



**GASTROPARTS**

# Coldine

- [EN]** Refrigeration
- [DE]** Kühlgeräte
- [ES]** Refrigeración
- [FR]** Réfrigération
- [IT]** Refrigerazione
- [PL]** Chłodnictwo
- [RU]** Холодильная техника

✉ [gastroparts@gastroparts.com](mailto:gastroparts@gastroparts.com)

☎ +48 56 657 00 66

📘 [fb.com/gastroparts.global](https://fb.com/gastroparts.global)

**GASTROPARTS.COM**





## heating elements

## heating elements for refrigeration

## heating elements for defrosting



<b>Part No.</b>	417515	<b>Ref. No.</b>	R030000600 R911015010
<b>description</b>	heating element 150W 230V L 630mm W 60mm Hmm cable length 1700mm tube ø 8.5mm		

## heating elements for condensate evaporation



<b>Part No.</b>	420181	<b>Ref. No.</b>	R111050010
<b>description</b>	heating element 500W 230V L 480mm W 59mm cable length 800mm tube ø 8.4mm condensate evaporation		

## switches and momentary switches

## microswitches

## lever actuated



<b>Part No.</b>	347683	<b>Ref. No.</b>	E912100110
<b>description</b>	microswitch with lever 250V 12A 1CO connection male faston 6.3mm L 46mm ambient temperature max. 85°C mounting distance 22mm type XGK15-88 actuating force: 25g lever length 32mm		

## electronic controllers

## DIXELL

## refrigeration controllers

## built-in version



<b>Part No.</b>	378461	<b>Ref. No.</b>	E020610420
<b>description</b>	electronic controller DIXELL XW30V-5N0C1-R mounting measurements 55x70mm built-in depth 65mm 230V voltage AC NTC/PTC relay outputs 3 NO-20A(8) NO-8A(3) NO-8A(3) NTC/PTC NTC/PTC DI protection IP65 -50 up to +150°C display 3½ digits		
<b>accessories for</b>	378461		
<b>Part No.</b>	379052	<b>Ref. No.</b>	—
<b>description</b>	temperature probe PTC 1kOhm cable silicone probe -50 up to +150°C cable -50 up to +180°C probe ø6x40mm cable length 1.5m without screw connection 2-wire		

<b>accessories for</b>	378461		
<b>Part No.</b>	379053	<b>Ref. No.</b>	—
<b>description</b>	temperature probe PTC 1kOhm cable PVC probe -50 up to +150°C cable -10 up to 100°C probe ø6x30mm cable length 3m without screw connection 2-wire		
<b>Part No.</b>	379064	<b>Ref. No.</b>	—
<b>description</b>	temperature probe PTC 1kOhm cable silicone probe -50 up to +150°C cable -50 up to +180°C probe ø6x40mm cable length 3m without screw connection 2-wire		
<b>Part No.</b>	379142	<b>Ref. No.</b>	—
<b>description</b>	temperature probe PTC 1kOhm cable PVC probe -50 up to +150°C cable -10 up to 100°C probe ø6x30mm cable length 1.5m without screw connection 2-wire		
<b>Part No.</b>	379160	<b>Ref. No.</b>	—
<b>description</b>	temperature probe NTC 10kOhm cable thermoplastic probe -40 up to +110°C cable -40 up to +110°C probe ø6x14mm cable length 1.5m without screw connection 2-wire		
<b>Part No.</b>	379161	<b>Ref. No.</b>	—
<b>description</b>	temperature probe NTC 10kOhm cable thermoplastic probe -40 up to +110°C cable -40 up to +110°C probe ø6x14mm cable length 3m without screw connection 2-wire		
<b>Part No.</b>	379162	<b>Ref. No.</b>	—
<b>description</b>	temperature probe NTC 10kOhm cable thermoplastic probe -40 up to +110°C cable -40 up to +110°C probe ø6x14mm cable length 6m 2-wire		
<b>Part No.</b>	379169	<b>Ref. No.</b>	—
<b>description</b>	temperature probe NTC 10kOhm cable thermoplastic probe -40 up to +110°C cable -40 up to +110°C probe ø6x14mm cable length 2m without screw connection 2-wire		
<b>Part No.</b>	379199	<b>Ref. No.</b>	—
<b>description</b>	temperature probe PTC 1kOhm cable PVC probe -50 up to +150°C cable -10 up to 100°C probe ø6x30mm cable length 5m without screw connection 2-wire		
<b>Part No.</b>	379343	<b>Ref. No.</b>	—
<b>description</b>	temperature probe NTC 10kOhm cable silicone probe -40 up to +110°C cable -50 up to +180°C probe ø6x40mm cable length 3m 2-wire		
<b>Part No.</b>	379458	<b>Ref. No.</b>	—
<b>description</b>	temperature probe NTC 10kOhm cable silicone probe -40 up to +110°C cable -50 up to +180°C probe ø6x40mm cable length 1.5m without screw connection 2-wire		
<b>Part No.</b>	379630	<b>Ref. No.</b>	—
<b>description</b>	temperature probe NTC 10kOhm cable thermoplastic probe -40 up to +110°C cable -40 up to +110°C probe ø6x14mm cable length 2.5m without screw connection 2-wire resistor 10kOhm		

<b>Part No.</b>	403533	<b>Ref. No.</b>	E020610410 E020610410 + E020650020
<b>description</b>	electronic controller DIXELL XW60L-5L0C0-R mounting measurements 150x30mm built-in depth 65.5mm 230V voltage AC NTC/PTC relay outputs 4 NO-20A(8) CO-8A(3) NO-8A(3) NO-16A(5) NTC/PTC NTC/PTC DI -50 up to +150°C display 3½ digits		



producer-specific

1

<b>Part No.</b>	378725	<b>Ref. No.</b>	E020610310
<b>description</b>	electronic controller DIXELL type XW30L-5NOC0-R 230V		

probes

producer-specific probes

probes



1

<b>Part No.</b>	379818	<b>Ref. No.</b>	E042651510
<b>description</b>	temperature probe PTC 1kOhm cable PVC probe -50 up to +150°C cable -10 up to 100°C connection 3-wire thread probe ø6x40mm cable length 1.5m		

core probes



1

<b>Part No.</b>	378407	<b>Ref. No.</b>	E043672510 E043673510 E200930030
<b>description</b>	core temperature probe PTC cable silicone probe -40 up to +120°C cable -50 up to +180°C connection 2-wire probe ø6/8x195mm thread cable length 3.5m handle ø 13mm handle length 130mm		

keypads

front foils



1

<b>Part No.</b>	403446	<b>Ref. No.</b>	E021041010
<b>description</b>	keypad foil for blast chiller COLDLINE self-adhesive		

fans

refrigeration fans

cold air circulating fans (complete)

ebm-papst

A4E series

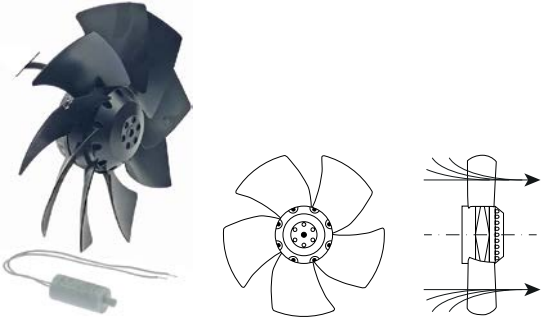

1

<b>Part No.</b>	602171	<b>Ref. No.</b>	F302125022
<b>description</b>	fan A4E250-AI02-10 fan wheel ø 250mm 230V blades 9 50/60Hz 42/45W 1400/1630rpm cable length 1500mm ebm-papst suitable capacitor 1.5µF		
<b>spare parts for</b>	602171		
<b>Part No.</b>	365171	<b>Ref. No.</b>	—
<b>description</b>	capacitor capacity 1.5µF 400V tolerance 5% 50/60Hz ambient temperature max. -40 up to +85°C ø 25mm L 50mm M8 plastic connection cable 250mm MLR25PRL		



## hinges

## spring assisted hinges

universal

INTERKLIMAT

hinges

1

<b>Part No.</b>	690714	<b>Ref. No.</b>	5038447
<b>description</b>	spring assisted hinge series 28XC mounting pos. left/right L 75mm W 25mm H 103mm A 8mm B 11mm intake 7.5x7.5 refrigeration units mounting distance 25mm		

## producer-specific

COLDLINE

1

<b>Part No.</b>	701128	<b>Ref. No.</b>	M121100020
<b>description</b>	spring assisted hinge L 75mm W 25mm H 103mm A 5mm B 13mm shaft length 9mm refrigeration units mounting distance 25.4mm mounting measurements 22x22x100mm intake 7.5x7.5		

## EVERLASTING

1

<b>Part No.</b>	701128	<b>Ref. No.</b>	M121100020
<b>description</b>	spring assisted hinge L 75mm W 25mm H 103mm A 5mm B 13mm shaft length 9mm refrigeration units mounting distance 25.4mm mounting measurements 22x22x100mm intake 7.5x7.5		

## gaskets

## refrigeration gaskets

plug-in gaskets

profile 9048

We offer custom-made gaskets for this profile

1

<b>Part No.</b>	902258	<b>Ref. No.</b>	N/A
<b>description</b>	refrigeration gasket profile 9048 Wmm L 2500mm plug size		

## profile 9794

We offer custom-made gaskets for this profile

1

<b>Part No.</b>	901952	<b>Ref. No.</b>	G504330608
<b>description</b>	refrigeration gasket profile 9794 W 405mm L 580mm plug size plug size		

1

<b>Part No.</b>	901955	<b>Ref. No.</b>	G504330653
<b>description</b>	refrigeration gasket profile 9794 W 408mm L 630mm plug size L1 653mm W1 433mm external size		

1

<b>Part No.</b>	901517	<b>Ref. No.</b>	G506581564
<b>description</b>	refrigeration gasket profile 9794 W 633mm L 1544mm plug size		



<b>Part No.</b>	901900	<b>Ref. No.</b>	G5065800739 Incastro G506580739
<b>description</b>	refrigeration gasket profile 9794 W 715mm L 635mm plug size		

<b>Part No.</b>	901901	<b>Ref. No.</b>	G906580754
<b>description</b>	refrigeration gasket profile 9195 W 630mm L 725mm plug size		

profile 9195

We offer custom-made gaskets for this profile

<b>Part No.</b>	901902	<b>Ref. No.</b>	G505080608
<b>description</b>	refrigeration gasket profile 9195 W 484mm L 584mm plug size		

evaporators

accessories

housings

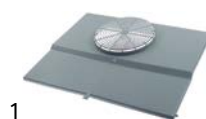

1

<b>Part No.</b>	692676	<b>Ref. No.</b>	M620700020
<b>description</b>	cover for AL140/ME L 587mm W 475mm H 100mm		





# GASTROPARTS



GASTROPARTS Sp. J.  
Klonowica 37  
87-100 Toruń

[www.gastroparts.com](http://www.gastroparts.com) 

[gastroparts@gastroparts.com](mailto:gastroparts@gastroparts.com) 

tel. +48 56 657 00 68 

[/gastroparts.global](#) 

[/gastroparts.global](#) 