



GASTROPARTS

MKN Ovens

[EN] Cooking

[DE] Kochtechnik

[ES] Cocción

[FR] Cuisson

[IT] Cottura

[PL] Obróbka termiczna

[RU] Термическая обработка

✉ gastroparts@gastroparts.com

☎ tel. +48 56 657 00 66

📘 fb.com/gastroparts.global

GASTROPARTS.COM





heating elements

heating elements for convection



1

Part No.	419248	Ref. No.	574183
description	heating element 15300W 400V heating circuits 6 ID \varnothing 450mm ED \varnothing 530mm L 540mm H 113mm W1 96mm H1 23mm H2 90mm flange length 130mm flange width 70mm connection length 100mm tube \varnothing 6.5mm cable length 1200mm dry heating element with fixing flange		



1

Part No.	418750	Ref. No.	574177
description	heating element 15400W 400V heating circuits 6 ID \varnothing 450mm ED \varnothing 530mm L 540mm H 113mm W1 96mm H1 23mm H2 90mm flange length 130mm flange width 70mm connection length 100mm tube \varnothing 6.5mm cable length 1200mm dry heating element with fixing flange		
accessories for	418750		
	Part No.	550639	Ref. No. 211083
	gasket L 130mm W 70mm thickness 1mm for heating element		



1

Part No.	418748	Ref. No.	574181
description	heating element 20400W 400V heating circuits 6 ID \varnothing 450mm ED \varnothing 525mm L 107mm H 113mm W1 97mm H1 28mm H2 85mm flange length 130mm flange width 70mm hole distance 119mm connection length 100mm tube \varnothing 6.5mm cable length 1200mm dry heating element hole \varnothing 6mm with fixing flange		
accessories for	418748		
	Part No.	550639	Ref. No. 211083
	gasket L 130mm W 70mm thickness 1mm for heating element		



1

Part No.	418751	Ref. No.	574189
description	heating element 30000W 400V heating circuits 6 ID \varnothing 380mm ED \varnothing 450mm L 535mm H 120mm W1 99mm H1 20mm H2 100mm flange length 130mm flange width 70mm connection length 100mm tube \varnothing 8mm cable length 1200mm dry heating element with fixing flange		



1

Part No.	418749	Ref. No.	574176
description	heating element 9900W 400V heating circuits 3 ID \varnothing 450mm ED \varnothing 465mm L 500mm H 115mm L1 35mm W1 96mm H1 26mm H2 89mm flange length 130mm flange width 70mm connection length 100mm tube \varnothing 6.5mm cable length 1200mm dry heating element with fixing flange		
accessories for	418749		
	Part No.	550639	Ref. No. 211083
	gasket L 130mm W 70mm thickness 1mm for heating element		

energy regulators

EGO

1-circuit



1

Part No.	380015	Ref. No.	203160
description	energy regulator 230V 13A single-circuit turn direction right shaft \varnothing 6x4.6mm shaft L 23mm mounting thread M4 power release 6-100% no. 50.57021.010		



thermostats

bi-metal thermostats

safety bi-metal thermostats



1			
Part No.	378659	Ref. No.	202806
description	bi-metal safety thermostat hole distance 24mm switch-off temp. 320°C NC 1-pole 16A 400V connection with cable cable length 120mm with fixing sheet		

bi-metal thermostats



1			
Part No.	390767	Ref. No.	203523
description	bi-metal thermostat switch-off temp. 60°C 1NC 1-pole connection F6.3		

control and safety thermostats

EGO

control thermostats

55.13_ series



1			
Part No.	375747	Ref. No.	203067 203662
description	thermostat t.max. 190°C temperature range 97-190°C 1-pole 1N0 16A probe ø 6mm probe L 87mm capillary pipe 1430mm capillary pipe isolated 1100mm gland nut M9x1 shaft ø ø6x4.6mm shaft L 23mm shaft position upper rotation 270°		
For models:	2020301-01, 2020301-02, 2020301A01, 2020301A02, 2020301A03, 2020301B01, 2020301C01, 2020302-01, 2020302-02, 2020302-03, 2020302-04, 2020302-05, 2020302A01, 2020302A02, 2020302A03, 2020302A04, 2020302A05, 2020302B01, 2020302C01, 3020301-01, 3020301-02, 3020301B01, 3020302-01, 3020302-02, 3020302-03, 3020302-04, 3020302B01		



1			
Part No.	375505	Ref. No.	203177 203500
description	thermostat t.max. 320°C temperature range 50-320°C 1-pole 1N0 16A probe ø 3mm probe L 160mm capillary pipe 870mm capillary pipe isolatedmm gland nut shaft ø ø6x4.6mm shaft L 23mm shaft position upper rotation 270°		

55.34_ series





1			
Part No.	375025	Ref. No.	203488
description	thermostat t.max. 300°C temperature range 50-300°C 3-pole 3C0 16A probe ø 6mm probe L 77mm capillary pipe 2980mm capillary pipe isolated 2260mm gland nut shaft ø ø6x4.6mm shaft L 23mm shaft position upper rotation 270°		
For models:	2021401-00, 2021401-01, 2021401-02, 2021401-03, 2021401-04, 2021401-05, 2021401-06, 2021401-07, 2021401A00, 2021401A01, 2021401A02, 2021401A03, 2021401A04, 2021401B00, 2021401B01, 2021401B02, 2021401B03, 2021401B04, 2021401C00, 2021401C01, 2021401C02, 2021401C03, 2021401C04, 2021402-00, 2021402-01, 2021402-02, 2021402-03, 2021402-04, 2021402-05, 2021402-06, 2021402-07, 2021402A00, 2021402A01, 2021402A02, 2021402A03, 2021402A04, 2021402B00, 2021402B01, 2021402B02, 2021402B03, 2021402B04, 2021402C00, 2021402C01, 2021402C02, 2021402C03, 2021402C04, 2021403-00, 2021403-01, 2021403-02, 2021403-03... (Other models you can see in the webshop)		

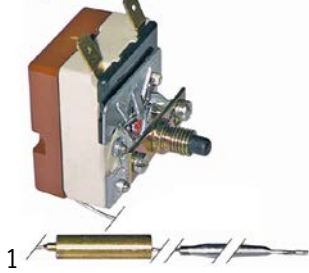

safety thermostats

55.13_ series



Part No.	375044	Ref. No.	203185
description	safety thermostat switch-off temp. 178°C 1-pole 16A probe ø 4mm probe L 91mm capillary pipe 1730mm capillary pipe isolated 1600mm gland nut probe with sealing sleeve screw connection M8x1 sealing sleeve 8.6x32mm		
accessories for	375044		
	Part No.	102067	Ref. No. 201524
	nut thread M8x1 H 3mm brass Qty 1 pcs type SEF 1		
	Part No.	551083	Ref. No. —
	cap for safety thermostat thread M8x1		

55.32_ series



Part No.	375392	Ref. No.	203484
description	safety thermostat switch-off temp. 360°C 3-pole 1CO/2NC 20A probe ø 4mm probe L 120mm capillary pipe 1490mm capillary pipe isolated 1450mm gland nut probe SS		
For models:	2021101-00, 2021101A00, 2021102-00, 2021103-00, 2021104-00, 2021104A00, 2021105-00, 2021106-00, 2021107-00, 2021107-01, 2021107A00, 2021108-00, 2021109-00, 2021109-01, 2021109A00, 2021110-00, 2021111-01, 2021111-02, 2021112-00, 2021112-01, 20211401-02, 20211401-03, 2021401-04, 2021401-05, 2021401-06, 2021401-07, 2021401A01, 2021401A02, 2021401A03, 2021401A04, 2021401B01, 2021401B02, 2021401B03, 2021401B04, 2021401C01, 2021401C02, 2021401C03, 2021401C04, 2021402-02, 2021402-03, 2021402-04, 2021402-05, 2021402-06, 2021402-07, 2021402A01, 2021402A02, 2021402A03, 2021402A04, 2021402B01, 2021402B02... (Other models you can see in the webshop)		

control thermostats with operation switch

55.34_ series

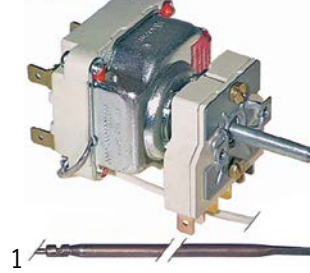

Part No.	375246	Ref. No.	203408
description	thermostat t.max. 645°C temperature range 100-615/645°C 2-pole 2NO 16A probe ø 4mm probe L 230mm capillary pipe 1100mm capillary pipe isolated 600mm gland nut shaft ø 6x4.6mm shaft L 25mm shaft position lower rotation 270° outer switch 2NO probe material copper		
For models:	2023206-00, 2023206-01, 2023207-00, 2023207-01, 2023207-02, 2023207-03, 2023207-04, 3023206-00, 3023206-01		

accessories

probe clips

clamps

for thermostat



Part No.	550878	Ref. No.	208057 575077
description	probe clip for pipe ømm for probe ø 6mm Qty 1 pcs		
For models:	2020303-02, 2020303-03, 2020303-04, 2020303A00, 2020501-0, 2020501-00, 2020501-01, 2020503-0, 2020504-00, 2020505-00, 2022801-02, 2022801-03, 2022801A02, 2022801B02, 2022801B03, 2022802-02, 2022802-03, 2022802A02, 2022802A03, 2022802B02, 2022802B03, 2022802B04, 2022802B05, 2022802C02, 2022802C03, 2022803-02, 2022803-03, 2022803A02, 2022803A03, 2022803B02, 2022803B03, 2022803C02, 2022803C03, 2022804-02, 2022804-03, 2022804A02, 2022804A03, 2022804B02, 2022804B03, 2022804B04, 2022804B05, 2022804C02, 2022804C03, 2022805-02, 2022805-03, 2022805A02, 2022805A03, 2022805B02, 2022805B03, 2022805B04... (Other models you can see in the webshop)		

protective pipes for capillary pipes



Part No.	550385	Ref. No.	541673
description	protective pipe for capillaries thread M10x1 H1 120mm L1 50mm L2 125mm		



Part No.	550386	Ref. No.	541674
description	protective pipe for capillaries thread M10x1 H1 148mm L1 46mm L2 100mm		



plunger sockets

 <p>1</p>			
Part No.	550285	Ref. No.	541221 935211
description	protection pipe thread M12x0.75 IT M9x1 ET M12x0.75 L 66mm SS single ø 10mm		
For models:	2020501-0, 2020501-00, 2020501-01, 2020502-00, 2020503-0, 2020504-00, 2020505-00, 2060501-0, 2060501-00, 2060501-01, 3020501-00, 3020502-00, 3020505-00		

switches and momentary switches

rocker/momentary rocker switches

30x22mm

 <p>1</p>			
Part No.	301060	Ref. No.	203235
description	rocker switch mounting measurements 30x22mm red 2NO 250V 16A illuminated connection male faston 6.3mm ambient temperature max. 125/55°C protection IP40		
For models:	2062801-00, 2062801A00, 2062801B00, 2062801C00, 2062802-00, 2062802-2, 2062802A00, 2062802B00, 2062802C00, 2062803-00, 2062803-1, 2062803-2, 2062803A00, 2062803C00, 2062804-00, 2062804-1, 2062804-2, 2062804A00, 2062804B00, 2062804C00, 2062806-00, 2062806A00, 2062806B00, 2062806B01, 2062806B02, 2062806C00, 2062806C01, 2062806C02, 2062901-00, 2062901-1, 2062901-2, 2062901A00, 2062901B00, 2062901B01, 2062901B02, 2062901C00, 2062901C01, 2062901C02, 2062902-00, 2062902-1, 2062902-2, 2062902A00, 2062902B00, 2062902B01, 2062902B02, 2062902C00, 2062902C01, 2062902C02		

accessories

push buttons

 <p>1</p>			
Part No.	348214	Ref. No.	207186
description	button for display PCB transparent suitable for MKN ED ø 16mm H 4.8mm for combi-steamer		

cam switches

on/off

 <p>1</p>			
Part No.	347953	Ref. No.	203958
description	cam switch 4 operating positions 2NO sequence 0-1-0-1 16A shaft ø 6x4.6mm shaft L 23mm connection male faston 6.3mm ON-OFF plastic		

7-position

 <p>1</p>			
Part No.	300106	Ref. No.	203560
description	cam switch 7 operating positions 1NO/2CO sequence 0-1-2-3-4-5-6 32A shaft ø 6x4.6mm shaft L 23mm connection screw 7-position shaft flat upper		

magnetic switches

28.5x19mm

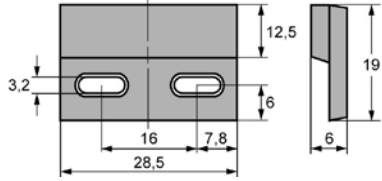
  <p>1</p>			
Part No.	345219	Ref. No.	203028
description	magnetic switch L 28.5mm W 19mm 1NO 230V 0.5A P max. 10W connection cable cable length 800mm		



29x19mm

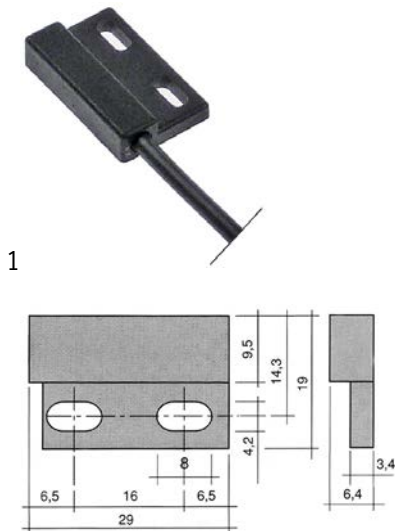

Part No.	345808	Ref. No.	202722
description	magnetic switch L 29mm W 19mm 1CO 150V 0.5A P max. 10W connection cable cable length 1000mm		

oven lamps

producer-specific oven lamps

MKN



Part No.	693050	Ref. No.	211128
description	gasket graphite D1 ø 71mm D2 ø 94mm thickness 1mm suitable for MKN Qty 1 pcs		
accessories for	693050		
	Part No.	694294	Ref. No. 216115
	glass panel ø 90mm thickness 8mm		



Part No.	694294	Ref. No.	216115
description	glass panel ø 90mm thickness 8mm		
accessories for	694294		
	Part No.	693050	Ref. No. 211128
	gasket graphite D1 ø 71mm D2 ø 94mm thickness 1mm suitable for MKN Qty 1 pcs		
	Part No.	699482	Ref. No. 211146
	gasket suitable for MKN combi-steamer mounting pos. for lens ED ø 105mm ID ø 71mm graphite thickness 1mm		



Part No.	357184	Ref. No.	203678
description	lamp socket socket G4 cable length 130mm connection male faston 6.3mm ø 17mm H 9mm mounting distance 12mm mounting thread M3 Qty 1 pcs		

lamps

halogen lamps

for socket G4 / G6.35 / G9



Part No.	357191	Ref. No.	202620
description	halogen lamp socket G4 12V 10W temp.-resist. 300°C OSRAM HALOSTAR OVEN		

encoders and potentiometers



Part No.	401968	Ref. No.	203733
description	potentiometer with momentary function		

lamps

screw-on/push-on fit

halogen lamp

for socket G4 / G6.35 / G9



Part No.	357191	Ref. No.	202620
description	halogen lamp socket G4 12V 10W temp.-resist. 300°C OSRAM HALOSTAR OVEN		



Part No.	359599	Ref. No.	203679
description	halogen lamp socket G4 12V 20W temp.-resist. 500°C		



			
1			
Part No.	359599	Ref. No.	203679
description	halogen lamp socket G4 12V 20W temp.-resist. 500°C		

alarm devices

buzzers

			
1			
Part No.	350050	Ref. No.	203325
description	buzzer 230VAC connection male faston 6.3mm screw mounting thread M4 60dB		

			
1			
Part No.	350221	Ref. No.	202775
description	buzzer 5-28VDC connection F6.3 mounting ø 40mm		

contactors

TELEMECANIQUE (Schneider Electric)

power contactors

			
1			
Part No.	381484	Ref. No.	203986
description	power contactor resistive load 125A 230 (AC3/400V) 37kW main contacts 3NO auxiliary contacts 1NO/1NC connection screw type LC1D80116		

			
1			
Part No.	381486	Ref. No.	203971
description	power contactor resistive load 20A (AC3/400V) 4kW main contacts 2x3NO auxiliary contacts 2x1NO connection screw type LC2K0910P7		

			
1			
Part No.	380965	Ref. No.	203744
description	power contactor resistive load 20A 230VAC (AC3/400V) 6A/2.2kW main contacts 3NO auxiliary contacts 1NO connection screw connection type LC1K0610P7+		

			
1			
Part No.	380976	Ref. No.	203675
description	power contactor resistive load 32A 230VAC (AC3/400V) 18A/7.5kW main contacts 3NO auxiliary contacts 1NO/1NC connection screw connection		

			
1			
Part No.	380980	Ref. No.	203985
description	power contactor resistive load 50A 230VAC (AC3/400V) 32A/15kW main contacts 3NO auxiliary contacts 1NO/1NC connection screw connection type LC1D32P7		



TRIPUS (Eichhoff)

small relay switches



1

Part No.	380121	Ref. No.	203219
description	small relay switch 230V main contacts 3NO/1NC auxiliary contacts knob \varnothing 70mm (227-piece) connection Faston 6.3mm type E3250 resistive load 16A		

solid state relays

CROUZET



1

Part No.	403534	Ref. No.	203668
description	solid state relay CROUZET 1 phase 100A 48-660V 4-32VDC L 58mm W 49mm new edition screw type 84137140		



1

Part No.	403535	Ref. No.	203669
description	solid state relay CROUZET 1 phase 10A 24-280V 90-280VAC L 58mm W 49mm new edition screw type 84137001		

heat-conducting foils



1

Part No.	401676	Ref. No.	203671
description	heat-conducting foil L 57mm W 45mm		

relays

power relays

with special fixing



1

Part No.	380441	Ref. No.	202732
description	power relays SCHRACK 230VAC 16A 2NO connection coded plug manuf. no. 0419 110301 00 2-pole		

miscellaneous



1

Part No.	381465	Ref. No.	203735
description	remote control module 440V capacity 47nF 3x2M Ω m DIN rail		

transformers

open transformers

with clamp terminal



1

Part No.	403900	Ref. No.	202604
description	control transformer primary 208-600VAC secondary 2x115VAC 460VA secondary 2A H 133mm L 150mm W 112mm 50/60Hz type EI 150N/49/F		

1

Part No.	403303	Ref. No.	202608 202608+202725
description	transformer primary 110-250VAC secondary 230VAC 100VA connection plug 50/60Hz		



1

Part No.	400791	Ref. No.	203999
description	transformer primary 120/200/220/230V secondary 24V 108VA 50/60Hz		



1

Part No.	400792	Ref. No.	203818
description	transformer primary 200/208/220/230/240/250V secondary 4.2/10.7/21V 162VA 50/60Hz		



1

Part No.	403304	Ref. No.	203980 203981
description	transformer primary 440VAC secondary 230VAC 500VA connection screw clamp 50/60Hz		

for lighting



1

Part No.	403306	Ref. No.	203749
description	transformer primary 230VAC secondary 11.5VAC 50VA secondary 4A connection screw L 165mm W 45mm H 37mm 50/60Hz mounting distance 155mm for lighting		

probes

producer-specific probes

probes



1

Part No.	378120	Ref. No.	203991
description	temperature probe thermocouple K (NiCr-Ni) cable PTFE probe -50 up to 1150°C cable -40 up to +250°C connection 2-wire thread M8x1 probe ø1.5x18mm cable length 1.6m		



1

Part No.	378121	Ref. No.	203689
description	temperature probe thermocouple K (NiCr-Ni) cable PTFE probe -50 up to 1150°C cable -40 up to +250°C connection 2-wire thread M8x1 probe ø1.5x18mm cable length 3.2m		



1

Part No.	378122	Ref. No.	203693
description	temperature probe thermocouple K (NiCr-Ni) cable silicone probe -50 up to 1150°C cable -50 up to +180°C connection 2-wire thread M10x1 probe ø3.5x13mm cable length 1.5m		



1

Part No.	378123	Ref. No.	203990
description	temperature probe thermocouple K (NiCr-Ni) cable silicone probe -50 up to 1150°C cable -50 up to +180°C connection 2-wire thread M10x1 probe ø3.5x13mm cable length 2.3m		

core probes



1

Part No.	378537	Ref. No.	202738
description	core temperature probe multipoint probe cable PTFE probe -40 up to +250°C cable -40 up to +250°C connection 5-wire probe ø4x100mm thread 1/4" cable length 1.8m handle ø 11mm handle length 75mm		



1

Part No.	378124 ¹	Ref. No.	203697
description	core temperature probe thermocouple K (NiCr-Ni) cable PTFE probe -40 up to +250°C cable -40 up to +250°C connection 5-wire probe ø4x100mm thread 1/4" cable length 1.5m handle ø 12mm handle length 90mm		

¹multipoint probe



			
Part No.	378125 ¹	Ref. No.	203688
description	core temperature probe thermocouple K (NiCr-Ni) cable PTFE probe -40 up to +250°C cable -40 up to +250°C connection 5-wire probe ø4x100mm thread 1/4" cable length 1.9m handle ø 12mm handle length 90mm		

¹multipoint probe

accessories

fasteners

			
Part No.	551022	Ref. No.	208032
description	probe clip		

electronics

electronics accessories

			
Part No.	694973	Ref. No.	207097
description	button for display PCB ø 15mm grey		

			
Part No.	348214	Ref. No.	207186
description	button for display PCB transparent suitable for MKN ED ø 16mm H 4.8mm for combi-steamer		

frequency converters

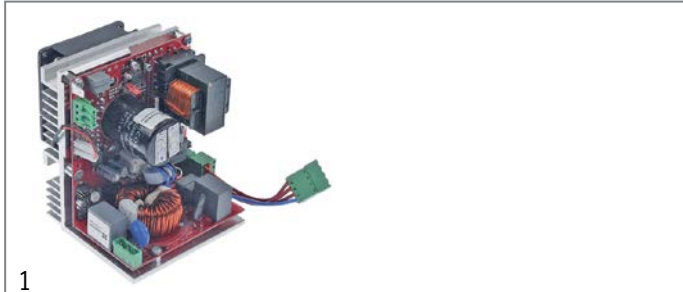
			
Part No.	403214	Ref. No.	10012693 203784
description	frequency converter with fan tray for hot air motors 100-240V L 135mm W 110mm H 135mm output frequency 0-100Hz input frequency 47-63Hz		

rectifiers

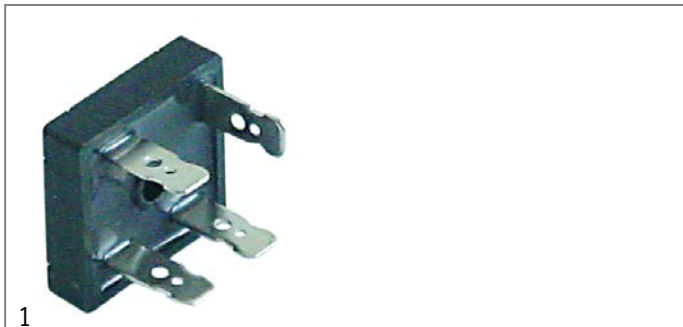
			
Part No.	400851	Ref. No.	203442
description	rectifier 420V 10A		

PCBs

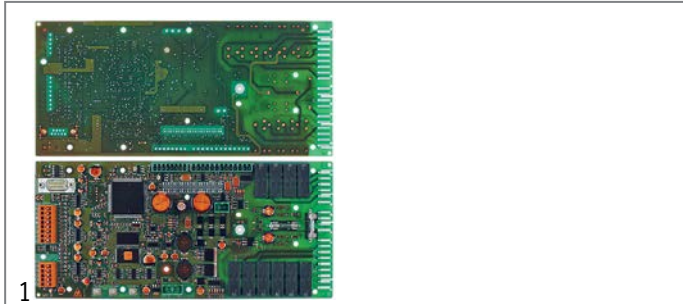
			
Part No.	403807	Ref. No.	202676
description	control PCB combi-steamer Hans Dampf L 250mm W 115mm		

			
Part No.	403808	Ref. No.	202788
description	controller for USB MKN L 64.5mm W 31.5mm		

1

Part No.	403034	Ref. No.	203746
description	keypad PCB		



1

Part No.	401969	Ref. No.	203766
description	PCB		



1

Part No.	401697	Ref. No.	202690
description	keypad PCB combi-steamer Hans Dampf		

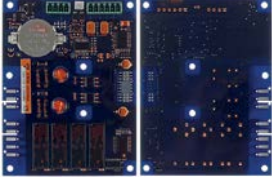

1

Part No.	403806	Ref. No.	202698
description	PCB combi-steamer Hans Dampf L 115mm W 87mm		



1

Part No.	401698	Ref. No.	203745
description	keypad PCB combi-steamer Hans Dampf		

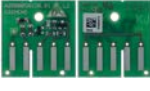

1

Part No.	403809	Ref. No.	202600
description	PCB for combi-steamer Hans Dampf L 28mm W 27mm for ignition electrode		



1

Part No.	403869	Ref. No.	203773
description	PCB for combi-steamer L 50mm W 50mm		

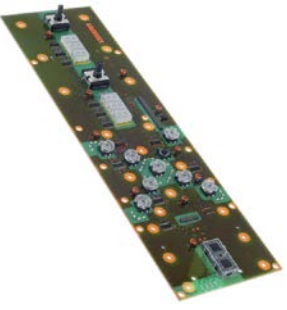

1

Part No.	403307	Ref. No.	202128
description	keypad PCB combi-steamer JUNIOR L 410mm W 115mm buttons 10		

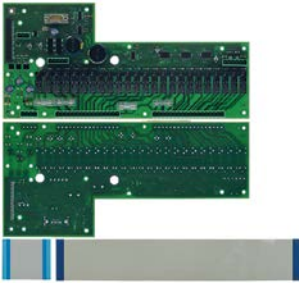

1

Part No.	403872	Ref. No.	203747
description	relay PCB for combi-steamer L 320mm W 150mm		



solenoid valves

solenoid valves (water)

INTERELEKTRIK

medium temperature: 90°C 90°C 60°C
 ambient temperature: 60°C 25°C 60°C
 duty cycle: 40% 100% 100%

with reducers



1

Part No.	370843	Ref. No.	203663
description	solenoid valve single straight 220-240 inlet 3/4" outlet 1/2" input 2l/min DN8 t.max. 90°C duty cycle 100% INTERELEKTRIK plastic flow regulating valve inlet yellow total length 84.5mm		



1

Part No.	370144	Ref. No.	201160
description	solenoid valve single straight 230VAC outlet 10.5mm t.max. 90°C plastic inlet 3/4"mm		

MÜLLER

medium temperature: 90°C
 duty cycle: 100%

spare parts and accessories

miscellaneous



1

Part No.	371002	Ref. No.	10011599
description	solenoid valve holder MÜLLER flange support		

various



1

Part No.	370307	Ref. No.	203831
description	valve unit 24VDC		

SOLENOID VALVES/PRESSURE SWITCHES MKN



1

Part No.	370308	Ref. No.	203832
description	valve unit 24VDC		

metal

PARKER

solenoid valves (various)



1

Part No.	370749	Ref. No.	201153
description	solenoid valve 2-ways 230VAC inlet 1/8" outlet 1/8" connection 1/8" L 30mm PARKER type series WB4.5 membranes Viton p max 10bar 50/60Hz brass		

Solenoid valve - accessories



1

Part No.	371001	Ref. No.	204532
description	solenoid valve holder		



1

Part No.	371002	Ref. No.	10011599
description	solenoid valve holder MÜLLER flange support		

pressure switches

for combi-steamers



1

Part No.	543037	Ref. No.	202601
description	pressure control ø 23mm pressure range 15/25mbar connection 9mm 42V 2A		



electrodes

			
1			
Part No.	401458	Ref. No.	203601
description	level electrode M10x1 total length 132mm probe L 112mm insulated probe length 105mm connection F6.3 1/8"		
For models:	2022802B04, 2022802B05, 2022804B04, 2022804B05, 2022805B04, 2022805B05, 2022807B03, 2022807B04, 2022902-00, 2022902-01, 2022903-00, 2022903-01, 2023003B01, 2023003B02, 2023007B01, 2023007B02, 2023009B01, 2023009B02, 2062804B08		

flow meters and flow sensors

flow meters

GICAR

			
1			
Part No.	403873	Ref. No.	203687
description	flow meter thread M10x1 plastic nominal-ø 2mm approval NSF Qmax. 2.3l/min		

fans

axial fans

ebm-papst

			
1			
Part No.	601715 ¹	Ref. No.	203819
description	axial fan L 119mm W 119mm H 38mm 230VAC 50Hz 18W bearing ball bearing manuf. no. 4656ZW metal connection cable 310mm ebm-papst fan wheel ø 110mm temp.-resist. 75°C		

¹with ball bearings

hot air motors

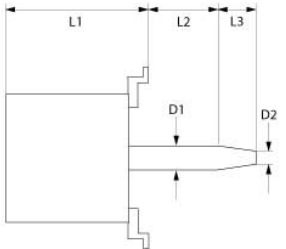
 			
1			
Part No.	601862	Ref. No.	203977
description	fan motor 200-230V 3 phase 50Hz 0.45/0.65kW 700/1400rpm speeds 2 L1 145mm L2 35mm L3 35mm 0.7/2A D1 ø 17mm D2 ø 13.5mm		

			
1			
Part No.	501583	Ref. No.	202745
description	fan motor 200-240V 50/60Hz 3000/3600rpm L1 125mm L2 35mm L3 15mm ø 100mm 0.5/0,7A type L5tw2 - 695 D1 ø 8mm D2 ø 8x7.5mm		

			
1			
Part No.	602153	Ref. No.	202673
description	fan motor 200-480V 3 phase 50/60Hz 0.6-0.82kW 1380/1650rpm speeds 1 L1 151mm L2 67mm L3 35mm ø 160mm M10 IT 2.8/1.6A at 50Hz 200-415V at 60Hz 200-480V at 50Hz 1380rpm at 60Hz 1650rpm type L9Fw4D-678 no. C6 D1 ø 17mm D2 ø 13.5mm with shaft sealing		

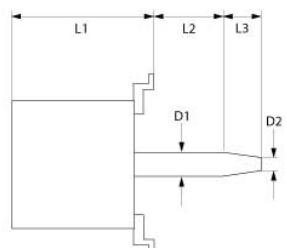
 			
1			
Part No.	601485	Ref. No.	203771
description	fan motor 240V 3 phase 60Hz 0.68kW 1730rpm speeds 1 L1 150mm L2 24mm L3 35mm M10R IT 2.9A power input 870W at 60Hz 1730rpm type L9DFw4D-596 no. W6 D1 ø 17mm D2 ø 13mm		



1

Part No.	514511	Ref. No.	062005
description	fan wheel blades 12 D1 \varnothing 280mm D2 \varnothing 13mm D3 \varnothing 16mm H1 110mm H2 31mm H3 4.5mm		



1

Part No.	514512	Ref. No.	062002
description	fan wheel blades 12 D1 \varnothing 350mm D2 \varnothing 13mm D3 \varnothing 16mm H1 115mm H2 32mm H3 4.5mm		



1

Part No.	699359	Ref. No.	945446
description	flange ED \varnothing 60mm int. \varnothing 1 22mm SS M4		



1

Part No.	699364	Ref. No.	204681
description	flange for combi-steamer ED \varnothing 50mm int. \varnothing 1 24mm int. \varnothing 2 19mm thickness 7mm SS		



1

Part No.	699363	Ref. No.	204423
description	flange for combi-steamer ED \varnothing 57mm int. \varnothing 1 24mm int. \varnothing 2 19mm thickness 7mm SS		



1

Part No.	699360	Ref. No.	945661
description	flange for combi-steamer int. \varnothing 1 22mm int. \varnothing 2 8.5mm thickness 4mm SS L 53mm W 50mm M4		

radial fans



1

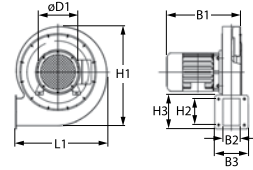

Part No.	601181	Ref. No.	203994
description	radial fan 230V voltage AC 50/60Hz 100W H1 170mm L1 175mm D1 \varnothing 50mm W1 115mm W2 40mm H2 45mm		

miscellaneous



1

Part No.	601475	Ref. No.	203926
description	radial fan 230V voltage AC 50/60Hz 20W H1 180mm L1 180mm D1 \varnothing 86mm W1 40mm W2 34mm H2 122mm W3 40mm H3 172mm		

pumps

drain pumps

HANNING



1

Part No.	499302	Ref. No.	203788
description	drain pump inlet \varnothing 24mm outlet \varnothing 24mm 220-240V 30W 50Hz HANNING type DPS25-303		



magnetic-drive pumps



1

Part No.	500696	Ref. No.	203825
description	magnetic-drive pump HANNING type DP040-025 30W 230V 50Hz inlet ø 24mm outlet ø 11mm L 130mm		



1

Part No.	499303	Ref. No.	203826
description	magnetic-drive pump HANNING type DP040-028 65W 208-240V 60Hz inlet ø 24mm outlet ø 11mm L 140mm		

condensators & interference suppression filters

operating capacitors

plastic



1

Part No.	365031	Ref. No.	202742
description	operating capacitor capacity 4µF 450V tolerance 5% 50/60Hz ambient temperature max. -25 to +85°C ø 31mm L 58mm M8 plastic connection male faston 6.3mm protection		

filters

RC circuits



1

Part No.	381485	Ref. No.	203743
description	RC circuit type LA4DA2U 110-240V Qty 1 pcs		



1

Part No.	380049	Ref. No.	203683
description	RC circuit type LAD4RCU 110-250V		

fuses

fine fuses

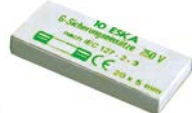

1

Part No.	358601	Ref. No.	203722
description	fine fuse size ø5x20mm 1.25A slow-acting rated 250V Qty 10 pcs		



1

Part No.	358608	Ref. No.	203996
description	fine fuse size ø5x20mm 10A slow-acting rated 250V Qty 10 pcs		



1

Part No.	358607	Ref. No.	203473
description	fine fuse size ø5x20mm 6.3A slow-acting rated 250V Qty 10 pcs		

fine fuse holders



1

Part No.	551378	Ref. No.	203635
description	fuse holder for USIG suitable fuse 5x20/5x25/5x30 1-pole 6.3A rated 400V L 45.4mm W 9.9mm H 32mm connection plug-in connection Phoenix Control ST-SI		

screw locks

D0-system (NEOZED)



1

Part No.	358045	Ref. No.	203739
description	fuse size D02 35A rated 250/400V E18 ø 15mm L 36mm Qty 10 pcs		



electric accessories

cables

connection cables

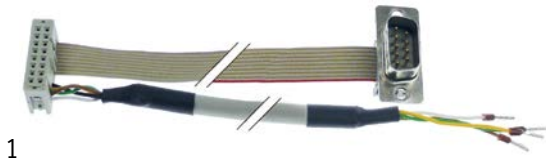

1			
Part No.	579003	Ref. No.	033057
description	connection cable L 1030mm 13-pole for USB		

terminals and connectors

not insulated

female fastons

iron nickel-plated



1			
Part No.	550001	Ref. No.	203089
description	female faston size 6.3x0.8mm 1.0-2.5mm ² straight Fe gal Ni t.max. 340°C Qty 100 pcs		

plug connectors



1			
Part No.	551354	Ref. No.	202689
description	plug connector 50-pole raster size 2mm		

terminals

PCB terminal blocks



1			
Part No.	551355	Ref. No.	203690
description	PCB terminal block 5-pole raster size 3.8mm cross section 1.5mm ²		

rail-mounted terminals

WIELAND

accessories



1			
Part No.	550370	Ref. No.	203273
description	terminal block end bracket clampsmm ²		

miscellaneous



1			
Part No.	551377	Ref. No.	203634
description	fuse holder Phönix Control type USIG 0.5-16mm ² DIN rail black W 10.2mm L 61mm for fuse holder 10A rated 500V		



1			
Part No.	551356	Ref. No.	203271
description	rail-mounted terminal Phönix Control type UK10 6-10mm ² W 8mm L 43mm max. 50A max 500V		



1			
Part No.	551373	Ref. No.	203620
description	rail-mounted terminal Phönix Control type UK16 0.5-16mm ² top-hat rail 35mm grey W 10.2mm L 42.5mm		



1			
Part No.	551375	Ref. No.	203622
description	rail-mounted terminal Phönix Control type UK35 0.75-35mm ² DIN rail grey W 15.1mm L 62mm		

1

Part No.	551371	Ref. No.	203279
description	rail-mounted terminal Phoenix Control type USLKG10 0.5-10mm ² yellow/green for DIN rail 35mm H 45mm 1-pole		



1

Part No.	551374	Ref. No.	203621
description	rail-mounted terminal Phoenix Control type USLKG16 0.5-16mm ² yellow/green W 10.2mm L 42.5mm for DIN rail 35mm H 45mm 1-pole		



1

Part No.	551376	Ref. No.	203633
description	rail-mounted terminal Phoenix Control type USLKG35 0.75-35mm ² DIN rail yellow/green W 15mm L 50mm for DIN rail 35mm H 62mm 1-pole		

electronic magnets



1

Part No.	400793	Ref. No.	203672
description	lifting magnet 205V voltage DC		



gas valves and ignition boxes

gas control valves

HONEYWELL



1

Part No.	106012	Ref. No.	201181	
description	gas valve type VK4115V 220-240V 50/60Hz gas inlet flange 32x32mm gas outlet flange 32x32mm thermocouple connection pilot connection pressure range 15-60mbar max 60mbar operator type HONEYWELL flange 32x32mm			
accessories for	106012			
	Part No.	102845	Ref. No.	—
	gas connection angled 1/2" flange 32x32mm hole distance 24x24mm Tandem			
	Part No.	102846	Ref. No.	—
	gas connection straight 1/2" flange 32x32mm hole distance 24x24mm suitable for Tandem			

ignition boxes

DUNGS



1

Part No.	102378	Ref. No.	201643 201662 201699 201735
description	ignition box type DGAI.73 model 10.1.0TCL electrodes 2 starting time <10s waiting time >3s safety time <1s 230V 50/60Hz ignition cable male faston 2.8mm DUNGS protection IP20 DGAI.73		
For models:	2061401-05, 2061401-06, 2061402-05, 2061402-06, 2061403-0, 2061403-00, 2061403-02, 2061403-03, 2061403-04, 2061404-0, 2061404-00, 2061404-02, 2061404-03, 2061404-04, 2061405-01, 2061405-02, 2061405-03, 2061406-01, 2061406-02, 2061406-03, 2062801-06, 2062801A06, 2062801B06, 2062801C06, 2062802-06, 2062802A00, 2062802B06, 2062802B07, 2062802B08, 2062802C06, 2062803-06, 2062803A06, 2062803C06, 2062804-06, 2062804A06, 2062804B06, 2062804B07, 2062804B08, 2062804C06, 3061403-01, 3061403-02, 3061403-03, 3061404-01, 3061404-02, 3061404-03, 3061405-01, 3061405-02, 3061405-03, 3061406-01, 3061406-02... (Other models you can see in the webshop)		



HONEYWELL



1

Part No.	106607	Ref. No.	201180
description	cover for ignition box		



1

Part No.	106606	Ref. No.	201179
description	ignition box HONEYWELL type S4575B 1025 electrodes 3 waiting times safety time 5s 230-240V 4VA 50/60Hz		

ignition parts

pilot burners



JUNKERS













CB 502 series

pilot burners



1

Part No.	102843	Ref. No.	520917 520997
description	pilot burner JUNKERS type CB502031 natural gas nozzle no.6 gas pressure 25mbar gas connection 6mm with primary air		
For models:	2060301-00, 2062801-00, 2062801A00, 2062801B00, 2062801C00, 2062802-0, 2062802-00, 2062802-2, 2062802A00, 2062802B00, 2062802C00, 2062803-0, 2062803-00, 2062803-2, 2062803A00, 2062803C00, 2062804-0, 2062804-2, 2062804A00, 2062804B00, 2062804C00, 2062901-0, 2062901-00, 2062901-2, 2062901A00, 2062901B00, 2062901B01, 2062901B02, 2062901C00, 2062901C01, 2062901C02, 2062902-0, 2062902-00, 2062902-2, 2062902A00, 2062902B00, 2062902B01, 2062902B02, 2062902C00, 2062902C01, 2062902C02		
spare parts for	102843		
	Part No.	100227	Ref. No. —
	pilot burner nozzle natural gas gas pressure 25mbar code 6 Qty 1 pcs suitable for JUNKERS CB50203_		
	Part No.	100704	Ref. No. 201570 201572 201578
	ignition electrode D1 ø 9mm connection M4 D2 ø 11mm L1 17mm L2 17mm BL1 13mm BL2 4mm BL3 22mm		

spare parts for	102843		
	Part No.	100909	Ref. No. —
	union screw thread M10x1 for pipe ø 6mm Qty 1 pcs		
	Part No.	101287	Ref. No. —
	olive for pipe ø 6mm Qty 1 pcs		
	Part No.	101292	Ref. No. —
	union screw for igniter suitable for CB 502/505 Qty 1 pcs		
accessories for	102843		
	Part No.	100220	Ref. No. 201547
	pilot burner nozzle LPG gas pressure 50mbar code 2 Qty 1 pcs suitable for JUNKERS CB503_		
	Part No.	100221	Ref. No. —
	pilot burner nozzle LPG gas pressure 30mbar code 29 Qty 1 pcs suitable for JUNKERS CB50203_		
	Part No.	100222	Ref. No. 201641
	pilot burner nozzle LPG gas pressure 50mbar code 5 Qty 1 pcs suitable for JUNKERS CB50203_		
	Part No.	100223	Ref. No. —
	pilot burner nozzle natural gas gas pressure 20mbar code 3 Qty 1 pcs suitable for JUNKERS CB503_		
	Part No.	100224	Ref. No. —
	pilot burner nozzle natural gas gas pressure 25mbar code 26 Qty 1 pcs suitable for JUNKERS CB503_		
	Part No.	100225	Ref. No. —
	pilot burner nozzle LPG gas pressure 30mbar code 39 Qty 1 pcs suitable for JUNKERS CB503_		
	Part No.	100226	Ref. No. —
	pilot burner nozzle LPG gas pressure 50mbar code 15 suitable for JUNKERS		
	Part No.	100228	Ref. No. —
	pilot burner nozzle town gas gas pressure 8mbar code 4 Qty 1 pcs suitable for JUNKERS CB50203_		
	Part No.	101281	Ref. No. 201560
	olive for pipe ø 4mm L 8.7mm Qty 1 pcs suitable for CB 502/503		
	Part No.	101283	Ref. No. 201692
	union screw thread M10x1 for pipe ø 4mm Qty 1 pcs		



electrodes



Part No.	102289	Ref. No.	201176 201176+ 211137+ 2x211143
description	glow plug mounting distance 28mm cable length 600mm connection male faston 2.8mm		
spare parts for	102289		
	Part No.	691609	Ref. No. 211143
	gasket graphite ED ø 150mm ID ø 115mm thickness 2mm Qty 1 pcs		

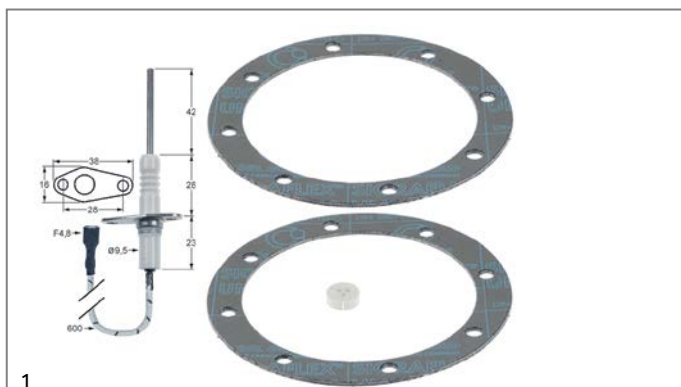

Part No.	102290	Ref. No.	201177
description	monitoring electrode flange length 38mm D1 ø 9.5mm flange width 16mm L1 42mm BL1 28mm BL2 23mm connection F4.8x0.8 cable length 600mm fixing dimensions 28mm		

thermocouples

plug-in thermocouples

plug-in thermocouples standard

with barrel socket ø6mm

SIT

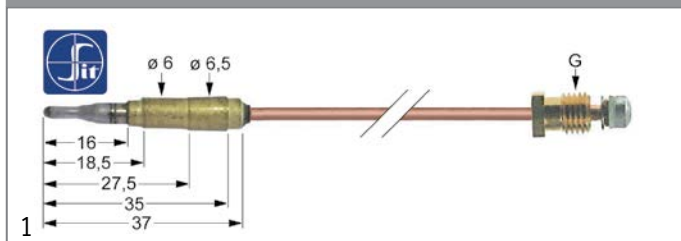

Part No.	102267	Ref. No.	201670
description	thermocouple M8x1 L 850mm plug connection ø6.0mm		
For models:	2061101-01, 2061101-02, 2061102-01, 2061107-00, 2061107-01, 3061101-00, 3061101-01, 3061102-00, 3061107-00, 3061107-01		

threaded thermocouples

threaded thermocouples standard

with socket with thread M8x1

SIT

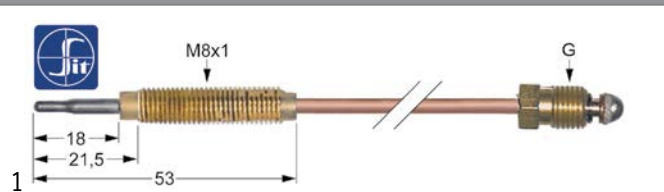

Part No.	107632	Ref. No.	201352 201532 201539
description	thermocouple SIT M8x1 L 1000mm M8x1		
For models:	2061101-0, 2061102-0, 2061103-0, 2061104-0, 2061104-00, 2061105-0, 2061105-00, 2061106-0, 2061106-00, 2062901B02, 2062901C02, 2062902B02, 2062902C02, 2063401-0, 2063401-00, 2063401-01, 2063401-02, 2063401-03, 2063401-04, 2063402-0, 2063402-00, 2063402-01, 2063402-02, 2063402-03, 2063402-04, 2063403-00, 2063403-01, 2063403-02, 2063403-03, 2063403-04, 2063403-05, 2063403-06, 2063403-07, 2063403-08, 2063404-00, 2063404-01, 2063404-02, 2063404-03, 2063404-04, 2063404-05, 2063405-0, 2063405-00, 2063405-01, 2063405-02, 2063405-03, 2063405-04, 2063406-00, 2063406-01, 2063406-02, 2063406-03...(Other models you can see in the webshop)		

accessories

interrupters



Part No.	101258	Ref. No.	201478 203478
description	interrupter thread M10x1		
For models:	2060301-00, 2060301-01, 2062802-0, 2062802-1, 2062802-2, 2062803-0, 2062803-1, 2062803-2, 2062804-0, 2062804-1, 2062804-2, 2062901-0, 2062901-1, 2062901-2, 2062902-0, 2062902-1, 2062902-2		

gas burners

forced air burners

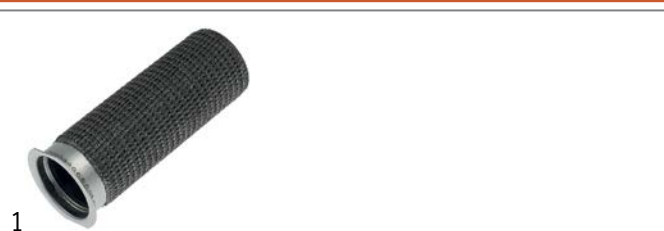

Part No.	107842	Ref. No.	201178
description	burner L 150mm ø 50mm 20kW combi-steamer		



1

Part No.	107877	Ref. No.	201174
description	connecting fitting for burner MKN combi-steamer		



1

Part No.	107878	Ref. No.	201172
description	connecting fitting for burner MKN combi-steamer		



1

Part No.	108150	Ref. No.	201182
description	venturi MKN combi-steamer with gasket		

equipment-specific units

for convection ovens/combi-steamers

drain units

drip rails



1

Part No.	692765	Ref. No.	202125
description	drip rail L 620mm plastic with support plate W 38mm hole ø 5mm for combi-steamer		

spare parts and accessories



1

Part No.	699338	Ref. No.	202726
description	battery Lithium H 8mm ø 24.5mm 3V CR2477N		

housing and bezels



1

Part No.	694972	Ref. No.	866789
description	bracket L 52mm W 28mm H 115mm		



1

Part No.	699337	Ref. No.	202782
description	cover cap for USB L 38mm W 29mm		

cleaning system

nozzles



1

Part No.	694665	Ref. No.	201146
description	nozzle thread 1/4" ET H 57mm for cleaning system		



1

Part No.	694664	Ref. No.	201152
description	nozzle thread 1/4" ET WS 17 H 37mm for cleaning system		

screw connections



1

Part No.	362008	Ref. No.	205293
description	connecting piece 1/2" -3/4" L 100.5mm plastic		

drip water trays



1

Part No.	692725	Ref. No.	202138
description	gutter for model 10.x L 605mm W 50mm H 20mm plastic		



miscellaneous



1			
Part No.	691608	Ref. No.	211137
description	boiler gasket silicone ED ø 15mm suitable for MKN		



1			
Part No.	694663	Ref. No.	203356
description	duct bore ø 30mm D1 ø 33.5mm D2 ø 30mm plastic H 12mm		



1			
Part No.	692813	Ref. No.	201135
description	screen for drain D1 ø 90mm		

for tilting bratt pans

spindles



1			
Part No.	514365	Ref. No.	110115
description	threaded rod		
For models:	2021405-0, 2021405-00, 2021405-01, 2021405-02, 2021405-03, 2021405B00, 2021405B01, 2023003-0, 2023003-00, 2023003-1, 2023003A00, 2023003B00, 2023003C00, 2023005-0, 2023005-00, 2023005-1, 2023005A00, 2023005B00, 2023005C00, 2023007-0, 2023007-00, 2023007-1, 2023007A00, 2023007B00, 2023007C00, 2023009-0, 2023009-00, 2023009-1, 2023009A00, 2023009B00, 2023009C00, 3061403-00, 3061403-01, 3061403-02, 3061403-03, 3061403A00, 3061403B00, 3061403C00, 3061405-00, 3061405-01, 3061405-02, 3061405-03, 3061405B00		

for boiling pans

gearboxes



1			
Part No.	514365	Ref. No.	110115
description	threaded rod		
For models:	2021405-0, 2021405-00, 2021405-01, 2021405-02, 2021405-03, 2021405B00, 2021405B01, 2023003-0, 2023003-00, 2023003-1, 2023003A00, 2023003B00, 2023003C00, 2023005-0, 2023005-00, 2023005-1, 2023005A00, 2023005B00, 2023005C00, 2023007-0, 2023007-00, 2023007-1, 2023007A00, 2023007B00, 2023007C00, 2023009-0, 2023009-00, 2023009-1, 2023009A00, 2023009B00, 2023009C00, 3061403-00, 3061403-01, 3061403-02, 3061403-03, 3061403A00, 3061403B00, 3061403C00, 3061405-00, 3061405-01, 3061405-02, 3061405-03, 3061405B00		

knobs

producer-specific knobs

MKN



1			
Part No.	112526	Ref. No.	209481
description	knob potentiometer t.max. °C ø 71mm shaft ø 6x4.6mm shaft flat upper with spring		

1

Part No.	111951	Ref. No.	580030
description	knob		

locks

electromagnetic closer



1			
Part No.	692216	Ref. No.	203768
description	electromagnetic closer 24V voltage DC L 104mm W 24mm H 34mm series 8440		

handle latches

producer-specific

MKN



1			
Part No.	691666	Ref. No.	207092
description	catch clamp length 46mm BL 31mm for off-set 59-69mm		

spare parts for



691666			
	Part No.	514390	Ref. No.
			—
	spring for door handle ø 6mm L 54mm W 27.5mm		

accessories for

691666			
	Part No.	691780	Ref. No.
			207090
	door catch L 24mm H 21mm thread M8 thread L 20mm		

Table continues overleaf



accessories for	691666		
	Part No.	694066	Ref. No. —
	door catch with spigot 2-stage L 28mm W 14mm H 15mm H1 16mm total length 51mm thread M8 thread L 23mm stainless steel		
	Part No.	694067	Ref. No. —
	door catch with spigot 1-stage L 26mm total length 51mm thread M8		

	1		
Part No.	692726	Ref. No.	10012036
description	catch for combi-steamer mounting thread M4/M8 clamp length 48mm BL 45mm ø 42mm		

	1		
Part No.	694660	Ref. No.	207094
description	catch L 103mm clamp length 60mm		

	1		
Part No.	699292	Ref. No.	203737
description	counterpart for door handle L 135mm W 35mm H 42mm hole ø 18mm		

	1		
Part No.	694662	Ref. No.	203667
description	cover for door latch plastic grey L 185mm W 48mm mounting distance 186mm D 37mm		

	1		
Part No.	691780	Ref. No.	207090
description	door catch L 24mm H 21mm thread M8 thread L 20mm		

	1		
Part No.	705011	Ref. No.	207103
description	door catch L 57mm W 13mm mounting thread 6mm BL 6mm		

	1		
Part No.	691617	Ref. No.	207089
description	door handle grey plastic		
accessories for	691617		
	Part No.	691666	Ref. No. 207092
	catch clamp length 46mm BL 31mm for off-set 59-69mm		
	Part No.	691777	Ref. No. 202662
	cover cap plastic grey L 94mm W 40mm mounting distance 75mm D 36mm		
	Part No.	691780	Ref. No. 207090
	door catch L 24mm H 21mm thread M8 thread L 20mm		
	Part No.	691782	Ref. No. 801064
	cover plate round ø 40mm thickness 1mm		
	Part No.	691783	Ref. No. 801059
	cover plate rectangular L 35mm W 14mm thickness 1mm		

	1		
Part No.	691785	Ref. No.	207147
description	catch L 97mm clamp length 54mm BL 39mm ø 51.5mm		

	1		
Part No.	691786	Ref. No.	207148
description	door catch L 38mm H 19mm thread M8 thread L 21mm		



			
1			
Part No.	691784	Ref. No.	207149
description	door handle L 200mm W 32mm H 70mm grey plastic		
accessories for	691784		
	Part No.	691777	Ref. No. 202662
	cover cap plastic grey L 94mm W 40mm mounting distance 75mm D 36mm		
	Part No.	691781	Ref. No. 802694
	cover plate round ø 38mm thickness 1mm		
	Part No.	691785	Ref. No. 207147
	catch L 97mm clamp length 54mm BL 39mm ø 51.5mm		
	Part No.	691786	Ref. No. 207148
	door catch L 38mm H 19mm thread M8 thread L 21mm		

			
1			
Part No.	691777	Ref. No.	202662
description	cover cap plastic grey L 94mm W 40mm mounting distance 75mm D 36mm		

			
1			
Part No.	691783	Ref. No.	801059
description	cover plate rectangular L 35mm W 14mm thickness 1mm		

			
1			
Part No.	691781	Ref. No.	802694
description	cover plate round ø 38mm thickness 1mm		

			
1			
Part No.	691782	Ref. No.	801064
description	cover plate round ø 40mm thickness 1mm		

gaskets

gaskets for heated units

door seals

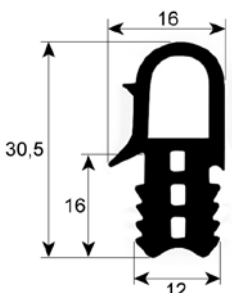
			
1			
Part No.	901456	Ref. No.	211112
description	door seal profile 2063 perimeter 1540mm Qty 1		

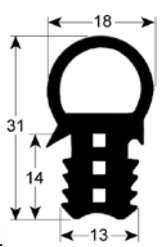
			
1			
Part No.	902213	Ref. No.	10012490
description	door seal profile 2064 W 600mm L 740mm outer plug size		

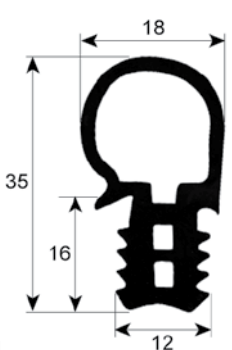
			
1			
Part No.	900793	Ref. No.	211096
description	door seal profile 2065 W 605mm L 1480mm external size Qty 1		

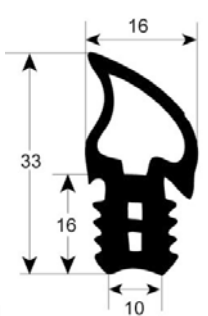
			
1			
Part No.	900783	Ref. No.	211094
description	door seal profile 2743 W 480mm L 610mm external size Qty 1		

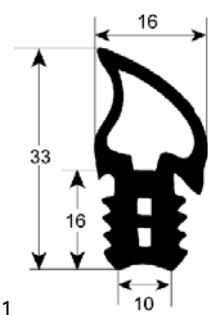
Part No.	900784	Ref. No.	211095
description	door seal profile 2743 W 610mm L 750mm external size Qty 1		

gaskets for tray rack trolleys

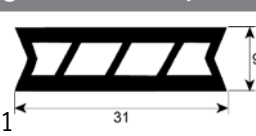

Part No.	901157	Ref. No.	211104
description	tray rack trolley gasket profile 4075 L 645mm		

gaskets for control panels



Part No.	902447	Ref. No.	211087
description	gasket for cover L 1580mm suitable for MKN for combi-steamer with 6 mounting clips		



Part No.	902448	Ref. No.	211088
description	gasket for cover L 2040mm suitable for MKN for combi-steamer with 6 mounting clips		

O-rings

Viton

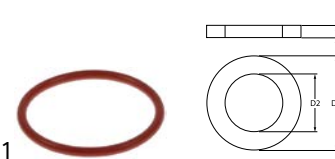

Part No.	532733	Ref. No.	211086
description	O-ring Viton thickness 5mm ID ø 65mm Qty 1 pcs		

sealing washers

graphite gaskets



Part No.	691609	Ref. No.	211143
description	gasket graphite ED ø 150mm ID ø 115mm thickness 2mm Qty 1 pcs		

copper gaskets

DIN-7603-C



Part No.	528520	Ref. No.	211004
description	gasket copper ED ø 22mm ID ø 16mm thickness 2mm		
For models:	2061101-01, 2061101-02, 2061102-01, 2061107-00, 2061107-01, 2061401-00, 2061401-04, 2061401-05, 2061401-06, 2061401A03, 2061401B03, 2061401C03, 2061402-04, 2061402-05, 2061402-06, 2061402A03, 2061402B03, 2061402C03, 2061403-02, 2061403-03, 2061403-04, 2061404-0, 2061404-00, 2061404-01, 2061404-02, 2061404-03, 2061404-04, 2061404A00, 2061404B00, 2061404C00, 2061405-01, 2061405-02, 2061405-03, 2061406-01, 2061406-02, 2061406-03, 2062801-01, 2062801-02, 2062801-03, 2062801-04, 2062801-05, 2062801-06, 2062801A01, 2062801A02, 2062801A03, 2062801A04, 2062801A05, 2062801A06, 2062801B01, 2062801B02... (Other models you can see in the webshop)		

sealing cords

round



Part No.	693464	Ref. No.	211047
description	sealing cord ø 10mm Qty supplied by meter		
For models:	2023201-01, 2023201-02, 2023201-03, 2023201A01, 2023202-01, 2023202-02, 2023202A01, 2023203-02, 2023203-03, 2023203-04, 2023203-05, 2023203-06, 2023203-07, 2023203A02, 2023203A03, 2023204-01, 2023204-02, 2023204A01, 2023205-02, 2023205-03, 2023205-04, 2023205-05, 2023205-06, 2023205-07, 2023205A02, 2023205A03, 2083201A01, 2083202A02, 2083202A03, 3023201-01, 3023201-02, 3023204-01, 3023204-02		

1



Part No.	693451	Ref. No.	211031
description	sealing cord ø 8mm Qty supplied by meter		
For models:	2023501-03, 2023501-04, 2023501-05, 2023501A02, 2023502-02, 2023502-03, 2023502-04, 2023502A02, 2023503-03, 2023503-04, 2023503-05, 2023503-06, 2023503-07, 2023503-08, 2023503-09, 2023503-10, 2023503A04, 2023503A05, 2023503A06, 3023501-01, 3023501-02, 3023501-03, 3023501A01, 3023502-01, 3023502-02, 3023502-03, 3023502A01		



shaft gaskets

miscellaneous



1

Part No. 691513 **Ref. No.** 211084

description shaft seal ID ø 16.5mm ED ø 29mm thickness 4.8mm

special gaskets

for combi-steamers



1

Part No. 692800 **Ref. No.** 211141

description gasket suitable for MKN combi-steamer L 82mm W 62mm mounting pos. burner thickness 1.5mm graphite Qty 1 pcs



1

Part No. 699362 **Ref. No.** 211079

description gasket suitable for MKN profile no to be sold in France for combi-steamer ED ø 58mm rubber DN 50mm



1

Part No. 699366 **Ref. No.** 211080

description gasket suitable for profile for combi-steamer ED ø 42mm ID ø 36mm rubber thickness 6.5mm



1

Part No. 699365 **Ref. No.** 211078

description gasket U-bend L 73mm W 73mm ID ø 60mm thickness 3mm

miscellaneous



1

Part No. 550289 **Ref. No.** 211003

description flat gasket

For models: 2020301-0, 2020301-00, 2020301-01, 2020301-02, 2020301A00, 2020301A01, 2020301A02, 2020301A03, 2020301B00, 2020301B01, 2020301C00, 2020301C01, 2020302-0, 2020302-00, 2020302-01, 2020302-02, 2020302-03, 2020302-04, 2020302-05, 2020302A00, 2020302A01, 2020302A02, 2020302A03, 2020302A04, 2020302A05, 2020302B00, 2020302B01, 2020302C00, 2020302C01, 2020307A00, 2020501-0, 2020501-00, 2020501-01, 2020501-02, 2020502-00, 2020503-0, 2020504-00, 2020505-00, 2020505-01, 2020505-02, 2020505-03, 2020506-01, 2020601-00, 2020601-01, 2021101-0, 2021101-00, 2021101A00, 2021102-0, 2021102-00, 2021103-0...(Other models you can see in the webshop)

springs

torsion springs



1

Part No. 699291 **Ref. No.** 216156

description torsion spring ø 24mm L2 69mm wire gauge ø 3mm L1 23mm L3 69mm for door handle

hose reels and spray guns

spray guns



1

Part No. 542800 **Ref. No.** 201147

description spray gun for appliances 1/2" ET L 120mm with backflow preventer type MKN



hose reels

appliance hose reels



1	Part No.	542804	Ref. No.	204410
	description	hose reel without spray gun hose length 1.8m		

countersunk screws

1			
Part No.	560263	Ref. No.	105470
description	countersunk screw thread M4 L 25mm SS DIN 963/ISO 2009 Qty 20 pcs intake slotted head ø 7.5mm		

1			
Part No.	560425	Ref. No.	105466
description	countersunk screw thread M4 L 13mm stainless steel DIN 965/ISO 7046 Qty 1 pcs head ø 7.5mm		

hoses

industrial hoses

nylon hoses



1			
Part No.	530566	Ref. No.	050016
description	nylon hose ID ø 8mm ED ø 10mm L 5m thickness 1mm operating p. 10bar burst p. 50bar t.max. 100°C transparent		

flat-headed bolts

1			
Part No.	560635	Ref. No.	105008
description	flat-headed bolt thread M3 thread L 6mm with plain washer		

1			
Part No.	560626	Ref. No.	105001
description	flat-headed bolt thread M4 thread L 8mm head ø 8mm head thickness 3mm torx		

fastening material

rivets/rivet nuts

blind rivet nuts hexagonal

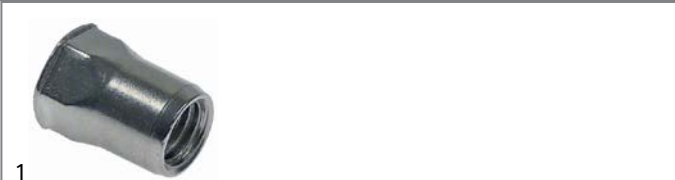

1			
Part No.	551382	Ref. No.	208039
description	rivet nut thread M8 DN 11mm L 16.4mm SS Qty 1 pcs		

1			
Part No.	511004	Ref. No.	105115
description	flat-headed bolt thread M4 thread L 12mm SS DIN 84/ISO 1207 Qty 1 pcs intake slotted L 14.5mm		

screws

sheet metal screws



1			
Part No.	560102	Ref. No.	111202
description	sheet metal screws ø 3.9mm L 9.5mm SS Qty 20 pcs DIN 7981/ISO 7049 head ø 7.5mm oval head		

1			
Part No.	560454	Ref. No.	105121
description	flat-headed bolt thread M4 thread L 22mm SS DIN 84/ISO 1207 Qty 1 pcs intake slotted head ø 7mm head thickness 2.5mm		

raised countersunk head screws

1			
Part No.	560634	Ref. No.	105471
description	raised countersunk head screw thread M4 thread L 40mm SS Qty 1 pcs intake slotted head ø 7.3mm		





hexagonal screws

 <p>1</p>			
Part No.	560311	Ref. No.	101451
description	hexagonal screw thread M10 thread L 20mm SS WS 17 Qty 1 pcs DIN 933 / ISO 4017		

 <p>1</p>			
Part No.	560081	Ref. No.	101412
description	hexagonal screw thread M4 thread L 10mm SS WS 7 Qty 20 pcs DIN 933 / ISO 4017		

 <p>1</p>			
Part No.	560080	Ref. No.	101127
description	hexagonal screw thread M4 thread L 8mm SS WS 7 Qty 20 pcs DIN 933 / ISO 4017		

 <p>1</p>			
Part No.	560083	Ref. No.	101125
description	hexagonal screw thread M5 thread L 10mm SS WS 8 Qty 20 pcs DIN 933 / ISO 4017		

 <p>1</p>			
Part No.	560084	Ref. No.	101403
description	hexagonal screw thread M5 thread L 16mm SS WS 8 Qty 20 pcs DIN 933 / ISO 4017		

 <p>1</p>			
Part No.	560086	Ref. No.	101405
description	hexagonal screw thread M6 thread L 10mm SS WS 10 Qty 20 pcs DIN 933 / ISO 4017		

 <p>1</p>			
Part No.	550682	Ref. No.	101435
description	hexagonal screw thread M8 thread L 20mm SS WS 13 Qty 1 pcs DIN 933 / ISO 4017		

cylinder head bolts

DIN 912/ISO 4762

 <p>1</p>			
Part No.	560305	Ref. No.	102008
description	cylinder head bolt thread M5 thread L 16mm WS 4 intake internal hexagon DIN 912/ISO 4762		

 <p>1</p>			
Part No.	520455	Ref. No.	102050
description	screw thread M8 thread L 20mm WS 6 SS Qty 1 pcs DIN 912/ISO 4762		

side bolts

 <p>1</p>			
Part No.	560051	Ref. No.	118005
description	side bolts thread M4 L 16mm SS Qty 20 pcs intake slotted head ø 10mm		
For models:	2020301-0, 2020301-00, 2020301-01, 2020301-02, 2020301A00, 2020301A01, 2020301A02, 2020301A03, 2020301B00, 2020301B01, 2020301C00, 2020301C01, 2020302-0, 2020302-00, 2020302-01, 2020302-02, 2020302-03, 2020302-04, 2020302-05, 2020302A00, 2020302A01, 2020302A02, 2020302A03, 2020302A04, 2020302A05, 2020302B00, 2020302B01, 2020302C00, 2020302C01, 2020303-02, 2020303-03, 2020303-04, 2020303A00, 2020307A00, 2020501-0, 2020501-00, 2020501-01, 2020501-02, 2020502-00, 2020503-0, 2020504-00, 2020505-00, 2020505-01, 2020505-02, 2020505-03, 2020506-01, 2020601-00, 2020601-01, 2021101-0, 2021101-00... (Other models you can see in the webshop)		

 <p>1</p>			
Part No.	560053	Ref. No.	118009
description	side bolts thread M5 L 16mm SS Qty 20 pcs intake slotted head ø 12.5mm		

grub screws

miscellaneous

 <p>1</p>			
Part No.	560306	Ref. No.	110124
description	grub screw thread M6 L 10mm DIN 915 intake internal hexagon Qty 1 pcs		



nuts

hexagonal nuts

DIN 934 / ISO 4032/8673



1

Part No.	560223	Ref. No.	113081
description	hexagonal nut thread M3 H 2.4mm WS 5.5 SS DIN/ISO DIN 934 / ISO 4032/8673 Qty 1 pcs		



1

Part No.	560340	Ref. No.	113082
description	hexagonal nut thread M4 H 3.2mm WS 7 SS DIN/ISO DIN 934 / ISO 4032/8673 Qty 1 pcs		



1

Part No.	560129	Ref. No.	113087 113088
description	hexagonal nut thread M5 H 4mm WS 8 SS DIN/ISO DIN 934 / ISO 4032/8673 Qty 1 pcs		



1

Part No.	511212	Ref. No.	113091
description	hexagonal nut thread M6 H 5mm WS 10 SS DIN/ISO DIN 934 / ISO 4032/8673 Qty 1 pcs		



1

Part No.	560197	Ref. No.	113096
description	nut thread M10 H 8mm WS 17 SS DIN/ISO DIN 934 / ISO 4032/8673 Qty 1 pcs		



1

Part No.	517174	Ref. No.	113092
description	nut thread M8 H 6.5mm WS 13 SS DIN/ISO DIN 934 / ISO 4032/8673 Qty 1 pcs		

DIN 985



1

Part No.	560227	Ref. No.	116041
description	hexagonal nut thread M3 H 4mm SS WS 5.5 Qty 1 pcs self-locking		



1

Part No.	560140	Ref. No.	113014
description	hexagonal nut thread M4 H 4.8mm SS WS 7 Qty 20 pcs DIN/ISO DIN 985 self-locking		



1

Part No.	560141	Ref. No.	116061
description	hexagonal nut thread M5 H 5.4mm SS WS 8 Qty 20 pcs DIN/ISO DIN 985 self-locking		



1

Part No.	560142	Ref. No.	116063
description	hexagonal nut thread M6 H 6mm SS WS 10 Qty 20 pcs DIN/ISO DIN 985 self-locking		



1

Part No.	560143	Ref. No.	121124
description	hexagonal nut thread M8 H 8.5mm SS WS 13 Qty 20 pcs DIN/ISO DIN 985 self-locking		

miscellaneous



1

Part No.	560548	Ref. No.	208025
description	nut thread M4 Qty 1 pcs		

For models:	2020301-00, 2020301-01, 2020301-02, 2020301A00, 2020301A01, 2020301A02, 2020301A03, 2020301B00, 2020301B01, 2020301C00, 2020301C01, 2020302-00, 2020302-01, 2020302-02, 2020302-03, 2020302-04, 2020302-05, 2020302A00, 2020302A01, 2020302A02, 2020302A03, 2020302A04, 2020302A05, 2020302B00, 2020302B01, 2020302C00, 2020302C01, 2020303-00, 2020303-01, 2020303-02, 2020303-03, 2020303-04, 2020303A00, 2020307A00, 2020501-01, 2020501-02, 2020502-00, 2020504-00, 2020505-00, 2020505-01, 2020505-02, 2020505-03, 2020506-01, 2020601-00, 2020601-01, 2021101-00, 2021101A00, 2021102-00, 2021103-00, 2021104-00... (Other models you can see in the webshop)		
--------------------	--	--	--



washers

spring rings



1

Part No.	560122	Ref. No.	121032
description	lock washer ID ø 5.2mm ED ø 9mm SS DIN127 Qty 20 pcs for thread M5		

washers

DIN 125A



1

Part No.	560110	Ref. No.	120005
description	plain washer ID ø 3.2mm ED ø 7mm thickness 0.5mm SS Qty 20 pcs DIN 125A for thread M3		



1

Part No.	560111	Ref. No.	120017
description	plain washer ID ø 4.3mm ED ø 9mm thickness 0.8mm SS Qty 20 pcs DIN 125A for thread M4		



1

Part No.	560112	Ref. No.	120022
description	plain washer ID ø 5.3mm ED ø 10mm thickness 1mm SS Qty 20 pcs DIN 125A for thread M5		



1

Part No.	560333	Ref. No.	120027
description	plain washer ID ø 6.4mm ED ø 12mm thickness 1.6mm SS Qty 1 pcs DIN 125A for thread M6		



1

Part No.	560645	Ref. No.	120008
description	plain washer ID ø 7.4mm ED ø 14mm thickness 1.6mm SS Qty 1 pcs DIN 125A		



1

Part No.	560114	Ref. No.	120108
description	plain washer ID ø 8.4mm ED ø 16mm thickness 1.6mm SS Qty 20 pcs DIN 125A for thread M8		

DIN 9021



1

Part No.	560303	Ref. No.	120030
description	plain washer ID ø 6.4mm ED ø 18mm Qty 1 pcs for thread M6		
For models:			

nylon



1

Part No.	560646	Ref. No.	120007
description	plain washer ID ø 12.5mm ED ø 28mm thickness 3mm nylon Qty 1 pcs		

tooth lock washers

DIN 6798A



1

Part No.	560125	Ref. No.	121023
description	tooth lock washer ID ø 4.2mm ED ø 8mm SS DIN/ISO DIN 6798A Qty 20 pcs for thread M4		



consumables

cleaning agents

combi-steamer detergents/descalers

Notice: Articles labelled 'DANGEROUS GOODS' are delivered by road through a forwarder for reasons of safety and are charged separately!



1

Part No.	802061	Ref. No.	303324 40-100575
description	detergent for combi-steamer MKN WaveClean detergent/rinse aid Qty 10 pcs		
description	MKN WaveClean - detergent - box of 10 cartridges Combination product for cleaning and descaling of combi steamers with WaveClean® Innovative 2-in-1 cartridge with cleaner and rinse aid. Easy handling with no direct contact to active agents. Cleans MKN combi steamers reliably, economically and hygienically. Start the WaveClean® cleaning program, unscrew the 2-in-1 cartridge cap and insert the cartridge into the holder when prompted to do so. After the cleaning process remove the cartridge before starting the machine. Rinse off any residue with plenty of water. For commercial use only.		

fuses

fine fuses

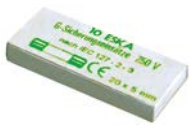

1

Part No.	358601	Ref. No.	203722
description	fine fuse size ø5x20mm 1.25A slow-acting rated 250V Qty 10 pcs		



1

Part No.	358608	Ref. No.	203996
description	fine fuse size ø5x20mm 10A slow-acting rated 250V Qty 10 pcs		



1

Part No.	358607	Ref. No.	203473
description	fine fuse size ø5x20mm 6.3A slow-acting rated 250V Qty 10 pcs		

screw locks

D0-system (NEOZED)



1

Part No.	358045	Ref. No.	203739
description	fuse size D02 35A rated 250/400V E18 ø 15mm L 36mm Qty 10 pcs		

GASTROPARTS.COM



© 2020 Gastroparts Sp. J. All rights reserved.