



GASTROPARTS

Anliker

- [EN]** Equipment
- [DE]** Geräte
- [ES]** Aparatos
- [FR]** Équipement
- [IT]** Attrezzature
- [PL]** Urządzenia
- [RU]** Оборудование

✉ gastroparts@gastroparts.com

☎ +48 56 657 00 66

📘 fb.com/gastroparts.global

GASTROPARTS.COM





heating elements

accessories

hexagonal nuts



1

Part No.	560131	Ref. No.	810.10022
description	hexagonal nut thread M4 H 3.2mm WS 7 SS DIN/ISO DIN 934 / ISO 4032/8673 Qty 20 pcs		
For models:	GSM-anlikerXL-STANDARD, GSM-anlikerXL-STAR, GSM-FIVE-STANDARD, GSM-FIVE-STAR, GSM-Quattro-PROFI, GSM-Quattro-STANDARD		



1

Part No.	560132	Ref. No.	810.10032
description	hexagonal nut thread M5 H 4mm WS 8 SS DIN/ISO DIN 934 / ISO 4032/8673 Qty 20 pcs		
For models:	GSM-anlikerXL-STANDARD, GSM-anlikerXL-STAR, GSM-FIVE-STANDARD, GSM-FIVE-STAR, GSM-Quattro-PROFI, GSM-Quattro-STANDARD		

washers



1

Part No.	560111	Ref. No.	812.60032
description	plain washer ID \varnothing 4.3mm ED \varnothing 9mm thickness 0.8mm SS Qty 20 pcs DIN 125A for thread M4		
For models:	GSM-FIVE-STANDARD, GSM-FIVE-STAR, GSM-Quattro-PROFI, GSM-Quattro-STANDARD		



1

Part No.	560112	Ref. No.	812.10032
description	plain washer ID \varnothing 5.3mm ED \varnothing 10mm thickness 1mm SS Qty 20 pcs DIN 125A for thread M5		
For models:	GSM-anlikerXL-STANDARD, GSM-anlikerXL-STAR, GSM-FIVE-STANDARD, GSM-FIVE-STAR, GSM-Quattro-PROFI, GSM-Quattro-STANDARD		

tooth lock washers



1

Part No.	560125	Ref. No.	814.20022
description	tooth lock washer ID \varnothing 4.2mm ED \varnothing 8mm SS DIN/ISO DIN 6798A Qty 20 pcs for thread M4		
For models:	GSM-FIVE-STANDARD, GSM-FIVE-STAR, GSM-Quattro-PROFI, GSM-Quattro-STANDARD		

switches and momentary switches

magnetic switches

M8x1.25



1

Part No.	347558	Ref. No.	708.04020
description	magnetic switch 1NO thread M8x1.25 cable length 300mm		
For models:	GSM-anlikerXL-STANDARD, GSM-anlikerXL-STAR, GSM-FIVE-STANDARD, GSM-FIVE-STAR, GSM-Quattro-PROFI, GSM-Quattro-STANDARD		

motors

motors

for vegetable slicers



1

Part No.	499124	Ref. No.	235.91815
description	motor 230V 260W 50Hz 2760rpm 1 phase shaft \varnothing 14mm shaft length 61mm \varnothing 116mm H 218mm mounting distance 144.5mm hole \varnothing 6mm		
For models:	GSM-FIVE-STANDARD, GSM-FIVE-STAR, GSM-Quattro-PROFI, GSM-Quattro-STANDARD		

condensators & interference suppression filters

operating capacitors

plastic



1

Part No.	365146	Ref. No.	705.01014
description	operating capacitor capacity 50 μ F 250V with plastic sheathing tolerance \pm 5% 50/60Hz \varnothing 45mm L 72mm connection male faston 6.3mm		
For models:	GSM-anlikerXL-STANDARD, GSM-anlikerXL-STAR		



			
1			
Part No.	365147	Ref. No.	705.01013
description	operating capacitor capacity 60µF 250V with plastic sheathing tolerance ± 5% 50/60Hz ø 45mm L 96mm connection male faston 6.3mm		
For models:	GSM-anlikerXL-STANDARD, GSM-anlikerXL-STAR		

			
1			
Part No.	365013	Ref. No.	705.01015
description	operating capacitor capacity 8µF 400V tolerance 5%Hz ambient temperature max. -25 to +85°C ø 31.5mm L 55mm M8 plastic connection male faston 6.3mm protection		
For models:	GSM-FIVE-STANDARD, GSM-FIVE-STAR, GSM-Quattro-PROFI, GSM-Quattro-STANDARD		

metal			
			
1			
Part No.	365145	Ref. No.	705.01001
description	operating capacitor capacity 8µF 420/470V with metal case tolerance ± 5% 50/60Hz ø 30mm L 108mm connection male faston 6.3mm		
For models:	GSM-Quattro-PROFI, GSM-Quattro-STANDARD		

fuses

fine fuses

			
1			
Part No.	358509	Ref. No.	710.02007
description	fine fuse size ø5x20mm 0.05A slow-acting rated 250V Qty 1 pcs		
For models:	GSM-anlikerXL-STANDARD, GSM-anlikerXL-STAR, GSM-FIVE-STANDARD, GSM-FIVE-STAR		

miscellaneous

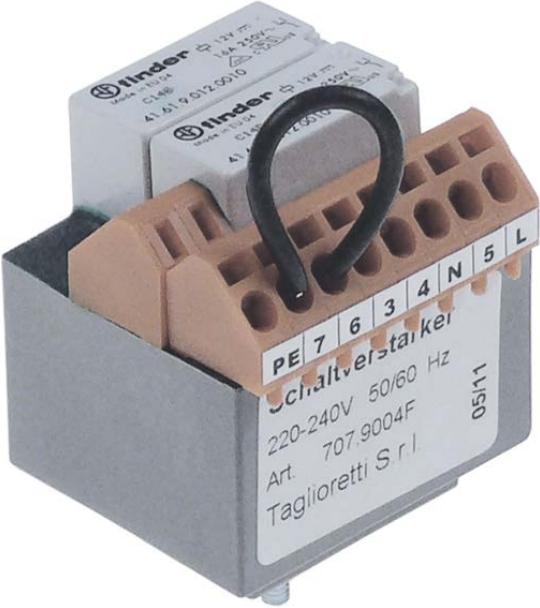
			
1			
Part No.	365148	Ref. No.	707.09004
description	switching amplifier 220-240V 50/60Hz		
For models:	GSM-anlikerXL-STANDARD, GSM-anlikerXL-STAR, GSM-FIVE-STANDARD, GSM-FIVE-STAR, GSM-Quattro-PROFI, GSM-Quattro-STANDARD		

equipment-specific units

for vegetable slicers

press levers

			
1			
Part No.	699117	Ref. No.	235.01608
description	plunger for vegetable slicer ø 125x55mm L 145mm W 125mm H 255mm		
For models:	GSM-Quattro-PROFI, GSM-Quattro-STANDARD		

ejector discs

			
1			
Part No.	699121	Ref. No.	235.01822
description	ejector H 21mm seat ø 29mm		
For models:	GSM-FIVE-STANDARD, GSM-FIVE-STAR, GSM-Quattro-PROFI, GSM-Quattro-STANDARD		



			
1			
Part No.	699114	Ref. No.	232.01860
description	ejector disc flat H 33mm ø 180mm seat ø 29mm		
For models:	GSM-FIVE-STANDARD, GSM-FIVE-STAR		

miscellaneous			
			
1			
Part No.	560466	Ref. No.	812.50960
description	adjusting washer ID ø 37mm ED ø 47mm thickness 0.1mm steel Qty 1 pcs DIN 988		
For models:	GSM-FIVE-STANDARD, GSM-FIVE-STAR		

			
1			
Part No.	699122	Ref. No.	235.02604
description	bolt ø 9mm L 35mm thread M8x1.25 SS for vegetable slicer		
For models:	GSM-anlikerXL-STANDARD, GSM-anlikerXL-STAR, GSM-FIVE-STANDARD, GSM-FIVE-STAR		

			
1			
Part No.	699116	Ref. No.	235.01607
description	bush ED ø 16mm ID ø 9.3mm L 15.5mm for catch		
For models:	GSM-Quattro-PROFI, GSM-Quattro-STANDARD		

			
1			
Part No.	699123	Ref. No.	235.02605
description	bush ED ø 16mm ID ø 9.3mm L 21mm plastic for catch		
For models:	GSM-anlikerXL-STANDARD, GSM-anlikerXL-STAR, GSM-FIVE-STANDARD, GSM-FIVE-STAR		

			
1			
Part No.	699125	Ref. No.	235.02620
description	flange ED ø 159mm ID ø 120mm H 101mm aluminium for vegetable slicer		
For models:	GSM-FIVE-STANDARD, GSM-FIVE-STAR, GSM-Quattro-PROFI, GSM-Quattro-STANDARD		

			
1			
Part No.	699127	Ref. No.	733.05002
description	gearbox ED ø 109mm ID ø 87mm H 16mm plastic for vegetable slicer		
For models:	GSM-FIVE-STANDARD, GSM-FIVE-STAR, GSM-Quattro-PROFI, GSM-Quattro-STANDARD		

			
1			
Part No.	699115	Ref. No.	235.01120
description	hinge pin ø 8mm L 25mm SS for vegetable slicer		
For models:	GSM-Quattro-PROFI, GSM-Quattro-STANDARD		

			
1			
Part No.	699124	Ref. No.	235.02619
description	planet gear ø 45mm H 41mm thread M6 mounting distance 45mm for gearbox		
For models:	GSM-FIVE-STANDARD, GSM-FIVE-STAR		

			
1			
Part No.	699118	Ref. No.	235.01644
description	shaft ø 5mm L 43.5mm thread M5 for plunger		
For models:	GSM-Quattro-PROFI, GSM-Quattro-STANDARD		



1

Part No.	699128	Ref. No.	735.01026
description	shaft sealing ED \varnothing 40mm ID \varnothing 30mm H 7mm plastic for vegetable slicer		
For models:	GSM-anlikerXL-STANDARD, GSM-anlikerXL-STAR, GSM-FIVE-STANDARD, GSM-FIVE-STAR		



1

Part No.	699120	Ref. No.	235.01811
description	slide bearing ED \varnothing 68mm ID \varnothing 60mm H 10mm plastic for vegetable slicer		
For models:	GSM-FIVE-STAR		



1

Part No.	699119	Ref. No.	235.01645
description	thread bolt \varnothing 8mm L 30mm thread M5 SS for catch		
For models:	GSM-Quattro-PROFI, GSM-Quattro-STANDARD		



1

Part No.	699126	Ref. No.	731.03001
description	Thumb screw \varnothing 19mm L 24mm thread M5 SS/plastic for vegetable slicer		
For models:	GSM-Quattro-PROFI, GSM-Quattro-STANDARD		

gaskets

O-rings

EPDM

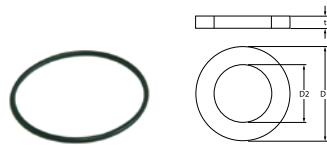

1

Part No.	512114	Ref. No.	825.20384
description	O-ring EPDM thickness 2.62mm ID \varnothing 55.25mm Qty 1 pcs		
For models:	GSM-FIVE-STAR, GSM-Quattro-PROFI		

shaft gaskets

shaft gaskets



1

Part No.	699128	Ref. No.	735.01026
description	shaft sealing ED \varnothing 40mm ID \varnothing 30mm H 7mm plastic for vegetable slicer		
For models:	GSM-anlikerXL-STANDARD, GSM-anlikerXL-STAR, GSM-FIVE-STANDARD, GSM-FIVE-STAR		

transmission technology and ball bearings

ball bearings

deep-groove ball bearings 2RS



1

Part No.	523525	Ref. No.	823.30373
description	deep-groove ball bearing type 6005-2RS shaft \varnothing 25mm ED \varnothing 47mm W 12mm with sealing discs deep-groove ball bearing DIN 625-1		
For models:	GSM-FIVE-STANDARD, GSM-FIVE-STAR		

angular contact ball bearings



1

Part No.	523017	Ref. No.	823.20473
description	angular contact ball bearing shaft \varnothing 30mm ED \varnothing 55mm W 19mm type 3006-2RS DIN 628		
For models:	GSM-anlikerXL-STANDARD, GSM-anlikerXL-STAR		



fastening material

screws

cylinder head bolts

DIN 912/ISO 4762



1

Part No.	560030	Ref. No.	801.30232
description	cylinder head bolt thread M5 thread L 25mm WS 4 SS Qty 20 pcs DIN 912/ISO 4762		
For models:	GSM-anlikerXL-STANDARD, GSM-anlikerXL-STAR, GSM-FIVE-STANDARD, GSM-FIVE-STAR, GSM-Quattro-PROFI, GSM-Quattro-STANDARD		

side bolts



1

Part No.	560053	Ref. No.	802.30102
description	side bolts thread M5 L 16mm SS Qty 20 pcs intake slotted head \varnothing 12.5mm		
For models:	GSM-anlikerXL-STANDARD, GSM-anlikerXL-STAR, GSM-FIVE-STANDARD, GSM-FIVE-STAR, GSM-Quattro-PROFI, GSM-Quattro-STANDARD		

grub screws

DIN 914/ISO 4027



1

Part No.	560169	Ref. No.	808.60018
description	grub screw thread M3 L 4mm DIN 914/ISO 4027 WS 1.5 Qty 1 pcs		
For models:	GSM-FIVE-STANDARD, GSM-FIVE-STAR		

knurled screws



1

Part No.	699126	Ref. No.	731.03001
description	Thumb screw \varnothing 19mm L 24mm thread M5 SS/plastic for vegetable slicer		
For models:	GSM-Quattro-PROFI, GSM-Quattro-STANDARD		

nuts

hexagonal nuts

DIN 934 / ISO 4032/8673



1

Part No.	560131	Ref. No.	810.10022
description	hexagonal nut thread M4 H 3.2mm WS 7 SS DIN/ISO DIN 934 / ISO 4032/8673 Qty 20 pcs		
For models:	GSM-anlikerXL-STANDARD, GSM-anlikerXL-STAR, GSM-FIVE-STANDARD, GSM-FIVE-STAR, GSM-Quattro-PROFI, GSM-Quattro-STANDARD		



1

Part No.	560132	Ref. No.	810.10032
description	hexagonal nut thread M5 H 4mm WS 8 SS DIN/ISO DIN 934 / ISO 4032/8673 Qty 20 pcs		
For models:	GSM-anlikerXL-STANDARD, GSM-anlikerXL-STAR, GSM-FIVE-STANDARD, GSM-FIVE-STAR, GSM-Quattro-PROFI, GSM-Quattro-STANDARD		



1

Part No.	560134	Ref. No.	810.10052
description	hexagonal nut thread M8 H 6.5mm WS 13 SS DIN/ISO DIN 934 / ISO 4032/8673 Qty 20 pcs		
For models:	GSM-anlikerXL-STANDARD, GSM-anlikerXL-STAR, GSM-FIVE-STANDARD, GSM-FIVE-STAR, GSM-Quattro-PROFI, GSM-Quattro-STANDARD		

washers

spring rings



1

Part No.	560122	Ref. No.	814.10039
description	lock washer ID \varnothing 5.2mm ED \varnothing 9mm SS DIN127 Qty 20 pcs for thread M5		
For models:	GSM-FIVE-STANDARD, GSM-FIVE-STAR, GSM-Quattro-PROFI, GSM-Quattro-STANDARD		



1

Part No.	560124	Ref. No.	814.10059
description	lock washer ID \varnothing 8.3mm ED \varnothing 15mm SS DIN127 Qty 20 pcs for thread M8		
For models:	GSM-FIVE-STANDARD, GSM-FIVE-STAR, GSM-Quattro-PROFI, GSM-Quattro-STANDARD		



washers

DIN 125A



1

Part No.	560111	Ref. No.	812.60032
description	plain washer ID \varnothing 4.3mm ED \varnothing 9mm thickness 0.8mm SS Qty 20 pcs DIN 125A for thread M4		
For models:	GSM-FIVE-STANDARD, GSM-FIVE-STAR, GSM-Quattro-PROFI, GSM-Quattro-STANDARD		



1

Part No.	560112	Ref. No.	812.10032
description	plain washer ID \varnothing 5.3mm ED \varnothing 10mm thickness 1mm SS Qty 20 pcs DIN 125A for thread M5		
For models:	GSM-anlikerXL-STANDARD, GSM-anlikerXL-STAR, GSM-FIVE-STANDARD, GSM-FIVE-STAR, GSM-Quattro-PROFI, GSM-Quattro-STANDARD		



1

Part No.	560114	Ref. No.	812.10052
description	plain washer ID \varnothing 8.4mm ED \varnothing 16mm thickness 1.6mm SS Qty 20 pcs DIN 125A for thread M8		
For models:	GSM-anlikerXL-STANDARD, GSM-anlikerXL-STAR, GSM-FIVE-STANDARD, GSM-FIVE-STAR		

adjusting washer (DIN 988)



1

Part No.	560466	Ref. No.	812.50960
description	adjusting washer ID \varnothing 37mm ED \varnothing 47mm thickness 0.1mm steel Qty 1 pcs DIN 988		
For models:	GSM-FIVE-STANDARD, GSM-FIVE-STAR		

tooth lock washers

DIN 6798A



1

Part No.	560125	Ref. No.	814.20022
description	tooth lock washer ID \varnothing 4.2mm ED \varnothing 8mm SS DIN/ISO DIN 6798A Qty 20 pcs for thread M4		
For models:	GSM-FIVE-STANDARD, GSM-FIVE-STAR, GSM-Quattro-PROFI, GSM-Quattro-STANDARD		



1

Part No.	560128	Ref. No.	814.20052
description	tooth lock washer ID \varnothing 8.3mm ED \varnothing 15mm SS DIN/ISO DIN 6798A Qty 20 pcs for thread M8		
For models:	GSM-FIVE-STANDARD, GSM-FIVE-STAR, GSM-Quattro-PROFI, GSM-Quattro-STANDARD		

fasteners

retaining rings

DIN 471



1

Part No.	519248	Ref. No.	815.20082
description	retaining ring shaft \varnothing 10mm thickness 1mm SS DIN 471		
For models:	GSM-FIVE-STANDARD, GSM-FIVE-STAR, GSM-Quattro-PROFI, GSM-Quattro-STANDARD		

DIN 472



1

Part No.	523102	Ref. No.	815.10314
description	retaining ring bore \varnothing 47mm thickness 1.8mm steel DIN 472		
For models:	GSM-FIVE-STANDARD, GSM-FIVE-STAR		

DIN 6799



1

Part No.	529268	Ref. No.	815.30112
description	retaining ring E D1 \varnothing 9mm D2 \varnothing 18mm stainless steel DIN 6799 thickness 1.1mm for shaft \varnothing 10-14mm		
For models:	GSM-FIVE-STAR		

consumables

fuses

fine fuses



1

Part No.	358509	Ref. No.	710.02007
description	fine fuse size \varnothing 5x20mm 0.05A slow-acting rated 250V Qty 1 pcs		
For models:	GSM-anlikerXL-STANDARD, GSM-anlikerXL-STAR, GSM-FIVE-STANDARD, GSM-FIVE-STAR		

GASTROPARTS.COM

