



**GASTROPARTS**

# NW

- [EN]** Equipment
- [DE]** Geräte
- [ES]** Aparatos
- [FR]** Équipement
- [IT]** Attrezzature
- [PL]** Urządzenia
- [RU]** Оборудование

✉ [gastroparts@gastroparts.com](mailto:gastroparts@gastroparts.com)

☎ tel. +48 56 657 00 66

📘 [fb.com/gastroparts.global](https://fb.com/gastroparts.global)





**GASTROPARTS.COM**











## heating elements

### heating elements for coffee machine

 <p>1</p>			
<b>Part No.</b>	417453	<b>Ref. No.</b>	098645
<b>description</b>	heating element 1000W 220V heating circuits 1 ø 55mm H 62mm W1 44mm H1 32mm H2 30mm mounting distance 40mm thread M10x1 stainless steel windings 4 tube ø 6mm coffee machine screw		
<b>accessories for</b>	417453		
	<b>Part No.</b>	510416	<b>Ref. No.</b> —
	flat gasket fibre ED ø 19mm ID ø 10.5mm thickness 1.5mm for thread M10 Qty 1 pcs		
	<b>Part No.</b>	510893	<b>Ref. No.</b> —
	O-ring EPDM thickness 2.62mm ID ø 9.92mm Qty 1 pcs		
	<b>Part No.</b>	520231	<b>Ref. No.</b> —
	nut thread M10x1 H 6mm WS 14 zinc-coated steel Qty 1 pcs		
	<b>Part No.</b>	521129	<b>Ref. No.</b> —
	nut thread M10 H 6mm SS WS 17 Qty 1 pcs DIN/ISO DIN 439		

### flow heaters

 <p>1</p>			
<b>Part No.</b>	417214	<b>Ref. No.</b>	0V2506
<b>description</b>	flow heater 1000W 220V ø 88mm L 110mm Wmm complete coffee machine suitable for KORO ES/Tank C252X02		
<b>spare parts for</b>	417214		
	<b>Part No.</b>	370477	<b>Ref. No.</b> 098761 258743
	solenoid valve brass 230VAC outlet 1/8" 5-way body outer cone slide-on receptacle DIN ODE coil type BDA/LBA p max 15bar coffee machine		
	<b>Part No.</b>	390624	<b>Ref. No.</b> 0V1318
	bi-metal safety thermostat hole distance 40mm switch-off temp. 125°C 2NC 2-pole 16A connection F6.3 2 hole fixing		
	<b>Part No.</b>	402078	<b>Ref. No.</b> 094372 094872 259898
	temperature probe NTC 10kOhm cable probe -40 up to +110°C cable°C connection male faston 6.3mm thread 1/4" probe ø10x25mm cable lengthm		
	<b>Part No.</b>	417453	<b>Ref. No.</b> 098645
	heating element 1000W 220V heating circuits 1 ø 55mm H 62mm W1 44mm H1 32mm H2 30mm mounting distance 40mm thread M10x1 stainless steel windings 4 tube ø 6mm coffee machine screw		
	<b>Part No.</b>	528110	<b>Ref. No.</b> 093347 095624
	O-ring EPDM thickness 2.62mm ID ø 12.37mm Qty 1 pcs		

<b>spare parts for</b>	417214		
	<b>Part No.</b>	528500	<b>Ref. No.</b> 098701
	O-ring EPDM thickness 3.53mm ID ø 72.62mm Qty 1 pcs		

## thermostats

### bi-metal thermostats



#### safety bi-metal thermostats

 <p>1</p>			
<b>Part No.</b>	390624	<b>Ref. No.</b>	0V1318
<b>description</b>	bi-metal safety thermostat hole distance 40mm switch-off temp. 125°C 2NC 2-pole 16A connection F6.3 2 hole fixing		

## switches and momentary switches



### rocker/momentary rocker switches

#### 30x22mm

 <p>1</p>			
<b>Part No.</b>	346377	<b>Ref. No.</b>	251858
<b>description</b>	rocker switch mounting measurements 30x22mm black 2CO 230V 16A 0-1 connection male faston 6.3mm ambient temperature max. 125/55°C protection IP40		
<b>accessories for</b>	346377		
	<b>Part No.</b>	301036	<b>Ref. No.</b> —
	protective cover internal size 30x22mm for rocker switch mounting measurementsmm		

### accessories

#### push buttons

 <p>1</p>			
<b>Part No.</b>	527289	<b>Ref. No.</b>	251787
<b>description</b>	button grey		
<b>accessories for</b>	527289		
	<b>Part No.</b>	402089	<b>Ref. No.</b> 251865
	keypad PCB for coffee machine		
	<b>Part No.</b>	402110	<b>Ref. No.</b> 251785
	push button set 8-piece transparent		



microswitches

roller-lever actuated

microswitches



1

<b>Part No.</b>	347028	<b>Ref. No.</b>	251861
<b>description</b>	microswitch with handle with a switch 250V 10A 1NO connection male faston 6.3mm L 28mm ambient temperature max. 125°C black/green lever length 26mm		

non-standard



1

<b>Part No.</b>	347026	<b>Ref. No.</b>	096355
<b>description</b>	microswitch with handle with a switch 250V 5A 1CO connection soldering connection L 12.5mm L1 20mm ambient temperature max. 85°C mounting distance 10mm actuating force: 55g lever length 16.6mm		

pin-plunger actuated



1

<b>Part No.</b>	300092	<b>Ref. No.</b>	097796
<b>description</b>	microswitch with plunger 400V 16A 2NO connection male faston 6.3mm ambient temperature max. 85°C mounting distance 22mm type XTD22A21 actuating force: 150g fryer black		

with push button

switches with snap-fit



1

<b>Part No.</b>	347027	<b>Ref. No.</b>	0V2378
<b>description</b>	microswitch with push button 250V 1A 1CO connection male faston 2.8mm L 26x12mm ambient temperature max. 85°C type XKA-304B1AAJ11 actuating force: 50g		

accessories



1

<b>Part No.</b>	347031	<b>Ref. No.</b>	090681
<b>description</b>	insulating mat for microswitch L 42mm W 28mm		

float switches

floats



1

<b>Part No.</b>	527288	<b>Ref. No.</b>	251851
<b>description</b>	float for drip pan		



1

<b>Part No.</b>	527287	<b>Ref. No.</b>	251876
<b>description</b>	float with magnet ømm L 23.5mm W 16mm H 17mm plastic		

magnetic switches

29x19mm



1

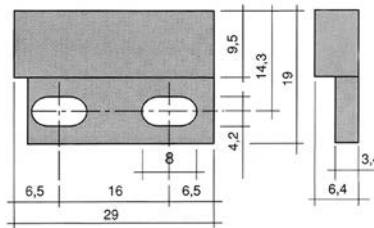

<b>Part No.</b>	347030 <sup>1</sup>	<b>Ref. No.</b>	251860
<b>description</b>	magnetic switch L 29mm W 19mm 1NO 250V cable length 360mm		

<sup>1</sup>with coded connector



## transformers

### open transformers

#### with cable connection

			
1			
<b>Part No.</b>	400058	<b>Ref. No.</b>	098792
<b>description</b>	transformer primary 230V secondary 15V 15VA connection cable 250mm 50/60Hz		

## probes

### producer-specific probes

#### probes

			
1			
<b>Part No.</b>	402078	<b>Ref. No.</b>	094372 094872 259898
<b>description</b>	temperature probe NTC 10kOhm cable probe -40 up to +110°C cable°C connection male faston 6.3mm thread 1/4" probe ø10x25mm cable lengthm		
<b>spare parts for</b>	402078		
			
	<b>Part No.</b>	528110	<b>Ref. No.</b> 093347 095624
	O-ring EPDM thickness 2.62mm ID ø 12.37mm Qty 1 pcs		

## electronics

### PCBs

			
1			
<b>Part No.</b>	402088	<b>Ref. No.</b>	0V2143
<b>description</b>	control PCB coffee machine KORO		

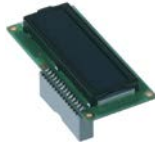
			
1			
<b>Part No.</b>	402090	<b>Ref. No.</b>	0V3458 251653
<b>description</b>	display coffee machine KORO		

			
1			
<b>Part No.</b>	402089	<b>Ref. No.</b>	251865
<b>description</b>	keypad PCB for coffee machine		
<b>accessories for</b>	402089		
	<b>Part No.</b>	402110	<b>Ref. No.</b> 251785
	push button set 8-piece transparent		
	<b>Part No.</b>	527289	<b>Ref. No.</b> 251787
	button grey		

			
1			
<b>Part No.</b>	402091	<b>Ref. No.</b>	252604
<b>description</b>	PCB coffee machine KORO 16Bit		

## keypads

### accessories

			
1			
<b>Part No.</b>	402111	<b>Ref. No.</b>	251786
<b>description</b>	push button L 60mm W 11mm H 9mm grey		

			
1			
<b>Part No.</b>	402110	<b>Ref. No.</b>	251785
<b>description</b>	push button set 8-piece transparent		
<b>accessories for</b>	402110		
	<b>Part No.</b>	402089	<b>Ref. No.</b> 251865
	keypad PCB for coffee machine		
	<b>Part No.</b>	527289	<b>Ref. No.</b> 251787
	button grey		



## solenoid valves

## solenoid valves (water)

## various



1

<b>Part No.</b>	372216	<b>Ref. No.</b>	251895 253818
<b>description</b>	solenoid valve with pressure switch single, angled 230VAC outlet 11mm inlet 3/4"mm		

## metal

## ODE

## 5-way



1

<b>Part No.</b>	370477	<b>Ref. No.</b>	098761 258743
<b>description</b>	solenoid valve brass 230VAC outlet 1/8" 5-way body outer cone slide-on receptacle DIN ODE coil type BDA/LBA p max 15bar coffee machine		

## spare parts for 370477

	<b>Part No.</b>	371150	<b>Ref. No.</b>	099057
	<b>description</b>	solenoid coil ODE 230VAC 16VA coil type BDV seat ø 13.5mm 750Ohm		
	<b>Part No.</b>	371191	<b>Ref. No.</b>	099056
	<b>description</b>	solenoid coil ODE 230VAC 10VA 50Hz coil type LBA seat ø 10mm		
	<b>Part No.</b>	371192	<b>Ref. No.</b>	099105
	<b>description</b>	solenoid valve body ø 13mm		
	<b>Part No.</b>	371193	<b>Ref. No.</b>	097472
	<b>description</b>	valve insert L 30mm ø 12mm Viton		
	<b>Part No.</b>	371194	<b>Ref. No.</b>	0V1953
	<b>description</b>	solenoid valve body ø 10mm		
	<b>Part No.</b>	371195	<b>Ref. No.</b>	099058
	<b>description</b>	valve insert L 24mm ø 9mm Viton		
	<b>Part No.</b>	510177	<b>Ref. No.</b>	094594
	<b>description</b>	O-ring EPDM thickness 1.78mm ID ø 7.66mm Qty 1 pcs		
	<b>Part No.</b>	520333	<b>Ref. No.</b>	095529
	<b>description</b>	hose connector brass straight thread 1/8" hose ø 7mm Qty 1 pcs		
	<b>Part No.</b>	520334	<b>Ref. No.</b>	0V2509
	<b>description</b>	angle piece thread 1/8" with coupling angled hose ø 5mm		

## spare parts and accessories

## gaskets



1

<b>Part No.</b>	371196	<b>Ref. No.</b>	099059
<b>description</b>	O-ring ø 12mm for valve body		

## solenoid coils



1

<b>Part No.</b>	371191	<b>Ref. No.</b>	099056
<b>description</b>	solenoid coil ODE 230VAC 10VA 50Hz coil type LBA seat ø 10mm		



1

<b>Part No.</b>	371150	<b>Ref. No.</b>	099057
<b>description</b>	solenoid coil ODE 230VAC 16VA coil type BDV seat ø 13.5mm 750Ohm		

## valve inserts



1

<b>Part No.</b>	371195	<b>Ref. No.</b>	099058
<b>description</b>	valve insert L 24mm ø 9mm Viton		



1

<b>Part No.</b>	371193	<b>Ref. No.</b>	097472
<b>description</b>	valve insert L 30mm ø 12mm Viton		

## valve bodies



1

<b>Part No.</b>	371194	<b>Ref. No.</b>	0V1953
<b>description</b>	solenoid valve body ø 10mm		



			
1			
<b>Part No.</b>	371192	<b>Ref. No.</b>	099105
<b>description</b>	solenoid valve body ø 13mm		

## flow meters and flow sensors

### flow meters

#### GICAR

			
1			
<b>Part No.</b>	400782	<b>Ref. No.</b>	098707
<b>description</b>	flow meter hose ø 6mm plastic plug-in connection approval NSF		

## fans

### axial fans

#### ebm-papst

			
1			
<b>Part No.</b>	601496 <sup>1</sup>	<b>Ref. No.</b>	251867
<b>description</b>	axial fan L 60mm W 60mm H 25mm 12VDC 0.8W bearing ball bearing manuf. no. 612NME plastic connection cable 310mm ebm-papst fan wheel ø 55mm with plug		

<sup>1</sup>with ball bearings

## motors

### gear motors

#### for automatic coffee machines

			
1			
<b>Part No.</b>	601486	<b>Ref. No.</b>	252030
<b>description</b>	gear motor 90W 230V 50Hz 48rpm shaft ø 15mm L 95mm W 61mm H 90mm for coffee machine		

			
1			
<b>Part No.</b>	601488	<b>Ref. No.</b>	251866
<b>description</b>	gear motor 90W 230V 50Hz 70rpm shaft ø 15mm L 96mm W 55mm H 90mm for coffee machine		

			
1			
<b>Part No.</b>	601490	<b>Ref. No.</b>	098708
<b>description</b>	gear motor LIP type 111 48W 230V 50Hz 8rpm shaft ø 6x8.5mm L 110mm W 71mm H 80mm		

### motors

#### for automatic coffee machines

			
1			
<b>Part No.</b>	601494	<b>Ref. No.</b>	251777
<b>description</b>	motor for coffee grinder 230V 48W 50/60Hz 1 phase shaft ø 7.5mm shaft length 24mm H 70mm L 120mm W 70mm KORO- ESPRESSO FISE		





1

<b>Part No.</b>	601495	<b>Ref. No.</b>	098808
<b>description</b>	motor for mixer 230V 50/60Hz 1 phase shaft ø 4mm shaft length 27mm KORO- ESPRESSO		
<b>accessories for</b>	601495		
	<b>Part No.</b>	527278	<b>Ref. No.</b> 097916
	impellor ø 32mm		



1

<b>Part No.</b>	500124	<b>Ref. No.</b>	098760
<b>description</b>	vibration pump type EX 5 230V 48W 50/60Hz inlet ø 6 outlet ø 1/8" IT flat seal ULKA brass L 123mm		
<b>accessories for</b>	500124		
	<b>Part No.</b>	520152	<b>Ref. No.</b> 252021
	hose connector Santoprene grommet ø 7mm grommet length 14mm		
	<b>Part No.</b>	520330	<b>Ref. No.</b> 0V4275
	bracket rubber dimensions 69x44x4mm		

## pumps

### vibration pumps



1

<b>Part No.</b>	520330	<b>Ref. No.</b>	0V4275
<b>description</b>	bracket rubber dimensions 69x44x4mm		



1

<b>Part No.</b>	520152	<b>Ref. No.</b>	252021
<b>description</b>	hose connector Santoprene grommet ø 7mm grommet length 14mm		



1

<b>Part No.</b>	390625	<b>Ref. No.</b>	0V1301
<b>description</b>	thermal fuse switch-off temp. 110°C suitable for ULKA pump Klixon		

## condensators & interference suppression filters

### filters

#### line filters

#### with housing



1

<b>Part No.</b>	365077	<b>Ref. No.</b>	097155 0V3512
<b>description</b>	line filter type 411524410 250V 50/60Hz conductor 2 with E connection male faston 6.3mm L 50mm ø 38mm Hmm Wmm M8 plastic Qty 1 pcs		

## fuses

### fine fuses



1

<b>Part No.</b>	358593	<b>Ref. No.</b>	097544
<b>description</b>	fine fuse size ø5x20mm 0.125A slow-acting rated 250V Qty 10 pcs		



1

<b>Part No.</b>	358601	<b>Ref. No.</b>	097103
<b>description</b>	fine fuse size ø5x20mm 1.25A slow-acting rated 250V Qty 10 pcs		





			
1			
<b>Part No.</b>	358851	<b>Ref. No.</b>	095636
<b>description</b>	fuse size ø6.3x32mm 15A slow-acting rated 250V Qty 1 pcs		

fine fuse holders			
			
1			
<b>Part No.</b>	358852	<b>Ref. No.</b>	251863
<b>description</b>	fuse holder suitable fuse ø6.3x32mm ø 16mm 1-pole 16A rated 250V L 52mm connection male faston 4.8mm/6.3mm		

## electric accessories

### terminals

terminal blocks with fuse holder			
			
1			
<b>Part No.</b>	358391	<b>Ref. No.</b>	097241
<b>description</b>	lustre terminal 2-pole max. 24A max 450V suitable fuse ø5x20mm cross section 2.5mm <sup>2</sup> with fuse holder		

			
1			
<b>Part No.</b>	358393	<b>Ref. No.</b>	098793
<b>description</b>	lustre terminal 4-pole max. 24A max 450V suitable fuse ø5x20mm cross section 2.5mm <sup>2</sup> with fuse holder		



connection terminals with screw/faston connections			
			
1			
<b>Part No.</b>	550458	<b>Ref. No.</b>	251856
<b>description</b>	power terminal block 3-pole max. 25A max 450V connection ø2.5mm <sup>2</sup> / F6.3 temp.-resist. 150°C		

## equipment-specific units

### for espresso machines

#### non-return valves

##### complete

			
1			
<b>Part No.</b>	529889	<b>Ref. No.</b>	099101
<b>description</b>	non-return valve thread 1/8" IT - 1/8" ET		
<b>accessories for</b>	529889		
	<b>Part No.</b>	<b>Ref. No.</b>	
	691535	251143	
			
	disc ID ø 10mm ED ø 14mm thicknessmm aluminium Qty 1 pcs		

#### screw connections

##### washers

			
1			
<b>Part No.</b>	691535	<b>Ref. No.</b>	251143
<b>description</b>	disc ID ø 10mm ED ø 14mm thicknessmm aluminium Qty 1 pcs		

### for coffee grinders

#### coffee beans containers

##### container lids

			
1			
<b>Part No.</b>	527843	<b>Ref. No.</b>	252423
<b>description</b>	lid L 180mm W 160mm H 3mm plastic transparent for coffee beans container		

#### coffee beans containers

			
1			
<b>Part No.</b>	527572	<b>Ref. No.</b>	251770
<b>description</b>	coffee grinder		
<b>spare parts for</b>	527572		
	<b>Part No.</b>	<b>Ref. No.</b>	
	402076	251779	
			
	sensor for coffee grinder complete		
	<b>Part No.</b>	<b>Ref. No.</b>	
	527249	095840	
			
	grinding burr turn direction right D1 ø 63mm ID ø 38mm H 9mm tooth spacing 3mm hole ø 5.5mm bore ø 8.5mm mounting ø 48 straight suitable for N & W		
	<b>Part No.</b>	<b>Ref. No.</b>	
	601494	251777	
			
	motor for coffee grinder 230V 48W 50/60Hz 1 phase shaft ø 7.5mm shaft length 24mm H 70mm L 120mm W 70mm KORO- ESPRESSO FISE		





## for cup coffee machines

## instant mixer units



1

<b>Part No.</b>	527279	<b>Ref. No.</b>	251833
<b>description</b>	coffee device type Z3000		



1

<b>Part No.</b>	527277	<b>Ref. No.</b>	251869
<b>description</b>	flange for mixing hopper		



1

<b>Part No.</b>	527278	<b>Ref. No.</b>	097916
<b>description</b>	impellor ø 32mm		



1

<b>Part No.</b>	527275	<b>Ref. No.</b>	251768
<b>description</b>	intake body plastic		

accessories for 527275

	<b>Part No.</b>	527276	<b>Ref. No.</b>	251767
	<b>description</b>	lid plastic for intake body		



1

<b>Part No.</b>	527276	<b>Ref. No.</b>	251767
<b>description</b>	lid plastic for intake body		



1

<b>Part No.</b>	527274	<b>Ref. No.</b>	251874
<b>description</b>	mixing hopper plastic		

## coffee spouts

## coffee spouts



1

<b>Part No.</b>	527283	<b>Ref. No.</b>	096868
<b>description</b>	coffee spout for coffee powder container rectangular		



1

<b>Part No.</b>	527282	<b>Ref. No.</b>	098939
<b>description</b>	coffee spout for coffee powder container round		

## coffee beans containers

## container lids



1

<b>Part No.</b>	527843	<b>Ref. No.</b>	252423
<b>description</b>	lid L 180mm W 160mm H 3mm plastic transparent for coffee beans container		



coffee beans containers



1

<b>Part No.</b>	527280	<b>Ref. No.</b>	251908
<b>description</b>	container complete incl. coil, lift and scraper for instant unit		
<b>accessories for</b>	527280		
	<b>Part No.</b>	527282	<b>Ref. No.</b> 098939
	coffee spout for coffee powder container round		



1

<b>Part No.</b>	527281	<b>Ref. No.</b>	251875
<b>description</b>	container with auger gear for instant unit		
<b>accessories for</b>	527281		
	<b>Part No.</b>	527282	<b>Ref. No.</b> 098939
	coffee spout for coffee powder container round		

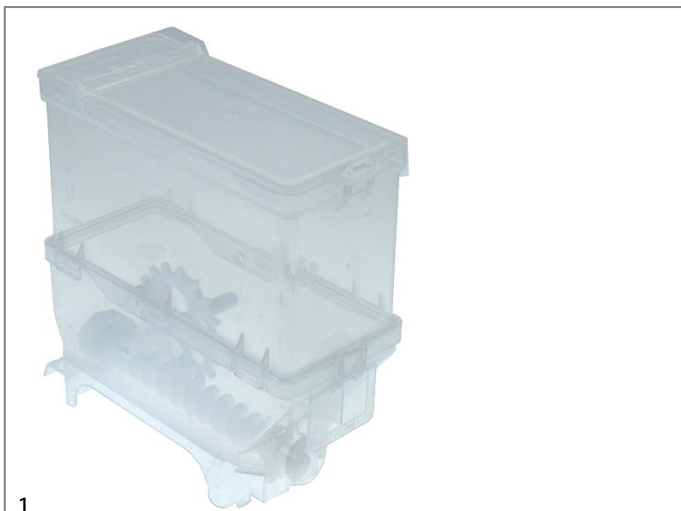

1

<b>Part No.</b>	527834	<b>Ref. No.</b>	252462
<b>description</b>	container standard		
<b>accessories for</b>	527834		
	<b>Part No.</b>	527283	<b>Ref. No.</b> 096868
	coffee spout for coffee powder container rectangular		

accessories



1

<b>Part No.</b>	527285	<b>Ref. No.</b>	252424
<b>description</b>	base part for coffee beans container		
<b>accessories for</b>	527285		
	<b>Part No.</b>	527284	<b>Ref. No.</b> 252536
	increasing for coffee beans container		



1

<b>Part No.</b>	527284	<b>Ref. No.</b>	252536
<b>description</b>	increasing for coffee beans container		
<b>accessories for</b>	527284		
	<b>Part No.</b>	527843	<b>Ref. No.</b> 252423
	lid L 180mm W 160mm H 3mm plastic transparent for coffee beans container		



## grinding units

## automatic grinding



1

<b>Part No.</b>	402076	<b>Ref. No.</b>	251779
-----------------	--------	-----------------	--------

**description** sensor for coffee grinder complete

## grinding burrs



1

<b>Part No.</b>	527249	<b>Ref. No.</b>	095840
-----------------	--------	-----------------	--------

**description** grinding burr turn direction right D1 ø 63mm ID ø 38mm H 9mm tooth spacing 3mm hole ø 5.5mm bore ø 8.5mm mounting ø 48 straight suitable for N & W

## mechanical components



1

<b>Part No.</b>	520334	<b>Ref. No.</b>	0V2509
-----------------	--------	-----------------	--------

**description** angle piece thread 1/8" with coupling angled hose ø 5mm

## keys



1

<b>Part No.</b>	527290	<b>Ref. No.</b>	097812 0V1654
-----------------	--------	-----------------	------------------

**description** service key

## water containers



1

<b>Part No.</b>	527286	<b>Ref. No.</b>	251873
-----------------	--------	-----------------	--------

**description** water container complete

**spare parts for** 527286

<b>Part No.</b>	527287	<b>Ref. No.</b>	251876
-----------------	--------	-----------------	--------



**description** float with magnet ømm L 23.5mm W 16mm H 17mm plastic

## counters



1

<b>Part No.</b>	527273	<b>Ref. No.</b>	251862
-----------------	--------	-----------------	--------

**description** counter coffee machine impulse 10imp/s mounting measurements 22x30mm 12VDC

## locks

## locking devices

## producer-specific

## N&amp;W



1

<b>Part No.</b>	691527	<b>Ref. No.</b>	252137
-----------------	--------	-----------------	--------

**description** key cylinder with key

## gaskets

## O-rings

## EPDM



1

<b>Part No.</b>	529545	<b>Ref. No.</b>	092140 252684
-----------------	--------	-----------------	------------------

**description** O-ring EPDM thickness 1.78mm ID ø 10.82mm Qty 1 pcs



1

<b>Part No.</b>	510177	<b>Ref. No.</b>	094594
-----------------	--------	-----------------	--------

**description** O-ring EPDM thickness 1.78mm ID ø 7.66mm Qty 1 pcs

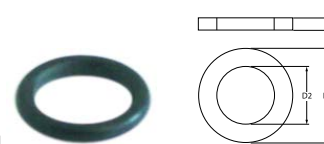

1

<b>Part No.</b>	528110	<b>Ref. No.</b>	093347 095624
-----------------	--------	-----------------	------------------

**description** O-ring EPDM thickness 2.62mm ID ø 12.37mm Qty 1 pcs

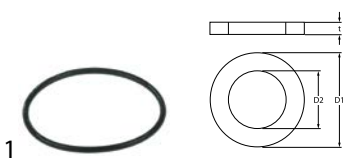
<b>Part No.</b>	528500	<b>Ref. No.</b>	098701
<b>description</b>	O-ring EPDM thickness 3.53mm ID ø 72.62mm Qty 1 pcs		



<b>Part No.</b>	520840	<b>Ref. No.</b>	097513
<b>description</b>	silicone hose ID ø 9mm ED ø 13mm L 1m thickness 2mm operating pressure without pressure burst pressure non defined t.max. 200°C brown		

## hoses

### industrial hoses

#### PTFE hoses

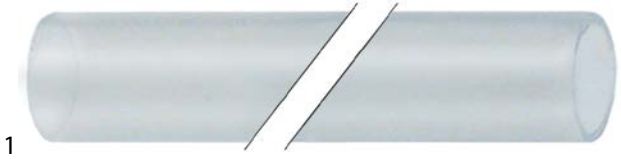

<b>Part No.</b>	520845 <sup>1</sup>	<b>Ref. No.</b>	252658
<b>description</b>	PTFE hose ED ø 6mm ID ø 3mm thickness 1.5mm Lm		

<sup>1</sup>by the meter

#### silicone hoses

##### without fabric



<b>Part No.</b>	520842	<b>Ref. No.</b>	097529
<b>description</b>	silicone hose ID ø 3mm ED ø 6mm L 1m thickness 1.5mm t.max. 200°C brown		



<b>Part No.</b>	520843	<b>Ref. No.</b>	097510
<b>description</b>	silicone hose ID ø 5mm ED ø 9mm L 1m thickness 2mm operating pressure without pressure burst pressure non defined t.max. 200°C brown		



<b>Part No.</b>	520844	<b>Ref. No.</b>	097511
<b>description</b>	silicone hose ID ø 6mm ED ø 9mm L 1m thickness 1.5mm operating pressure without pressure burst pressure non defined t.max. 200°C brown		

## fittings, hose and pipe connectors

### hose connectors

#### brass



<b>Part No.</b>	520333	<b>Ref. No.</b>	095529
<b>description</b>	hose connector brass straight thread 1/8" hose ø 7mm Qty 1 pcs		

## fastening material

### screws

#### flat-headed bolts



<b>Part No.</b>	560062	<b>Ref. No.</b>	252917
<b>description</b>	flat-headed bolt thread M4 thread L 10mm SS DIN 7985/ISO 7045 Qty 20 pcs intake Phillips head ø 8mm head thickness 2mm		

### washers

#### washers

#### miscellaneous



<b>Part No.</b>	691535	<b>Ref. No.</b>	251143
<b>description</b>	disc ID ø 10mm ED ø 14mm thicknessmm aluminium Qty 1 pcs		



# consumables

## fuses

### fine fuses



1

<b>Part No.</b>	358593	<b>Ref. No.</b>	097544
<b>description</b>	fine fuse size ø5x20mm 0.125A slow-acting rated 250V Qty 10 pcs		



1

<b>Part No.</b>	358601	<b>Ref. No.</b>	097103
<b>description</b>	fine fuse size ø5x20mm 1.25A slow-acting rated 250V Qty 10 pcs		

### ø6.3x32mm 250V



1

<b>Part No.</b>	358851	<b>Ref. No.</b>	095636
<b>description</b>	fuse size ø6.3x32mm 15A slow-acting rated 250V Qty 1 pcs		

**GASTRO**PARTS.COM

