







GASTROPARTS

zmywarki / dishwashers

ELFRAMO

-  www.gastroparts.com
-  gastroparts@gastroparts.com
-  tel. +48 56 657 00 68
-  [/gastroparts.global](https://www.facebook.com/gastroparts.global)
-  [/gastroparts.global](https://www.instagram.com/gastroparts.global)



heating elements

coil heating elements



Part No.	420345	Ref. No.	00055600 00055640
description	heating element 1400W 230V L 285mm W 135mm ø 19.5mm thread 3/8" connection M5 for drying heating circuits 1 2 hole fixing		
For models:	EN, ET, ET020, ETA, ETE20, ETE21, ETE25, ETE27, ETS15		

immersion heating elements

miscellaneous



Part No.	418574	Ref. No.	00203052 00203053
description	heating element 3000W 230V heating circuits 1 L 233mm W 45mm H 29mm rectangular flange hole distance 50mm hole ø 9.5mm connection male faston 6.3mm tube ø 8.5mm flange length 96mm flange width 80mm immersion heater INCOLOY-800		
For models:	BD13, BD14, BD46, BD47, BD50, BE35, BE40, BE50		
accessories for	418574		
	Part No.	510401	Ref. No. 00003430
	gasket rubber L 88mm W 73mm thickness 5mm hole ø 7mm hole distance 65mm for heating element 4 holes ID ø 50mm		



Part No.	418548	Ref. No.	00003305 00003324 00003325
description	heating element 5200W 230V heating circuits 3 L 325mm W 47mm H 50mm tube ø 8.5mm hole distance 62mm hole ø 9.3mm connection M4 4 hole flange immersion heater flange width 81mm flange length 96mm with thermal fuse		
For models:	120, 160, 240, 885, 904, 906, 908, 912, C33, C34, C34dgt, C44, C44dgt, C44dgt-elt, C66, C66dgt, C66dgt-elt, C77, CE24, D120, D120dgt, D30, D35, D36, D40, D40ELT, D40ELT-BT-BA, D40i, D40i-BT-BA, D40i-ELT-BT-BA, D45, D80, D80F, D85, LP60		
spare parts for	418548		
	Part No.	510401	Ref. No. 00003430
	gasket rubber L 88mm W 73mm thickness 5mm hole ø 7mm hole distance 65mm for heating element 4 holes ID ø 50mm		



Part No.	420213	Ref. No.	00003335
description	heating element 9000W 240V heating circuits 3 L 483mm W 46mm H 40mm tube ø 8.5mm hole distance 65mm hole ø 9.5mm connection M4 4 hole flange immersion heater flange width 81mm flange length 96mm		
For models:	CE24, ETE20, ETE21, ETE25, ETE27, ETS15, LP130		
accessories for	420213		
	Part No.	510401	Ref. No. 00003430
	gasket rubber L 88mm W 73mm thickness 5mm hole ø 7mm hole distance 65mm for heating element 4 holes ID ø 50mm		



Part No.	418879	Ref. No.	00003349
description	heating element 9800W 230V heating circuits 3 L 322mm W 37mm H 68mm number of thermostat sleeves 2 thermostat sleeves ø 6.5/10mm length thermostat sleeves 185/80mm tube ø 6.3mm hole distance 65/45mm hole ø 10mm connection M4 4 hole flange immersion heater flange width 81mm flange length 96mm		
For models:	120, 160, 240, 885, 904, 906, 908, 912, C33, C34, C34dgt, C44, C44dgt, C44dgt-elt, C66, C66dgt, C66dgt-elt, C77, CW650-15, CW650-16, CW650-35, CW650-36, D120, D120dgt, D30, D40, D40ELT, D40ELT-BT-BA, D40i, D40i-BT-BA, D40i-ELT-BT-BA, D45, D80, D80F, D85, EN, ET, ET020, ETA, ETE20, ETE21, ETE25, ETE27, ETS15, LP130, LP60, LP60H, LP61, LP61H, LP70		
accessories for	418879		
	Part No.	510401	Ref. No. 00003430
	gasket rubber L 88mm W 73mm thickness 5mm hole ø 7mm hole distance 65mm for heating element 4 holes ID ø 50mm		





1 1/4"







Part No.	415153	Ref. No.	00002430 00003251 00003270 00003271
description	heating element 5700W 230V heating circuits 3 thread 1 1/4" L 300mm W 85mm H 42mm L1 120mm L2 180mm W1 29mm W2 28mm H1 21mm H2 21mm tube ø 6.3mm connection male faston 6.3mm connection length 40mm flange with thread immersion heater		
For models:	120, 160, 240, 882, 885, 904, 906, 908, 912, C33, C44, C44dgt, C44dgt-elt, C66, C66dgt, C66dgt-elt, C77, D120, D120dgt, D35, D36, D40, D40ELT, D40ELT-BT-BA, D40i, D40i-ELT-BT-BA, D45, D80, D80F, D85, LP60, LP60H, LP61, LP61H, LP70		
spare parts for	415153		
	Part No.	510405	Ref. No. —
	flat gasket fibre ED ø 56mm ID ø 42mm thickness 2mm for thread 1 1/4" Qty 1 pcs		
accessories for	415153		
	Part No.	520232	Ref. No. —
	nut thread 1 1/4" H 5mm nickel-plated brass WS 47 Qty 1 pcs		
	Part No.	528021	Ref. No. —
	flat gasket PTFE ED ø 53mm ID ø 42.5mm thickness 3mm Qty 1 pcs equiv. no. 12001/02286 suitable for Astoria/Aurora/Brasilia/Wega		



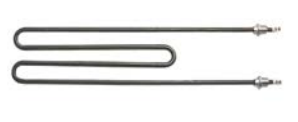

			
1			
Part No.	418981	Ref. No.	00003277
description	heating element 1000/1300/1400W 200/230/240V heating circuits 1 L 213mm W 67mm H 29mm thread 1/4" mounting distance 61mm tube ø 6.3mm connection male faston 6.3mm immersion heater		
For models:	BD46, BD47, BE35, BE40		

			
1			
Part No.	416281	Ref. No.	00203091
description	heating element 2000W 230V heating circuits 1 L 300mm W 76mm H 30mm thread 1/4" mounting distance 80mm tube ø 6.3mm connection male faston 6.3mm 2 hole fixing connection length 15mm immersion heater		
For models:	B11, B15, BD11, BD13, BD14, BD14alt, BD22, BD46, BD47, D30, D35, D36, D40, D40ELT, D40ELT-BT-BA, D40i, D40i-ELT-BT-BA		
spare parts for	416281		
	Part No.	Ref. No.	
	510417	—	flat gasket fibre ED ø 20mm ID ø 14mm thickness 2mm Qty 1 pcs
accessories for	416281		
	Part No.	Ref. No.	
	361182	—	nut thread 1/4" H 5mm nickel-plated brass WS 17 Qty 1 pcs
	Part No.	Ref. No.	
	520228	—	tooth lock washer ID ø 15.3mm ED ø 24mm steel Qty 1 pcs for thread M14
	Part No.	Ref. No.	
	550262	—	flat gasket copper ED ø 20mm ID ø 14mm thickness 2mm

			
1			
Part No.	415176	Ref. No.	00203089
description	heating element 2700W 230V heating circuits 1 L 350mm W 70mm thread 1/4" mounting distance 64mm tube ø 6.25mm 2 hole fixing immersion heater connection male faston 6.3mm		
For models:	42, 42E, 48, 48E, 55, 55E, 60		

			
1			
Part No.	416282	Ref. No.	00018070
description	heating element 3200W 230V heating circuits 1 L 350mm W 77mm H 33mm thread 1/4" mounting distance 71mm tube ø 6.3mm connection male faston 6.3mm 2 hole fixing immersion heater		
For models:	882, 885, BD50, BE50, BE50T, C33, C34, C34dgt, C44, C44dgt, C44dgt-elt, C66, C77, CE24, D120, D120dgt, D80, D80F, D85, LP60, LP60H		
spare parts for	416282		
	Part No.	Ref. No.	
	510417	—	flat gasket fibre ED ø 20mm ID ø 14mm thickness 2mm Qty 1 pcs
accessories for	416282		
	Part No.	Ref. No.	
	361182	—	nut thread 1/4" H 5mm nickel-plated brass WS 17 Qty 1 pcs

accessories for	416282		
	Part No.	Ref. No.	
	520228	—	tooth lock washer ID ø 15.3mm ED ø 24mm steel Qty 1 pcs for thread M14
	Part No.	Ref. No.	
	550262	—	flat gasket copper ED ø 20mm ID ø 14mm thickness 2mm

accessories

washers

			
1			
Part No.	560113	Ref. No.	02120006
description	plain washer ID ø 6.4mm ED ø 12mm thickness 1.6mm SS Qty 20 pcs DIN 125A for thread M6		
For models:	42, 42E, 48, 48E, 55, 55E, 60, BD14, BD14alt, BD22, D120, D30, D35, D36, D40, D40ELT, D40ELT-BT-BA, D40i, D40i-BT-BA, D40i-ELT-BT-BA, D45, D80		

flange gaskets

			
1			
Part No.	510400	Ref. No.	00202180
description	gasket L 70mm W 70mm thickness 3mm hole ø 40mm hole distance 44x44mm for heating element		

			
1			
Part No.	510401	Ref. No.	00003430
description	gasket rubber L 88mm W 73mm thickness 5mm hole ø 7mm hole distance 65mm for heating element 4 holes ID ø 50mm		
For models:	120, 160, 240, 42, 42E, 48, 48E, 55, 55E, 60, 882, 885, 904, 906, 908, 912, B11, B15, BD11, BD13, BD14, BD14alt, BD22, BD46, BD47, BD50, BE35, BE40, BE50, BE50T, C33, C34, C34dgt, C44, C44dgt, C44dgt-elt, C66, C66dgt, C66dgt-elt, C77, CE24, CW650-15, CW650-16, CW650-35, CW650-36, D120, D120dgt, D30, D35, D36...(Other models you can see in the webshop)		

protection caps

			
1			
Part No.	511486	Ref. No.	00000342 00003420
description	cover H 47mm W 80mm L 98mm		
For models:	120, 160, 240, 882, 885, 904, 906, 908, 912, C33, C34, C34dgt, C44, C44dgt, C44dgt-elt, C66, C66dgt, C66dgt-elt, C77, CE24, CW650-15, CW650-16, CW650-35, CW650-36, D120, D120dgt, D30, D35, D36, D40, D40ELT, D40ELT-BT-BA, D40i, D40i-ELT-BT-BA, D45, D80, D80F, D85, EN, ET, ET020, ETA, ETE20, ETE21, ETE25, ETE27, ETS15, LP130, LP60, LP60H...(Other models you can see in the webshop)		



thermostats

bi-metal thermostats

safety bi-metal thermostats



1

Part No.	390748	Ref. No.	22110020
description	bi-metal safety thermostat hole distance 23.5mm switch-off temp. 100°C 1NC 1-poleA connection F6.3		
For models:	42, 42E, 48, 48E, 55, 55E, 60, 882, B11, B15, BD11, BD13, BD14, BD14alt, BD22, BE35, BE40, D30		

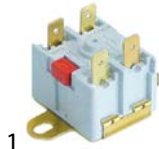

1

Part No.	390681	Ref. No.	22110021
description	bi-metal safety thermostat hole distance 40mm switch-off temp. 105°C 2NC 2-pole 16A 250V connection F6.3		
For models:	BE35, BE40, BE50		

bi-metal thermostats



1

Part No.	390909	Ref. No.	22180101
description	bi-metal thermostat hole distance 46mm switch-off temp. 56°C 1NC 1-pole 16A 250V connection F6.3 Qty 1 pcs		
For models:	BE35, BE40		

control and safety thermostats

EGO

control thermostats

55.10/19_ series

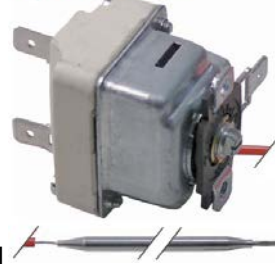

1

Part No.	375534	Ref. No.	22180004
description	thermostat t.max. 90°C temperature range 19-90°C 1-pole 1CO 16A probe ø 6mm probe L 129mm capillary pipe 980mm capillary pipe isolated 960mm gland nut shaft Lmm shaft position rotation 180°		
For models:	B11, B15, BD11, BD13, BD14, BD14alt, BD22, BD46, BD47, BD50, BE35, BE40, BE50, BE50T, C33, C34, C34dgt, C44, C44dgt, C44dgt-elt, C66, C66dgt, C66dgt-elt, C77, CE24, CW650-15, CW650-16, CW650-35, CW650-36, D120, D120dgt, D30, D35, D36, D40, D40i, D40i-BT-BA, D45, D80, D80F, D85, ETE20, ETE21, ETE25, ETE27, LP60, LP60H, LP61, LP61H, LP70		

55.34_ series



1

Part No.	390042	Ref. No.	00003190 0000319A 22190001
description	thermostat t.max. 85°C temperature range 35-85°C 3-pole 3CO 16A probe ø 9.5mm probe L 80mm capillary pipe 870mm capillary pipe isolatedmm gland nut shaft ø 6x4.6mm shaft L 23mm shaft position upper° rotation 180° with disc disc ø 10mm		



safety thermostats

55.10/19_ series



Part No.	390738	Ref. No.	22180100
description	safety thermostat switch-off temp. 107°C 1-pole 1NC 16A probe ø 6mm probe L 77mm capillary pipe 1170mm capillary pipe isolated 1150mm gland nut probe material SS		
For models:	EN, ET, ET020, ETA, LPE100, LPE145		

55.32_ series

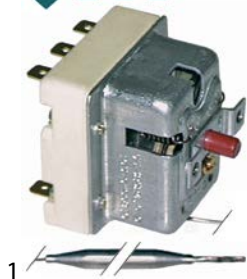

Part No.	390178	Ref. No.	22100002
description	safety thermostat switch-off temp. 124°C 3-pole 20A probe ø 6mm probe L 74mm capillary pipe 900mm capillary pipe isolated 900mm gland nut probe SS		
For models:	120, 160, 240, 882, 885, 904, 906, 908, 912, C33, C34, C34dgt, C44, C44dgt, C44dgt-elt, C66, C66dgt, C66dgt-elt, C77, CE24, D120, D120dgt, D30, D35, D36, D40, D40ELT, D40ELT-BT-BA, D40i, D40i-BT-BA, D45, D80, D80F, D85, EN, ET, ET020, ETA, ETE20, ETE21, ETE25, ETE27, ETS15, LP130, LP60, LP60H, LP61, LP61H, LP70, SQ885...(Other models you can see in the webshop)		

IMIT / TEMPOMATIC / ARATHERMO

control thermostats



Part No.	390173	Ref. No.	00003170 00057150
description	thermostat t.max. 87°C temperature range 27-87°C 1-pole 1CO 15A probe ø 6.5mm probe L 95mm capillary pipe 1000mm capillary pipe isolated 1000mm gland nut shaft ø 6x4.6mm shaft L 19mm rotation 270° with disc disc ø 14.5mm		
For models:	120, 160, 240, 42, 42E, 48, 48E, 55, 55E, 60, 882, 885, 904, 906, 908, 912, C33, C44, C66, D120, EN, ET, ET020, ETA, LP130, LP60, LP70, LPE100, LPE145, SQ885, SQT80		

accessories for



Part No.	110100	Ref. No.	—
-----------------	--------	-----------------	---

knob thermostat t.max. 90°C 0-90°C ø 42mm shaft ø 6x4.6mm shaft flat -135° black



Part No.	110310	Ref. No.	—
-----------------	--------	-----------------	---

rosette knob up to ø 45mm

accessories

fitting parts

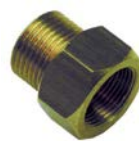

Part No.	511627	Ref. No.	00003400
description	screw connection for boiler IT M16x1 ET 3/8"		
For models:	120, 160, 240, 42, 42E, 48, 48E, 55, 55E, 60, 882, 885, 904, 906, 908, 912, D30, LPE100, LPE145, SQ885, SQT80		

switches and momentary switches

push/momentary push switches

17x13mm



Part No.	345950	Ref. No.	28160041
description	momentary push switch mounting measurements 17x13mm grey 2CO 250V 16A connection male faston 6.3mm ambient temperature max. 150/75°C protection IP40		
For models:	BD14, C33		

20.6x16.4mm



Part No.	345948	Ref. No.	28160038 28160039
description	momentary push switch mounting measurements 20.6x16.4mm grey 2CO 250V 16A outflow connection male faston 6.3mm ambient temperature max. 150°C protection IP40		
For models:	BD14, C33		



Part No.	345949	Ref. No.	28160040
description	push switch mounting ø 20.6x16.4mm grey 2CO 250V 16A connection male faston 6.3mm ambient temperature max. 150°C protection IP40		
For models:	BD14, C33		



28.5x28.5mm



1

Part No.	345940	Ref. No.	28160020
description	momentary push switch mounting measurements 28.5x28.5mm grey 2CO 240V 16A connection male faston 6.3mm ambient temperature max. 150°C protection IP40		
For models:	120, 160, 240, 42, 42E, 48, 48E, 55, 55E, 60, 882, 885, 904, 906, 908, 912, C44, C66, C77, LP130, LP60, LP60H, LP61, LP61H, LP70		



2

Part No.	345942	Ref. No.	28160024 28160273
description	push switch mounting measurements 28.5x28.5mm grey 2CO 250V 16A connection male faston 6.3mm ambient temperature max. 150°C protection IP40		
For models:	C44, C66, C77, LP130, LP60, LP60H, LP61, LP61H, LP70		



1

Part No.	345941	Ref. No.	28160022
description	momentary push switch mounting measurements 28.5x28.5mm grey 2CO 250V 16A drain pump connection male faston 6.3mm ambient temperature max. 150°C protection IP40		
For models:	120, 160, 240, 42, 42E, 48, 48E, 55, 55E, 882, 885, 904, 906, 908, 912		



1

Part No.	347990	Ref. No.	28160045
description	momentary push switch mounting measurements 28.5x28.5mm grey 2CO 250V 16A regeneration connection male faston 6.3mm		
For models:	D35, D40i		

28.5x77.5mm



1

Part No.	345944	Ref. No.	28160028 28160034
description	switch combination latching mounting measurements 28.5x77.5mm grey 2CO 250V 16A main switch connection male faston 6.3mm ambient temperature max. 85°C protection IP40		
For models:	B11, B15, BD11, BD13, D30		



1

Part No.	345954	Ref. No.	28160274
description	switch combination latching mounting measurements 28.5x77.5mm grey 2CO/2CO/2CO 250V 16A connection male faston 6.3mm ambient temperature max. 85°C protection IP40		
For models:	C44, C66, C77		



1

Part No.	345945	Ref. No.	28160029 28160033
description	switch combination latching mounting measurements 28.5x77.5mm grey 2CO/2CO/2CO 250V 16A main switch/program/drain pump connection male faston 6.3mm ambient temperature max. 85°C protection IP40		
For models:	CE24, D35, D40, D40i, D40i-BT-BA		



1

Part No.	345180	Ref. No.	28160021 28160023
description	switch combination mounting measurements 28.5x77.5mm grey 1CO/1CO/1CO 250V 16A connection male faston 6.3mm ambient temperature max. 85°C protection IP40		
For models:	120, 160, 240, 882, 885, 904, 906, 908, 912, C44, C66, LP130, LP60, LP60H, LP61, LP61H, LP70, SQ885, SQT80		



1

Part No.	345946	Ref. No.	28160036
description	switch combination mounting measurements 28.5x77.5mm grey 2CO/2CO/2CO 250V 16A double arrow/arrow/main switch connection male faston 6.3mm ambient temperature max. 85°C protection IP40		
For models:	D120, D40ELT, D80, D80F		

miscellaneous



1

Part No.	345951	Ref. No.	28160043
description	momentary push switch grey 2CO 250V 16A without frame drain connection male faston 6.3mm ambient temperature max. 85°C		
For models:	B11, BD11, BD13, BD22, BD50, BE35, BE40, BE50, BE50T		





			
1			
Part No.	345952	Ref. No.	28160044
description	momentary push switch grey 2CO 250V 16A without frame rinsing connection male faston 6.3mm ambient temperature max. 85°C		
For models:	B11, BD11, BD13, BD50, BE35, BE40		

			
1			
Part No.	511081	Ref. No.	00011100
description	actuator microswitch		
For models:	42, 42E, 48, 48E, 55, 60		

microswitches

lever actuated

			
1			
Part No.	345183	Ref. No.	25190005
description	microswitch with double lever 250V 16A 2CO connection male faston 6.3mm L 50mm ambient temperature max. 125°C mounting distance 22.5mm type N16 actuating force: 290g lever length 47mm		
For models:	42, 42E, 48, 48E, 55, 60, C33, C44, C66, C77, CW650-15, CW650-16, CW650-35, CW650-36		

			
1			
Part No.	511111	Ref. No.	00006410
description	actuator microswitch kit		

			
1			
Part No.	511119	Ref. No.	00011090
description	actuator microswitch kit		
For models:	120, 160, 240, SQ885, SQT80		

			
1			
Part No.	345178	Ref. No.	25190003
description	microswitch with lever 250V 16A 1CO connection male faston 6.3mm L 28mm L1 37mm ambient temperature max. 125°C mounting distance 22mm actuating force: 220g lever length 33mm		
For models:	120, 160, 240, 885, 904, 906, 908, 912, C44, C66, C77, D40i, D40i-BT-BA, D40i-ELT-BT-BA, EB12, EB12+12, EB6, EB6+6, EB8, EM12, EM12+12, EM20, EM20+20, ES12, ES20, ESD12, ESD20, FE12, FE20, FE20+20, FE30, FE30+30, KES20, KESD20, ST12, ST12+12, ST7, ST7+7		

			
1			
Part No.	511112	Ref. No.	00006401 640H
description	lever for microswitch		
For models:	E500, MR600		

position switches

LOVATO

			
1			
Part No.	347579	Ref. No.	25190004
description	position switch plastic 1NO/1NC 400V 3A L 110mm W 30mm H 44mm protection IP66/67 actuating force: 380g screw connection M16 mounting distance 22mm type ZCP21		
For models:	ET, ETE20, ETE21, ETE25, ETE27, ETS15		

			
1			
Part No.	345255	Ref. No.	25190007
description	microswitch with lever 250V 16A 1CO connection male faston 6.3mm L 35mm L1 28mm ambient temperature max. 125°C mounting distance 22mm actuating force: 136g lever length 27mm		
For models:	B11, BD11, BD13, BD14, BD14alt, BD22, C34, C34dgt, C44, C44dgt, C44dgt-elt, C66, C66dgt, C66dgt-elt, C77, CE24, D30, D40, D40ELT, D40ELT-BT-BA, D80, D80F, EN, ST4, ST6		

TELEMECANIQUE (EFA)

			
1			
Part No.	347579	Ref. No.	25190004
description	position switch plastic 1NO/1NC 400V 3A L 110mm W 30mm H 44mm protection IP66/67 actuating force: 380g screw connection M16 mounting distance 22mm type ZCP21		
For models:	ET, ETE20, ETE21, ETE25, ETE27, ETS15		

accessories

			
1			
Part No.	511892	Ref. No.	00011115
description	actuator for microswitch kit		
For models:	885, 904, 906, 908, 912		





			
1			
Part No.	347903	Ref. No.	00073790 25190002
description	position switch plastic 1NO/1NC 400V 3A L 110mm W 30mm H 44mm protection IP66/67 actuating force: 380g screw connection M16 mounting distance 22mm type ZCP21		
For models:	D40i, D40i-ELT-BT-BA, EN, ET, ET020, ETA, LP100, LP145, LPE100, LPE145		

system switches (ROLD)

			
1			
Part No.	346233	Ref. No.	28160205 28160210 28160218 28160219
description	blank ø 23.3mm grey		
For models:	BD50, BE35, BE40, BE50, BE50T		

			
1			
Part No.	347193	Ref. No.	28160250
description	momentary switch unit 1NO 250V 16A connection male faston 6.3mm		
For models:	BD14alt, BD50, BE35, BE40, BE50		

			
1			
Part No.	346256	Ref. No.	28160214
description	push button ø 23mm grey clock no lens		
For models:	BD50, BE35, BE40, BE50, CE24		

			
1			
Part No.	346255	Ref. No.	28160202
description	push button ø 23mm grey drain pump		
For models:	BE35, BE40, BE50		

			
1			
Part No.	346253	Ref. No.	28160213
description	push button ø 23mm grey main switch		
For models:	BD50, BE35, BE40, BE50, CE24		

rotary switches

TECNOMATIC

			
1			
Part No.	345016	Ref. No.	0000597A 25100001
description	rotary switch 2 0-1 sets of contacts 1 type HD1201R000 600V 12A shaft ø 5x5mm shaft L 23mm shaft square connection screw		
For models:	EB12, EB12+12, EB18P, EB6, EB6+6, EB8, EM12, EM12+12, EM20, EM20+20, EM20+20-900, EM20-900, EM35, EM40-900, ES12, ES20, ESD12, ESD20, FE12, FE20, FE20+20, FE30, FE30+30, KES20, KESD20, ST12, ST12+12, ST7, ST7+7		

			
1			
Part No.	347055	Ref. No.	25100102
description	rotary switch 2 0-1 sets of contacts 2 type HD1602R000 600V 16A shaft ø 5x5mm shaft L 23mm shaft square connection screw		
For models:	120, 160, 240, 42, 42E, 48, 48E, 55, 55E, 60, 882, 885, 904, 906, 908, 912, C44, C66, CW650-15, CW650-16, CW650-35, CW650-36, SQ885, SQT80		



magnetic switches

65x20mm

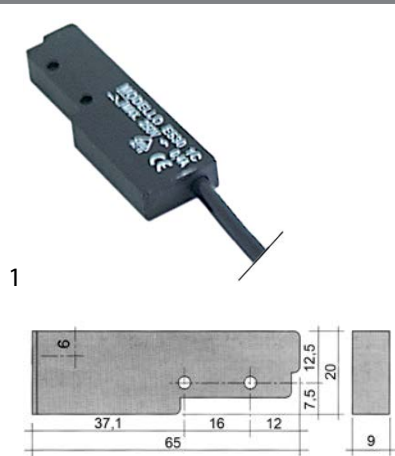

Part No.	345116	Ref. No.	25240003
description	magnetic switch L 65mm W 20mm 1NO 250V 0.4A P max. 100W connection cable cable length 3000mm		
For models:	EN, ET, ET020, ETA, ETE20, ETE21, ETE25, ETE27, LP130, LP70, LPE100, LPE145		
accessories for	345116		
	Part No.	345399	Ref. No. —
	magnet ø 3.3mm L 40mm H 8mm W 13mm hole distance 30mm M3		

accessories

magnets

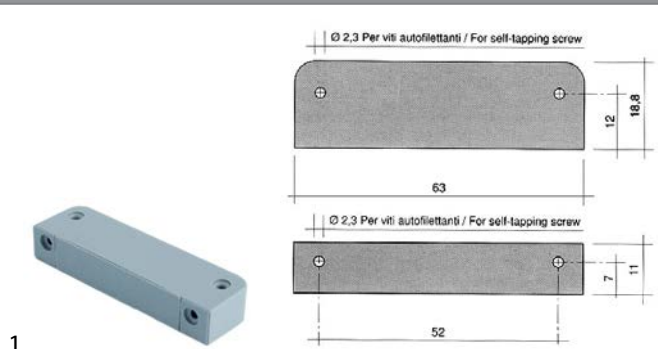

Part No.	519049	Ref. No.	25110115
description	magnet ømm L 63mm H 10.7mm W 18.8mm hole distance 52mm M2 hole ø 2mm		
For models:	ETE20, ETE21, ETE25, ETE27, ETS15		
accessories for	519049		
	Part No.	560095	Ref. No. —
	sheet metal screws ø 2.9mm L 9.5mm SS Qty 20 pcs DIN 7981/ISO 7049 head ø 5.6mm oval head		

miscellaneous



			
1			
Part No.	347904	Ref. No.	00065606
description	holding plate L 62mm W 26mm for magnetic switch		
For models:	LP60, LP60H, LP61, LP61H		

control equipment

TELEMECANIQUE (EFA)

ZB4 series

switches (complete)

			
1			
Part No.	346925	Ref. No.	00061070
description	rotary selector mounting measurements ø22mm latching white illuminated rotation 90° sequence 0-1		
For models:	EN, ET, ET020, ETA, ETE20, ETE21, ETE25, ETE27, ETS15, LPE100, LPE145		
spare parts for	346925		
	Part No.	347385	Ref. No. —
	contact block EFA ZBE-101 1NO max 230V 10(6)A black		

			
1			
Part No.	347905	Ref. No.	00061060
description	rotary selector mounting measurements ø22mm latching white illuminated sequence 0-1		
For models:	ETS15, LP130, LP60, LP60H, LP61, LP61H, LP70		

lamps

indicator lights

indicator lights (complete)

ø 6mm

			
1			
Part No.	359005	Ref. No.	28100006
description	indicator light ø 6mm 230V yellow cable length 400mm		
For models:	120, 160, 240, 42, 42E, 48, 48E, 55, 55E, 60, 882, 885, 904, 906, 908, 912, C44, C66, CW650-15, CW650-16, CW650-35, CW650-36, SQ885, SQT80		



ø10mm

with plug-in socket



1

Part No.	359140	Ref. No.	28100007
description	indicator light ø 10mm yellow 230V connection male faston 6.3mm Qty 1 pcs		
For models:	120, 160, 240, 42, 42E, 48, 48E, 55, 55E, 60, 882, 885, 904, 906, 908, 912, B11, B15, C44, C66, LP70, SQ885, SQT80		

ø12mm

with screw socket



1

Part No.	359048	Ref. No.	28110100 28110101
description	indicator light ø 12mm 230V yellow connection male faston 6.3mm		
For models:	D35, D40ELT, D40i, D40i-BT-BA		

ø13mm

with plug-in socket



1

Part No.	359119	Ref. No.	28100004
description	indicator light ø 13mm green 24V connection male faston 6.3mm Qty 1 pcs		

33x10mm



1

Part No.	359452	Ref. No.	00003320 28110001 28110001 + 00038828
description	indicator light mounting measurements 33.1x10.3mm 400V green connection male faston 6.3mm		
For models:	120, 160, 240, 882, 885, EB12, EB12+12, EB18P, EB6, EB6+6, EB8, EM12, EM12+12, EM20, EM20+20, EM20+20-900, EM20-900, EM35, EM40-900, ES12, ES20, ESD12, ESD20, FE12, FE20, FE20+20, FE30, FE30+30, KES20, KESD20, SQ885, SQT80		

timers

programme timers



1

Part No.	360654	Ref. No.	26100024
description	timer CDC 11804F1 engines 1 chambers 4 operation time 120s 230V shaft ømm shaft Lmm		
For models:	B11, BD11, BD13, BD14, BD14alt, BD22, BE35, BE40		



1

Part No.	360653	Ref. No.	26100023
description	timer CDC 11804F1 engines 1 chambers 4 operation time 180s 230V shaft ømm shaft Lmm		
For models:	BD50, BE50, BE50T, D30		



1

Part No.	360671	Ref. No.	26100021
description	timer CDC 4905DV engines 2 chambers 5 operation time 72s / 4.8min 230V shaft ømm shaft Lmm		
For models:	C33, C44, C66, C77, D120, D40, D80, D80F		



1

Part No.	360069	Ref. No.	26100017
description	timer CROUZET engines 1 chambers 4 operation time 120s 230V shaft ømm shaft Lmm manuf. no. 645/5245 motor type 82340		
For models:	42, 42E, 48, 48E, 55, 55E, B11, B15		







1

Part No.	360068	Ref. No.	26100019
description	timer CROUZET engines 1 chambers 5 operation time 90s 230V shaft ømm shaft Lmm manuf. no. 645/5238 motor type 82340		
For models:	120, 160, 240, 882, 885, 904, 906, 908, 912, SQ885, SQT80		



1

Part No.	360304	Ref. No.	26100022
description	timer FIBER P25 engines 2 chambers 4 operation time 2min / 7.5min 230V shaft ømm shaft Lmm manuf. no. P255J04LXP8 motor type M51BJOR6400 / M51BJ0L6400		
For models:	LP130, LP60, LP60H, LP61, LP61H, LP70		
spare parts for	360304		
	Part No.	360673	Ref. No. —
	motor kit pinion ø 6.8mm teeth 15 230V voltage AC 50/60Hz turn direction clockwise motor ø 48mm H 18.5mm motor type UDS-40NE1RNZ165 cable length 150mm with holder		
	Part No.	360674	Ref. No. —
	motor kit pinion ø 6.8mm teeth 15 230V voltage AC 50/60Hz turn direction counterclockwise motor ø 48mm H 18.5mm motor type UDS40NE1RNZ165 cable length 150mm with holder		



1

Part No.	360087	Ref. No.	26100011
description	timer FIBER P26 engines 1 chambers 3 operation time 20min 230V shaft ømm shaft Lmm manuf. no. P265J03L130 motor type M61B40R6400		



1

Part No.	360305	Ref. No.	26100025
description	timer FIBER PWE engines 1 chambers 1 operation time 20min 230V shaft ømm shaft Lmm manuf. no. PWE5J01L103 motor type M51B-JOR6400		
For models:	B11, BD11, BD13, BD14, BD14alt, BD22, BD50, BE35, BE40, BE50, BE50T		
spare parts for	360305		
	Part No.	360673	Ref. No. —
	motor kit pinion ø 6.8mm teeth 15 230V voltage AC 50/60Hz turn direction clockwise motor ø 48mm H 18.5mm motor type UDS-40NE1RNZ165 cable length 150mm with holder		

contactors

GENERAL ELECTRIC (AEG)

power contactors



1

Part No.	380245	Ref. No.	25130028
description	power contactor resistive load 25A 230VAC (AC3/400V) 9A/4kW main contacts 3NO auxiliary contacts 1NC connection screw connection type AEG LS4K 01A type GE CL00A 301 H 85mm		
For models:	EB12, EB12+12, EB18P, EB6, EB6+6, EB8, EM12, EM12+12, EM20, EM20+20, EM20+20-900, EM20-900, EM35, EM40-900, SQ885, SQT80		



1

Part No.	380262	Ref. No.	25130026
description	power contactor resistive load 32A 230VAC (AC3/400V) 17A/7.5kW main contacts 3NO auxiliary contacts 1NC connection screw connection type AEG LS7K01A type GE CL02A 301 H 85mm		
For models:	EM12, EM12+12, EM20, EM20+20, EM20+20-900, EM20-900, EM35, EM40-900, SQ885, SQT80		



1

Part No.	380261	Ref. No.	25130025
description	power contactor resistive load 32A 230VAC (AC3/400V) 17A/7.5kW main contacts 3NO auxiliary contacts 1NO connection screw connection type AEG LS7K 10A type GE CL02A 310		
For models:	EM12, EM12+12, EM20, EM20+20, EM20+20-900, EM20-900, EM35, EM40-900		

LOVATO

power contactors



1

Part No.	380083	Ref. No.	25130037
description	power contactor resistive load 25A 230VAC (AC3/400V) 9A/4.2kW main contacts 3NO auxiliary contacts 1NC connection screw connection type BF0901A230		
For models:	BE50T, C44dgt, C44dgt-elt, C66dgt, C66dgt-elt, CE24, D36, D45, ES12, ESD12, ST12, ST12+12, ST7, ST7+7		



1

Part No.	380717	Ref. No.	25130038
description	power contactor resistive load 32A 230VAC (AC3/400V) 18A/7.5kW main contacts 3NO auxiliary contacts 1NC connection screw connection type BF1801A230		
For models:	D36, D45, ES12, ES20, ESD12, ESD20, ST12, ST12+12		

TELEMECANIQUE (Schneider Electric)

power contactors



1

Part No.	380820	Ref. No.	00000628 00006280
description	power contactor resistive load 25A 230VAC (AC3/400V) 9A/4kW main contacts 3NO auxiliary contacts 1NO/1NC connection screw connection type LC1D0900M7		
For models:	120, 160, 240, 882, 885, C33, C34, C34dgt, C44, C44dgt, C44dgt-elt, C66, C66dgt, C66dgt-elt, C77, CW650-15, CW650-16, CW650-35, CW650-36, D120, D120dgt, D30, D35, D36, D40, D40ELT, D40i, D40i-BT-BA, D40i-ELT-BT-BA, D45, D80, D80F, D85, EB12, EB12+12, EB8, EG140S, EM12, EM12+12, EM20, EM20+20, ES12, ES20, ESD12, ESD20, ETS15, FE12, FE20, FE20+20, FE30...(Other models you can see in the webshop)		



1

Part No.	380617	Ref. No.	00060670
description	power contactor resistive load 25A 24VAC (AC3/400V) 9A/4kW main contacts 3NO auxiliary contacts 1NO/1NC connection screw connection type LC1D09B7		
For models:	Cybergel, EN, ET, ET020, ETA, ETE20, ETE21, ETE25, ETE27, ETS15		



1

Part No.	380976	Ref. No.	00000627 00006270
description	power contactor resistive load 32A 230VAC (AC3/400V) 18A/7.5kW main contacts 3NO auxiliary contacts 1NO/1NC connection screw connection		
For models:	C44dgt, C44dgt-elt, C66dgt, C66dgt-elt, D120dgt, D36, D45, D85, EB12, EB12+12, EM12, EM12+12, EM20, EM20+20, ES12, ES20, ESD12, ESD20, ETS15, FE20, FE20+20, FE30, FE30+30, KES20, KESD20, LP130, LP60, LP60H, LP61, LP61H, LP70		



relays

power relays

with bracket mounting



Part No.	380626	Ref. No.	25130101 25130102
description	power relays FINDER 230VAC 10A 2CO connection male faston 4.8mm bracket mounting manuf. no. 62.62.8.230.0000		
For models:	C44, C66, C77, D120, D80, D80F, LP130, LP60, LP60H, LP61, LP61H, LP70		

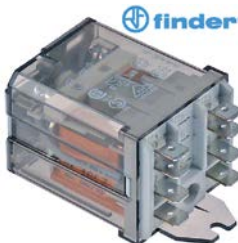

Part No.	380139	Ref. No.	25130100
description	power relays FINDER 230VAC 16A 2CO connection F6.3 bracket mounting dimensions 68x38.2x35.8mm manuf. no. 62.82.8.230.0000		
For models:	42, 42E, 48, 48E, 55, 55E, 882, 885, B11, B15, BD46, BD50, BE35, BE40, BE50, BE50T, C34, C34dgt, C44dgt, C44dgt-elt, C66dgt, C66dgt-elt, CE24, D120dgt, D30, D36, D45, D85, LP70		

transformers

encapsulated transformers

PMA



Part No.	379054	Ref. No.	22192006
description	transformer primary 230VAC secondary 12VAC 3VA secondary 0.25A H 40mm L 45mm W 50mm connection screw 50/60Hz type 153/M		
For models:	ETS15, LP130, LP60, LP60H, LP61, LP61H, LP70		

electronic controllers

SHANGFANG

accessories



Part No.	379054	Ref. No.	22192006
description	transformer primary 230VAC secondary 12VAC 3VA secondary 0.25A H 40mm L 45mm W 50mm connection screw 50/60Hz type 153/M		
For models:	ETS15, LP130, LP60, LP60H, LP61, LP61H, LP70		

probes

universal probes

temperature probes



Part No.	379142	Ref. No.	22192003
description	temperature probe PTC 1kOhm cable PVC probe -50 up to +150°C cable -10 up to 100°C probe ø6x30mm cable length 1.5m without screw connection 2-wire		
For models:	ETE20, ETE21, ETE25, ETE27, ETS15, LP130, LP60, LP60H, LP61, LP61H, LP70		

producer-specific probes

probes



Part No.	378361	Ref. No.	00590021
description	temperature probe GCPTP-51F cable PTFE probe°C cable -40 up to +250°C connection male faston 6.3mm thread probe 20mm cable length 24.5m		
For models:	BD47, C44dgt, C44dgt-elt, C66dgt, C66dgt-elt, Cybergel, D120dgt, D36, D45, D85		



Part No.	378343	Ref. No.	25192400
description	temperature probe NTC 10kOhm cable silicone probe -40 up to +110°C cable -50 up to +180°C connection 2-wire thread probe ø7x30mm cable length 1m		
For models:	BD47, C44, C44dgt, C44dgt-elt, C66, C66dgt, C66dgt-elt, C77, D40, D40ELT-BT-BA, D40i-ELT-BT-BA, D45, D85		

electronics

PCBs



Part No.	403775	Ref. No.	25192030
description	control PCB warewashing D35/36/45/46/47 L 170mm W 28mm connection coded plug suitable for ELFRAMO		
For models:	BD46, BD47, C34, C34dgt, C44dgt, C44dgt-elt, C66dgt, C66dgt-elt, D120dgt, D36, D45, D85		



Part No.	403163	Ref. No.	25192040
description	PCB dishwasher C34/C44/C66 230V 50/60A		
For models:	C34, C34dgt, C44dgt, C44dgt-elt, C66dgt, C66dgt-elt, D120dgt, D36, D45, D85		



Part No.	402990	Ref. No.	25192020
description	PCB dishwasher D35/40		
For models:	D35, D40i, D40i-BT-BA		

keypads

control panel



Part No.	403262	Ref. No.	00222433
description	control panel warewashing BE35 W 178mm H 48mm D 58mm suitable for ELFRAMO		
For models:	BD50, BE35, BE40, BE50		

solenoid valves

solenoid valves (water)

ELBI



Part No.	370257	Ref. No.	23120003
description	solenoid valve triple straight 230VAC inlet 3/4" outlet 11.5mm t.max. 90°C ELBI plastic output B 2.5l/min flow regulating valve outlet B orange		
For models:	42, 42E, 48, 48E, 55, 55E, 60, B11, BD11, BD13, BD14, BD14alt, BD22, BD46, BD47, BD50, BE35, BE40, BE50, BE50T, D35, D36, D40, D40ELT, D40ELT-BT-BA, D40i, D40i-BT-BA, D40i-ELT-BT-BA, D45		

TP



Part No.	370021	Ref. No.	00003120 23120001
description	solenoid valve double straight 230VAC inlet 3/4" outlet 11.5mm DN10 TP flow regulating valve inlet white		
For models:	120, 160, 240, 42, 42E, 48, 48E, 55, 55E, 60, 882, 885, 904, 906, 908, 912, BD14, BD14alt, BD22, BD46, BD47, D40, D40ELT, SQ885, SQT80		

spare parts for











Part No.	371013	Ref. No.	—
description	solenoid coil TP 230VAC 50/60Hz		





accessories for















Part No.	371220	Ref. No.	—
description	reducer TP flow rate 3l/min red tolerance ±15%		
Part No.	371221	Ref. No.	—
description	reducer TP flow rate 5.5l/min yellow tolerance ±15%		
Part No.	371222	Ref. No.	—
description	reducer TP flow rate 6l/min grey tolerance ±15%		
Part No.	371223	Ref. No.	—
description	reducer TP flow rate 10l/min white tolerance ±15%		
Part No.	371224	Ref. No.	—
description	reducer TP flow rate 12l/min bronze tolerance ±15%		
Part No.	371225	Ref. No.	—
description	reducer TP flow rate 16l/min light brown tolerance ±15%		
Part No.	371226	Ref. No.	—
description	reducer TP flow rate 20l/min red tolerance ±15%		

Table continues overleaf



accessories for		370021		
Part No.	371230	Ref. No.	—	
	reducer TP flow rate 0.25l/min red tolerance ±25%			
	reducer TP flow rate 0.35l/min violet tolerance ±25%			
	reducer TP flow rate 0.5l/min orange tolerance ±25%			
	reducer TP flow rate 0.8l/min white tolerance ±25%			
	reducer TP flow rate 1l/min light blue tolerance ±25%			
	reducer TP flow rate 1.2l/min brown tolerance ±25%			
	reducer TP flow rate 1.5l/min light brown tolerance ±25%			
	reducer TP flow rate 2.5l/min yellow tolerance ±25%			
	reducer TP flow rate 3.4l/min dark green tolerance ±25%			
	reducer TP flow rate 5l/min black tolerance ±25%			
	reducer TP flow rate 8l/min blue tolerance ±20%			

			
1			
Part No.	370111	Ref. No.	00003090 23120002
description	solenoid valve double straight 24VAC inlet 3/4" outlet 11.5mm DN10 TP		
For models:	SQ885, SQT80		
spare parts for	370111		
	Part No.	371035	Ref. No. —
	solenoid coil 24VAC		
accessories for	370111		
	Part No.	371220	Ref. No. —
	reducer TP flow rate 3l/min red tolerance ±15%		
	Part No.	371221	Ref. No. —
	reducer TP flow rate 5.5l/min yellow tolerance ±15%		
	Part No.	371222	Ref. No. —
	reducer TP flow rate 6l/min grey tolerance ±15%		

accessories for		370111		
Part No.	371223	Ref. No.	—	
	reducer TP flow rate 10l/min white tolerance ±15%			
	reducer TP flow rate 12l/min bronze tolerance ±15%			
	reducer TP flow rate 16l/min light brown tolerance ±15%			
	reducer TP flow rate 20l/min red tolerance ±15%			
	reducer TP flow rate 0.25l/min red tolerance ±25%			
	reducer TP flow rate 0.35l/min violet tolerance ±25%			
	reducer TP flow rate 0.5l/min orange tolerance ±25%			
	reducer TP flow rate 0.8l/min white tolerance ±25%			
	reducer TP flow rate 1l/min light blue tolerance ±25%			
	reducer TP flow rate 1.2l/min brown tolerance ±25%			
	reducer TP flow rate 1.5l/min light brown tolerance ±25%			
	reducer TP flow rate 2.5l/min yellow tolerance ±25%			
	reducer TP flow rate 3.4l/min dark green tolerance ±25%			
	reducer TP flow rate 5l/min black tolerance ±25%			
	reducer TP flow rate 8l/min blue tolerance ±20%			



			
1			
Part No.	370017	Ref. No.	23120021
description	solenoid valve single straight 230VAC inlet 3/4" outlet 11.5mm DN10 TP p max 10bar		
spare parts for	370017		
	Part No.	371013	Ref. No. —
	solenoid coil TP 230VAC 50/60Hz		

Table continues overleaf



accessories for		370017		
	Part No.	371220	Ref. No.	—
reducer TP flow rate 3l/min red tolerance ±15%				
	Part No.	371221	Ref. No.	—
reducer TP flow rate 5.5l/min yellow tolerance ±15%				
	Part No.	371222	Ref. No.	—
reducer TP flow rate 6l/min grey tolerance ±15%				
	Part No.	371223	Ref. No.	—
reducer TP flow rate 10l/min white tolerance ±15%				
	Part No.	371224	Ref. No.	—
reducer TP flow rate 12l/min bronze tolerance ±15%				
	Part No.	371225	Ref. No.	—
reducer TP flow rate 16l/min light brown tolerance ±15%				
	Part No.	371226	Ref. No.	—
reducer TP flow rate 20l/min red tolerance ±15%				
	Part No.	371230	Ref. No.	—
reducer TP flow rate 0.25l/min red tolerance ±25%				
	Part No.	371231	Ref. No.	—
reducer TP flow rate 0.35l/min violet tolerance ±25%				
	Part No.	371232	Ref. No.	—
reducer TP flow rate 0.5l/min orange tolerance ±25%				
	Part No.	371233	Ref. No.	—
reducer TP flow rate 0.8l/min white tolerance ±25%				
	Part No.	371234	Ref. No.	—
reducer TP flow rate 1l/min light blue tolerance ±25%				
	Part No.	371235	Ref. No.	—
reducer TP flow rate 1.2l/min brown tolerance ±25%				
	Part No.	371236	Ref. No.	—
reducer TP flow rate 1.5l/min light brown tolerance ±25%				
	Part No.	371237	Ref. No.	—
reducer TP flow rate 2.5l/min yellow tolerance ±25%				
	Part No.	371238	Ref. No.	—
reducer TP flow rate 3.4l/min dark green tolerance ±25%				
	Part No.	371239	Ref. No.	—
reducer TP flow rate 5l/min black tolerance ±25%				
	Part No.	371240	Ref. No.	—
reducer TP flow rate 8l/min blue tolerance ±20%				



metal

SIRAI

2-way

L140-B series



Part No.	370239	Ref. No.	23140006	
description	solenoid valve 2-ways 230VAC connection 1/2" L 41mm DN 10mm slide-on receptacle compact -10 up to +90°C SIRAI type series L140-B coil type Z610A membranes NBR (water) p max 12bar p min 0.35bar			
For models:	CW650-15, CW650-16, CW650-35, CW650-36, ETS15, LP130, LP70			
spare parts for	370239			
	Part No.	371085	Ref. No.	—
solenoid coil 230VAC 4VA SIRAI coil type ZB10A seat ø 10mm 50/60Hz				
	Part No.	371163	Ref. No.	—
membrane connection 1/2" series L140-B membrane type NBR (water)				
accessories for	370239			
	Part No.	371091	Ref. No.	—
power socket plug type DIN 43650B cable lengthmm small				

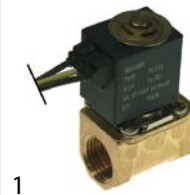

Part No.	370472	Ref. No.	23140004
description	solenoid valve 2-ways 24VAC inlet 1/2" connection 1/2" L 41mm DN 10mm -10 up to +90°C SIRAI coil type Z610A membranes NBR (water) p max 12bar p min 0.35bar 24V voltage AC		
For models:	EN, ET, ET020, ETA, ETE20, ETE21, ETE25, ETE27, ETS15, LPE100, LPE145		

L180-B series







Part No.	370329	Ref. No.	00005692 23140003	
description	solenoid valve 2-ways 24VAC inlet 1/2" outlet 1/2" connection 1/2" L 66mm DN 13.5mm slide-on receptacle compact -10 up to +90°C SIRAI type series L180-B coil type Z610A membranes NBR (water) p max 12bar p min 0.35bar			
For models:	ET, ETA			
spare parts for	370329			
	Part No.	371070	Ref. No.	00005661 23160001
solenoid coil 24VAC 10VA SIRAI coil type Z610A seat ø 10mm				



Table continues overleaf



spare parts for 370329	
	Part No. 371171 Ref. No. — membrane series L180-B membrane type NBR (water)
accessories for 370329	
	Part No. 371091 Ref. No. — power socket plug type DIN 43650B cable lengthmm small

solenoid valves steam (water)	
2-way	
L153-D series	
	1
Part No.	370264 Ref. No. 23150003
description	solenoid valve 2-ways 230VAC inlet 1/2" outlet 1/2" connection 1/2" L 66mm DN 11.5mm slide-on receptacle DIN -10 up to 140°C SIRAI type series L153-D coil type Z134A membranes EPDM (steam/water) p max 8bar p min 0.1bar
For models:	LP130
spare parts for 370264	
	Part No. 371077 Ref. No. — solenoid coil 230VAC 24VA SIRAI coil type Z110A/Z114A/Z134A seat ø 14mm
	Part No. 371167 Ref. No. — membrane connection 1/2" series L153-D membrane type EPDM
accessories for 370264	
	Part No. 371090 Ref. No. — power socket plug type DIN 43650A screw

	1
Part No.	370325 Ref. No. 00005660 23150001
description	solenoid valve 2-ways 24VAC inlet 3/4" outlet 3/4" connection 3/4" L 79mm DN 17mm slide-on receptacle DIN -10 up to 140°C SIRAI type series L153-D coil type Z134A membranes EPDM (steam/water) p max 8bar p min 0.1bar 50Hz
For models:	EN, ET, ET020, ETA, ETE20, ETE21, ETE25, ETE27, LPE100, LPE145

spare parts and accessories	
solenoid coils	
	1
Part No.	371070 Ref. No. 00005661 23160001
description	solenoid coil 24VAC 10VA SIRAI coil type Z610A seat ø 10mm
For models:	ET, ETA, LPE100, LPE145
accessories for 371070	
	Part No. 371091 Ref. No. — power socket plug type DIN 43650B cable lengthmm small

solenoid valves (various)	
	1
Part No.	370738 Ref. No. 00065310
description	solenoid valve 230VAC inlet 3/4" ET outlet 1" ET L 225mm with in-line particle filter SIRAI coil type Z610A 230V brass warewashing voltage AC
For models:	LP130, LP70

pressure switches

for warewashing

ø 58mm with male faston 6.3mm

with connection horizontal

	1
Part No.	541314 Ref. No. 27100002
description	pressure control pressure range 46/26mbar connection 6mm ø 58mm pressure connection horizontal warewashing pressure connection ø 6mm
For models:	B11, B15, BD11, BD13, BD14, BD22, BD46, BD47, BD50, BE35, BE40, BE50, BE50T, C33, D30, D35, D36, D40, D40ELT, D40i, D40i-BT-BA, D45, D80, D80F



			
1			
Part No.	541019	Ref. No.	00005960
description	pressure control pressure range 70/30mbar connection 6mm ø 58mm pressure connection horizontal warewashing pressure connection ø 6mm		

electrodes

			
1			
Part No.	403264	Ref. No.	00013897
description	level electrode total length 125mm angled ø 4mm		
For models:	BD47, C44, C44dgt, C44dgt-elt, C66, C66dgt, C66dgt-elt, C77, D40, D40ELT, D40ELT-BT-BA, D40i-BT-BA, D40i-ELT-BT-BA, D45, D85		

			
1			
Part No.	403263	Ref. No.	00014133
description	level electrode total length 75mm angled ø 4mm		
For models:	BD47, C44, C44dgt, C44dgt-elt, C66, C66dgt, C66dgt-elt, C77, D40, D40ELT, D40ELT-BT-BA, D40i-ELT-BT-BA, D45, D85		

pumps

wash and rinse pumps

FIR

pumps

			
1			
Part No.	500927	Ref. No.	00002501
description	pump inlet ø 53mm outlet ø 44mm type 0213.1600 230V 50/60Hz 1 phase 1kW 1.36HP L 290mm rotation direction right capacitor 12.5µF FIR		
spare parts for	500927		
	Part No.	365014	Ref. No. 00002630
	operating capacitor capacity 12.5µF 450V tolerance 5%Hz ambient temperature max. -25 to +85°C ø 35mm L 70mm M8 plastic connection male faston 6.3mm 45S.C3DS.12.5 protection		

spare parts for	500927		
	Part No.	509010	Ref. No. 00002860
	impellor ø 105mm H 20mm M10L rotation direction right blades 4		
	Part No.	510693	Ref. No. 00000300 00003000 06150001
	mechanical shaft seal for shaft ø 12mm slide ring ext. ø 24mm slide ring H 15.5mm slide ring int. ø 11mm counter ring mounting ø 24mm height counter ring 8mm counter ring int. ø 13.5mm		
	Part No.	521543	Ref. No. 00002700
	pump cover ELFRAMO inlet ø 53mm outlet ø 44mm turn direction right ø 160mm ID ø 136mm inner height 34mm		
	Part No.	521717	Ref. No. 00000290 00002900 06140008 06140140
	O-ring EPDM thickness 1.78mm ID ø 120.37mm Qty 1 pcs		





INSERT STAR

pumps

			
1			
Part No.	499270	Ref. No.	20160040
description	pump inlet ø 38mm outlet ø 38mm type 2/102FA15 220/240V 50/60Hz 1 phase 0.26kW L 200mm rotation direction right INSERT-STAR		
For models:	BE40		
spare parts for	499270		
	Part No.	504578	Ref. No. —
	O-ring EPDM thickness 3.53mm ID ø 94.84mm Qty 1 pcs		
	Part No.	510693	Ref. No. 00000300 00003000 06150001
	mechanical shaft seal for shaft ø 12mm slide ring ext. ø 24mm slide ring H 15.5mm slide ring int. ø 11mm counter ring mounting ø 24mm height counter ring 8mm counter ring int. ø 13.5mm		
	Part No.	650239	Ref. No. —
	impellor ø 75mm H 27mm pump type 2/102FA15 shaft intake ø 8mm rotation direction right thread M8L suitable for INSERTSTAR blades 6		
accessories for	499270		
	Part No.	365093	Ref. No. —
	operating capacitor capacity 6µF 400V tolerance 5% 50/60Hz ambient temperature max. -25 to +85°C ø 31.5mm L 55mm M8 plastic connection male faston 6.3mm protection		







1

Part No.	500320	Ref. No.	20160042
description	pump inlet ø 38mm outlet ø 38mm type 2/123/FA30 230V 50Hz 1 phase 0.59kW 0.8HP L 235mm rotation direction right capacitor 10µF INSERTSTAR		
For models:	BD50, BE50, BE50T		
spare parts for	500320		
	Part No.	510693	Ref. No. 00000300 00003000 06150001
	mechanical shaft seal for shaft ø 12mm slide ring ext. ø 24mm slide ring H 15.5mm slide ring int. ø 11mm counter ring mounting ø 24mm height counter ring 8mm counter ring int. ø 13.5mm		
	Part No.	521000	Ref. No. —
	pump cover FAGOR inlet ø 38mm outlet ø 38mm		
	Part No.	521255	Ref. No. —
	impellor ø 88mm H 33mm M8L pump type 2/123/FA30 shaft ø 12mm		
	Part No.	532491	Ref. No. —
	O-ring EPDM thickness 3.53mm ID ø 120.2mm Qty 1 pcs		
accessories for	500320		
	Part No.	365015	Ref. No. 24100009
	operating capacitor capacity 10µF 400V tolerance 5%Hz ambient temperature max. -25 to +85°C ø 35.5mm L 59mm M8 plastic connection male faston 6.3mm protection		
	Part No.	551227	Ref. No. —
	female faston size 6.3x0.8mm 1.0-2.5mm ² straight CuZn gal Sn t.max. 110°C Qty 10 pcs		

LGB

1

Part No.	499204	Ref. No.	20160048
description	pump inlet ø 28mm outlet ø 26mm type ZF119SX 230V 50Hz 1 phase 0.15kW 0.2HP L 195mm rotation direction right capacitor 5µF auxiliary pressure connection 12mm LGB		
For models:	C34, C34dgt, C44, C44dgt, C44dgt-elt, C66, C66dgt, C66dgt-elt, C77, D120, D120dgt, D80, D85, LP61, LP61H		
spare parts for	499204		
	Part No.	365017	Ref. No. —
	operating capacitor capacity 5µF 450V tolerance 5% 50/60Hz ambient temperature max. -25 to +85°C ø 28mm L 54mm M8 plastic connection male faston 6.3mm 16.10.08 protection		
	Part No.	510703	Ref. No. 06150006
	mechanical shaft seal for shaft ø 13mm slide ring H 13mm height counter ring 5.5mm ED ø 26mm		
	Part No.	521057	Ref. No. 20161002
	pump cover LGB inlet ø 28mm outlet ø 26mm auxiliary pressure connection 12mm supporting pressure open turn direction right ø 102mm ID ø 77mm inner height 31mm		
	Part No.	521114	Ref. No. —
	impellor ø 48mm H 17mm pump type ZF119SX shaft ø 13mm shaft length 12mm		
	Part No.	528800	Ref. No. —
	O-ring EPDM thickness 2.62mm ID ø 75.87mm Qty 1 pcs		



Part No.	501556	Ref. No.	20160027
description	pump inlet \varnothing 28mm outlet \varnothing 26mm type ZF119SX 230V 50Hz 1 phase 0.2kW 0.27HP L 186mm rotation direction right capacitor 5 μ F LGB		
For models:	BE35		
spare parts for	501556		
	Part No.	521057	Ref. No. 20161002
	pump cover LGB inlet \varnothing 28mm outlet \varnothing 26mm auxiliary pressure connection 12mm supporting pressure open turn direction right \varnothing 102mm ID \varnothing 77mm inner height 31mm		



Part No.	500094	Ref. No.	20160025
description	pump inlet \varnothing 28mm outlet \varnothing 26mm type ZF131SX 230V 50Hz 1 phase 0.2kW 0.15HP L 195mm rotation direction left capacitor 6.3 μ F LGB		
For models:	42, 42E, 48, 48E, 55, 55E, B11, BD11		
spare parts for	500094		
	Part No.	365012	Ref. No. 24100001
	operating capacitor capacity 6.3 μ F 450V tolerance 5% 50Hz ambient temperature max. -25 to +85°C \varnothing 30mm L 61mm M8 plastic connection male faston 6.3mm protection		
	Part No.	502266	Ref. No. 20161000
	pump cover inlet \varnothing 28mm outlet \varnothing 26mm		
	Part No.	510703	Ref. No. 06150006
	mechanical shaft seal for shaft \varnothing 13mm slide ring H 13mm height counter ring 5.5mm ED \varnothing 26mm		
	Part No.	521085	Ref. No. —
	impeller \varnothing 72mm H 17mm thread M7L shaft \varnothing 13mm shaft length 12mm blades 3		
	Part No.	528800	Ref. No. —
	O-ring EPDM thickness 2.62mm ID \varnothing 75.87mm Qty 1 pcs		



Part No.	500539	Ref. No.	00202481
description	pump inlet \varnothing 28mm outlet \varnothing 26mm type ZF170SX 230V 50Hz 1 phase 0.32kW 0.44HP L 200mm rotation direction right capacitor 8 μ F LGB		
For models:	B15, BD13, BD14, BD14alt, BD46, BD47		
spare parts for	500539		
	Part No.	509004	Ref. No. 00210036
	impeller \varnothing 71mm H 16mm M7L rotation direction right shaft \varnothing 13mm shaft length 13mm blades 8		
	Part No.	510703	Ref. No. 06150006
	mechanical shaft seal for shaft \varnothing 13mm slide ring H 13mm height counter ring 5.5mm ED \varnothing 26mm		
	Part No.	521057	Ref. No. 20161002
	pump cover LGB inlet \varnothing 28mm outlet \varnothing 26mm auxiliary pressure connection 12mm supporting pressure open turn direction right \varnothing 102mm ID \varnothing 77mm inner height 31mm		
	Part No.	528800	Ref. No. —
	O-ring EPDM thickness 2.62mm ID \varnothing 75.87mm Qty 1 pcs		
accessories for	500539		
	Part No.	365013	Ref. No. —
	operating capacitor capacity 8 μ F 400V tolerance 5%Hz ambient temperature max. -25 to +85°C \varnothing 31.5mm L 55mm M8 plastic connection male faston 6.3mm protection		



Part No.	500092	Ref. No.	00202480
description	pump inlet \varnothing 50mm outlet \varnothing 44mm type W300SX 230V 50Hz 1 phase 0.3kW 0.5HP L 170mm rotation direction right capacitor 10 μ F LGB		
For models:	42, 42E, 48, 48E, 55, 55E, 60, BD22		
spare parts for	500092		
	Part No.	365015	Ref. No. 24100009
	operating capacitor capacity 10 μ F 400V tolerance 5%Hz ambient temperature max. -25 to +85°C \varnothing 35.5mm L 59mm M8 plastic connection male faston 6.3mm protection		

Table continues overleaf



spare parts for 500092				
	Part No.	510554	Ref. No.	—
O-ring EPDM thickness 2mm ID ø 120mm Qty 1 pcs				
	Part No.	510607	Ref. No.	00210029 00210032
impellor ø 85mm H 29mm shaft intake ø 9x8mm rotation direction right blades 6				
	Part No.	510693	Ref. No.	00000300 00003000 06150001
mechanical shaft seal for shaft ø 12mm slide ring ext. ø 24mm slide ring H 15.5mm slide ring int. ø 11mm counter ring mounting ø 24mm height counter ring 8mm counter ring int. ø 13.5mm				
	Part No.	511178	Ref. No.	00202460
pump cover bottom part				
	Part No.	521564	Ref. No.	00210028
pump cover				



1				
Part No.	499225	Ref. No.	00002591 20160053	
description	pump inlet ø 50mm outlet ø 50mm type ZF400VSX 230V 50Hz 1 phase 0.81kW 1.1HP L 245mm rotation direction right capacitor 16µF C 34 dgt / C 44 dgt LGB			
For models:	C34, C44dgt, CE24			
spare parts for 499225				
	Part No.	365021	Ref. No.	24100004
operating capacitor capacity 16µF 425V tolerance 5% 50/60Hz ambient temperature max. -25 to +85°C ø 35mm L 73mm single M8 plastic connection male faston 6.3mm 416.10.99 protection				
	Part No.	510703	Ref. No.	06150006
mechanical shaft seal for shaft ø 13mm slide ring H 13mm height counter ring 5.5mm ED ø 26mm				
	Part No.	520454	Ref. No.	00004072 0000407B 05100008
hose clamp ø 70-90mm width 9mm Qty 5 pcs DIN 3017				
	Part No.	521090	Ref. No.	—
impellor ø 101mm H 32mm thread M8L shaft ø 13mm shaft length 12mm				
	Part No.	521548	Ref. No.	—
pump cover LGB inlet ø 50mm outlet ø 50mm				
	Part No.	532623	Ref. No.	—
O-ring EPDM thickness 2.62mm ID ø 120.32mm Qty 1 pcs				

OLYMPIA

pumps



1

Part No.	499217	Ref. No.	20160063
description	pump inlet ø 50mm outlet ø 40mm type L80.T7_5040 230V 50Hz 1 phase 0.6kW 0.8HP L 205mm rotation direction right capacitor 12.5µF D 85 dgt OLYMPIA		
spare parts for 499217			
	Part No.	365014	Ref. No. 00002630
operating capacitor capacity 12.5µF 450V tolerance 5%Hz ambient temperature max. -25 to +85°C ø 35mm L 70mm M8 plastic connection male faston 6.3mm 45S.C3DS.12.5 protection			
	Part No.	510554	Ref. No. —
O-ring EPDM thickness 2mm ID ø 120mm Qty 1 pcs			
	Part No.	510693	Ref. No. 00000300 00003000 06150001
mechanical shaft seal for shaft ø 12mm slide ring ext. ø 24mm slide ring H 15.5mm slide ring int. ø 11mm counter ring mounting ø 24mm height counter ring 8mm counter ring int. ø 13.5mm			
	Part No.	512415	Ref. No. 20161004
pump cover OLYMPIA inlet ø 50mm outlet ø 40mm			
	Part No.	517368	Ref. No. —
impellor ø 102mm H 21mm rotation direction right thread M10L suitable for Dühr blades 8			

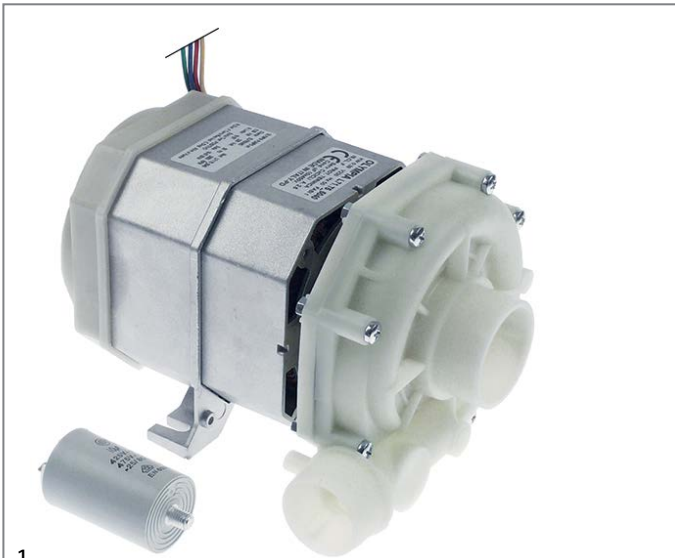





1

Part No.	499314	Ref. No.	20160062
description	pump inlet \varnothing 50mm outlet \varnothing 41mm type L71T5_5040 230V 50Hz 1 phase 0.38kW L 200mm rotation direction right capacitor 10 μ F OLYMPIA		
spare parts for	499314		
	Part No.	365015	Ref. No. 24100009
	operating capacitor capacity 10 μ F 400V tolerance 5%Hz ambient temperature max. -25 to +85°C \varnothing 35.5mm L 59mm M8 plastic connection male faston 6.3mm protection		
	Part No.	510554	Ref. No. —
	O-ring EPDM thickness 2mm ID \varnothing 120mm Qty 1 pcs		
	Part No.	510693	Ref. No. 00000300 00003000 06150001
	mechanical shaft seal for shaft \varnothing 12mm slide ring ext. \varnothing 24mm slide ring H 15.5mm slide ring int. \varnothing 11mm counter ring mounting \varnothing 24mm height counter ring 8mm counter ring int. \varnothing 13.5mm		
	Part No.	512415	Ref. No. 20161004
	pump cover OLYMPIA inlet \varnothing 50mm outlet \varnothing 40mm		
	Part No.	521157	Ref. No. 20161501
	impellor \varnothing 82mm H 22mm thread M10L		



1

Part No.	499338	Ref. No.	20160072
description	pump inlet \varnothing 62mm outlet \varnothing 50mm type MEC71.T120SX 220-240/380-415V 50Hz 3 phase 0.88kW 1.2HP L 310mm rotation direction right OLYMPIA		
spare parts for	499338		
	Part No.	510693	Ref. No. 00000300 00003000 06150001
	mechanical shaft seal for shaft \varnothing 12mm slide ring ext. \varnothing 24mm slide ring H 15.5mm slide ring int. \varnothing 11mm counter ring mounting \varnothing 24mm height counter ring 8mm counter ring int. \varnothing 13.5mm		
	Part No.	521152	Ref. No. 20161100
	pump cover OLYMPIA inlet 62 \varnothing 190mm		
	Part No.	521153	Ref. No. 20161003
	pump casing OLYMPIA outlet \varnothing 52mm		
	Part No.	521154	Ref. No. 06140046
	O-ring ID \varnothing 152.7mm thickness 2.62mm EPDM Qty 1 pcs		



1











Part No.	542117	Ref. No.	20160066
description	pump inlet \varnothing 62mm outlet \varnothing 52mm type L80.T200SX 230V 50Hz 1 phase 1.5kW L 340mm rotation direction right capacitor 17/17 μ F OLYMPIA		
spare parts for	542117		
	Part No.	521152	Ref. No. 20161100
	pump cover OLYMPIA inlet 62 \varnothing 190mm		
	Part No.	521153	Ref. No. 20161003
	pump casing OLYMPIA outlet \varnothing 52mm		

Table continues overleaf





spare parts for 542117				
	Part No.	521154	Ref. No.	06140046
	O-ring ID ø 152.7mm thickness 2.62mm EPDM Qty 1 pcs			
	Part No.	521155	Ref. No.	20161500 20161506
	impellor ø 107mm H 34mm pump type OLYMPIA thread M8L blades 6			
accessories for 542117				
	Part No.	542157	Ref. No.	00018280
	bracket for wash pump L 267mm W 132mm H 43mm			



1				
Part No.	499226	Ref. No.	20160061	
description	pump inlet ø 62mm outlet ø 52mm type MEC80.T200SX 230/400V 50Hz 3 phase 1.5kW 2HP L 340mm rotation direction right OLYMPIA			
For models:	C66dgt			
spare parts for 499226				
	Part No.	510693	Ref. No.	00000300 00003000 06150001
	mechanical shaft seal for shaft ø 12mm slide ring ext. ø 24mm slide ring H 15.5mm slide ring int. ø 11mm counter ring mounting ø 24mm height counter ring 8mm counter ring int. ø 13.5mm			
	Part No.	521152	Ref. No.	20161100
	pump cover OLYMPIA inlet 62 ø 190mm			
	Part No.	521153	Ref. No.	20161003
	pump casing OLYMPIA outlet ø 52mm			
	Part No.	521154	Ref. No.	06140046
	O-ring ID ø 152.7mm thickness 2.62mm EPDM Qty 1 pcs			
	Part No.	521155	Ref. No.	20161500 20161506
	impellor ø 107mm H 34mm pump type OLYMPIA thread M8L blades 6			
accessories for 499226				
	Part No.	542157	Ref. No.	00018280
	bracket for wash pump L 267mm W 132mm H 43mm			



booster pumps I

1				
				
Part No.	500540	Ref. No.	20160001 20160054	
description	pump inlet ø 1" IT outlet ø 1" IT type PKM60 230V 50Hz 1 phase 0.37kW PEDRELLO 0.5HP			
For models:	120, 160, 240, 882, 885, 904, 906, 908, 912, C33, C34, C34dgt, C44, C44dgt, C44dgt-elt, C66, C66dgt, C66dgt-elt, C77, D120, D120dgt, D80, D80F, D85, LP130, LP60, LP60H, LP61, LP61H, LP70, SQ885, SQT80			
accessories for 500540				
	Part No.	365015	Ref. No.	24100009
	operating capacitor capacity 10µF 400V tolerance 5%Hz ambient temperature max. -25 to +85°C ø 35.5mm L 59mm M8 plastic connection male faston 6.3mm protection			

1				
				
Part No.	499308	Ref. No.	20160056	
description	pump inlet ø 1" IT outlet ø 1" IT type PQM60 220V 60Hz 1 phase 0.37kW 0.5HP L 195mm rotation direction left capacitor 10µF PEDRELLO			
For models:	C34, C44dgt, C66dgt			

1				
				
Part No.	499145	Ref. No.	00047030 20160004 20160055	
description	pump inlet ø 1" outlet ø 1" type PQ60 230/400V 50Hz 3 phase 0.37kW PEDRELLO			
For models:	EN, ET, ETA, ETE20, ETE21, ETE25, ETE27, ETS15, LPE100, LPE145			



			
1			
Part No.	500395	Ref. No.	20160011 20160016
description	pump inlet \varnothing 3/8" IT outlet \varnothing 3/8" IT type PS45DX 230V 50Hz 0.35kW capacitor 8 μ F LGB		
For models:	B11, BD11, BD13, BD14, BD14alt, BD22, BD46, BD47, BD50, BE50, D30, D35, D36, D40, D40ELT, D40ELT-BT-BA, D40i, D40i-ELT-BT-BA, D45, D80, LP60, LP60H		
spare parts for	500395		
	Part No.	365013	Ref. No. —
	operating capacitor capacity 8 μ F 400V tolerance 5%Hz ambient temperature max. -25 to +85°C \varnothing 31.5mm L 55mm M8 plastic connection male faston 6.3mm protection		
	Part No.	698400	Ref. No. —
	pump cover gasket pump type PS46 thickness 2mm ID \varnothing 66mm Qty 1 pcs		

drain pumps

miscellaneous

			
1			
Part No.	499001	Ref. No.	20160013
description	drain pump inlet \varnothing 30mm outlet \varnothing 22mm 220V 34W 60Hz PLASET		
For models:	BD13, BD14, BD50, BE35, BE40, BE50, BE50T, D35, D36, D40, D40i, D40i-ELT-BT-BA, D45		

accessories

			
1			
Part No.	511626	Ref. No.	00003490
description	filter suitable for drain pump with locking screw and gasket		

condensators & interference suppression filters

operating capacitors

plastic

			
1			
Part No.	365014	Ref. No.	00002630
description	operating capacitor capacity 12.5 μ F 450V tolerance 5%Hz ambient temperature max. -25 to +85°C \varnothing 35mm L 70mm M8 plastic connection male faston 6.3mm 45S.C3DS.12.5 protection		
For models:	120, 160, 882, 885, C44, C66		

			
1			
Part No.	365021	Ref. No.	24100004
description	operating capacitor capacity 16 μ F 425V tolerance 5% 50/60Hz ambient temperature max. -25 to +85°C \varnothing 35mm L 73mm single M8 plastic connection male faston 6.3mm 416.10.99 protection		
For models:	42, 42E, 48, 48E, 55, 55E, 60, BD22, C33, C34, C34dgt, C44, C44dgt, C44dgt-elt, C66, C77, CW650-15, CW650-16, CW650-35, CW650-36, D30, D35, D36, D40, D40ELT, D40ELT-BT-BA, D40i, D40i-BT-BA, D40i-ELT-BT-BA, D45, D80, D80F, D85		

filters

interference suppression filters

			
1			
Part No.	365026	Ref. No.	00002650 24100100
description	interference suppression filter capacity 0.47 μ F(X2)+2x0.01 μ F(Y2) 0.68MOhm		

			
1			
Part No.	365089	Ref. No.	24100102
description	interference suppression filter type X1+100R 250V capacity 0.24 μ F		
For models:	120, 885, 906, 908, C33, C34, C34dgt, C44, C44dgt, C44dgt-elt, C66, C66dgt, C66dgt-elt, C77, D35, D36, D40, D40i, D40i-ELT-BT-BA, D45, D80, D85, EM20, EM20+20, ES20, ESD20		





fuses

fine fuses

			
1			
Part No.	358041	Ref. No.	00060970
description	fine fuse size $\varnothing 10 \times 38 \text{mm}$ 20A slow-acting rated 400V type aM Qty 1 pcs		
For models:	EN, ET, ET020, ETA, LPE100, LPE145		

			
1			
Part No.	358030	Ref. No.	00060980
description	fine fuse size $\varnothing 10 \times 38 \text{mm}$ 32A slow-acting rated 400V type aM Qty 1 pcs		
For models:	EN, ET, ET020, ETA, LPE100, LPE145		

			
1			
Part No.	358038	Ref. No.	00060960 37130999
description	fine fuse size $\varnothing 10 \times 38 \text{mm}$ 10A slow-acting rated 500V type aM Qty 1 pcs		
For models:	120, 160, 240, 882, 885, 904, 906, 908, 912, CW650-15, CW650-16, CW650-35, CW650-36, Cybergel, EB12, EB12+12, EG140S, EM240, EM360, EM480, EM612, EM-HT, EN, ES12, ESD12, ET, ET020, ETA, ETE20, ETE21, ETE25, ETE27, ETS15, LPE100, LPE145, SQ885, SQT80		

			
1			
Part No.	358040	Ref. No.	00006261
description	fine fuse size $\varnothing 10 \times 38 \text{mm}$ 16A slow-acting rated 500V type aM Qty 1 pcs		

fine fuse holders

			
1			
Part No.	358075	Ref. No.	00006121 37170001
description	fuse holder for for fuse $\varnothing 10 \times 38 \text{mm}$ suitable fuse $\varnothing 10 \times 38 \text{mm}$ 1-pole 32A rated 690V for DIN rail 35mm cross section 10mm ² suitable for for fuse $\varnothing 10 \times 38 \text{mm}$		
For models:	120, 160, 240, 882, 885, 904, 906, 908, 912, Cybergel, EM240, EM360, EM480, EM612, EM-HT, EN, ET, ET020, ETA, ETE20, ETE21, ETE25, ETE27, ETS15, LPE100, LPE145, SQ885, SQT80		

electric accessories

cables

ribbon cables

group 1

			
1			
Part No.	403776	Ref. No.	25190105
description	ribbon cable 10-pole L 2600mm plug type FC-10P raster size 2.54mm		
For models:	BD46, BD47, C34, C34dgt, C44dgt, C44dgt-elt, C66dgt, C66dgt-elt, D120dgt, D36, D45, D85		

terminals

rail-mounted terminals

miscellaneous

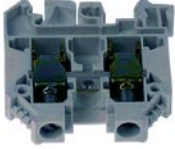
			
1			
Part No.	358505	Ref. No.	00006260
description	rail-mounted terminal 6-10mm ² 1-pole		

for dishwashers

drain and intake components

ELFRAMO

drain /intake bodies

			
1			
Part No.	517804	Ref. No.	00014169 00018351
description	connection angle thread 1/2" hose $\varnothing 13 \text{mm}$		
For models:	BD50, BE35, BE40, BE50, BE50T, C34, C44, C44dgt, C66, C66dgt, C77, D120, D35, D36, D40i, D40i-BT-BA, D40i-ELT-BT-BA, D45, D85		

			
1			
Part No.	511843	Ref. No.	00012701
description	drain connection		
For models:	BD14, BD14alt, BD47, C33, C34, C34dgt, C44, C44dgt, C44dgt-elt, C66, C66dgt, C66dgt-elt, C77, CE24, CW650-15, CW650-16, CW650-35, CW650-36, D120, D120dgt, D30, D40, D80, D80F, D85, ETE20, ETE21, ETE25, ETE27, LP60, LP60H, LP61, LP61H		



1

Part No.	511830	Ref. No.	00211035
description	drain connection thread 1 3/4" hose ø 28.5mm		
For models:	B11, B15, BD11, BD13, BD14, BD22, BD47, BD50, BE35, BE40, BE50, BE50T, C44, C66, C77, D30, D35, D36, D40, D40ELT, D40ELT-BT-BA, D40i, D40i-BT-BA, D40i-ELT-BT-BA, D45		



1

Part No.	511838 ¹	Ref. No.	00211026
description	drain connection thread 1 3/4" hose ø 28mm		
For models:	B11, BD11, BD13, BD14, BD46, BD50, BE35, BE40, BE50, C34, C34dgt, C44dgt, C44dgt-elt, C66dgt, C66dgt-elt, D85, LP61, LP61H		

¹for drain pump

1

Part No.	511853	Ref. No.	00012702
description	drain fitting		
For models:	BD22, C33, C44, C66, CW650-15, CW650-16, CW650-35, CW650-36, D120, D120dgt, D30, D35, D36, D40, D40ELT, D40ELT-BT-BA, D40i, D40i-BT-BA, D40i-ELT-BT-BA, D45, D80, D80F, D85, ETE20, ETE21, ETE25, ETE27		



1

Part No.	511070	Ref. No.	00002130
description	drain fitting complete		
For models:	ET, ET020, ETA, ETE20, ETE21, ETE25, ETE27		





1

Part No.	511836	Ref. No.	00012715
description	drain fitting complete thread 1 3/4" ED ø 65mm ID ø 43mm hose ø 37mm		
For models:	C44, C66, D30, D80, LP60		



1

Part No.	512409	Ref. No.	00012703+00211035+06140018 00012741
description	drain fitting complete thread 1 3/4" ED ø 70.5mm ID ø 52mm hose ø 28.5mm		
spare parts for	512409		
	Part No.	511826	Ref. No. 00012703
	mounting ring thread 1 3/4" ID ø 44mm		
	Part No.	511828	Ref. No. 06140018
	O-ring EPDM thickness 3.53mm ID ø 56.74mm Qty 1 pcs		
	Part No.	511830	Ref. No. 00211035
	drain connection thread 1 3/4" hose ø 28.5mm		



1

Part No.	511827	Ref. No.	00012704
description	flange ED ø 115mm ID ø 55mm		
For models:	B11, B15, BD11, BD13, BD14, BD46, BD47, BE35, BE40		



1

Part No.	511092	Ref. No.	00002110
description	intake body ED ø 125mm H 100mm ID ø 62mm hose ø 70mm		



1

Part No.	511837	Ref. No.	00012712
description	mounting ring thread 1 3/4" ED ø 65mm		
For models:	B11, BD11, BD13, BD14, BD46		



1

Part No.	511826	Ref. No.	00012703
description	mounting ring thread 1 3/4" ID ø 44mm		
For models:	B11, B15, BD11, BD13, BD14, BD14alt, BD22, BD46, BD47, BD50, BE35, BE40, BE50, BE50T, C33, C34, C34dgt, C44, C44dgt, C44dgt-elt, C66, C66dgt, C66dgt-elt, C77, CE24, CW650-15, CW650-16, CW650-35, CW650-36, D120, D120dgt, D30, D35, D36, D40, D40ELT, D40ELT-BT-BA, D40i, D40i-BT-BA, D40i-ELT-BT-BA, D45, D80, D80F, D85, ETE20, ETE21, ETE25, ETE27, LP60, LP60H...(Other models you can see in the webshop)		



			
1			
Part No.	511828	Ref. No.	06140018
description	O-ring EPDM thickness 3.53mm ID ø 56.74mm Qty 1 pcs		
For models:	B11, B15, BD11, BD13, BD14, BD14alt, BD22, BD46, BD47, BD50, BE35, BE40, BE50, BE50T, C33, C34, C34dgt, C44, C44dgt, C44dgt-elt, C66, C66dgt, C66dgt-elt, C77, CE24, CW650-15, CW650-16, CW650-35, CW650-36, D120, D120dgt, D30, D35, D36, D40, D40ELT, D40ELT-BT-BA, D40i, D40i-BT-BA, D40i-ELT-BT-BA, D45, D80, D80F, D85, ETE20, ETE21, ETE25, ETE27, ETS15, LP60...(Other models you can see in the webshop)		

			
1			
Part No.	511852	Ref. No.	00010580
description	flat filter		
For models:	882, 885, 904, 906, 908, 912		

filters

			
1			
Part No.	507384	Ref. No.	00071600 00085810
description	filter		
For models:	EN, ET, ET020, ETA, LP130, LP70, LPE100, LPE145		

			
1			
Part No.	511590	Ref. No.	00065523 00067144
description	flat filter H 15mm stainless steel L 318mm W 242mm		
For models:	D120, D120dgt, LP60, LP60H, LP61, LP61H, LP70		

			
1			
Part No.	511120	Ref. No.	00011020
description	flat filter		
For models:	120, 160, 904, 906, 908, 912		

			
1			
Part No.	517491	Ref. No.	00065750
description	flat filter H 27mm SS L 365mm W 270mm		
For models:	LP130		

			
1			
Part No.	511121	Ref. No.	00011230
description	flat filter		
For models:	120, 160, 240, 904, 906, 908, 912, D120, D36, D45, D80, D80F, D85		

			
1			
Part No.	517493	Ref. No.	00079360
description	flat filter H 35mm SS L 577mm W 225mm		
For models:	ETE20, ETE21, ETE25, ETE27		

			
1			
Part No.	511122	Ref. No.	00010930
description	flat filter		
For models:	120, 160		

			
1			
Part No.	511583	Ref. No.	00018042
description	flat filter L 257mm W 294mm		
For models:	C44, C44dgt, C44dgt-elt, C66, C66dgt, C66dgt-elt, C77		

			
1			
Part No.	517492	Ref. No.	00065288
description	intake filter H 142mm SS L 130mm W 93mm		
For models:	LP130, LP70		



1

Part No.	511850	Ref. No.	00012735
description	intake filter \varnothing 225mm		
For models:	C33, CW650-15, CW650-16, CW650-35, CW650-36, D40, D40ELT, D40ELT-BT-BA, D40i, D40i-ELT-BT-BA, D80		



1

Part No.	511847	Ref. No.	00222030
description	intake filter suction \varnothing 205mm		
For models:	BD14, BD14alt		



1

Part No.	511825	Ref. No.	00200500
description	round filters \varnothing 115mm H 55mm		
For models:	42, 42E, 48, 48E, 55, 55E, B11, B15, BD11, BD13, BD14, BD46, BD47, BE35, BE40		



1

Part No.	511849	Ref. No.	00013773
description	round filters \varnothing 145mm H 107mm		
For models:	D30, D35, D36, D40, D40ELT, D40ELT-BT-BA, D40i, D40i-BT-BA, D40i-ELT-BT-BA, D45, D80		



1

Part No.	511845	Ref. No.	00018301
description	round filters \varnothing 145mm H 150mm		
For models:	C33, C34, C34dgt, C44, C44dgt, C44dgt-elt, C66, C66dgt, C66dgt-elt, CE24, CW650-15, CW650-16, CW650-35, CW650-36, D80, D80F, D85		



1

Part No.	517485	Ref. No.	00222665
description	round filters \varnothing 167mm H 112mm		
For models:	BD50, BE50, BE50T		



1

Part No.	517484	Ref. No.	00065570
description	round filters \varnothing 235mm H 180mm hole \varnothing 56mm		
For models:	C77, D120, D120dgt, LP60, LP60H, LP61, LP61H		



1

Part No.	511848	Ref. No.	00012724
description	round filters \varnothing 81mm H 67mm		
For models:	B11, BD11, BD13, BD14, BD46		



1

Part No.	511090	Ref. No.	00002000
description	round filters outflow		



1

Part No.	511087	Ref. No.	00002010
description	round filters suction		



overflow pipes



1

Part No.	511834	Ref. No.	06160041
description	gasket ø 33mm		
For models:	B11, B15, BD11, BD13, BD14, BD14alt, BD22, BD50, BE35, BE40, BE50, BE50T, C33, C34, C34dgt, C44, C44dgt, C44dgt-elt, C66, C66dgt, C66dgt-elt, C77, CW650-15, CW650-16, CW650-35, CW650-36, D120, D120dgt, D30, D35, D36, D40, D40ELT, D40ELT-BT-BA, D40i, D40i-BT-BA, D40i-ELT-BT-BA, D45, D80, D80F, D85, EN, ET, ET020, ETA, ETE20, ETE21, ETE25, ETE27, ETS15...(Other models you can see in the webshop)		



1

Part No.	511093	Ref. No.	00002113 0000211C
description	gasket with 4 screw holes ID ø 74mm ED ø 116mm thickness 3mm		



1

Part No.	503186	Ref. No.	00211052
description	overflow pipe L 130mm ø 43mm		
For models:	B11, BD11, BD13, BD14, BD46, BE35, BE40		



1

Part No.	511831	Ref. No.	00210937	
description	overflow pipe L 140mm ø 43mm			
For models:	B11, B15, BD11, BD13, BD14, BD46, BE35, BE40			
spare parts for	511831			
	Part No.	511834	Ref. No.	06160041
	gasket ø 33mm			



1

Part No.	511833 ¹	Ref. No.	00222045
description	overflow pipe L 180mm ø 43mm		
For models:	BD14, BD14alt, BD47		

¹for drain pump



1

Part No.	511832	Ref. No.	00222035
description	overflow pipe L 185mm ø 43mm		
For models:	BD14, BD14alt, BD47		



1

Part No.	511840 ¹	Ref. No.	00013839	
description	overflow pipe L 190mm ø 43mm			
For models:	BD22, D30, D35, D36, D40, D40ELT, D40ELT-BT-BA, D40i, D40i-BT-BA, D40i-ELT-BT-BA, D45			
accessories for	511840			
	Part No.	511834	Ref. No.	06160041
	gasket ø 33mm			

¹for drain pump



1

Part No.	511839	Ref. No.	00012718	
description	overflow pipe L 195mm ø 43mm			
For models:	BD22, D30, D35, D36, D40, D40ELT, D40ELT-BT-BA, D40i, D40i-BT-BA, D40i-ELT-BT-BA, D45			
accessories for	511839			
	Part No.	511834	Ref. No.	06160041
	gasket ø 33mm			

1

Part No.	511387	Ref. No.	00014074
description	overflow pipe L 240mm ø 43mm		
For models:	BD50, BE50, BE50T, C33, CW650-15, CW650-16, CW650-35, CW650-36, D80, D80F, D85		
spare parts for	511387		
	Part No.	511834	Ref. No. 06160041
	gasket ø 33mm		





1

Part No.	517499	Ref. No.	00222670
description	overflow pipe L 240mm ø 43mm		
For models:	BD50, BE50, BE50T		



1

Part No.	511844	Ref. No.	00018271
description	overflow pipe L 315mm ø 43mm		
For models:	C34, C34dgt, C44, C44dgt, C44dgt-elt, C66, C66dgt, C66dgt-elt, CE24		
spare parts for	511844		
	Part No.	511834	Ref. No. 06160041
	gasket ø 33mm		



1

Part No.	517489	Ref. No.	00065554
description	overflow pipe L 350mm ø 43mm		
For models:	C44, C66, C77, D120, D120dgt, LP60, LP60H, LP61, LP61H		



1

Part No.	518625	Ref. No.	00065375
description	overflow pipe L 390mm ø 38mm		
For models:	LP130, LP70		

containers

dosing containers



1

Part No.	361739	Ref. No.	00003740
description	rinse aid container		



1

Part No.	511126	Ref. No.	00011060
description	rinse aid container		
For models:	120, 160, 240, 882, 885, 904, 906, 908, 912		



accessories



1			
Part No.	511487	Ref. No.	00011053
description	funnel		
For models:	42, 42E, 48, 48E, 55, 55E, 60		



1			
Part No.	511163	Ref. No.	00003731 373A
description	screw for rinse aid container		
For models:	ES400, ES400-alt, ES400-sehr-alt, MRS400, MRS400-alt		

boilers

boilers for dishwashers



1			
Part No.	511901	Ref. No.	00003440
description	boiler		



1			
Part No.	511896	Ref. No.	00211009
description	boiler ø 120mm L 270mm		
For models:	B11, B15, BD11, BE35, BE40		



1			
Part No.	511898	Ref. No.	00210410
description	boiler ø 140mm L 270mm		
For models:	42, 42E, 48, 48E, 55, 55E, 60		



1			
Part No.	511897	Ref. No.	00222040
description	boiler ø 140mm L 270mm flange 4 hole inlet ø 50		
For models:	BD13, BD14, BD14alt, BD22, BD46, BD47, BD50, BE50, BE50T		



1			
Part No.	511900	Ref. No.	00010500 00065312
description	boiler ø 170mm L 440mm		
For models:	120, 160, 240, 882, 885, 904, 906, 908, 912, C33, C34, C34dgt, C44, C44dgt, C44dgt-elt, C66, C66dgt, C66dgt-elt, C77, CE24, CW650-15, CW650-16, CW650-35, CW650-36, D120, D120dgt, D30, D35, D36, D40, D40ELT, D40ELT-BT-BA, D40i, D40i-ELT-BT-BA, D45, D80, D80F, D85, LP60, LP60H, LP61, LP61H, LP70		

accessories



1			
Part No.	699274	Ref. No.	00010514
description	connecting fitting for boiler thread 1/2" L 75mm W 32mm hose ø 14/5mm		
For models:	BD46, BD47, BE35, BE40, BE50, BE50T, C34, C44dgt, C44dgt-elt, C66dgt, C66dgt-elt, CE24, D120dgt, D36, D45, D85, LP61, LP61H, LP70		



1			
Part No.	511817	Ref. No.	00010502
description	T-piece connection 1/4" ET - 1/2" IT hose ø 13mm 1/4" ET - 1/2" IT hose ø 13mm		
For models:	120, 160, 240, 882, 885, 904, 906, 908, 912, B11, B15, BD11, BD13, BD14, BD14alt, BD22, BD46, BD47, BD50, BE35, BE40, BE50, C33, C34, C34dgt, C44, C44dgt, C66, C66dgt, C77, D120, D30, D35, D36, D40, D40ELT, D40ELT-BT-BA, D40i, D40i-ELT-BT-BA, D45, D80, D80F, D85, LP60, LP60H, LP61, LP61H, SQ885, SQT80		



softener cartridges

softening columns



1

Part No.	530001	Ref. No.	12145001
description	softener 4-fold L 380mm W 180mm		
For models:	42, 42E, 48, 48E, 55, 55E, 60, B11, BD11, BD13, BD14, BD14alt, BD22, BD50, BE35, BE40, BE50, BE50T, D35, D36, D40, D40ELT, D40ELT-BT-BA, D40i, D40i-BT-BA, D40i-ELT-BT-BA, D45		

housing and bezels

fascias



1

Part No.	403262	Ref. No.	00222433
description	control panel warewashing BE35 W 178mm H 48mm D 58mm suitable for ELFRAMO		
For models:	BD50, BE35, BE40, BE50		

miscellaneous



1

Part No.	692476	Ref. No.	00222460
description	spacer for lid L 43mm ID \varnothing 5mm ED \varnothing 24.6mm thickness 2.7mm		
For models:	BD50, BE35, BE40, BE50		

hood mechanics for dishwashers

bolts



1

Part No.	511888	Ref. No.	00018051
description	screw bolt hood mechanics		
For models:	C33, C34, C34dgt, C44, C44dgt, C44dgt-elt, C66, C66dgt, C66dgt-elt, C77, CE24, CW650-15, CW650-16, CW650-35, CW650-36		

springs



1

Part No.	511623	Ref. No.	00002320
description	spring for hood mechanics		



1

Part No.	511625	Ref. No.	00002330
description	spring for hood mechanics		

hood handles



1

Part No.	701464	Ref. No.	00018661
description	hood handle L 870mm W 705mm		
For models:	C34, C34dgt, C44dgt, C44dgt-elt, C66dgt, C66dgt-elt, CE24		

hood handle supports



1

Part No.	511560	Ref. No.	00018030 00018049 00018165
description	handle holder hood mechanics H 42mm \varnothing 90mm		
For models:	C33, C34, C34dgt, C44, C44dgt, C44dgt-elt, C66, C66dgt, C66dgt-elt, C77, CE24, CW650-15, CW650-16, CW650-35, CW650-36		



rollers



1

Part No.	511876	Ref. No.	00013784
description	roller ED ø 40mm ID ø 11mm		
For models:	BD14, BD14alt, BD22, BD46, BD47, D36, D40, D40ELT, D40ELT-BT-BA, D40i, D40i-BT-BA, D40i-ELT-BT-BA, D45, D80, D80F, D85		



1

Part No.	511595	Ref. No.	00065842
description	roller set ø 30mm H 24mm for dishwasher hole ø 15mm		
For models:	LP130		

cable controls



1

Part No.	511118	Ref. No.	00000235 00002350
description	cable control foot switch for hood		



1

Part No.	511152	Ref. No.	00002370
description	hauling cable L 900mm hood mechanics		

miscellaneous



1

Part No.	511887	Ref. No.	00018050
description	bush hood mechanics		
For models:	C33, C34, C34dgt, C44, C44dgt, C44dgt-elt, C66, C66dgt, C66dgt-elt, C77, CE24, CW650-15, CW650-16, CW650-35, CW650-36		



1

Part No.	511885	Ref. No.	00018026
description	handle holder hood mechanics		
For models:	C33, C34, C34dgt, C44, C44dgt, C44dgt-elt, C66, C66dgt, C66dgt-elt, C77, CE24, CW650-15, CW650-16, CW650-35, CW650-36		



1

Part No.	511886	Ref. No.	00018021
description	roller hood mechanics		
For models:	C33, C34, C34dgt, C44, C44dgt, C44dgt-elt, C66, C66dgt, C66dgt-elt, C77, CE24, CW650-15, CW650-16, CW650-35, CW650-36, GFP25, GFP25AC, GFU25, GFU25AC		

basket guides

guide bars



1

Part No.	699273	Ref. No.	00073240
description	guide for rack conveyor dishwashing machine L 50mm W 45mm H 80mm with rollers		
For models:	ET, ET020, ETA, ETE20, ETE21, ETE25, ETE27		

basket holders

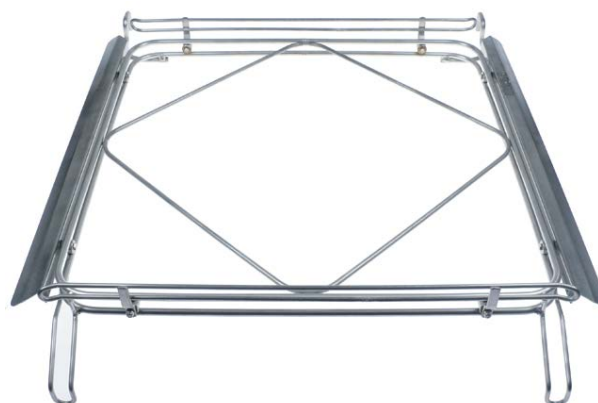

1

Part No.	971059	Ref. No.	00018060 00018404
description	basket support L 640m W 560mm H 110mm		
For models:	C34, C34dgt, C44, C44dgt, C44dgt-elt, C66, C66dgt, C66dgt-elt, CE24		



air traps

air traps



1

Part No.	511067	Ref. No.	00002180 00011350 00205750
description	air trap		
For models:	120, 160, 240, 904, 906, 908, 912, C34, C34dgt, C44, C44dgt, C44dgt-elt, C66, C66dgt, C66dgt-elt, C77, D120, D120dgt, EN, ET, ET020, ETA, ETE20, ETE21, ETE25, ETE27, ETS15, LP130, LP60, LP60H, LP61, LP61H, LP70, LPE100, LPE145		



1

Part No.	511824	Ref. No.	00013984 00014098 00014099
description	air trap		
For models:	B11, BD11, BD13, BD14, BD22, BD46, BD47, BE35, BE40, D30, D35, D36, D40, D40i, D40i-BT-BA, D45, D80		



1

Part No.	519465	Ref. No.	00014086 00014087
description	air trap ø 45mm H 160mm thread 3/8" hose ø 6mm		
For models:	C33, D80, D80F, D85		

mechanics for flight type dishwashers



1

Part No.	532687	Ref. No.	00049050
description	tappet L 115mm W 68mm hole ø 8.5mm		

backflow preventers

backflow preventers



1

Part No.	516101	Ref. No.	23180203
description	backflow preventer dishwasher hose ø 12mm		
For models:	B11, BD13, BD14, BD46, BD47, BD50, BE35, BE40, BE50, BE50T, C33, C34, C34dgt, C44, C44dgt, C44dgt-elt, C66, C66dgt, C66dgt-elt, C77, CE24, D120, D120dgt, D30, D35, D36, D40, D40ELT, D40ELT-BT-BA, D40i, D40i-BT-BA, D40i-ELT-BT-BA, D45, D80, D85, LP130, LP60, LP60H, LP61, LP61H, LP70		
spare parts for	516101		
	Part No.	506367	Ref. No. —
flat gasket rubber ED ø 40mm ID ø 28mm thickness 1.8mm Qty 1 pcs			

door mechanics

springs

roller springs



1

Part No.	519550	Ref. No.	00079740
description	roller spring W 25.35mm		
For models:	ETE20, ETE21, ETE25, ETE27		



1

Part No.	519491	Ref. No.	00079730
description	roller spring W 26mm		
For models:	ETE20, ETE21, ETE25, ETE27, ETS15, LP130, LP60H, LP61H, LP70		





			
1			
Part No.	519543	Ref. No.	00065816
description	roller spring with holder W 46mm ID 6mm lug lengthmm		
For models:	LP130, LP60, LP60H, LP61, LP61H		

linkage

			
1			
Part No.	698783	Ref. No.	00073630
description	door pin		
For models:	ET, ET020, ETA		

			
1			
Part No.	511906	Ref. No.	00210993
description	door pin L 210mm tie bar		
For models:	B11		

			
1			
Part No.	511881	Ref. No.	00210366
description	door pin mounting pos. left complete tie bar		
For models:	42, 42E, 48, 48E, 55, 55E		

			
1			
Part No.	698784	Ref. No.	00073640
description	door pin mounting pos. upper		
For models:	ET, ET020, ETA		

			
1			
Part No.	511871	Ref. No.	00210983
description	tie bar L 260mm		
For models:	B11, BD13, BD14, BD22, BD50, BE50, BE50T, D120, D120dgt, D30, D35, D36, D40, D40ELT, D40ELT-BT-BA, D40i, D40i-BT-BA, D40i-ELT-BT-BA, D45, D80, D85		

			
1			
Part No.	511880	Ref. No.	00210361
description	tie bar mounting pos. right complete		
For models:	42, 42E, 48, 48E, 55, 55E		

threaded shafts

			
1			
Part No.	511879	Ref. No.	00210939
description	threaded part threaded part		
For models:	B11, B15, BD11, BD13, BD14, BD14alt, BD22, BD50, BE50, BE50T, D120, D120dgt, D30, D35, D36, D40, D40ELT, D40ELT-BT-BA, D40i, D40i-BT-BA, D40i-ELT-BT-BA, D45, D80, D80F, D85		

sliding plates

			
1			
Part No.	511907	Ref. No.	00013777
description	sliding plate		
For models:	BD14, BD14alt, D120, D120dgt, D30, D40, D80		

			
1			
Part No.	511878	Ref. No.	00013780
description	sliding plate sliding plate		
For models:	BD14, BD14alt, D30, D40, D80		

rollers

			
1			
Part No.	501445	Ref. No.	00041907
description	roller ED ø 23.7mm for door shaft diameter 8mm		
For models:	EN, ET, ET020, ETA, LPE100, LPE145		

			
1			
Part No.	501431	Ref. No.	00013907
description	roller ED ø 9mm for door mechanism shaft diameter 3.5mm W 5mm		
For models:	BD14, BD14alt, BD22, BD46, BD47, D35, D36, D40, D40ELT, D40ELT-BT-BA, D40i, D40i-BT-BA, D40i-ELT-BT-BA, D45, D80, D80F, D85, ET, ETE20, ETE21, ETE25, ETE27, ETS15		



hinges



Part No.	519417	Ref. No.	00065309
description	door hinge		
For models:	D120, LP130, LP60, LP60H, LP61, LP61H, LP70		



Part No.	511866	Ref. No.	00210902
description	door hinge door hinge left mounting pos. left		
For models:	B11, B15		



Part No.	511874	Ref. No.	00013744
description	door hinge door hinge left mounting pos. left		
For models:	BD14, BD14alt, BD22, D36, D40, D40ELT, D40ELT-BT-BA, D40i, D40i-BT-BA, D40i-ELT-BT-BA, D45, D80, D80F, D85		



Part No.	511865	Ref. No.	00210903
description	door hinge door hinge right mounting pos. right		
For models:	B11, B15		



Part No.	511873	Ref. No.	00013743
description	door hinge door hinge right mounting pos. right		
For models:	BD14, BD14alt, BD22, D36, D40, D40ELT, D40ELT-BT-BA, D40i, D40i-BT-BA, D40i-ELT-BT-BA, D45, D80, D80F, D85		



Part No.	517781	Ref. No.	00222629
description	hinge for door mounting pos. left dishwasher L 130mm ELFRAMO W 32mm		
For models:	BD50, BE35, BE40, BE50, BE50T		



Part No.	517780	Ref. No.	00222626
description	hinge for door mounting pos. right for dishwasher L 130mm H 32mm		
For models:	BD50, BE35, BE40, BE50, BE50T		

door guides



Part No.	517496	Ref. No.	00065245
description	door guides L 460mm W 34mm H 25mm mounting pos. left/right		
For models:	LP130, LP60, LP60H, LP61, LP70		



door magnets



1

Part No.	694539	Ref. No.	25110108
description	door magnet L 63mm W 7.5mm H 19mm mounting distance 52mm		
For models:	D120dgt		

door bumpers



1

Part No.	511869	Ref. No.	00013791
description	door bumper end stop		
For models:	B11, B15, BD14, BD14alt, D120, D30, D40, D80		

locks



1

Part No.	511083	Ref. No.	00011040
description	counterpart door catch		
For models:	120, 160, 240, 42, 42E, 48, 48E, 55, 55E, 60, 882, 885, 904, 906, 908, 912, B11, B15, BD11, BD13, D120, D120dgt, D30, D35, SQ885, SQT80		



1

Part No.	511105	Ref. No.	00001670 00001680
description	counterpart door catch		



1

Part No.	511104	Ref. No.	00001630 00001640	
description	door catch			
accessories for	511104			
	Part No.	511105	Ref. No.	00001670 00001680
	counterpart door catch			



1

Part No.	511082	Ref. No.	00011028	
description	door catch complete catch			
For models:	120, 160, 240, 42, 42E, 48, 48E, 55, 55E, 60, 882, 885, 904, 906, 908, 912, B11, B15, BD11, BD13, D120, D120dgt, D30, D35, SQ885, SQT80			
accessories for	511082			
	Part No.	511083	Ref. No.	00011040
	counterpart door catch			

miscellaneous



1

Part No.	530847	Ref. No.	00065595
description	cap for door handle ID ø 5mm D1 ø 21.7mm D2 ø 12.7mm		
For models:	ETE20, ETE21, ETE25, ETE27, LP130, LP60, LP60H, LP61, LP61H, LP70		



1

Part No.	524047	Ref. No.	00013786
description	hauling cable for door mechanism ø 1.5mm L 475mm		
For models:	BD22, BD46, BD47, D36, D40, D40ELT, D40ELT-BT-BA, D40i, D40i-BT-BA, D40i-ELT-BT-BA, D45, D80, D80F		



1

Part No.	511877	Ref. No.	00222059
description	hauling cable hauling cable		
For models:	BD14, BD14alt, D80, D85		



1

Part No.	511868	Ref. No.	00013829
description	hinge complete hinge		
For models:	D120, D120dgt, D30		



1

Part No.	511594	Ref. No.	00220340
description	hinge for dishwasher door set D1 ø 20mm D2 ø 12mm		
For models:	B11, BD11, BD13, BD22, D30, D35		



1

Part No.	519408	Ref. No.	00013909
description	linkage guide for tie bar complete		
For models:	B11, BD11, BD13, BD14, BD22, BD50, BE50, BE50T, D120, D120dgt, D30, D35, D36, D40, D40ELT, D40ELT-BT-BA, D40i, D40i-BT-BA, D40i-ELT-BT-BA, D45, D80, D80F, D85		



1

Part No.	517782	Ref. No.	00001672
description	spring L 16.5mm mounting pos. for door guides D1 ø 9mm wire gauge ø 1.2mm		
For models:	BD50, BE35, BE40, BE50		

screw connections



1

Part No.	519409	Ref. No.	00013785
description	screw		
For models:	BD14, BD14alt, BD22, BD46, BD47, D36, D40, D40ELT, D40ELT-BT-BA, D40i, D40i-BT-BA, D40i-ELT-BT-BA, D45, D80, D80F, D85		

curtains

curtains

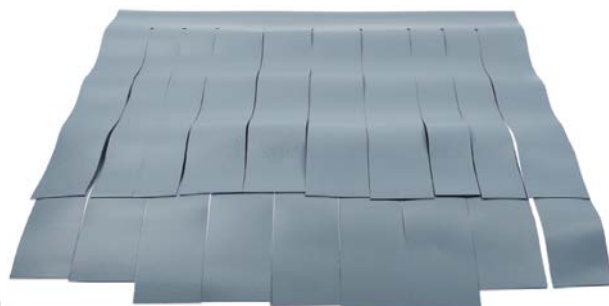

1

Part No.	533013	Ref. No.	00076010
description	curtain W 620mm H 550mm warewashing		
For models:	EN, ET, ET020, ETA, ETE20, ETE21, ETE25, ETE27, ETS15		



1

Part No.	533021	Ref. No.	00062000 00062030
description	curtain W 650mm H 450mm plastic thickness 1.5mm		
For models:	EN, ET, ET020, ETA, ETE20, ETE21, ETE25, ETE27, ETS15		

washing and rinsing systems



1

Part No.	511716	Ref. No.	00222102
description	null		
For models:	BD14, BD14alt, BD47, C33, CW650-15, CW650-16, CW650-35, CW650-36, D80, D85		



1

Part No.	511781	Ref. No.	00202632
description	rinse arm support mounting pos. upper		
For models:	42, 42E, 48, 48E, 55, 55E, 60, B11, B15, BD11, BE35		





1

Part No.	511728	Ref. No.	00018077
description	rinse pipe		
For models:	C44, C44dgt, C44dgt-elt, C66, C66dgt, C66dgt-elt, C77, D120, D120dgt, D30, D40		





			
1			
Part No.	511730	Ref. No.	00014042
description	rinse pipe		
For models:	BD50, BE50, BE50T, C33, C34, C34dgt, CE24, CW650-15, CW650-16, CW650-35, CW650-36, D30, D35, D36, D40, D40ELT, D40ELT-BT-BA, D40i, D40i-BT-BA, D40i-ELT-BT-BA, D45, D80, D80F, D85		

			
1			
Part No.	511732	Ref. No.	00013779
description	rinse pipe		
For models:	D30, D35, D40, D40ELT, D40ELT-BT-BA, D40i, D40i-BT-BA, D40i-ELT-BT-BA		

			
1			
Part No.	517503	Ref. No.	00018038 00018261 00018352
description	rinse pipe L 770mm		
For models:	C34, C34dgt, C44, C44dgt, C44dgt-elt, C66, C66dgt, C66dgt-elt, C77, D120, D120dgt		

			
1			
Part No.	511720	Ref. No.	00211015
description	rinse pipe mounting pos. lower		
For models:	B11, B15, BD11, BD13, BD14, BD22, BD46, BE35, BE40		

			
1			
Part No.	511714	Ref. No.	00222103
description	rinse pipe mounting pos. upper		
For models:	B11, B15, BD11, BD13, BD14, BD14alt, BD22, BD46, BD47, BE35, BE40		

			
1			
Part No.	511624	Ref. No.	00005080
description	rinse pipe ø 10mm L 400mm connection 3/8"		
For models:	120, 240, C44, C66, C77, D120, D120dgt, LP130, LP60, LP60H, LP61, LP61H, LP70		

			
1			
Part No.	511741	Ref. No.	02120040
description	throttle disc		
For models:	C34, C34dgt, C44, C66, CE24, LP130, LP60, LP60H, LP61, LP61H, LP70		

			
1			
Part No.	511704	Ref. No.	00018076
description	Thumb screw		
For models:	B11, B15, BD11, BD13, BD14, BD14alt, BD22, BD46, BD47, BE35, BE40, BE50, C33, C34, C34dgt, C44, C44dgt, C44dgt-elt, C66, C66dgt, C66dgt-elt, C77, CE24, CW650-15, CW650-16, CW650-35, CW650-36, D120, D120dgt, D30, D36, D40, D40ELT, D40ELT-BT-BA, D45, D80, D80F, D85, LP130, LP60, LP60H, LP61, LP61H, LP70		

			
1			
Part No.	511484	Ref. No.	00000395 00003950
description	T-piece thread 1 1/4" H 82mm L 120mm		
For models:	SQ885, SQT80		

			
1			
Part No.	511713	Ref. No.	00222111
description	wash arm bearing		
For models:	BD13, BD14, BD14alt, BD22, BD46, BD47, BE40		

			
1			
Part No.	511729	Ref. No.	00014041
description	wash arm bearing		
For models:	BD50, BE50, BE50T, C33, C34, C34dgt, CE24, CW650-15, CW650-16, CW650-35, CW650-36, D30, D35, D36, D40, D40ELT, D40ELT-BT-BA, D40i, D40i-BT-BA, D40i-ELT-BT-BA, D45, D80, D80F, D85		



Part No.	511592	Ref. No.	00011858 00014286
description	wash pipe L 730mm suitable for ELFRAMO		
For models:	BD50, BE50, BE50T, D30, D35, D36, D40, D40ELT, D40ELT-BT-BA, D40i, D40i-BT-BA, D40i-ELT-BT-BA, D45, D80		



Part No.	517505	Ref. No.	00018260
description	wash pipe L 870mm SS		
For models:	C44, C44dgt, C44dgt-elt, C66, C66dgt, C66dgt-elt, D120		



Part No.	511492	Ref. No.	00000511 00005110
description	wash pipe mounting pos. lower ø 34mm L 153mm		
For models:	882, 885, SQ885, SQT80		



Part No.	511493	Ref. No.	00000512 00005120
description	wash pipe mounting pos. lower ø 38mm L 176mm		
For models:	120, 160, 906, 908		



Part No.	511489	Ref. No.	00000514 00005140
description	wash pipe mounting pos. lower ø 39mm L 233mm		
For models:	240, C34, C34dgt, C44, C44dgt, C44dgt-elt, C66, C66dgt, C66dgt-elt, C77, CE24, D120, D120dgt, LP60, LP60H, LP61, LP61H		



Part No.	511491	Ref. No.	00000513 00005130
description	wash pipe ø 38mm L 214mm		
For models:	120, 160, 906, 908		

washing and rinsing systems (sorted by producer)

ELFRAMO



Part No.	511028	Ref. No.	00202710
description	wash arm L 320mm nozzles 4 mounting ø 15/59mm mounting pos. lower		
For models:	42, 42E, 48, 48E, 55, 55E		

Part No.	511757	Ref. No.	00202670
description	wash arm L 135mm nozzles 1 mounting ø 19mm		
Part No.	511758	Ref. No.	00202680
description	wash arm L 135mm nozzles 1 mounting ø 19mm		
Part No.	511759	Ref. No.	00202690
description	wash arm L 135mm nozzles 1 mounting ø 19mm		
Part No.	511760	Ref. No.	00202700
description	wash arm L 135mm nozzles 1 mounting ø 19mm		
Part No.	511770	Ref. No.	00202530
description	spring		
Part No.	511772	Ref. No.	—
description	wash jet		





Part No.	511770	Ref. No.	00202530
description	spring		
For models:	42, 42E, 48, 48E, 55, 55E, 60		





			
1			
Part No.	511757	Ref. No.	00202670
description	wash arm L 135mm nozzles 1 mounting ø 19mm		
For models:	42, 42E, 48, 48E, 55, 55E		

			
1			
Part No.	511758	Ref. No.	00202680
description	wash arm L 135mm nozzles 1 mounting ø 19mm		
For models:	42, 42E, 48, 48E, 55, 55E		

			
1			
Part No.	511759	Ref. No.	00202690
description	wash arm L 135mm nozzles 1 mounting ø 19mm		
For models:	42, 42E, 48, 48E, 55, 55E		







			
1			
Part No.	511760	Ref. No.	00202700
description	wash arm L 135mm nozzles 1 mounting ø 19mm		
For models:	42, 42E, 48, 48E, 55, 55E		

			
1			
Part No.	511770	Ref. No.	00202530
description	spring		
For models:	42, 42E, 48, 48E, 55, 55E, 60		

			
1			
Part No.	511761	Ref. No.	00202540
description	wash arm L 165mm nozzles 1 mounting ø 19mm		
For models:	42, 42E, 48, 48E, 55, 55E		

			
1			
Part No.	511762	Ref. No.	00202550
description	wash arm L 165mm nozzles 1 mounting ø 19mm		
For models:	42, 42E, 48, 48E, 55, 55E		
spare parts for	511762		
	Part No.	511772	Ref. No. —
	wash jet		

			
1			
Part No.	511763	Ref. No.	00202560
description	wash arm L 165mm nozzles 1 mounting ø 19mm		
For models:	42, 42E, 48, 48E, 55, 55E		

			
1			
Part No.	511029	Ref. No.	00202830
description	wash arm L 450mm nozzles 4 mounting ø 15/59mm mounting pos. lower		
For models:	42, 42E, 48, 48E, 55, 55E, 60		
spare parts for	511029		
	Part No.	511766	Ref. No. 00202800
	wash arm L 200mm nozzles 1 mounting ø 19mm		
	Part No.	511767	Ref. No. 00202810
	wash arm L 200mm nozzles 1 mounting ø 19mm		
	Part No.	511768	Ref. No. 00202820
	wash arm L 200mm nozzles 1 mounting ø 19mm		
	Part No.	511770	Ref. No. 00202530
	spring		
	Part No.	511772	Ref. No. —
	wash jet		

			
1			
Part No.	511770	Ref. No.	00202530
description	spring		
For models:	42, 42E, 48, 48E, 55, 55E, 60		





			
1			
Part No.	511767	Ref. No.	00202810
description	wash arm L 200mm nozzles 1 mounting ø 19mm		
For models:	42, 42E, 48, 48E, 55, 55E, 60		

			
1			
Part No.	511768	Ref. No.	00202820
description	wash arm L 200mm nozzles 1 mounting ø 19mm		
For models:	42, 42E, 48, 48E, 55, 55E		

			
1			
Part No.	511074	Ref. No.	00011340
description	wash jet		
For models:	120, 160, 240, 906, 908, ET, ETA, ETE20, ETE21, ETE25, ETE27		

			
1			
Part No.	511795	Ref. No.	00011180
description	wash arm L 200mm nozzles 1 mounting ø 27mm		
For models:	120, 160, 906, 908		

			
1			
Part No.	511074	Ref. No.	00011340
description	wash jet		
For models:	120, 160, 240, 906, 908, ET, ETA, ETE20, ETE21, ETE25, ETE27		

			
1			
Part No.	511800	Ref. No.	00011259
description	wash arm L 220mm nozzles 1 mounting ø 27mm		
For models:	240		

			
1			
Part No.	511802	Ref. No.	00011261
description	wash arm L 220mm nozzles 1 mounting ø 27mm		
For models:	240		

			
1			
Part No.	511799	Ref. No.	00011258
description	wash arm L 220mm nozzles 2 mounting ø 27mm		
For models:	240		

			
1			
Part No.	511801	Ref. No.	00011260
description	wash arm L 220mm nozzles 2 mounting ø 27mm		
For models:	240		

			
1			
Part No.	511074	Ref. No.	00011340
description	wash jet		
For models:	120, 160, 240, 906, 908, ET, ETA, ETE20, ETE21, ETE25, ETE27		

			
1			
Part No.	511800	Ref. No.	00011259
description	wash arm L 220mm nozzles 1 mounting ø 27mm		
For models:	240		

			
1			
Part No.	511802	Ref. No.	00011261
description	wash arm L 220mm nozzles 1 mounting ø 27mm		
For models:	240		





 <p>1</p>			
Part No.	511799	Ref. No.	00011258
description	wash arm L 220mm nozzles 2 mounting ø 27mm		
For models:	240		

 <p>1</p>			
Part No.	511074	Ref. No.	00011340
description	wash jet		
For models:	120, 160, 240, 906, 908, ET, ETA, ETE20, ETE21, ETE25, ETE27		

 <p>1</p>			
Part No.	511813	Ref. No.	00004520
description	wash arm L 170mm nozzles 1 thread 3/4"		
For models:	882, 885, SQ885, SQT80		



 <p>1</p>			
Part No.	511814	Ref. No.	00004530
description	wash arm L 195mm nozzles 1 thread 3/4"		
For models:	882, 885, SQ885, SQT80		



 <p>1</p>			
Part No.	511811	Ref. No.	00004500
description	wash arm L 200mm nozzles 1 thread 3/4"		
For models:	882, 885, SQ885, SQT80		

 <p>1</p>			
Part No.	511773	Ref. No.	00202720
description	rinse arm L 315mm nozzles 4 mounting ø 14mm mounting pos. upper/lower		
For models:	42, 42E, 48, 48E, 55, 55E		
spare parts for	511773		
	Part No.	511039	Ref. No. 00011166
rinse arm shaft			

spare parts for	511773		
	Part No.	511775	Ref. No. 00202730
rinse arm L 130mm nozzles 2 thread 1/4"			



 <p>1</p>			
Part No.	511775	Ref. No.	00202730
description	rinse arm L 130mm nozzles 2 thread 1/4"		
For models:	42, 42E, 48, 48E, 55, 55E		

 <p>1</p>			
Part No.	511774	Ref. No.	00202600
description	rinse arm L 375mm nozzles 4 mounting ø 14mm mounting pos. upper		
For models:	42, 42E, 48, 48E, 55, 55E		
spare parts for	511774		
	Part No.	511039	Ref. No. 00011166
rinse arm shaft			
	Part No.	511777	Ref. No. 00202610
rinse arm L 163mm nozzles 2 thread 1/4"			

 <p>1</p>			
Part No.	511026	Ref. No.	00011241
description	rinse arm L 545mm nozzles 4 mounting ø 14mm complete		
For models:	240		
spare parts for	511026		
	Part No.	511039	Ref. No. 00011166
rinse arm shaft			

1

Part No.	511041	Ref. No.	00210015
description	wash arm L 328mm nozzles 3 mounting pos. upper thread 3/4"		
For models:	42, 42E, 48, 48E, 55, 55E		
spare parts for	511041		
	Part No.	505073	Ref. No. 06140005
	O-ring EPDM thickness 2.62mm ID ø 20.63mm Qty 1 pcs		
	Part No.	511772	Ref. No. —
	wash jet		



1

Part No.	511042	Ref. No.	00210016
description	wash arm L 365mm nozzles 3 mounting pos. upper thread 3/4"		
For models:	42, 42E, 48, 48E, 55, 55E		
spare parts for	511042		
	Part No.	505073	Ref. No. 06140005
	O-ring EPDM thickness 2.62mm ID ø 20.63mm Qty 1 pcs		
	Part No.	511772	Ref. No. —
	wash jet		







1

Part No.	511701	Ref. No.	00220395
description	rinse arm L 325mm nozzles 4 mounting ø 12mm mounting pos. upper/lower		
For models:	B11, BE35		



1

Part No.	511703	Ref. No.	00222083 00222122 00222127
description	rinse arm L 380mm nozzles 4 mounting ø 12mm mounting pos. upper/lower		
For models:	BD13, BD14, BD14alt, BD46, BD47, BE40		
spare parts for	511703		
	Part No.	511704	Ref. No. 00018076
	Thumb screw		
	Part No.	511705	Ref. No. 00018106
	disc		
	Part No.	511706	Ref. No. 00018228
	knurled nut		
	Part No.	511707	Ref. No. 00014555 00018083 00018084
	rinse jet ø 8mm H 10mm WS		



1

Part No.	511909	Ref. No.	00011214
description	wash and rinse arm conversion kit for ELFRAMO Mod. 120		



1

Part No.	511700	Ref. No.	00211010
description	wash arm L 350mm nozzles 7 mounting ø 14/39.5mm mounting pos. upper/lower		
For models:	B11, B15, BD11, BE35		





			
1			
Part No.	511702	Ref. No.	00222000
description	wash arm L 400mm nozzles 8 mounting ø 15/39.5mm mounting pos. upper/lower		
For models:	BD13, BD14, BD14alt, BD46, BD47, BE40		

			
1			
Part No.	511723	Ref. No.	00014045 00018287
description	wash arm L 484mm nozzles 8 mounting ø 15/46mm mounting pos. upper/lower		
For models:	BD50, BE50, BE50T, D30, D35, D36, D40, D40ELT, D40ELT-BT-BA, D40i, D40i-BT-BA, D40i-ELT-BT-BA, D45		

			
1			
Part No.	511724	Ref. No.	00014048
description	wash arm L 485mm nozzles 11 mounting ø 15/46mm mounting pos. upper/lower		
For models:	BD50, BE50, C33, C34, C34dgt, CE24, CW650-15, CW650-16, CW650-35, CW650-36, D80, D80F, D85		

			
1			
Part No.	511737	Ref. No.	00016851 00018190
description	wash arm L 535mm nozzles 10 mounting ø 15/60mm mounting pos. upper/lower		
For models:	C44, C44dgt, C44dgt-elt, C66, C66dgt, C66dgt-elt, C77, D120, D120dgt		





			
1			
Part No.	511921	Ref. No.	00052010
description	wash arm L 655mm nozzles 24 mounting ø 15/80mm mounting pos. upper/lower		
For models:	LP130, LP70		

			
1			
Part No.	511924	Ref. No.	00011216
description	wash arm mounting pos. upper and bottom conversion kit for ELFRAMO Mod. 160		

			
1			
Part No.	517497	Ref. No.	00222005
description	wash arm mounting pos. upper/lower L 460mm nozzles 10		
For models:	BD22		

			
1			
Part No.	517500	Ref. No.	00065336
description	wash arm boss mounting pos. upper/lower ø 99mm H 74mm		
For models:	LP130, LP60, LP60H, LP61, LP61H, LP70		





			
1			
Part No.	511551	Ref. No.	00018155 00222295
description	rinse arm L 480mm nozzles 6 mounting ø 12mm mounting pos. upper/lower		
For models:	BD22, BE50, BE50T, C33, C34, C34dgt, C44, C44dgt, C44dgt-elt, C66, C66dgt, C66dgt-elt, CE24, CW650-15, CW650-16, CW650-35, CW650-36, D30, D36, D40, D45, D80, D80F, D85		
spare parts for	511551		
	Part No.	511704	Ref. No. 00018076
	Thumb screw		
	Part No.	511705	Ref. No. 00018106
	disc		
	Part No.	511706	Ref. No. 00018228
	knurled nut		

			
1			
Part No.	517486	Ref. No.	00079318 00090793 00090821 00095071
description	rinse arm L 580mm nozzles 4		
For models:	ETE20, ETE21, ETE25, ETE27, ETS15		

			
1			
Part No.	519490	Ref. No.	00065294 00065435
description	rinse arm L 665mm nozzles 7 mounting ø 12mm mounting pos. upper/lower W 29mm		
For models:	LP130, LP70		

			
1			
Part No.	517487	Ref. No.	00065625
description	rinse arm mounting pos. upper/lower L 550mm nozzles 6 thread M10x1.5		
For models:	C77, D120, D120dgt, LP60, LP60H, LP61, LP61H		

			
1			
Part No.	511707	Ref. No.	00014555 00018083 00018084
description	rinse jet ø 8mm H 10mm WS		
For models:	B11, B15, BD11, BD13, BD14, BD14alt, BD22, BD50, BE40, BE50, BE50T, C33, C34, C34dgt, C44, C44dgt, C44dgt-elt, C66, C66dgt, C66dgt-elt, C77, CE24, CW650-15, CW650-16, CW650-35, CW650-36, D120, D120dgt, D30, D36, D40, D40ELT, D40ELT-BT-BA, D45, D80, D80F, D85, EN, ET, ET020, ETE20, ETE21, ETE25, ETE27, ETS15, LP130, LP60, LP60H, LP61, LP61H...(Other models you can see in the webshop)		

			
1			
Part No.	511586	Ref. No.	00072360
description	rinse arm L 636mm nozzles 7 mounting pos. upper/lower thread 3/4"		
For models:	EN, ET, ETA		

			
1			
Part No.	511587	Ref. No.	00052150 00072350
description	rinse arm L 638mm nozzles 7 mounting pos. left thread 3/4"		
For models:	EN, ET, ET020, ETA		

			
1			
Part No.	511621	Ref. No.	00000496 00004960 00007237 00072370
description	rinse jet rinse jet ID ø 2.5mm		
For models:	120, 160, 240, 882, 885, 908, EN, ET, ETA, ETE20, ETE21, ETE25, ETE27, LPE100, LPE145		





			
1			
Part No.	512408	Ref. No.	00082549
description	wash arm L 625mm nozzles 4 mounting ø 41mm mounting pos. upper/lower with pin for pre-washing ELFRAMO		
For models:	EN, ET, ET020		

			
1			
Part No.	517501	Ref. No.	00079102
description	wash jet mounting pos. upper/lower H 18mm ø 24.4mm		
For models:	EN, ET, ET020, ETE20, ETE21, ETE25, ETE27, ETS15		

			
1			
Part No.	511077	Ref. No.	00004931
description	wash jet		

			
1			
Part No.	511640	Ref. No.	00011839
description	wash jet holder ø 40mm thread M32x2.5		

			
1			
Part No.	511715	Ref. No.	00222104
description	opposite support mounting pos. lower for wash arm support		
For models:	BD13, BD14, BD14alt, BD22, BD46, BD47, BE40		

			
1			
Part No.	511719	Ref. No.	00012710
description	opposite support mounting pos. lower for wash arm support		
For models:	B11, B15, BD11, BD50, BE35, BE50, BE50T, C33, CW650-15, CW650-16, CW650-35, CW650-36, D120, D30, D35, D36, D40, D40ELT, D40ELT-BT-BA, D40i, D40i-BT-BA, D40i-ELT-BT-BA, D45, D80, D80F, D85		

			
1			
Part No.	511785	Ref. No.	00202781
description	opposite support mounting pos. lower for wash arm support		
For models:	42, 42E, 48, 48E, 55, 55E, 60		

			
1			
Part No.	511717	Ref. No.	00222101
description	wash arm support		
For models:	BD14, BD14alt, BD47		

			
1			
Part No.	511735	Ref. No.	00014040
description	wash arm support		
For models:	D30, D35, D40, D40ELT, D40ELT-BT-BA, D40i, D40i-BT-BA, D40i-ELT-BT-BA		

			
1			
Part No.	511736	Ref. No.	00014055
description	wash arm support		
For models:	BD50, BE50, BE50T, D36, D45, D80		

			
1			
Part No.	511036	Ref. No.	00004260 00011152
description	wash arm support mounting pos. lower		
For models:	882, 885, SQ885, SQT80		

			
1			
Part No.	511038	Ref. No.	00011195
description	wash arm support mounting pos. lower		
For models:	120, 160, 240, 906, 908		





			
1			
Part No.	511721	Ref. No.	00211014
description	wash arm support mounting pos. lower		
For models:	B11, B15, BD11, BD13, BD14, BD22, BD46, BE35, BE40		

			
1			
Part No.	511740	Ref. No.	00018063
description	wash arm support mounting pos. lower		
For models:	C34, C34dgt, C44, C44dgt, C44dgt-elt, C66, C66dgt, C66dgt-elt, C77, CE24, D120, D120dgt		

			
1			
Part No.	511710	Ref. No.	00011851
description	wash arm support mounting pos. upper		
For models:	BD13, BD14, BD14alt, BD22, BD46, BD47, BD50, BE40, BE50, BE50T, C33, CW650-15, CW650-16, CW650-35, CW650-36, D30, D35, D36, D40, D40ELT, D40ELT-BT-BA, D40i, D40i-BT-BA, D40i-ELT-BT-BA, D45, D80, D80F, D85		

			
1			
Part No.	511738	Ref. No.	00018062
description	wash arm support mounting pos. upper		
For models:	C34, C34dgt, C44, C44dgt, C44dgt-elt, C66, C66dgt, C66dgt-elt, C77, D120, D120dgt		

			
1			
Part No.	511784	Ref. No.	00014020 00014021
description	wash arm support mounting pos. upper		
For models:	60		

			
1			
Part No.	511035	Ref. No.	00004270
description	wash arm support thread 1 1/4" mounting pos. upper		

rinse arm shafts			
			
1			
Part No.	511039	Ref. No.	00011166
description	rinse arm shaft		
For models:	120, 160, 240, 42, 42E, 48, 48E, 55, 55E, 60, 906, 908		

knobs

producer-specific knobs

ELFRAMO			
			
1			
Part No.	110056	Ref. No.	00006500
description	knob switch zero mark ø 55mm shaft ø 5x5mm shaft flat horizontal black		
For models:	EB12, EB12+12, EB18P, EB6, EB6+6, EB8, EM12, EM12+12, EM20, EM20+20, EM20+20-900, EM20-900, EM35, EM40-900, ES12, ES20, ESD12, ESD20, FE12, FE20, FE20+20, FE30, FE30+30, KES20, KESD20, ST12, ST12+12, ST7, ST7+7		

handles and hand wheels

bracket handles

			
1			
Part No.	511100	Ref. No.	00001510 00009200
description	pull handle		

recessed handles

			
1			
Part No.	511889	Ref. No.	00205530
description	recessed handle L 213mm W 87mm H 27.5mm		
For models:	42, 42E, 48, 48E, 55, 55E, 60, B11, B15, BD11, BD13, BD14, BD14alt, BD46, BD47, BE35, BE40, EM12, EM12+12, EM20, EM20+20		





1

Part No.	511890	Ref. No.	00010610
description	recessed handle L 292mm W 86mm H 27.5mm		
For models:	120, 160, 240, 882, 885, BD22, BD50, BE50, BE50T, D120, D120dgt, D30, D35, D36, D40, D40ELT, D40ELT-BT-BA, D40i, D40i-BT-BA, D40i-ELT-BT-BA, D45, D80, D80F, D85		

equipment feet and end caps

screw-in feet



1

Part No.	695604	Ref. No.	00000970 00000980 00013783
description	equipment foot thread M10 thread L 32mm ø 50mm H 14mm		
For models:	882, 885, BD14, BD14alt, BD22, BD46, BD47, C33, C44, C66, D30, D35, D36, D40, D40ELT, D40ELT-BT-BA, D40i, D40i-BT-BA, D40i-ELT-BT-BA, D45, D80, EB12, EB12+12, EB18P, EB6, EB6+6, EB8, EM12, EM12+12, EM20, EM20+20, EM20+20-900, EM20-900, EM35, EM40-900, ET, ET020, ETA, ETE20, ETE21, ETE25, ETE27, ETS15, GM12, GM12+12, GM20+20, GM20+20-900, GM25+25-900, GM25-900, GM35...(Other models you can see in the webshop)		



1

Part No.	695601	Ref. No.	00206960
description	equipment foot thread M17 thread L 23mm ø 24mm H 11mm plastic WS 24 Qty 1 pcs		
For models:	42, 42E, 48, 48E, 55, 55E, 60, B11, B15, BD11, BD13, BD50, BE35, BE40, BE50, BE50T, EB12, EB12+12, EB6, EB6+6, EB8		

baskets

warewashing baskets

steel wire baskets round

mix baskets

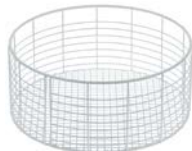

1

Part No.	970514	Ref. No.	00206731
description	mix basket ED ø 330mm H 145mm seat ømm		
For models:	42, 42E, 48, 48E, 55, 55E, B11, BD11, BE35		



1

Part No.	970515	Ref. No.	00007400
description	mix basket ED ø 440mm H 145mm seat ø 445mm		
For models:	120, 160, 240, 42, 42E, 48, 48E, 55, 55E, 882, 885, 904, 906, 908, 912, BD22, SQ885, SQT80		



1

Part No.	970516	Ref. No.	00007420
description	mix basket ED ø 500mm H 125mm seat ø 445mm		
For models:	120, 160, 240, 882, 885, 904, 906, 908, 912		

plate baskets



1

Part No.	970513	Ref. No.	00007320
description	plate basket ED ø 495mm H 120mm seat ø 445mm plates 18		
For models:	120, 160, 240, 882, 885, 904, 906, 908, 912		

steel wire baskets octagonal

mix baskets



1

Part No.	970068 ¹	Ref. No.	00206712	
description	mix basket L 400mm W 400mm H 170mm			
For models:	42, 42E, 48, 48E, 55, 55E, B15, BD13, BD14, BD46, BD47			
spare parts for	970068			
	Part No.	970001	Ref. No.	—
	sliding corner wire gauge ø 5mm L 120mm W 120mm H 12mm L-shape			

¹wide-meshed



1

Part No.	971049 ¹	Ref. No.	00206713 X098E006/710
description	mix basket L 460mm W 460mm		
For models:	42, 42E, 48, 48E, 55, 55E, 60, BD22		

¹wide-meshed

1

Part No.	970074 ¹	Ref. No.	00007120
description	mix basket L 500mm W 500mm H 130mm mesh type close-meshed		
For models:	120, 160, 240, 882, 885, 904, 906, 908, 912, BD50, BE50, BE50T, C33, C34, C34dgt, C44, C44dgt, C44dgt-elt, C66, C66dgt, C66dgt-elt, CE24, D30, D35, D36, D40, D40ELT, D40ELT-BT-BA, D40i, D40i-BT-BA, D40i-ELT-BT-BA, D45, D80, D85, SQ885, SQT80		

¹fine-meshed

1

Part No.	970027 ¹	Ref. No.	00007140
description	mix basket L 550mm W 550mm H 125mm mesh type close-meshed		
For models:	120, 160, 240, 882, 885, 904, 906, 908, 912, C77, D120, D120dgt		

¹fine-meshed

plate baskets



1

Part No.	971051	Ref. No.	00007000
description	plate basket L 470mm W 470mm H 100mm plates 16 plate ø 240mm		
For models:	120, 160, 240, 42, 42E, 48, 48E, 55, 55E, 60, 882, 885, 904, 906, 908, 912, BD22		



1

Part No.	971043	Ref. No.	00007020 00007040
description	plate basket L 500mm W 500mm H 130mm plates 20 plate ø 240mm		
For models:	120, 160, 240, 882, 885, 904, 906, 908, 912, BD50, BE50, BE50T, C33, C34, C34dgt, C44, C44dgt, C44dgt-elt, C66, C66dgt, C66dgt-elt, CE24, D30, D35, D36, D40, D40ELT, D40ELT-BT-BA, D40i, D40i-BT-BA, D40i-ELT-BT-BA, D45, D80, D85, SQ885, SQT80		



1

Part No.	970026	Ref. No.	00007060 X098E012/706
description	plate basket L 550mm W 550mm H 130mm plates 24 plate ø 270mm		
For models:	120, 160, 240, 882, 885, 904, 906, 908, 912, C77, D120, D120dgt		

glass basket



1

Part No.	971052	Ref. No.	00206720
description	glass basket L 470mm W 470mm H 150mm number of rows 3 rows spacing 145mm		
For models:	42, 42E, 48, 48E, 55, 55E, 60, BD22		

plastic baskets octagonal

mix baskets



1

Part No.	971058	Ref. No.	00206701
description	mix basket L 350mm W 350mm H 150mm		
For models:	BE35		

accessories

cutlery inserts



1

Part No.	976011	Ref. No.	00206721
description	cutlery insert Lmm Wmm ø 110mm H 130mm		

plate inserts



1

Part No.	970047	Ref. No.	00007200 00206751 00206752
description	plate insert L 308mm W 100mm plates 15		
For models:	120, 160, 240, 42, 42E, 48, 48E, 55, 55E, 60, 882, 885, 904, 906, 908, 912, B11, B15, BD11, BD13, BD14, BD22, BD46, BD47, BD50, BE35, BE40, BE50, BE50T, C33, C34, C34dgt, C44, C44dgt, C44dgt-elt, C66, C66dgt, C66dgt-elt, C77, CE24, D120, D120dgt, D30, D35, D36, D40, D40ELT, D40ELT-BT-BA, D40i, D40i-BT-BA...(Other models you can see in the webshop)		



gaskets

O-rings

EPDM

ø1.78mm

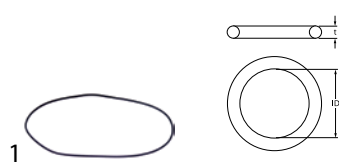

Part No.	521717	Ref. No.	00000290 00002900 06140008 06140140
description	O-ring EPDM thickness 1.78mm ID ø 120.37mm Qty 1 pcs		
For models:	42, 42E, 48, 48E, 55, 55E, 60, 882, 885, BD22, C33, C34, C34dgt, D30, D35, D36, D40, D40ELT, D40ELT-BT-BA, D40i, D40i-BT-BA, D40i-ELT-BT-BA, D45, D80, D80F, D85, SQ885, SQT80		

ø2.62mm

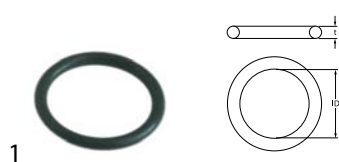

Part No.	528919	Ref. No.	00004480 06140005
description	O-ring EPDM thickness 2.62mm ID ø 20.24mm Qty 1 pcs		
For models:	42, 42E, 48, 48E, 55, 55E, 60, 882, 885, B11, BD11, BE35, SQ885, SQT80		



Part No.	505073	Ref. No.	06140005
description	O-ring EPDM thickness 2.62mm ID ø 20.63mm Qty 1 pcs		



Part No.	510769	Ref. No.	06140004
description	O-ring EPDM thickness 2.62mm ID ø 25.07mm Qty 1 pcs		
For models:	B11, B15, BD13, BD14, BD14alt, BD46, BD47, BE35, C44, C44dgt, C44dgt-elt, C66, C66dgt, C66dgt-elt, C77, D40, D40ELT, D40ELT-BT-BA, D40i-ELT-BT-BA, D45		



Part No.	521154	Ref. No.	06140046
description	O-ring ID ø 152.7mm thickness 2.62mm EPDM Qty 1 pcs		
For models:	C66dgt		

ø3.53mm

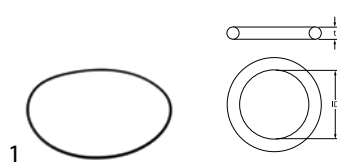

Part No.	521718	Ref. No.	00002910 06140010
description	O-ring EPDM thickness 3.53mm ID ø 164.7mm Qty 1 pcs		
For models:	120, 160, 906, 908, C44, C44dgt, C44dgt-elt, C66, C66dgt, C66dgt-elt, C77, D120, D120dgt, EN, ET, ET020, ETA, ETE20, ETE21, ETE25, ETE27, ETS15		



Part No.	532451	Ref. No.	06140028
description	O-ring EPDM thickness 3.53mm ID ø 53.98mm Qty 1 pcs		
For models:	ETE20, ETE21, ETE25, ETE27, ETS15		



Part No.	511828	Ref. No.	06140018
description	O-ring EPDM thickness 3.53mm ID ø 56.74mm Qty 1 pcs		
For models:	B11, B15, BD11, BD13, BD14, BD14alt, BD22, BD46, BD47, BD50, BE35, BE40, BE50, BE50T, C33, C34, C34dgt, C44, C44dgt, C44dgt-elt, C66, C66dgt, C66dgt-elt, C77, CE24, CW650-15, CW650-16, CW650-35, CW650-36, D120, D120dgt, D30, D35, D36, D40, D40ELT, D40ELT-BT-BA, D40i, D40i-BT-BA, D40i-ELT-BT-BA, D45, D80, D80F, D85, ETE20, ETE21, ETE25, ETE27, ETS15, LP60...(Other models you can see in the webshop)		



Part No.	511711	Ref. No.	06140026
description	O-ring EPDM thickness 3.53mm ID ø 78.97mm Qty 1 pcs		
For models:	B11, B15, BD11, BD13, BD14, BD14alt, BD22, BD46, BD47, BD50, BE35, BE40, BE50, BE50T, C33, C34, C34dgt, C44, C44dgt, C44dgt-elt, C66, C66dgt, C66dgt-elt, C77, CW650-15, CW650-16, CW650-35, CW650-36, D120, D120dgt, D30, D35, D36, D40, D40ELT, D40ELT-BT-BA, D40i, D40i-BT-BA, D40i-ELT-BT-BA, D45, D80, D80F, D85		

ø5.34mm

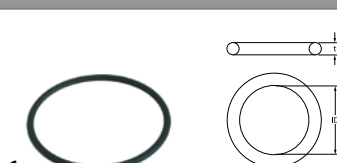

Part No.	505178	Ref. No.	06140035
description	O-ring EPDM thickness 5.34mm ID ø 85.09mm Qty 1 pcs		
For models:	ETE20, ETE21, ETE25, ETE27, ETS15		

mechanical components, equipment accessories



sealing washers

fibre gaskets



1

Part No.	506042	Ref. No.	06110006 06120004
description	flat gasket FIBER ED ø 27mm ID ø 17mm thickness 2mm Qty 1 pcs		
For models:	C34dgt, C44, C44dgt, C66, C66dgt, C77, CE24, D120, D120dgt, LP130		



1

Part No.	511490	Ref. No.	06120001
description	flat gasket fibre ED ø 15mm ID ø 8mm thickness 2mm Qty 1 pcs		
For models:	B11, B15, BD11, BD13, BD14, BD14alt, BD22, BD47, BE35, BE40, BE50, C33, C34, C34dgt, C44, C44dgt, C44dgt-elt, C66, C66dgt, C66dgt-elt, C77, CE24, CW650-15, CW650-16, CW650-35, CW650-36, D120, D30, D40, D40ELT, D40ELT-BT-BA, D40i-BT-BA, D40i-ELT-BT-BA, D80, D80F, D85, LP130		

plastic gaskets



1

Part No.	696375	Ref. No.	00010504
description	gasket plastic ED ø 19mm ID ø 10.5mm thickness 6mm for boiler Qty 1 pcs		
For models:	B11, BD11, BD13, BD14, BD14alt, BD22, BD46, BD47, BD50, BE35, BE40, BE50, BE50T, C33, C34, C34dgt, C44, C44dgt, C44dgt-elt, C66, C66dgt, C66dgt-elt, C77, CE24, D120, D120dgt, D30, D35, D36, D40, D40ELT, D40ELT-BT-BA, D40i, D40i-ELT-BT-BA, D45, D80, D80F, D85, GFP25, GFP25AC, GFU25, GFU25AC, LP130, LP61, LP61H, LP70		

copper gaskets

DIN-7603-A



1

Part No.	560523	Ref. No.	02150006
description	flat gasket nickel-plated copper ED ø 18.5mm ID ø 12.2mm thickness 2mm Qty 1 pcs		
For models:	BD46, BD47, BD50, BE40, BE50, C33, C34, C34dgt, C44, C66, C77, D120, D35, D36, D40i, D40i-BT-BA, D40i-ELT-BT-BA, D45, D80, D85		

PTFE gaskets



1

Part No.	511589	Ref. No.	06112001
description	flat gasket PTFE ED ø 11mm ID ø 4.5mm thickness 2mm Qty 1 pcs		
For models:	BD13, BD14, BD46, BD47, BD50, BE35, BE40, BE50, C33, C34, C34dgt, C44, C44dgt, C44dgt-elt, C66, C66dgt, C66dgt-elt, C77, D120, D120dgt, D35, D36, D40, D40i, D40i-ELT-BT-BA, D45, D80, D85, GFP25, GFP25AC, GFU25, GFU25AC		

transmission technology and ball bearings

ball bearings

deep-groove ball bearings 2RS



1

Part No.	523528	Ref. No.	09100013
description	deep-groove ball bearing type 6007-2RS shaft ø 35mm ED ø 62mm W 14mm with sealing discs deep-groove ball bearing DIN 625-1		
For models:	ETE20, ETE21, ETE25, ETE27, ETS15		

miscellaneous



1

Part No.	507393	Ref. No.	09100004
description	ball bearing shaft ø 10mm ED ø 26mm W 13mm		

springs

compression springs



1

Part No.	511117	Ref. No.	0000235A 00073718
description	compression spring ø 14.2/8.1mm L 53mm wire gauge ø 1.2mm cone-shaped		



roller springs

roller springs



Part No.	511116	Ref. No.	00002301 0000230A
description	roller spring mounting pos. left complete		
spare parts for	511116		
	Part No.	511622	Ref. No. 00002310
	roller spring mounting pos. right/left W 40mm		



Part No.	519550	Ref. No.	00079740
description	roller spring W 25.35mm		
For models:	ETE20, ETE21, ETE25, ETE27		



Part No.	519491	Ref. No.	00079730
description	roller spring W 26mm		
For models:	ETE20, ETE21, ETE25, ETE27, ETS15, LP130, LP60H, LP61H, LP70		



Part No.	519543	Ref. No.	00065816
description	roller spring with holder W 46mm ID 0mm lug lengthmm		
For models:	LP130, LP60, LP60H, LP61, LP61H		

tension springs



Part No.	361593	Ref. No.	00000812
description	spring		



Part No.	511904	Ref. No.	00013717
description	tension spring ø 15.1mm total length 148mm wire gauge ø 1.7mm		
For models:	BD14, BD46, BD47, D36, D40, D40i, D40i-ELT-BT-BA, D45, D80, D85, ET, ETE20, ETE21, ETE25, ETE27, ETS15		



Part No.	511216	Ref. No.	00018056
description	tension spring ø 25mm total length 790mm wire gauge ø 5mm L1 120mm L2 580mm D1 ø 23mm thread M8 thread L 90mm mounting pos. left/right for hood		
For models:	C34, C34dgt, C44, C44dgt, C44dgt-elt, C66, C66dgt, C66dgt-elt, C77, CE24		

dosing pumps

peristaltic dosing pumps

SEKO

built-in version

with frequency control



Part No.	362025	Ref. No.	20155111
description	dosing pump SEKO frequency control 0.3-3.0l/h 230VAC detergent hose ø 4x6mm hose Santoprene type NBR 3 with accessories angled 90°		
For models:	B11, BD11, BD13, BD14, BD22, BD46, BD47, BD50, BE35, BE40, BE50, BE50T, C33, C34, C34dgt, C44, C44dgt, C44dgt-elt, C66, C66dgt, C66dgt-elt, C77, CW650-15, CW650-16, CW650-35, CW650-36, D120, D120dgt, D30, D35, D36, D40, D40ELT, D40ELT-BT-BA, D40i, D40i-ELT-BT-BA, D45, D80, D80F, D85, EN, ET, ETS15, LP130, LP60, LP60H, LP61, LP61H, LP70		



Part No.	361215	Ref. No.	20155100 20155111 old version
description	dosing pump SEKO frequency control 0.3-3.0l/h 230VAC detergent hose ø 4x6mm hose type K hose Santoprene suction level 1.5m type PBR protection IP55 dimensions 100x67x68mm power input 3.5W		
For models:	42, 42E, 48, 48E, 55, 55E, 60, B11, B15, BD11, BD13, BD14, BD14alt, BD22, C33, C44, C66, D120, D30, D40, D80, D80F, LP130, LP60, LP70		







spare parts for	361215		
	Part No.	361136	Ref. No. —
	roller assembly for dosing pump hole ø 4.8x4mm		





Table continues overleaf



spare parts for 361215			
	Part No.	361226	Ref. No. —
PCB L 59mm W 26mm electronic control			
	Part No.	361815	Ref. No. 20155112
pump hose detergent hose ø 6x10mm hose ø 4x6mm hose type K hose Santoprene type SEKO			
accessories for 361215			
	Part No.	361142	Ref. No. —
mounting set detergent hose type 4x6mm hose length 2m PVC 2x hose/container filter/tank intake transparent			
	Part No.	520090	Ref. No. 07125002
PVC hose ID ø 4mm ED ø 6mm L 2m thickness 1mm t.max. 60°C transparent			
	Part No.	520091	Ref. No. 20155110
nylon hose ID ø 4mm ED ø 6mm L 2m thickness 1mm operating p. 10bar burst p. 50bar t.max. 100°C transparent			



with time control





Part No.	361768 ¹	Ref. No.	00220423 old version 20155104 old version
description	dosing pump SEKO time control 0.4l/h 230VAC rinse aid hose ø 4x6mm hose type D hose Sekobril suction level 1.5m type NBM 0.4 8W with accessories 8VA dosing time 0-30s		
spare parts for 361768			
	Part No.	361135	Ref. No. 20155109
pump hose SEKO rinse aid hose ø 3x8mm hose ø 4x6mm hose type D hose Sekobril			
	Part No.	361141	Ref. No. 20155105
container filter with weight ceramic hose ø 4mm			
	Part No.	361821	Ref. No. 00220419
non-return valve inlet 4x6mm outlet 1/4" L 45mm			
	Part No.	520091	Ref. No. 20155110
nylon hose ID ø 4mm ED ø 6mm L 2m thickness 1mm operating p. 10bar burst p. 50bar t.max. 100°C transparent			
	Part No.	520242	Ref. No. —
silicone hose for peristaltic pump ID ø 4mm ED ø 7mm L 5m thickness 1.5mm t.max. 200°C Shore A 55° transparent dosing Qty 5m			

¹with accessories

			
Part No.	362024	Ref. No.	20155104 20155104 new version
description	dosing pump SEKO time control 0.4l/h 230VAC rinse aid hose ø 4x6mm hose type Sekobril type NBM 0.4 with accessories angled 90°		
For models:	B11, B15, BD11, BD13, BD14, BD14alt, BD22, BD46, BD47, C33, C44, C44dgt, C44dgt-elt, C66, C66dgt, C66dgt-elt, CW650-15, CW650-16, CW650-35, CW650-36, D120, D120dgt, D30, D36, D40, D40ELT, D45, D80, D80F, D85, LP130, LP60, LP60H, LP70		

spare parts			
			
			
Part No.	361815	Ref. No.	20155112
description	pump hose detergent hose ø 6x10mm hose ø 4x6mm hose type K hose Santoprene type SEKO		
For models:	B11, BD11, BD13, BD14, BD22, BD46, BD47, BD50, BE35, BE40, BE50, C33, C34, C34dgt, C44, C44dgt, C66, C66dgt, C77, CW650-15, CW650-16, CW650-35, CW650-36, D120, D120dgt, D30, D35, D36, D40, D40ELT, D40ELT-BT-BA, D40i, D40i-ELT-BT-BA, D45, D80, D80F, D85, EN, ET, ETE20, ETE21, ETE25, ETE27, ETS15, LP130, LP60, LP60H, LP61, LP61H, LP70		

			
Part No.	361135	Ref. No.	20155109
description	pump hose SEKO rinse aid hose ø 3x8mm hose ø 4x6mm hose type D hose Sekobril		
For models:	B11, BD11, BD13, BD14, BD22, BD46, BD47, C33, C34, C34dgt, C44, C44dgt, C66, C66dgt, CW650-15, CW650-16, CW650-35, CW650-36, D120, D120dgt, D30, D35, D36, D40, D40ELT, D45, D80, D80F, D85, EN, ET, ETE20, ETE21, ETE25, ETE27, ETS15, LP130, LP60, LP60H, LP70		
spare parts for 361135			
	Part No.	361866	Ref. No. —
union nut for hose connector ø 17mm			



membrane dosing pumps

self-priming

SEKO











1

Part No.	361594	Ref. No.	20155108
description	dosing pump type DIB3E rinse aid pump rate 0-3cm ³ per stroke pressure connection ø 4x6mm suction connection ø 4x6mm		
For models:	BD13, BD14, BD46, BD47, BD50, BE35, BE40, BE50, C33, C34, C34dgt, C44, C44dgt, C66, C66dgt, C77, D120, D30, D35, D36, D40, D40ELT, D40ELT-BT-BA, D40i, D40i-ELT-BT-BA, D45, D80, D85, LP130, LP60, LP60H, LP61, LP61H, LP70		
spare parts for	361594		
	Part No.	361240	Ref. No. —
	hose connector 1-way hose ø 6mm plastic connection M10x1		
	Part No.	361301	Ref. No. —
	hose connector for type DIB3E/DIB5E		
	Part No.	361302	Ref. No. —
	valve bush for type DIB3E/DIB5E		
	Part No.	361304	Ref. No. —
	O-ring EPDM ID ø 11.11mm thickness 1.78mm Qty 1 pcs for type DIB3E/DIB5E		
	Part No.	361305	Ref. No. —
	valve disc for type DIB3E/DIB5E DIB3P/DIB5P		
	Part No.	361306	Ref. No. —
	membrane for type DIB3E/DIB5E ø 49mm hole ø 5mm		
	Part No.	361481	Ref. No. —
	lip valve for type DIB3P/DIB5P DIB3E/DIB5E		



1

Part No.	361837 ¹	Ref. No.	2015511+00019656 20155117
description	dosing pump type DIB5E conversion kit rinse aid pump rate 0-5cm ³ per stroke pressure connection ø 4x6mm suction connection ø 6mm SEKO		
For models:	BD46, BD47, BE35, BE40, BE50, BE50T, C34, C44dgt, C44dgt-elt, C66dgt, C66dgt-elt, CE24, D120dgt, D36, D45, LP61, LP61H		
spare parts for	361837		
	Part No.	361301	Ref. No. —
	hose connector for type DIB3E/DIB5E		
	Part No.	361302	Ref. No. —
	valve bush for type DIB3E/DIB5E		
	Part No.	361304	Ref. No. —
	O-ring EPDM ID ø 11.11mm thickness 1.78mm Qty 1 pcs for type DIB3E/DIB5E		
	Part No.	361305	Ref. No. —
	valve disc for type DIB3E/DIB5E DIB3P/DIB5P		
	Part No.	361306	Ref. No. —
	membrane for type DIB3E/DIB5E ø 49mm hole ø 5mm		
	Part No.	361307	Ref. No. —
	membrane dosing pump ø 68mm hole ø 6mm for type DIB3P/DIB5P		
	Part No.	361481	Ref. No. —
	lip valve for type DIB3P/DIB5P DIB3E/DIB5E		
accessories for	361837		
	Part No.	361240	Ref. No. —
	hose connector 1-way hose ø 6mm plastic connection M10x1		
	Part No.	361241	Ref. No. —
	hose connector 1-way hose ø 9mm plastic connection M10x1		

¹auxiliary pressure connection closed

accessories

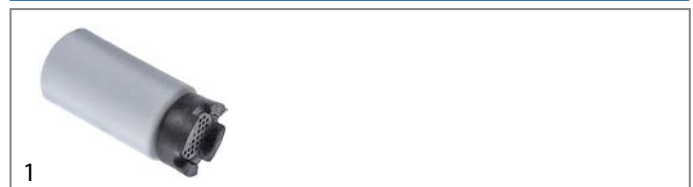



1

Part No.	361141	Ref. No.	20155105
description	container filter with weight ceramic hose ø 4mm		
For models:	B11, BD11, BD13, BD14, BD22, C33, C44, C66, CW650-15, CW650-16, CW650-35, CW650-36, D120, D30, D40, D40ELT, D80, D80F		











non-return valves

	1		
Part No.	361821	Ref. No.	00220419
description	non-return valve inlet 4x6mm outlet 1/4" L 45mm		
For models:	B11, BD13, BD22, BD46, BD47, C33, C34, C34dgt, C44, C44dgt, C44dgt-elt, C66, C66dgt, C66dgt-elt, C77, D120, D120dgt, D30, D35, D36, D40, D40ELT, D40ELT-BT-BA, D40i, D45, D80, D85, LP130, LP60, LP60H, LP61, LP61H, LP70		

	1		
Part No.	361147	Ref. No.	20155106
description	non-return valve inlet 4x6mm outlet 1/8" L 50mm Qty 1 pcs		
For models:	B11, BD11, BD13, BD14, BD22, C33, C44, C66, CW650-15, CW650-16, CW650-35, CW650-36, D120, D30, D40, D40ELT, D80, D80F, LP130, LP70		

hoses

PVC hoses



	1			
Part No.	520090	Ref. No.	07125002	
description	PVC hose ID ø 4mm ED ø 6mm L 2m thickness 1mm t.max. 60°C transparent			
For models:	B11, B15, BD11, BD13, BD14, BD14alt, BD22, BD50, BE35, BE40, BE50, C33, C34, C34dgt, C44, C66, C77, CE24, CW650-15, CW650-16, CW650-35, CW650-36, D120, D30, D35, D40, D40ELT, D40ELT-BT-BA, D40i, D40i-ELT-BT-BA, D80, D80F, EN, ET, ET020, ETA, ETE20, ETE21, ETE25, ETE27, ETS15, LP130, LP60, LP60H, LP61, LP61H, LP70			
accessories for	520090			
	Part No.	361058	Ref. No.	—
	container filter with non-return valve SS hose ø 4x6mm ø 20mm L 56mm			
	Part No.	361066	Ref. No.	—
	container filter straight SS hose ø 4x6mm L 37mm non return valve ball valve			
	Part No.	361106	Ref. No.	—
	container filter with weight and non-return valve SS hose ø 4x6mm ø 21mm L 51mm non return valve lip valve			
	Part No.	361141	Ref. No.	20155105
	container filter with weight ceramic hose ø 4mm			
	Part No.	361230	Ref. No.	—
	container filter with weight stainless steel hose ø 4x6mm			
	Part No.	361462	Ref. No.	—
	container filter with weight SS hose ø 4x6mm			
	Part No.	361728	Ref. No.	—
	container filter with 4m 4x6 hose SS hose ø 4x6mm hose length 4000mm			



hoses

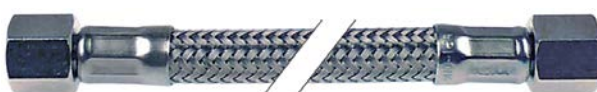

supply hoses

stainless steel flexi hoses

universal hoses

	1		
			
Part No.	520627	Ref. No.	00053360
description	flex hose SS braid straight-straight DN12 connections 3/4" L 2000mm approval DVGW operating p. 10bar test pressure 32bar burst p. 95bar		
For models:	EN, ET, ETA		

	1		
			
Part No.	520459	Ref. No.	00003530
description	flex hose SS braid straight-straight DN8 connections 3/8"-1/2" L 740mm approval DVGW operating p. 10bar test pressure 32bar burst p. 95bar		
For models:	CW650-15, CW650-16, CW650-35, CW650-36, LP70		

	1		
			
Part No.	520007	Ref. No.	336A
description	flex hose SS braid straight-curved DN15 connection 1: 3/4" connection 2: 3/4" L 2500mm approval operating p. 10bar test pressure 32bar burst p. 95bar		

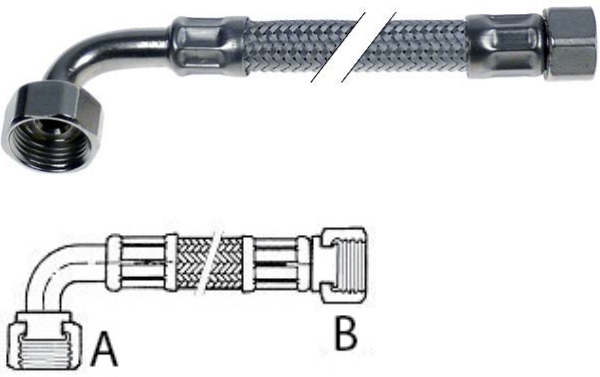
Part No.	520468	Ref. No.	12160008
description	flex hose SS braid straight-curved DN8 connection 1: 1/2" connection 2: 3/8" L 350mm approval DVGW operating p. 10bar test pressure 32bar burst p. 95bar		
For models:	BE35, BE40		

PVC supply hoses



Part No.	520010	Ref. No.	00200720 07130001 07130002
description	supply hose PVC straight-curved DN13 connections 3/4" L 1500mm operating p. 10bar burst p. 32bar t.max. 90°C blue approval VDE flat seal		
For models:	120, 160, 240, 42, 42E, 48, 48E, 55, 55E, 60, 882, 885, 904, 906, 908, 912, B11, B15, BD11, BD13, BD14, BD14alt, BD22, BD46, BD47, BD50, BE35, BE40, BE50, BE50T, C33, C34, C34dgt, C44, C44dgt, C44dgt-elt, C66, C66dgt, C66dgt-elt, C77, CE24, D120, D120dgt, D30, D35, D36, D40, D40ELT, D40ELT-BT-BA, D40i...(Other models you can see in the webshop)		
accessories for	520010		
	Part No.	520053	Ref. No. —
	screen connection 3/4" D1 ø 26mm D2 ø 15mm Qty 10 pcs rubber thickness 8mm		
	Part No.	520054	Ref. No. —
	flat gasket rubber ED ø 23.5mm ID ø 14mm thickness 2.3mm Qty 10 pcs		

drain hoses



Part No.	511206	Ref. No.	07130157
description	drain hose		
For models:	42, 42E, 48, 48E, 55, 55E, 60, B11, BD11, BD13, BD14, BD22, BD50, BE35, BE40, BE50, BE50T, D30, D35, D36, D40, D40ELT, D40ELT-BT-BA, D40i, D40i-ELT-BT-BA, D45, D80		



Part No.	513718	Ref. No.	00003630 00003640 00200652 00200653
description	drain hose DN19 L 1500mm straight ø inside 24mm straight ext. ø 28mm outer hose ø 23mm		



Part No.	511205	Ref. No.	00000364 07130156
description	drain hose DN19 L 1500mm A int. ø 23mm A ext. ø 29mm B int. ø 29mm outer hose ø 29mm B ext. ø 35mm		



Part No.	530608	Ref. No.	00003630 00003640 00200652 00200653 07130155 07130156
description	drain hose DN24 L 1500mm A int. ø 24mm A ext. ø 28mm B int. ø 28mm B ext. ø 35mm outer hose ø 29mm temp.-resist. 90°C		
For models:	120, 160, 240, 42, 42E, 48, 48E, 55, 55E, 60, 882, 885, 906, 908, B11, B15, BD11, BD13, BD14, BD14alt, BD22, BD46, BD47, BD50, BE35, BE40, BE50, BE50T, C33, C34, C34dgt, C44, C44dgt, C44dgt-elt, C66, C66dgt, C66dgt-elt, C77, D120, D120dgt, D30, D35, D36, D40, D40ELT, D40ELT-BT-BA, D40i, D40i-BT-BA, D40i-ELT-BT-BA, D45...(Other models you can see in the webshop)		



Part No.	530399	Ref. No.	07130158
description	drain hose DN31 L 2000mm A int. ø 33mm A ext. ø 39mm B int. ø 33mm B ext. ø 39mm outer hose ø 35mm		
For models:	C33, C34, C34dgt, C44, C44dgt, C44dgt-elt, C66, C66dgt, C66dgt-elt, C77, CE24, CW650-15, CW650-16, CW650-35, CW650-36, D120, D120dgt, D30, D40, D80, D80F, D85, LP60, LP60H, LP61, LP61H		



industrial hoses

nylon hoses



Part No.	520091	Ref. No.	20155110
description	nylon hose ID \varnothing 4mm ED \varnothing 6mm L 2m thickness 1mm operating p. 10bar burst p. 50bar t.max. 100°C transparent		
For models:	B11, BD11, BD13, BD14, BD22, C33, C44, C66, CW650-15, CW650-16, CW650-35, CW650-36, D120, D30, D40, D40ELT, D80, D80F		

PVC hoses

PVC hoses without fabric



Part No.	520090	Ref. No.	07125002
description	PVC hose ID \varnothing 4mm ED \varnothing 6mm L 2m thickness 1mm t.max. 60°C transparent		
For models:	B11, B15, BD11, BD13, BD14, BD14alt, BD22, BD50, BE35, BE40, BE50, C33, C34, C34dgt, C44, C66, C77, CE24, CW650-15, CW650-16, CW650-35, CW650-36, D120, D30, D35, D40, D40ELT, D40ELT-BT-BA, D40i, D40i-ELT-BT-BA, D80, D80F, EN, ET, ET020, ETA, ETE20, ETE21, ETE25, ETE27, ETS15, LP130, LP60, LP60H, LP61, LP61H, LP70		
accessories for	520090		
	Part No.	361058	Ref. No. —
	container filter with non-return valve SS hose \varnothing 4x6mm \varnothing 20mm L 56mm		
	Part No.	361066	Ref. No. —
	container filter straight SS hose \varnothing 4x6mm L 37mm non return valve ball valve		
	Part No.	361106	Ref. No. —
	container filter with weight and non-return valve SS hose \varnothing 4x6mm \varnothing 21mm L 51mm non return valve lip valve		
	Part No.	361141	Ref. No. 20155105
	container filter with weight ceramic hose \varnothing 4mm		
	Part No.	361230	Ref. No. —
	container filter with weight stainless steel hose \varnothing 4x6mm		
	Part No.	361462	Ref. No. —
	container filter with weight SS hose \varnothing 4x6mm		
	Part No.	361728	Ref. No. —
	container filter with 4m 4x6 hose SS hose \varnothing 4x6mm hose length 4000mm		

silicone hoses

without fabric



Part No.	530410	Ref. No.	00003750 00011065
description	silicone hose ID \varnothing 4mm ED \varnothing 7mm L 2m thickness 1.5mm t.max. 200°C transparent		
For models:	120, 160, 240, 42, 42E, 48, 48E, 55, 55E, 60, 882, 885, 904, 906, 908, 912, B11, BD11, BD13, BD14, BD22, BD46, BD47, BD50, BE35, BE40, BE50, BE50T, C33, C34, C34dgt, C44, C44dgt, C44dgt-elt, C66, C66dgt, C66dgt-elt, C77, D120, D120dgt, D30, D35, D36, D40, D40ELT, D40ELT-BT-BA, D40i, D40i-BT-BA, D45, D80...(Other models you can see in the webshop)		

formed hoses

straight



Part No.	511048	Ref. No.	00004060 00072970 00200671 00200676 00200678
description	formed hose dishwasher straight equiv. no. 00004060		
For models:	120, 160, 42, 42E, 48, 48E, 55, 55E, 906, 908, C34, C44, C44dgt, C44dgt-elt, C66, C66dgt, C66dgt-elt, C77, CE24, D120, D120dgt, EN, ET, ET020, ETA, ETE20, ETE21, ETE25, ETE27		



Part No.	511858	Ref. No.	00013827 00222217
description	formed hose dishwasher straight equiv. no. 00013827		
For models:	BD22, C33, CW650-15, CW650-16, CW650-35, CW650-36, D30, D35, D36, D40, D40ELT, D40ELT-BT-BA, D40i, D40i-BT-BA, D40i-ELT-BT-BA, D45, D80, D80F, D85		

form L



Part No.	511050	Ref. No.	00004070 00065552
description	formed hose end piece A int. \varnothing 50mm \varnothing end piece B 70mm L 190mm warewashing L-shape equiv. no. 00004070		
For models:	240, LP60, LP60H, LP61, LP61H		



Part No.	511140	Ref. No.	00010540
description	formed hose warewashing L-shape equiv. no. 00010540		
For models:	120, 160		



with branch



1

Part No.	511859	Ref. No.	00013718
description	formed hose warewashing equiv. no. 00013718 with piggyback		
For models:	BD50, BE50, BE50T, C33, CW650-15, CW650-16, CW650-35, CW650-36, D30, D35, D36, D40, D40ELT, D40ELT-BT-BA, D40i, D40i-BT-BA, D40i-ELT-BT-BA, D45, D80, D80F, D85		



1

Part No.	511056	Ref. No.	00206911
description	formed hose warewashing with piggyback		
For models:	42, 42E, 48, 48E, 55, 55E		



1

Part No.	511057	Ref. No.	00206912
description	formed hose warewashing with piggyback		
For models:	42, 42E, 48, 48E, 55, 55E		



1

Part No.	511058	Ref. No.	00206909
description	formed hose warewashing with piggyback		
For models:	42, 42E, 48, 48E, 55, 55E, 60		



1

Part No.	511857	Ref. No.	00210956 00222108
description	pressure hose		
For models:	B11, B15, BD11, BD13, BD14, BD14alt, BD46, BD47, BE35		

form S



1

Part No.	517498	Ref. No.	00018312
description	formed hose hose ext. ø 78mm hose int. ø 63mm L 310mm S-shape		
For models:	C44, C44dgt, C44dgt-elt, C66, C66dgt, C66dgt-elt, C77, D120, D120dgt		



1

Part No.	511856	Ref. No.	00222109
description	formed hose S-shape warewashing equiv. no. 00222109		
For models:	BD14, BD14alt, BD47, BE35		



miscellaneous



1

Part No.	511047	Ref. No.	00004110
description	formed hose warewashing equiv. no. 00004110		

for dishwashers

miscellaneous



1

Part No.	511467	Ref. No.	00003520 00013411
description	pressure hose L 1000mm		



1

Part No.	511464	Ref. No.	00013340
description	pressure hose L 480mm ø 18mm		

fittings, hose and pipe connectors

fittings

T-pieces

miscellaneous



1

Part No.	511499	Ref. No.	00000350
description	T-piece thread 3/8" brass L 58mm		

hose connectors

producer-specific



1

Part No.	511071	Ref. No.	00002140
description	hose connector for drain		

valves and tank inlets

ball valves

producer-specific

ELFRAMO



1

Part No.	542254	Ref. No.	131110001
description	ball valve connection 1" IT - tube ø25mm handle length without handle L 67mm		

water cycle components

pressure reduction valves

pressure reduction valves

universal



1

Part No.	520871	Ref. No.	00074380 23200001 23200002
description	pressure reduction valve MALGORANI series Eurobrass 143 connection 1/2" default setting bar setting range 0.5-6bar p max 25bar t.max. 80°C brass		
For models:	EN, ET, ET020, ETA, ETE20, ETE21, ETE25, ETE27, ETS15		

supply filters



1

Part No.	511485	Ref. No.	00000348 00003480 00003481
description	T-piece thread 1/2" -3/4" brass with filter H 100mm L 175mm		



ancillary products

clamps

hose clamps

DIN 3017 - W2



1

Part No.	520116	Ref. No.	05100011
description	hose clamp ø 32-50mm width 9mm Qty 5 pcs DIN 3017		
For models:	D30, D80, ET, ET020, ETA		



1

Part No.	520118	Ref. No.	00004051 05100002 05100004
description	hose clamp ø 50-70mm width 9mm Qty 5 pcs DIN 3017		
For models:	120, 160, 42, 42E, 48, 48E, 55, 55E, 60, 882, 885, 906, 908, B11, B15, BD11, BD13, BD14, BD14alt, BD22, BD50, BE35, BE40, BE50, BE50T, C33, C34, C34dgt, C44, C44dgt, C44dgt-elt, C66, C66dgt, C66dgt-elt, C77, CE24, CW650-15, CW650-16, CW650-35, CW650-36, D120, D120dgt, D30, D35, D36, D40, D40ELT, D40ELT-BT-BA, D40i, D40i-BT-BA...(Other models you can see in the webshop)		



1

Part No.	520454	Ref. No.	00004072 0000407B 05100008
description	hose clamp ø 70-90mm width 9mm Qty 5 pcs DIN 3017		
For models:	120, 160, 240, 908, BD13, BD14, BD46, BD47, BE50, C33, C34, C34dgt, C44, C44dgt, C44dgt-elt, C66, C66dgt, C66dgt-elt, C77, CE24, D120, D120dgt, D35, D40, D40ELT, D40ELT-BT-BA, D40i, D40i-BT-BA, D40i-ELT-BT-BA, D80, EN, ET, ET020, ETA, LP130, LP60, LP60H, LP61, LP61H, LP70, LPE100, LPE145		



1

Part No.	520110	Ref. No.	05100006 376A
description	hose clamp ø 8-12mm width 9mm Qty 10 pcs DIN 3017		
For models:	120, 160, 240, 42, 42E, 48, 48E, 55, 55E, 60, 882, 885, 904, 906, 908, 912, C33, C44, C66, D30, E1200, E500, E700, EC1200, EC800, ES400, ES400-alt, ES400-sehr-alt, LP60, MR1200, MR600, MR800, MRC1100, MRC1400, MRC800, MRS400, MRS400-alt, SQ885, SQT80		



1

Part No.	520117	Ref. No.	05100003
description	hose clamp stainless steel ø 40-60mm width 9mm Qty 5 pcs DIN 3017		
For models:	42, 42E, 48, 48E, 55, 55E, 60, B11, BD11, BD13, BD14, BD14alt, BD22, BD46, BD47, BD50, BE35, BE40, BE50, BE50T, C33, CW650-15, CW650-16, CW650-35, CW650-36, D30, D35, D36, D40, D40ELT, D40ELT-BT-BA, D40i, D40i-BT-BA, D40i-ELT-BT-BA, D45, D80, D80F, D85, ETE20, ETE21, ETE25, ETE27, ETS15		

measuring equipment

thermometers

built-in thermometers



1

Part No.	541086	Ref. No.	32110003
description	thermometer mounting measurements 58x25.5mm 0 up to +120°C capillary pipe 2000mm probe ø 6mm probe L 23mm		
For models:	C44, C66, C77, D120, D40, D40i, D40i-BT-BA, D80, D80F		

ø52mm



1

Part No.	541065	Ref. No.	00006010 32100001
description	thermometer mounting ø 52mm t.max. 120°C 0 up to +120°C probe ø 6.5mm probe L 28mm capillary pipe 1500mm		
For models:	E1200, E500, E700, EC1200, EC800, LP100, LP145, LPE100, LPE145, MR1200, MR600, MR800, MRC1100, MRC1400, MRC800		

ø60mm



1

Part No.	541791	Ref. No.	00074420 32100003
description	thermometer mounting ø 60mm t.max. 120°C 0-120°C probe ø 6mm probe L 39mm capillary pipe 1500mm		
For models:	EN, ET, ET020, ETA		



fastening material

screws

countersunk screws



1

Part No.	560337	Ref. No.	01350001
description	countersunk screw thread M6 L 20mm WS 4 SS DIN 7991/ISO 10642 Qty 1 pcs intake hexagonal		
For models:	BD14, BD14alt, BD22, BD46, BD47, D36, D40, D40ELT, D40ELT-BT-BA, D40i, D40i-BT-BA, D40i-ELT-BT-BA, D45, D80, D80F, D85		

miscellaneous



1

Part No.	511494	Ref. No.	00000216 00002160
description	flat-headed bolt thread M5x0.8 thread L 7.8mm head ø 18mm intake slotted		
For models:	120, 160, 240, 42, 42E, 48, 48E, 55, 55E, 60, 882, 885, 904, 906, 908, 912, EG140S, EM-HT, EN, ET, ET020, ETA, SQ885, SQT80		



1

Part No.	519409	Ref. No.	00013785
description	screw		
For models:	BD14, BD14alt, BD22, BD46, BD47, D36, D40, D40ELT, D40ELT-BT-BA, D40i, D40i-BT-BA, D40i-ELT-BT-BA, D45, D80, D80F, D85		

nuts

hexagonal nuts

DIN 934 / ISO 4032/8673



1

Part No.	511212	Ref. No.	03100006
description	hexagonal nut thread M6 H 5mm WS 10 SS DIN/ISO DIN 934 / ISO 4032/8673 Qty 1 pcs		
For models:	42, 42E, 48, 48E, 55, 55E, 60, BD22, D30, D35, D36, D40, D40ELT, D40ELT-BT-BA, D40i, D40i-BT-BA, D40i-ELT-BT-BA, D45, FG12M, FG24M, GB10, GBD10		



1

Part No.	517174	Ref. No.	03100008
description	nut thread M8 H 6.5mm WS 13 SS DIN/ISO DIN 934 / ISO 4032/8673 Qty 1 pcs		
For models:	120, 160, 882, 885, 906, 908, C33, C34, C34dgt, C44, C44dgt, C44dgt-elt, C66, C66dgt, C66dgt-elt, C77, D120, D120dgt, D80, D80F, D85, EN, ET, ET020, ETA, ETE20, ETE21, ETE25, ETE27, ETS15		

washers

washers

DIN 125A



1

Part No.	560113	Ref. No.	02120006
description	plain washer ID ø 6.4mm ED ø 12mm thickness 1.6mm SS Qty 20 pcs DIN 125A for thread M6		
For models:	42, 42E, 48, 48E, 55, 55E, 60, BD14, BD14alt, BD22, D120, D30, D35, D36, D40, D40ELT, D40ELT-BT-BA, D40i, D40i-BT-BA, D40i-ELT-BT-BA, D45, D80		



1

Part No.	511481	Ref. No.	02120008
description	plain washer ID ø 8.4mm ED ø 16mm thickness 1.6mm zinc-coated steel Qty 1 pcs DIN 125A for thread M8		
For models:	B11, B15, BD11, BD13, BD14, BD22, C33, C34, C34dgt, D120, D120dgt, D30, D35, D40, D40ELT, D40ELT-BT-BA, D40i, D40i-BT-BA, D40i-ELT-BT-BA, D80, D80F, D85, EN, ETS15		

miscellaneous



1

Part No.	511591	Ref. No.	02160100
description	disc ID ø 16mm ED ø 20mm thickness 1.5mm brass Qty 1 pcs		
For models:	BD14, BD46, BD47, D36, D40, D40ELT, D40ELT-BT-BA, D40i, D40i-BT-BA, D40i-ELT-BT-BA, D45, D80, D80F, D85, ETS15		



fasteners

clamps

hose clamps

DIN 3017 - W2



Part No.	520116	Ref. No.	05100011
description	hose clamp ø 32-50mm width 9mm Qty 5 pcs DIN 3017		
For models:	D30, D80, ET, ET020, ETA		



Part No.	520118	Ref. No.	00004051 05100002 05100004
description	hose clamp ø 50-70mm width 9mm Qty 5 pcs DIN 3017		
For models:	120, 160, 42, 42E, 48, 48E, 55, 55E, 60, 882, 885, 906, 908, B11, B15, BD11, BD13, BD14, BD14alt, BD22, BD50, BE35, BE40, BE50, BE50T, C33, C34, C34dgt, C44, C44dgt, C44dgt-elt, C66, C66dgt, C66dgt-elt, C77, CE24, CW650-15, CW650-16, CW650-35, CW650-36, D120, D120dgt, D30, D35, D36, D40, D40ELT, D40ELT-BT-BA, D40i, D40i-BT-BA...(Other models you can see in the webshop)		



Part No.	520454	Ref. No.	00004072 0000407B 05100008
description	hose clamp ø 70-90mm width 9mm Qty 5 pcs DIN 3017		
For models:	120, 160, 240, 908, BD13, BD14, BD46, BD47, BE50, C33, C34, C34dgt, C44, C44dgt, C44dgt-elt, C66, C66dgt, C66dgt-elt, C77, CE24, D120, D120dgt, D35, D40, D40ELT, D40ELT-BT-BA, D40i, D40i-BT-BA, D40i-ELT-BT-BA, D80, EN, ET, ET020, ETA, LP130, LP60, LP60H, LP61, LP61H, LP70, LPE100, LPE145		



Part No.	520110	Ref. No.	05100006 376A
description	hose clamp ø 8-12mm width 9mm Qty 10 pcs DIN 3017		
For models:	120, 160, 240, 42, 42E, 48, 48E, 55, 55E, 60, 882, 885, 904, 906, 908, 912, C33, C44, C66, D30, E1200, E500, E700, EC1200, EC800, ES400, ES400-alt, ES400-sehr-alt, LP60, MR1200, MR600, MR800, MRC1100, MRC1400, MRC800, MRS400, MRS400-alt, SQ885, SQT80		



Part No.	520117	Ref. No.	05100003
description	hose clamp stainless steel ø 40-60mm width 9mm Qty 5 pcs DIN 3017		
For models:	42, 42E, 48, 48E, 55, 55E, 60, B11, BD11, BD13, BD14, BD14alt, BD22, BD46, BD47, BD50, BE35, BE40, BE50, BE50T, C33, CW650-15, CW650-16, CW650-35, CW650-36, D30, D35, D36, D40, D40ELT, D40ELT-BT-BA, D40i, D40i-BT-BA, D40i-ELT-BT-BA, D45, D80, D80F, D85, ETE20, ETE21, ETE25, ETE27, ETS15		

consumables

fuses

fine fuses

ø10x38mm 400V



Part No.	358041	Ref. No.	00060970
description	fine fuse size ø10x38mm 20A slow-acting rated 400V type aM Qty 1 pcs		
For models:	EN, ET, ET020, ETA, LPE100, LPE145		



Part No.	358030	Ref. No.	00060980
description	fine fuse size ø10x38mm 32A slow-acting rated 400V type aM Qty 1 pcs		
For models:	EN, ET, ET020, ETA, LPE100, LPE145		

ø10x38mm 500V



Part No.	358038	Ref. No.	00060960 37130999
description	fine fuse size ø10x38mm 10A slow-acting rated 500V type aM Qty 1 pcs		
For models:	120, 160, 240, 882, 885, 904, 906, 908, 912, CW650-15, CW650-16, CW650-35, CW650-36, Cybergel, EB12, EB12+12, EG140S, EM240, EM360, EM480, EM612, EM-HT, EN, ES12, ESD12, ET, ET020, ETA, ETE20, ETE21, ETE25, ETE27, ETS15, LPE100, LPE145, SQ885, SQT80		



Part No.	358040	Ref. No.	00006261
description	fine fuse size ø10x38mm 16A slow-acting rated 500V type aM Qty 1 pcs		



GASTROPARTS

GASTROPARTS Sp. J.
Klonowica 37
87-100 Toruń

www.gastroparts.com 

gastroparts@gastroparts.com 

tel. +48 56 657 00 68 

[/gastroparts.global](https://www.facebook.com/gastroparts.global) 

[/gastroparts.global](https://www.instagram.com/gastroparts.global) 