

# LGB

✉ [gastroparts@gastroparts.com](mailto:gastroparts@gastroparts.com)

☎ tel. +48 56 657 00 66

📘 [fb.com/gastroparts.global](https://fb.com/gastroparts.global)

**GASTROPARTS.COM**





## pumps

## wash and rinse pumps

LGB



1

<b>Part No.</b>	500334	<b>Ref. No.</b>	111130 ZF130SX
<b>description</b>	pump inlet $\varnothing$ 1½" IT outlet $\varnothing$ 1" ET type ZF130SX 230V 50Hz 1 phase 0,37kW 0,54HP L 220mm rotation direction right capacitor 10 $\mu$ F LGB inlet $\varnothing$ 1¼" ITmm outlet $\varnothing$ 1" ETmm		
<b>spare parts for</b>	500334		
	<b>Part No.</b>	365012	<b>Ref. No.</b> —
	operating capacitor capacity 6,3 $\mu$ F 450V		
	<b>Part No.</b>	510122	<b>Ref. No.</b> 0002R
	pump cover LGB inlet $\varnothing$ 28 mm outlet $\varnothing$ 26 mm		
	<b>Part No.</b>	510703	<b>Ref. No.</b> 1001R 1058R N/A
	mechanical shaft seal for shaft $\varnothing$ 13 mm		
	<b>Part No.</b>	521085	<b>Ref. No.</b> 0106-1R
	impellor $\varnothing$ 72 mm H 17 mm thread M7L shaft $\varnothing$ 13 mm		
	<b>Part No.</b>	528800	<b>Ref. No.</b> 0042R
	O-ring EPDM thickness 2,62 mm ID $\varnothing$ 75,87 mm		
<b>accessories for</b>	500334		
	<b>Part No.</b>	503030	<b>Ref. No.</b> —
	round filters outflow		
	<b>Part No.</b>	503108	<b>Ref. No.</b> —
	round filters outflow		
	<b>Part No.</b>	506015	<b>Ref. No.</b> —
	O-ring EPDM thickness 3,53mm ID $\varnothing$ 39,69mm		
	<b>Part No.</b>	510072	<b>Ref. No.</b> —
	O-ring EPDM thickness 3,53mm ID $\varnothing$ 32,93mm		







1

<b>Part No.</b>	499220	<b>Ref. No.</b>	GISH35-V D55
<b>description</b>	pump inlet $\varnothing$ 1½" outlet $\varnothing$ 1½" type GISH35-V D55 230V 50Hz 1 phase 0,17kW L 230mm rotation direction right capacitor 5 $\mu$ F LGB		
<b>spare parts for</b>	499220		
	<b>Part No.</b>	365017	<b>Ref. No.</b> —
	operating capacitor capacity 5 $\mu$ F 450V		



1

<b>Part No.</b>	500599	<b>Ref. No.</b>	2349-1 2349A ZF131DX
<b>description</b>	pump inlet $\varnothing$ 28mm outlet $\varnothing$ 12mm type ZF131DX 230V 50Hz 1 phase 0,16kW 0,22HP L 175mm rotation direction left capacitor 6,3 $\mu$ F LGB		
<b>spare parts for</b>	500599		
	<b>Part No.</b>	365012	<b>Ref. No.</b> —
	operating capacitor capacity 6,3 $\mu$ F 450V		
	<b>Part No.</b>	510703	<b>Ref. No.</b> 1001R 1058R N/A
	mechanical shaft seal for shaft $\varnothing$ 13 mm		
	<b>Part No.</b>	521119	<b>Ref. No.</b> 2135R
	pump cover LGB inlet $\varnothing$ 28 mm outlet $\varnothing$ 12 mm		
	<b>Part No.</b>	521228	<b>Ref. No.</b> 0105-1R
	impellor $\varnothing$ 72 mm H 17 mm rotation direction left		
	<b>Part No.</b>	528800	<b>Ref. No.</b> 0042R
	O-ring EPDM thickness 2,62 mm ID $\varnothing$ 75,87 mm		



1

<b>Part No.</b>	501503	<b>Ref. No.</b>	C.F.2745 LA 40 SX
<b>description</b>	pump inlet ø 28mm outlet ø 22/27mm type CF 2745 230V 50Hz 1 phase 0,19kW L 175mm rotation direction right capacitor 4µF LGB with capacitor		
<b>spare parts for</b>	501503		
	<b>Part No.</b>	<b>Ref. No.</b>	—
	operating capacitor capacity 4µF 450V		
	<b>Part No.</b>	<b>Ref. No.</b>	Guarnizione per Pompa CRC-R DX EPR 2570A
	O-ring EPDM thickness 2,62mm ID ø 82,22mm		
	<b>Part No.</b>	<b>Ref. No.</b>	1001R 1058R N/A
	mechanical shaft seal for shaft ø 13 mm		
	<b>Part No.</b>	<b>Ref. No.</b>	N/A
	impellor ø 70 mm H 21 mm rotation direction right		
	<b>Part No.</b>	<b>Ref. No.</b>	N/A
	pump cover LGB inlet ø 28 mm outlet ø 22/28mm		



1

<b>Part No.</b>	501525	<b>Ref. No.</b>	CF 3091 LA 40 SX
<b>description</b>	pump inlet ø 28mm outlet ø 22/27mm type CF 3091 230V 60Hz 1 phase 0,2kW L 175mm rotation direction right capacitor 4µF LGB with capacitor		
<b>spare parts for</b>	501525		
	<b>Part No.</b>	<b>Ref. No.</b>	—
	operating capacitor capacity 4µF 450V		

<b>spare parts for</b> 501525			
	<b>Part No.</b>	<b>Ref. No.</b>	Guarnizione per Pompa CRC-R DX EPR 2570A
	O-ring EPDM thickness 2,62mm ID ø 82,22mm		
	<b>Part No.</b>	<b>Ref. No.</b>	1001R 1058R N/A
	mechanical shaft seal for shaft ø 13 mm		
	<b>Part No.</b>	<b>Ref. No.</b>	N/A
	impellor ø 70 mm H 21 mm rotation direction right		
	<b>Part No.</b>	<b>Ref. No.</b>	N/A
	pump cover LGB inlet ø 28 mm outlet ø 22/28mm		







1

<b>Part No.</b>	499099	<b>Ref. No.</b>	CRC-R DX 2570 EPR2570 EPR2570A
<b>description</b>	pump inlet ø 28mm outlet ø 26mm type CRC-R DX 230V 50Hz 1 phase 0,2kW L 175mm rotation direction left capacitor 4µF LGB		
<b>spare parts for</b>	499099		
	<b>Part No.</b>	<b>Ref. No.</b>	—
	operating capacitor capacity 4µF 450V		
	<b>Part No.</b>	<b>Ref. No.</b>	Guarnizione per Pompa CRC-R DX EPR 2570A
	O-ring EPDM thickness 2,62mm ID ø 82,22mm		
	<b>Part No.</b>	<b>Ref. No.</b>	1001R 1058R N/A
	mechanical shaft seal for shaft ø 13 mm		
	<b>Part No.</b>	<b>Ref. No.</b>	2576R
	pump cover LGB inlet ø 28 mm outlet ø 26 mm		
	<b>Part No.</b>	<b>Ref. No.</b>	2574R Girante per Pompa CRC-R DX EPR2570A
	impellor ø 80 mm H 25 mm pump type CRC-R DX		



1





<b>Part No.</b>	501526	<b>Ref. No.</b>	2582-1 CRC-R DX 60 HZ
<b>description</b>	pump inlet $\varnothing$ 28mm outlet $\varnothing$ 26mm type CRC-R DX 230V 60Hz 1 phase 0,21kW L 175mm rotation direction left capacitor 4 $\mu$ F LGB		
<b>spare parts for</b>	501526		
	<b>Part No.</b>	365031	<b>Ref. No.</b> —
	operating capacitor capacity 4 $\mu$ F 450V		
	<b>Part No.</b>	509002	<b>Ref. No.</b> Guarnizione per Pompa CRC-R DX EPR 2570A
	O-ring EPDM thickness 2,62mm ID $\varnothing$ 82,22mm		
	<b>Part No.</b>	510703	<b>Ref. No.</b> 1001R 1058R N/A
	mechanical shaft seal for shaft $\varnothing$ 13 mm		
	<b>Part No.</b>	521091	<b>Ref. No.</b> 2576R
	pump cover LGB inlet $\varnothing$ 28 mm outlet $\varnothing$ 26 mm		
	<b>Part No.</b>	521092	<b>Ref. No.</b> 2574R Girante per Pompa CRC-R DX EPR2570A
	impellor $\varnothing$ 80 mm H 25 mm pump type CRC-R DX		



1





<b>Part No.</b>	499061	<b>Ref. No.</b>	2753-1 ZF115SX EPR2753
<b>description</b>	pump inlet $\varnothing$ 28mm outlet $\varnothing$ 26mm type ZF115SX 230V 50Hz 1 phase 0,21kW L 190mm capacitor 5 $\mu$ F LGB		
<b>spare parts for</b>	499061		
	<b>Part No.</b>	365017	<b>Ref. No.</b> —
	operating capacitor capacity 5 $\mu$ F 450V		

**spare parts for** 499061

	<b>Part No.</b>	510122	<b>Ref. No.</b>	0002R
	pump cover LGB inlet $\varnothing$ 28 mm outlet $\varnothing$ 26 mm			
	<b>Part No.</b>	510703	<b>Ref. No.</b>	1001R 1058R N/A
	mechanical shaft seal for shaft $\varnothing$ 13 mm			
	<b>Part No.</b>	521221	<b>Ref. No.</b>	N/A
	impellor $\varnothing$ 67 mm H 16 mm rotation direction right			
	<b>Part No.</b>	528800	<b>Ref. No.</b>	0042R
	O-ring EPDM thickness 2,62 mm ID $\varnothing$ 75,87 mm			



1

<b>Part No.</b>	500353	<b>Ref. No.</b>	EPR499 ZF115SX	
<b>description</b>	pump inlet $\varnothing$ 28mm outlet $\varnothing$ 26mm type ZF115SX 230V 50Hz 1 phase 0,2kW 0,27HP L 190mm rotation direction right capacitor 5 $\mu$ F LGB			
<b>spare parts for</b>	500353			
	<b>Part No.</b>	365017	<b>Ref. No.</b> —	
	operating capacitor capacity 5 $\mu$ F 450V			
	<b>Part No.</b>	510122	<b>Ref. No.</b>	0002R
	pump cover LGB inlet $\varnothing$ 28 mm outlet $\varnothing$ 26 mm			
	<b>Part No.</b>	510703	<b>Ref. No.</b>	1001R 1058R N/A
	mechanical shaft seal for shaft $\varnothing$ 13 mm			
	<b>Part No.</b>	521223	<b>Ref. No.</b>	1517R
	impellor $\varnothing$ 61 mm H 17 mm thread M7L shaft $\varnothing$ 13 mm			
	<b>Part No.</b>	528800	<b>Ref. No.</b>	0042R
	O-ring EPDM thickness 2,62 mm ID $\varnothing$ 75,87 mm			



1

<b>Part No.</b>	500342	<b>Ref. No.</b>	ZF119SX (BL19655)
<b>description</b>	pump inlet ø 28mm outlet ø 26mm type ZF119DX 230V 50Hz 1 phase 0,2kW 0,27HP L 186mm rotation direction left capacitor 5µF LGB		







1

<b>Part No.</b>	499204	<b>Ref. No.</b>	ZF119SX
<b>description</b>	pump inlet ø 28mm outlet ø 26mm type ZF119SX 230V 50Hz 1 phase 0,15kW 0,2HP L 195mm rotation direction right capacitor 5µF auxiliary pressure connection 12mm LGB		
<b>spare parts for</b>	499204		
	<b>Part No.</b>	365017	<b>Ref. No.</b> —
	operating capacitor capacity 5µF 450V		
	<b>Part No.</b>	510703	<b>Ref. No.</b> 1001R 1058R N/A
	mechanical shaft seal for shaft ø 13 mm		
	<b>Part No.</b>	521057	<b>Ref. No.</b> 1650R
	pump cover LGB inlet ø 28 mm outlet ø 26 mm		
	<b>Part No.</b>	521114	<b>Ref. No.</b> Girante per Pompa ZF119SX C.F.2126
	impellor ø 48 mm H 17 mm pump type ZF119SX		
	<b>Part No.</b>	528800	<b>Ref. No.</b> 0042R
	O-ring EPDM thickness 2,62 mm ID ø 75,87 mm		



1

<b>Part No.</b>	500936	<b>Ref. No.</b>	ZF119SX
<b>description</b>	pump inlet ø 28mm outlet ø 26mm type ZF119SX 230V 50Hz 1 phase 0,24kW 0,33HP L 190mm rotation direction right capacitor 5µF LGB		
<b>spare parts for</b>	500936		
	<b>Part No.</b>	365017	<b>Ref. No.</b> —
	operating capacitor capacity 5µF 450V		
	<b>Part No.</b>	521057	<b>Ref. No.</b> 1650R
	pump cover LGB inlet ø 28 mm outlet ø 26 mm		
	<b>Part No.</b>	528800	<b>Ref. No.</b> 0042R
	O-ring EPDM thickness 2,62 mm ID ø 75,87 mm		
<b>accessories for</b>	500936		
	<b>Part No.</b>	550964	<b>Ref. No.</b> —
	fastening angle for pump		





1

<b>Part No.</b>	499132	<b>Ref. No.</b>	EPR2894 ZF121SX
<b>description</b>	pump inlet ø 28mm outlet ø 26mm type ZF121SX 230V 50Hz 1 phase 0,11kW 0,15HP L 195mm rotation direction right capacitor 6,3µF LGB		
<b>spare parts for</b>	499132		
	<b>Part No.</b>	365012	<b>Ref. No.</b> —
	operating capacitor capacity 6,3µF 450V		
	<b>Part No.</b>	510703	<b>Ref. No.</b> 1001R 1058R N/A
	mechanical shaft seal for shaft ø 13 mm		

Table continues overleaf





<b>spare parts for</b> 499132			
	Part No.	521057	Ref. No. 1650R
pump cover LGB inlet ø 28 mm outlet ø 26 mm			
	Part No.	521085	Ref. No. 0106-1R
impellor ø 72 mm H 17 mm thread M7L shaft ø 13 mm			
	Part No.	528800	Ref. No. 0042R
O-ring EPDM thickness 2,62 mm ID ø 75,87 mm			



1

<b>Part No.</b>	500542	<b>Ref. No.</b>	EPR0459 ZF130DX
<b>description</b>	pump inlet ø 28mm outlet ø 26mm type ZF130DX 230V 50Hz 1 phase 0,3kW 0,41HP L 190mm rotation direction left capacitor 6,3µF LGB		
<b>spare parts for</b> 500542			
	Part No.	365012	Ref. No. —
operating capacitor capacity 6,3µF 450V			
	Part No.	510703	Ref. No. 1001R 1058R N/A
mechanical shaft seal for shaft ø 13 mm			
	Part No.	521107	Ref. No. 0001R
pump cover LGB inlet ø 28 mm outlet ø 26 mm			
	Part No.	521228	Ref. No. 0105-1R
impellor ø 72 mm H 17 mm rotation direction left			
	Part No.	528800	Ref. No. 0042R
O-ring EPDM thickness 2,62 mm ID ø 75,87 mm			



1

<b>Part No.</b>	500494	<b>Ref. No.</b>	C.F0551 EPR0551 ZF130DX
<b>description</b>	pump inlet ø 28mm outlet ø 26mm type ZF130DX 230V 50Hz 1 phase 0,3kW 0,4HP L 200mm rotation direction left capacitor 6,3µF LGB		
<b>spare parts for</b> 500494			
	Part No.	365012	Ref. No. —
operating capacitor capacity 6,3µF 450V			
	Part No.	510703	Ref. No. 1001R 1058R N/A
mechanical shaft seal for shaft ø 13 mm			
	Part No.	521107	Ref. No. 0001R
pump cover LGB inlet ø 28 mm outlet ø 26 mm			
	Part No.	521228	Ref. No. 0105-1R
impellor ø 72 mm H 17 mm rotation direction left			
	Part No.	528800	Ref. No. 0042R
O-ring EPDM thickness 2,62 mm ID ø 75,87 mm			



1







<b>Part No.</b>	500352	<b>Ref. No.</b>	EPR0500 ZF130SX
<b>description</b>	pump inlet ø 28mm outlet ø 26mm type ZF130SX 230V 50Hz 1 phase 0,2kW 0,27HP L 195mm rotation direction right capacitor 6,3µF LGB		
<b>spare parts for</b> 500352			
	Part No.	365012	Ref. No. —
operating capacitor capacity 6,3µF 450V			
	Part No.	510122	Ref. No. 0002R
pump cover LGB inlet ø 28 mm outlet ø 26 mm			

Table continues overleaf

<b>spare parts for</b> 500352			
	Part No.	510703	Ref. No. 1001R 1058R N/A
mechanical shaft seal for shaft $\varnothing$ 13 mm			
	Part No.	521085	Ref. No. 0106-1R
impellor $\varnothing$ 72 mm H 17 mm thread M7L shaft $\varnothing$ 13 mm			
	Part No.	528800	Ref. No. 0042R
O-ring EPDM thickness 2,62 mm ID $\varnothing$ 75,87 mm			







1

<b>Part No.</b>	500583	<b>Ref. No.</b>	EPR1219 ZF130SX
<b>description</b>	pump inlet $\varnothing$ 28mm outlet $\varnothing$ 26mm type ZF130SX 230V 50Hz 1 phase 0,2kW 0,27HP L 195mm rotation direction right capacitor 6,3 $\mu$ F LGB		
<b>spare parts for</b> 500583			
	Part No.	509004	Ref. No. 0951R
impellor $\varnothing$ 71 mm H 16 mm M7L			
	Part No.	510703	Ref. No. 1001R 1058R N/A
mechanical shaft seal for shaft $\varnothing$ 13 mm			







1

<b>Part No.</b>	500382	<b>Ref. No.</b>	EPR0542 ZF131DX
<b>description</b>	pump inlet $\varnothing$ 28mm outlet $\varnothing$ 26mm type ZF131DX 230V 50Hz 1 phase 0,2kW 0,26HP L 180mm rotation direction left capacitor 6,3 $\mu$ F LGB		
<b>spare parts for</b> 500382			
	Part No.	365012	Ref. No. —
operating capacitor capacity 6,3 $\mu$ F 450V			
	Part No.	510703	Ref. No. 1001R 1058R N/A
mechanical shaft seal for shaft $\varnothing$ 13 mm			
	Part No.	521228	Ref. No. 0105-1R
impellor $\varnothing$ 72 mm H 17 mm rotation direction left			

<b>spare parts for</b> 500382			
	Part No.	521524	Ref. No. 0882R
pump cover LGB inlet $\varnothing$ 28 mm outlet $\varnothing$ 26 mm			
	Part No.	528800	Ref. No. 0042R
O-ring EPDM thickness 2,62 mm ID $\varnothing$ 75,87 mm			







1

<b>Part No.</b>	500555	<b>Ref. No.</b>	EPR0532 ZF131DX
<b>description</b>	pump inlet $\varnothing$ 28mm outlet $\varnothing$ 26mm type ZF131DX 230V 50Hz 1 phase 0,2kW 0,27HP L 195mm rotation direction left capacitor 6,3 $\mu$ F auxiliary pressure connection 12mm supporting pressure closed LGB		
<b>spare parts for</b> 500555			
	Part No.	365012	Ref. No. —
operating capacitor capacity 6,3 $\mu$ F 450V			
	Part No.	510703	Ref. No. 1001R 1058R N/A
mechanical shaft seal for shaft $\varnothing$ 13 mm			
	Part No.	521228	Ref. No. 0105-1R
impellor $\varnothing$ 72 mm H 17 mm rotation direction left			
	Part No.	521524	Ref. No. 0882R
pump cover LGB inlet $\varnothing$ 28 mm outlet $\varnothing$ 26 mm			
	Part No.	528800	Ref. No. 0042R
O-ring EPDM thickness 2,62 mm ID $\varnothing$ 75,87 mm			





1



<b>Part No.</b>	500582	<b>Ref. No.</b>	EPR1002 EPR1453 ZF131DX 1002
<b>description</b>	pump inlet $\varnothing$ 28mm outlet $\varnothing$ 26mm type ZF131DX 230V 50Hz 1 phase 0,2kW 0,27HP L 195mm rotation direction left capacitor 6,3 $\mu$ F LGB		
<b>spare parts for</b>	500582		
	Part No.	365012	Ref. No. —
	operating capacitor capacity 6,3 $\mu$ F 450V		
	Part No.	510703	Ref. No. 1001R 1058R N/A
	mechanical shaft seal for shaft $\varnothing$ 13 mm		
	Part No.	521084	Ref. No. 1263R
	pump cover LGB inlet $\varnothing$ 28 mm outlet $\varnothing$ 25 mm		
	Part No.	521228	Ref. No. 0105-1R
	impellor $\varnothing$ 72 mm H 17 mm rotation direction left		
	Part No.	528800	Ref. No. 0042R
	O-ring EPDM thickness 2,62 mm ID $\varnothing$ 75,87 mm		



1





<b>Part No.</b>	499301	<b>Ref. No.</b>	EPR1644 ZF131DX
<b>description</b>	pump inlet $\varnothing$ 28mm outlet $\varnothing$ 26mm type ZF131DX 230V 50Hz 1 phase 0,2kW L 195mm rotation direction left capacitor 6,3 $\mu$ F LGB		
<b>spare parts for</b>	499301		
	Part No.	365012	Ref. No. —
	operating capacitor capacity 6,3 $\mu$ F 450V		
	Part No.	510703	Ref. No. 1001R 1058R N/A
	mechanical shaft seal for shaft $\varnothing$ 13 mm		
	Part No.	521084	Ref. No. 1263R
	pump cover LGB inlet $\varnothing$ 28 mm outlet $\varnothing$ 25 mm		

**spare parts for** 499301

	Part No.	521228	Ref. No.	0105-1R
	impellor $\varnothing$ 72 mm H 17 mm rotation direction left			
	Part No.	528800	Ref. No.	0042R
	O-ring EPDM thickness 2,62 mm ID $\varnothing$ 75,87 mm			



1

<b>Part No.</b>	500094	<b>Ref. No.</b>	EPR0744 ZF131SX
<b>description</b>	pump inlet $\varnothing$ 28mm outlet $\varnothing$ 26mm type ZF131SX 230V 50Hz 1 phase 0,2kW 0,15HP L 195mm rotation direction left capacitor 6,3 $\mu$ F LGB		
<b>spare parts for</b>	500094		
	Part No.	365012	Ref. No. —
	operating capacitor capacity 6,3 $\mu$ F 450V		
	Part No.	502266	Ref. No. 0881R
	pump cover inlet $\varnothing$ 28 mm outlet $\varnothing$ 26 mm		
	Part No.	510703	Ref. No. 1001R 1058R N/A
	mechanical shaft seal for shaft $\varnothing$ 13 mm		
	Part No.	521085	Ref. No. 0106-1R
	impellor $\varnothing$ 72 mm H 17 mm thread M7L shaft $\varnothing$ 13 mm		
	Part No.	528800	Ref. No. 0042R
	O-ring EPDM thickness 2,62 mm ID $\varnothing$ 75,87 mm		





1

<b>Part No.</b>	500539	<b>Ref. No.</b>	EPR0861 EPR0861A ZF170SX
<b>description</b>	pump inlet ø 28mm outlet ø 26mm type ZF170SX 230V 50Hz 1 phase 0,32kW 0,44HP L 200mm rotation direction right capacitor 8µF LGB		
<b>spare parts for</b>	500539		
	<b>Part No.</b>	<b>Ref. No.</b>	—
	operating capacitor capacity 8µF 400V		
	<b>Part No.</b>	<b>Ref. No.</b>	0951R
	impellor ø 71 mm H 16 mm M7L		
	<b>Part No.</b>	<b>Ref. No.</b>	1001R 1058R N/A
	mechanical shaft seal for shaft ø 13 mm		
	<b>Part No.</b>	<b>Ref. No.</b>	1650R
	pump cover LGB inlet ø 28 mm outlet ø 26 mm		
	<b>Part No.</b>	<b>Ref. No.</b>	0042R
	O-ring EPDM thickness 2,62 mm ID ø 75,87 mm		



1

<b>Part No.</b>	500510	<b>Ref. No.</b>	EPR1106 EPR1106A ZF170SX
<b>description</b>	pump inlet ø 28mm outlet ø 26mm type ZF170SX 230V 50Hz 1 phase 0,3kW 0,41HP L 195mm rotation direction right capacitor 6,3µF LGB		
<b>spare parts for</b>	500510		
	<b>Part No.</b>	<b>Ref. No.</b>	—
	operating capacitor capacity 6,3µF 450V		
	<b>Part No.</b>	<b>Ref. No.</b>	1001R 1058R N/A
	mechanical shaft seal for shaft ø 13 mm		

<b>spare parts for</b>	500510		
	<b>Part No.</b>	<b>Ref. No.</b>	1650R
	pump cover LGB inlet ø 28 mm outlet ø 26 mm		
	<b>Part No.</b>	<b>Ref. No.</b>	0110-1R
	impellor ø 72 mm H 22 mm rotation direction right		
	<b>Part No.</b>	<b>Ref. No.</b>	0042R
	O-ring EPDM thickness 2,62 mm ID ø 75,87 mm		



1

<b>Part No.</b>	500460	<b>Ref. No.</b>	EPR1800 ZFC119DX
<b>description</b>	pump inlet ø 28mm outlet ø 26mm type ZFC119DX 230V 50Hz 1 phase 0,2kW 0,27HP L 180mm rotation direction left capacitor 5µF LGB		





1

<b>Part No.</b>	500979	<b>Ref. No.</b>	EPR1810 ZFC121DX
<b>description</b>	pump inlet ø 28mm outlet ø 26mm type ZFC121DX 230V 50Hz 1 phase 0,25kW L 198mm rotation direction left capacitor 6,3µF LGB		
<b>spare parts for</b>	500979		
	<b>Part No.</b>	<b>Ref. No.</b>	—
	operating capacitor capacity 6,3µF 450V		
	<b>Part No.</b>	<b>Ref. No.</b>	1001R 1058R N/A
	mechanical shaft seal for shaft ø 13 mm		
	<b>Part No.</b>	<b>Ref. No.</b>	1649R
	pump cover LGB inlet ø 28 mm outlet ø 26 mm		



Table continues overleaf



<b>spare parts for</b> 500979			
	Part No.	521099	Ref. No. 1580-1R
impellor ø 72 mm H 17 mm thread M7R shaft ø 13 mm			
	Part No.	528800	Ref. No. 0042R
O-ring EPDM thickness 2,62 mm ID ø 75,87 mm			



1

<b>Part No.</b>	500567	<b>Ref. No.</b>	EPR1626 ZF121DX
<b>description</b>	pump inlet ø 28mm outlet ø 28mm type ZF121DX 230V 50Hz 1 phase 0,25kW L 195mm rotation direction left capacitor 6,3µF LGB		
<b>spare parts for</b> 500567			
	Part No.	365012	Ref. No. —
operating capacitor capacity 6,3µF 450V			
	Part No.	510703	Ref. No. 1001R 1058R N/A
mechanical shaft seal for shaft ø 13 mm			
	Part No.	521098	Ref. No. 1649R
pump cover LGB inlet ø 28 mm outlet ø 26 mm			
	Part No.	521099	Ref. No. 1580-1R
impellor ø 72 mm H 17 mm thread M7R shaft ø 13 mm			
	Part No.	528800	Ref. No. 0042R
O-ring EPDM thickness 2,62 mm ID ø 75,87 mm			







1

<b>Part No.</b>	500483	<b>Ref. No.</b>	ZF121DX
<b>description</b>	pump inlet ø 28mm outlet ø 28mm type ZF121DX 230V 50Hz 1 phase 0,28kW 0,38HP L 195mm rotation direction left capacitor 6,3µF LGB		
<b>spare parts for</b> 500483			
	Part No.	365012	Ref. No. —
operating capacitor capacity 6,3µF 450V			



1

<b>Part No.</b>	500480	<b>Ref. No.</b>	EPR2380 ZF131DX
<b>description</b>	pump inlet ø 28mm outlet ø 28mm type ZF131DX 230V 50Hz 1 phase 0,29kW 0,4HP L 195mm rotation direction left capacitor 6,3µF LGB		
<b>spare parts for</b> 500480			
	Part No.	365012	Ref. No. —
operating capacitor capacity 6,3µF 450V			
	Part No.	510690	Ref. No. N/A
mechanical shaft seal for shaft ø 8 mm ED ø 24 mm			
	Part No.	521083	Ref. No. 0815R
impellor ø 73 mm H 13 mm thread M7R blades 3			
	Part No.	521084	Ref. No. 1263R
pump cover LGB inlet ø 28 mm outlet ø 25 mm			
	Part No.	528800	Ref. No. 0042R
O-ring EPDM thickness 2,62 mm ID ø 75,87 mm			







1

<b>Part No.</b>	500466	<b>Ref. No.</b>	EPR1722 ZFC1121DX
<b>description</b>	pump inlet $\varnothing$ 28mm outlet $\varnothing$ 28mm type ZFC1121DX 230V 50Hz 1 phase 0,35kW 0,47HP L 200mm rotation direction left capacitor 6,3 $\mu$ F LGB		
<b>spare parts for</b> 500466			
	<b>Part No.</b>	365012	<b>Ref. No.</b> —
	operating capacitor capacity 6,3 $\mu$ F 450V		
	<b>Part No.</b>	510703	<b>Ref. No.</b> 1001R 1058R N/A
	mechanical shaft seal for shaft $\varnothing$ 13 mm		
	<b>Part No.</b>	521007	<b>Ref. No.</b> 1774R
	pump cover LGB inlet $\varnothing$ 28 mm outlet $\varnothing$ 26 mm		
	<b>Part No.</b>	521008	<b>Ref. No.</b> 0109-1R
	impellor $\varnothing$ 72 mm H 22 mm rotation direction left		
	<b>Part No.</b>	528800	<b>Ref. No.</b> 0042R
	O-ring EPDM thickness 2,62 mm ID $\varnothing$ 75,87 mm		







1

<b>Part No.</b>	500966	<b>Ref. No.</b>	EPR2111 FC2006
<b>description</b>	pump inlet $\varnothing$ 29mm outlet $\varnothing$ 31/38mm type FC2006 230V 50Hz 1 phase 0,7kW 0,95HP L 195mm rotation direction left capacitor 16 $\mu$ F LGB		
<b>spare parts for</b> 500966			
	<b>Part No.</b>	365021	<b>Ref. No.</b> —
	operating capacitor capacity 16 $\mu$ F 425V		

<b>spare parts for</b> 500966			
	<b>Part No.</b>	510703	<b>Ref. No.</b> 1001R 1058R N/A
	mechanical shaft seal for shaft $\varnothing$ 13 mm		
	<b>Part No.</b>	521149	<b>Ref. No.</b> N/A
	pump cover LGB outlet $\varnothing$ 38/31mm		
	<b>Part No.</b>	521150	<b>Ref. No.</b> N/A
	impellor $\varnothing$ 85 mm H 17 mm thread M8R shaft $\varnothing$ 13 mm		
	<b>Part No.</b>	532537	<b>Ref. No.</b> N/A
	O-ring EPDM thickness 3,53 mm ID $\varnothing$ 113,9 mm		



1

<b>Part No.</b>	500351	<b>Ref. No.</b>	X5SX 130994
<b>description</b>	pump inlet $\varnothing$ 29mm outlet $\varnothing$ 39mm type X5SX 230V 50Hz 1 phase 0,8kW 1,09HP L 210mm rotation direction right capacitor 16 $\mu$ F LGB		
<b>spare parts for</b> 500351			
	<b>Part No.</b>	365021	<b>Ref. No.</b> —
	operating capacitor capacity 16 $\mu$ F 425V		
	<b>Part No.</b>	510703	<b>Ref. No.</b> 1001R 1058R N/A
	mechanical shaft seal for shaft $\varnothing$ 13 mm		
	<b>Part No.</b>	518294	<b>Ref. No.</b> —
	flat gasket rubber D1 $\varnothing$ 85mm D2 $\varnothing$ 71mm		
	<b>Part No.</b>	521234	<b>Ref. No.</b> N/A
	impellor thread M8L ED $\varnothing$ 93 mm W 16 mm		
	<b>Part No.</b>	523509	<b>Ref. No.</b> —
	deep-groove ball bearing type 6201-2RS		
	<b>Part No.</b>	532537	<b>Ref. No.</b> N/A
	O-ring EPDM thickness 3,53 mm ID $\varnothing$ 113,9 mm		





1

<b>Part No.</b>	500459	<b>Ref. No.</b>	ZF110SX
<b>description</b>	pump inlet $\varnothing$ 30mm outlet $\varnothing$ 29mm type ZF110SX 230V 50Hz 1 phase 0,25kW 0,34HP L 150mm rotation direction left capacitor 8 $\mu$ F LGB		



1

<b>Part No.</b>	500511	<b>Ref. No.</b>	EPR1453 ZF140SX
<b>description</b>	pump inlet $\varnothing$ 30mm outlet $\varnothing$ 29mm type ZF140SX 230V 50Hz 1 phase 0,36kW 0,5HP L 190mm rotation direction right LGB		

<b>spare parts for</b>	500511		
	<b>Part No.</b>	365017	<b>Ref. No.</b> —
	operating capacitor capacity 5 $\mu$ F 450V		
	<b>Part No.</b>	510703	<b>Ref. No.</b> 1001R 1058R N/A
	mechanical shaft seal for shaft $\varnothing$ 13 mm		
	<b>Part No.</b>	521230	<b>Ref. No.</b> N/A
	impellor $\varnothing$ 86 mm H 16 mm M7L		
	<b>Part No.</b>	521526	<b>Ref. No.</b> 0009R 3286R
	pump cover LGB inlet $\varnothing$ 30 mm outlet $\varnothing$ 30 mm		
<b>image not available</b>	<b>Part No.</b>	521706	<b>Ref. No.</b> 2234R
	pump cover gasket		



1

<b>Part No.</b>	499104	<b>Ref. No.</b>	EPR1598 ZF135SX
-----------------	--------	-----------------	--------------------

**description** pump inlet  $\varnothing$  30mm outlet  $\varnothing$  30mm type ZF135 SX 230V 50Hz 1 phase 0,37kW L 210mm rotation direction right capacitor 8 $\mu$ F LGB

<b>spare parts for</b>	499104		
	<b>Part No.</b>	365013	<b>Ref. No.</b> —
	operating capacitor capacity 8 $\mu$ F 400V		
	<b>Part No.</b>	510703	<b>Ref. No.</b> 1001R 1058R N/A
	mechanical shaft seal for shaft $\varnothing$ 13 mm		
	<b>Part No.</b>	521527	<b>Ref. No.</b> 0645R
	pump cover LGB inlet $\varnothing$ 30 mm outlet $\varnothing$ 30 mm		
	<b>Part No.</b>	521701	<b>Ref. No.</b> 0044R
	pump cover gasket		



1



<b>Part No.</b>	500538	<b>Ref. No.</b>	EPR0492 ZF150SX
-----------------	--------	-----------------	--------------------

**description** pump inlet  $\varnothing$  30mm outlet  $\varnothing$  30mm type ZF150SX 230V 50Hz 1 phase 0,2kW 0,25HP L 170mm rotation direction right capacitor 10 $\mu$ F LGB

<b>spare parts for</b>	500538		
	<b>Part No.</b>	365015	<b>Ref. No.</b> —
	operating capacitor capacity 10 $\mu$ F 400V		
	<b>Part No.</b>	510703	<b>Ref. No.</b> 1001R 1058R N/A
	mechanical shaft seal for shaft $\varnothing$ 13 mm		
	<b>Part No.</b>	521527	<b>Ref. No.</b> 0645R
	pump cover LGB inlet $\varnothing$ 30 mm outlet $\varnothing$ 30 mm		





Table continues overleaf



<b>spare parts for</b> 500538			
	Part No.	521701	Ref. No. 0044R
	pump cover gasket		
	Part No.	521707	Ref. No. —
	pump cover gasket		



1

<b>Part No.</b>	500384	<b>Ref. No.</b>	EPR0548 ZF160SX
<b>description</b>	pump inlet ø 30mm outlet ø 30mm type ZF160SX 230V 50Hz 1 phase 0,41kW 0,55HP L 180mm rotation direction right capacitor 12,5µF LGB		
<b>spare parts for</b> 500384			
	Part No.	365014	Ref. No. —
	operating capacitor capacity 12,5µF 400V		
	Part No.	510703	Ref. No. 1001R 1058R N/A
	mechanical shaft seal for shaft ø 13 mm		
	Part No.	521527	Ref. No. 0645R
	pump cover LGB inlet ø 30 mm outlet ø 30 mm		
	Part No.	521701	Ref. No. 0044R
	pump cover gasket		
	Part No.	521707	Ref. No. —
	pump cover gasket		



1

<b>Part No.</b>	499078	<b>Ref. No.</b>	ZF160SX
<b>description</b>	pump inlet ø 30mm outlet ø 30mm type ZF160SX 230V 50Hz 1 phase 0,4kW 0,54HP L 186mm rotation direction right capacitor 12µF LGB		



1

<b>Part No.</b>	500461	<b>Ref. No.</b>	EPR0524 ZF210SX
<b>description</b>	pump inlet ø 32mm outlet ø 32mm type ZF210SX 230V 50Hz 1 phase 0,6kW 0,8HP L 180mm capacitor 12,5µF LGB		
<b>spare parts for</b> 500461			
	Part No.	365014	Ref. No. —
	operating capacitor capacity 12,5µF 400V		
	Part No.	502267	Ref. No. 0935-1R
	pump cover		
	Part No.	510702	Ref. No. N/A
	mechanical shaft seal height counter ring 5,5 mm		
	Part No.	521042	Ref. No. 0116R Girante Pompa EPR0524(Z- F210SX)
	impellor ø 103 mm H 14 mm pump type ZF210SX		
<b>image not available</b>	Part No.	532719	Ref. No. N/A
	O-ring EPDM thickness 2,62mm ID ø 126,67mm		









1

<b>Part No.</b>	499138	<b>Ref. No.</b>	1826 X3SX
<b>description</b>	pump inlet $\varnothing$ 33mm outlet $\varnothing$ 26mm type X3SX 230V 50Hz 1 phase 0,26kW L 300mm rotation direction right capacitor 6,3 $\mu$ F LGB		
<b>spare parts for</b>	499138		
	<b>Part No.</b>	365012	<b>Ref. No.</b> —
	operating capacitor capacity 6,3 $\mu$ F 450V		
	<b>Part No.</b>	509004	<b>Ref. No.</b> 0951R
	impellor $\varnothing$ 71 mm H 16 mm M7L		
	<b>Part No.</b>	510703	<b>Ref. No.</b> 1001R 1058R N/A
	mechanical shaft seal for shaft $\varnothing$ 13 mm		
	<b>Part No.</b>	521088	<b>Ref. No.</b> N/A
	pump cover LGB inlet $\varnothing$ 33 mm outlet $\varnothing$ 26 mm		
	<b>Part No.</b>	521147	<b>Ref. No.</b> —
	flange		
	<b>Part No.</b>	521703	<b>Ref. No.</b> N/A
	pump cover gasket EPDM thickness 2,5 mm ID $\varnothing$ 75 mm		
	<b>Part No.</b>	523501	<b>Ref. No.</b> —
	deep-groove ball bearing type 608-2RS shaft $\varnothing$ 8mm		



1

<b>Part No.</b>	499100	<b>Ref. No.</b>	EPR2248 Kundenschutz LA50 130982 LA50 2248
<b>description</b>	pump inlet $\varnothing$ 42mm outlet $\varnothing$ 24/37mm type LA50 230V 50Hz 1 phase 0,47kW L 220mm rotation direction right capacitor 10 $\mu$ F LGB with flange and hoses		
<b>spare parts for</b>	499100		
	<b>Part No.</b>	365015	<b>Ref. No.</b> —
	operating capacitor capacity 10 $\mu$ F 400V		
	<b>Part No.</b>	510702	<b>Ref. No.</b> N/A
	mechanical shaft seal height counter ring 5,5 mm		
	<b>Part No.</b>	521024	<b>Ref. No.</b> N/A
	impellor $\varnothing$ 88 mm H 30 mm rotation direction right		
	<b>Part No.</b>	698767	<b>Ref. No.</b> —
	fan blade $\varnothing$ 110mm H 18mm shaft intake $\varnothing$ 12mm		
	<b>Part No.</b>	698768	<b>Ref. No.</b> N/A
	pump cover LGB inlet $\varnothing$ 42 mm pump type LA50 AP		
	<b>Part No.</b>	698810	<b>Ref. No.</b> N/A
	O-ring EPDM thickness 3,56mm ID $\varnothing$ 112mm Qty 1 pcs		
	<b>Part No.</b>	698827	<b>Ref. No.</b> N/A
	threaded ring LGB pump type LA50 $\varnothing$ 120 mm		



1

<b>Part No.</b>	499190	<b>Ref. No.</b>	EPR2432 LA50 LA50 2432 LA50 69120
<b>description</b>	pump inlet $\varnothing$ 42mm outlet $\varnothing$ 24/37mm type LA50 230V 50Hz 1 phase 0,47kW L 225mm rotation direction right capacitor 10 $\mu$ F LGB		
<b>spare parts for</b>	499190		
	<b>Part No.</b>	365015	<b>Ref. No.</b> —
	operating capacitor capacity 10 $\mu$ F 400V		
	<b>Part No.</b>	510702	<b>Ref. No.</b> N/A
	mechanical shaft seal height counter ring 5,5 mm		
	<b>Part No.</b>	521024	<b>Ref. No.</b> N/A
	impellor $\varnothing$ 88 mm H 30 mm rotation direction right		
	<b>Part No.</b>	698767	<b>Ref. No.</b> —
	fan blade $\varnothing$ 110mm H 18mm shaft intake $\varnothing$ 12mm		
	<b>Part No.</b>	698768	<b>Ref. No.</b> N/A
	pump cover LGB inlet $\varnothing$ 42 mm pump type LA50 AP		
	<b>Part No.</b>	698793	<b>Ref. No.</b> —
	pump cover outlet $\varnothing$ 24/36mm pump type LGB		
	<b>Part No.</b>	698810	<b>Ref. No.</b> N/A
	O-ring EPDM thickness 3,56mm ID $\varnothing$ 112mm Qty 1 pcs		
	<b>Part No.</b>	698827	<b>Ref. No.</b> N/A
	threaded ring LGB pump type LA50 $\varnothing$ 120 mm		







1

<b>Part No.</b>	499342	<b>Ref. No.</b>	LA50 74122
<b>description</b>	pump inlet $\varnothing$ 42mm outlet $\varnothing$ 24/37mm type LA50 230V 50Hz 1 phase 0,47kW L 225mm rotation direction right capacitor 10 $\mu$ F LGB		
<b>spare parts for</b>	499342		
	<b>Part No.</b>	365015	<b>Ref. No.</b> —
	operating capacitor capacity 10 $\mu$ F 400V		
	<b>Part No.</b>	510702	<b>Ref. No.</b> N/A
	mechanical shaft seal height counter ring 5,5 mm		
	<b>Part No.</b>	521024	<b>Ref. No.</b> N/A
	impellor $\varnothing$ 88 mm H 30 mm rotation direction right		
	<b>Part No.</b>	698767	<b>Ref. No.</b> —
	fan blade $\varnothing$ 110mm H 18mm shaft intake $\varnothing$ 12mm		
	<b>Part No.</b>	698768	<b>Ref. No.</b> N/A
	pump cover LGB inlet $\varnothing$ 42 mm pump type LA50 AP		
	<b>Part No.</b>	698769	<b>Ref. No.</b> —
	pump casing $\varnothing$ 125mm outlet $\varnothing$ 24/37mm		
	<b>Part No.</b>	698810	<b>Ref. No.</b> N/A
	O-ring EPDM thickness 3,56mm ID $\varnothing$ 112mm Qty 1 pcs		
	<b>Part No.</b>	698827	<b>Ref. No.</b> N/A
	threaded ring LGB pump type LA50 $\varnothing$ 120 mm		



1

<b>Part No.</b>	501484	<b>Ref. No.</b>	LA50
<b>description</b>	pump inlet $\varnothing$ 42mm outlet $\varnothing$ 37/24mm type LA50 230V 50Hz 1 phase 0,47kW L 220mm rotation direction right capacitor 10 $\mu$ F auxiliary pressure connection 8mm LGB		
<b>spare parts for</b>	501484		
	<b>Part No.</b>	365015	<b>Ref. No.</b> —
	operating capacitor capacity 10 $\mu$ F 400V		
	<b>Part No.</b>	510702	<b>Ref. No.</b> N/A
	mechanical shaft seal height counter ring 5,5 mm		
	<b>Part No.</b>	521024	<b>Ref. No.</b> N/A
	impellor $\varnothing$ 88 mm H 30 mm rotation direction right		
	<b>Part No.</b>	698767	<b>Ref. No.</b> —
	fan blade $\varnothing$ 110mm H 18mm shaft intake $\varnothing$ 12mm		
	<b>Part No.</b>	698768	<b>Ref. No.</b> N/A
	pump cover LGB inlet $\varnothing$ 42 mm pump type LA50 AP		
	<b>Part No.</b>	698769	<b>Ref. No.</b> —
	pump casing $\varnothing$ 125mm outlet $\varnothing$ 24/37mm		
	<b>Part No.</b>	698810	<b>Ref. No.</b> N/A
	O-ring EPDM thickness 3,56mm ID $\varnothing$ 112mm Qty 1 pcs		
	<b>Part No.</b>	698827	<b>Ref. No.</b> N/A
	threaded ring LGB pump type LA50 $\varnothing$ 120 mm		









1

<b>Part No.</b>	501486	<b>Ref. No.</b>	Kundenschutz LA50AP
<b>description</b>	pump inlet $\varnothing$ 42mm outlet $\varnothing$ 37mm type LA50 AP 230V 50Hz 1 phase 0,7kW L 220mm rotation direction right capacitor 14 $\mu$ F auxiliary pressure connection 8mm LGB		
<b>spare parts for</b>	501486		
	<b>Part No.</b>	365020	<b>Ref. No.</b> —
	operating capacitor capacity 14 $\mu$ F 400V		
	<b>Part No.</b>	510702	<b>Ref. No.</b> N/A
	mechanical shaft seal height counter ring 5,5 mm		
	<b>Part No.</b>	521024	<b>Ref. No.</b> N/A
	impellor $\varnothing$ 88 mm H 30 mm rotation direction right		
	<b>Part No.</b>	698767	<b>Ref. No.</b> —
	fan blade $\varnothing$ 110mm H 18mm shaft intake $\varnothing$ 12mm		
	<b>Part No.</b>	698768	<b>Ref. No.</b> N/A
	pump cover LGB inlet $\varnothing$ 42 mm pump type LA50 AP		
	<b>Part No.</b>	698793	<b>Ref. No.</b> —
	pump cover outlet $\varnothing$ 24/36mm pump type LGB		
	<b>Part No.</b>	698810	<b>Ref. No.</b> N/A
	O-ring EPDM thickness 3,56mm ID $\varnothing$ 112mm Qty 1 pcs		
	<b>Part No.</b>	698827	<b>Ref. No.</b> N/A
	threaded ring LGB pump type LA50 $\varnothing$ 120 mm		





1

<b>Part No.</b>	501485	<b>Ref. No.</b>	CF3265 LA500
<b>description</b>	pump inlet ø 42mm outlet ø 37mm type LA500 230V 50Hz 1 phase 0,47kW L 220mm rotation direction right capacitor 10µF auxiliary pressure connection 8mm LGB		
<b>spare parts for</b>	501485		
	<b>Part No.</b>	365015	<b>Ref. No.</b> —
	operating capacitor capacity 10µF 400V		
	<b>Part No.</b>	510702	<b>Ref. No.</b> N/A
	mechanical shaft seal height counter ring 5,5 mm		
	<b>Part No.</b>	521024	<b>Ref. No.</b> N/A
	impellor ø 88 mm H 30 mm rotation direction right		
	<b>Part No.</b>	698767	<b>Ref. No.</b> —
	fan blade ø 110mm H 18mm shaft intake ø 12mm		
	<b>Part No.</b>	698768	<b>Ref. No.</b> N/A
	pump cover LGB inlet ø 42 mm pump type LA50 AP		
	<b>Part No.</b>	698769	<b>Ref. No.</b> —
	pump casing ø 125mm outlet ø 24/37mm		
	<b>Part No.</b>	698810	<b>Ref. No.</b> N/A
	O-ring EPDM thickness 3,56mm ID ø 112mm Qty 1 pcs		
	<b>Part No.</b>	698827	<b>Ref. No.</b> N/A
	threaded ring LGB pump type LA50 ø 120 mm		



1

<b>Part No.</b>	501528	<b>Ref. No.</b>	CF3192 LA500 60HZ
<b>description</b>	pump inlet ø 42mm outlet ø 37mm type LA500 230V 60Hz 1 phase 0,46kW L 220mm rotation direction right capacitor 10µF auxiliary pressure connection 8mm LGB		
<b>spare parts for</b>	501528		
	<b>Part No.</b>	365015	<b>Ref. No.</b> —
	operating capacitor capacity 10µF 400V		
	<b>Part No.</b>	510702	<b>Ref. No.</b> N/A
	mechanical shaft seal height counter ring 5,5 mm		
	<b>Part No.</b>	521024	<b>Ref. No.</b> N/A
	impellor ø 88 mm H 30 mm rotation direction right		
	<b>Part No.</b>	698767	<b>Ref. No.</b> —
	fan blade ø 110mm H 18mm shaft intake ø 12mm		
	<b>Part No.</b>	698768	<b>Ref. No.</b> N/A
	pump cover LGB inlet ø 42 mm pump type LA50 AP		
	<b>Part No.</b>	698769	<b>Ref. No.</b> —
	pump casing ø 125mm outlet ø 24/37mm		
	<b>Part No.</b>	698810	<b>Ref. No.</b> N/A
	O-ring EPDM thickness 3,56mm ID ø 112mm Qty 1 pcs		
	<b>Part No.</b>	698827	<b>Ref. No.</b> N/A
	threaded ring LGB pump type LA50 ø 120 mm		



<b>Part No.</b>	499084	<b>Ref. No.</b>	ZF340VSX
<b>description</b>	pump inlet ø 44mm outlet ø 39mm type ZF340VSX 220-240V 50Hz 1 phase 0,7kW L 245mm rotation direction right capacitor 16µF LGB HOONVED		



<b>Part No.</b>	500553	<b>Ref. No.</b>	EPR2008 ZF290SX
<b>description</b>	pump inlet ø 45mm outlet ø 38mm type ZF290SX 230V 50Hz 1 phase 0,65kW 0,88HP L 200mm rotation direction right capacitor 12,5µF auxiliary pressure connection 13mm supporting pressure open LGB		
<b>spare parts for</b>	500553		
	<b>Part No.</b>	365014	<b>Ref. No.</b> —
	operating capacitor capacity 12,5µF 400V		
	<b>Part No.</b>	510702	<b>Ref. No.</b> N/A
	mechanical shaft seal height counter ring 5,5 mm		
	<b>Part No.</b>	521106	<b>Ref. No.</b> 0114-1R
	impellor ø 97 mm H 24 mm rotation direction right		
	<b>Part No.</b>	521542	<b>Ref. No.</b> 0878R
	pump cover LGB inlet ø 45 mm outlet ø 40 mm		
	<b>Part No.</b>	521714	<b>Ref. No.</b> 0046R 3283R
	pump cover gasket thickness 4x4mm Qty 1 pcs		



<b>Part No.</b>	499154	<b>Ref. No.</b>	EPR 1986 ZF320SX
<b>description</b>	pump inlet ø 45mm outlet ø 38mm type ZF320SX 230V 50Hz 1 phase 0,55kW 0,75HP L 205mm rotation direction right capacitor 12,5µF LGB		
<b>spare parts for</b>	499154		
	<b>Part No.</b>	365014	<b>Ref. No.</b> —
	operating capacitor capacity 12,5µF 400V		
	<b>Part No.</b>	510702	<b>Ref. No.</b> N/A
	mechanical shaft seal height counter ring 5,5 mm		
	<b>Part No.</b>	521247	<b>Ref. No.</b> N/A
	impellor ø 90 mm H 27 mm rotation direction right		
	<b>Part No.</b>	521542	<b>Ref. No.</b> 0878R
	pump cover LGB inlet ø 45 mm outlet ø 40 mm		
	<b>Part No.</b>	521714	<b>Ref. No.</b> 0046R 3283R
	pump cover gasket thickness 4x4mm Qty 1 pcs		



<b>Part No.</b>	500508	<b>Ref. No.</b>	EPR1204 ZF320VSX
<b>description</b>	pump inlet ø 45mm outlet ø 38mm type ZF320VSX 230V 50Hz 1 phase 0,75kW 1HP L 230mm rotation direction right capacitor 12,5µF LGB		
<b>spare parts for</b>	500508		
	<b>Part No.</b>	365014	<b>Ref. No.</b> —
	operating capacitor capacity 12,5µF 400V		

Table continues overleaf

<b>spare parts for</b> 500508			
	Part No.	510702	Ref. No. N/A
	mechanical shaft seal height counter ring 5,5 mm		
	Part No.	521247	Ref. No. N/A
	impellor ø 90 mm H 27 mm rotation direction right		
	Part No.	521542	Ref. No. 0878R
	pump cover LGB inlet ø 45 mm outlet ø 40 mm		
	Part No.	521714	Ref. No. 0046R 3283R
	pump cover gasket thickness 4x4mm Qty 1 pcs		



<b>Part No.</b>	499074	<b>Ref. No.</b>	EPR2906 ZF340SX
<b>description</b>	pump inlet ø 45mm outlet ø 38mm type ZF340SX 230V 50Hz 1 phase 0,7kW 0,95HP L 215mm rotation direction right capacitor 16µF auxiliary pressure connection 13mm LGB		
<b>spare parts for</b> 499074			
	Part No.	365021	Ref. No. —
	operating capacitor capacity 16µF 425V		
	Part No.	510702	Ref. No. N/A
	mechanical shaft seal height counter ring 5,5 mm		
	Part No.	521246	Ref. No. 0591-1R
	impellor ø 103 mm H 26 mm thread M8L shaft ø 20 mm		
	Part No.	521542	Ref. No. 0878R
	pump cover LGB inlet ø 45 mm outlet ø 40 mm		
	Part No.	521714	Ref. No. 0046R 3283R
	pump cover gasket thickness 4x4mm Qty 1 pcs		



<b>Part No.</b>	500586	<b>Ref. No.</b>	EPR1043 FM4023SX
<b>description</b>	pump inlet ø 45mm outlet ø 39mm type FM4023SX 230V 50Hz 1 phase 0,8kW 1,09HP L 297mm rotation direction right capacitor 16µF LGB		
<b>spare parts for</b> 500586			
	Part No.	365021	Ref. No. —
	operating capacitor capacity 16µF 425V		
	Part No.	510703	Ref. No. 1001R 1058R N/A
	mechanical shaft seal for shaft ø 13 mm		
	Part No.	521246	Ref. No. 0591-1R
	impellor ø 103 mm H 26 mm thread M8L shaft ø 20 mm		
	Part No.	521542	Ref. No. 0878R
	pump cover LGB inlet ø 45 mm outlet ø 40 mm		
	Part No.	521714	Ref. No. 0046R 3283R
	pump cover gasket thickness 4x4mm Qty 1 pcs		



<b>Part No.</b>	500984	<b>Ref. No.</b>	EPR1760 ZF270VSX 230/50/1
<b>description</b>	pump inlet ø 45mm outlet ø 39mm type ZF270VSX 230V 50Hz 1 phase 0,4kW L 209mm rotation direction right capacitor 10µF LGB		



1

<b>Part No.</b>	500157	<b>Ref. No.</b>	ZF320SX (Hoonved 31154)
<b>description</b>	pump inlet $\varnothing$ 45mm outlet $\varnothing$ 39mm type ZF320SX 230V 50Hz 1 phase 0,75kW 1HP L 200mm rotation direction right capacitor 12 $\mu$ F LGB		



1

<b>Part No.</b>	500585	<b>Ref. No.</b>	EPR1041 ZF320VSX
<b>description</b>	pump inlet $\varnothing$ 45mm outlet $\varnothing$ 39mm type ZF320VSX 230V 50Hz 1 phase 0,65kW 0,88HP L 230mm rotation direction right capacitor 12,5 $\mu$ F LGB		
<b>spare parts for</b>	500585		
	<b>Part No.</b>	365014	<b>Ref. No.</b> —
	operating capacitor capacity 12,5 $\mu$ F 400V		
	<b>Part No.</b>	510702	<b>Ref. No.</b> N/A
	mechanical shaft seal height counter ring 5,5 mm		
	<b>Part No.</b>	521106	<b>Ref. No.</b> 0114-1R
	impellor $\varnothing$ 97 mm H 24 mm rotation direction right		
	<b>Part No.</b>	521542	<b>Ref. No.</b> 0878R
	pump cover LGB inlet $\varnothing$ 45 mm outlet $\varnothing$ 40 mm		
	<b>Part No.</b>	521714	<b>Ref. No.</b> 0046R 3283R
	pump cover gasket thickness 4x4mm Qty 1 pcs		







1

<b>Part No.</b>	500398	<b>Ref. No.</b>	EPR0759 ZF320VSX
<b>description</b>	pump inlet $\varnothing$ 45mm outlet $\varnothing$ 39mm type ZF320VSX 230V 50Hz 1 phase 0,6kW 0,82HP L 230mm rotation direction right capacitor 12,5 $\mu$ F LGB		
<b>spare parts for</b>	500398		
	<b>Part No.</b>	365014	<b>Ref. No.</b> —
	operating capacitor capacity 12,5 $\mu$ F 400V		
	<b>Part No.</b>	510702	<b>Ref. No.</b> N/A
	mechanical shaft seal height counter ring 5,5 mm		
	<b>Part No.</b>	521247	<b>Ref. No.</b> N/A
	impellor $\varnothing$ 90 mm H 27 mm rotation direction right		
	<b>Part No.</b>	521542	<b>Ref. No.</b> 0878R
	pump cover LGB inlet $\varnothing$ 45 mm outlet $\varnothing$ 40 mm		
	<b>Part No.</b>	521714	<b>Ref. No.</b> 0046R 3283R
	pump cover gasket thickness 4x4mm Qty 1 pcs		





1

<b>Part No.</b>	500513	<b>Ref. No.</b>	0452 EPR0452 EPR0452A FM4023SX
<b>description</b>	pump inlet ø 45mm outlet ø 40mm type FM4023SX 230V 50Hz 1 phase 0,75kW 1HP L 300mm rotation direction right capacitor 16µF LGB		
<b>spare parts for</b>	500513		
	<b>Part No.</b>	365021	<b>Ref. No.</b> —
	operating capacitor capacity 16µF 425V		
	<b>Part No.</b>	510703	<b>Ref. No.</b> 1001R 1058R N/A
	mechanical shaft seal for shaft ø 13 mm		
	<b>Part No.</b>	521246	<b>Ref. No.</b> 0591-1R
	impellor ø 103 mm H 26 mm thread M8L shaft ø 20 mm		
	<b>Part No.</b>	521542	<b>Ref. No.</b> 0878R
	pump cover LGB inlet ø 45 mm outlet ø 40 mm		
	<b>Part No.</b>	521714	<b>Ref. No.</b> 0046R 3283R
	pump cover gasket thickness 4x4mm Qty 1 pcs		





1

<b>Part No.</b>	500942	<b>Ref. No.</b>	EPR2372 ZF150SX
<b>description</b>	pump inlet ø 45mm outlet ø 40mm type ZF150SX 230V 50Hz 1 phase 0,34kW 0,5HP L 180mm rotation direction right capacitor 10µF LGB		



1

<b>Part No.</b>	500937	<b>Ref. No.</b>	EPR2346-1 ZF150SX
<b>description</b>	pump inlet ø 45mm outlet ø 40mm type ZF150SX 230V 50Hz 1 phase 0,36kW 0,48HP L 180mm rotation direction right capacitor 10µF auxiliary pressure connection 13mm supporting pressure open LGB		
<b>spare parts for</b>	500937		
	<b>Part No.</b>	365015	<b>Ref. No.</b> —
	operating capacitor capacity 10µF 400V		
	<b>Part No.</b>	510703	<b>Ref. No.</b> 1001R 1058R N/A
	mechanical shaft seal for shaft ø 13 mm		
	<b>Part No.</b>	521701	<b>Ref. No.</b> 0044R
	pump cover gasket		



1





<b>Part No.</b>	500946	<b>Ref. No.</b>	EPR2660 ZF150SX
<b>description</b>	pump inlet ø 45mm outlet ø 40mm type ZF150SX 230V 50Hz 1 phase 0,36kW 0,5HP L 180mm rotation direction right capacitor 10µF LGB		
<b>spare parts for</b>	500946		
	<b>Part No.</b>	365015	<b>Ref. No.</b> —
	operating capacitor capacity 10µF 400V		
	<b>Part No.</b>	510703	<b>Ref. No.</b> 1001R 1058R N/A
	mechanical shaft seal for shaft ø 13 mm		

Table continues overleaf



<b>spare parts for</b> 500946			
	<b>Part No.</b>	521140	<b>Ref. No.</b> Chiocciola per Pompa EPR2660/ ZF150SX
pump cover LGB inlet $\varnothing$ 45 mm outlet $\varnothing$ 40 mm			
	<b>Part No.</b>	521701	<b>Ref. No.</b> 0044R
pump cover gasket			







1

<b>Part No.</b>	499096	<b>Ref. No.</b>	ZF220SX
<b>description</b>	pump inlet $\varnothing$ 45mm outlet $\varnothing$ 40mm type ZF220SX 230V 50Hz 1 phase 0,69kW L 188mm rotation direction right capacitor 12,5 $\mu$ F LGB		



1

<b>Part No.</b>	499248	<b>Ref. No.</b>	C.F.2062 ZF220V SX
<b>description</b>	pump inlet $\varnothing$ 45mm outlet $\varnothing$ 40mm type ZF220VSX 230V 50Hz 1 phase 0,85kW L 230mm rotation direction right capacitor 12,5 $\mu$ F LGB		





<b>spare parts for</b> 499248			
	<b>Part No.</b>	365014	<b>Ref. No.</b> —
operating capacitor capacity 12,5 $\mu$ F 400V			
	<b>Part No.</b>	510556	<b>Ref. No.</b> N/A
O-ring EPDM thickness 1,78 mm ID $\varnothing$ 94,97 mm			
	<b>Part No.</b>	510694	<b>Ref. No.</b> N/A
mechanical shaft seal for shaft $\varnothing$ 13 mm			
	<b>Part No.</b>	521112	<b>Ref. No.</b> N/A
impellor $\varnothing$ 93 mm H 21 mm pump type ZF220VSX			
	<b>Part No.</b>	521113	<b>Ref. No.</b> N/A
pump cover LGB inlet $\varnothing$ 45 mm outlet $\varnothing$ 40 mm			



1

<b>Part No.</b>	500470	<b>Ref. No.</b>	EPR2046 ZF270V DX
-----------------	--------	-----------------	-------------------

<b>description</b>	pump inlet $\varnothing$ 45mm outlet $\varnothing$ 40mm type ZF270V DX 230V 50Hz 1 phase 0,6kW 0,8HP L 225mm rotation direction left capacitor 12,5 $\mu$ F LGB		
--------------------	---	--	--

<b>spare parts for</b> 500470			
	<b>Part No.</b>	365014	<b>Ref. No.</b> —
operating capacitor capacity 12,5 $\mu$ F 400V			
	<b>Part No.</b>	510702	<b>Ref. No.</b> N/A
mechanical shaft seal height counter ring 5,5 mm			
	<b>Part No.</b>	521109	<b>Ref. No.</b> 1572R
pump cover LGB inlet $\varnothing$ 45 mm outlet $\varnothing$ 40 mm			
	<b>Part No.</b>	521111	<b>Ref. No.</b> 1574-1R
impellor $\varnothing$ 105 mm H 29 mm thread M8R shaft $\varnothing$ 20 mm			
	<b>Part No.</b>	521714	<b>Ref. No.</b> 0046R 3283R
pump cover gasket thickness 4x4mm Qty 1 pcs			



1

<b>Part No.</b>	500584	<b>Ref. No.</b>	EPR1040 ZF290SX
<b>description</b>	pump inlet ø 45mm outlet ø 40mm type ZF290SX 230V 50Hz 1 phase 0,65kW 0,88HP L 200mm rotation direction right capacitor 12,5µF LGB		
<b>spare parts for</b>	500584		
	<b>Part No.</b>	365014	<b>Ref. No.</b> —
	operating capacitor capacity 12,5µF 400V		
	<b>Part No.</b>	510702	<b>Ref. No.</b> N/A
	mechanical shaft seal height counter ring 5,5 mm		
	<b>Part No.</b>	521106	<b>Ref. No.</b> 0114-1R
	impellor ø 97 mm H 24 mm rotation direction right		
	<b>Part No.</b>	521542	<b>Ref. No.</b> 0878R
	pump cover LGB inlet ø 45 mm outlet ø 40 mm		
	<b>Part No.</b>	521714	<b>Ref. No.</b> 0046R 3283R
	pump cover gasket thickness 4x4mm Qty 1 pcs		



1

<b>Part No.</b>	500554	<b>Ref. No.</b>	EPR2030 ZF290SX
<b>description</b>	pump inlet ø 45mm outlet ø 40mm type ZF290SX 230V 50Hz 1 phase 0,67kW 0,8HP L 200mm rotation direction right capacitor 12,5µF LGB		
<b>spare parts for</b>	500554		
	<b>Part No.</b>	365014	<b>Ref. No.</b> —
	operating capacitor capacity 12,5µF 400V		



1

<b>Part No.</b>	500120	<b>Ref. No.</b>	EPR0926 ZF320SX
<b>description</b>	pump inlet ø 45mm outlet ø 40mm type ZF320SX 230V 50Hz 1 phase 0,55kW 0,75HP L 200mm rotation direction right capacitor 12,5µF LGB		
<b>spare parts for</b>	500120		
	<b>Part No.</b>	365014	<b>Ref. No.</b> —
	operating capacitor capacity 12,5µF 400V		
	<b>Part No.</b>	510702	<b>Ref. No.</b> N/A
	mechanical shaft seal height counter ring 5,5 mm		
	<b>Part No.</b>	521300	<b>Ref. No.</b> 0697-1R
	impellor ø 94 mm H 27 mm pump type ZF320SX		
	<b>Part No.</b>	521542	<b>Ref. No.</b> 0878R
	pump cover LGB inlet ø 45 mm outlet ø 40 mm		
	<b>Part No.</b>	521714	<b>Ref. No.</b> 0046R 3283R
	pump cover gasket thickness 4x4mm Qty 1 pcs		







1

<b>Part No.</b>	500919	<b>Ref. No.</b>	EPR0629 ZF320SX
<b>description</b>	pump inlet ø 45mm outlet ø 40mm type ZF320SX 230V 50Hz 1 phase 0,55kW 0,75HP L 200mm rotation direction right capacitor 12µF LGB		











1

<b>Part No.</b>	500121	<b>Ref. No.</b>	EPR0630 ZF320SX
<b>description</b>	pump inlet $\varnothing$ 45mm outlet $\varnothing$ 40mm type ZF320SX 230V 50Hz 1 phase 0,55kW 0,75HP L 220mm rotation direction right capacitor 12,5 $\mu$ F LGB		
<b>spare parts for</b>	500121		
	<b>Part No.</b>	365014	<b>Ref. No.</b> —
	operating capacitor capacity 12,5 $\mu$ F 400V		
	<b>Part No.</b>	510702	<b>Ref. No.</b> N/A
	mechanical shaft seal height counter ring 5,5 mm		
	<b>Part No.</b>	521300	<b>Ref. No.</b> 0697-1R
	impellor $\varnothing$ 94 mm H 27 mm pump type ZF320SX		
	<b>Part No.</b>	521542	<b>Ref. No.</b> 0878R
	pump cover LGB inlet $\varnothing$ 45 mm outlet $\varnothing$ 40 mm		
	<b>Part No.</b>	521714	<b>Ref. No.</b> 0046R 3283R
	pump cover gasket thickness 4x4mm Qty 1 pcs		



1

<b>Part No.</b>	500355	<b>Ref. No.</b>	EPR1356 ZF320SX
<b>description</b>	pump inlet $\varnothing$ 45mm outlet $\varnothing$ 40mm type ZF320SX 230V 50Hz 1 phase 0,7kW 0,95HP L 200mm rotation direction right capacitor 12,5 $\mu$ F LGB		
<b>spare parts for</b>	500355		
	<b>Part No.</b>	365014	<b>Ref. No.</b> —
	operating capacitor capacity 12,5 $\mu$ F 400V		

<b>spare parts for</b> 500355			
	<b>Part No.</b>	510702	<b>Ref. No.</b> N/A
	mechanical shaft seal height counter ring 5,5 mm		
	<b>Part No.</b>	512404	<b>Ref. No.</b> 0438R
	bracket mounting distance 130mm		
	<b>Part No.</b>	521246	<b>Ref. No.</b> 0591-1R
	impellor $\varnothing$ 103 mm H 26 mm thread M8L shaft $\varnothing$ 20 mm		
	<b>Part No.</b>	521542	<b>Ref. No.</b> 0878R
	pump cover LGB inlet $\varnothing$ 45 mm outlet $\varnothing$ 40 mm		
	<b>Part No.</b>	521714	<b>Ref. No.</b> 0046R 3283R
	pump cover gasket thickness 4x4mm Qty 1 pcs		



1

<b>Part No.</b>	500381	<b>Ref. No.</b>	EPR0713 ZF320VSX
<b>description</b>	pump inlet $\varnothing$ 45mm outlet $\varnothing$ 40mm type ZF320VSX 230V 50Hz 1 phase 0,6kW 0,82HP L 230mm rotation direction right capacitor 12,5 $\mu$ F LGB		
<b>spare parts for</b>	500381		
	<b>Part No.</b>	365014	<b>Ref. No.</b> —
	operating capacitor capacity 12,5 $\mu$ F 400V		
	<b>Part No.</b>	510702	<b>Ref. No.</b> N/A
	mechanical shaft seal height counter ring 5,5 mm		
	<b>Part No.</b>	512420	<b>Ref. No.</b> 0437R
	bracket mounting distance 110mm		
	<b>Part No.</b>	521058	<b>Ref. No.</b> 2899R
	fanwheel cover suitable for LGB ID $\varnothing$ 138mm		
	<b>Part No.</b>	521247	<b>Ref. No.</b> N/A
	impellor $\varnothing$ 90 mm H 27 mm rotation direction right		
	<b>Part No.</b>	521542	<b>Ref. No.</b> 0878R
	pump cover LGB inlet $\varnothing$ 45 mm outlet $\varnothing$ 40 mm		
	<b>Part No.</b>	521714	<b>Ref. No.</b> 0046R 3283R
	pump cover gasket thickness 4x4mm Qty 1 pcs		





1

<b>Part No.</b>	500512	<b>Ref. No.</b>	EPR1227 ZF340VSX
<b>description</b>	pump inlet ø 45mm outlet ø 40mm type ZF340VSX 230V 50Hz 1 phase 0,75kW 1HP L 245mm rotation direction right capacitor 16µF LGB		
<b>spare parts for</b>	500512		
	<b>Part No.</b>	365021	<b>Ref. No.</b> —
	operating capacitor capacity 16µF 425V		
	<b>Part No.</b>	510702	<b>Ref. No.</b> N/A
	mechanical shaft seal height counter ring 5,5 mm		
	<b>Part No.</b>	521246	<b>Ref. No.</b> 0591-1R
	impellor ø 103 mm H 26 mm thread M8L shaft ø 20 mm		
	<b>Part No.</b>	521542	<b>Ref. No.</b> 0878R
	pump cover LGB inlet ø 45 mm outlet ø 40 mm		
	<b>Part No.</b>	521714	<b>Ref. No.</b> 0046R 3283R
	pump cover gasket thickness 4x4mm Qty 1 pcs		



1

<b>Part No.</b>	499135	<b>Ref. No.</b>	EPR2898 ZF350SX
<b>description</b>	pump inlet ø 45mm outlet ø 40mm type ZF350SX 230/400V 50Hz 3 phase 0,61kW L 220mm rotation direction right LGB		
<b>spare parts for</b>	499135		
	<b>Part No.</b>	510702	<b>Ref. No.</b> N/A
	mechanical shaft seal height counter ring 5,5 mm		

<b>spare parts for</b>	499135		
	<b>Part No.</b>	521089	<b>Ref. No.</b> 2037R
	impellor ø 88 mm H 32 mm thread M8L		
	<b>Part No.</b>	521542	<b>Ref. No.</b> 0878R
	pump cover LGB inlet ø 45 mm outlet ø 40 mm		
	<b>Part No.</b>	521714	<b>Ref. No.</b> 0046R 3283R
	pump cover gasket thickness 4x4mm Qty 1 pcs		



1

<b>Part No.</b>	499011	<b>Ref. No.</b>	EPR2022 ZF350SX
<b>description</b>	pump inlet ø 50mm outlet ø 40mm type ZF350SX 230V 50Hz 1 phase 0,63kW L 201mm rotation direction right LGB 2800rpm suitable capacitor 12,5µF		
<b>spare parts for</b>	499011		
	<b>Part No.</b>	365014	<b>Ref. No.</b> —
	operating capacitor capacity 12,5µF 400V		
	<b>Part No.</b>	510702	<b>Ref. No.</b> N/A
	mechanical shaft seal height counter ring 5,5 mm		
	<b>Part No.</b>	521086	<b>Ref. No.</b> 1435R
	pump cover LGB inlet ø 50 mm outlet ø 40 mm		
	<b>Part No.</b>	521278	<b>Ref. No.</b> 2037R
	impellor ø 93 mm H 32 mm pump type ZF350SX		
	<b>Part No.</b>	521714	<b>Ref. No.</b> 0046R 3283R
	pump cover gasket thickness 4x4mm Qty 1 pcs		







1

<b>Part No.</b>	500924	<b>Ref. No.</b>	EPR2353-1 ZF350VSX
<b>description</b>	pump inlet $\varnothing$ 50mm outlet $\varnothing$ 40mm type ZF350VSX 440V 60Hz 3 phase 0,75kW 1HP L 230mm rotation direction right LGB		



1



<b>Part No.</b>	499058	<b>Ref. No.</b>	EPR2024 ZF380SX
<b>description</b>	pump inlet $\varnothing$ 50mm outlet $\varnothing$ 40mm type ZF380SX 230V 50Hz 1 phase 0,73kW 0,99HP L 210mm rotation direction right capacitor 16 $\mu$ F LGB		

<b>spare parts for</b>	499058			
	<b>Part No.</b>	365021	<b>Ref. No.</b>	—
		operating capacitor capacity 16 $\mu$ F 425V		
	<b>Part No.</b>	510702	<b>Ref. No.</b>	N/A
		mechanical shaft seal height counter ring 5,5 mm		
	<b>Part No.</b>	521086	<b>Ref. No.</b>	1435R
		pump cover LGB inlet $\varnothing$ 50 mm outlet $\varnothing$ 40 mm		
	<b>Part No.</b>	521087	<b>Ref. No.</b>	2038-1R
		impellor $\varnothing$ 100 mm H 32 mm thread M8L		
	<b>Part No.</b>	521714	<b>Ref. No.</b>	0046R 3283R
		pump cover gasket thickness 4x4mm Qty 1 pcs		



1

<b>Part No.</b>	500092	<b>Ref. No.</b>	W300SX
<b>description</b>	pump inlet $\varnothing$ 50mm outlet $\varnothing$ 44mm type W300SX 230V 50Hz 1 phase 0,3kW 0,5HP L 170mm rotation direction right capacitor 10 $\mu$ F LGB		

<b>spare parts for</b>	500092			
	<b>Part No.</b>	365015	<b>Ref. No.</b>	—
		operating capacitor capacity 10 $\mu$ F 400V		
	<b>Part No.</b>	510554	<b>Ref. No.</b>	n/a
		O-ring EPDM thickness 2 mm ID $\varnothing$ 120 mm Qty 1 pcs		
	<b>Part No.</b>	510607	<b>Ref. No.</b>	N/A
		impellor $\varnothing$ 85 mm H 29 mm shaft intake $\varnothing$ 9x8mm		
	<b>Part No.</b>	510693	<b>Ref. No.</b>	N/A
		mechanical shaft seal for shaft $\varnothing$ 12 mm		
	<b>Part No.</b>	511178	<b>Ref. No.</b>	—
		pump cover bottom part		
	<b>Part No.</b>	521564	<b>Ref. No.</b>	N/A
		pump cover		



1

<b>Part No.</b>	500093	<b>Ref. No.</b>	EPR0962 W500SX
<b>description</b>	pump inlet $\varnothing$ 50mm outlet $\varnothing$ 44mm type W500SX 230V 50Hz 1 phase 0,5kW 0,7HP L 200mm rotation direction right capacitor 16 $\mu$ F LGB		





<b>spare parts for</b>	500093			
	<b>Part No.</b>	365021	<b>Ref. No.</b>	—
		operating capacitor capacity 16 $\mu$ F 425V		
	<b>Part No.</b>	510607	<b>Ref. No.</b>	N/A
		impellor $\varnothing$ 85 mm H 29 mm shaft intake $\varnothing$ 9x8mm		







Table continues overleaf

<b>spare parts for</b> 500093			
	Part No.	510693	Ref. No. N/A
	mechanical shaft seal for shaft $\varnothing$ 12 mm		
	Part No.	521564	Ref. No. N/A
	pump cover		
	Part No.	521717	Ref. No. N/A
	O-ring EPDM thickness 1,78 mm ID $\varnothing$ 120,37 mm		



<b>Part No.</b>	499306	<b>Ref. No.</b>	ZF650SX (2473 - 9099.ZF650.00)
<b>description</b>	pump inlet $\varnothing$ 50mm outlet $\varnothing$ 48mm type ZF650SX 230V 50Hz 1 phase 1,47kW L 340mm rotation direction right LGB		
<b>spare parts for</b> 499306			
	Part No.	365019	Ref. No. —
	operating capacitor capacity 20 $\mu$ F 400V		
	Part No.	510551	Ref. No. 0049R
	pump cover gasket ID $\varnothing$ 158,3 mm		
	Part No.	510694	Ref. No. N/A
	mechanical shaft seal for shaft $\varnothing$ 13 mm		
	Part No.	521108	Ref. No. 0021R
	pump cover LGB inlet $\varnothing$ 50 mm outlet $\varnothing$ 50 mm		
	Part No.	521240	Ref. No. 2500R
	impellor $\varnothing$ 110 mm H 32 mm rotation direction left		



<b>Part No.</b>	500156	<b>Ref. No.</b>	EPR0461 ZF400SX
<b>description</b>	pump inlet $\varnothing$ 50mm outlet $\varnothing$ 50mm type ZF400SX 230V 50Hz 1 phase 0,6kW 0,8HP L 210mm rotation direction right capacitor 16 $\mu$ F LGB		
<b>spare parts for</b> 500156			
	Part No.	365021	Ref. No. —
	operating capacitor capacity 16 $\mu$ F 425V		
	Part No.	509020	Ref. No. 1834R
	impellor $\varnothing$ 104 mm H 25 mm M8L		
	Part No.	510703	Ref. No. 1001R 1058R N/A
	mechanical shaft seal for shaft $\varnothing$ 13 mm		
	Part No.	521548	Ref. No. 0020R
	pump cover LGB inlet $\varnothing$ 50 mm outlet $\varnothing$ 50 mm		
	Part No.	521734	Ref. No. —
	pump cover bottom part		
	Part No.	523509	Ref. No. —
	deep-groove ball bearing type 6201-2RS		
	Part No.	532623	Ref. No. 1743R
	O-ring EPDM thickness 2,62mm ID $\varnothing$ 120,32mm		



1

Part No.	499225	Ref. No.	ZF400VSX
----------	--------	----------	----------

**description** pump inlet  $\varnothing$  50mm outlet  $\varnothing$  50mm type ZF400VSX 230V 50Hz 1 phase 0,81kW 1,1HP L 245mm rotation direction right capacitor 16 $\mu$ F C 34 dgt / C 44 dgt LGB

**spare parts for** 499225

Part No.	365021	Ref. No.	—
----------	--------	----------	---

 operating capacitor capacity 16 $\mu$ F 425V

Part No.	510703	Ref. No.	1001R 1058R N/A
----------	--------	----------	-----------------

 mechanical shaft seal for shaft  $\varnothing$  13 mm

Part No.	521090	Ref. No.	Girante per Pompa ZF400SX EPR2287
----------	--------	----------	-----------------------------------

 impellor  $\varnothing$  101 mm H 32 mm thread M8L shaft  $\varnothing$  13 mm

Part No.	521548	Ref. No.	0020R
----------	--------	----------	-------

 pump cover LGB inlet  $\varnothing$  50 mm outlet  $\varnothing$  50 mm

Part No.	532623	Ref. No.	1743R
----------	--------	----------	-------

 O-ring EPDM thickness 2,62mm ID  $\varnothing$  120,32mm



1

Part No.	500543	Ref. No.	EPR0634 ZF400VSX
----------	--------	----------	------------------

**description** pump inlet  $\varnothing$  50mm outlet  $\varnothing$  50mm type ZF400VSX 230V 50Hz 1 phase 0,85kW 1,2HP L 245mm rotation direction right capacitor 16 $\mu$ F LGB

**spare parts for** 500543





Part No.	365021	Ref. No.	—
----------	--------	----------	---

 operating capacitor capacity 16 $\mu$ F 425V

Part No.	509020	Ref. No.	1834R
----------	--------	----------	-------

 impellor  $\varnothing$  104 mm H 25 mm M8L

**spare parts for** 500543

Part No.	510703	Ref. No.	1001R 1058R N/A
	mechanical shaft seal for shaft $\varnothing$ 13 mm		
Part No.	521548	Ref. No.	0020R
	pump cover LGB inlet $\varnothing$ 50 mm outlet $\varnothing$ 50 mm		
Part No.	521734	Ref. No.	—
	pump cover bottom part		
Part No.	532623	Ref. No.	1743R
	O-ring EPDM thickness 2,62mm ID $\varnothing$ 120,32mm		



1

Part No.	500361	Ref. No.	EPR1230 ZF400SX
----------	--------	----------	-----------------

**description** pump inlet  $\varnothing$  60mm outlet  $\varnothing$  49mm type ZF400SX 230V 50Hz 1 phase 0,8kW 1HP L 210mm rotation direction right capacitor 16 $\mu$ F LGB

**spare parts for** 500361

Part No.	365021	Ref. No.	—
----------	--------	----------	---

 operating capacitor capacity 16 $\mu$ F 425V

Part No.	509020	Ref. No.	1834R
----------	--------	----------	-------

 impellor  $\varnothing$  104 mm H 25 mm M8L

Part No.	510703	Ref. No.	1001R 1058R N/A
----------	--------	----------	-----------------

 mechanical shaft seal for shaft  $\varnothing$  13 mm

Part No.	521547	Ref. No.	0758R 0758R (blu)
----------	--------	----------	-------------------

 pump cover LGB inlet  $\varnothing$  60 mm outlet  $\varnothing$  50 mm

Part No.	532623	Ref. No.	1743R
----------	--------	----------	-------

 O-ring EPDM thickness 2,62mm ID  $\varnothing$  120,32mm





1

<b>Part No.</b>	501527	<b>Ref. No.</b>	CF2420 ZF400SX 60HZ
<b>description</b>	pump inlet ø 60mm outlet ø 49mm type ZF400SX 230V 60Hz 1 phase 0,77kW 1HP L 210mm rotation direction right capacitor 16µF LGB		
<b>spare parts for</b>	501527		
	Part No.	365021	Ref. No. —
	operating capacitor capacity 16µF 425V		
	Part No.	509020	Ref. No. 1834R
	impellor ø 104 mm H 25 mm M8L		
	Part No.	510703	Ref. No. 1001R 1058R N/A
	mechanical shaft seal for shaft ø 13 mm		
	Part No.	521547	Ref. No. 0758R 0758R (blu)
	pump cover LGB inlet ø 60 mm outlet ø 50 mm		
	Part No.	532623	Ref. No. 1743R
	O-ring EPDM thickness 2,62mm ID ø 120,32mm		



1

<b>Part No.</b>	499282	<b>Ref. No.</b>	2196 ZF400VSX
<b>description</b>	pump inlet ø 60mm outlet ø 49mm type ZF400VSX 220-230/380-400V 50Hz 3 phase 0,7kW L 270mm rotation direction right LGB		
<b>spare parts for</b>	499282		
	Part No.	502279	Ref. No. 2038R
	impellor H 31 mm ED ø 100 mm blades 6		
	Part No.	510702	Ref. No. N/A
	mechanical shaft seal height counter ring 5,5 mm		
	Part No.	521058	Ref. No. 2899R
	fanwheel cover suitable for LGB ID ø 138mm		

<b>spare parts for</b>	499282		
	Part No.	521547	Ref. No. 0758R 0758R (blu)
	pump cover LGB inlet ø 60 mm outlet ø 50 mm		
	Part No.	532623	Ref. No. 1743R
	O-ring EPDM thickness 2,62mm ID ø 120,32mm		







1

<b>Part No.</b>	499114	<b>Ref. No.</b>	EPR1831
<b>description</b>	pump inlet ø 60mm outlet ø 50mm 220-240V 50Hz 1 phase 0,7kW L 245mm rotation direction right capacitor 16µF		
<b>spare parts for</b>	499114		
	Part No.	365021	Ref. No. —
	operating capacitor capacity 16µF 425V		
	Part No.	509020	Ref. No. 1834R
	impellor ø 104 mm H 25 mm M8L		
	Part No.	510703	Ref. No. 1001R 1058R N/A
	mechanical shaft seal for shaft ø 13 mm		
<b>image not available</b>	Part No.	521049	Ref. No. —
	service kit for pump type ZF400VSX LGB		
	Part No.	521547	Ref. No. 0758R 0758R (blu)
	pump cover LGB inlet ø 60 mm outlet ø 50 mm		
	Part No.	532623	Ref. No. 1743R
	O-ring EPDM thickness 2,62mm ID ø 120,32mm		





1



<b>Part No.</b>	500001	<b>Ref. No.</b>	EPR1638 T150SX
<b>description</b>	pump inlet ø 60mm outlet ø 50mm type T150SX 230/400V 50Hz 3 phase 0,9kW 1,2HP L 290mm rotation direction right LGB		
<b>spare parts for</b>	500001		
	Part No.	509020	Ref. No. 1834R
	impellor ø 104 mm H 25 mm M8L		
	Part No.	510703	Ref. No. 1001R 1058R N/A
	mechanical shaft seal for shaft ø 13 mm		
	Part No.	521547	Ref. No. 0758R 0758R (blu)
	pump cover LGB inlet ø 60 mm outlet ø 50 mm		
	Part No.	532623	Ref. No. 1743R
	O-ring EPDM thickness 2,62mm ID ø 120,32mm		



1



<b>Part No.</b>	500091	<b>Ref. No.</b>	EPR0464 ZA160SX
<b>description</b>	pump inlet ø 60mm outlet ø 50mm type ZA160SX 230/400V 50Hz 3 phase 1,1kW 1,5HP L 310mm rotation direction right LGB		
<b>spare parts for</b>	500091		
	Part No.	510554	Ref. No. n/a
	O-ring EPDM thickness 2 mm ID ø 120 mm Qty 1 pcs		
	Part No.	510616	Ref. No. 0123R
	impellor ø 104 mm H 25 mm shaft intake ø 10 mm		

## spare parts for 500091

	Part No.	510703	Ref. No.	1001R 1058R N/A
	mechanical shaft seal for shaft ø 13 mm			
	Part No.	521547	Ref. No.	0758R 0758R (blu)
	pump cover LGB inlet ø 60 mm outlet ø 50 mm			



1

<b>Part No.</b>	500148	<b>Ref. No.</b>	EPR0650 ZA160SX
<b>description</b>	pump inlet ø 60mm outlet ø 50mm type ZA160SX 230V 50Hz 1 phase 1,1kW 1,5HP L 310mm rotation direction right capacitor 25µF LGB		
<b>spare parts for</b>	500148		
	Part No.	365109	Ref. No. —
	operating capacitor capacity 25µF 400V		
	Part No.	510616	Ref. No. 0123R
	impellor ø 104 mm H 25 mm shaft intake ø 10 mm		
	Part No.	510703	Ref. No. 1001R 1058R N/A
	mechanical shaft seal for shaft ø 13 mm		
	Part No.	521547	Ref. No. 0758R 0758R (blu)
	pump cover LGB inlet ø 60 mm outlet ø 50 mm		
	Part No.	532623	Ref. No. 1743R
	O-ring EPDM thickness 2,62mm ID ø 120,32mm		



1

<b>Part No.</b>	500002	<b>Ref. No.</b>	EPR0460A ZA400SX
<b>description</b>	pump inlet ø 60mm outlet ø 50mm type ZA400SX 230V 50Hz 1 phase 0,9kW 1,2HP L 300mm rotation direction right capacitor 20µF LGB		
<b>spare parts for</b>	500002		
	<b>Part No.</b>	<b>Ref. No.</b>	—
	365019		
	operating capacitor capacity 20µF 400V		
	<b>Part No.</b>	<b>Ref. No.</b>	1834R
	509020		
	impellor ø 104 mm H 25 mm M8L		
	<b>Part No.</b>	<b>Ref. No.</b>	1001R 1058R N/A
	510703		
	mechanical shaft seal for shaft ø 13 mm		
	<b>Part No.</b>	<b>Ref. No.</b>	0758R 0758R (blu)
	521547		
	pump cover LGB inlet ø 60 mm outlet ø 50 mm		
	<b>Part No.</b>	<b>Ref. No.</b>	1743R
	532623		
	O-ring EPDM thickness 2,62mm ID ø 120,32mm		



1

<b>Part No.</b>	500474	<b>Ref. No.</b>	EPR1622 ZF400SX
<b>description</b>	pump inlet ø 60mm outlet ø 50mm type ZF400SX 230V 50Hz 1 phase 0,7kW 0,95HP L 215mm rotation direction right capacitor 16µF LGB		
<b>spare parts for</b>	500474		
	<b>Part No.</b>	<b>Ref. No.</b>	—
	365021		
	operating capacitor capacity 16µF 425V		

<b>spare parts for</b> 500474			
	<b>Part No.</b>	<b>Ref. No.</b>	1834R
	509020		
	impellor ø 104 mm H 25 mm M8L		
	<b>Part No.</b>	<b>Ref. No.</b>	1001R 1058R N/A
	510703		
	mechanical shaft seal for shaft ø 13 mm		
	<b>Part No.</b>	<b>Ref. No.</b>	0758R 0758R (blu)
	521547		
	pump cover LGB inlet ø 60 mm outlet ø 50 mm		
	<b>Part No.</b>	<b>Ref. No.</b>	1743R
	532623		
	O-ring EPDM thickness 2,62mm ID ø 120,32mm		







1

<b>Part No.</b>	499126	<b>Ref. No.</b>	EPR2287 ZF400SX
<b>description</b>	pump inlet ø 60mm outlet ø 50mm type ZF400SX 230V 50Hz 1 phase 1,1kW L 215mm rotation direction right capacitor 16µF LGB		
<b>spare parts for</b>	499126		
	<b>Part No.</b>	<b>Ref. No.</b>	—
	365021		
	operating capacitor capacity 16µF 425V		
	<b>Part No.</b>	<b>Ref. No.</b>	1001R 1058R N/A
	510703		
	mechanical shaft seal for shaft ø 13 mm		
	<b>Part No.</b>	<b>Ref. No.</b>	Girante per Pompa ZF400SX EPR2287
	521090		
	impellor ø 101 mm H 32 mm thread M8L shaft ø 13 mm		
	<b>Part No.</b>	<b>Ref. No.</b>	0758R 0758R (blu)
	521547		
	pump cover LGB inlet ø 60 mm outlet ø 50 mm		
	<b>Part No.</b>	<b>Ref. No.</b>	1743R
	532623		
	O-ring EPDM thickness 2,62mm ID ø 120,32mm		



<b>Part No.</b>	500486	<b>Ref. No.</b>	EPR1623 ZF400SX
<b>description</b>	pump inlet $\varnothing$ 60mm outlet $\varnothing$ 50mm type ZF400VSX 230V 50Hz 1 phase 0,7kW 0,95HP L 255mm rotation direction right capacitor 16 $\mu$ F LGB		
<b>spare parts for</b>	500486		
	<b>Part No.</b>	365021	<b>Ref. No.</b> —
	operating capacitor capacity 16 $\mu$ F 425V		
	<b>Part No.</b>	509020	<b>Ref. No.</b> 1834R
	impellor $\varnothing$ 104 mm H 25 mm M8L		
	<b>Part No.</b>	510703	<b>Ref. No.</b> 1001R 1058R N/A
	mechanical shaft seal for shaft $\varnothing$ 13 mm		
	<b>Part No.</b>	512404	<b>Ref. No.</b> 0438R
	bracket mounting distance 130mm		
	<b>Part No.</b>	521058	<b>Ref. No.</b> 2899R
	fanwheel cover suitable for LGB ID $\varnothing$ 138mm		
	<b>Part No.</b>	521547	<b>Ref. No.</b> 0758R 0758R (blu)
	pump cover LGB inlet $\varnothing$ 60 mm outlet $\varnothing$ 50 mm		
	<b>Part No.</b>	532623	<b>Ref. No.</b> 1743R
	O-ring EPDM thickness 2,62mm ID $\varnothing$ 120,32mm		



<b>Part No.</b>	500377	<b>Ref. No.</b>	EPR1007 ZF800DX
<b>description</b>	pump inlet $\varnothing$ 61mm outlet $\varnothing$ 52mm type ZF800DX 230/400V 50Hz 3 phase 2kW 2,72HP L 330mm rotation direction left LGB		
<b>spare parts for</b>	500377		
	<b>Part No.</b>	510551	<b>Ref. No.</b> 0049R
	pump cover gasket ID $\varnothing$ 158,3 mm		
	<b>Part No.</b>	510694	<b>Ref. No.</b> N/A
	mechanical shaft seal for shaft $\varnothing$ 13 mm		
	<b>Part No.</b>	521276	<b>Ref. No.</b> 1360-1R
	impellor $\varnothing$ 120 mm H 39 mm pump type ZF800DX		
	<b>Part No.</b>	521516	<b>Ref. No.</b> 0648R
	pump cover LGB inlet $\varnothing$ 62 mm outlet $\varnothing$ 52 mm		











<b>Part No.</b>	500380	<b>Ref. No.</b>	EPR1208 ZF1200SX
<b>description</b>	pump inlet $\varnothing$ 61mm outlet $\varnothing$ 61mm type ZF1200SX 230/400V 50Hz 3 phase 3,2kW 4,4HP L 370mm rotation direction right capacitor 16 $\mu$ F LGB		
<b>spare parts for</b>	500380		
	<b>Part No.</b>	510896	<b>Ref. No.</b> 1158R
	O-ring EPDM thickness 3,53mm ID $\varnothing$ 183,75mm		
	<b>Part No.</b>	521053	<b>Ref. No.</b> 1139R
	pump cover LGB inlet $\varnothing$ 61 mm outlet $\varnothing$ 61 mm		

Table continues overleaf







<b>spare parts for</b> 500380			
	Part No.	521054	Ref. No. 1161-1R
impellor ø 135 mm H 37 mm shaft intake ø 18 mm			
	Part No.	521055	Ref. No. 1159R
slide ring with gasket ID ø 21 mm			
	Part No.	521056	Ref. No. 1160R
slide ring for shaft ø 20mm ED ø 39mm H 16mm			







1			
<b>Part No.</b>	499241	<b>Ref. No.</b>	ZF650SX
<b>description</b>	pump inlet ø 62mm outlet ø 48mm type ZF650SX 230/400V 50Hz 3 phase 1,33kW L 340mm rotation direction right LGB		
<b>spare parts for</b> 499241			
	Part No.	510551	Ref. No. 0049R
pump cover gasket ID ø 158,3 mm			
	Part No.	510694	Ref. No. N/A
mechanical shaft seal for shaft ø 13 mm			
	Part No.	521240	Ref. No. 2500R
impellor ø 110 mm H 32 mm rotation direction left			
	Part No.	521536	Ref. No. 0022R
pump cover ALBA / LGB inlet ø 62 mm outlet ø 50 mm			



1			
<b>Part No.</b>	500376	<b>Ref. No.</b>	AM5225SX EPR1020 EPR1020A
<b>description</b>	pump inlet ø 62mm outlet ø 50mm type AM5225SX 230V 50Hz 1 phase 0,9kW 1,2HP L 300mm rotation direction right capacitor 16µF LGB		
<b>spare parts for</b> 500376			
	Part No.	365021	Ref. No. —
operating capacitor capacity 16µF 425V			
	Part No.	510551	Ref. No. 0049R
pump cover gasket ID ø 158,3 mm			
	Part No.	510694	Ref. No. N/A
mechanical shaft seal for shaft ø 13 mm			
	Part No.	512029	Ref. No. 1339D103
impellor ø 103 mm H 26 mm thread M8L shaft ø 19 mm			
	Part No.	521536	Ref. No. 0022R
pump cover ALBA / LGB inlet ø 62 mm outlet ø 50 mm			







1

<b>Part No.</b>	500362	<b>Ref. No.</b>	CE150SX EPR0727
<b>description</b>	pump inlet $\varnothing$ 62mm outlet $\varnothing$ 50mm type CE150SX 230/400V 50Hz 3 phase 1,1kW 1,5HP L 280mm rotation direction right LGB		
<b>spare parts for</b>	500362		
	Part No.	510551	Ref. No. 0049R
	pump cover gasket ID $\varnothing$ 158,3 mm		
	Part No.	510693	Ref. No. N/A
	mechanical shaft seal for shaft $\varnothing$ 12 mm		
	Part No.	521240	Ref. No. 2500R
	impellor $\varnothing$ 110 mm H 32 mm rotation direction left		
	Part No.	521536	Ref. No. 0022R
	pump cover ALBA / LGB inlet $\varnothing$ 62 mm outlet $\varnothing$ 50 mm		
	Part No.	602013	Ref. No. Lüfterrad für 500362 Ventola per 500362
	fan wheel $\varnothing$ 100mm H 28mm shaft intake $\varnothing$ 17,5mm		



1

<b>Part No.</b>	500360	<b>Ref. No.</b>	EPR1231 ZF522SX
<b>description</b>	pump inlet $\varnothing$ 62mm outlet $\varnothing$ 50mm type ZF522SX 230V 50Hz 1 phase 1,1kW 1,5HP L 220mm rotation direction right capacitor 16 $\mu$ F LGB		
<b>spare parts for</b>	500360		
	Part No.	365021	Ref. No. —
	operating capacitor capacity 16 $\mu$ F 425V		
	Part No.	510551	Ref. No. 0049R
	pump cover gasket ID $\varnothing$ 158,3 mm		
	Part No.	510693	Ref. No. N/A
	mechanical shaft seal for shaft $\varnothing$ 12 mm		
	Part No.	521280	Ref. No. 1339-1R
	impellor $\varnothing$ 107 mm H 26 mm thread M8L shaft $\varnothing$ 20 mm		
	Part No.	521536	Ref. No. 0022R
	pump cover ALBA / LGB inlet $\varnothing$ 62 mm outlet $\varnothing$ 50 mm		



1

<b>Part No.</b>	499163	<b>Ref. No.</b>	C.F.2147 EPR 2147 kundenschutz ZF 522VSX
<b>description</b>	pump inlet $\varnothing$ 62mm outlet $\varnothing$ 50mm type ZF522VSX 230V 50Hz 1 phase 0,76kW 1HP L 255mm rotation direction right capacitor 16 $\mu$ F LGB		
<b>spare parts for</b>	499163		
	Part No.	365021	Ref. No. —
	operating capacitor capacity 16 $\mu$ F 425V		
	Part No.	510551	Ref. No. 0049R
	pump cover gasket ID $\varnothing$ 158,3 mm		
	Part No.	510693	Ref. No. N/A
	mechanical shaft seal for shaft $\varnothing$ 12 mm		
	Part No.	521239	Ref. No. 2510R
	impellor $\varnothing$ 110 mm H 26 mm rotation direction right		



1

<b>Part No.</b>	500943	<b>Ref. No.</b>	EPR1625 ZF522VSX
<b>description</b>	pump inlet $\varnothing$ 62mm outlet $\varnothing$ 50mm type ZF522VSX 230V 50Hz 1 phase 0,7kW 0,95HP L 250mm rotation direction right capacitor 16 $\mu$ F LGB		
<b>spare parts for</b>	500943		
	Part No.	365021	Ref. No. —
	operating capacitor capacity 16 $\mu$ F 425V		

<b>spare parts for</b> 500943			
	Part No.	510551	Ref. No. 0049R
	pump cover gasket ID $\varnothing$ 158,3 mm		
	Part No.	510694	Ref. No. N/A
	mechanical shaft seal for shaft $\varnothing$ 13 mm		
	Part No.	512029	Ref. No. 1339D103
	impellor $\varnothing$ 103 mm H 26 mm thread M8L shaft $\varnothing$ 19 mm		
	Part No.	521536	Ref. No. 0022R
	pump cover ALBA / LGB inlet $\varnothing$ 62 mm outlet $\varnothing$ 50 mm		







1

<b>Part No.</b>	499267	<b>Ref. No.</b>	ZF523VSX
<b>description</b>	pump inlet $\varnothing$ 62mm outlet $\varnothing$ 50mm type ZF523VSX 230/400V 60Hz 3 phase 1,1kW L 282mm rotation direction right LGB		
<b>spare parts for</b>	499267		
	Part No.	510551	Ref. No. 0049R
	pump cover gasket ID $\varnothing$ 158,3 mm		
	Part No.	510693	Ref. No. N/A
	mechanical shaft seal for shaft $\varnothing$ 12 mm		
	Part No.	521093	Ref. No. Girante per Pompa ZF523 VSX 60Hz
	impellor $\varnothing$ 85 mm H 29 mm thread M8L shaft $\varnothing$ 20 mm		
	Part No.	521536	Ref. No. 0022R
	pump cover ALBA / LGB inlet $\varnothing$ 62 mm outlet $\varnothing$ 50 mm		







1

<b>Part No.</b>	500379	<b>Ref. No.</b>	EPR1005 ZF650SX
<b>description</b>	pump inlet $\varnothing$ 62mm outlet $\varnothing$ 50mm type ZF650SX 230/400V 50Hz 3 phase 1,35kW 1,8HP L 335mm rotation direction right LGB		
<b>spare parts for</b>	500379		
	<b>Part No.</b>	510551	<b>Ref. No.</b> 0049R
	pump cover gasket ID $\varnothing$ 158,3 mm		
	<b>Part No.</b>	510694	<b>Ref. No.</b> N/A
	mechanical shaft seal for shaft $\varnothing$ 13 mm		
	<b>Part No.</b>	521240	<b>Ref. No.</b> 2500R
	impellor $\varnothing$ 110 mm H 32 mm rotation direction left		
	<b>Part No.</b>	521536	<b>Ref. No.</b> 0022R
	pump cover ALBA / LGB inlet $\varnothing$ 62 mm outlet $\varnothing$ 50 mm		







1

<b>Part No.</b>	499238	<b>Ref. No.</b>	ZF650SX
<b>description</b>	pump inlet $\varnothing$ 62mm outlet $\varnothing$ 50mm type ZF650SX 230/400V 50Hz 3 phase 1,7kW L 340mm rotation direction right LGB		
<b>spare parts for</b>	499238		
	<b>Part No.</b>	510551	<b>Ref. No.</b> 0049R
	pump cover gasket ID $\varnothing$ 158,3 mm		
	<b>Part No.</b>	510694	<b>Ref. No.</b> N/A
	mechanical shaft seal for shaft $\varnothing$ 13 mm		
	<b>Part No.</b>	521094	<b>Ref. No.</b> 2853R
	impellor $\varnothing$ 105 mm H 34 mm thread M8L shaft $\varnothing$ 27 mm		
	<b>Part No.</b>	521536	<b>Ref. No.</b> 0022R
	pump cover ALBA / LGB inlet $\varnothing$ 62 mm outlet $\varnothing$ 50 mm		







1

<b>Part No.</b>	500378	<b>Ref. No.</b>	EPR1006 ZF800SX
<b>description</b>	pump inlet $\varnothing$ 62mm outlet $\varnothing$ 50mm type ZF800SX 230/400V 50Hz 3 phase 2kW 2,72HP L 340mm rotation direction right LGB		
<b>spare parts for</b>	500378		
	<b>Part No.</b>	510551	<b>Ref. No.</b> 0049R
	pump cover gasket ID $\varnothing$ 158,3 mm		
	<b>Part No.</b>	510694	<b>Ref. No.</b> N/A
	mechanical shaft seal for shaft $\varnothing$ 13 mm		
	<b>Part No.</b>	521242	<b>Ref. No.</b> 2853R
	impellor $\varnothing$ 115 mm H 36 mm M8L shaft intake $\varnothing$ 12 mm		
	<b>Part No.</b>	521536	<b>Ref. No.</b> 0022R
	pump cover ALBA / LGB inlet $\varnothing$ 62 mm outlet $\varnothing$ 50 mm		



1

<b>Part No.</b>	499247	<b>Ref. No.</b>	1612 ZF650DX
<b>description</b>	pump inlet $\varnothing$ 62mm outlet $\varnothing$ 51mm type ZF650DX 230/400V 50Hz 3 phase 1,1kW L 333mm rotation direction left LGB		
<b>spare parts for</b>	499247		
	<b>Part No.</b>	510551	<b>Ref. No.</b> 0049R
	pump cover gasket ID $\varnothing$ 158,3 mm		
	<b>Part No.</b>	510694	<b>Ref. No.</b> N/A
	mechanical shaft seal for shaft $\varnothing$ 13 mm		
	<b>Part No.</b>	521095	<b>Ref. No.</b> 1360-1R
	impellor $\varnothing$ 110 mm H 39 mm thread M8R shaft $\varnothing$ 30 mm		
	<b>Part No.</b>	521516	<b>Ref. No.</b> 0648R
	pump cover LGB inlet $\varnothing$ 62 mm outlet $\varnothing$ 52 mm		









1

<b>Part No.</b>	500122	<b>Ref. No.</b>	AM5225DX EPR0854
<b>description</b>	pump inlet ø 62mm outlet ø 52mm type AM5225DX 230/400V 50Hz 3 phase 1,2kW 1,6HP L 300mm rotation direction left LGB		
<b>spare parts for</b>	500122		
	<b>Part No.</b>	501495	<b>Ref. No.</b> 0189R
	cover plastic for terminal box for pump LGB		
	<b>Part No.</b>	510551	<b>Ref. No.</b> 0049R
	pump cover gasket ID ø 158,3 mm		
	<b>Part No.</b>	510694	<b>Ref. No.</b> N/A
	mechanical shaft seal for shaft ø 13 mm		
	<b>Part No.</b>	521236	<b>Ref. No.</b> 0120D105
	impellor ø 105 mm H 32 mm M8R		
	<b>Part No.</b>	521516	<b>Ref. No.</b> 0648R
	pump cover LGB inlet ø 62 mm outlet ø 52 mm		







1

<b>Part No.</b>	500536	<b>Ref. No.</b>	AM5225DX EPR1229
<b>description</b>	pump inlet ø 62mm outlet ø 52mm type AM5225DX 230V 50Hz 1 phase 0,9kW 1,2HP L 300mm rotation direction left capacitor 20µF LGB		
<b>spare parts for</b>	500536		
	<b>Part No.</b>	365019	<b>Ref. No.</b> —
	operating capacitor capacity 20µF 400V		

<b>spare parts for</b>	500536		
	<b>Part No.</b>	510551	<b>Ref. No.</b> 0049R
	pump cover gasket ID ø 158,3 mm		
	<b>Part No.</b>	510694	<b>Ref. No.</b> N/A
	mechanical shaft seal for shaft ø 13 mm		
	<b>Part No.</b>	521217	<b>Ref. No.</b> N/A
	impellor ø 110 mm H 32 mm thread M8R shaft ø 20 mm		
	<b>Part No.</b>	521516	<b>Ref. No.</b> 0648R
	pump cover LGB inlet ø 62 mm outlet ø 52 mm		



1

<b>Part No.</b>	501363	<b>Ref. No.</b>	AM5226DX EPR0444 EPR0444A
<b>description</b>	pump inlet ø 62mm outlet ø 52mm type AM5226 230/400V 50Hz 0,65kW L 295mm rotation direction left LGB		
<b>spare parts for</b>	501363		
	<b>Part No.</b>	510551	<b>Ref. No.</b> 0049R
	pump cover gasket ID ø 158,3 mm		
	<b>Part No.</b>	510694	<b>Ref. No.</b> N/A
	mechanical shaft seal for shaft ø 13 mm		
	<b>Part No.</b>	521141	<b>Ref. No.</b> 0120-1R
	impellor ø 70 mm H 32 mm thread M8R shaft ø 20 mm		
	<b>Part No.</b>	521516	<b>Ref. No.</b> 0648R
	pump cover LGB inlet ø 62 mm outlet ø 52 mm		



<b>Part No.</b>	499299	<b>Ref. No.</b>	AM5226DX (DPE1906)
-----------------	--------	-----------------	--------------------

**description** pump inlet ø 62mm outlet ø 52mm type AM5226DX 220-240/380-415V 60Hz 3 phase 0,55kW L 293mm rotation direction left LGB

**spare parts for** 499299

	<b>Part No.</b>	510551	<b>Ref. No.</b>	0049R
---	-----------------	--------	-----------------	-------

pump cover gasket ID ø 158,3 mm

	<b>Part No.</b>	510694	<b>Ref. No.</b>	N/A
---	-----------------	--------	-----------------	-----

mechanical shaft seal for shaft ø 13 mm

	<b>Part No.</b>	521141	<b>Ref. No.</b>	0120-1R
---	-----------------	--------	-----------------	---------

impellor ø 70 mm H 32 mm thread M8R shaft ø 20 mm

	<b>Part No.</b>	521516	<b>Ref. No.</b>	0648R
---	-----------------	--------	-----------------	-------

pump cover LGB inlet ø 62 mm outlet ø 52 mm



<b>Part No.</b>	500537	<b>Ref. No.</b>	EPR1099 ZF522VDX
-----------------	--------	-----------------	---------------------

**description** pump inlet ø 62mm outlet ø 52mm type ZF522VDX 230V 50Hz 1 phase 0,85kW 1,16HP L 255mm rotation direction left capacitor 16µF auxiliary pressure connection 12mm supporting pressure open LGB

**spare parts for** 500537

	<b>Part No.</b>	365021	<b>Ref. No.</b>	—
---	-----------------	--------	-----------------	---

operating capacitor capacity 16µF 425V

	<b>Part No.</b>	510551	<b>Ref. No.</b>	0049R
---	-----------------	--------	-----------------	-------

pump cover gasket ID ø 158,3 mm

	<b>Part No.</b>	510693	<b>Ref. No.</b>	N/A
---	-----------------	--------	-----------------	-----

mechanical shaft seal for shaft ø 12 mm

**spare parts for** 500537

	<b>Part No.</b>	521281	<b>Ref. No.</b>	0120D90
---	-----------------	--------	-----------------	---------

impellor ø 90 mm H 30 mm thread M8R shaft ø 20 mm

	<b>Part No.</b>	521516	<b>Ref. No.</b>	0648R
---	-----------------	--------	-----------------	-------

pump cover LGB inlet ø 62 mm outlet ø 52 mm



<b>Part No.</b>	499242	<b>Ref. No.</b>	C.F.2561 ZF650DX
-----------------	--------	-----------------	---------------------

**description** pump inlet ø 62mm outlet ø 52mm type ZF650DX 230V 50Hz 1 phase 1,47kW L 335mm rotation direction left capacitor 20µF LGB

**spare parts for** 499242

	<b>Part No.</b>	365019	<b>Ref. No.</b>	—
---	-----------------	--------	-----------------	---

operating capacitor capacity 20µF 400V

	<b>Part No.</b>	510551	<b>Ref. No.</b>	0049R
---	-----------------	--------	-----------------	-------

pump cover gasket ID ø 158,3 mm

	<b>Part No.</b>	510694	<b>Ref. No.</b>	N/A
---	-----------------	--------	-----------------	-----

mechanical shaft seal for shaft ø 13 mm

	<b>Part No.</b>	521217	<b>Ref. No.</b>	N/A
---	-----------------	--------	-----------------	-----

impellor ø 110 mm H 32 mm thread M8R shaft ø 20 mm

	<b>Part No.</b>	521516	<b>Ref. No.</b>	0648R
---	-----------------	--------	-----------------	-------

pump cover LGB inlet ø 62 mm outlet ø 52 mm



1

<b>Part No.</b>	500780	<b>Ref. No.</b>	EPR1611 ZF800DX
<b>description</b>	pump inlet ø 62mm outlet ø 52mm type ZF800DX 230/400V 50Hz 3 phase 1,5kW 2HP L 340mm rotation direction left LGB		
<b>spare parts for</b>	500780		
	<b>Part No.</b>	510551	<b>Ref. No.</b> 0049R
	pump cover gasket ID ø 158,3 mm		
	<b>Part No.</b>	510694	<b>Ref. No.</b> N/A
	mechanical shaft seal for shaft ø 13 mm		
	<b>Part No.</b>	521276	<b>Ref. No.</b> 1360-1R
	impellor ø 120 mm H 39 mm pump type ZF800DX		
	<b>Part No.</b>	521516	<b>Ref. No.</b> 0648R
	pump cover LGB inlet ø 62 mm outlet ø 52 mm		



1

<b>Part No.</b>	499141	<b>Ref. No.</b>	EPR1874 ZF800DX
<b>description</b>	pump inlet ø 62mm outlet ø 52mm type ZF800DX 230/400V 50Hz 3 phase 1,65kW 2,2HP L 336mm rotation direction left auxiliary pressure connection 12mm supporting pressure closed LGB		
<b>spare parts for</b>	499141		
	<b>Part No.</b>	510551	<b>Ref. No.</b> 0049R
	pump cover gasket ID ø 158,3 mm		
	<b>Part No.</b>	510694	<b>Ref. No.</b> N/A
	mechanical shaft seal for shaft ø 13 mm		
	<b>Part No.</b>	521276	<b>Ref. No.</b> 1360-1R
	impellor ø 120 mm H 39 mm pump type ZF800DX		

<b>spare parts for</b>	499141		
	<b>Part No.</b>	521516	<b>Ref. No.</b> 0648R
	pump cover LGB inlet ø 62 mm outlet ø 52 mm		



1

<b>Part No.</b>	499287	<b>Ref. No.</b>	ZF800DX (TR0080)
<b>description</b>	pump inlet ø 62mm outlet ø 52mm type ZF800DX 230/400V 50Hz 3 phase 2,7kW L 332mm rotation direction left LGB		
<b>spare parts for</b>	499287		
	<b>Part No.</b>	510551	<b>Ref. No.</b> 0049R
	pump cover gasket ID ø 158,3 mm		
	<b>Part No.</b>	510694	<b>Ref. No.</b> N/A
	mechanical shaft seal for shaft ø 13 mm		
	<b>Part No.</b>	521276	<b>Ref. No.</b> 1360-1R
	impellor ø 120 mm H 39 mm pump type ZF800DX		
	<b>Part No.</b>	521516	<b>Ref. No.</b> 0648R
	pump cover LGB inlet ø 62 mm outlet ø 52 mm		







1

<b>Part No.</b>	500733	<b>Ref. No.</b>	AM5225SX EPR2495
<b>description</b>	pump inlet ø 63mm outlet ø 48mm type AM5225SX 230/400V 50Hz 3 phase 0,9kW 1,2HP L 300mm rotation direction right LGB		







1

<b>Part No.</b>	500779	<b>Ref. No.</b>	EPR1489 ZF523VSX
<b>description</b>	pump inlet $\varnothing$ 63mm outlet $\varnothing$ 48mm type ZF523VSX 230/400V 50Hz 3 phase 1kW 1,36HP L 280mm rotation direction right LGB		
<b>spare parts for</b>	500779		
	<b>Part No.</b>	510551	<b>Ref. No.</b> 0049R
	pump cover gasket ID $\varnothing$ 158,3 mm		
	<b>Part No.</b>	510693	<b>Ref. No.</b> N/A
	mechanical shaft seal for shaft $\varnothing$ 12 mm		
	<b>Part No.</b>	521097	<b>Ref. No.</b> 1388-1R
	impellor $\varnothing$ 100 mm H 31 mm thread M8L shaft $\varnothing$ 20 mm		
	<b>Part No.</b>	521536	<b>Ref. No.</b> 0022R
	pump cover ALBA / LGB inlet $\varnothing$ 62 mm outlet $\varnothing$ 50 mm		



1

<b>Part No.</b>	500469	<b>Ref. No.</b>	EPR1806 ZF650SX
<b>description</b>	pump inlet $\varnothing$ 63mm outlet $\varnothing$ 48mm type ZF650SX 230/400V 50Hz 3 phase 1,35kW 1,83HP L 335mm rotation direction right LGB		
<b>spare parts for</b>	500469		
	<b>Part No.</b>	510551	<b>Ref. No.</b> 0049R
	pump cover gasket ID $\varnothing$ 158,3 mm		
	<b>Part No.</b>	510694	<b>Ref. No.</b> N/A
	mechanical shaft seal for shaft $\varnothing$ 13 mm		

spare parts for 500469



<b>Part No.</b>	521240	<b>Ref. No.</b>	2500R
-----------------	--------	-----------------	-------

impellor  $\varnothing$  110 mm H 32 mm rotation direction left

<b>Part No.</b>	521536	<b>Ref. No.</b>	0022R
-----------------	--------	-----------------	-------

pump cover ALBA / LGB inlet  $\varnothing$  62 mm outlet  $\varnothing$  50 mm

image not available

<b>Part No.</b>	500960	<b>Ref. No.</b>	EPR2042 ZF650SX
<b>description</b>	pump inlet $\varnothing$ 63mm outlet $\varnothing$ 48mm type ZF650SX 230V 50Hz 1 phase 1,47kW 2HP L 340mm rotation direction right capacitor 20 $\mu$ F LGB inlet $\varnothing$ 63mm outlet $\varnothing$ 48mm		



1

<b>Part No.</b>	499271	<b>Ref. No.</b>	ZF650SX (ATA 8214)
<b>description</b>	pump inlet $\varnothing$ 63mm outlet $\varnothing$ 61mm type ZF650SX 230/400V 50Hz 3 phase 0,95kW L 340mm rotation direction right LGB		





1

<b>Part No.</b>	499083	<b>Ref. No.</b>	EPR1829 ZF650SX (ATA 9821)
<b>description</b>	pump inlet ø 63mm outlet ø 63mm type ZF650SX 230/400V 50Hz 3 phase 1,5kW L 335mm		
<b>spare parts for</b>	499083		
	Part No.	510551	Ref. No. 0049R
	pump cover gasket ID ø 158,3 mm		
	Part No.	510694	Ref. No. N/A
	mechanical shaft seal for shaft ø 13 mm		
<b>image not available</b>	Part No.	521069	Ref. No. 0180R
	fanwheel cover		
	Part No.	521240	Ref. No. 2500R
	impellor ø 110 mm H 32 mm rotation direction left		
	Part No.	521537	Ref. No. N/A
	pump cover inlet ø 62 mm outlet ø 62 mm		

**spare parts for** 499101

	Part No.	502280	Ref. No.	N/A
	pump sump LGB auxiliary pressure connection 7 mm			
	Part No.	510703	Ref. No.	1001R 1058R N/A
	mechanical shaft seal for shaft ø 13 mm			
	Part No.	521234	Ref. No.	N/A
	impellor thread M8L ED ø 93 mm W 16 mm			
	Part No.	523509	Ref. No.	—
	deep-groove ball bearing type 6201-2RS			
	Part No.	532537	Ref. No.	N/A
	O-ring EPDM thickness 3,53 mm ID ø 113,9 mm			



1

<b>Part No.</b>	499101	<b>Ref. No.</b>	C600/PS60 2248 C600/PS60 79056
<b>description</b>	pump inlet ø outlet ø 38mm type C600 230V 50Hz 1 phase 0,8kW L 220mm rotation direction right capacitor 16µF LGB with drain and flange		
<b>spare parts for</b>	499101		
	Part No.	365021	Ref. No. —
	operating capacitor capacity 16µF 425V		



1

<b>Part No.</b>	499119	<b>Ref. No.</b>	1751
<b>description</b>	pump inlet ø outlet ø 38mm type RV54 230V 50Hz 1 phase 0,8kW L 380mm rotation direction right capacitor 16µF LGB with holder		
<b>spare parts for</b>	499119		
	Part No.	365021	Ref. No. —
	operating capacitor capacity 16µF 425V		
	Part No.	502280	Ref. No. N/A
	pump sump LGB auxiliary pressure connection 7 mm		
	Part No.	510703	Ref. No. 1001R 1058R N/A
	mechanical shaft seal for shaft ø 13 mm		
	Part No.	521234	Ref. No. N/A
	impellor thread M8L ED ø 93 mm W 16 mm		
	Part No.	523509	Ref. No. —
	deep-groove ball bearing type 6201-2RS		
	Part No.	532537	Ref. No. N/A
	O-ring EPDM thickness 3,53 mm ID ø 113,9 mm		



1

<b>Part No.</b>	500153	<b>Ref. No.</b>	W180SX
<b>description</b>	pump inlet $\varnothing$ outlet $\varnothing$ type W180SX 230V 50Hz 1 phase 0,19kW 0,26HP L 220mm rotation direction right capacitor 5 $\mu$ F LGB		
<b>spare parts for</b>	500153		
	<b>Part No.</b>	365017	<b>Ref. No.</b> —
	operating capacitor capacity 5 $\mu$ F 450V		
	<b>Part No.</b>	510703	<b>Ref. No.</b> 1001R 1058R N/A
	mechanical shaft seal for shaft $\varnothing$ 13 mm		
	<b>Part No.</b>	513267	<b>Ref. No.</b> —
	end cap for wash pump suitable for pump casing		
	<b>Part No.</b>	518177	<b>Ref. No.</b> N/A
	drain unit thread 3/4" ID $\varnothing$ 35mm hose $\varnothing$ 24mm		
	<b>Part No.</b>	518204	<b>Ref. No.</b> —
	screw connection for filter $\varnothing$ 67mm		
	<b>Part No.</b>	518205	<b>Ref. No.</b> —
	flat gasket rubber D1 $\varnothing$ 61mm D2 $\varnothing$ 47mm		
	<b>Part No.</b>	521147	<b>Ref. No.</b> —
	flange		
	<b>Part No.</b>	521221	<b>Ref. No.</b> N/A
	impellor $\varnothing$ 67 mm H 16 mm rotation direction right		
	<b>Part No.</b>	528800	<b>Ref. No.</b> 0042R
	O-ring EPDM thickness 2,62 mm ID $\varnothing$ 75,87 mm		



1

<b>Part No.</b>	500150	<b>Ref. No.</b>	EPR130980 W210SX
<b>description</b>	pump inlet $\varnothing$ outlet $\varnothing$ type W210SX 230V 50Hz 1 phase 0,24kW 0,33HP L 230mm rotation direction right capacitor 6,3 $\mu$ F LGB		
<b>spare parts for</b>	500150		
	<b>Part No.</b>	365012	<b>Ref. No.</b> —
	operating capacitor capacity 6,3 $\mu$ F 450V		
	<b>Part No.</b>	509004	<b>Ref. No.</b> 0951R
	impellor $\varnothing$ 71 mm H 16 mm M7L		
	<b>Part No.</b>	510703	<b>Ref. No.</b> 1001R 1058R N/A
	mechanical shaft seal for shaft $\varnothing$ 13 mm		
	<b>Part No.</b>	513267	<b>Ref. No.</b> —
	end cap for wash pump suitable for pump casing		
	<b>Part No.</b>	513275	<b>Ref. No.</b> N/A
	O-ring EPDM thickness 1,78mm ID $\varnothing$ 82,27mm		
	<b>Part No.</b>	518177	<b>Ref. No.</b> N/A
	drain unit thread 3/4" ID $\varnothing$ 35mm hose $\varnothing$ 24mm		
	<b>Part No.</b>	518204	<b>Ref. No.</b> —
	screw connection for filter $\varnothing$ 67mm		
	<b>Part No.</b>	518205	<b>Ref. No.</b> —
	flat gasket rubber D1 $\varnothing$ 61mm D2 $\varnothing$ 47mm		
	<b>Part No.</b>	521147	<b>Ref. No.</b> —
	flange		



1

<b>Part No.</b>	500390	<b>Ref. No.</b>	ELET.FM4023SX FM4022SX
<b>description</b>	pump type FM4022SX 230V 50Hz 1 phase 0,5kW 0,86HP rotation direction right capacitor 16µF LGB		
<b>spare parts for</b>	500390		
	Part No.	365021	Ref. No. —
	operating capacitor capacity 16µF 425V		
	Part No.	510703	Ref. No. 1001R 1058R N/A
	mechanical shaft seal for shaft ø 13 mm		
	Part No.	521246	Ref. No. 0591-1R
	impellor ø 103 mm H 26 mm thread M8L shaft ø 20 mm		
	Part No.	521542	Ref. No. 0878R
	pump cover LGB inlet ø 45 mm outlet ø 40 mm		
	Part No.	521714	Ref. No. 0046R 3283R
	pump cover gasket thickness 4x4mm Qty 1 pcs		

spare parts and accessories

mechanical shaft seals



1

<b>Part No.</b>	510692	<b>Ref. No.</b>	N/A
<b>description</b>	mechanical shaft seal for shaft ø 11mm slide ring ext. ø 24mm slide ring H 13mm counter ring mounting ø 26mm height counter ring 8mm counter ring int. ø 14mm		



1

<b>Part No.</b>	510693	<b>Ref. No.</b>	N/A
<b>description</b>	mechanical shaft seal for shaft ø 12mm slide ring ext. ø 24mm slide ring H 15,5mm slide ring int. ø 11mm counter ring mounting ø 24mm height counter ring 8mm counter ring int. ø 14mm		



1

<b>Part No.</b>	510694	<b>Ref. No.</b>	N/A
<b>description</b>	mechanical shaft seal for shaft ø 13mm height counter ring 8mm ID ø 11,5mm H 16mm mounting ø 24/26mm int. ø 14mm		



1

<b>Part No.</b>	510703	<b>Ref. No.</b>	1001R 1058R N/A
<b>description</b>	mechanical shaft seal for shaft ø 13mm slide ring H 13mm height counter ring 5,5mm ED ø 26mm		



1

<b>Part No.</b>	510690	<b>Ref. No.</b>	N/A
<b>description</b>	mechanical shaft seal for shaft ø 8mm ED ø 24mm mounting ø 24/26mm		



## impellers

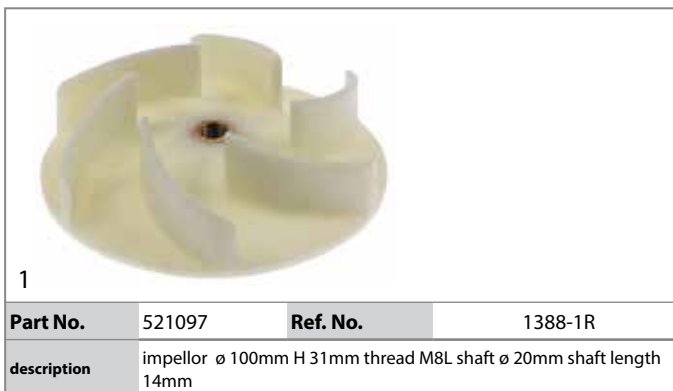



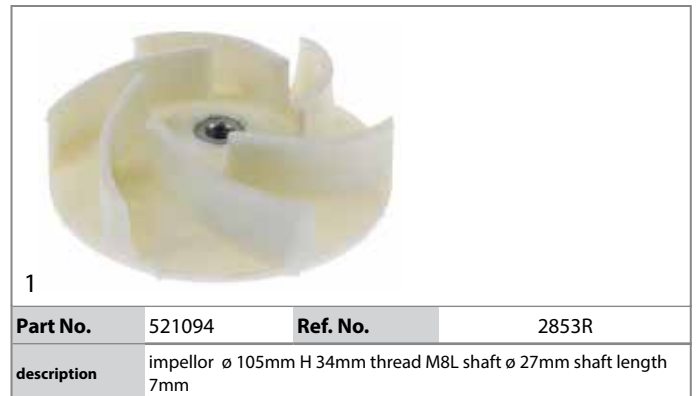
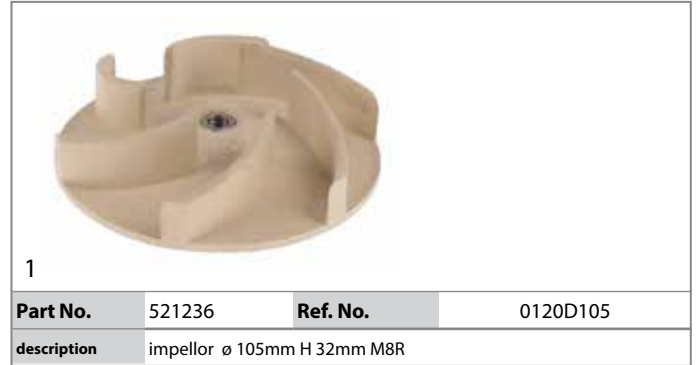





			
1			
<b>Part No.</b>	521239	<b>Ref. No.</b>	2510R
<b>description</b>	impellor ø 110mm H 26mm rotation direction right thread M8L shaft ø 19,5mm shaft length 17mm seat ø 8,2mm blades 6		

			
1			
<b>Part No.</b>	521217	<b>Ref. No.</b>	N/A
<b>description</b>	impellor ø 110mm H 32mm thread M8R shaft ø 20mm shaft length 10mm seat ø 8,2mm blades 6 for ZF522DX		

			
1			
<b>Part No.</b>	521095	<b>Ref. No.</b>	1360-1R
<b>description</b>	impellor ø 110mm H 39mm thread M8R shaft ø 30mm		

			
1			
<b>Part No.</b>	521242	<b>Ref. No.</b>	2853R
<b>description</b>	impellor ø 115mm H 36mm M8L shaft intake ø 12mm rotation direction right blades 6		

			
1			
<b>Part No.</b>	521276	<b>Ref. No.</b>	1360-1R
<b>description</b>	impellor ø 120mm H 39mm pump type ZF800DX shaft intake ø 12mm rotation direction left thread M8R pump for ZF800DX blades 6		

			
1			
<b>Part No.</b>	521059	<b>Ref. No.</b>	2854R
<b>description</b>	impellor ø 120mm H 39mm rotation direction left thread M8R suitable for LGB ZF900DX seat ø 12mm		

			
1			
<b>Part No.</b>	521054	<b>Ref. No.</b>	1161-1R
<b>description</b>	impellor ø 135mm H 37mm shaft intake ø 18mm rotation direction right thread M14L blades 6		

			
1			
<b>Part No.</b>	521114	<b>Ref. No.</b>	Girante per Pompa ZF119SX C.F.2126
<b>description</b>	impellor ø 48mm H 17mm pump type ZF119SX shaft ø 13mm shaft length 12mm		





1

<b>Part No.</b>	698663	<b>Ref. No.</b>	0965R
<b>description</b>	impellor ø 60mm H 12mm with flute shaft intake ø 12mm W 60mm suitable for LGB		



1

<b>Part No.</b>	530455	<b>Ref. No.</b>	0101-1R
<b>description</b>	impellor ø 60mm H 30mm screw mounting shaft intake ø M5mm rotation direction left suitable for LGB for ZF115M7 DX shaft ø M5mm shaft length 26mm blades 3		
<b>accessories for</b>	530455		
	<b>Part No.</b>	500542	<b>Ref. No.</b> EPR0459 ZF-130DX
pump inlet ø 28mm outlet ø 26mm type ZF130DX 230V			



1

<b>Part No.</b>	521223	<b>Ref. No.</b>	1517R
<b>description</b>	impellor ø 61mm H 17mm thread M7L shaft ø 13mm shaft length 12mm		



1

<b>Part No.</b>	521221	<b>Ref. No.</b>	N/A
<b>description</b>	impellor ø 67mm H 16mm rotation direction right thread M7L shaft ø 13mm shaft length 12mm blades 8		



1

<b>Part No.</b>	698765	<b>Ref. No.</b>	N/A
<b>description</b>	impellor ø 70mm H 21mm rotation direction right thread M7L suitable for LGB shaft ø 13mm shaft length 20mm blades 4		



1

<b>Part No.</b>	521141	<b>Ref. No.</b>	0120-1R
<b>description</b>	impellor ø 70mm H 32mm thread M8R shaft ø 20mm shaft length 9mm		



1

<b>Part No.</b>	509004	<b>Ref. No.</b>	0951R
<b>description</b>	impellor ø 71mm H 16mm M7L rotation direction right shaft ø 13mm shaft length 13mm blades 8		





1

<b>Part No.</b>	521228	<b>Ref. No.</b>	0105-1R
<b>description</b>	impellor ø 72mm H 17mm rotation direction left thread M7R shaft ø 13mm shaft length 12mm blades 3		



			
1			
<b>Part No.</b>	521085	<b>Ref. No.</b>	0106-1R
<b>description</b>	impellor ø 72mm H 17mm thread M7L shaft ø 13mm shaft length 12mm blades 3		

			
1			
<b>Part No.</b>	521099	<b>Ref. No.</b>	1580-1R
<b>description</b>	impellor ø 72mm H 17mm thread M7R shaft ø 13mm shaft length 12mm		

			
1			
<b>Part No.</b>	521008	<b>Ref. No.</b>	0109-1R
<b>description</b>	impellor ø 72mm H 22mm rotation direction left thread M7R shaft ø 13mm shaft length 12mm		

			
1			
<b>Part No.</b>	521225	<b>Ref. No.</b>	0110-1R
<b>description</b>	impellor ø 72mm H 22mm rotation direction right thread M7L shaft ø 13mm shaft length 12mm		

			
1			
<b>Part No.</b>	521083	<b>Ref. No.</b>	0815R
<b>description</b>	impellor ø 73mm H 13mm thread M7R blades 3 metal		

			
1			
<b>Part No.</b>	521092	<b>Ref. No.</b>	2574R Girante per Pompa CRC-R DX EPR2570A
<b>description</b>	impellor ø 80mm H 25mm pump type CRC-R DX thread M6R shaft ø 13mm shaft length 20mm		

			
1			
<b>Part No.</b>	521150	<b>Ref. No.</b>	N/A
<b>description</b>	impellor ø 85mm H 17mm thread M8R shaft ø 13mm shaft length 10mm		

			
1			
<b>Part No.</b>	521093	<b>Ref. No.</b>	Girante per Pompa ZF523 VSX 60Hz
<b>description</b>	impellor ø 85mm H 29mm thread M8L shaft ø 20mm shaft length 10mm		





1

<b>Part No.</b>	521230	<b>Ref. No.</b>	N/A
<b>description</b>	impellor ø 86mm H 16mm M7L		

image not available

<b>Part No.</b>	521040	<b>Ref. No.</b>	1857
<b>description</b>	impellor ø 88mm H 16mm pump type ZF220SX rotation direction right thread M8L		



1

<b>Part No.</b>	521024	<b>Ref. No.</b>	N/A
<b>description</b>	impellor ø 88mm H 30mm rotation direction right thread M7L shaft ø 12mm blades 6		



1

<b>Part No.</b>	521089	<b>Ref. No.</b>	2037R
<b>description</b>	impellor ø 88mm H 32mm thread M8L		



1

<b>Part No.</b>	521247	<b>Ref. No.</b>	N/A
<b>description</b>	impellor ø 90mm H 27mm rotation direction right thread M8L blades 6		



1

<b>Part No.</b>	521281	<b>Ref. No.</b>	0120D90
<b>description</b>	impellor ø 90mm H 30mm thread M8R shaft ø 20mm shaft length 10mm seat ø 8,2mm blades 6		



1

<b>Part No.</b>	521112	<b>Ref. No.</b>	N/A
<b>description</b>	impellor ø 93mm H 21mm pump type ZF220VSX thread M8L shaft ø 13mm shaft length 11mm		



1

<b>Part No.</b>	521278	<b>Ref. No.</b>	2037R
<b>description</b>	impellor ø 93mm H 32mm pump type ZF350SX thread M8L		



1

<b>Part No.</b>	521300	<b>Ref. No.</b>	0697-1R
<b>description</b>	impellor ø 94mm H 27mm pump type ZF320SX thread M8L		



1

<b>Part No.</b>	521106	<b>Ref. No.</b>	0114-1R
<b>description</b>	impellor ø 97mm H 24mm rotation direction right thread M8L seat ø 8,2mm blades 5		



1

<b>Part No.</b>	521234	<b>Ref. No.</b>	N/A
<b>description</b>	impellor thread M8L ED ø 93mm W 16mm		

pump covers



1

<b>Part No.</b>	518177	<b>Ref. No.</b>	N/A
<b>description</b>	drain unit thread 3/4" ID ø 35mm hose ø 24mm		



1

<b>Part No.</b>	502267	<b>Ref. No.</b>	0935-1R
<b>description</b>	pump cover		



1

<b>Part No.</b>	521564	<b>Ref. No.</b>	N/A
<b>description</b>	pump cover		



1

<b>Part No.</b>	521536	<b>Ref. No.</b>	0022R
<b>description</b>	pump cover ALBA / LGB inlet ø 62mm outlet ø 50mm auxiliary pressure connection 12mm supporting pressure closed turn direction right ø 180mm ID ø 150mm inner height 38mm		



1

<b>Part No.</b>	502266	<b>Ref. No.</b>	0881R
<b>description</b>	pump cover inlet ø 28mm outlet ø 26mm		

image not available

<b>Part No.</b>	521037	<b>Ref. No.</b>	0246
<b>description</b>	pump cover inlet $\varnothing$ 45mm outlet $\varnothing$ 40mm pump type ZF220SX		



2

<b>Part No.</b>	521537	<b>Ref. No.</b>	N/A
<b>description</b>	pump cover inlet $\varnothing$ 62mm outlet $\varnothing$ 62mm auxiliary pressure connection 12mm supporting pressure closed turn direction right $\varnothing$ 180mm ID $\varnothing$ 150mm inner height 38mm		



1

<b>Part No.</b>	521119	<b>Ref. No.</b>	2135R
<b>description</b>	pump cover LGB inlet $\varnothing$ 28mm outlet $\varnothing$ 12mm auxiliary pressure connection 12mm pump type ZF131DX		



1

<b>Part No.</b>	698770	<b>Ref. No.</b>	N/A
<b>description</b>	pump cover LGB inlet $\varnothing$ 28mm outlet $\varnothing$ 22/28mm $\varnothing$ 108mm ID $\varnothing$ 84mm		



1

<b>Part No.</b>	521084	<b>Ref. No.</b>	1263R
<b>description</b>	pump cover LGB inlet $\varnothing$ 28mm outlet $\varnothing$ 25mm auxiliary pressure connection 13mm pump type ZF131DX ID $\varnothing$ 78mm		



1

<b>Part No.</b>	521098	<b>Ref. No.</b>	1649R
<b>description</b>	pump cover LGB inlet $\varnothing$ 28mm outlet $\varnothing$ 26mm auxiliary pressure connection 12mm ID $\varnothing$ 77mm		



1

<b>Part No.</b>	521107	<b>Ref. No.</b>	0001R
<b>description</b>	pump cover LGB inlet $\varnothing$ 28mm outlet $\varnothing$ 26mm auxiliary pressure connection 12mm ID $\varnothing$ 77mm		



1

<b>Part No.</b>	521057	<b>Ref. No.</b>	1650R
<b>description</b>	pump cover LGB inlet $\varnothing$ 28mm outlet $\varnothing$ 26mm auxiliary pressure connection 12mm supporting pressure open turn direction right $\varnothing$ 102mm ID $\varnothing$ 77mm inner height 31mm		



1

<b>Part No.</b>	510122	<b>Ref. No.</b>	0002R
<b>description</b>	pump cover LGB inlet $\varnothing$ 28mm outlet $\varnothing$ 26mm auxiliary pressure connection 13mm supporting pressure open $\varnothing$ 98mm ID $\varnothing$ 77mm inner height 31mm		



1

<b>Part No.</b>	521524	<b>Ref. No.</b>	0882R
<b>description</b>	pump cover LGB inlet $\varnothing$ 28mm outlet $\varnothing$ 26mm auxiliary pressure connection 13mm turn direction left $\varnothing$ 98mm ID $\varnothing$ 78mm inner height 25mm		



1

<b>Part No.</b>	521091	<b>Ref. No.</b>	2576R
<b>description</b>	pump cover LGB inlet $\varnothing$ 28mm outlet $\varnothing$ 26mm pump type CRC-R DX		



1

<b>Part No.</b>	521007	<b>Ref. No.</b>	1774R
<b>description</b>	pump cover LGB inlet $\varnothing$ 28mm outlet $\varnothing$ 26mm turn direction left		



1

<b>Part No.</b>	521527	<b>Ref. No.</b>	0645R
<b>description</b>	pump cover LGB inlet $\varnothing$ 30mm outlet $\varnothing$ 30mm		



1

<b>Part No.</b>	521526	<b>Ref. No.</b>	0009R 3286R
<b>description</b>	pump cover LGB inlet $\varnothing$ 30mm outlet $\varnothing$ 30mm auxiliary pressure connection 12mm supporting pressure open turn direction right $\varnothing$ 117mm ID $\varnothing$ 95mm inner height 19mm		



1

<b>Part No.</b>	521088	<b>Ref. No.</b>	N/A
<b>description</b>	pump cover LGB inlet $\varnothing$ 33mm outlet $\varnothing$ 26mm		



1

<b>Part No.</b>	698768	<b>Ref. No.</b>	N/A
<b>description</b>	pump cover LGB inlet $\varnothing$ 42mm pump type LA50 AP $\varnothing$ 115mm ID $\varnothing$ 36mm		







1

<b>Part No.</b>	521140	<b>Ref. No.</b>	Chiocciola per Pompa EPR2660/ ZF150SX
<b>description</b>	pump cover LGB inlet $\varnothing$ 45mm outlet $\varnothing$ 40mm auxiliary pressure connection 12mm pump type ZF150SX		



1

<b>Part No.</b>	521086	<b>Ref. No.</b>	1435R
<b>description</b>	pump cover LGB inlet $\varnothing$ 50mm outlet $\varnothing$ 40mm		



1

<b>Part No.</b>	521542	<b>Ref. No.</b>	0878R
<b>description</b>	pump cover LGB inlet $\varnothing$ 45mm outlet $\varnothing$ 40mm auxiliary pressure connection 13mm supporting pressure open $\varnothing$ 150mm ID $\varnothing$ 120mm inner height 25mm		



1

<b>Part No.</b>	521548	<b>Ref. No.</b>	0020R
<b>description</b>	pump cover LGB inlet $\varnothing$ 50mm outlet $\varnothing$ 50mm		



1

<b>Part No.</b>	521113	<b>Ref. No.</b>	N/A
<b>description</b>	pump cover LGB inlet $\varnothing$ 45mm outlet $\varnothing$ 40mm pump type ZF220V SX		



1

<b>Part No.</b>	521108	<b>Ref. No.</b>	0021R
<b>description</b>	pump cover LGB inlet $\varnothing$ 50mm outlet $\varnothing$ 50mm auxiliary pressure connection 12mm		



1

<b>Part No.</b>	521109	<b>Ref. No.</b>	1572R
<b>description</b>	pump cover LGB inlet $\varnothing$ 45mm outlet $\varnothing$ 40mm supporting pressure 12		



1

<b>Part No.</b>	521547	<b>Ref. No.</b>	0758R 0758R (blu)
<b>description</b>	pump cover LGB inlet $\varnothing$ 60mm outlet $\varnothing$ 50mm supporting pressure M8 turn direction right $\varnothing$ 160mm ID $\varnothing$ 127mm inner height 36mm		
<b>spare parts for</b>	521547		
	<b>Part No.</b>	503122	<b>Ref. No.</b> —
	hexagonal screw thread M8 thread L 10mm SS WS 13		
	<b>Part No.</b>	510177	<b>Ref. No.</b> —
	O-ring EPDM thickness 1,78mm ID $\varnothing$ 7,66mm Qty 1 pcs		



1

<b>Part No.</b>	521053	<b>Ref. No.</b>	1139R
<b>description</b>	pump cover LGB inlet $\phi$ 61mm outlet $\phi$ 61mm turn direction right $\phi$ 210mm ID $\phi$ 175mm inner height 41mm		



1

<b>Part No.</b>	521516	<b>Ref. No.</b>	0648R
<b>description</b>	pump cover LGB inlet $\phi$ 62mm outlet $\phi$ 52mm auxiliary pressure connection 12mm supporting pressure closed turn direction left $\phi$ 190mm ID $\phi$ 150mm inner height 40mm		
<b>spare parts for</b>	521516		
	<b>Part No.</b>	503122	<b>Ref. No.</b> —
	hexagonal screw thread M8 thread L 10mm SS WS 13		
	<b>Part No.</b>	510177	<b>Ref. No.</b> —
	O-ring EPDM thickness 1,78mm ID $\phi$ 7,66mm Qty 1 pcs		



1

<b>Part No.</b>	521149	<b>Ref. No.</b>	N/A
<b>description</b>	pump cover LGB outlet $\phi$ 38/31mm		



1

<b>Part No.</b>	502280	<b>Ref. No.</b>	N/A
<b>description</b>	pump sump LGB auxiliary pressure connection 7mm supporting pressure closed pump type RV54		



1

<b>Part No.</b>	698827	<b>Ref. No.</b>	N/A
<b>description</b>	threaded ring LGB pump type LA50 $\phi$ 120mm ID $\phi$ 70mm		

**pump cover gaskets**



1

<b>Part No.</b>	521717	<b>Ref. No.</b>	N/A
<b>description</b>	O-ring EPDM thickness 1,78mm ID $\phi$ 120,37mm Qty 1 pcs		

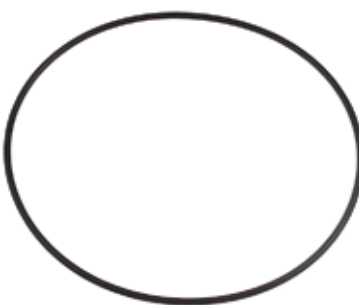

1

<b>Part No.</b>	513275	<b>Ref. No.</b>	N/A
<b>description</b>	O-ring EPDM thickness 1,78mm ID $\phi$ 82,27mm Qty 1 pcs		

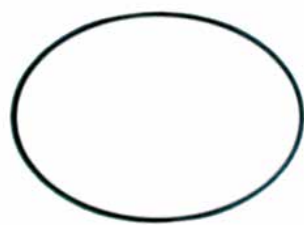

1

<b>Part No.</b>	510556	<b>Ref. No.</b>	N/A
<b>description</b>	O-ring EPDM thickness 1,78mm ID $\phi$ 94,97mm Qty 1 pcs pump type T110		



1

<b>Part No.</b>	532623	<b>Ref. No.</b>	1743R
<b>description</b>	O-ring EPDM thickness 2,62mm ID $\phi$ 120,32mm Qty 1 pcs		

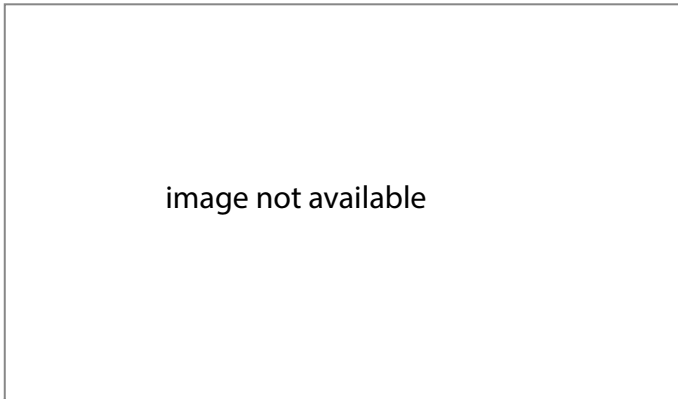

image not available

<b>Part No.</b>	532719	<b>Ref. No.</b>	N/A
<b>description</b>	O-ring EPDM thickness 2,62mm ID ø 126,67mm Qty 1 pcs		



1

<b>Part No.</b>	528800	<b>Ref. No.</b>	0042R
<b>description</b>	O-ring EPDM thickness 2,62mm ID ø 75,87mm Qty 1 pcs		



1

<b>Part No.</b>	509002	<b>Ref. No.</b>	Guarnizione per Pompa CRC-R DX EPR 2570A
<b>description</b>	O-ring EPDM thickness 2,62mm ID ø 82,22mm Qty 1 pcs		

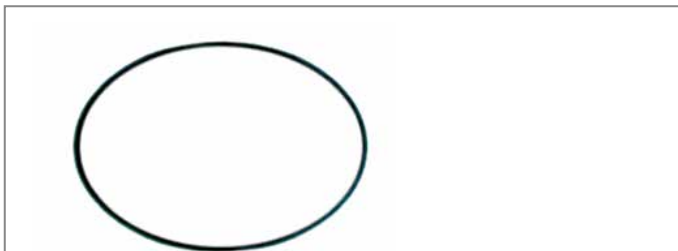

1

<b>Part No.</b>	510554	<b>Ref. No.</b>	n/a
<b>description</b>	O-ring EPDM thickness 2mm ID ø 120mm Qty 1 pcs		



1

<b>Part No.</b>	532537	<b>Ref. No.</b>	N/A
<b>description</b>	O-ring EPDM thickness 3,53mm ID ø 113,9mm Qty 1 pcs		

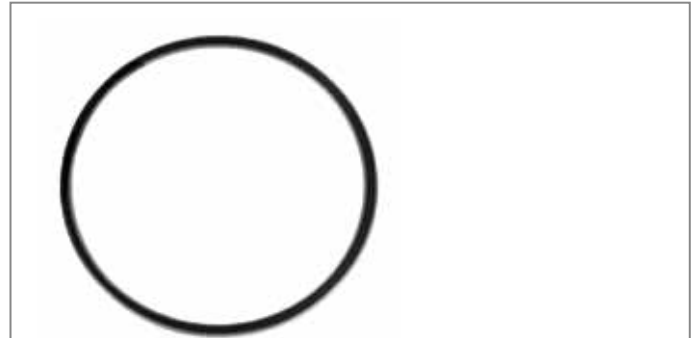

1

<b>Part No.</b>	510896	<b>Ref. No.</b>	1158R
<b>description</b>	O-ring EPDM thickness 3,53mm ID ø 183,75mm Qty 1 pcs		



1

<b>Part No.</b>	698810	<b>Ref. No.</b>	N/A
<b>description</b>	O-ring EPDM thickness 3,56mm ID ø 112mm Qty 1 pcs		



1

<b>Part No.</b>	521701	<b>Ref. No.</b>	0044R
<b>description</b>	pump cover gasket		

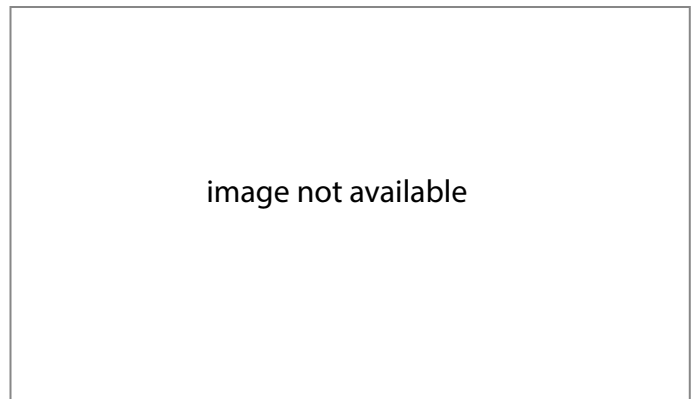



image not available

<b>Part No.</b>	521706	<b>Ref. No.</b>	2234R
<b>description</b>	pump cover gasket		



1



<b>Part No.</b>	521703	<b>Ref. No.</b>	N/A
<b>description</b>	pump cover gasket EPDM thickness 2,5mm ID ø 75mm Qty 1 pcs		

1



<b>Part No.</b>	503125	<b>Ref. No.</b>	N/A
<b>description</b>	pump cover gasket EPDM thickness 3mm ID ø 129mm Qty 1 pcs		

1



<b>Part No.</b>	510551	<b>Ref. No.</b>	0049R
<b>description</b>	pump cover gasket ID ø 158,3mm pump type 1214/1293/1225/2243/1226/1204/3473/1241 thickness 3,53mm EPDM Qty 1 pcs		

1



<b>Part No.</b>	698400	<b>Ref. No.</b>	0682R
<b>description</b>	pump cover gasket pump type PS46 thickness 2mm ID ø 66mm Qty 1 pcs		

image not available

<b>Part No.</b>	521038	<b>Ref. No.</b>	0045R
<b>description</b>	pump cover gasket pump type ZF220SX		

1



<b>Part No.</b>	521714	<b>Ref. No.</b>	0046R 3283R
<b>description</b>	pump cover gasket thickness 4x4mm Qty 1 pcs		



**GASTROPARTS.COM**

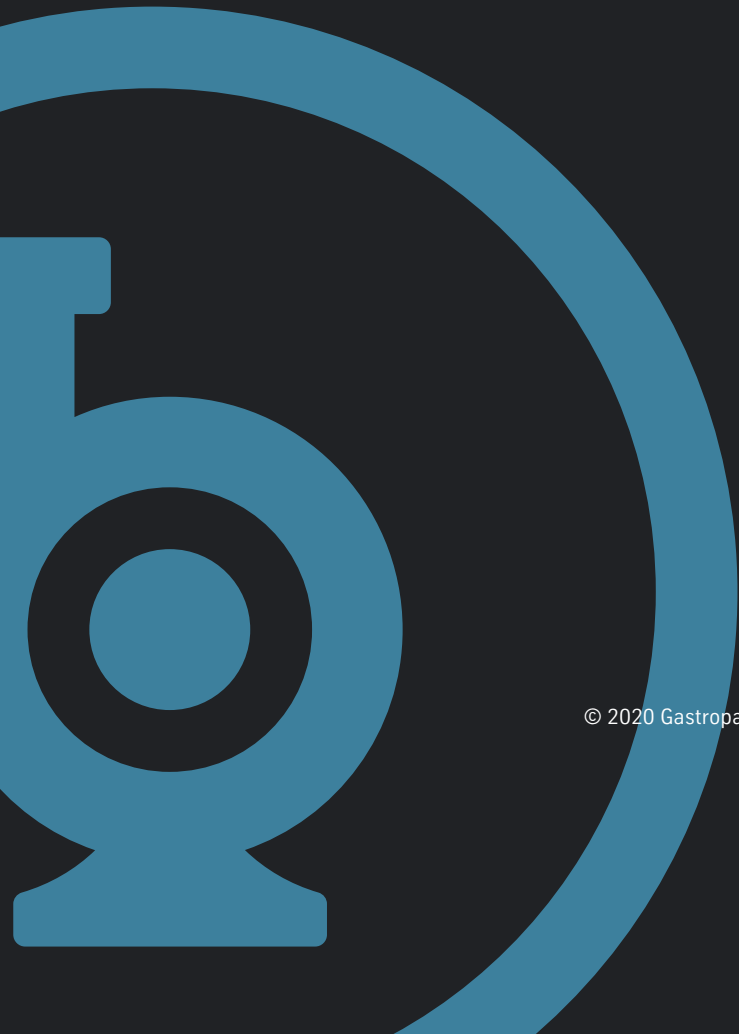

© 2020 Gastroparts Sp. J. All rights reserved.