







GASTROPARTS

zmywarki / dishwashers

LAMBER

-  www.gastroparts.com
-  gastroparts@gastroparts.com
-  tel. +48 56 657 00 68
-  [/gastroparts.global](https://www.facebook.com/gastroparts.global)
-  [/gastroparts.global](https://www.instagram.com/gastroparts.global)



heating elements

coil heating elements



Part No.	418823	Ref. No.	0303100
description	heating element 1000W 230V L 405mm W 50mm H 25mm tube ϕ 8.5mm thread M14x1.5 connection M5 heating circuits 1		

immersion heating elements

3 hole flange ϕ 57.5mm

Part No.	416229	Ref. No.	0303001
description	heating element 2400W 230V mounting ϕ 57.5mm heating circuits 2 L 235mm W 37mm H 35mm number of thermostat sleeves 1 thermostat sleeves ϕ 7mm length thermostat sleeves 225mm thermostat sleeve not clinging tube ϕ 8mm hole distance 75mm hole ϕ 7.8mm connection length 29mm connection M5 3 hole flange immersion heater		
For models:	DSP1, DSP2, S200, S280, S280Dep, Super-QS, Super-QS-Dep		



Part No.	416230	Ref. No.	0300011
description	heating element 3000W 230V mounting ϕ 57.5mm heating circuits 3 L 235mm W 34mm H 48mm number of thermostat sleeves 1 thermostat sleeves ϕ 7mm length thermostat sleeves 215mm thermostat sleeve upper tube ϕ 8.5mm hole distance 72mm hole ϕ 10mm connection length 20mm connection M5 3 hole flange immersion heater		
For models:	015-24L, 050F, 050F-Dep, DSP5, MATIC20, P550		

Part No.	416231	Ref. No.	0300002
description	heating element 4500W 230V mounting ϕ 57.5mm heating circuits 3 L 307mm W 45mm H 36mm number of thermostat sleeves 1 thermostat sleeves ϕ 7mm length thermostat sleeves 210mm thermostat sleeve eccentric, non clinging tube ϕ 8.5mm hole distance 74mm hole ϕ 8/10mm connection M5 3 hole flange immersion heater		
For models:	DSP4, DSP5, F85, F85-Dep, MATIC20		

Part No.	416231	Ref. No.	0300002
description	heating element 4500W 230V mounting ϕ 57.5mm heating circuits 3 L 307mm W 45mm H 36mm number of thermostat sleeves 1 thermostat sleeves ϕ 7mm length thermostat sleeves 210mm thermostat sleeve eccentric, non clinging tube ϕ 8.5mm hole distance 74mm hole ϕ 8/10mm connection M5 3 hole flange immersion heater		
For models:	DSP4, DSP5, F85, F85-Dep, MATIC20		

Part No.	416231	Ref. No.	0300002
description	heating element 4500W 230V mounting ϕ 57.5mm heating circuits 3 L 307mm W 45mm H 36mm number of thermostat sleeves 1 thermostat sleeves ϕ 7mm length thermostat sleeves 210mm thermostat sleeve eccentric, non clinging tube ϕ 8.5mm hole distance 74mm hole ϕ 8/10mm connection M5 3 hole flange immersion heater		
For models:	DSP4, DSP5, F85, F85-Dep, MATIC20		

Part No.	416231	Ref. No.	0300002
description	heating element 4500W 230V mounting ϕ 57.5mm heating circuits 3 L 307mm W 45mm H 36mm number of thermostat sleeves 1 thermostat sleeves ϕ 7mm length thermostat sleeves 210mm thermostat sleeve eccentric, non clinging tube ϕ 8.5mm hole distance 74mm hole ϕ 8/10mm connection M5 3 hole flange immersion heater		
For models:	DSP4, DSP5, F85, F85-Dep, MATIC20		

Part No.	416231	Ref. No.	0300002
description	heating element 4500W 230V mounting ϕ 57.5mm heating circuits 3 L 307mm W 45mm H 36mm number of thermostat sleeves 1 thermostat sleeves ϕ 7mm length thermostat sleeves 210mm thermostat sleeve eccentric, non clinging tube ϕ 8.5mm hole distance 74mm hole ϕ 8/10mm connection M5 3 hole flange immersion heater		
For models:	DSP4, DSP5, F85, F85-Dep, MATIC20		

accessories for	416231			
	Part No.	520258	Ref. No.	0301112
	protection cap			

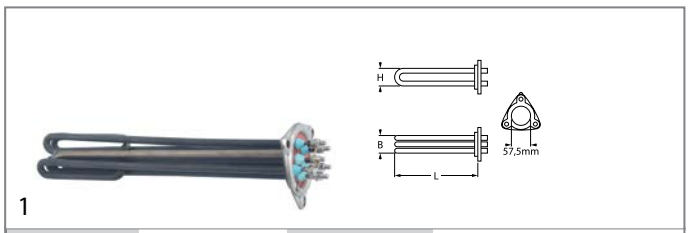

Part No.	416232	Ref. No.	0300012
description	heating element 6000W 230V mounting ϕ 57.5mm heating circuits 3 L 293mm W 40mm H 36mm number of thermostat sleeves 1 thermostat sleeves ϕ 7mm length thermostat sleeves 280mm thermostat sleeve eccentric, non clinging tube ϕ 8.5mm hole distance 74mm hole ϕ 8x10mm connection M5 3 hole flange immersion heater		
For models:	015-24L, F85, F85-Dep, L20, L21, LP31L, LP6L, M115, M150, MATIC20, P550		

Part No.	416232	Ref. No.	0300012
description	heating element 6000W 230V mounting ϕ 57.5mm heating circuits 3 L 293mm W 40mm H 36mm number of thermostat sleeves 1 thermostat sleeves ϕ 7mm length thermostat sleeves 280mm thermostat sleeve eccentric, non clinging tube ϕ 8.5mm hole distance 74mm hole ϕ 8x10mm connection M5 3 hole flange immersion heater		
For models:	015-24L, F85, F85-Dep, L20, L21, LP31L, LP6L, M115, M150, MATIC20, P550		

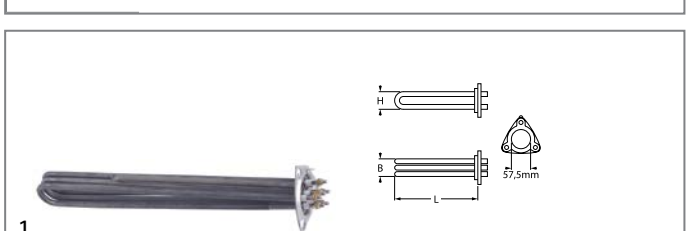

Part No.	416233	Ref. No.	0300299
description	heating element 9000W 230V mounting ϕ 57.5mm heating circuits 3 L 440mm W 42mm H 38mm number of thermostat sleeves 1 thermostat sleeves ϕ 7.5mm length thermostat sleeves 290mm thermostat sleeve eccentric, non clinging tube ϕ 8.5mm hole distance 73mm hole ϕ 8/10mm connection M5 3 hole flange immersion heater		
For models:	015-24L, LP31L, LP6, LP6L, M115, M150, MATIC20		

Part No.	416233	Ref. No.	0300299
description	heating element 9000W 230V mounting ϕ 57.5mm heating circuits 3 L 440mm W 42mm H 38mm number of thermostat sleeves 1 thermostat sleeves ϕ 7.5mm length thermostat sleeves 290mm thermostat sleeve eccentric, non clinging tube ϕ 8.5mm hole distance 73mm hole ϕ 8/10mm connection M5 3 hole flange immersion heater		
For models:	015-24L, LP31L, LP6, LP6L, M115, M150, MATIC20		

Part No.	416233	Ref. No.	0300299
description	heating element 9000W 230V mounting ϕ 57.5mm heating circuits 3 L 440mm W 42mm H 38mm number of thermostat sleeves 1 thermostat sleeves ϕ 7.5mm length thermostat sleeves 290mm thermostat sleeve eccentric, non clinging tube ϕ 8.5mm hole distance 73mm hole ϕ 8/10mm connection M5 3 hole flange immersion heater		
For models:	015-24L, LP31L, LP6, LP6L, M115, M150, MATIC20		



Part No.	416225	Ref. No.	0303042
description	heating element 2400W 230V heating circuits 3 thread 1/4" L 275mm W 90mm H 40mm L1 25mm L2 50mm L3 200mm W1 31mm W2 28mm H1 20mm H2 20mm connection M4 immersion heater tube ϕ 6.3mm flange with thread connection length 40mm WS 32		
For models:	DSP5		



Part No.	416225	Ref. No.	0303042
description	heating element 2400W 230V heating circuits 3 thread 1/4" L 275mm W 90mm H 40mm L1 25mm L2 50mm L3 200mm W1 31mm W2 28mm H1 20mm H2 20mm connection M4 immersion heater tube ϕ 6.3mm flange with thread connection length 40mm WS 32		
For models:	DSP5		

Part No.	416225	Ref. No.	0303042
description	heating element 2400W 230V heating circuits 3 thread 1/4" L 275mm W 90mm H 40mm L1 25mm L2 50mm L3 200mm W1 31mm W2 28mm H1 20mm H2 20mm connection M4 immersion heater tube ϕ 6.3mm flange with thread connection length 40mm WS 32		
For models:	DSP5		



Part No.	416225	Ref. No.	0303042
description	heating element 2400W 230V heating circuits 3 thread 1/4" L 275mm W 90mm H 40mm L1 25mm L2 50mm L3 200mm W1 31mm W2 28mm H1 20mm H2 20mm connection M4 immersion heater tube ϕ 6.3mm flange with thread connection length 40mm WS 32		
For models:	DSP5		

Table continues overleaf



accessories for	416225			
	Part No.	520232	Ref. No.	—
	nut thread 1/4" H 5mm nickel-plated brass WS 47 Qty 1 pcs			
	Part No.	528021	Ref. No.	—
	flat gasket PTFE ED ø 53mm ID ø 42.5mm thickness 3mm Qty 1 pcs equiv. no. 12001/02286 suitable for Astoria/Aurora/Brasilia/Wega			







Part No.	416226	Ref. No.	0300022	
description	heating element 4500W 230V heating circuits 3 thread 1/4" L 260mm W 90mm H 35mm L1 60mm L2 50mm L3 150mm W1 31mm W2 28mm H1 15mm H2 20mm connection M4 immersion heater tube ø 6.3mm flange with thread connection length 42mm			
accessories for	416226			
	Part No.	510405	Ref. No.	—
	flat gasket fibre ED ø 56mm ID ø 42mm thickness 2mm for thread 1/4" Qty 1 pcs			
	Part No.	520232	Ref. No.	—
	nut thread 1/4" H 5mm nickel-plated brass WS 47 Qty 1 pcs			
	Part No.	528021	Ref. No.	—
	flat gasket PTFE ED ø 53mm ID ø 42.5mm thickness 3mm Qty 1 pcs equiv. no. 12001/02286 suitable for Astoria/Aurora/Brasilia/Wega			



Part No.	420358	Ref. No.	0303045	
description	heating element 1000W 230V heating circuits 1 L 125mm W 40mm H 35mm thread 1/4" mounting distance 32mm tube ø 8mm connection male faston 6.3mm immersion heater 2 hole fixing			
accessories for	420358			
	Part No.	501362	Ref. No.	—
	flat gasket fibre ED ø 22mm ID ø 13.5mm thickness 2mm Qty 1 pcs			







Part No.	416227	Ref. No.	0303044	
description	heating element 1000W 230V heating circuits 1 L 195mm W 40mm thread 1/4" mounting distance 32mm tube ø 8mm 2 hole fixing immersion heater connection male faston 6.3mm			
For models:	S200			
accessories for	416227			
	Part No.	361182	Ref. No.	—
	nut thread 1/4" H 5mm nickel-plated brass WS 17 Qty 1 pcs			
	Part No.	510417	Ref. No.	—
	flat gasket fibre ED ø 20mm ID ø 14mm thickness 2mm Qty 1 pcs			
	Part No.	520228	Ref. No.	—
	tooth lock washer ID ø 15.3mm ED ø 24mm steel Qty 1 pcs for thread M14			

accessories for	416227			
	Part No.	550262	Ref. No.	—
	flat gasket copper ED ø 20mm ID ø 14mm thickness 2mm			



Part No.	416228	Ref. No.	0300067	
description	heating element 2000W 230V heating circuits 1 L 197mm W 46mm H 33mm thread 1/4" mounting distance 38mm tube ø 8.5mm connection male faston 6.3mm immersion heater 2 hole fixing			
For models:	050F, 050F-Dep, DSP1, DSP2, DSP4, F85, F85-Dep, L20, L21, S280, S280Dep, Super-QS, Super-QS-Dep			

accessories for	416228			
	Part No.	361182	Ref. No.	—
	nut thread 1/4" H 5mm nickel-plated brass WS 17 Qty 1 pcs			
	Part No.	510417	Ref. No.	—
	flat gasket fibre ED ø 20mm ID ø 14mm thickness 2mm Qty 1 pcs			
	Part No.	520228	Ref. No.	—
	tooth lock washer ID ø 15.3mm ED ø 24mm steel Qty 1 pcs for thread M14			
	Part No.	550262	Ref. No.	—
	flat gasket copper ED ø 20mm ID ø 14mm thickness 2mm			



Part No.	420220	Ref. No.	0303050	
description	heating element 3000W 230V heating circuits 1 L 270mm W 39mm H 18mm thread 1/4" mounting distance 31mm tube ø 8mm connection screw 2 hole fixing immersion heater			

thermostats

bi-metal thermostats

safety bi-metal thermostats



Part No.	375913	Ref. No.	0300302	
description	bi-metal safety thermostat hole distance 23.8mm switch-off temp. 105°C 1NC 1-pole 16A connection F6.3 2 hole fixing mounting ø 18mm			
For models:	015-24L, DSP4, DSP5, F85-Dep, L20, L21			

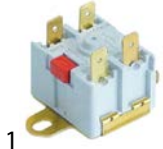

Part No.	390681	Ref. No.	0300301
description	bi-metal safety thermostat hole distance 40mm switch-off temp. 105°C 2NC 2-pole 16A 250V connection F6.3		
For models:	050F, 050F-Dep, DSP1, DSP2		

bi-metal thermostats



Part No.	390680	Ref. No.	0300303
description	bi-metal thermostat hole distance 23.8mm switch-off temp. 65°C 1NC 1-pole 16A connection F6.3 2 hole fixing		
For models:	DSP1, DSP2, DSP4, DSP5		

control and safety thermostats

IMIT / TEMPOMATIC / ARTHERMO

control thermostats

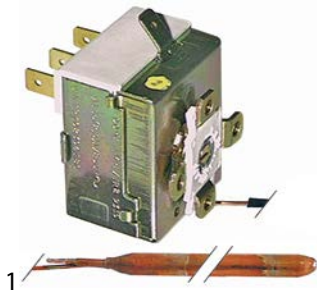

Part No.	390460	Ref. No.	0300005
description	thermostat t.max. 90°C temperature range 30-90°C 1-pole 1CO 16A probe ø 6.5mm probe L 95mm capillary pipe 2000mm capillary pipe isolated 1950mm gland nut shaft ømm shaft Lmm shaft position rotation 270° probe material copper		
For models:	015-24L, 050F, 050F-Dep, DSP1, DSP2, DSP4, DSP5, F85, F85-Dep, L20, L21, LP31L, LP6, LP6L, P550, S200, S280, S280Dep, Super-QS, Super-QS-Dep		

safety thermostats



Part No.	390751	Ref. No.	0300305
description	safety thermostat switch-off temp. 80°C 1-pole 1CO probe ø 5mm probe L 131mm capillary pipe 1000mm capillary pipe isolated 930mm gland nut probe		
For models:	M115, M150, MATIC20		

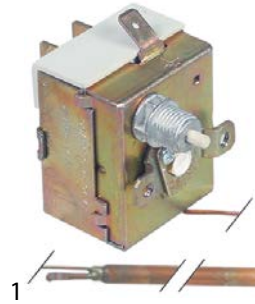

Part No.	390458	Ref. No.	0300004 0300196
description	safety thermostat switch-off temp. 90-110°C 1-pole 16A probe ø 6.5mm probe L 90mm capillary pipe 2000mm capillary pipe isolated 1950mm gland nut probe		
For models:	F85, LP31L, LP6, LP6L, P550, S200, S280, S280Dep, Super-QS, Super-QS-Dep		

PRODIGY / FIRT

control thermostats



Part No.	390733	Ref. No.	0300270
description	thermostat t.max. 90°C temperature range 30-90°C 1-pole 16A probe ø 6.5mm probe L 85mm capillary pipe 1350mm capillary pipe isolated 1325mm shaft ø 6x4.6mm shaft L 5mm rotation 270° 230V with knob		
For models:	M115, M150, MATIC20		

accessories

plunger sockets



Part No.	506059	Ref. No.	0200270
description	thermowell double		
For models:	015-24L, F85, LP31L, LP6, LP6L, M115, M150, MATIC20, P550		



			
1			
Part No.	506130	Ref. No.	0300006
description	thermowell thread 1/2" L 107mm SS single ø 6.5mm		
For models:	015-24L, 050F, 050F-Dep, F85, F85-Dep, L20, L21, S200, S280, S280Dep, Super-QS, Super-QS-Dep		

			
1			
Part No.	345565	Ref. No.	0301000
description	push switch mounting measurements 28.5x28.5mm green 2NO 250V 16A connection male faston 6.3mm ambient temperature max. 150°C protection IP40		
For models:	015-24L, 050F, 050F-Dep, DSP5, F85, L20, LP31L, LP6, LP6L, P550, S200, S280, S280Dep, Super-QS, Super-QS-Dep		
spare parts for	345565		
	Part No.	345131	Ref. No. —
	 element holder mounting measurements 28.5x28.5mm grey single element holder		
	Part No.	345132	Ref. No. —
	 push button ø 23mm green		
	Part No.	345720	Ref. No. —
	 switch 2NO 250V 16A connection male faston 6.3mm		

switches and momentary switches

push/momentary push switches

19x13mm			
			
1			
Part No.	359446 ¹	Ref. No.	0301003
description	push switch mounting measurements 19x13mm yellow 2NO 250V 16A illuminated connection male faston 6.3mm ambient temperature max. 125°C protection IP65 with cover cap		
For models:	DSP1, DSP2, DSP4		

¹illuminated

28.5x28.5mm			
			
1			
Part No.	345498	Ref. No.	0301101
description	momentary push switch mounting measurements 28.5x28.5mm green 2NO 250V 16A connection male faston 6.3mm ambient temperature max. 150°C protection IP40		
For models:	S200		

			
1			
Part No.	345497	Ref. No.	0301005
description	push switch mounting measurements 28.5x28.5mm green 2CO 250V 16A connection male faston 6.3mm ambient temperature max. 150°C protection IP40		
For models:	015-24L, 050F, 050F-Dep, F85, L20, L21, S200, S280, S280Dep, Super-QS, Super-QS-Dep		

			
1			
Part No.	345499	Ref. No.	0301004
description	push switch mounting measurements 28.5x28.5mm grey 1CO/1NO 250V 16A connection male faston 6.3mm ambient temperature max. 150°C protection IP40		
For models:	050F, 050F-Dep, F85, S280Dep, Super-QS-Dep		

microswitches

lever actuated

			
1			
Part No.	346969	Ref. No.	0300141
description	microswitch with lever 250V 16A 1NO connection male faston 6.3mm L 59mm L1 29mm ambient temperature max. 120°C mounting distance 22mm actuating force: 50g lever length 50mm		

position switches

SIEMENS

3SE0 series

switches (complete)

			
1			
Part No.	347236	Ref. No.	0300232
description	position switch with handle with a switch 1NO/1NC 230V		



system switches (ROLD)



1

Part No.	345537	Ref. No.	0301051
description	element holder mounting measurements 20.6x16.4mm grey arched for push buttons 13x17mm		
For models:	015-24L, 050F, 050F-Dep, DSP5, F85-Dep, L20, L21		



1

Part No.	346810	Ref. No.	0301068
description	push button size 17x13mm blue		
For models:	015-24L, 050F, 050F-Dep, DSP5, F85-Dep, L20, L21		



1

Part No.	346809	Ref. No.	0301066
description	push button size 17x13mm green		
For models:	015-24L, 050F, 050F-Dep, DSP5, L20		



1

Part No.	345539	Ref. No.	0301069
description	push button size 17x13mm grey		
For models:	050F, 050F-Dep, DSP5, F85-Dep		



1

Part No.	346572	Ref. No.	0301067
description	push button size 17x13mm yellow		
For models:	F85-Dep		

rotary switches

LOVATO



1

Part No.	347976 ¹	Ref. No.	0301020
description	rotary switch 2 0-1 sets of contacts 2 type GN209775U20 690V 20A shaft ø 6x6mm shaft L 15mm shaft square connection screw		

¹incl. knob and dial plate

1

Part No.	347429 ¹	Ref. No.	0301022
description	rotary switch 3 0-1-2 sets of contacts 3 type GN209773U20 690V 20A shaft ø 6x6mm shaft L 15mm shaft square connection screw		
For models:	M150, MATIC20		
spare parts for	347429		



Part No.	112633	Ref. No.	0300352
-----------------	--------	-----------------	---------

knob ø 33mm shaft ø 6x6mm grey

¹incl. knob

1

Part No.	345799	Ref. No.	0300206 0301019 0301025
description	rotary switch 4 1-2-3-4 sets of contacts 7 type GN20 9779 U20 690V 20A shaft ø 6x6mm shaft L 13.5mm shaft square connection screw		
For models:	015-24L, F85-Dep, L21, LP31L, LP6, LP6L, P550		
accessories for	345799		



Part No.	112633	Ref. No.	0300352
-----------------	--------	-----------------	---------

knob ø 33mm shaft ø 6x6mm grey

accessories

levers



1

Part No.	347168	Ref. No.	0301084
description	lever 0-1 lever length 118mm L 90mm W 90mm shaft 8x8mm mounting distance 68x68mm		
For models:	M150, MATIC20		



magnetic switches

40x13mm

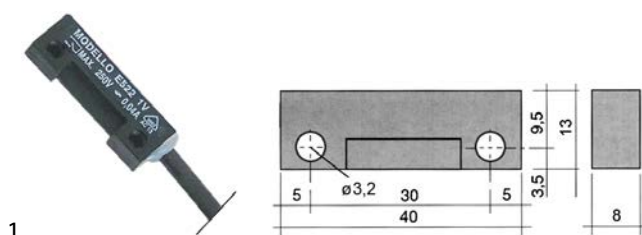

Part No.	345504	Ref. No.	0300138 0300183
description	magnetic switch L 40mm W 13mm 1NO 250V 0.04A P max. 10W connection cable cable length 1000mm		
For models:	015-24L, 050F, 050F-Dep, DSP1, DSP2, DSP4, DSP5, F85, F85-Dep, L20, L21, P550, S200, S280, S280Dep, Super-QS, Super-QS-Dep		
accessories for	345504		
	Part No.	345399	Ref. No. 0800141 0800142
	magnet ø 3.3mm L 40mm H 8mm W 13mm hole distance 30mm M3		

65x20mm

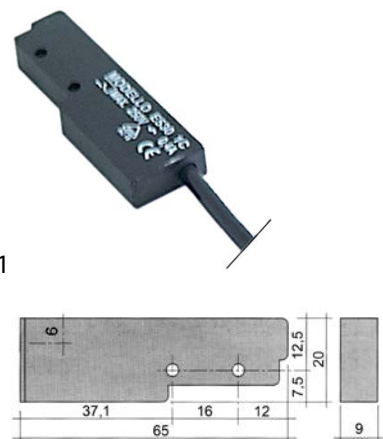

Part No.	345116	Ref. No.	0300082
description	magnetic switch L 65mm W 20mm 1NO 250V 0.4A P max. 100W connection cable cable length 3000mm		
For models:	LP31L, LP6, LP6L, M115, M150, MATIC20		
accessories for	345116		
	Part No.	345399	Ref. No. 0800141 0800142
	magnet ø 3.3mm L 40mm H 8mm W 13mm hole distance 30mm M3		

accessories

magnets

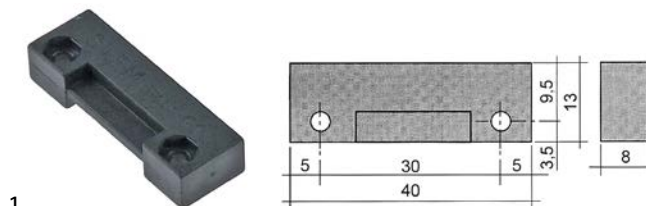

Part No.	345399	Ref. No.	0800141 0800142
description	magnet ø 3.3mm L 40mm H 8mm W 13mm hole distance 30mm M3		
For models:	015-24L, DSP5		



Part No.	347653	Ref. No.	0800139
description	magnet ø 8mm L 40mm		
For models:	M115, M150, MATIC20		

magnetic holders



Part No.	347943	Ref. No.	0200623
description	magnet holder H 75mm thread M10x1.5 ø 17mm		
For models:	M115, M150, MATIC20		

miscellaneous



Part No.	347938	Ref. No.	0406141
description	bracket L 86mm W 10mm H 12mm for magnetic switch SS		
For models:	015-24L, L20, L21		



control equipment

SIEMENS

3SB series ø22mm new

switches (complete)





1

Part No.	347942	Ref. No.	0301010
description	momentary push switch mounting measurements ø22mm blue 1NO non-illuminated		
For models:	LP31L, LP6, LP6L, M115, M150, MATIC20, P550		
spare parts for	347942		
	Part No.	346630	Ref. No. —
	contact block SIEMENS 3SB3400-0B 1NO max 400V 10A black		



1

Part No.	347944	Ref. No.	0301011
description	momentary push switch mounting measurements ø22mm red 1NC/1NO OFF		
For models:	M115, M150, MATIC20		
spare parts for	347944		
	Part No.	346630	Ref. No. —
	contact block SIEMENS 3SB3400-0B 1NO max 400V 10A black		
	Part No.	346631	Ref. No. —
	contact block SIEMENS 3SB3400-0C 1NC max 400V 10A black		

miscellaneous



1

Part No.	347939	Ref. No.	0300397
description	contact block red L 74mm 1NC 1-pole ø 22mm type ECX1030		
For models:	M150, MATIC20		
accessories for	347939		
	Part No.	347940	Ref. No. 0301015
	emergency stop switch mounting measurements ø22mm red		



1

Part No.	347940	Ref. No.	0301015
description	emergency stop switch mounting measurements ø22mm red		
For models:	M115, M150, MATIC20		
accessories for	347940		
	Part No.	347939	Ref. No. 0300397
	contact block red L 74mm 1NC 1-pole ø 22mm type ECX1030		

lamps

indicator lights

indicator lights (complete)

ø10mm

with screw socket



1

Part No.	357023	Ref. No.	0301901
description	indicator light ø 10mm 24V green cable length 200mm		
For models:	LP31L, LP6, M115		



1

Part No.	360578	Ref. No.	0301907
description	indicator light ø 10mm white 24V connection cable cable length 200mm		
For models:	LP31L, LP6		



1

Part No.	360579	Ref. No.	0301902
description	indicator light ø 10mm yellow 24V connection cable cable length 200mm		
For models:	LP31L, LP6, M115		

screw-on/push-on fit

light bulbs

for indicator lights



1

Part No.	359807	Ref. No.	0300387
description	light bulb socket Ba9s 24V 2W ø 10mm L 28mm clear		
For models:	M150, MATIC20		



timers

programme timers





1

Part No.	402949	Ref. No.	0300829 0301821
description	electronic timer 9.2.21.16G engines chambers operation time 230V shaft ømm shaft Lmm voltage 50/60		
For models:	DSP5		





1

Part No.	360403	Ref. No.	0300818
description	timer CDC 11803 engines 1 chambers 3 operation time 120s 230V shaft ømm shaft Lmm manuf. no. 11803F1 / 0300818 motor type M48R ATS		
spare parts for	360403		
	Part No.	360118	Ref. No. 0300850
	motor CDC pinion ø 4.9mm teeth 10 230V voltage AC 50/60Hz turn direction right motor ø 47mm H 19.3mm motor type M48R ATS for timer cable length 260mm 1.9/2.5W		



1

Part No.	360257	Ref. No.	0300117
description	timer CDC 4904F engines 1 chambers 4 operation time 6min 230V shaft ømm shaft Lmm manuf. no. 4904F3 / 360257 motor type M48L ATS		
For models:	015-24L		
spare parts for	360257		
	Part No.	360083	Ref. No. —
	motor CDC pinion ø 4.9mm teeth 10 230V turn direction left motor ø 47mm H 19.3mm motor type M48L ATS for timer		



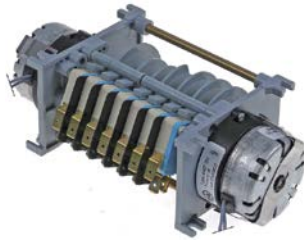

1

Part No.	360393	Ref. No.	0300803
description	timer CDC 4905 engines 1 chambers 5 operation time 12min 230V shaft ømm shaft Lmm		
For models:	L21, LP6L, P550		
spare parts for	360393		
	Part No.	360118	Ref. No. 0300850
	motor CDC pinion ø 4.9mm teeth 10 230V voltage AC 50/60Hz turn direction right motor ø 47mm H 19.3mm motor type M48R ATS for timer cable length 260mm 1.9/2.5W		



1

Part No.	360457	Ref. No.	0300822
description	timer CDC 4907DV engines 2 chambers 7 operation time 6s / 8min 24V		
For models:	LP31L, LP6		
spare parts for	360457		
	Part No.	360323	Ref. No. —
	motor CDC pinion ø 4.9mm teeth 10 24V voltage AC turn direction left motor ø 47mm H 19.3mm motor type M48L ATS for timer		



1





Part No.	360255	Ref. No.	0300101 0300806 0300807 0300812
description	timer CDC 7003F engines 1 chambers 3 operation time 6min 230V shaft ø 6x4.6mm shaft L 20mm manuf. no. 7003F3 / 360255 motor type M37LN		
For models:	F85, L20		
spare parts for	360255		
	Part No.	360131	Ref. No. —
	motor CDC pinion ø 5.4mm teeth 12 230V turn direction left motor ø 37mm motor type M37LN for timer		



Table continues overleaf



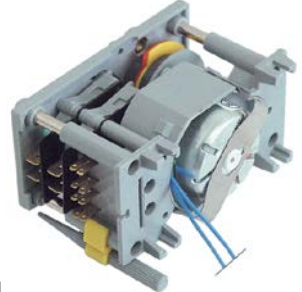

accessories for	360255		
	Part No.	110905	Ref. No. 0300049
	knob switch zero mark ø 42mm shaft ø 6x4.6mm shaft flat right black		

			
1			
Part No.	360582	Ref. No.	0300804
description	timer CDC 7802 engines 1 chambers 2 operation time 60s 208V 60Hz shaft ømm shaft Lmm manuf. no. 7802M1 / 0300804 motor type M37RS warewashing		

			
1			
Part No.	360254	Ref. No.	0300085
description	timer CDC 7802 engines 1 chambers 2 operation time 60s 230V manuf. no. 7802M1 / 0300085 motor type M37RN		
For models:	015-24L, 050F, 050F-Dep, F85, L20, L21, S200, S280, S280Dep, Super-QS, Super-QS-Dep		
spare parts for	360254		
	Part No.	360119	Ref. No. —
	motor CDC pinion ø 5.4mm teeth 12 230V turn direction right motor ø 37mm motor type M37RN for timer		

			
1			
Part No.	360256	Ref. No.	0300143
description	timer CDC 7804F engines 1 chambers 4 operation time 120s 230V shaft ømm shaft Lmm manuf. no. 7804F1 / 360256 motor type M37RN		
For models:	050F, 050F-Dep, S200, S280, S280Dep, Super-QS, Super-QS-Dep		
spare parts for	360256		
	Part No.	360119	Ref. No. —
	motor CDC pinion ø 5.4mm teeth 12 230V turn direction right motor ø 37mm motor type M37RN for timer		

			
1			
Part No.	360253	Ref. No.	0300297
description	timer CDC 7804F engines 1 chambers 4 operation time 20min 230V manuf. no. 7804F1 / 0300297 motor type M37RN		
For models:	050F, 050F-Dep, F85, S280Dep, Super-QS-Dep		
spare parts for	360253		
	Part No.	360119	Ref. No. —
	motor CDC pinion ø 5.4mm teeth 12 230V turn direction right motor ø 37mm motor type M37RN for timer		

			
1			
Part No.	360580	Ref. No.	0300821
description	timer CDC 7805F engines 1 chambers 5 operation time 120s 230V shaft ømm shaft Lmm manuf. no. 7805F1 motor type M37RN voltage AC		
For models:	050F, 050F-Dep		

			
1			
Part No.	360581	Ref. No.	0300805
description	timer CDC 7805F engines 1 chambers 5 operation time 150s 208V shaft ømm shaft Lmm manuf. no. 7805F1 motor type M37RS voltage AC		
For models:	S200, S280, S280Dep, Super-QS, Super-QS-Dep		





1

Part No.	360500	Ref. No.	0300801
description	timer CDC 7806M engines 1 chambers 6 operation time 150s 230V manuf. no. 7806M1 motor type M37RN 5 chambers adjustable, 1 chamber fixed voltage AC		



1

Part No.	360402	Ref. No.	0300100
description	timer CDC 9003F engines 1 chambers 3 operation time 6min 230V shaft ϕ 6x4.6mm shaft L 22mm manuf. no. 9003F3 / 0300100 motor type M48R ATS		
spare parts for	360402		
	Part No.	Ref. No.	0300850
	motor CDC pinion ϕ 4.9mm teeth 10 230V voltage AC 50/60Hz turn direction right motor ϕ 47mm H 19.3mm motor type M48R ATS for timer cable length 260mm 1.9/2.5W		
accessories for	360402		
	Part No.	Ref. No.	—
	knob switch zero mark ϕ 42mm shaft ϕ 6x4.6mm shaft flat adjustable black		

digital timers



1

Part No.	400946	Ref. No.	0300810
description	timer electronic		

spare parts and accessories

motors

CDC



1

Part No.	360118	Ref. No.	0300850
description	motor CDC pinion ϕ 4.9mm teeth 10 230V voltage AC 50/60Hz turn direction right motor ϕ 47mm H 19.3mm motor type M48R ATS for timer cable length 260mm 1.9/2.5W		

contactors

GENERAL ELECTRIC (AEG)

power contactors



1

Part No.	380244	Ref. No.	0300390
description	power contactor resistive load 25A 230VAC (AC3/400V) 9A/4kW main contacts 3NO auxiliary contacts 1NO connection screw connection type AEG LS4K 10A type GE CL00A 310		
For models:	P550		

TELEMECANIQUE (Schneider Electric)



1

Part No.	380450	Ref. No.	0300198
description	overload switch setting range 1.8-2.6A for contactors LC1K		
For models:	015-24L, P550		

1

Part No.	380760	Ref. No.	0300199 0300322
description	overload switch setting range 2.6-3.7A for contactors LC1K		



1

Part No.	380452	Ref. No.	0300324
description	overload switch setting range 3.7 - 5.5A for contactors LC1K		

relays

power relays

with bracket mounting



1

Part No.	380815	Ref. No.	0301794
description	power relays 230VAC 16A 2NO connection male faston 6.3mm flange dimensions 36x38x68mm		



1

Part No.	380808	Ref. No.	0301746
description	power relays FINDER 230VAC 16A 3CO connection male faston 6.3mm bracket mounting manuf. no. 62.83.8.230.0000		
For models:	050F, 050F-Dep, F85, F85-Dep, S280Dep, Super-QS-Dep		

relay sockets



1

Part No.	380885	Ref. No.	0300121
description	relay socket 11-pole dimensions 47x47x20mm		

time relays

time relays



1

Part No.	401894	Ref. No.	0300823
description	time relay 9.2.21.04G 230V 11-pole model NDWT 30/11		
accessories for	401894		
	Part No.	380885	Ref. No. 0300121
	relay socket 11-pole dimensions 47x47x20mm		

electronic controllers

EVCO - EVERY CONTROL

electronic thermometers

built-in version



1

Part No.	378346	Ref. No.	0500400
description	thermometer EVCO type EVK100P3 mounting measurements 71x29mm 12/24V voltage AC/DC -50 up to +150°C measuring input PTC display 3½ digits front measurements 75x33mm protection IP64 accuracy 1%		



probes

accessories

probe extension cables



Part No.	378309	Ref. No.	0305101
description	probe L 2500mm		

electronics

PCBs



Part No.	403266	Ref. No.	0500406
description	thermometer dishwasher Linear 30/40/60 LS 350/500 L 10mm W 9mm temperature 24V		

keypads

front foils



Part No.	506441	Ref. No.	0400041
description	front foil		



Part No.	506152	Ref. No.	0500230
description	keypad foil dishwasher S200/240		
For models:	S200		

membrane keypads



Part No.	403279	Ref. No.	0502003 0502008
description	membrane keypad warewashing 045F buttons 3 Qty 1 pcs L 317mm W 40mm		

control panel



Part No.	506440	Ref. No.	0400192
description	control panel		

solenoid valves

solenoid valves (water)





TP













Part No.	370021	Ref. No.	0300056	
description	solenoid valve double straight 230VAC inlet 3/4" outlet 11.5mm DN10 TP flow regulating valve inlet white			
spare parts for	370021			
	Part No.	371013	Ref. No.	—
	solenoid coil TP 230VAC 50/60Hz			
accessories for	370021			
	Part No.	371220	Ref. No.	—
	reducer TP flow rate 3l/min red tolerance ±15%			
	Part No.	371221	Ref. No.	—
	reducer TP flow rate 5.5l/min yellow tolerance ±15%			
	Part No.	371222	Ref. No.	—
	reducer TP flow rate 6l/min grey tolerance ±15%			
	Part No.	371223	Ref. No.	—
	reducer TP flow rate 10l/min white tolerance ±15%			
	Part No.	371224	Ref. No.	—
	reducer TP flow rate 12l/min bronze tolerance ±15%			
	Part No.	371225	Ref. No.	—
	reducer TP flow rate 16l/min light brown tolerance ±15%			
	Part No.	371226	Ref. No.	—
	reducer TP flow rate 20l/min red tolerance ±15%			
	Part No.	371230	Ref. No.	—
	reducer TP flow rate 0.25l/min red tolerance ±25%			
	Part No.	371231	Ref. No.	—
	reducer TP flow rate 0.35l/min violet tolerance ±25%			
	Part No.	371232	Ref. No.	—
	reducer TP flow rate 0.5l/min orange tolerance ±25%			
	Part No.	371233	Ref. No.	—
	reducer TP flow rate 0.8l/min white tolerance ±25%			
	Part No.	371234	Ref. No.	—
	reducer TP flow rate 1l/min light blue tolerance ±25%			
	Part No.	371235	Ref. No.	—
	reducer TP flow rate 1.2l/min brown tolerance ±25%			

Table continues overleaf



accessories for		370021		
Part No.		371236	Ref. No.	—
	reducer TP flow rate 1.5l/min light brown tolerance ±25%			
	reducer TP flow rate 2.5l/min yellow tolerance ±25%			
	reducer TP flow rate 3.4l/min dark green tolerance ±25%			
	reducer TP flow rate 5l/min black tolerance ±25%			
	reducer TP flow rate 8l/min blue tolerance ±20%			

  1				
Part No.	370017	Ref. No.	0300025	
description	solenoid valve single straight 230VAC inlet 3/4" outlet 11.5mm DN10 TP p max 10bar			
For models:	015-24L, 050F, 050F-Dep, DSP1, DSP2, DSP4, DSP5, F85, F85-Dep, L20, L21, LP6L, P550, S200, S280, S280Dep, Super-QS, Super-QS-Dep			
spare parts for		370017		
	Part No.	371013	Ref. No.	—
solenoid coil TP 230VAC 50/60Hz				
accessories for		370017		
	Part No.	371220	Ref. No.	—
reducer TP flow rate 3l/min red tolerance ±15%				
	Part No.	371221	Ref. No.	—
reducer TP flow rate 5.5l/min yellow tolerance ±15%				
	Part No.	371222	Ref. No.	—
reducer TP flow rate 6l/min grey tolerance ±15%				
	Part No.	371223	Ref. No.	—
reducer TP flow rate 10l/min white tolerance ±15%				
	Part No.	371224	Ref. No.	—
reducer TP flow rate 12l/min bronze tolerance ±15%				
	Part No.	371225	Ref. No.	—
reducer TP flow rate 16l/min light brown tolerance ±15%				
	Part No.	371226	Ref. No.	—
reducer TP flow rate 20l/min red tolerance ±15%				
	Part No.	371230	Ref. No.	—
reducer TP flow rate 0.25l/min red tolerance ±25%				
	Part No.	371231	Ref. No.	—
reducer TP flow rate 0.35l/min violet tolerance ±25%				

accessories for		370017		
Part No.		371232	Ref. No.	—
	reducer TP flow rate 0.5l/min orange tolerance ±25%			
	reducer TP flow rate 0.8l/min white tolerance ±25%			
	reducer TP flow rate 1l/min light blue tolerance ±25%			
	reducer TP flow rate 1.2l/min brown tolerance ±25%			
	reducer TP flow rate 1.5l/min light brown tolerance ±25%			
	reducer TP flow rate 2.5l/min yellow tolerance ±25%			
	reducer TP flow rate 3.4l/min dark green tolerance ±25%			
	reducer TP flow rate 5l/min black tolerance ±25%			
	reducer TP flow rate 8l/min blue tolerance ±20%			



solenoid valves with reducers

 1				
Part No.	370242	Ref. No.	0300096	
description	solenoid valve triple straight 230VAC inlet 3/4" outlet 11.5mm plastic			

various

 1				
Part No.	370241	Ref. No.	0301149	
description	solenoid valve 2-fold, with reducer straight 230VAC suitable for Lamber			
For models:	050F, 050F-Dep, F85, F85-Dep, S280, S280Dep, Super-QS, Super-QS-Dep			





 <p>1</p>			
Part No.	370636	Ref. No.	0301161
description	solenoid valve single CO 230VAC outlet 10.5mm MILANO 00168401 plastic 3-ways inlet 10.5mm 50/60Hz male faston 6.3mm		
accessories for	370636		
	Part No.	371142	Ref. No. —
	 reducer for solenoid valve ø 8.2mm		

metal
BÜRKERT
solenoid valves (various)

 <p>1</p>			
Part No.	370741	Ref. No.	0301159
description	solenoid valve 2-ways 230VAC inlet 1/2" IT outlet 1/2" IT L 135mm BÜRKERT membranes EPDM p max 16bar p min 0.2bar 50/60Hz brass		

 <p>1</p>			
Part No.	370544	Ref. No.	0300173
description	solenoid valve 2-ways 24VAC inlet 1/2" outlet 1/2" L 65mm DN 13mm BÜRKERT membranes NBR 24V brass		
For models:	M115, M150, MATIC20		

SIRAI			
2-way			
L180-B series			
 <p>1</p>			
Part No.	370391	Ref. No.	0300070
description	solenoid valve 2-ways 24VAC connection 3/4" L 79mm DN 18mm -10 up to +90°C coil type Z610A membranes NBR (water) p max 12bar p min 0.35bar		
For models:	LP31L, LP6		
accessories for	370391		
	Part No.	371091	Ref. No. —
	 power socket plug type DIN 43650B cable lengthmm small		

drain valves

 <p>1</p>			
Part No.	370543	Ref. No.	0300066
description	drain solenoid valve angled 230V single inlet 46mm outlet 1 1/2" duty cycle 60% SIRAI Z923G plastic		

 <p>1</p>			
Part No.	371109	Ref. No.	0301157
description	drain valve 230V 50/60Hz single inlet 50mm outlet 50mm		



pressure switches

for warewashing

ø 58mm with male faston 6.3mm

with connection horizontal



1

Part No.	541842	Ref. No.	0301503
description	pressure control pressure range 100/40mbar connection 6mm ø 58mm pressure connection horizontal warewashing pressure connection ø 5.5mm		
For models:	L20, L21		



1

Part No.	541165	Ref. No.	0300026 0301502
description	pressure control pressure range 60/30mbar connection 6mm ø 58mm pressure connection horizontal warewashing pressure connection ø 6mm		
For models:	015-24L, 050F, 050F-Dep, DSP1, DSP2, DSP4, DSP5, F85, F85-Dep, LP31L, LP6, LP6L, M115, M150, MATIC20, P550, S200, S280, S280Dep, Super-QS, Super-QS-Dep		

pumps



wash and rinse pumps

ALBA (C&A)

pumps



1

Part No.	500417	Ref. No.	0300252
description	pump inlet ø 28mm outlet ø 28mm type C904 230V 50Hz 1 phase 0.15kW 0.2HP L 200mm rotation direction right capacitor 6.3µF ALBA PUMPS (C&A)		
For models:	DSP1, DSP2, S200, S280, S280Dep, Super-QS, Super-QS-Dep		
spare parts for	500417		
	Part No.	365012	Ref. No. 0300110
	operating capacitor capacity 6.3µF 450V tolerance 5% 50Hz ambient temperature max. -25 to +85°C ø 30mm L 61mm M8 plastic connection male faston 6.3mm protection		
	Part No.	510693	Ref. No. 0200242 0200340 0209707
	mechanical shaft seal for shaft ø 12mm slide ring ext. ø 24mm slide ring H 15.5mm slide ring int. ø 11mm counter ring mounting ø 24mm height counter ring 8mm counter ring int. ø 13.5mm		
	Part No.	532490	Ref. No. —
	O-ring EPDM thickness 2.62mm ID ø 72.69mm Qty 1 pcs		

EBARA

pumps



1



Part No.	500357	Ref. No.	0301249 0301254
description	pump inlet ø 63mm outlet ø 63mm type DWO150 230/400V 50Hz 3 phase 1.1kW 1.5HP rotation direction left EBARA inlet ø 63mm outlet ø 63mm		
For models:	015-24L, P550		
spare parts for	500357		
	Part No.	503147	Ref. No. 0209906
	pump cover gasket thickness 3.53mm ID ø 148.8mm Qty 1 pcs		

Table continues overleaf





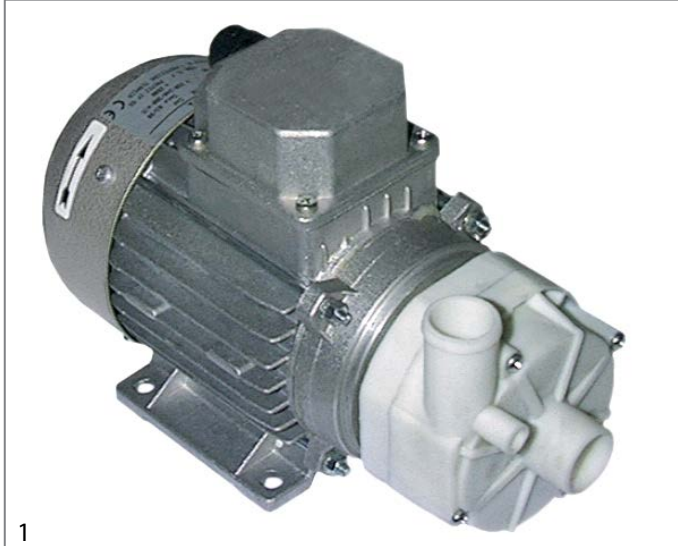

spare parts for 500357				
	Part No.	503148	Ref. No.	0209709
	mechanical shaft seal for shaft \varnothing 18mm height counter ring 12.5mm ID \varnothing 18.5mm ED \varnothing 32mm H 31mm mounting \varnothing 33mm int. \varnothing 1 19mm			
	Part No.	521270	Ref. No.	0209820
	impellor \varnothing 88mm H 24mm with flute shaft intake \varnothing 13mm rotation direction left blades 6 stainless steel			

FIR

pumps



1

Part No.	500030	Ref. No.	0300205	
description	pump inlet \varnothing 28mm outlet \varnothing 26mm type 4226.2540 230/400V 50Hz 3 phase 0.35kW 0.5HP L 260mm rotation direction right FIR			
spare parts for 500030				
	Part No.	510510	Ref. No.	—
	pump cover pump type 2212/2228/2229/2211			
	Part No.	510690	Ref. No.	—
	mechanical shaft seal for shaft \varnothing 8mm ED \varnothing 24mm mounting \varnothing 24/26mm			
	Part No.	521202	Ref. No.	—
	impellor \varnothing 72mm H 17mm thread M5L			
	Part No.	521703	Ref. No.	—
	pump cover gasket EPDM thickness 2.5mm ID \varnothing 75mm Qty 1 pcs			



1

Part No.	500375	Ref. No.	0300245
description	pump inlet \varnothing 45mm outlet \varnothing 40mm type 3983.1411 230V 50Hz 1 phase 0.37kW 0.5HP L 200mm rotation direction right capacitor 12.5 μ F FIR		

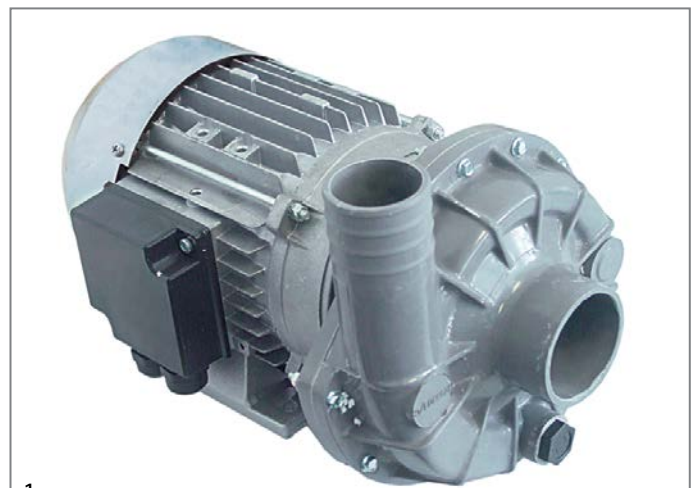

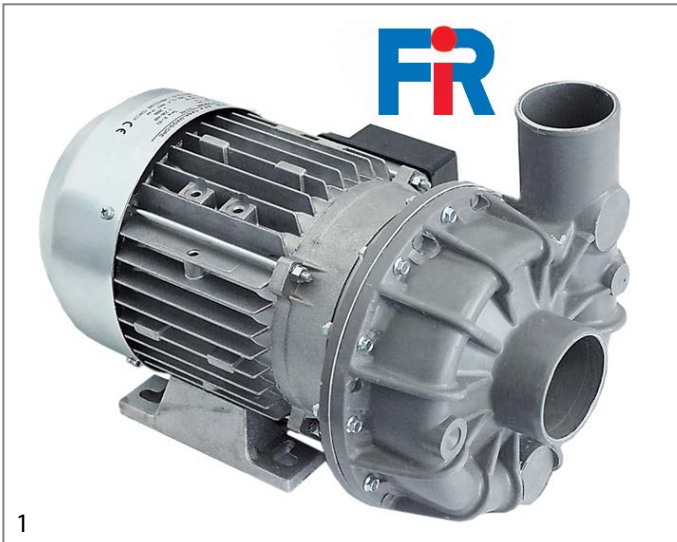

1

Part No.	500323	Ref. No.	0300310	
description	pump inlet \varnothing 63mm outlet \varnothing 47mm type 1227.2721 230/400V 50Hz 3 phase 2kW 2.7HP L 335mm rotation direction right FIR			
spare parts for 500323				
	Part No.	510599	Ref. No.	—
	impellor \varnothing 123mm H 34mm M8L			
	Part No.	510693	Ref. No.	0200242 0200340 0209707
	mechanical shaft seal for shaft \varnothing 12mm slide ring ext. \varnothing 24mm slide ring H 15.5mm slide ring int. \varnothing 11mm counter ring mounting \varnothing 24mm height counter ring 8mm counter ring int. \varnothing 13.5mm			
	Part No.	521513	Ref. No.	—
	pump cover FIR inlet \varnothing 63mm outlet \varnothing 47mm turn direction right ID \varnothing 150mm inner height 32mm			
	Part No.	524416	Ref. No.	0200290
	pump cover gasket thickness 4x4mm Qty 1 pcs			



1

Part No.	500111	Ref. No.	0300021	
description	pump inlet \varnothing 63mm outlet \varnothing 53mm type 1241.2500 230/400V 50Hz 3 phase 1.1kW 1.5HP L 330mm rotation direction left FIR			
spare parts for	500111			
	Part No.	510531	Ref. No.	0200593
	pump cover FIR inlet \varnothing 63mm outlet \varnothing 53mm auxiliary pressure connection M16x1.5mm supporting pressure open turn direction left \varnothing 185mm ID \varnothing 150mm inner high 37mm			
	Part No.	510612	Ref. No.	—
	impellor \varnothing 110mm H 34mm M8R			
	Part No.	510693	Ref. No.	0200242 0200340 0209707
	mechanical shaft seal for shaft \varnothing 12mm slide ring ext. \varnothing 24mm slide ring H 15.5mm slide ring int. \varnothing 11mm counter ring mounting \varnothing 24mm height counter ring 8mm counter ring int. \varnothing 13.5mm			
	Part No.	524416	Ref. No.	0200290
	pump cover gasket thickness 4x4mm Qty 1 pcs			



1

Part No.	499293	Ref. No.	0301243	
description	pump inlet \varnothing 63mm outlet \varnothing 53mm type 2241.2703 230/400V 50Hz 3 phase 0.89kW 1.2HP L 300mm rotation direction left FIR			

LGB



1

Part No.	500352	Ref. No.	0300373	
description	pump inlet \varnothing 28mm outlet \varnothing 26mm type ZF130SX 230V 50Hz 1 phase 0.2kW 0.27HP L 195mm rotation direction right capacitor 6.3 μ F LGB			
spare parts for	500352			
	Part No.	365012	Ref. No.	0300110
	operating capacitor capacity 6.3 μ F 450V tolerance 5% 50Hz ambient temperature max. -25 to +85°C \varnothing 30mm L 61mm M8 plastic connection male faston 6.3mm protection			
	Part No.	510122	Ref. No.	0200595
	pump cover LGB inlet \varnothing 28mm outlet \varnothing 26mm auxiliary pressure connection 13mm supporting pressure open \varnothing 98mm ID \varnothing 77mm inner high 31mm			
	Part No.	510703	Ref. No.	0200397
	mechanical shaft seal for shaft \varnothing 13mm slide ring H 13mm height counter ring 5.5mm ED \varnothing 26mm			
	Part No.	521085	Ref. No.	—
	impellor \varnothing 72mm H 17mm thread M7L shaft \varnothing 13mm shaft length 12mm blades 3			
	Part No.	528800	Ref. No.	0209905
	O-ring EPDM thickness 2.62mm ID \varnothing 75.87mm Qty 1 pcs			



1

Part No.	500355	Ref. No.	0301203 0301204
description	pump inlet ø 45mm outlet ø 40mm type ZF320SX 230V 50Hz 1 phase 0.7kW 0.95HP L 200mm rotation direction right capacitor 12.5µF LGB		
For models:	050F, 050F-Dep, DSP4, DSP5, F85, F85-Dep, L20, L21		
spare parts for	500355		
	Part No.	365014	Ref. No. 0300081
	operating capacitor capacity 12.5µF 450V tolerance 5%Hz ambient temperature max. -25 to +85°C ø 35mm L 70mm M8 plastic connection male faston 6.3mm 45S.C3DS.12.5 protection		
	Part No.	510702	Ref. No. —
	mechanical shaft seal height counter ring 5.5mm ID ø 12mm		
	Part No.	512404	Ref. No. —
	bracket mounting distance 130mm		
	Part No.	521246	Ref. No. —
	impellor ø 103mm H 26mm thread M8L shaft ø 20mm shaft length 7mm seat ø 8.2mm blades 6		
	Part No.	521542	Ref. No. —
	pump cover LGB inlet ø 45mm outlet ø 40mm auxiliary pressure connection 13mm supporting pressure open ø 150mm ID ø 120mm inner height 25mm		
	Part No.	521714	Ref. No. —
	pump cover gasket thickness 4x4mm Qty 1 pcs		

accessories for	500060		
	Part No.	520183	Ref. No. —
	reducer thread 1" ET - 3/4" IT brass		



1



Part No.	499292	Ref. No.	0100631
description	pump inlet ø 1¼" IT outlet ø 1" IT type CDX/A 120/07 230-240V 50Hz 3 phase 0.55kW 0.75HP L 320mm rotation direction left EBARA		
For models:	LP6		

drain pumps

PLASET



1

Part No.	500354	Ref. No.	0300068
description	drain pump inlet ø 30mm outlet ø 22mm 230V 30W 50Hz PLASET type 64079		
For models:	015-24L, 050F, 050F-Dep, DSP5, F85, F85-Dep, L20, L21, S200, S280, S280Dep, Super-QS, Super-QS-Dep		
accessories for	500354		
	Part No.	506074	Ref. No. 0200521
	drain hose ID ø 32mm ED ø 41mm L 1m wire reinforced		
	Part No.	506207	Ref. No. 0900006
	drain hose DN19 L 1500mm straight ø inside 19mm straight ext. ø 24mm elbow ø inside 21mm elbow ext. ø 27mm outer hose ø 25mm		

booster pumps I



1

Part No.	500060	Ref. No.	0300361
description	pump inlet ø 1" outlet ø 1" type PQM60 230V 50Hz 1 phase 0.37kW PEDRELLO		
For models:	015-24L, L20, L21, LP6L, P550		
accessories for	500060		
	Part No.	365015	Ref. No. 0300106
	operating capacitor capacity 10µF 400V tolerance 5%Hz ambient temperature max. -25 to +85°C ø 35.5mm L 59mm M8 plastic connection male faston 6.3mm protection		

accessories

pump cover gaskets



1

Part No.	510399	Ref. No.	0200241
description	pump cover gasket		



condensators & interference suppression filters

operating capacitors

plastic



1

Part No.	365015	Ref. No.	0300106
description	operating capacitor capacity 10µF 400V tolerance 5%Hz ambient temperature max. -25 to +85°C ø 35.5mm L 59mm M8 plastic connection male faston 6.3mm protection		
For models:	F85		



1

Part No.	365014	Ref. No.	0300081
description	operating capacitor capacity 12.5µF 450V tolerance 5%Hz ambient temperature max. -25 to +85°C ø 35mm L 70mm M8 plastic connection male faston 6.3mm 45S.C3DS.12.5 protection		
For models:	050F, 050F-Dep, DSP4, DSP5, F85, F85-Dep, L20, L21		



1

Part No.	365017	Ref. No.	0300105
description	operating capacitor capacity 5µF 450V tolerance 5% 50/60Hz ambient temperature max. -25 to +85°C ø 28mm L 54mm M8 plastic connection male faston 6.3mm 16.10.08 protection		
For models:	S200, S280, S280Dep, Super-QS, Super-QS-Dep		



1

Part No.	365012	Ref. No.	0300110
description	operating capacitor capacity 6.3µF 450V tolerance 5% 50Hz ambient temperature max. -25 to +85°C ø 30mm L 61mm M8 plastic connection male faston 6.3mm protection		

filters

interference suppression filters



1

Part No.	365046	Ref. No.	0300900
description	interference suppression filter type 10S7E-G1474253105-Q 115/250V 50/60Hz conductor 2 with E connection male faston 6.3mm L 40mm ø 40mm Hmm Wmm M8 plastic Qty 1 pcs		
For models:	015-24L, 050F, 050F-Dep, DSP1, DSP2, DSP4, DSP5, F85, F85-Dep, L20, L21, LP31L, LP6, LP6L, M115, M150, MATIC20, P550, S200, S280, S280Dep, Super-QS, Super-QS-Dep		

fuses

line circuit breakers

miscellaneous



1

Part No.	358146	Ref. No.	0301723
description	line circuit breaker 3-pole 16A tripping type C rated 400V connection screw		
For models:	M150, MATIC20		



1

Part No.	358145	Ref. No.	0301729
description	line circuit breaker 3-pole 32A tripping type C rated 400V connection screw		
For models:	M115		



1

Part No.	358144	Ref. No.	0301730
description	shunt release rated 12-24V Qty 1 pcs		
For models:	M115, M150, MATIC20		



electric accessories

cables

accessories

cable glands

strain reliefs



1

Part No.	506444	Ref. No.	0300193
description	strain relief		
For models:	050F, 050F-Dep, DSP1, DSP2, DSP4, DSP5, F85, F85-Dep, L20, L21, S200, S280, S280Dep, Super-QS, Super-QS-Dep		

terminals

connection boxes



1

Part No.	550671	Ref. No.	0300751
description	power terminal block 6-pole contacts 3P+N+E		
For models:	050F, 050F-Dep, DSP4, DSP5, F85, F85-Dep, L20, L21		

rail-mounted terminals

SIEMENS

feed-through terminals



1

Part No.	551238	Ref. No.	0300405
description	rail-mounted terminal 16mm ² beige 1-pole		
For models:	LP31L, LP6, M115		

equipmentspecific units

for dishwashers

drain and intake components

LAMBER

drain /intake bodies



1

Part No.	517685	Ref. No.	0221333
description	drain connection ø 40mm L 62mm thread 1½"		



1

Part No.	506035	Ref. No.	0200128
description	drain fitting thread 1¼" ID ø 27mm		
For models:	DSP1, DSP2, S200, S280, S280Dep, Super-QS, Super-QS-Dep		



1

Part No.	506026	Ref. No.	0200113
description	drain fitting thread 2"/1¼" ID ø 42mm		
For models:	015-24L, 050F, 050F-Dep, DSP4, DSP5, F85, F85-Dep, L20, L21, P550		
accessories for	506026		



1

Part No.	506043	Ref. No.	0200173
description	flat gasket rubber ED ø 75mm ID ø 58.5mm thickness 2mm Qty 1 pcs		



1

Part No.	506017	Ref. No.	0200078
description	drain fitting with gasket thread 1¼" ID ø 24mm hose ø 32mm		
For models:	015-24L, 050F, 050F-Dep, F85, F85-Dep, L20, L21, P550, S200, S280, S280Dep, Super-QS, Super-QS-Dep		

spare parts for



1

Part No.	512073	Ref. No.	—
description	flat gasket rubber ED ø 31mm ID ø 22mm thickness 2mm Qty 1 pcs		





1

Part No.	506028	Ref. No.	0200115
description	flange ED ø 140mm		





			
1			
Part No.	506072	Ref. No.	0200403
description	flat gasket fibre ED ø 38mm ID ø 27mm thickness 2mm outflow for thread 1¼" Qty 1 pcs		
For models:	015-24L, 050F, 050F-Dep, DSP5, F85, F85-Dep, L20, L21, P550, S200, S280, S280Dep, Super-QS, Super-QS-Dep		



			
1			
Part No.	506121	Ref. No.	0201524 0208153
description	flat gasket rubber ED ø 68mm ID ø 41mm thickness 2mm Qty 1 pcs		
For models:	DSP1, DSP2, L20, L21, S200, S280, S280Dep, Super-QS, Super-QS-Dep		



			
1			
Part No.	506043	Ref. No.	0200173
description	flat gasket rubber ED ø 75mm ID ø 58.5mm thickness 2mm Qty 1 pcs		
For models:	015-24L, 050F, 050F-Dep, DSP4, DSP5, F85, F85-Dep, L20, L21, P550		

			
1			
Part No.	504442	Ref. No.	0201532
description	gasket for intake filter ED ø 140mm ID ø 84mm thickness 2mm hole distance 78mm		

			
1			
Part No.	506022	Ref. No.	0200098
description	gasket with 4 screw holes ED ø 134mm ID ø 65mm thickness 2.5mm		
For models:	DSP4, DSP5		

			
1			
Part No.	506123	Ref. No.	0221305
description	hose connector		

				
1				
Part No.	506122	Ref. No.	0221302	
description	hose connector plastic straight thread 1¼" hose ø 31mm Qty 1 pcs			
For models:	015-24L, DSP5, L20, L21, P550			
accessories for	506122			
	Part No.	506072	Ref. No.	0200403
	flat gasket fibre ED ø 38mm ID ø 27mm thickness 2mm outflow for thread 1¼" Qty 1 pcs			
	Part No.	506074	Ref. No.	0200521
	drain hose ID ø 32mm ED ø 41mm L 1m wire reinforced			



				
1				
Part No.	506129	Ref. No.	0221331	
description	hose connector thread 1½" hose ø 40mm			
For models:	050F, 050F-Dep, F85, F85-Dep			
accessories for	506129			
	Part No.	506015	Ref. No.	0200056
	O-ring EPDM thickness 3.53mm ID ø 39.69mm Qty 1 pcs			
	Part No.	506016	Ref. No.	0200058
	quick-fit retaining nut thread 1½"			

			
1			
Part No.	506096	Ref. No.	0201470
description	intake body		

			
1			
Part No.	506030	Ref. No.	0200118
description	intake body ED ø 110mm thread 1¼"		
For models:	DSP5, M115, M150, MATIC20		

			
1			
Part No.	506029	Ref. No.	0200116
description	intake body ED ø 140mm		
For models:	DSP4, DSP5		





			
1			
Part No.	506034	Ref. No.	0200127
description	intake body thread 1 1/4" ID ø 25mm		
For models:	DSP1, DSP2, L20, L21, S200, S280, S280Dep, Super-QS, Super-QS-Dep		
accessories for	506034		
	Part No.	506018	Ref. No. 0200080
	nut thread 1 1/4"		
	Part No.	506121	Ref. No. 0201524 0208153
	flat gasket rubber ED ø 68mm ID ø 41mm thickness 2mm Qty 1 pcs		

			
1			
Part No.	506018	Ref. No.	0200080
description	nut thread 1 1/4"		
For models:	015-24L, 050F, 050F-Dep, DSP1, DSP2, DSP4, DSP5, F85, F85-Dep, L20, L21, P550, S200, S280, S280Dep, Super-QS, Super-QS-Dep		

			
1			
Part No.	506027	Ref. No.	0200114
description	nut thread 2" for intake body		
For models:	015-24L, 050F, 050F-Dep, DSP4, DSP5, F85, F85-Dep, L20, L21, P550		

			
1			
Part No.	506015	Ref. No.	0200056
description	O-ring EPDM thickness 3.53mm ID ø 39.69mm Qty 1 pcs		
For models:	015-24L, 050F, 050F-Dep, DSP1, DSP2, DSP4, DSP5, F85, L20, L21, P550, S200, S280, S280Dep, Super-QS, Super-QS-Dep		

			
1			
Part No.	532547	Ref. No.	0203009
description	O-ring EPDM thickness 3.53mm ID ø 44.45mm Qty 1 pcs		
For models:	050F, 050F-Dep, F85, F85-Dep		

			
1			
Part No.	528315	Ref. No.	0800074
description	O-ring EPDM thickness 3.53mm ID ø 47.63mm Qty 1 pcs		

			
1			
Part No.	506016	Ref. No.	0200058
description	quick-fit retaining nut thread 1 1/2"		
For models:	050F, 050F-Dep, F85, F85-Dep, LP31L, LP6, LP6L, M115, M150, MATIC20		

filters			
			
1			
Part No.	517675	Ref. No.	0202015
description	filter for dishwasher L 122mm W 122mm H 100mm SS		

			
1			
Part No.	517676	Ref. No.	0202000
description	filter for dishwasher L 200mm W 155mm H 120mm SS		

			
1			
Part No.	517674	Ref. No.	0202008
description	filter for dishwasher L 248mm W 248mm H 41mm SS		
For models:	M115, M150		

			
1			
Part No.	517673	Ref. No.	0202034
description	filter for dishwasher L 365mm W 292mm H 17mm SS		

			
1			
Part No.	517672	Ref. No.	0202063
description	filter for dishwasher L 415mm W 203mm H 37mm SS		



1

Part No.	517681	Ref. No.	0202014
description	filter for dishwasher L 608mm W 180mm H 30mm SS		



1

Part No.	517680	Ref. No.	0202013
description	filter for dishwasher L 660mm W 200mm H 62mm SS		
For models:	M150		



1

Part No.	517684	Ref. No.	0200310
description	filter \varnothing 22mm H 93mm SS		
For models:	LP31L, LP6, M115, M150, MATIC20		



1

Part No.	506115	Ref. No.	0202006
description	flat filter		



1

Part No.	506133	Ref. No.	0400151
description	flat filter		
For models:	050F, 050F-Dep, F85, F85-Dep		



1

Part No.	506410	Ref. No.	0202005
description	flat filter L 270mm W 165mm		



1

Part No.	506134	Ref. No.	0400152
description	flat filter L 320mm W 235mm		
For models:	015-24L, DSP5, L21, P550		

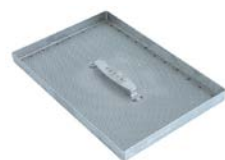

1

Part No.	506135	Ref. No.	0400153
description	flat filter L 322mm W 216mm		



1

Part No.	517683	Ref. No.	0202055
description	rectangular filter L 140mm W 60mm H 86mm plastic		



1

Part No.	506056	Ref. No.	0200247
description	round filters \varnothing 100mm		
For models:	DSP1, DSP2, S200, S280, S280Dep, Super-QS, Super-QS-Dep		



1

Part No.	506422	Ref. No.	0202003
description	round filters \varnothing 101mm connection \varnothing 48x55mm for pump suitable for L25/S		

1

Part No.	517677	Ref. No.	0202065
description	round filters ø 145mm H 90mm overall height 130mm SS		



1

Part No.	506009	Ref. No.	0200024
description	round filters ø 165mm H 50mm		
For models:	L20, L21		



1

Part No.	506119	Ref. No.	0202209
description	round filters ø 185mm H 80mm		
For models:	015-24L, M115, M150, MATIC20, P550		



1

Part No.	506010	Ref. No.	0200025
description	round filters ø 215mm		
For models:	050F, 050F-Dep, DSP4, DSP5, F85, F85-Dep		

overflow pipes



1

Part No.	517662	Ref. No.	0800903
description	cover ø 80mm ID ø 55mm H 25mm for overflow pipe		
For models:	LP31L, LP6, LP6L, M115, M150, MATIC20		



1

Part No.	517663	Ref. No.	0500801
description	knob ø 35.5mm thread M8 H 23.5mm for overflow pipe		
For models:	LP31L, LP6, LP6L, M115, M150, MATIC20		



1

Part No.	506007	Ref. No.	0200020
description	overflow pipe L 125mm ø 28mm		
For models:	DSP1, DSP2, S200, S280, S280Dep, Super-QS, Super-QS-Dep		



1

Part No.	506047	Ref. No.	0200180
description	overflow pipe L 140mm ø 45mm		
For models:	050F, 050F-Dep, DSP4, DSP5, F85, F85-Dep		



1

Part No.	524259	Ref. No.	0204007
description	overflow pipe L 180mm ø 28mm		



1

Part No.	517668	Ref. No.	0200021
description	overflow pipe L 200mm ø 45mm		



1

Part No.	506008	Ref. No.	0200022
description	overflow pipe L 226mm ø 45mm		
For models:	L20, L21		



			
1			
Part No.	506416	Ref. No.	0200023
description	overflow pipe L 320mm ø 45mm		

			
1			
Part No.	506120	Ref. No.	0204003
description	overflow pipe L 366mm ø 45mm usable height 340mm		
For models:	015-24L, P550		

			
1			
Part No.	524784	Ref. No.	0204006
description	overflow pipe L 405mm ø 45mm plastic ID ø 38mm		

			
1			
Part No.	517664	Ref. No.	0204004
description	overflow pipe L 430mm ø 45mm		

			
1			
Part No.	517665	Ref. No.	0204002
description	overflow pipe L 575mm ø 45mm SS ID ø 33mm		
For models:	LP6, LP6L		

containers

dosing containers

			
1			
Part No.	506432	Ref. No.	0520003
description	rinse aid container 0.25l		

salt tanks

			
1			
Part No.	510929	Ref. No.	0200149
description	salt tank ø 120mm H 117mm hose ø 10mm mounting ø 70mm overall height 157mm		
For models:	050F, 050F-Dep, F85, F85-Dep, S280, S280Dep, Super-QS, Super-QS-Dep		
spare parts for	510929		
	Part No.	506015	Ref. No. 0200056
	O-ring EPDM thickness 3.53mm ID ø 39.69mm Qty 1 pcs		
	Part No.	510018	Ref. No. —
	nut ø 92mm H 10.5mm for salt tank ID ø 64mm		
	Part No.	524177	Ref. No. —
	lid ø 69mm H 20mm for salt tank ID ø 50mm		
accessories for	510929		
	Part No.	510071	Ref. No. —
	flat gasket rubber ED ø 81mm ID ø 68mm thickness 3mm for salt tank Qty 1 pcs		
	Part No.	510654	Ref. No. —
	gasket H 6mm D1 ø 82mm D2 ø 68mm		
	Part No.	510883	Ref. No. —
	gasket rubber ED ø 86mm ID ø 66mm thickness 2mm for salt tank Qty 1 pcs		



boilers

boilers for dishwashers



1			
Part No.	506142	Ref. No.	0400268
description	boiler		
For models:	S200, S280, S280Dep, Super-QS, Super-QS-Dep		



1			
Part No.	506136	Ref. No.	0400259 siehe Bemerkung
description	boiler capacity 3l		



1			
Part No.	506137	Ref. No.	0400260 siehe Bemerkung
description	boiler capacity 4l		



1			
Part No.	506139	Ref. No.	0400262
description	boiler capacity 5l		
For models:	050F, 050F-Dep, F85, F85-Dep		



1			
Part No.	506262	Ref. No.	0400261
description	boiler capacity 8l		
For models:	015-24L, L20, L21, LP6, LP6L, P550		



1			
Part No.	517679	Ref. No.	400266 400266+1x200324+6x300079+1x403012
description	boiler with insulation ø 220mm L 540mm		

rotation plates

rotation plates



1			
Part No.	506442	Ref. No.	0800027
description	rotation plate for model A81		

softener cartridges

softening columns



1			
Part No.	530000	Ref. No.	0200011
description	softener 4-fold L 380mm W 180mm		
For models:	050F, 050F-Dep, F85, F85-Dep, S280, S280Dep, Super-QS, Super-QS-Dep		



housing and bezels

fastening angles



1

Part No.	504437	Ref. No.	0406127
description	fastening angle for valve SS L 85mm W 65mm thickness 1mm H 20mm		
For models:	015-24L, DSP5, L21		

hood mechanics for dishwashers

bolts



1

Part No.	506171	Ref. No.	0800117
description	screw bolt for grab handle hood mechanics		
For models:	015-24L, DSP5, L21		



1

Part No.	506206	Ref. No.	0899999
description	screw bolt for grab handle hood mechanics		
For models:	015-24L		

bushes



1

Part No.	506190	Ref. No.	0800497
description	bush for grab handle hood mechanics		
For models:	015-24L, DSP5, L21		



1

Part No.	506188	Ref. No.	0800418
description	bush for roller hood mechanics		
For models:	015-24L, DSP5, L21		



1

Part No.	506211	Ref. No.	0800108
description	bush hood mechanics		
For models:	015-24L, DSP5, L20, L21		



1

Part No.	506212	Ref. No.	0800109
description	spacer bush hood mechanics		
For models:	015-24L, DSP5, L20, L21		



1

Part No.	506213	Ref. No.	0800110
description	spacer bush hood mechanics		
For models:	015-24L, DSP5, L20, L21		

guide bars



1

Part No.	506436	Ref. No.	0800116
description	guide bar L 1115mm ø 31.5mm		
For models:	DSP5, L20, L21		

linkage



1

Part No.	506426	Ref. No.	0800701
description	linkage L 602mm hood mechanics for dishwasher		
For models:	DSP5		



1

Part No.	506228	Ref. No.	0800702
description	linkage L 635mm hood mechanics for dishwasher		
For models:	015-24L		

accessories for 506228



Part No.	560475	Ref. No.	0800144
description	hexagonal nut thread M10 H 11.5mm zinc-coated steel WS 17 Qty 1 pcs DIN/ISO DIN 982		



hood handles



1

Part No.	506176	Ref. No.	0800241
description	hood handle		
For models:	DSP5, L20, L21		

rollers



1

Part No.	506163	Ref. No.	0800048
description	roller hood mechanics dimensions 23/9.4/8mm		
For models:	015-24L, DSP5, L20, L21, M115, M150, MATIC20		



1

Part No.	506178	Ref. No.	0800244
description	roller hood mechanics dimensions 35x12mm PVC		
For models:	015-24L, DSP5, L21		

miscellaneous



1

Part No.	506023	Ref. No.	0200099
description	gasket hood mechanics thread M8		
For models:	015-24L, 050F, 050F-Dep, DSP4, DSP5, F85, F85-Dep, L20, L21, LP31L, LP6, LP6L, M115, M150, MATIC20, P550		



1

Part No.	506170	Ref. No.	0800115
description	hinge pin hood mechanics		
For models:	015-24L, DSP5, L20, L21		



1

Part No.	524791	Ref. No.	0200650
description	plate for hood mechanics L 39mm thread M10 zinc-coated steel H 10mm W 21mm		
For models:	015-24L, DSP5, L20, L21		



1

Part No.	506159	Ref. No.	0150007 0800020 GA0150007
description	rod guide hood mechanics with rollers		
For models:	015-24L, DSP5, L20, L21		



1

Part No.	506177	Ref. No.	0800242
description	spacer piece hood mechanics		
For models:	015-24L		



1

Part No.	506189	Ref. No.	0800420
description	spacer piece hood mechanics L 18mm thread M16		
For models:	015-24L, DSP5, L21		



basket guides

guide bars



1

Part No.	506439	Ref. No.	0400156
description	guide bar for warewashing basket mounting pos. left		
For models:	050F, 050F-Dep, F85, F85-Dep		



1

Part No.	506438	Ref. No.	0400157
description	guide bar for warewashing basket mounting pos. right		
For models:	050F, 050F-Dep, F85, F85-Dep		

basket holders



1

Part No.	971148	Ref. No.	0400360 siehe Bemerkung
description	basket support for dishwasher L 580m W 510mm H 75mm		
For models:	015-24L		
accessories for	971148		
	Part No.	971151	Ref. No. 0400370 0400370 (KIT)
	mixer coupling L 450mm H 75mm		

miscellaneous



1

Part No.	512078	Ref. No.	0800094
description	guide for dishwasher L 99mm W 45mm H 31.5mm		
For models:	M115, M150, MATIC20		



1

Part No.	971151	Ref. No.	0400370 0400370 (KIT)
description	mixer coupling L 450mm H 75mm		
For models:	015-24L, DSP5, L20, L21		





air traps

air traps



1

Part No.	506221	Ref. No.	0201455 0201455+0200196+0800652
description	air trap L 40mm W 40mm H 85mm thread M12x1.75 ABS plastic		
For models:	015-24L, 050F, 050F-Dep, DSP1, DSP5, F85, F85-Dep, L20, L21, LP31L, LP6, LP6L, M115, M150, MATIC20, P550, S200, S280, S280Dep, Super-QS, Super-QS-Dep		

accessories for	506221		
	Part No.	506063	Ref. No. 0200295
	gasket suitable for Lamber equiv. no. 0200295 air trap ED ø 15.5mm ID ø 11.5mm Nyltite		
	Part No.	506076	Ref. No. 0200638
	hose connector thread M12x1.75 hose ø 6mm		
	Part No.	506220	Ref. No. 0200196
	gasket ø 4mm H 2.5mm nylon		
	Part No.	560227	Ref. No. 0800652
	hexagonal nut thread M3 H 4mm SS WS 5.5 Qty 1 pcs self-locking		





1

Part No.	506414	Ref. No.	0200019
description	air trap ø 40mm H 100mm hose ø 10mm plastic		
For models:	DSP2, DSP4		





air trap accessories

			
1			
Part No.	506429	Ref. No.	0200289
description	gasket for air trap		
For models:	DSP2, DSP4		

			
1			
Part No.	506220	Ref. No.	0200196
description	gasket ø 4mm H 2.5mm nylon		
For models:	015-24L, 050F, 050F-Dep, DSP1, DSP5, F85, F85-Dep, L20, L21, LP31L, LP6, LP6L, S200, S280, S280Dep, Super-QS, Super-QS-Dep		

			
1			
Part No.	506431	Ref. No.	0200200
description	hose ED ø 10/15mm ID ø 4/10mm L 2200mm temp.-resist. 70°C for air trap		
For models:	015-24L, DSP2, DSP4, L20, L21, LP31L, LP6, LP6L		

			
1			
Part No.	506040	Ref. No.	0200147
description	hose connector ø 4mm thread M12		
For models:	050F, 050F-Dep, DSP1, DSP5, F85, F85-Dep, S200, S280, S280Dep, Super-QS, Super-QS-Dep		

			
1			
Part No.	506076	Ref. No.	0200638
description	hose connector thread M12x1.75 hose ø 6mm		
For models:	M115, M150, MATIC20, P550		

mechanics for flight type dishwashers



			
1			
Part No.	524826	Ref. No.	0802051
description	bush for ratchet L 21mm ID ø 8mm ED ø 10mm suitable for Lamber		
For models:	M115, M150, MATIC20		

			
1			
Part No.	524789	Ref. No.	0800492
description	cable clamp wire gauge ø 5mm SS		
For models:	M115, M150, MATIC20		

			
1			
Part No.	504436	Ref. No.	0800407
description	coupling for transport system L 55mm ø 70mm ID ø 19mm suitable for Lamber		
For models:	M115, M150, MATIC20		

			
1			
Part No.	524790	Ref. No.	0802048
description	distance washers for drive shaft H 10mm ID ø 12.4mm ED ø 22mm		
For models:	M115, M150, MATIC20		

			
1			
Part No.	529272	Ref. No.	0800123 0800150
description	drive shaft for transport system		
For models:	M115, M150, MATIC20		
accessories for	529272		

			
	Part No.	532144	Ref. No.
			—
	O-ring EPDM thickness 3.53mm ID ø 98.02mm Qty 10 pcs		
			
	Part No.	694970	Ref. No.
			0802707
	gear wheel H 28mm ID ø 64mm ED ø 85mm hole ø 20mm		

			
1			
Part No.	694970	Ref. No.	0802707
description	gear wheel H 28mm ID ø 64mm ED ø 85mm hole ø 20mm		
For models:	M115, M150		

			
1			
Part No.	524787	Ref. No.	0802046
description	thread bolt for drive shaft L 62mm ø 12mm suitable for Lamber thread M8x1.25		
For models:	M115, M150, MATIC20		



backflow preventers

backflow preventers



1

Part No.	506210	Ref. No.	0500602
-----------------	--------	-----------------	---------

description	backflow preventer dishwasher		
--------------------	-------------------------------	--	--



1

Part No.	516101	Ref. No.	0500605
-----------------	--------	-----------------	---------

description	backflow preventer dishwasher hose ø 12mm		
--------------------	---	--	--

For models:	015-24L, 050F, 050F-Dep, DSP5, F85, F85-Dep, L20, L21, LP31L, LP6, LP6L, M115, M150, P550, S200, S280, S280Dep, Super-QS, Super-QS-Dep		
--------------------	--	--	--

spare parts for	516101		
------------------------	--------	--	--



Part No.	506367	Ref. No.	—
description	flat gasket rubber ED ø 40mm ID ø 28mm thickness 1.8mm Qty 1 pcs		

non-return valves



1

Part No.	506073	Ref. No.	0200426
-----------------	--------	-----------------	---------

description	non-return valve plastic total length 26mm hose ø 11mm		
--------------------	--	--	--

For models:	050F, 050F-Dep, F85, F85-Dep, S280, S280Dep, Super-QS, Super-QS-Dep		
--------------------	---	--	--

miscellaneous



1

Part No.	506160	Ref. No.	0800028
-----------------	--------	-----------------	---------

description	plain washer ID ø 8.6mm ED ø 16mm thickness 1.5mm SS Qty 1 pcs		
--------------------	--	--	--

For models:	015-24L, DSP5, L20, L21, LP31L, LP6, LP6L, M115, M150, MATIC20		
--------------------	--	--	--

door mechanics

springs

tension springs



1

Part No.	519494	Ref. No.	0800714
-----------------	--------	-----------------	---------

description	tension spring ø 9mm wire gauge ø 1.5mm total length 168mm for door		
--------------------	---	--	--

For models:	050F, 050F-Dep, F85, F85-Dep		
--------------------	------------------------------	--	--

linkage



1

Part No.	506186	Ref. No.	0800408
-----------------	--------	-----------------	---------

description	door pin L 180mm door pin ø 5mm		
--------------------	---------------------------------	--	--

For models:	DSP1, DSP2, S200, S280, S280Dep, Super-QS, Super-QS-Dep		
--------------------	---	--	--



1

Part No.	506179	Ref. No.	0800400
-----------------	--------	-----------------	---------

description	door pin L 305mm door pin ø 5mm		
--------------------	---------------------------------	--	--

For models:	050F, 050F-Dep, DSP2, DSP4, DSP5, F85, F85-Dep, LP31L, LP6, LP6L, M115, M150, P550, S280, S280Dep, Super-QS, Super-QS-Dep		
--------------------	---	--	--

threaded shafts



1

Part No.	506180	Ref. No.	0800401
-----------------	--------	-----------------	---------

description	threaded part spigot		
--------------------	----------------------	--	--

For models:	050F, 050F-Dep, DSP1, DSP2, DSP4, F85, F85-Dep, S200, S280, S280Dep, Super-QS, Super-QS-Dep		
--------------------	---	--	--

sliding plates



1

Part No.	506182	Ref. No.	0800403 0800403+2x0800187
-----------------	--------	-----------------	------------------------------

description	sliding plate plate		
--------------------	---------------------	--	--

For models:	050F, 050F-Dep, DSP1, DSP2, DSP4, F85, F85-Dep, S200, S280, S280Dep, Super-QS, Super-QS-Dep		
--------------------	---	--	--

hinges



1

Part No.	506167	Ref. No.	0800098
-----------------	--------	-----------------	---------

description	door bolt door bearing		
--------------------	------------------------	--	--





			
1			
Part No.	506168	Ref. No.	0800099
description	door bolt door bearing		
For models:	DSP1, DSP2, DSP4		

			
1			
Part No.	692467	Ref. No.	0800174
description	hinge L 52mm W 57mm H 18mm mounting distance 34mm hole ø 5mm plastic		

rod support			
			
1			
Part No.	506434	Ref. No.	0400190
description	support bracket		

door bumpers			
			
1			
Part No.	506181	Ref. No.	0800402 0800402+0800256+0800653
description	door bumper hinge camp		
For models:	050F, 050F-Dep, DSP1, DSP2, DSP4, DSP5, F85, F85-Dep, P550, S200, S280, S280Dep, Super-QS, Super-QS-Dep		

			
1			
Part No.	506185	Ref. No.	0800406
description	door bumper hinge camp brass		
For models:	LP31L, LP6, LP6L, M115, M150		

locks			
			
1			
Part No.	506157	Ref. No.	0800006
description	door catch catch		
For models:	050F, 050F-Dep, DSP1, DSP2, DSP4, F85, F85-Dep, S200, S280, S280Dep, Super-QS, Super-QS-Dep		

			
1			
Part No.	506183	Ref. No.	0800404 0800404+0800652+0800665
description	door catch counterpart		
For models:	050F, 050F-Dep, DSP1, DSP2, DSP4, F85, F85-Dep, S200, S280, S280Dep, Super-QS, Super-QS-Dep		

			
1			
Part No.	506184	Ref. No.	0800405
description	door catch SS door catch		

miscellaneous			
			
1			
Part No.	506173	Ref. No.	0800169
description	bush for door bolt		
For models:	DSP1, DSP2, DSP4		

			
1			
Part No.	506187	Ref. No.	0800409
description	bush for door bolt		

			
1			
Part No.	524254	Ref. No.	0800480
description	hauling cable for door ø 3mm L 1800mm		
For models:	M115, M150, MATIC20		



screw connections



1

Part No.	506196	Ref. No.	0800673
description	nut brass		
For models:	015-24L, 050F, 050F-Dep, DSP5, F85, F85-Dep, L20, L21, LP31L, LP6, LP6L, P550, S200, S280, S280Dep, Super-QS, Super-QS-Dep		



1

Part No.	506027	Ref. No.	0200114
description	nut thread 2" for intake body		
For models:	015-24L, 050F, 050F-Dep, DSP4, DSP5, F85, F85-Dep, L20, L21, P550		



1

Part No.	506132	Ref. No.	0300047
description	nut thread 3/8"		
For models:	050F, 050F-Dep, F85, F85-Dep, S200, S280, S280Dep, Super-QS, Super-QS-Dep		

washing and rinsing systems



1

Part No.	506012	Ref. No.	0200038
description	bearing rinse arm SS		
For models:	015-24L, 050F, 050F-Dep, DSP1, DSP2, DSP4, DSP5, F85, F85-Dep, L20, L21, P550, S200, S280, S280Dep, Super-QS, Super-QS-Dep		



1

Part No.	506174	Ref. No.	0800175
description	bush for rinse arm mounting pos. lower		
For models:	LP31L, LP6, LP6L		



1

Part No.	506192	Ref. No.	0800499
description	bush for rinse arm ø 13.3mm		
For models:	015-24L, 050F, 050F-Dep, F85, F85-Dep, L20, L21, P550, S200, S280, S280Dep, Super-QS, Super-QS-Dep		



1

Part No.	506191	Ref. No.	0800498
description	bush for rinse arm ø 16.2mm		
For models:	015-24L, 050F, 050F-Dep, F85, F85-Dep, L20, L21, P550, S200, S280, S280Dep, Super-QS, Super-QS-Dep		



1

Part No.	517682	Ref. No.	0200121
description	bush for wash arm mounting pos. upper H 52mm thread 1 1/4" D1 ø 54mm D2 ø 41mm Qty 1 pcs		



1

Part No.	506197	Ref. No.	0800685
description	disc for wash arm ID ø 18mm ED ø 50mm thickness 2mm nylon		



1

Part No.	506198	Ref. No.	0800686
description	disc for wash arm ID ø 50mm ED ø 22mm thickness 2mm nylon		
For models:	015-24L, 050F, 050F-Dep, F85, F85-Dep, L20, L21, P550		



1

Part No.	524264	Ref. No.	0800053
description	disc for wash arm support mounting pos. upper ø 50mm H 2mm		
For models:	DSP4, DSP5		





			
1			
Part No.	506161	Ref. No.	0800030
description	disc SS for wash arm ID ϕ 18.2mm ED ϕ 50mm		

			
1			
Part No.	506094	Ref. No.	0201458
description	flange thread 1 1/4" ϕ 110mm		
For models:	015-24L, 050F, 050F-Dep, F85, F85-Dep, L20, L21, P550		

			
1			
Part No.	524792	Ref. No.	0200259
description	gasket for rinse arm mounting pos. upper/lower ϕ 22.5mm ID ϕ 13mm thickness 10mm		
For models:	M115, M150, MATIC20		

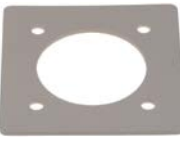
			
1			
Part No.	524786	Ref. No.	0200400
description	gasket for wash arm mounting pos. upper/lower ϕ 46mm ID ϕ 36mm		
For models:	M115, M150, MATIC20		

			
1			
Part No.	524258	Ref. No.	0201504
description	gasket suitable for Lamber for wash arm support L 100mm W 100mm Qty 1m ID ϕ 61mm		
For models:	LP31L, LP6, LP6L		

			
1			
Part No.	504440	Ref. No.	0201505
description	gasket suitable for Lamber L 100mm W 100mm ID ϕ 43mm thickness 3mm		
For models:	M115, M150, MATIC20		

			
1			
Part No.	504441	Ref. No.	0201503
description	gasket suitable for Lamber L 100mm W 100mm Qty 1m ID ϕ 40mm thickness 3mm		
For models:	M115, M150, MATIC20		

			
1			
Part No.	506128	Ref. No.	0221315
description	hose connector curved plastic		

			
1			
Part No.	506127	Ref. No.	0221314
description	hose connector thread 1 1/4" for hose ID 30mm curved plastic		
For models:	DSP4, MATIC20		

			
1			
Part No.	506101	Ref. No.	0201820
description	rinse arm support mounting pos. lower		
For models:	050F, 050F-Dep, F85, F85-Dep		

			
1			
Part No.	506103	Ref. No.	0201830
description	rinse arm support mounting pos. lower		

			
1			
Part No.	506020	Ref. No.	0200096
description	rinse pipe		
For models:	DSP1, DSP2, DSP4, DSP5, S200, S280, S280Dep, Super-QS, Super-QS-Dep		





			
1			
Part No.	506104	Ref. No.	0201836
description	rinse pipe		
For models:	015-24L, L20, L21		

			
1			
Part No.	506437	Ref. No.	0201335
description	rinse pipe		

			
1			
Part No.	506200	Ref. No.	0800712
description	spring SS for rinse pipe		
For models:	015-24L, 050F, 050F-Dep, F85, F85-Dep, L20, L21, P550, S200, S280, S280Dep, Super-QS, Super-QS-Dep		

			
1			
Part No.	506172	Ref. No.	0800130
description	Thumb screw thread M6 thread L 9mm ø 22mm H 6mm SS		
For models:	015-24L, 050F, 050F-Dep, F85, F85-Dep, L20, L21, LP31L, LP6, LP6L, P550, S200, S280, S280Dep, Super-QS, Super-QS-Dep		

			
1			
Part No.	510338	Ref. No.	0200219
description	union nut dosing pump thread 1/2" ø 32mm H 15mm for dosing pump		

			
1			
Part No.	506102	Ref. No.	0201822
description	wash arm support mounting pos. lower		

			
1			
Part No.	506421	Ref. No.	0800043
description	wash pipe L 200mm nylon size inch 1¼~		
For models:	M150		

washing and rinsing systems (sorted by producer)

LAMBER

			
1			
Part No.	506267	Ref. No.	0200861
description	rinse arm L 372mm mounting pos. upper nozzles 4 mounting ø 16mm		

			
1			
Part No.	506265	Ref. No.	0200808 0200855
description	rinse arm L 376mm mounting pos. lower nozzles 4		
For models:	DSP2		

			
1			
Part No.	506261	Ref. No.	0200804 0200807 0200852
description	rinse arm L 420mm mounting pos. upper nozzles 4 thread M18x1		
For models:	015-24L, 050F, 050F-Dep, F85, F85-Dep, L20, L21, P550		

1

Part No.	517830	Ref. No.	0200850
description	rinse arm L 480mm mounting pos. lower nozzles 6		



1

Part No.	506276	Ref. No.	0200859
description	rinse arm L 620mm nozzles 6 mounting ø uppermm		





1

Part No.	517667	Ref. No.	0500515
description	wash arm L 380mm mounting pos. upper/lower nozzles 6		
For models:	M115, M150, MATIC20		



1

Part No.	506155	Ref. No.	0500502 0500505
description	wash arm L 383mm mounting pos. upper nozzles 6 mounting ø 43.5mm		
For models:	050F, 050F-Dep, DSP1, DSP2, DSP4, DSP5, F85, F85-Dep, L20, L21, S200, S280, S280Dep, Super-QS, Super-QS-Dep		
accessories for	506155		
	Part No.	506164	Ref. No. 0200222 0800052
	flat gasket PTFE ED ø 57mm ID ø 41mm thickness 2mm Qty 1 pcs		



1

Part No.	506153	Ref. No.	0500500
description	wash arm L 545mm mounting pos. lower nozzles 6 mounting ø 43mm		
For models:	050F, 050F-Dep, DSP4, DSP5, F85, F85-Dep, L20, L21, P550		



1

Part No.	524783	Ref. No.	0500510
description	wash arm L 550/600mm mounting pos. upper/lower nozzles 8 complete		
For models:	LP31L, LP6, LP6L		



1



Part No.	524782	Ref. No.	0500516
description	wash arm L 550mm mounting pos. upper/lower nozzles 6 complete		





1

Part No.	506154	Ref. No.	0200094 0500501
description	wash arm L 550mm mounting pos. upper/lower nozzles 8 mounting ø 43mm		
For models:	015-24L		







			
1			
Part No.	506061	Ref. No.	0200286 0200287
description	rinse arm L 470mm nozzles 6 mounting ø 17mm mounting pos. lower complete		
For models:	015-24L, 050F, 050F-Dep, F85, F85-Dep, L20, L21, P550		
accessories for	506061		
	Part No.	506012	Ref. No. 0200038
	bearing rinse arm SS		

			
1			
Part No.	505045	Ref. No.	0200303
description	O-ring EPDM thickness 1.78mm ID ø 5.28mm Qty 1 pcs		
For models:	015-24L, 050F, 050F-Dep, F85, F85-Dep, L20, L21, LP31L, LP6, LP6L, M115, M150, MATIC20, P550, S200, S280, S280Dep, Super-QS, Super-QS-Dep		

			
1			
Part No.	506001	Ref. No.	0200012
description	rinse arm L 235mm nozzles 3 thread M12x1 mounting pos. lower		
For models:	015-24L, 050F, 050F-Dep, F85, F85-Dep, L20, L21, P550		

			
1			
Part No.	506002	Ref. No.	0200013
description	rinse arm L 235mm nozzles 3 thread M12x1 mounting pos. lower		
For models:	015-24L, 050F, 050F-Dep, F85, F85-Dep, L20, L21, P550		

			
1			
Part No.	506019	Ref. No.	0200086
description	rinse arm boss		
For models:	015-24L, 050F, 050F-Dep, DSP1, DSP2, DSP4, DSP5, F85, F85-Dep, L20, L21, P550, S200, S280, S280Dep, Super-QS, Super-QS-Dep		

			
1			
Part No.	506089	Ref. No.	0201164
description	rinse jet		
For models:	015-24L, 050F, 050F-Dep, F85, F85-Dep, L20, L21, P550, S200, S280, S280Dep, Super-QS, Super-QS-Dep		
accessories for	506089		
	Part No.	505045	Ref. No. 0200303
	O-ring EPDM thickness 1.78mm ID ø 5.28mm Qty 1 pcs		
	Part No.	524788	Ref. No. 0200625
	union nut for rinse jet mounting pos. upper/lower thread M12x1 H 10mm WS 14		

			
1			
Part No.	506090	Ref. No.	0201165
description	rinse jet ø 1.5mm approval NSF		
For models:	015-24L, 050F, 050F-Dep, F85, F85-Dep, L20, L21, P550, S200, S280, S280Dep, Super-QS, Super-QS-Dep		

			
1			
Part No.	505045	Ref. No.	0200303
description	O-ring EPDM thickness 1.78mm ID ø 5.28mm Qty 1 pcs		
For models:	015-24L, 050F, 050F-Dep, F85, F85-Dep, L20, L21, LP31L, LP6, LP6L, M115, M150, MATIC20, P550, S200, S280, S280Dep, Super-QS, Super-QS-Dep		



			
1			
Part No.	506067	Ref. No.	0200370
description	rinse arm L 200mm nozzles 2 thread M12x1 mounting pos. upper		
For models:	015-24L, 050F, 050F-Dep, F85, F85-Dep, L20, L21, P550		

			
1			
Part No.	506068	Ref. No.	0200371
description	rinse arm L 200mm nozzles 2 thread M12x1 mounting pos. upper		
For models:	015-24L, 050F, 050F-Dep, F85, F85-Dep, L20, L21, P550		

			
1			
Part No.	506019	Ref. No.	0200086
description	rinse arm boss		
For models:	015-24L, 050F, 050F-Dep, DSP1, DSP2, DSP4, DSP5, F85, F85-Dep, L20, L21, P550, S200, S280, S280Dep, Super-QS, Super-QS-Dep		





			
1			
Part No.	506088	Ref. No.	0201151
description	rinse arm boss		
For models:	015-24L, 050F, 050F-Dep, F85, F85-Dep, L20, L21, P550, S200, S280, S280Dep, Super-QS, Super-QS-Dep		

			
1			
Part No.	506089	Ref. No.	0201164
description	rinse jet		
For models:	015-24L, 050F, 050F-Dep, F85, F85-Dep, L20, L21, P550, S200, S280, S280Dep, Super-QS, Super-QS-Dep		
accessories for	506089		
	Part No.	505045	Ref. No. 0200303
	 O-ring EPDM thickness 1.78mm ID ø 5.28mm Qty 1 pcs		
	Part No.	524788	Ref. No. 0200625
	 union nut for rinse jet mounting pos. upper/lower thread M12x1 H 10mm WS 14		

			
1			
Part No.	506090	Ref. No.	0201165
description	rinse jet ø 1.5mm approval NSF		
For models:	015-24L, 050F, 050F-Dep, F85, F85-Dep, L20, L21, P550, S200, S280, S280Dep, Super-QS, Super-QS-Dep		

			
1			
Part No.	506215	Ref. No.	0200806
description	rinse arm L 322mm nozzles 4 mounting ø 16mm mounting pos. upper		
For models:	S200, S280, S280Dep, Super-QS, Super-QS-Dep		

			
1			
Part No.	506077	Ref. No.	0200801
description	rinse arm L 325mm nozzles 4 mounting ø 17mm mounting pos. lower		
For models:	S200		

			
1			
Part No.	505045	Ref. No.	0200303
description	O-ring EPDM thickness 1.78mm ID ø 5.28mm Qty 1 pcs		
For models:	015-24L, 050F, 050F-Dep, F85, F85-Dep, L20, L21, LP31L, LP6, LP6L, M115, M150, MATIC20, P550, S200, S280, S280Dep, Super-QS, Super-QS-Dep		

			
1			
Part No.	506003	Ref. No.	0200016
description	rinse arm L 150mm nozzles 2 thread M12x1 mounting pos. upper/lower		
For models:	S200, S280, S280Dep, Super-QS, Super-QS-Dep		

			
1			
Part No.	506004	Ref. No.	0200017
description	rinse arm L 150mm nozzles 2 thread M12x1 mounting pos. upper/lower		
For models:	S200, S280, S280Dep, Super-QS, Super-QS-Dep		

			
1			
Part No.	506019	Ref. No.	0200086
description	rinse arm boss		
For models:	015-24L, 050F, 050F-Dep, DSP1, DSP2, DSP4, DSP5, F85, F85-Dep, L20, L21, P550, S200, S280, S280Dep, Super-QS, Super-QS-Dep		





			
1			
Part No.	506088	Ref. No.	0201151
description	rinse arm boss		
For models:	015-24L, 050F, 050F-Dep, F85, F85-Dep, L20, L21, P550, S200, S280, S280Dep, Super-QS, Super-QS-Dep		

			
1			
Part No.	506089	Ref. No.	0201164
description	rinse jet		
For models:	015-24L, 050F, 050F-Dep, F85, F85-Dep, L20, L21, P550, S200, S280, S280Dep, Super-QS, Super-QS-Dep		
accessories for	506089		
	Part No.	505045	Ref. No. 0200303
	O-ring EPDM thickness 1.78mm ID ø 5.28mm Qty 1 pcs		
	Part No.	524788	Ref. No. 0200625
	union nut for rinse jet mounting pos. upper/lower thread M12x1 H 10mm WS 14		

			
1			
Part No.	506090	Ref. No.	0201165
description	rinse jet ø 1.5mm approval NSF		
For models:	015-24L, 050F, 050F-Dep, F85, F85-Dep, L20, L21, P550, S200, S280, S280Dep, Super-QS, Super-QS-Dep		

			
1			
Part No.	505045	Ref. No.	0200303
description	O-ring EPDM thickness 1.78mm ID ø 5.28mm Qty 1 pcs		
For models:	015-24L, 050F, 050F-Dep, F85, F85-Dep, L20, L21, LP31L, LP6, LP6L, M115, M150, MATIC20, P550, S200, S280, S280Dep, Super-QS, Super-QS-Dep		

			
1			
Part No.	506069	Ref. No.	0200372
description	rinse arm L 295mm nozzles 3 thread M12x1 mounting pos. upper/lower		
For models:	LP31L, LP6, LP6L		

			
1			
Part No.	506070	Ref. No.	0200373
description	rinse arm L 295mm nozzles 3 thread M12x1 mounting pos. upper/lower		
For models:	LP31L, LP6, LP6L		

			
1			
Part No.	517658	Ref. No.	0201172
description	rinse jet mounting pos. upper/lower ø 1.2mm H 19mm SS		
For models:	LP31L, LP6, LP6L, M115, M150, MATIC20		

			
1			
Part No.	524788	Ref. No.	0200625
description	union nut for rinse jet mounting pos. upper/lower thread M12x1 H 10mm WS 14		
For models:	015-24L, 050F, 050F-Dep, F85, F85-Dep, L20, L21, LP31L, LP6, LP6L, M115, M150, MATIC20, S200, S280, S280Dep, Super-QS, Super-QS-Dep		

			
1			
Part No.	506080	Ref. No.	0200805
description	rinse arm L 472mm nozzles 6 mounting ø 16mm mounting pos. upper complete		

			
1			
Part No.	505045	Ref. No.	0200303
description	O-ring EPDM thickness 1.78mm ID ø 5.28mm Qty 1 pcs		
For models:	015-24L, 050F, 050F-Dep, F85, F85-Dep, L20, L21, LP31L, LP6, LP6L, M115, M150, MATIC20, P550, S200, S280, S280Dep, Super-QS, Super-QS-Dep		

			
1			
Part No.	506001	Ref. No.	0200012
description	rinse arm L 235mm nozzles 3 thread M12x1 mounting pos. lower		
For models:	015-24L, 050F, 050F-Dep, F85, F85-Dep, L20, L21, P550		

			
1			
Part No.	506002	Ref. No.	0200013
description	rinse arm L 235mm nozzles 3 thread M12x1 mounting pos. lower		
For models:	015-24L, 050F, 050F-Dep, F85, F85-Dep, L20, L21, P550		





			
1			
Part No.	506088	Ref. No.	0201151
description	rinse arm boss		
For models:	015-24L, 050F, 050F-Dep, F85, F85-Dep, L20, L21, P550, S200, S280, S280Dep, Super-QS, Super-QS-Dep		

			
1			
Part No.	517658	Ref. No.	0201172
description	rinse jet mounting pos. upper/lower ø 1.2mm H 19mm SS		
For models:	LP31L, LP6, LP6L, M115, M150, MATIC20		

			
1			
Part No.	524788	Ref. No.	0200625
description	union nut for rinse jet mounting pos. upper/lower thread M12x1 H 10mm WS 14		
For models:	015-24L, 050F, 050F-Dep, F85, F85-Dep, L20, L21, LP31L, LP6, LP6L, M115, M150, MATIC20, S200, S280, S280Dep, Super-QS, Super-QS-Dep		

			
1			
Part No.	517656	Ref. No.	0201844
description	rinse arm mounting pos. upper/lower L 500mm nozzles 4 stationary thread M12x1		
For models:	M115, M150		

			
1			
Part No.	524781	Ref. No.	0200376
description	rinse arm mounting pos. upper/lower L 590mm nozzles 5 stationary thread M12x1		

			
1			
Part No.	505045	Ref. No.	0200303
description	O-ring EPDM thickness 1.78mm ID ø 5.28mm Qty 1 pcs		
For models:	015-24L, 050F, 050F-Dep, F85, F85-Dep, L20, L21, LP31L, LP6, LP6L, M115, M150, MATIC20, P550, S200, S280, S280Dep, Super-QS, Super-QS-Dep		

			
1			
Part No.	517658	Ref. No.	0201172
description	rinse jet mounting pos. upper/lower ø 1.2mm H 19mm SS		
For models:	LP31L, LP6, LP6L, M115, M150, MATIC20		

			
1			
Part No.	506233	Ref. No.	0201171
description	rinse jet mounting pos. upper/lower ø 1.5mm H 20mm SS		
For models:	015-24L, 050F, 050F-Dep, F85, F85-Dep, L20, L21, MATIC20, S200, S280, S280Dep, Super-QS, Super-QS-Dep		

			
1			
Part No.	506234	Ref. No.	0201170
description	rinse jet mounting pos. upper/lower ø 1.8mm H 20mm SS		

			
1			
Part No.	524788	Ref. No.	0200625
description	union nut for rinse jet mounting pos. upper/lower thread M12x1 H 10mm WS 14		
For models:	015-24L, 050F, 050F-Dep, F85, F85-Dep, L20, L21, LP31L, LP6, LP6L, M115, M150, MATIC20, S200, S280, S280Dep, Super-QS, Super-QS-Dep		



			
1			
Part No.	505045	Ref. No.	0200303
description	O-ring EPDM thickness 1.78mm ID ø 5.28mm Qty 1 pcs		
For models:	015-24L, 050F, 050F-Dep, F85, F85-Dep, L20, L21, LP31L, LP6, LP6L, M115, M150, MATIC20, P550, S200, S280, S280Dep, Super-QS, Super-QS-Dep		

			
1			
Part No.	506005	Ref. No.	0200014
description	rinse arm L 175mm nozzles 2 thread M12x1 mounting pos. upper/lower		
For models:	S280, S280Dep, Super-QS, Super-QS-Dep		

			
1			
Part No.	506006	Ref. No.	0200015
description	rinse arm L 175mm nozzles 2 thread M12x1 mounting pos. upper/lower		
For models:	S280, S280Dep, Super-QS, Super-QS-Dep		





			
1			
Part No.	506088	Ref. No.	0201151
description	rinse arm boss		
For models:	015-24L, 050F, 050F-Dep, F85, F85-Dep, L20, L21, P550, S200, S280, S280Dep, Super-QS, Super-QS-Dep		

			
1			
Part No.	506089	Ref. No.	0201164
description	rinse jet		
For models:	015-24L, 050F, 050F-Dep, F85, F85-Dep, L20, L21, P550, S200, S280, S280Dep, Super-QS, Super-QS-Dep		
accessories for	506089		
	Part No.	505045	Ref. No.
			0200303
	O-ring EPDM thickness 1.78mm ID ø 5.28mm Qty 1 pcs		
	Part No.	524788	Ref. No.
			0200625
	union nut for rinse jet mounting pos. upper/lower thread M12x1 H 10mm WS 14		

			
1			
Part No.	506090	Ref. No.	0201165
description	rinse jet ø 1.5mm approval NSF		
For models:	015-24L, 050F, 050F-Dep, F85, F85-Dep, L20, L21, P550, S200, S280, S280Dep, Super-QS, Super-QS-Dep		

			
1			
Part No.	517660	Ref. No.	0200815
description	rinse arm mounting pos. lower nozzles 5		
For models:	DSP4		

			
1			
Part No.	506019	Ref. No.	0200086
description	rinse arm boss		
For models:	015-24L, 050F, 050F-Dep, DSP1, DSP2, DSP4, DSP5, F85, F85-Dep, L20, L21, P550, S200, S280, S280Dep, Super-QS, Super-QS-Dep		

			
1			
Part No.	506049	Ref. No.	0200186
description	rinse jet thread 1/8" hole ø 0.9mm		
For models:	DSP1, DSP2, DSP4, DSP5		





			
1			
Part No.	506050	Ref. No.	0200187
description	rinse jet thread 1/8" hole ø 1.8mm		
For models:	DSP1, DSP2, DSP4, DSP5		

			
1			
Part No.	506048	Ref. No.	0200181
description	union nut thread 3/8" SS cone-shaped		
For models:	015-24L, DSP1, DSP2, DSP4, DSP5, L20, L21, P550, S200, S280, S280Dep, Super-QS, Super-QS-Dep		

			
1			
Part No.	517670	Ref. No.	0201174
description	wash jet for pre-rinsing mounting pos. upper/lower H 23mm ø 12mm		

			
1			
Part No.	506268	Ref. No.	0200853
description	rinse arm L 425mm nozzles 5 mounting ø 18mm		

miscellaneous

			
1			
Part No.	506066	Ref. No.	0200315
description	opposite support rinse jet		
For models:	DSP1, DSP2, DSP4, DSP5		
accessories for	506066		
	Part No.	506417	Ref. No.
			0200089
	swirl H 14mm ø 10mm 2mm H1 5mm		
	Part No.	506418	Ref. No.
			0200088
	rinse jet		
	Part No.	506430	Ref. No.
			0200249
	rinse jet holder		



1			
Part No.	506418	Ref. No.	0200088
description	rinse jet		
For models:	DSP1, DSP2, DSP4, DSP5		

1			
Part No.	506037	Ref. No.	0200132
description	rinse jet thread 1/8" brass		

1			
Part No.	506057	Ref. No.	0200250
description	rinse jet holder		

1			
Part No.	506430	Ref. No.	0200249
description	rinse jet holder		
For models:	DSP1, DSP2, DSP4, DSP5		
spare parts for	506430		

	Part No.	510177	Ref. No.	0200239
O-ring EPDM thickness 1.78mm ID ø 7.66mm Qty 1 pcs				

accessories for	506430			
------------------------	--------	--	--	--

	Part No.	506066	Ref. No.	0200315
opposite support rinse jet				

	Part No.	506417	Ref. No.	0200089
swirl H 14mm ø 10mm 2mm H1 5mm				

	Part No.	506418	Ref. No.	0200088
rinse jet				

1			
Part No.	506417	Ref. No.	0200089
description	swirl H 14mm ø 10mm 2mm H1 5mm		
For models:	DSP1, DSP2, DSP4, DSP5		

1			
Part No.	506099	Ref. No.	0201809
description	opposite support mounting pos. lower		

1			
Part No.	506033	Ref. No.	0200126
description	wash arm support mounting pos. lower		
For models:	050F, 050F-Dep, F85, F85-Dep		

1			
Part No.	506427	Ref. No.	0201801
description	wash arm support mounting pos. lower		

1			
Part No.	524785	Ref. No.	0201452
description	wash arm support mounting pos. lower thread 1 1/4" D1 ø 59mm D2 ø 43mm D3 ø 37mm H 65mm ID ø 31.5mm		

1			
Part No.	506092	Ref. No.	0201451
description	wash arm support mounting pos. lower thread 1 1/4" ø 15.5mm nylon		
For models:	DSP1, DSP2, DSP4, S200, S280, S280Dep, Super-QS, Super-QS-Dep		

1			
Part No.	506219	Ref. No.	0200032
description	wash arm bearing 14 holes ø 54mm D2 ø 41mm H 52mm thread 1 1/4"		

1			
Part No.	506116	Ref. No.	0202101
description	wash arm bearing mounting pos. lower 2 holes hole ø 16mm seat ø 18mm ø 35.5mm D2 ø 41mm D3 ø 53.5mm H 51.5mm double thread 1 1/4"		
For models:	015-24L, 050F, 050F-Dep, DSP5, F85, F85-Dep, L20, L21		



1

Part No.	506117	Ref. No.	0202103
description	wash arm bearing mounting pos. lower 4 holes hole ø 16mm seat ø 18mm ø 35mm D2 ø 41mm D3 ø 54mm H 52mm 4-fold thread 1¼"		
For models:	015-24L, DSP1, DSP2, DSP4, P550, S200, S280, S280Dep, Super-QS, Super-QS-Dep		



1

Part No.	506118	Ref. No.	0202120
description	wash arm bearing mounting pos. upper 4 holes hole ø 16mm seat ø 22mm ø 35.5mm D2 ø 41mm D3 ø 54mm H 52mm thread 1¼"		
For models:	015-24L, 050F, 050F-Dep, F85, F85-Dep, L20, L21, P550		



1

Part No.	506227	Ref. No.	0202113
description	wash arm bearing mounting pos. upper ø 54mm D2 ø 41mm D3 ø 35.5mm H 51.5mm 4-fold thread M8		
For models:	DSP4, DSP5		

rinse arm shafts



1

Part No.	506084	Ref. No.	0201001
description	rinse arm shaft		



1

Part No.	506086	Ref. No.	0201003
description	rinse arm shaft		
For models:	015-24L, 050F, 050F-Dep, F85, F85-Dep, L20, L21, P550, S200, S280, S280Dep, Super-QS, Super-QS-Dep		

gear wheels



1

Part No.	698414	Ref. No.	0802722
description	gear wheel splitting 1/2" teeth 22 shaft intake ø 45mm H 7mm		
For models:	M115, M150		

knobs

producer-specific knobs

LAMBER



1

Part No.	112633	Ref. No.	0300352
description	knob ø 33mm shaft ø 6x6mm grey		
For models:	F85-Dep		



1

Part No.	110905	Ref. No.	0300049
description	knob switch zero mark ø 42mm shaft ø 6x4.6mm shaft flat right black		
For models:	F85, L20		

handles and hand wheels

handle rails

LAMBER



1

Part No.	508399	Ref. No.	0500017
description	handle rail L 310mm W 25mm H 30mm grey hole distance 180mm Qty 1 pcs		
For models:	DSP1, DSP2, DSP4		



bracket handles

			
1			
Part No.	506147	Ref. No.	0500045 0500049
description	pull handle		
For models:	DSP5, LP31L, LP6, LP6L		

hinges

piano hinges

producer-specific

LAMBER

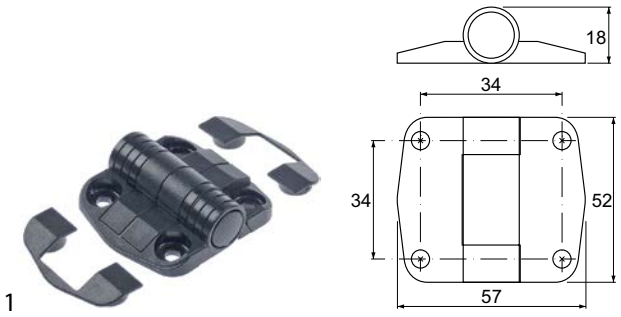
			
1			
Part No.	692467	Ref. No.	0800174
description	hinge L 52mm W 57mm H 18mm mounting distance 34mm hole ø 5mm plastic		

pullouts

rollers

rollers

accessories

			
1			
Part No.	560133	Ref. No.	0800063 0800656
description	hexagonal nut thread M6 H 5mm WS 10 SS DIN/ISO DIN 934 / ISO 4032/8673 Qty 20 pcs		
For models:	015-24L, 050F, 050F-Dep, F85, F85-Dep, L20, L21, LP31L, LP6, LP6L, M115, M150, MATIC20, P550, S200, S280, S280Dep, Super-QS, Super-QS-Dep		

gaskets

O-rings

EPDM

ø1.78mm

			
1			
Part No.	510302	Ref. No.	0200103
description	O-ring EPDM ID ø 12.42mm thickness 1.78mm Qty 1 pcs		
For models:	050F, 050F-Dep, F85, F85-Dep, S200, S280, S280Dep, Super-QS, Super-QS-Dep		

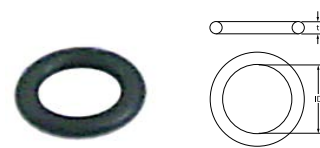
			
1			
Part No.	505045	Ref. No.	0200303
description	O-ring EPDM thickness 1.78mm ID ø 5.28mm Qty 1 pcs		
For models:	015-24L, 050F, 050F-Dep, F85, F85-Dep, L20, L21, LP31L, LP6, LP6L, M115, M150, MATIC20, P550, S200, S280, S280Dep, Super-QS, Super-QS-Dep		

			
1			
Part No.	510177	Ref. No.	0200239
description	O-ring EPDM thickness 1.78mm ID ø 7.66mm Qty 1 pcs		
For models:	DSP1, DSP2, DSP4, DSP5		

ø2.62mm

			
1			
Part No.	532047	Ref. No.	0200211
description	O-ring EPDM thickness 2.62mm ID ø 7.59mm Qty 10 pcs		
For models:	015-24L, F85-Dep, L20, L21		

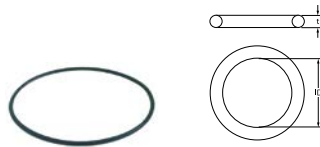
			
1			
Part No.	528800	Ref. No.	0209905
description	O-ring EPDM thickness 2.62mm ID ø 75.87mm Qty 1 pcs		



1		
	Part No. 510893	Ref. No. 0203012
description O-ring EPDM thickness 2.62mm ID ø 9.92mm Qty 1 pcs		

ø3.00mm		
1		
	Part No. 510811	Ref. No. 0200224
description O-ring EPDM thickness 3mm ID ø 59.2mm Qty 1 pcs		

ø3.53mm		
1		
	Part No. 506015	Ref. No. 0200056
description O-ring EPDM thickness 3.53mm ID ø 39.69mm Qty 1 pcs		
For models: 015-24L, 050F, 050F-Dep, DSP1, DSP2, DSP4, DSP5, F85, L20, L21, P550, S200, S280, S280Dep, Super-QS, Super-QS-Dep		

1		
	Part No. 532547	Ref. No. 0203009
description O-ring EPDM thickness 3.53mm ID ø 44.45mm Qty 1 pcs		
For models: 050F, 050F-Dep, F85, F85-Dep		

1		
	Part No. 528315	Ref. No. 0800074
description O-ring EPDM thickness 3.53mm ID ø 47.63mm Qty 1 pcs		

1		
	Part No. 528793	Ref. No. 0203003
description O-ring EPDM thickness 3.53mm ID ø 58.74mm Qty 1 pcs		

1		
	Part No. 890224	Ref. No. 0203004
description O-ring EPDM thickness 3.53mm ID ø 98.02mm Qty 1 pcs		
For models: M115, M150, MATIC20		

1		
	Part No. 503147	Ref. No. 0209906
description pump cover gasket thickness 3.53mm ID ø 148.8mm Qty 1 pcs		

ø5.34mm		
1		
	Part No. 532577	Ref. No. 0203011
description O-ring EPDM thickness 5.34mm ID ø 40.65mm Qty 1 pcs		
For models: F85-Dep		

1		
	Part No. 510409	Ref. No. 0200041
description O-ring EPDM thickness 5.34mm ID ø 56.52mm Qty 1 pcs		
For models: 015-24L, 050F, 050F-Dep, DSP1, DSP2, DSP4, DSP5, F85, F85-Dep, L20, L21, LP31L, LP6, LP6L, M115, M150, MATIC20, P550, S200, S280, S280Dep, Super-QS, Super-QS-Dep		

sealing washers

fibre gaskets

1		
	Part No. 506046	Ref. No. 0200178
description flat gasket FIBER ED ø 19.5mm ID ø 13mm thickness 2mm Qty 1 pcs		
For models: 015-24L, 050F, 050F-Dep, DSP5, F85, F85-Dep, L20, L21, S200, S280, S280Dep, Super-QS, Super-QS-Dep		





			
1			
Part No.	506071	Ref. No.	0200402
description	flat gasket FIBER ED ø 25mm ID ø 18mm thickness 2mm Qty 1 pcs		
For models:	S200, S280, S280Dep, Super-QS, Super-QS-Dep		

			
1			
Part No.	506121	Ref. No.	0201524 0208153
description	flat gasket rubber ED ø 68mm ID ø 41mm thickness 2mm Qty 1 pcs		
For models:	DSP1, DSP2, L20, L21, S200, S280, S280Dep, Super-QS, Super-QS-Dep		

			
1			
Part No.	506042	Ref. No.	0200171
description	flat gasket FIBER ED ø 27mm ID ø 17mm thickness 2mm Qty 1 pcs		
For models:	015-24L, DSP1, DSP2, DSP4, L20, L21, S200, S280, S280Dep, Super-QS, Super-QS-Dep		

			
1			
Part No.	506043	Ref. No.	0200173
description	flat gasket rubber ED ø 75mm ID ø 58.5mm thickness 2mm Qty 1 pcs		
For models:	015-24L, 050F, 050F-Dep, DSP4, DSP5, F85, F85-Dep, L20, L21, P550		

			
1			
Part No.	506025	Ref. No.	0200110
description	flat gasket FIBER ED ø 31mm ID ø 21mm thickness 2mm Qty 1 pcs		
For models:	015-24L, 050F, 050F-Dep, F85, F85-Dep, L20, L21, LP31L, LP6, LP6L, M115, M150, MATIC20, P550, S200, S280, S280Dep, Super-QS, Super-QS-Dep		

PTFE gaskets			
			
1			
Part No.	506164	Ref. No.	0200222 0800052
description	flat gasket PTFE ED ø 57mm ID ø 41mm thickness 2mm Qty 1 pcs		
For models:	015-24L, 050F, 050F-Dep, DSP1, DSP2, DSP4, DSP5, F85, F85-Dep, L20, L21, P550, S200, S280, S280Dep, Super-QS, Super-QS-Dep		

			
1			
Part No.	506072	Ref. No.	0200403
description	flat gasket fibre ED ø 38mm ID ø 27mm thickness 2mm outflow for thread 1¼" Qty 1 pcs		
For models:	015-24L, 050F, 050F-Dep, DSP5, F85, F85-Dep, L20, L21, P550, S200, S280, S280Dep, Super-QS, Super-QS-Dep		

			
1			
Part No.	506058	Ref. No.	0200268
description	gasket PTFE ED ø 15mm ID ø 12.2mm thickness 9mm beveled size 3/8" Qty 1 pcs		
For models:	015-24L, 050F, 050F-Dep, DSP1, DSP2, DSP4, DSP5, F85, F85-Dep, L20, L21, LP31L, LP6, LP6L, P550, S200, S280, S280Dep, Super-QS, Super-QS-Dep		

rubber gaskets			
			
1			
Part No.	506051	Ref. No.	0200188
description	flat gasket rubber ED ø 25mm ID ø 16mm thickness 2mm Qty 1 pcs		
For models:	015-24L, 050F, 050F-Dep, DSP1, DSP2, DSP4, DSP5, F85, F85-Dep, L20, L21, LP6, LP6L, P550, S200, S280, S280Dep, Super-QS, Super-QS-Dep		

silicone gaskets			
			
1			
Part No.	516255	Ref. No.	0200304
description	gasket silicone ED ø 45mm ID ø 35mm thickness 6mm Qty 1 pcs		
For models:	LP31L, LP6, LP6L, M115, M150, MATIC20		

			
1			
Part No.	516254	Ref. No.	0201500
description	flat gasket rubber ED ø 66mm ID ø 46mm thickness 2.1mm Qty 1 pcs		
For models:	LP31L, LP6, LP6L, M115, M150, MATIC20		



shaft gaskets

shaft gaskets



1

Part No.	697121	Ref. No.	0800080
description	shaft seal ID \varnothing 17mm ED \varnothing 40mm thickness 7mm		
For models:	M115, M150, MATIC20		



1

Part No.	698001	Ref. No.	0800078
description	shaft seal ID \varnothing 20mm ED \varnothing 35mm thickness 7mm		
For models:	M115, M150, MATIC20		



1

Part No.	698413	Ref. No.	0209780
description	shaft sealing ID \varnothing 18mm ED \varnothing 40mm thickness 7mm		

special gaskets

miscellaneous



1

Part No.	506044	Ref. No.	0200175
description	gasket		
For models:	DSP1, DSP2, DSP4		



1

Part No.	506039	Ref. No.	0200145
description	gasket ED \varnothing 7mm ID \varnothing 5mm thickness 3mm		
For models:	DSP1, DSP2, DSP4		



1

Part No.	506429	Ref. No.	0200289
description	gasket for air trap		
For models:	DSP2, DSP4		



1

Part No.	504442	Ref. No.	0201532
description	gasket for intake filter ED \varnothing 140mm ID \varnothing 84mm thickness 2mm hole distance 78mm		



1

Part No.	524792	Ref. No.	0200259
description	gasket for rinse arm mounting pos. upper/lower \varnothing 22.5mm ID \varnothing 13mm thickness 10mm		
For models:	M115, M150, MATIC20		



1

Part No.	524786	Ref. No.	0200400
description	gasket for wash arm mounting pos. upper/lower \varnothing 46mm ID \varnothing 36mm		
For models:	M115, M150, MATIC20		



1

Part No.	506063	Ref. No.	0200295
description	gasket suitable for Lamber equiv. no. 0200295 air trap ED \varnothing 15.5mm ID \varnothing 11.5mm Nyltite		
For models:	015-24L, 050F, 050F-Dep, DSP1, DSP5, F85, F85-Dep, L20, L21, LP31L, LP6, LP6L, M115, M150, MATIC20, P550, S200, S280, S280Dep, Super-QS, Super-QS-Dep		



1

Part No.	506097	Ref. No.	0201506 0203506
description	gasket suitable for Lamber equiv. no. 0201506 L 100mm W 100mm thickness 3mm		
For models:	015-24L, LP31L, LP6, LP6L, M115, M150, MATIC20, P550		

2

Part No.	524258	Ref. No.	0201504
description	gasket suitable for Lamber for wash arm support L 100mm W 100mm Qty 1m ID ø 61mm		
For models:	LP31L, LP6, LP6L		

1

Part No.	504440	Ref. No.	0201505
description	gasket suitable for Lamber L 100mm W 100mm ID ø 43mm thickness 3mm		
For models:	M115, M150, MATIC20		

1

Part No.	504441	Ref. No.	0201503
description	gasket suitable for Lamber L 100mm W 100mm Qty 1m ID ø 40mm thickness 3mm		
For models:	M115, M150, MATIC20		

gaskets for wash arm support

1

Part No.	506021	Ref. No.	0200097
description	gasket D1 ø 45mm D2 ø 105mm thickness 3.4mm rubber with 4 screw holes wash arm support equiv. no. 0200097 suitable for Lamber		
For models:	015-24L, 050F, 050F-Dep, DSP5, F85, F85-Dep, L20, L21, M115, M150, MATIC20, P550		

transmission technology and ball bearings

ball bearings

deep-groove ball bearings 2RS

1

Part No.	523551	Ref. No.	0802500
description	deep-groove ball bearing type 6003-2RS shaft ø 17mm ED ø 35mm W 10mm with sealing discs deep-groove ball bearing DIN 625-1		
For models:	M115, M150, MATIC20		

1

Part No.	523509	Ref. No.	0800131
description	deep-groove ball bearing type 6201-2RS shaft ø 12mm ED ø 32mm W 10mm with sealing discs deep-groove ball bearing DIN 625-1		
For models:	M115, M150, MATIC20		

1

Part No.	523511	Ref. No.	0802501
description	deep-groove ball bearing type 6203-2RS shaft ø 17mm ED ø 40mm W 12mm with sealing discs deep-groove ball bearing DIN 625-1		
For models:	M115, M150, MATIC20		



miscellaneous



1

Part No.	523021	Ref. No.	0800490
description	ball bearing shaft \varnothing 8mm ED \varnothing 27mm W 9.5mm plastic		
For models:	M115, M150, MATIC20		

chains

roller chains 08B-1 single



1

Part No.	697854	Ref. No.	0800081
description	roller chain DIN/ISO 08 B-1 splitting 1/2" / 12.7mm L 1180mm internal width 7.75mm roller \varnothing 8.51mm single		
For models:	MATIC20		

accessories for 697854

Part No.	693276	Ref. No.	0813444
description	connector single DIN/ISO 08 B-1 splitting 1/2" links 1 L 23mm internal width 11.8mm roller \varnothing 4.3mm metal		

connectors



1

Part No.	693276	Ref. No.	0813444
description	connector single DIN/ISO 08 B-1 splitting 1/2" links 1 L 23mm internal width 11.8mm roller \varnothing 4.3mm metal		
For models:	M115, M150, MATIC20		

half links



1

Part No.	697841	Ref. No.	0813534
description	half link single DIN/ISO 08 B-1 splitting 1/2"		
For models:	M115, M150, MATIC20		

springs

spring compressors



1

Part No.	517160	Ref. No.	0800210
description	spring compressor thread M10		
For models:	015-24L, L20, L21		

tension springs



1

Part No.	506424	Ref. No.	0800033
description	tension spring		



1

Part No.	700730	Ref. No.	0800161
description	tension spring \varnothing 12mm total length 100mm wire gauge \varnothing 1mm		
For models:	LP31L, LP6, LP6L		



1

Part No.	506199	Ref. No.	0800711
description	tension spring \varnothing 40.5mm total length 355mm wire gauge \varnothing 5mm L1 220mm D1 \varnothing 40.5mm for hood H1 30mm L 355mm windings 42		
For models:	015-24L, DSP5, L20, L21		

manometers



1

Part No.	541865	Ref. No.	0301152
description	manometer \varnothing 51mm pressure range 0 up to 4bar thread 1/4" marking 3 connection on the backside		
For models:	M115, M150, MATIC20		



dosing pumps



membrane dosing pumps

self-priming

LANG





1

Part No.	361221	Ref. No.	0500057
description	dosing pump type N6 rinse aid pressure connection ø 4x6mm suction connection ø 6x8mm LANG		
For models:	DSP1, DSP2, DSP4, DSP5		
spare parts for	361221		
	Part No.	361079	Ref. No. —
	spring for type N5/N6 for ball		
	Part No.	361080	Ref. No. —
	O-ring EPDM thickness 2mm ID ø 16mm Qty 1 pcs		
	Part No.	361085	Ref. No. —
	O-ring EPDM thickness 2mm ID ø 8mm Qty 1 pcs		
	Part No.	361309	Ref. No. —
	ball for type N5/N6		
	Part No.	361310	Ref. No. —
	bracket for type N6 ball guide		
	Part No.	361311	Ref. No. —
	O-ring EPDM thickness 2mm ID ø 6mm Qty 1 pcs for type N6		
	Part No.	361314	Ref. No. —
	valve ring for type N6 holder for O-ring		
	Part No.	361317	Ref. No. —
	sealing disc for type N6		
	Part No.	361886	Ref. No. —
	non-return valve inletmm outletmm outlet ø 12.4mm L 12.7mm		
	Part No.	505228	Ref. No. —
	spacer bush ID ø 4.5mm ED ø 10mm L 16mm for dosing pump		

various



1

Part No.	361015	Ref. No.	0599999
description	dosing pump membrane dosing pump rinse aid inlet 6x8mm outlet 4x6mm pressure connection ø 4x6mm suction connection ø 6x8mm		
For models:	015-24L, 050F, 050F-Dep, F85, F85-Dep, L20, L21, P550, S200, S280, S280Dep, Super-QS, Super-QS-Dep		
spare parts for	361015		
	Part No.	361132	Ref. No. 0200428
	membrane dosing pump		
	Part No.	510298	Ref. No. 0200425
	lip valve dosing pump suitable for DB2/DS5		

spare parts



1

Part No.	361132	Ref. No.	0200428
description	membrane dosing pump		
For models:	015-24L, 050F, 050F-Dep, F85, F85-Dep, L20, L21, S200, S280, S280Dep, Super-QS, Super-QS-Dep		



1

Part No.	510338	Ref. No.	0200219
description	union nut dosing pump thread 1/2" ø 32mm H 15mm for dosing pump		

accessories

container filters



1

Part No.	361062	Ref. No.	0200443
description	container filter hose ø 4mm		
For models:	015-24L, 050F, 050F-Dep, DSP1, DSP2, DSP4, DSP5, F85, F85-Dep, L20, L21, P550, S200, S280, S280Dep, Super-QS, Super-QS-Dep		



hoses

dosing hoses



Part No.	512477	Ref. No.	0200511
description	hose ED ø 6mm ID ø 4mm PVC		
For models:	050F, 050F-Dep, DSP5, F85, F85-Dep, S200, S280, S280Dep, Super-QS, Super-QS-Dep		

tank inlets



Part No.	506150	Ref. No.	0500090
description	tank inlet		
For models:	015-24L, 050F, 050F-Dep, F85, F85-Dep, L20, L21, S200, S280, S280Dep, Super-QS, Super-QS-Dep		

hoses

supply hoses

PVC supply hoses

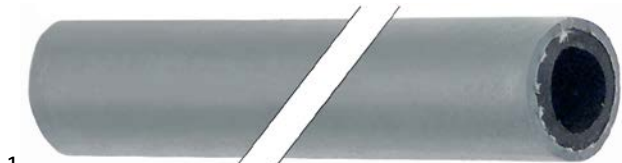

Part No.	520017	Ref. No.	0200498
description	supply hose ID ø 13mm ED ø 20mm L 5m operating p. 20bar burst p. 60bar t.max. 95°C grey Qty 5m		
For models:	LP31L, LP6, LP6L, M115, M150, MATIC20		

drain hoses



Part No.	506207	Ref. No.	0900006
description	drain hose DN19 L 1500mm straight ø inside 19mm straight ext. ø 24mm elbow ø inside 21mm elbow ext. ø 27mm outer hose ø 25mm		
For models:	015-24L, 050F, 050F-Dep, DSP5, F85, F85-Dep, L20, L21, S200, S280, S280Dep, Super-QS, Super-QS-Dep		

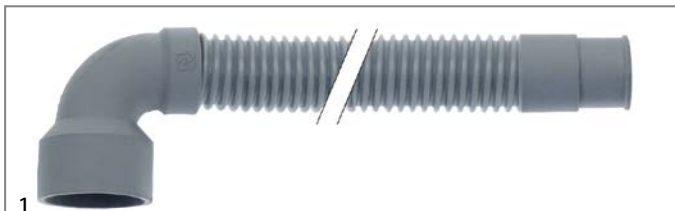

Part No.	506208	Ref. No.	0900027
description	drain hose DN25 L 1500mm straight ø inside 25mm straight ext. ø 30mm elbow ø inside 40mm elbow ext. ø 46mm outer hose ø 32mm		
For models:	DSP1, DSP2, DSP4, S200, S280, S280Dep, Super-QS, Super-QS-Dep		

industrial hoses

pressure control hoses



Part No.	530068	Ref. No.	0200515
description	pressure hose ID ø 4mm ED ø 8.5mm L 1m operating p. 30bar burst p. 90bar temp.-resist. 60°C L 1000mm Qty 1m		
For models:	050F, 050F-Dep, DSP1, DSP5, F85, F85-Dep, LP31L, LP6, LP6L, M115, M150, MATIC20, P550, S200, S280, S280Dep, Super-QS, Super-QS-Dep		

PVC hoses

PVC hoses without fabric



Part No.	520090	Ref. No.	0200091
description	PVC hose ID ø 4mm ED ø 6mm L 2m thickness 1mm t.max. 60°C transparent		
For models:	015-24L, 050F, 050F-Dep, DSP1, DSP2, DSP4, DSP5, F85, F85-Dep, L20, L21, P550, S200, S280, S280Dep, Super-QS, Super-QS-Dep		

accessories for	520090			
	Part No.	361058	Ref. No.	—
	container filter with non-return valve SS hose ø 4x6mm ø 20mm L 56mm			
	Part No.	361066	Ref. No.	—
	container filter straight SS hose ø 4x6mm L 37mm non return valve ball valve			
	Part No.	361106	Ref. No.	—
	container filter with weight and non-return valve SS hose ø 4x6mm ø 21mm L 51mm non return valve lip valve			
	Part No.	361141	Ref. No.	—
	container filter with weight ceramic hose ø 4mm			
	Part No.	361230	Ref. No.	—
	container filter with weight stainless steel hose ø 4x6mm			
	Part No.	361462	Ref. No.	—
	container filter with weight SS hose ø 4x6mm			
	Part No.	361728	Ref. No.	—
	container filter with 4m 4x6 hose SS hose ø 4x6mm hose length 4000mm			



hoses wire reinforced

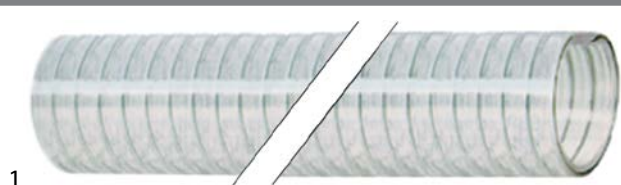

Part No.	506074	Ref. No.	0200521
description	drain hose ID ø 32mm ED ø 41mm L 1m wire reinforced		
For models:	015-24L		



Part No.	504160	Ref. No.	0201900
description	formed hose L 100mm dishwasher straight hose ext. ø 60mm equiv. no. 4085, 3927		
For models:	M115, M150, MATIC20		

formed hoses

straight



Part No.	506218	Ref. No.	0201923
description	extraction hose		
For models:	050F, 050F-Dep, F85, F85-Dep		



Part No.	506036	Ref. No.	0200131
description	formed hose L 100mm dishwasher straight ø 30mm		
For models:	015-24L, 050F, 050F-Dep, F85, F85-Dep, L20, L21, P550		



Part No.	506011	Ref. No.	0200031
description	formed hose dishwasher straight		



Part No.	506032	Ref. No.	0200122
description	formed hose L 130mm dishwasher straight hose ext. ø 50mm		



Part No.	506112	Ref. No.	0201914
description	formed hose dishwasher straight		
For models:	015-24L, P550		



Part No.	506113	Ref. No.	0201919
description	formed hose L 150mm dishwasher straight enlarged mounting pos. lower nominal-ø 60/43mm		
For models:	015-24L, DSP5, P550		



Part No.	506423	Ref. No.	0201924
description	formed hose L 230mm dishwasher straight ø 40mm		
For models:	L20, L21		



1

Part No.	506031	Ref. No.	0200119
description	formed hose L 50mm dishwasher straight hose ext. ø 35mm		



1

Part No.	506038	Ref. No.	0200133
description	formed hose L 60mm dishwasher straight mounting pos. lower ø 40mm		

form L



1

Part No.	506107	Ref. No.	0201904
description	formed hose end piece A ext. ø 37mm AD2 ø 28mm warewashing L-shape equiv. no. 0201904		
For models:	DSP1, DSP2		



1

Part No.	506108	Ref. No.	0201905
description	formed hose end piece A ext. ø 38mm AD2 ø 29mm warewashing L-shape equiv. no. 0201905		
For models:	DSP1, DSP2, S200, S280, S280Dep, Super-QS, Super-QS-Dep		



1

Part No.	506055	Ref. No.	0200244
description	formed hose L 133mm warewashing L-shape equiv. no. 0200244 ID ø 37mm		



1

Part No.	506435	Ref. No.	0200124
description	formed hose warewashing L-shape		
For models:	DSP4		



1

Part No.	506110	Ref. No.	0201907
description	formed hose warewashing L-shape equiv. no. 02001907		



1

Part No.	506109	Ref. No.	0201906
description	formed hose warewashing L-shape equiv. no. 0201906		

form S



1

Part No.	506217	Ref. No.	0201922
description	formed hose		
For models:	050F, 050F-Dep, F85, F85-Dep		



1

Part No.	506209	Ref. No.	0200213
description	formed hose S-shape warewashing equiv. no. 0200213		



1

Part No.	506053	Ref. No.	0200093 0200232
description	formed hose S-shape warewashing equiv. no. 0200232		
For models:	DSP5		

for dishwashers

ventilation hoses



1

Part No.	506156	Ref. No.	0500600
description	ventilation hose warewashing		
For models:	050F, 050F-Dep, DSP4, F85, F85-Dep		

miscellaneous



1

Part No.	511642	Ref. No.	0200931
description	flex hose ET 1/2" IT 3/4" L 23mm SS ext. ø 18		
For models:	LP6		



1

Part No.	506431	Ref. No.	0200200
description	hose ED ø 10/15mm ID ø 4/10mm L 2200mm temp.-resist. 70°C for air trap		
For models:	015-24L, DSP2, DSP4, L20, L21, LP31L, LP6, LP6L		

fittings, hose and pipe connectors

fittings

double nipples



1

Part No.	520164	Ref. No.	0200698
description	double nipple nickel-plated brass thread 1/4" - 3/8" Qty 1 pcs		



1

Part No.	506013	Ref. No.	0200040
description	double nipple SS thread 1/4" - 3/8" Qty 1 pcs		
For models:	015-24L, DSP1, DSP2, DSP4, DSP5, L20, L21, S200, S280, S280Dep, Super-QS, Super-QS-Dep		

reducers



1

Part No.	520880	Ref. No.	0200909
description	reducer thread 1/4" ET - 1" IT brass total length 26mm WS 42 Qty 1 pcs		



1

Part No.	520879	Ref. No.	0200920
description	reducer thread 3/4" ET - 1/2" IT brass total length 17mm WS 26 Qty 1 pcs		
For models:	LP31L, LP6, M115, M150		



1

Part No.	506083	Ref. No.	0200932
description	reducer thread 1" ET - 1/2" IT brass total length 22mm WS 34		
For models:	015-24L, L20, L21, LP31L, LP6L, P550		

angle pieces



1

Part No.	541675	Ref. No.	0200905
description	angle piece thread 1/2" ET - 1/2" IT brass		
For models:	LP6, M115, M150, MATIC20		



1

Part No.	540020	Ref. No.	0200910
description	angle piece thread 1/2" IT - 1/2" IT chrome-plated brass		
For models:	LP31L, LP6, M115, M150, MATIC20		



1

Part No.	506041	Ref. No.	0200162
description	angle piece thread 3/8" polypropylene		
For models:	015-24L, L20, L21		

hose connectors

plastic





1

Part No.	506122	Ref. No.	0221302
description	hose connector plastic straight thread 1/4" hose ø 31mm Qty 1 pcs		
For models:	015-24L, DSP5, L20, L21, P550		
accessories for	506122		
	Part No.	506072	Ref. No.
			0200403
	flat gasket fibre ED ø 38mm ID ø 27mm thickness 2mm outflow for thread 1/4" Qty 1 pcs		

accessories for	506122		
	Part No.	506074	Ref. No.
			0200521
	drain hose ID ø 32mm ED ø 41mm L 1m wire reinforced		



1

Part No.	506125	Ref. No.	0221310
description	hose connector plastic angled thread 3/8" hose ø 12mm Qty 1 pcs		
For models:	015-24L, 050F, 050F-Dep, F85, F85-Dep, L20, L21, S200, S280, S280Dep, Super-QS, Super-QS-Dep		
accessories for	506125		
	Part No.	506042	Ref. No.
			0200171
	flat gasket FIBER ED ø 27mm ID ø 17mm thickness 2mm Qty 1 pcs		
	Part No.	506132	Ref. No.
			0300047
	nut thread 3/8"		

producer-specific



1

Part No.	506082	Ref. No.	0200906
description	hose connector angled brass ø 1/2"mm		
For models:	015-24L, L20, L21, LP31L, LP6, LP6L, M115, M150, MATIC20, P550		



1

Part No.	506052	Ref. No.	0200231
description	hose connector connection 3/4" hose ø 12mm		
For models:	LP31L		



1

Part No.	506126	Ref. No.	0221313
description	hose connector curved plastic ø 3/4"mm		
For models:	LP31L, M115, M150		



1

Part No.	506081	Ref. No.	0200903
description	hose connector straight ø 1/2"mm		
For models:	015-24L, L20, L21, LP31L, LP6, LP6L, M115, M150, MATIC20, P550		

1

Part No.	506014	Ref. No.	0200049
description	hose connector straight \varnothing 3/4"mm		



1

Part No.	506415	Ref. No.	0221304
description	hose connector thread 2" for hose \varnothing 60mm		
For models:	LP31L, LP6L		



1

Part No.	505256	Ref. No.	0200646
description	hose connector thread M12 \varnothing 13mm 1/2" ET		
For models:	M115, M150, MATIC20		



1

Part No.	506124	Ref. No.	0221307
description	reducer straight plastic		



1

Part No.	506098	Ref. No.	0201804
description	T-piece		
For models:	015-24L, P550		

water cycle components

pressure reduction valves

pressure reduction valves

universal



1

Part No.	520881	Ref. No.	0301151
description	pressure reduction valve DESBORDES series DN15 connection 1/2" default setting 3bar setting range 1-5.5bar EN1567 p max 25bar t.max. 80°C brass WRAS/ACS		
For models:	M115, M150, MATIC20		

tools

hand tools

wrenches

miscellaneous



1

Part No.	801662	Ref. No.	0802792
description	adjusting spanner for clutch L 270mm		
For models:	M115, M150, MATIC20		

measuring equipment

thermometers

built-in thermometers



1

Part No.	541086	Ref. No.	0500005
description	thermometer mounting measurements 58x25.5mm 0 up to +120°C capillary pipe 2000mm probe \varnothing 6mm probe L 23mm		
For models:	M115, M150		



1

Part No.	541305	Ref. No.	0500008
description	thermometer mounting measurements 62x11mm +20 up to +120°C capillary pipe 1500mm probe ø 6.5mm probe L 16mm		

ø52mm



1

Part No.	541065	Ref. No.	0500009
description	thermometer mounting ø 52mm t.max. 120°C 0 up to +120°C probe ø 6.5mm probe L 28mm capillary pipe 1500mm		
For models:	F85, LP31L, LP6, LP6L, MATIC20, P550, S280, S280Dep, Super-QS, Super-QS-Dep		

fastening material

screws

sheet metal screws



1

Part No.	560240	Ref. No.	0800001
description	sheet metal screws ø 3.9mm L 16mm SS Qty 20 pcs DIN 7982/ISO 7050 head ø 7.5mm sunk head		
For models:	DSP1, DSP2, DSP4, DSP5		

hexagonal screws



1

Part No.	506445	Ref. No.	0800228
description	hexagonal screw thread M10 thread L 35mm SS WS 17 Qty 1 pcs DIN 933 / ISO 4017		
For models:	015-24L, DSP5, L20, L21		



1

Part No.	560476	Ref. No.	0800661
description	hexagonal screw thread M10 thread L 40mm zinc-coated steel WS 17 Qty 1 pcs head thickness 6.4mm DIN 933 / ISO 4017		
For models:	015-24L, DSP5, L20, L21		



1

Part No.	560539	Ref. No.	0800667
description	hexagonal screw thread M10 thread L 42mm SS WS 17 Qty 1 pcs head thickness 6.5mm DIN 933 / ISO 4017		
For models:	M115, M150, MATIC20		



1

Part No.	560085	Ref. No.	0800648
description	hexagonal screw thread M5 thread L 20mm SS WS 8 Qty 20 pcs DIN 933 / ISO 4017		
For models:	DSP1, DSP2, DSP4		



1

Part No.	560088	Ref. No.	0800062
description	hexagonal screw thread M6 thread L 20mm SS WS 10 Qty 20 pcs DIN 933 / ISO 4017		
For models:	LP31L, LP6, LP6L, P550		



1

Part No.	506447	Ref. No.	0800009
description	hexagonal screw thread M8 thread L 16mm SS WS 13 Qty 1 pcs DIN 933 / ISO 4017		
For models:	DSP4, DSP5, LP31L, LP6, LP6L		



1

Part No.	506446	Ref. No.	0800016
description	hexagonal screw thread M8 thread L 40mm SS WS 13 Qty 1 pcs DIN 933 / ISO 4017		
For models:	015-24L, 050F, 050F-Dep, F85, F85-Dep, P550		



grub screws

DIN 914/ISO 4027

			
1			
Part No.	560175	Ref. No.	0800682
description	grub screw thread M8 L 16mm DIN 914/ISO 4027 intake internal hexagon WS 4 Qty 1 pcs		
For models:	LP6L, M115, M150, MATIC20		

knurled screws

			
1			
Part No.	506172	Ref. No.	0800130
description	Thumb screw thread M6 thread L 9mm ø 22mm H 6mm SS		
For models:	015-24L, 050F, 050F-Dep, F85, F85-Dep, L20, L21, LP31L, LP6, LP6L, P550, S200, S280, S280Dep, Super-QS, Super-QS-Dep		

nuts

knurled nuts

			
1			
Part No.	506146	Ref. No.	0500011
description	knurled nut thread M6		

hexagonal nuts

DIN 934 / ISO 4032/8673

			
1			
Part No.	560199	Ref. No.	0800082
description	hexagonal nut thread M10 H 8mm WS 17 SS DIN/ISO DIN 934 / ISO 4032/8673 Qty 10 pcs		
For models:	M115, M150, MATIC20		

			
1			
Part No.	560129	Ref. No.	0800257
description	hexagonal nut thread M5 H 4mm WS 8 SS DIN/ISO DIN 934 / ISO 4032/8673 Qty 1 pcs		
For models:	DSP1, DSP2, DSP4		

			
1			
Part No.	560133	Ref. No.	0800063 0800656
description	hexagonal nut thread M6 H 5mm WS 10 SS DIN/ISO DIN 934 / ISO 4032/8673 Qty 20 pcs		
For models:	015-24L, 050F, 050F-Dep, F85, F85-Dep, L20, L21, LP31L, LP6, LP6L, M115, M150, MATIC20, P550, S200, S280, S280Dep, Super-QS, Super-QS-Dep		

			
1			
Part No.	560197	Ref. No.	0800106
description	nut thread M10 H 8mm WS 17 SS DIN/ISO DIN 934 / ISO 4032/8673 Qty 1 pcs		
For models:	015-24L, DSP5, L20, L21		

			
1			
Part No.	506166	Ref. No.	0800091
description	nut thread M12 H 10mm WS 19 SS DIN/ISO DIN 934 / ISO 4032/8673 Qty 1 pcs		
For models:	015-24L, 050F, 050F-Dep, DSP5, F85, F85-Dep, L20, L21, S200, S280, S280Dep, Super-QS, Super-QS-Dep		

DIN 985

			
1			
Part No.	560227	Ref. No.	0800652
description	hexagonal nut thread M3 H 4mm SS WS 5.5 Qty 1 pcs self-locking		
For models:	050F, 050F-Dep, DSP1, DSP2, DSP4, DSP5, F85, F85-Dep, S200, S280, S280Dep, Super-QS, Super-QS-Dep		

			
1			
Part No.	560142	Ref. No.	0800669
description	hexagonal nut thread M6 H 6mm SS WS 10 Qty 20 pcs DIN/ISO DIN 985 self-locking		
For models:	LP31L, LP6, LP6L, M115, M150		

			
1			
Part No.	560143	Ref. No.	0800093 0800657
description	hexagonal nut thread M8 H 8.5mm SS WS 13 Qty 20 pcs DIN/ISO DIN 985 self-locking		
For models:	015-24L, DSP4, DSP5, L20, L21, LP31L, LP6, LP6L, M115, M150, MATIC20, P550		



DIN 982 (self-locking, tall version)



1

Part No.	560475	Ref. No.	0800144
description	hexagonal nut thread M10 H 11.5mm zinc-coated steel WS 17 Qty 1 pcs DIN/ISO DIN 982		
For models:	015-24L, DSP5, L20, L21		



1

Part No.	560660	Ref. No.	0800653
description	hexagonal nut thread M5 H 5.4mm zinc-coated steel WS 8 Qty 20 pcs DIN/ISO DIN 982 self-locking		

hexagonal nuts metric (without norm)



1

Part No.	521131	Ref. No.	0800205
description	nut thread M12x1 H 3.5mm WS 17 SS Qty 1 pcs		
For models:	015-24L, 050F, 050F-Dep, DSP1, DSP2, DSP4, DSP5, F85, F85-Dep, L20, L21, LP31L, LP6, LP6L, P550, S200, S280, S280Dep, Super-QS, Super-QS-Dep		



1

Part No.	521101	Ref. No.	0800664
description	nut thread M14x1.5 H 5mm WS 19 SS Qty 1 pcs		

hexagonal nuts inch thread



1

Part No.	506194	Ref. No.	0800655
description	nut thread 1/2" H 3mm nickel-plated brass WS 24 Qty 1 pcs		
For models:	050F, 050F-Dep, F85, F85-Dep, M115, M150, MATIC20, S200, S280, S280Dep, Super-QS, Super-QS-Dep		



1

Part No.	506024	Ref. No.	0200101
description	nut thread 3/8" H 6mm SS WS 22 Qty 1 pcs		
For models:	015-24L, L20, L21, S200, S280, S280Dep, Super-QS, Super-QS-Dep		

union nuts



1

Part No.	506196	Ref. No.	0800673
description	nut brass		
For models:	015-24L, 050F, 050F-Dep, DSP5, F85, F85-Dep, L20, L21, LP31L, LP6, LP6L, P550, S200, S280, S280Dep, Super-QS, Super-QS-Dep		

washers

spring rings



1

Part No.	560123	Ref. No.	0800066
description	lock washer ID ø 6.3mm ED ø 11mm SS DIN127 Qty 20 pcs for thread M6		
For models:	015-24L, 050F, 050F-Dep, DSP5, F85, F85-Dep, L20, L21, LP31L, LP6, LP6L, M115, M150, MATIC20, P550, S200, S280, S280Dep, Super-QS, Super-QS-Dep		

washers

DIN 125A



1

Part No.	560112	Ref. No.	0800256
description	plain washer ID ø 5.3mm ED ø 10mm thickness 1mm SS Qty 20 pcs DIN 125A for thread M5		
For models:	050F, 050F-Dep, DSP1, DSP2, DSP4, F85, F85-Dep, S200, S280, S280Dep, Super-QS, Super-QS-Dep		



1

Part No.	560113	Ref. No.	0800004
description	plain washer ID ø 6.4mm ED ø 12mm thickness 1.6mm SS Qty 20 pcs DIN 125A for thread M6		
For models:	LP31L, LP6, LP6L		

DIN 9021



1

Part No.	528761	Ref. No.	0800064
description	plain washer ID ø 6.5mm ED ø 18mm thickness 1.5mm SS Qty 1 pcs		
For models:	050F, 050F-Dep, F85, F85-Dep, LP31L, LP6, LP6L, M115, M150, MATIC20, P550, S200, S280, S280Dep, Super-QS, Super-QS-Dep		



miscellaneous



1			
Part No.	506205	Ref. No.	0800906
description	disc SS		



1			
Part No.	506160	Ref. No.	0800028
description	plain washer ID ø 8.6mm ED ø 16mm thickness 1.5mm SS Qty 1 pcs		
For models:	015-24L, DSP5, L20, L21, LP31L, LP6, LP6L, M115, M150, MATIC20		

tooth lock washers

DIN 6798A



1			
Part No.	560125	Ref. No.	0800101
description	tooth lock washer ID ø 4.2mm ED ø 8mm SS DIN/ISO DIN 6798A Qty 20 pcs for thread M4		
For models:	050F, 050F-Dep, F85, F85-Dep, LP31L, LP6, LP6L, S200, S280, S280Dep, Super-QS, Super-QS-Dep		

fasteners

clamps

hose clamps

DIN 3017 - W2



1			
Part No.	520115	Ref. No.	0200298
description	hose clamp ø 25-40mm width 9mm Qty 10 pcs DIN 3017		
For models:	015-24L, 050F, 050F-Dep, DSP1, DSP2, DSP4, DSP5, F85, F85-Dep, L20, L21, P550, S200, S280, S280Dep, Super-QS, Super-QS-Dep		



1			
Part No.	520119	Ref. No.	0200248 0200713
description	hose clamp ø 60-80mm width 9mm Qty 5 pcs DIN 3017		
For models:	L20, L21, M115, M150, MATIC20, P550		



1			
Part No.	520117	Ref. No.	0200069
description	hose clamp stainless steel ø 40-60mm width 9mm Qty 5 pcs DIN 3017		
For models:	050F, 050F-Dep, DSP4, DSP5, F85, F85-Dep, L20, L21, P550		

DIN 3017 - W4



1			
Part No.	520120	Ref. No.	0200190 0200300
description	hose clamp SS W4 ø 12-20mm width 9mm Qty 1 pcs DIN 3017		
For models:	015-24L, 050F, 050F-Dep, DSP1, DSP2, DSP4, DSP5, F85, F85-Dep, L20, L21, LP31L, LP6, LP6L, P550, S200, S280, S280Dep, Super-QS, Super-QS-Dep		

cable clamps



1			
Part No.	524789	Ref. No.	0800492
description	cable clamp wire gauge ø 5mm SS		
For models:	M115, M150, MATIC20		

retaining rings

DIN 471



1			
Part No.	514030	Ref. No.	0800133
description	retaining ring shaft ø 20mm thickness 1.3mm steel DIN 471		

screw caps



1			
Part No.	505257	Ref. No.	0800166 + 0200295 0802080
description	screw thread 1/8" with gasket thread L 15mm V2A WS 13 head thickness 4mm		
For models:	LP31L, LP6, M115, M150, MATIC20		



GASTROPARTS

GASTROPARTS Sp. J.
Klonowica 37
87-100 Toruń

www.gastroparts.com 

gastroparts@gastroparts.com 

tel. +48 56 657 00 68 

[/gastroparts.global](https://www.facebook.com/gastroparts.global) 

[/gastroparts.global](https://www.instagram.com/gastroparts.global) 