








GASTROPARTS

zmywarki / dishwashers


ELETTROBAR

-  www.gastroparts.com
-  gastroparts@gastroparts.com
-  tel. +48 56 657 00 68
-  [/gastroparts.global](https://www.facebook.com/gastroparts.global)
-  [/gastroparts.global](https://www.instagram.com/gastroparts.global)





heating elements


contact heaters

			
1			
Part No.	416237	Ref. No.	230104 999206
description	contact heater 1400W 230V heating circuits 1 L 133mm W 120mm H 10mm dishwasher connection soldering connection connection distance 76mm connection length 37mm heat-conducting paste included hole \varnothing 7mm dry heating element		
For models:	2312-007, 2312-009-CRP, 914100, 914101, 914339, 914342, 914343, 914624, 914625, 914626, 914627, 914628, 914850, 914851, 914854, 914944, PS-60, RIVER-48, RIVER-50, RIVER-50-CRP, RIVER-50-CRP-SP, RIVER-54, RIVER-54CRP, River-54-CRP-s.p., RIVER-54-CRP-SP, RIVER-61		

coil heating elements



			
1			
Part No.	420330	Ref. No.	927132 DRE2
description	heating element 2000W 240V L 454mm W 210mm \varnothing 27.5mm thread M14x1 connection M4 for drying warewashing heating circuits 1 2 hole fixing		
For models:	161, 221, 271, 272, 362, A3EBDAKRKYK, A3EBSAKRK, A4EBDAKEYK, A4EBDAKRK, A4EBDAKWK, A4EBDAKZK, A4EBDBKRR, A4EBSAK, A4EBSAKCK, A4EBSAKEKYK, A4EBSAKRKP, A4EBTSAK, A5EBDAKYK, A5EBSAKRK, A5EBSAKRKYK, A5EBSAKWK, A5EBSAKWKYK, A5EBSBKRRPK, A5EBSBKWK, CLEAN-161, CLEAN-221, CLEAN-271, CLEAN-272, CLEAN-361, CLEAN-361P, CLEAN-362, CLEAN-471, CLEAN-471P, GL280EB23DAR, GL280EBDARY, GL280EBDAW, GL280EBDAY, GL280EBDB, GL280EBDBR, GL280EBSA, GL280EBSAE, GL280EBSAEW, GL280EBSAEWY, GL280EBSAR, GL280EBSARY, GL280EBSAW, GL280EBSAWY, GL280EBSAY, GL280EBSB, GL282EB93DA...(Other models you can see in the webshop)		

			
1			
Part No.	417640	Ref. No.	927245
description	heating element 3000W 230V L 455mm W 212mm \varnothing 28mm thread M15x1 heating circuits 1 screw		
For models:	CLEAN-160, CLEAN-220, CLEAN-270, CLEAN-271, CLEAN-361, CLEAN-361P, CLEAN-471, CLEAN-471P		

			
1			
Part No.	417526	Ref. No.	DRE1
description	heating element 4000W 220V L 475mm W 350mm \varnothing 28mm thread M15x1 connection M4 connection length 33mm dry heating element heating circuits 1 2 hole fixing		

immersion heating elements

3 hole flange \varnothing 38.5mm

			
1			
Part No.	418642	Ref. No.	230113
description	heating element 2600W 230V mounting \varnothing 38.5mm heating circuits 1 L 260mm W 33mm H 24mm number of thermostat sleeves 1 thermostat sleeves \varnothing 7mm length thermostat sleeves 175mm thermostat sleeve eccentric, non clinging tube \varnothing 6.5mm hole distance 57mm 3 hole flange connection male faston 6.3mm immersion heater		
For models:	913289, 913290, 913291, 913292, 913356, 913357, 913363, 913364, 913372, 913373, 913374, 913375, 913376, 913377, 913416, 913418, 913435, 913544, 913545, 913665, 913666, 913667, 913668, 913685, 913771, 913772, 913773, 913774, 913832, 913837, 913911, 913912, 913948, 913950, 913977, 913984, 913990, 914165, 914166, 914167, 914168, 914206, 914214, 914316, 914317, 914355, 914386, 914387, 914388, 914389...(Other models you can see in the webshop)		
accessories for	418642		
		Part No.	532577
		Ref. No.	—
	O-ring EPDM thickness 5.34mm ID \varnothing 40.65mm Qty 1 pcs		

3 hole flange \varnothing 47.5mm









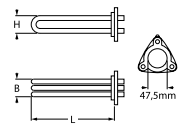



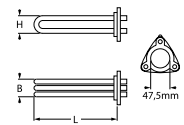


			
1			
Part No.	415001	Ref. No.	230013 230014 230034 230081
description	heating element 4500W 230V mounting \varnothing 47.5mm heating circuits 3 L 316mm W 35mm H 34mm number of thermostat sleeves 1 thermostat sleeves \varnothing 7mm length thermostat sleeves 180mm thermostat sleeve eccentric, non clinging tube \varnothing 6.3mm hole distance 62mm hole \varnothing 8mm connection M4 3 hole flange immersion heater		
For models:	10, 12, 14, 22F, 22R, 40F, 440F, 44F, 510F, 510FD, 66, 913297, 913298, 913299, 913300, 913360, 913361, 913391, 913392, 913546, 913547, 913578, 913611, 913684, 913932, 913933, 914318, 914319, 914326, 914331, 914338, 914406, 914431, 914517, 914545, 914688, 914979, 915140, 915248, CLEAN-100, CLEAN-120, CLEAN-3, E.50, E.51, E.52, E.55, E1, E10, E100, E110...(Other models you can see in the webshop)		
spare parts for	415001		
		Part No.	510408
		Ref. No.	456002 456079
	O-ring EPDM thickness 5.34mm ID \varnothing 47mm Qty 1 pcs		


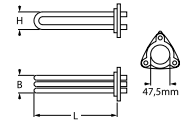

Table continues overleaf



accessories for	415001		
	Part No.	510562	Ref. No. —
	O-ring silicone thickness 5.34mm ID ø 47mm Qty 1 pcs		
	Part No.	521103	Ref. No. —
	nut thread M4 H 3mm WS 7 brass Qty 20 pcs		
	Part No.	521104	Ref. No. —
	washer ID ø 4.3mm ED ø 8mm thickness 0.5mm brass Qty 20 pcs for thread M4		
	Part No.	560111	Ref. No. —
	plain washer ID ø 4.3mm ED ø 9mm thickness 0.8mm SS Qty 20 pcs DIN 125A for thread M4		
	Part No.	560131	Ref. No. —
	hexagonal nut thread M4 H 3.2mm WS 7 SS DIN/ISO DIN 934 / ISO 4032/8673 Qty 20 pcs		

			
1			
Part No.	417440	Ref. No.	230111
description	heating element 4900W 230V mounting ø 47.5mm heating circuits 3 L 330mm W 32mm H 34mm number of thermostat sleeves 1 thermostat sleeves ø 7mm length thermostat sleeves 177mm thermostat sleeve not clinging tube ø 6.5mm hole distance 62mm hole ø 8mm connection M4 3 hole flange immersion heater		
For models:	913913, 913914, 914284, 914356, 914400, 914401, 914402, 914403, 914404, 914405, 914449, 914642, 914909, 915136, 915137, 915150, 915151, 915152, 915154, 915155, 915160, 915161, 915162, 915166, 915167, 915168, 915175, 915176, 915177, 915319, 915338, 915341, 915348, 915418, 915419, 915420, 915421, 915479, 915483, 915484, 915492, 915493, 915528, 915537, 915538, 915539, 915540, 915547, 915558, 915635...(Other models you can see in the webshop)		
accessories for	417440		
	Part No.	510408	Ref. No. 456002 456079
	O-ring EPDM thickness 5.34mm ID ø 47mm Qty 1 pcs		
	Part No.	510562	Ref. No. —
	O-ring silicone thickness 5.34mm ID ø 47mm Qty 1 pcs		

			
1			
Part No.	416240	Ref. No.	230083 230083C
description	heating element 6545W 230/400V mounting ø 48mm heating circuits 3 L 355mm W 31mm H 37mm number of thermostat sleeves 1 thermostat sleeves ø 7mm length thermostat sleeves 175mm thermostat sleeve upper centre not clinging tube ø 6.5mm hole distance 63mm hole ø 10mm connection M4 3 hole flange immersion heater		
For models:	80, 914380, 914436, 915747, 915817, 916045, A3EB, A3EBD, A3EBDA-KRKYK, A3EBDAKWK, A3EBDBKWK, A3EBDRKYK, A3EBDWK, A3EBDYK, A3EBSAK, A3EBSAKRK, A3EBSAKWK, A3EBSBKWKYK, A3EBSEKWK, A3EBSWK, A4EBT, A4EBTSAK, CE78HZ23, E.60, E78, E78HP, F85, F85P, FAST-161+PA-220-60-1, Fast161+PA-220-60-1, GL280EB, GL280EB23, GL280EB23DAR, GL280EB23HZ, GL280EB23HZDY, GL280EBD, GL280EBDA, GL280EBDAE, GL280EBDAR, GL280EBDARY, GL280EBDAW, GL280EBDAWY, GL280EBDAY, GL280EBDB, GL280EBDBR, GL280EBDBW, GL280EBDWY, GL280EBDY, GL280EBS, GL280EBSA... (Other models you can see in the webshop)		
accessories for	416240		
	Part No.	510408	Ref. No. 456002 456079
	O-ring EPDM thickness 5.34mm ID ø 47mm Qty 1 pcs		
	Part No.	510562	Ref. No. —
	O-ring silicone thickness 5.34mm ID ø 47mm Qty 1 pcs		

			
1			
Part No.	419043	Ref. No.	230117
description	heating element 7600W 400V mounting ø 47.5mm heating circuits 3 L 330mm W 40mm H 35mm number of thermostat sleeves 1 thermostat sleeves ø 7.5mm length thermostat sleeves 180mm thermostat sleeve eccentric, non clinging tube ø 8.5mm hole distance 63mm hole ø 10mm connection length 25mm connection M4 3 hole flange immersion heater		
For models:	915157, 915158, 915166, 915167, 915168, 915172, 915173, 915285, 915348, 915420, 915421, 915422, 915479, 915494, 915495, 915496, 915497, 915547, 915558, 915635, 915747, 916054, 916067, 916068, 916069, 916079, 916080, 916209, 916367, 916368, 916417, 916420, 916421, 916422, 916423, 916424, 916686, 916760, 916802, 916885, NG281, NG281CDD, NG281HZ23, NG281HZ23DD, NG38123, NG38123TERMO, NG381DDHZ23, NG381DDPSHZ23, NIAGARA-261, Niagara-271-2...(Other models you can see in the webshop)		
accessories for	419043		
	Part No.	510408	Ref. No. 456002 456079
	O-ring EPDM thickness 5.34mm ID ø 47mm Qty 1 pcs		



1			
Part No.	416241	Ref. No.	230020 230020C 230095 REB230020C
description	heating element 8000W 230V mounting \varnothing 47.5mm heating circuits 3 L 355mm W 35mm H 35mm number of thermostat sleeves 1 thermostat sleeves \varnothing 7.5mm length thermostat sleeves 185mm thermostat sleeve not clinging tube \varnothing 6.3mm hole distance 64mm hole \varnothing 8mm connection M4 3 hole flange immersion heater		
For models:	81, 914380, 914436, 915729, 915747, A3EB, A3EBD, A3EBDAKRKYK, A3EBDAKWK, A3EBDBKWK, A3EBDRKYK, A3EBDVK, A3EBDYK, A3EBSAK, A3EBSAKRK, A3EBSAKWK, A3EBSBKWKYK, A3EBSEKWK, A3EBSWK, A4EB, A4EBD, A4EBDAKEKYK, A4EBDAKRK, A4EBDAKWK, A4EBDAKZK, A4EBDBKRK, A4EBDPKWYK, A4EBDRK, A4EBS, A4EBSAK, A4EBSAKCK, A4EBSAKEKYK, A4EBSAKRK, A4EBSAKRKP, A4EBSAKYK, A4EBSCK, A4EBT, A4EBTSAK, CLEAN-110, E.65, E110, E12, E120, E14, Fast180, Fast180-230V-3Ph-60Hz, Fast181, FAST-181, FAST-200, FAST-63...(Other models you can see in the webshop)		
accessories for	416241		
	Part No.	510093	Ref. No. 467002 69870
	protection cap		
	Part No.	510408	Ref. No. 456002 456079
	O-ring EPDM thickness 5.34mm ID \varnothing 47mm Qty 1 pcs		
	Part No.	510562	Ref. No. —
	O-ring silicone thickness 5.34mm ID \varnothing 47mm Qty 1 pcs		

1			
Part No.	416242	Ref. No.	80398 80398C
description	heating element 9500W 230V mounting \varnothing 47.5mm heating circuits 3 L 330mm W 35mm H 35mm number of thermostat sleeves 1 thermostat sleeves \varnothing 7mm length thermostat sleeves 175mm thermostat sleeve eccentric, non clinging tube \varnothing 8.5mm hole distance 72mm hole \varnothing 8/10mm connection M4 3 hole flange immersion heater		
For models:	80, 82, 914380, 914436, 915747, A5EB, A5EBD, A5EBDAKPKWK, A5EBDAKWK, A5EBDAKYK, A5EBDRK, A5EBS, A5EBSAKPKWK, A5EBSAKRK, A5EBSAKRKYK, A5EBSAKWK, A5EBSAKWKYK, A5EBSBKRPK, A5EBSBKWK, A5EBSRK, A5EBSYK, CGL74CABT, CNT800CH, Fast200, FAST-200, Fast93, GL280EB, GL280EB23, GL280EB23DAR, GL280EB23HZ, GL280EB23HZDY, GL280EBD, GL280EBDA, GL280EBDAE, GL280EBDAR, GL280EBDARY, GL280EBDAW, GL280EBDAWY, GL280EBDAY, GL280EBDB, GL280EBDBR, GL280EBDBW, GL280EBDWY, GL280EBDY, GL280EBS, GL280EBSA, GL280EBSAE, GL280EBSAEW, GL280EBSAEWY, GL280EBSAR...(Other models you can see in the webshop)		
spare parts for	416242		
	Part No.	510408	Ref. No. 456002 456079
	O-ring EPDM thickness 5.34mm ID \varnothing 47mm Qty 1 pcs		

1			
Part No.	415002	Ref. No.	230012
description	heating element 3000W 230V mounting \varnothing 47.5mm heating circuits 1 L 198mm W 35mm H 44mm number of thermostat sleeves 1 thermostat sleeves \varnothing 7mm length thermostat sleeves 175mm thermostat sleeve not clinging tube \varnothing 6.3mm hole distance 64mm hole \varnothing 8mm connection M4 3 hole flange immersion heater		
For models:	21F, 21FD, 21R, 21RD, 22F, 22R, 25F, 25FD, 25R, 25RD, 30F, 30FD, 30R, 30RD, 31F, 31FD, 31R, 31RD, 40F, 44F, S621, S623, S624, S626, S631, S633, S634, S636		
accessories for	415002		
	Part No.	510408	Ref. No. 456002 456079
	O-ring EPDM thickness 5.34mm ID \varnothing 47mm Qty 1 pcs		
	Part No.	510562	Ref. No. —
	O-ring silicone thickness 5.34mm ID \varnothing 47mm Qty 1 pcs		
	Part No.	521103	Ref. No. —
	nut thread M4 H 3mm WS 7 brass Qty 20 pcs		
	Part No.	521104	Ref. No. —
	washer ID \varnothing 4.3mm ED \varnothing 8mm thickness 0.5mm brass Qty 20 pcs for thread M4		
	Part No.	560111	Ref. No. —
	plain washer ID \varnothing 4.3mm ED \varnothing 9mm thickness 0.8mm SS Qty 20 pcs DIN 125A for thread M4		
	Part No.	560131	Ref. No. —
	hexagonal nut thread M4 H 3.2mm WS 7 SS DIN/ISO DIN 934 / ISO 4032/8673 Qty 20 pcs		

3 hole flange \varnothing 57.5mm

1			
Part No.	418871	Ref. No.	927026 927276
description	heating element 10000W 230V mounting \varnothing 57.5mm heating circuits 3 L 375mm W 40mm H 33mm number of thermostat sleeves 1 thermostat sleeves \varnothing 7mm length thermostat sleeves 225mm thermostat sleeve upper centre not clinging tube \varnothing 6.3mm hole distance 73mm hole \varnothing 8mm connection length 24mm		
For models:	161, 221, 271, 272, 362, CLEAN-160, CLEAN-161, CLEAN-220, CLEAN-221, CLEAN-270, CLEAN-271, CLEAN-272, CLEAN-361, CLEAN-361P, CLEAN-362, CLEAN-471, CLEAN-471P		
accessories for	418871		
	Part No.	510409	Ref. No. 929046
	O-ring EPDM thickness 5.34mm ID \varnothing 56.52mm Qty 1 pcs		



Part No.	415039	Ref. No.	927066 927280 DRB81C
description	heating element 8000W 230V mounting ϕ 57.5mm heating circuits 3 L 375mm W 41mm H 42mm number of thermostat sleeves 1 thermostat sleeves ϕ 7mm length thermostat sleeves 230mm thermostat sleeve upper centre not clinging tube ϕ 6mm hole distance 73mm hole ϕ 10mm connection length 30mm connection M4 3 hole flange immersion heater		
For models:	161, 221, 271, 272, 362, CLEAN-160, CLEAN-161, CLEAN-220, CLEAN-221, CLEAN-270, CLEAN-271, CLEAN-272, CLEAN-362		
spare parts for	415039		
	Part No.	510409	Ref. No. 929046
	O-ring EPDM thickness 5.34mm ID ϕ 56.52mm Qty 1 pcs		
accessories for	415039		
	Part No.	521103	Ref. No. —
	nut thread M4 H 3mm WS 7 brass Qty 20 pcs		
	Part No.	521104	Ref. No. —
	washer ID ϕ 4.3mm ED ϕ 8mm thickness 0.5mm brass Qty 20 pcs for thread M4		
	Part No.	560111	Ref. No. —
	plain washer ID ϕ 4.3mm ED ϕ 9mm thickness 0.8mm SS Qty 20 pcs DIN 125A for thread M4		
	Part No.	560131	Ref. No. —
	hexagonal nut thread M4 H 3.2mm WS 7 SS DIN/ISO DIN 934 / ISO 4032/8673 Qty 20 pcs		

with compression flange 50 x 26mm

Part No.	420332	Ref. No.	230107
description	heating element 600W 230V heating circuits 1 flange 50x26mm L 125mm W 48mm H 70mm tube ϕ 8.4mm connection male faston 6.3mm immersion heater compression flange		
For models:	913992, 913993, 914583, 914592, 914612, 914613, 915143, RIVER-40, RIVER-40-CRP, RIVER-44, RIVER-44-CRP, RIVER-44-CRP-ST, RIVER-44CRP-ST		
spare parts for	420332		
	Part No.	510387	Ref. No. 437086
	gasket L 46mm W 22mm ϕ mm EPDM for heating element for flange 50x26mm		
	Part No.	510388	Ref. No. —
	counterflange ϕ mm hole distancemm perforation ϕ mm L 43mm W 21mm SS for heating element for flange 50x26mm		



Part No.	416234	Ref. No.	230098
description	heating element 600W 230V heating circuits 1 flange 50x26mm L 160mm W 45mm H 27mm tube ϕ 8.8mm connection male faston 6.3mm connection length 40mm immersion heater compression flange		
For models:	913289, 913290, 913291, 913292, 913356, 913357, 913372, 913373, 913374, 913375, 913416, 913435, 913544, 913545, 913665, 913666, 913667, 913668, 913685, 913771, 913772, 913773, 913774, 913832, 913837, 913911, 913912, 913948, 913950, 913977, 913984, 913990, 914165, 914166, 914206, 914214, 914316, 914317, 914355, 914386, 914387, 914388, 914389, 914390, 914391, 914392, 914393, 914394, 914395, 914396...(Other models you can see in the webshop)		
accessories for	416234		
	Part No.	510387	Ref. No. 437086
	gasket L 46mm W 22mm ϕ mm EPDM for heating element for flange 50x26mm		
	Part No.	510388	Ref. No. —
	counterflange ϕ mm hole distancemm perforation ϕ mm L 43mm W 21mm SS for heating element for flange 50x26mm		



Part No.	420333	Ref. No.	230103
description	heating element 2450W 220/240V heating circuits 1 compression flange flange 50x26mm L 295mm W 89mm H 27mm L1 35mm L2 260mm W1 59mm W2 30mm connection male faston 6.3mm tube ϕ 6.2mm immersion heater for tank		
spare parts for	420333		
	Part No.	510387	Ref. No. 437086
	gasket L 46mm W 22mm ϕ mm EPDM for heating element for flange 50x26mm		
	Part No.	510388	Ref. No. —
	counterflange ϕ mm hole distancemm perforation ϕ mm L 43mm W 21mm SS for heating element for flange 50x26mm		




			
1			
Part No.	420331	Ref. No.	230112
description	heating element 1400W 230V compression flange flange 50x26mm L 160mm heating circuits 1 H 29mm W 190mm connection male faston 6.3mm immersion heater tube ø 8.4mm		
For models:	915150, 915151, 915152, 915154, 915155, 915160, 915161, 915162, 915166, 915167, 915168, 915172, 915173, 915175, 915176, 915177, 915285, 915319, 915338, 915341, 915348, 915418, 915419, 915420, 915421, 915422, 915479, 915492, 915493, 915496, 915497, 915547, 915558, 915635, 915663, 915747, 916054, CNT800CH, FAST-73, NG281, NG281HP, NIAGARA-251, Niagara-261, NIAGARA-281, NIAGARA-281HP, PLUVIA-260, Pluvia-270, PLUVIA-280, Pluvia280-230V-3PH-60HZ, PV280...(Other models you can see in the webshop)		
spare parts for	420331		
	Part No.	510387	Ref. No. 437086
gasket L 46mm W 22mm ømm EPDM for heating element for flange 50x26mm			


with compression flange 70 x 26mm

			
1			
Part No.	415009	Ref. No.	230057 230058 230087
description	heating element 2500W 230V heating circuits 1 flange 70x26mm L 280mm W 51mm Hmm tube ø 6.3mm connection M4 immersion heater compression flange		
For models:	11F, 11FD, 11F-DVGW, 11R, 11RD, 350F, 350FD, 350R, 350RD, 35-ELECTRONIC, 35F, 35FD, 35R, 35RD, 400F, 400FD, 400R, 400RD, 40-ELECTRONIC, 40F, 40FD, 40R, 40RD, 45, 450, 67F, 67R, E.35, E.40, E.41, E.42, E.45		
accessories for	415009		
	Part No.	521128	Ref. No. 437048
gasket L 66mm W 21mm ømm for heating element suitable for ELETTROBAR, WOLK			

			
1			
Part No.	415000	Ref. No.	230075 230076 230088
description	heating element 2900W 230V heating circuits 1 flange 70x26mm L 272mm W 51mm Hmm tube ø 6.3mm connection M4 immersion heater compression flange		
For models:	050F, 050FP, 46, 460, 500F, 500FD, 50-ELECTRONIC, 50F, 50FD, 510F, 510FD, 913297, 913298, 913299, 913300, 913360, 913361, 913391, 913392, 913546, 913547, 913578, 913611, 913684, 913932, 913933, 914331, 914517, 914545, 914688, 914979, 915140, 915248, E.46, E.50, E.51, GSP50, GSP50P, LF50, LF55, MC501E, MC501EP, MC501S, MC501SP, P500		
accessories for	415000		
	Part No.	521128	Ref. No. 437048
gasket L 66mm W 21mm ømm for heating element suitable for ELETTROBAR, WOLK			

with expansion flange 70 x 18mm

			
1			
Part No.	416239	Ref. No.	230100
description	heating element 2600W 230V heating circuits 1 flange 70x18mm L 270mm W 65mm connection male faston 6.3mm tube ø 8.5mm immersion heater expansion flange		
For models:	913289, 913290, 913771, 913772, 913832, 914386, 914387, 914388, 914390, 914391, 914692, 914693, 914694, 914703, 914870, E.35, E.35H, E.40, E.40H, E.45, MC201CL, MINIBAR, MISTRAL-40, NIAGARA-35, NIAGARA-40, NIAGARA-45, S280		

			
1			
Part No.	416243	Ref. No.	230106
description	heating element 7600W 230V heating circuits 3 flange 70x18mm L 390mm W 60mm H 13mm connection male faston 6.3mm tube ø 6.3mm immersion heater expansion flange INCOLOY-800		
For models:	2312-007, 914100, 914101, 914339, 914342, 914343, 914624, 914625, 914626, 914627, 914850, 914851, 914854, RIVER-48, RIVER-50, RIVER-54, RIVER-61		

with round flange ø57.5mm










			
1			
Part No.	415038	Ref. No.	929040
description	heating element 5000W 230V heating circuits 3 mounting ø 57.5mm L 373mm W 44mm H 40mm round flange connection M4 immersion heater tube ø 6.3mm connection length 19mm thermostat sleeves ø 7mm number of thermostat sleeves 1 length thermostat sleeves 328mm thermostat sleeve not clinging		
For models:	55		
spare parts for	415038		
	Part No.	510409	Ref. No. 929046
O-ring EPDM thickness 5.34mm ID ø 56.52mm Qty 1 pcs			





Table continues overleaf





accessories for		415038		
Part No.		521103	Ref. No.	—
	nut thread M4 H 3mm WS 7 brass Qty 20 pcs			
	washer ID ø 4.3mm ED ø 8mm thickness 0.5mm brass Qty 20 pcs for thread M4	521104	Ref. No.	—
	tension strap H 10mm L 21mm W 10mm hole ø 6.5mm for heating element	550002	Ref. No.	—
	plain washer ID ø 4.3mm ED ø 9mm thickness 0.8mm SS Qty 20 pcs DIN 125A for thread M4	560111	Ref. No.	—
	hexagonal nut thread M4 H 3.2mm WS 7 SS DIN/ISO DIN 934 / ISO 4032/8673 Qty 20 pcs	560131	Ref. No.	—

accessories for		415042		
Part No.		520232	Ref. No.	—
	nut thread 1¼" H 5mm nickel-plated brass WS 47 Qty 1 pcs			
	nut thread M4 H 3mm WS 7 brass Qty 20 pcs	521103	Ref. No.	—
	washer ID ø 4.3mm ED ø 8mm thickness 0.5mm brass Qty 20 pcs for thread M4	521104	Ref. No.	—
	flat gasket PTFE ED ø 53mm ID ø 42.5mm thickness 3mm Qty 1 pcs equiv. no. 12001/02286 suitable for Astoria/Aurora/Brasilia/Wega	528021	Ref. No.	—
	plain washer ID ø 4.3mm ED ø 9mm thickness 0.8mm SS Qty 20 pcs DIN 125A for thread M4	560111	Ref. No.	—
	hexagonal nut thread M4 H 3.2mm WS 7 SS DIN/ISO DIN 934 / ISO 4032/8673 Qty 20 pcs	560131	Ref. No.	—

1¼"			
	1		
Part No.	Ref. No.	415005	230002
description	heating element 2000W 230V heating circuits 1 thread 1¼" L 170mm W 32mm H 22mm tube ø 6.2mm connection M4		
For models:	R497, R499, R501, R503, R505, R507, S641, S643		
accessories for		415005	
	flat gasket fibre ED ø 56mm ID ø 42mm thickness 2mm for thread 1¼" Qty 1 pcs	510405	Ref. No. 437028
	nut thread 1¼" H 5mm nickel-plated brass WS 47 Qty 1 pcs	520232	Ref. No. —
	nut thread M4 H 3mm WS 7 brass Qty 20 pcs	521103	Ref. No. —
	washer ID ø 4.3mm ED ø 8mm thickness 0.5mm brass Qty 20 pcs for thread M4	521104	Ref. No. —
	flat gasket PTFE ED ø 53mm ID ø 42.5mm thickness 3mm Qty 1 pcs equiv. no. 12001/02286 suitable for Astoria/Aurora/Brasilia/Wega	528021	Ref. No. —
	plain washer ID ø 4.3mm ED ø 9mm thickness 0.8mm SS Qty 20 pcs DIN 125A for thread M4	560111	Ref. No. —
	hexagonal nut thread M4 H 3.2mm WS 7 SS DIN/ISO DIN 934 / ISO 4032/8673 Qty 20 pcs	560131	Ref. No. —

1			
	1		
Part No.	Ref. No.	415011	230007 230021
description	heating element 3000W 230V heating circuits 1 thread 1¼" L 285mm W 24mm H 20mm tube ø 6.5mm connection M4 immersion heater connection length 26mm flange with thread WS 54		
For models:	35F, 35FD, 35R, 35RD, R509, R511, R704		
accessories for		415011	
	flat gasket fibre ED ø 56mm ID ø 42mm thickness 2mm for thread 1¼" Qty 1 pcs	510405	Ref. No. 437028
	nut thread 1¼" H 5mm nickel-plated brass WS 47 Qty 1 pcs	520232	Ref. No. —
	flat gasket PTFE ED ø 53mm ID ø 42.5mm thickness 3mm Qty 1 pcs equiv. no. 12001/02286 suitable for Astoria/Aurora/Brasilia/Wega	528021	Ref. No. —

1			
	1		
Part No.	Ref. No.	415042	230003
description	heating element 2200W 230V heating circuits 1 thread 1¼" L 165mm W 35mm H 26mm tube ø 6.3mm connection M4 immersion heater flange with thread		
spare parts for		415042	
	flat gasket fibre ED ø 56mm ID ø 42mm thickness 2mm for thread 1¼" Qty 1 pcs	510405	Ref. No. 437028











1½"			
	1		
Part No.	Ref. No.	415004	230008 230026
description	heating element 3000W 230/380V heating circuits 3 thread 1½" L 300mm W 32mm H 34mm tube ø 6.3mm connection M4 immersion heater connection length 20mm flange with thread		
For models:	R708, S870		
accessories for		415004	
	flat gasket fibre ED ø 60mm ID ø 48mm thickness 3mm for thread 1½" Qty 1 pcs	510406	Ref. No. —
	gasket copper ED ø 55mm ID ø 48mm thickness 2.2mm Centellen for thread 1½"	510424	Ref. No. —
	reducer thread 2" ET - 1½" IT brass	520211	Ref. No. —











Table continues overleaf



accessories for	415004			
	Part No.	520212	Ref. No.	—
	hexagonal nut thread 1½" brass WS 60 H 8mm			
	Part No.	521103	Ref. No.	—
	nut thread M4 H 3mm WS 7 brass Qty 20 pcs			
	Part No.	521104	Ref. No.	—
	washer ID ø 4.3mm ED ø 8mm thickness 0.5mm brass Qty 20 pcs for thread M4			
	Part No.	550361	Ref. No.	—
	blind flange ø 58mm thread 1½"			
	Part No.	560111	Ref. No.	—
	plain washer ID ø 4.3mm ED ø 9mm thickness 0.8mm SS Qty 20 pcs DIN 125A for thread M4			
	Part No.	560131	Ref. No.	—
	hexagonal nut thread M4 H 3.2mm WS 7 SS DIN/ISO DIN 934 / ISO 4032/8673 Qty 20 pcs			

	1		
Part No.	415666	Ref. No.	230077
description	heating element 1100W 230V heating circuits 1 L 151mm W 56mm H 35mm thread 1/8" mounting distance 50mm tube ø 6.3mm 2 hole fixing immersion heater connection male faston 6.3mm		
For models:	350F, 350FD, 350R, 350RD, 400F, 400FD, 400R, 400RD, 40F, 40FD, 40R, 40RD		

	1			
Part No.	415008	Ref. No.	230016	
description	heating element 2000W 230V heating circuits 1 L 140mm W 173mm H 35mm thread M14x1.5 mounting distance 33mm tube ø 4.2mm 2 hole fixing connection length 15mm immersion heater L1 14mm L2 118mm W1 128mm W2 45mm			
For models:	R495			
accessories for	415008			
	Part No.	510417	Ref. No.	437002 437024
	flat gasket fibre ED ø 20mm ID ø 14mm thickness 2mm Qty 1 pcs			
	Part No.	520228	Ref. No.	—
	tooth lock washer ID ø 15.3mm ED ø 24mm steel Qty 1 pcs for thread M14			
	Part No.	520230	Ref. No.	—
	nut thread M14x1.5 H 5mm WS 19 zinc-coated steel Qty 1 pcs			
	Part No.	521101	Ref. No.	—
	nut thread M14x1.5 H 5mm WS 19 SS Qty 1 pcs			
	Part No.	550262	Ref. No.	—
	flat gasket copper ED ø 20mm ID ø 14mm thickness 2mm			

	1			
Part No.	415010	Ref. No.	230009 230017 230044	
description	heating element 2000W 230V heating circuits 1 L 260mm W 125mm H 20mm L1 110mm L2 150mm W1 42mm W2 83mm thread M10x1 mounting distance 70mm tube ø 6.5mm connection M4 immersion heater 2 hole fixing			
For models:	11F, 11FD, 11F-DVGW, 11R, 11RD, 21F, 21FD, 21R, 21RD, 22F, 22R, 25F, 25FD, 25R, 25RD, 30F, 30FD, 30R, 30RD, 31F, 31FD, 31R, 31RD, 40F, 440F, 44F, S621, S623, S624, S626, S631, S633, S634, S636			
spare parts for	415010			
	Part No.	510416	Ref. No.	437022
	flat gasket fibre ED ø 19mm ID ø 10.5mm thickness 1.5mm for thread M10 Qty 1 pcs			
accessories for	415010			
	Part No.	504306	Ref. No.	—
	gasket fibre ED ø 16mm ID ø 10mm thickness 2mm Qty 1 pcs			
	Part No.	510893	Ref. No.	456015
	O-ring EPDM thickness 2.62mm ID ø 9.92mm Qty 1 pcs			
	Part No.	520231	Ref. No.	—
	nut thread M10x1 H 6mm WS 14 zinc-coated steel Qty 1 pcs			
	Part No.	521103	Ref. No.	—
	nut thread M4 H 3mm WS 7 brass Qty 20 pcs			
	Part No.	521104	Ref. No.	—
	washer ID ø 4.3mm ED ø 8mm thickness 0.5mm brass Qty 20 pcs for thread M4			
	Part No.	521129	Ref. No.	—
	nut thread M10 H 6mm SS WS 17 Qty 1 pcs DIN/ISO DIN 439			
	Part No.	560111	Ref. No.	—
	plain washer ID ø 4.3mm ED ø 9mm thickness 0.8mm SS Qty 20 pcs DIN 125A for thread M4			
	Part No.	560131	Ref. No.	—
	hexagonal nut thread M4 H 3.2mm WS 7 SS DIN/ISO DIN 934 / ISO 4032/8673 Qty 20 pcs			
























	1			
Part No.	415664	Ref. No.	230006 230085	
description	heating element 2250W 230V heating circuits 1 L 300mm W 90mm H 25mm thread 1/8" mounting distance 64mm tube ø 6.3mm connection M4 immersion heater 2 hole fixing			
For models:	11F, 11FD, 11R, 11RD, 31F, 31FD, 31R, 31RD, 67F, 67R, 913363, 913364, 913376, 913377, 913418, 914167, 914168, 914398, 914399, 914443, 914943, 915695, 915696, 915819, E.41, E.42, E.45, E.41, Fast145, FAST-145, Fast145D, FAST-145D, NIAGARA-45			
accessories for	415664			
	Part No.	510893	Ref. No.	456015
	O-ring EPDM thickness 2.62mm ID ø 9.92mm Qty 1 pcs			


Table continues overleaf



accessories for 415664	
	Part No. 521103 Ref. No. — nut thread M4 H 3mm WS 7 brass Qty 20 pcs
	Part No. 521104 Ref. No. — washer ID ø 4.3mm ED ø 8mm thickness 0.5mm brass Qty 20 pcs for thread M4
	Part No. 521129 Ref. No. — nut thread M10 H 6mm SS WS 17 Qty 1 pcs DIN/ISO DIN 439
	Part No. 560111 Ref. No. — plain washer ID ø 4.3mm ED ø 9mm thickness 0.8mm SS Qty 20 pcs DIN 125A for thread M4
	Part No. 560131 Ref. No. — hexagonal nut thread M4 H 3.2mm WS 7 SS DIN/ISO DIN 934 / ISO 4032/8673 Qty 20 pcs

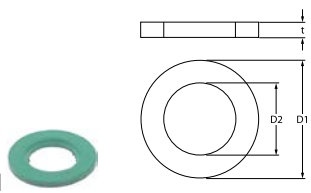
 <p>1</p>			
Part No.	415665	Ref. No.	230060 230061 230086
description	heating element 2750/3250W 220/240V heating circuits 1 L 380mm W 110mm H 30mm thread M10x1 mounting distance 75mm tube ø 6.5mm connection M4 immersion heater 2 hole fixing		
For models:	050F, 050FP, 10, 12, 14, 22F, 22R, 2312-001, 2312-002, 40F, 440F, 44F, 46, 460, 500F, 500FD, 50F, 50FD, 510F, 510FD, 913297, 913298, 913299, 913300, 913360, 913361, 913391, 913392, 913546, 913547, 913578, 913611, 913684, 913913, 913914, 913932, 913933, 914284, 914318, 914319, 914326, 914331, 914338, 914356, 914400, 914401, 914402, 914403, 914404, 914405...(Other models you can see in the webshop)		
spare parts for	415665		
	Part No. 510893	Ref. No.	456015
	O-ring EPDM thickness 2.62mm ID ø 9.92mm Qty 1 pcs		
accessories for	415665		
	Part No. 510416	Ref. No.	437022
	flat gasket fibre ED ø 19mm ID ø 10.5mm thickness 1.5mm for thread M10 Qty 1 pcs		
	Part No. 520231	Ref. No.	—
	nut thread M10x1 H 6mm WS 14 zinc-coated steel Qty 1 pcs		
	Part No. 520876	Ref. No.	463007
	protection cap for heating element ø 11.5mm H 32mm W 25mm plastic		
	Part No. 521103	Ref. No.	—
	nut thread M4 H 3mm WS 7 brass Qty 20 pcs		
	Part No. 521104	Ref. No.	—
	washer ID ø 4.3mm ED ø 8mm thickness 0.5mm brass Qty 20 pcs for thread M4		
	Part No. 521129	Ref. No.	—
	nut thread M10 H 6mm SS WS 17 Qty 1 pcs DIN/ISO DIN 439		
	Part No. 560111	Ref. No.	—
	plain washer ID ø 4.3mm ED ø 9mm thickness 0.8mm SS Qty 20 pcs DIN 125A for thread M4		
	Part No. 560131	Ref. No.	—
	hexagonal nut thread M4 H 3.2mm WS 7 SS DIN/ISO DIN 934 / ISO 4032/8673 Qty 20 pcs		

 <p>1</p>			
Part No.	416235	Ref. No.	70562 80360 80677
description	heating element 3000W 230V heating circuits 1 L 320mm W 50mm H 40mm thread M10x1 mounting distance 44mm tube ø 6.3mm connection male faston 6.3mm 2 hole fixing L1 32mm L2 288mm		
For models:	80, 81, 82, CE78HZ23, CGL74CABT, E78, E78HP, Fast181, Fast181-230V-3Ph-60Hz, Fast181-400V-3NPh-60Hz, HM1, KLP105EB, LP105DDDTEB, LP105DDDTEBN, LP105EB, LP60, NG292HZ, NG381L, NG381LC, NG381LCFUR, NG381LDDPS, NIAGARA-271, Niagara-283A, Niagara-283L-2, Niagara-292-400V-3Ph-60Hz, Niagara-381L, Niagara-381LC, RIVER-282, River-282L-2, River-282LS-2TDE, River-285, River-295P, River-296P, River-382L, River-382L-230V-3Ph-50Hz, River-382LNRG, River-382LTDE, River-482, RIVER-71, RIVER-78, RIVER-80, River-81, River-81CRP, RIVER-81-CRP, RIVER-82, RIVER-82CRP, RIVER-82-CRP, RIVER-E78, RIVER-HL-81, RIVER-HL-82...(Other models you can see in the webshop)		
spare parts for	416235		
	Part No. 510893	Ref. No.	456015
	O-ring EPDM thickness 2.62mm ID ø 9.92mm Qty 1 pcs		
accessories for	416235		
	Part No. 510416	Ref. No.	437022
	flat gasket fibre ED ø 19mm ID ø 10.5mm thickness 1.5mm for thread M10 Qty 1 pcs		
	Part No. 510893	Ref. No.	456015
	O-ring EPDM thickness 2.62mm ID ø 9.92mm Qty 1 pcs		
	Part No. 521129	Ref. No.	—
	nut thread M10 H 6mm SS WS 17 Qty 1 pcs DIN/ISO DIN 439		
	Part No. 560192	Ref. No.	—
	tooth lock washer ID ø 10.4mm ED ø 18mm SS DIN/ISO DIN 6798A Qty 1 pcs for thread M10		

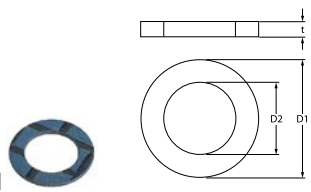
 <p>1</p>			
Part No.	420334	Ref. No.	41211 C.41211
description	heating element 3000W 230V heating circuits 1 L 380mm W 87mm H 26mm thread M10x1 mounting distance 81mm tube ø 6.3mm connection M4 immersion heater 2 hole fixing		
For models:	U61, U61E, U61H, U61HE		

**foil heating elements**

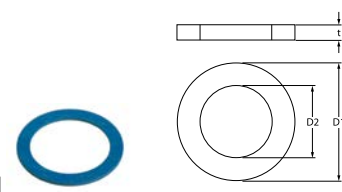
Part No.	416236	Ref. No.	230080.AG
description	foil heating element L 130mm W 84mm 130W 230V t.max. 175°C without temperature limiter silicone cable length 200mm thickness 1mm		
For models:	CLEAN-3, RIVER-43		

accessories**sealing washers****fibre gaskets**


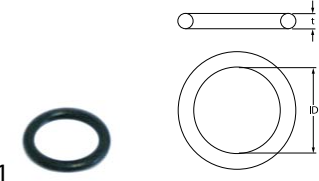
Part No.	510416	Ref. No.	437022
description	flat gasket fibre ED ø 19mm ID ø 10.5mm thickness 1.5mm for thread M10 Qty 1 pcs		
For models:	S621, S623, S624, S626, S631, S633, S634, S636		



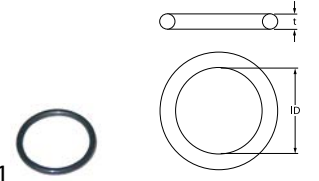
Part No.	510417	Ref. No.	437002 437024
description	flat gasket fibre ED ø 20mm ID ø 14mm thickness 2mm Qty 1 pcs		
For models:	11F, 11FD, 11F-DVGW, 11R, 11RD, 12, 14, 21F, 21FD, 21R, 21RD, 22F, 22R, 25F, 25FD, 25R, 25RD, 30F, 30FD, 30R, 30RD, 31F, 31FD, 31R, 31RD, 40F, 440F, 44F, 450, 46, 460, 500F, 500FD, 50F, 50FD, 510F, 510FD, CLEAN-100, CLEAN-110, CLEAN-120, E.45, E.46, E.50, E.51, E.52, E1, E10, E100, E110, E12...(Other models you can see in the webshop)		



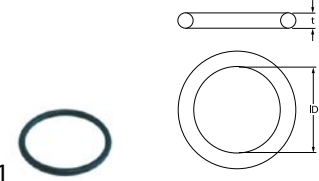
Part No.	510405	Ref. No.	437028
description	flat gasket fibre ED ø 56mm ID ø 42mm thickness 2mm for thread 1¼" Qty 1 pcs		
For models:	R497, R499, R501, R503, R505, R507, R509, R511, R704, S641, S643		

O-rings


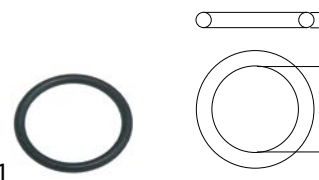
Part No.	510893	Ref. No.	456015
description	O-ring EPDM thickness 2.62mm ID ø 9.92mm Qty 1 pcs		
For models:	050F, 050FP, 2312-001, 2312-002, 31F, 31FD, 31R, 31RD, 500F, 500FD, 50F, 50FD, 510F, 510FD, 67F, 67R, 913297, 913298, 913299, 913300, 913360, 913361, 913363, 913364, 913376, 913377, 913391, 913392, 913418, 913546, 913547, 913578, 913611, 913684, 913913, 913914, 913932, 913933, 914167, 914168, 914284, 914318, 914319, 914326, 914331, 914338, 914356, 914398, 914399, 914400...(Other models you can see in the webshop)		



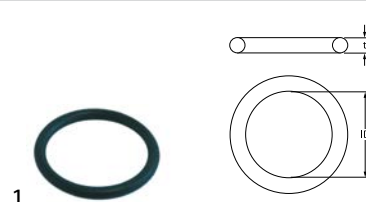
Part No.	510072	Ref. No.	456016
description	O-ring EPDM thickness 3.53mm ID ø 32.93mm Qty 1 pcs		
For models:	050F, 050FP, 10, 11F, 11FD, 11F-DVGW, 11R, 11RD, 21F, 21FD, 21R, 21RD, 22F, 22R, 25F, 25FD, 25R, 25RD, 30F, 30FD, 30R, 30RD, 31F, 31FD, 31R, 31RD, 350F, 350FD, 350R, 350RD, 35-ELECTRONIC, 35F, 35FD, 35R, 35RD, 400F, 400FD, 400R, 400RD, 40-ELECTRONIC, 40F, 40FD, 40R, 40RD, 440F, 44F, 45, 450, 46, 460...(Other models you can see in the webshop)		



Part No.	521120	Ref. No.	456075
description	O-ring EPDM thickness 5.34mm ID ø 37.47mm Qty 1 pcs		
For models:	913289, 913290, 913291, 913292, 913356, 913357, 913363, 913364, 913372, 913373, 913374, 913375, 913376, 913377, 913416, 913418, 913435, 913544, 913545, 913665, 913666, 913667, 913668, 913685, 913771, 913772, 913773, 913774, 913832, 913837, 913911, 913912, 913948, 913950, 913977, 913984, 913990, 914165, 914166, 914167, 914168, 914206, 914214, 914316, 914317, 914355, 914386, 914387, 914388, 914389...(Other models you can see in the webshop)		





Part No.	510408	Ref. No.	456002 456079
description	O-ring EPDM thickness 5.34mm ID ø 47mm Qty 1 pcs		
For models:	10, 12, 14, 21F, 21FD, 21R, 21RD, 22F, 22R, 25F, 25FD, 25R, 25RD, 30F, 30FD, 30R, 30RD, 31F, 31FD, 31R, 31RD, 40F, 440F, 44F, 50F, 50FD, 510F, 510FD, 66, 80, 81, 82, 913297, 913298, 913299, 913300, 913360, 913361, 913391, 913392, 913546, 913547, 913578, 913611, 913684, 913913, 913914, 913932, 913933, 913992...(Other models you can see in the webshop)		





Part No.	510410	Ref. No.	456008
description	O-ring EPDM thickness 5.34mm ID ø 75.57mm Qty 1 pcs		
For models:	66, S651, S651P, S653, S654, S655, S810, S815, S830, S835, S850, SR651		

flange gaskets




Part No.	510387	Ref. No.	437086
description	gasket L 46mm W 22mm ømm EPDM for heating element for flange 50x26mm		
For models:	913289, 913290, 913291, 913292, 913356, 913357, 913372, 913373, 913374, 913375, 913416, 913435, 913544, 913545, 913665, 913666, 913667, 913668, 913685, 913771, 913772, 913773, 913774, 913832, 913837, 913911, 913912, 913948, 913950, 913977, 913984, 913990, 913992, 913993, 914165, 914166, 914206, 914214, 914316, 914317, 914355, 914386, 914387, 914388, 914389, 914390, 914391, 914392, 914393, 914394...(Other models you can see in the webshop)		
accessories for	510387		
	Part No.	510388	Ref. No. —
	counterflange ømm hole distancemm perforation ømm L 43mm W 21mm SS for heating element for flange 50x26mm		




Part No.	521128	Ref. No.	437048
description	gasket L 66mm W 21mm ømm for heating element suitable for ELETTROBAR, WOLK		
For models:	050F, 050FP, 11F, 11FD, 11F-DVGW, 11R, 11RD, 2312-001, 2312-002, 350F, 350FD, 350R, 350RD, 35-ELECTRONIC, 35F, 35FD, 35R, 35RD, 400F, 400FD, 400R, 400RD, 40-ELECTRONIC, 40F, 40FD, 40R, 40RD, 46, 460, 500F, 500FD, 50-ELECTRONIC, 50F, 50FD, 510F, 510FD, 67F, 67R, 913297, 913298, 913299, 913300, 913360, 913361, 913391, 913392, 913546, 913547, 913578, 913611...(Other models you can see in the webshop)		


protection caps



Part No.	510084	Ref. No.	467001
description	protection cap		
For models:	66, S651, S651P, S653, S654, S655, S810, S815, S830, S835, S850, SR651		



Part No.	510093	Ref. No.	467002 69870
description	protection cap		
For models:	10, 12, 14, 21F, 21FD, 21R, 21RD, 22F, 22R, 25F, 25FD, 25R, 25RD, 30F, 30FD, 30R, 30RD, 31F, 31FD, 31R, 31RD, 40F, 440F, 44F, 510F, 510FD, 66, 913297, 913298, 913299, 913300, 913360, 913361, 913391, 913392, 913546, 913547, 913578, 913611, 913684, 913913, 913914, 913932, 913933, 913992, 913993, 914284, 914318, 914319, 914326...(Other models you can see in the webshop)		






Part No.	520876	Ref. No.	463007
description	protection cap for heating element ø 11.5mm H 32mm W 25mm plastic		
For models:	050F, 050FP, 10, 11F, 11FD, 11F-DVGW, 11R, 11RD, 12, 14, 22F, 22R, 2312-001, 2312-002, 31F, 31FD, 31R, 31RD, 350F, 350FD, 350R, 350RD, 35-ELECTRONIC, 35F, 35FD, 35R, 35RD, 400F, 400FD, 400R, 400RD, 40-ELECTRONIC, 40F, 40FD, 40R, 40RD, 440F, 44F, 45, 450, 46, 460, 500F, 500FD, 50-ELECTRONIC, 50F, 50FD, 510F, 510FD, 67F...(Other models you can see in the webshop)		

thermostats


bi-metal thermostats

safety bi-metal thermostats





Part No.	390233	Ref. No.	236039 926189
description	bi-metal safety thermostat hole distance 24mm switch-off temp. 110°C 1NC 1-pole 16A connection F6.3 2 hole fixing without holder		
For models:	050F, 050FP, 10, 11F, 11FD, 11R, 11RD, 12, 14, 22F, 2312-001, 2312-002, 2312-007, 31F, 31FD, 31R, 31RD, 350F, 350FD, 350R, 350RD, 35F, 35FD, 35R, 35RD, 400F, 400FD, 400R, 400RD, 40F, 40FD, 40R, 40RD, 440F, 44F, 45, 450, 46, 460, 500F, 500FD, 50F, 50FD, 510F, 510FD, 80, 81, 82, 913289, 913290...(Other models you can see in the webshop)		
accessories for	390233		
	Part No.	504736	Ref. No. —
	bracket for contact thermostat		
	Part No.	550388	Ref. No. 431006
	bracket for contact thermostat mounting distance 24.5mm mounting ø 3.8		





			
1			
Part No.	390318	Ref. No.	236047
description	bi-metal safety thermostat switch-off temp. 95°C 1-pole 2 hole fixing		
For models:	2312-009-CRP, 913289, 913290, 913291, 913292, 913356, 913357, 913363, 913364, 913372, 913373, 913374, 913375, 913376, 913377, 913416, 913435, 913544, 913545, 913665, 913666, 913667, 913668, 913685, 913771, 913772, 913773, 913774, 913832, 913837, 913911, 913912, 913913, 913948, 913950, 913977, 913984, 913990, 913992, 913993, 914165, 914166, 914206, 914214, 914284, 914316, 914317, 914355, 914386, 914387...(Other models you can see in the webshop)		

bi-metal thermostats

			
1			
Part No.	390301	Ref. No.	236035
description	bi-metal thermostat hole distance 23.8mm switch-off temp. 60°C 1NC 1-pole 16A connection F6.3 2 hole fixing		
For models:	350F, 350FD, 350R, 350RD, 400F, 400FD, 400R, 400RD, 913289, 913290, 913291, 913292, 913356, 913357, 913363, 913364, 913372, 913373, 913374, 913375, 913376, 913377, 913416, 913435, 913544, 913545, 913665, 913666, 913667, 913668, 913685, 913771, 913772, 913773, 913774, 913832, 913837, 913948, 914386, 914387, 914388, 914389, 914390, 914391, 914392, 914393, 914394, 914395, 914396, 914397...(Other models you can see in the webshop)		

			
1			
Part No.	390319	Ref. No.	236048
description	bi-metal thermostat hole distance 23.8mm switch-off temp. 80°C 1NC 1-pole 16A connection F6.3 2 hole fixing		
For models:	913289, 913290, 913291, 913292, 913356, 913357, 913372, 913373, 913374, 913375, 913416, 913435, 913544, 913545, 913665, 913666, 913667, 913668, 913685, 913771, 913772, 913773, 913774, 913832, 913837, 913948, 914386, 914387, 914388, 914389, 914390, 914391, 914392, 914393, 914394, 914395, 914396, 914397, 914441, 914442, 914515, 914537, 914547, 914683, 914689, 914692, 914693, 914694, 914703, 914863...(Other models you can see in the webshop)		

			
1			
Part No.	390504	Ref. No.	236052
description	bi-metal thermostat hole distance 23.8mm switch-off temp. 90°C 1NO 1-pole 16A 250V connection F6.3 2 hole fixing probe ø 16mm		
For models:	915150, 915151, 915152, 915154, 915155, 915160, 915161, 915162, 915166, 915167, 915168, 915172, 915173, 915175, 915319, 915348, 915418, 915419, 915420, 915421, 915422, 915479, 915492, 915493, 915496, 915497, 915547, 915558, 915635, 915663, 915747, 916020, 916021, 916024, 916025, 916026, 916027, 916030, 916031, 916045, 916054, 916068, 916069, 916080, 916201, 916202, 916203, 916204, 916205, 916206...(Other models you can see in the webshop)		



			
1			
Part No.	390129	Ref. No.	236056
description	bi-metal thermostat hole distance mm switch-off temp. 125°C 1NC 1-pole 16A connection F6.3 M4		
For models:	2312-007, 914100, 914101, 914339, 914342, 914343, 914624, 914625, 914626, 914627, 914628, 914850, 914851, 914854, 914944, PS-60, RIVER-48, RIVER-54, RIVER-54CRP, River-54-CRP-s.p.		

control and safety thermostats


EGO

control thermostats

55.10/19_ series

			
1			
Part No.	390003	Ref. No.	236002 236007 236008
description	thermostat t.max. 90°C temperature range 30-90°C 1-pole 1CO 16A probe ø 15mm probe L 22.5mm capillary pipe 1700mm capillary pipe isolated mm gland nut shaft ø 6x4.6mm shaft L 16mm shaft position upper shaft position rotation 270° with knob probe		
For models:	R495, R497, R499, R708, S641, S643		
accessories for	390003		
		Part No.	510165 Ref. No. —
	gasket for thermostat ED ø 27mm ID ø 11mm thickness 8.5mm		

55.13_ series

			
1			
Part No.	375006	Ref. No.	236004 236027 236041 236046
description	thermostat t.max. 85°C temperature range 30-85°C 1-pole 1CO 16A probe ø 6mm probe L 92mm capillary pipe 3150mm capillary pipe isolated 300mm gland nut shaft L 23mm shaft position upper rotation 270° probe material SS		
For models:	10, 11F, 11FD, 11R, 11RD, 12, 14, 350F, 350FD, 350R, 350RD, 400F, 400FD, 400R, 400RD, 500F, 500FD, CLEAN-3, S621, S623, S624, S626, S631, S633, S634, S636, S651, S651P, S653, S654, S655, S810, S815, S830, S835, S850, S870, S950, SR651		

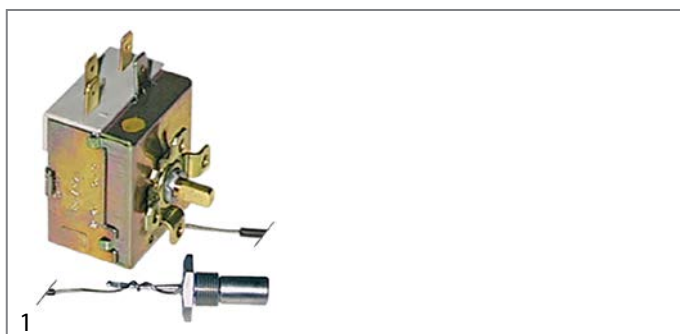




IMIT / TEMPOMATIC / ARTHERMO

control thermostats





Part No.	390421	Ref. No.	929107
description	thermostat t.max. 85°C temperature range 0-90°C 1-pole 1CO 16A probe ø 6.5mm probe L 95mm capillary pipe 1500mm capillary pipe isolated 1450mm gland nut shaft ømm shaft Lmm shaft position rotation 270° probe material copper		
For models:	161, 221, 271, 272, 362, 55, CE78HZ23, CLEAN-160, CLEAN-161, CLEAN-220, CLEAN-221, CLEAN-270, CLEAN-271, CLEAN-272, CLEAN-361, CLEAN-361P, CLEAN-362, CLEAN-471, CLEAN-471P, E.60, E.65, E1, E10, E100, E110, E12, E120, E14, E140, E78, E78HP, GL280EB-23DAR, GL280EBDARY, GL280EBDAW, GL280EBDAY, GL280EBDB, GL280EBDBR, GL280EBSA, GL280EBSAE, GL280EBSAEW, GL280EBSAEWY, GL280EBSAR, GL280EBSARY, GL280EBSAW, GL280EBSAWY, GL280EBSAY, GL280EBSB, GL282EB93DA, GL282EBDA, GL282EB-DARW...(Other models you can see in the webshop)		





Part No.	390005	Ref. No.	236003 236014 926196
description	thermostat t.max. 85°C temperature range 25-85°C 1-pole 1CO 15A probe ø 11mm probe L 35mm capillary pipe 600mm capillary pipe isolated 600mm gland nut shaft ø 6x4.6mm shaft L 8mm shaft position upper° rotation 270° screw-in probe		
For models:	11F, 11FD, 11R, 11RD, E.60, E.65, E1, E10, E100, E110, E12, E120, E14, E140, E78, RIVER-78, RIVER-E78, S621, S623, S624, S626, S631, S633, S634, S636, U61, U61H		
accessories for	390005		
	Part No.	510417	Ref. No. 437002 437024
	flat gasket fibre ED ø 20mm ID ø 14mm thickness 2mm Qty 1 pcs		
	Part No.	550261	Ref. No. —
	nut thread M14x1 H 4mm WS 19 SS Qty 1 pcs		



Part No.	390425	Ref. No.	926259 DRT141C
description	thermostat t.max. 85°C temperature range fixed 60°C 1-pole 1CO 16A probe ø 9.5mm probe L 37mm capillary pipe 600mm capillary pipe isolated 600mm gland nut shaft ømm shaft Lmm shaft position rotation° screw-in probe probe thread M14x1 probe material SS		
For models:	E78		
accessories for	390425		
	Part No.	510417	Ref. No. 437002 437024
	flat gasket fibre ED ø 20mm ID ø 14mm thickness 2mm Qty 1 pcs		
	Part No.	511472	Ref. No. —
	nut thread 3/8" H 4mm brass WS 21 Qty 1 pcs		



Part No.	390006	Ref. No.	929044 DRT13L
description	thermostat t.max. 86°C temperature range 0-86°C 1-pole 1CO 16A probe ø 6.5mm probe L 95mm capillary pipe 1500mm capillary pipe isolatedmm gland nut shaft ø 6x4.6mm shaft L 19mm rotation 270°		
For models:	161, 221, 271, 272, 362, CLEAN-160, CLEAN-161, CLEAN-220, CLEAN-221, CLEAN-270, CLEAN-271, CLEAN-272, CLEAN-361, CLEAN-361P, CLEAN-362, CLEAN-471, CLEAN-471P, RIVER-150		
accessories for	390006		
	Part No.	110100	Ref. No. 929042
	knob thermostat t.max. 90°C 0-90°C ø 42mm shaft ø 6x4.6mm shaft flat -135° black		
	Part No.	110105	Ref. No. —
	rosette knob ø 42mm ø 56mm zero mark		



safety thermostats



Part No.	390770	Ref. No.	927057
description	safety thermostat switch-off temp. 90-110°C 1-pole 1CO 16/0.5A probe ø 6.5mm probe L 90mm capillary pipe 2000mm capillary pipe isolated 1950mm gland nut probe		
For models:	161, 221, 271, 272, 362, 914380, 914436, A3EB, A3EBD, A3EBDAKRKYK, A3EBDAKWK, A3EBDBKWK, A3EBDRKYK, A3EBDWK, A3EBDYK, A3ESB-AK, A3ESBKRK, A3ESBKWYK, A3ESBKWKYK, A3EBSEKWK, A3ESB-WK, A4EB, A4EBD, A4EBDAKEKYK, A4EBDAKRK, A4EBDAKWK, A4EB-DAKZK, A4EBDBKRK, A4EBDPKWYK, A4EBDRK, A4EBS, A4ESAK, A4ESAKCK, A4ESAKEKYK, A4ESAKRK, A4ESAKRKP, A4ESAKYK, A4ESCK, A4EBT, A4EBTSAK, A5EB, A5EBD, A5EBDAKPKWK, A5EBDAK-WK, A5EBDAKYK, A5EBDRK, A5EBS, A5ESAKPKWK, A5ESAKRK, A5ESAKRKYK...(Other models you can see in the webshop)		

CAEM

control thermostats



Part No.	390686	Ref. No.	236043
description	thermostat t.max. 83°C temperature range°C 1-pole 1CO 20A probe ø 6mm probe L 90mm capillary pipe 630mm capillary pipe isolated 550mm gland nut shaft ømm shaft Lmm shaft position rotation 270° probe material copper		
For models:	2312-001, 2312-002, 31F, 31FD, 31R, 31RD, 350F, 350FD, 350R, 350RD, 400F, 400FD, 400R, 400RD, 440F, 450, 460, 50F, 50FD, 510F, 510FD, 67F, 67R, 913297, 913298, 913299, 913300, 913360, 913361, 913363, 913364, 913376, 913377, 913391, 913392, 913418, 913546, 913547, 913578, 913611, 913684, 913932, 913933, 914326, 914331, 914398, 914399, 914400, 914401, 914402...(Other models you can see in the webshop)		

accessories

plunger sockets



Part No.	513031	Ref. No.	929038 DZP22
description	thermowell L 125mm SS single		
For models:	55, A3EB, A3EBD, A3EBDAKRKYK, A3EBDAKWK, A3EBDBKWK, A3EB-DRKYK, A3EBDWK, A3EBDYK, A3ESB, A3ESBKRK, A3ESBKWYK, A3ESBKWKYK, A3EBSEKWK, A3ESBWK, A4EB, A4EBD, A4EBDAKEKYK, A4EBDAKRK, A4EBDAKWK, A4EBDAKZK, A4EBDBKRK, A4EBDPKWYK, A4EBDRK, A4EBS, A4ESAK, A4ESAKCK, A4ESAKEKYK, A4ESB-AKRK, A4ESBKRKPK, A4ESBKYK, A4ESCK, A4EBT, A4EBTSAK, A5EB, A5EBD, A5EBDAKPKWK, A5EBDAKWK, A5EBDAKYK, A5EBDRK, A5EBS, A5ESAKPKWK, A5ESAKRK, A5ESAKRKYK, A5ESAKWK, A5ES-AKWYK, A5ESBKRKPK, A5ESBKWK, A5ESRK, A5ESYK...(Other models you can see in the webshop)		



Part No.	550995	Ref. No.	999160
description	thermowell thread M14x1 ID ø 5mm L 40mm SS ø 9mm		
For models:	050F, 050FP, 913913, 913914, 914167, 914168, 914284, 914318, 914319, 914338, 914356, 914431, 914642, 914909, 914943, 915136, 915137, F85, F85P, Mistral51, MISTRAL-51, NIAGARA-45, Niagara-51		

switches and momentary switches

rocker/momentary rocker switches

27.8x25mm



Part No.	345002	Ref. No.	208009
description	rocker switch mounting measurements 27.8x25mm black 2CO 250V 16A connection male faston 6.3mm ambient temperature max. 85°C protection IP40		



Part No.	345003 ¹	Ref. No.	213007
description	rocker switch mounting measurements 27.8x25mm green 2NO 250V 16A illuminated connection male faston 6.3mm ambient temperature max. 85°C protection IP40		

¹illuminated



push/momentary push switches

28.5x77.5mm



1			
Part No.	345625	Ref. No.	926190 DEP61
description	switch combination latching mounting measurements 28.5x77.5mm black 2CO/2NO/2NO 250V 16A connection male faston 6.3mm ambient temperature max. 85°C protection IP40		

30x22mm



1			
Part No.	301047 ¹	Ref. No.	226059
description	push switch mounting measurements 30x22mm green 2NO 250V 16A illuminated connection male faston 6.3mm ambient temperature max. 85°C protection IP40 latching		
For models:	11F, 11FD, 11F-DVGW, 11R, 11RD		

¹illuminated

microswitches

universal



1			
Part No.	345042	Ref. No.	218009
description	microswitch with plunger 250V 16A 1CO connection male faston 6.3mm L 28mm ambient temperature max. 125°C mounting distance 22mm type EF83161.3 actuating force: 75g blue/black		
For models:	11F, 11FD, 11R, 11RD, R495, R497, R499, R501, R503, R505, R507, R509, R511, R704, R706, R708, S621, S623, S624, S626, S631, S633, S634, S636, S641, S643, S651, S651P, S653, S654, S655, S810, S815, S830, S835, S850, S870, S950, SR651		
accessories for	345042		
	Part No.	345043	Ref. No. —
	lever set 5-piece		

lever actuated



1			
Part No.	345257	Ref. No.	218002
description	microswitch with lever 250V 16A 1CO connection male faston 6.3mm L 29mm L1 33mm ambient temperature max. 120°C mounting distance 22mm actuating force: 130g lever length 31.5mm		

pin-plunger actuated



1			
Part No.	345042	Ref. No.	218009
description	microswitch with plunger 250V 16A 1CO connection male faston 6.3mm L 28mm ambient temperature max. 125°C mounting distance 22mm type EF83161.3 actuating force: 75g blue/black		
For models:	11F, 11FD, 11R, 11RD, R495, R497, R499, R501, R503, R505, R507, R509, R511, R704, R706, R708, S621, S623, S624, S626, S631, S633, S634, S636, S641, S643, S651, S651P, S653, S654, S655, S810, S815, S830, S835, S850, S870, S950, SR651		
accessories for	345042		
	Part No.	345043	Ref. No. —
	lever set 5-piece		

accessories



1			
Part No.	518041	Ref. No.	462005
description	pressure pin for microswitch L 25.4mm ø 4.7mm		
For models:	21F, 21FD, 21R, 21RD, 25F, 25FD, 25R, 25RD, 30F, 30FD, 30R, 30RD, 31F, 31FD, 31R, 31RD, 440F, 44F		

position switches

HIGHLY



1			
Part No.	347877	Ref. No.	927304
description	position switch 2NC 250V L 56mm W 21mm H 25mm 5A		



system switches (ROLD)



1

Part No.	345612	Ref. No.	480059
description	blank size 23x23mm black		
For models:	350F, 350FD, 350R, 350RD, 35-ELECTRONIC, 35F, 35FD, 35R, 35RD, 400F, 400FD, 400R, 400RD, 40-ELECTRONIC, 40F, 40FD, 40R, 40RD, 45, 450, 46, 500F, 500FD, 50-ELECTRONIC, 50F, 50FD, 510F, 510FD, P500		



1

Part No.	345721	Ref. No.	226102
description	blank cap holder		
For models:	Fast180, Fast180-230V-3Ph-60Hz, FAST-60, FAST-73, PLUVIA-280, Pluvia280-230V-3PH-60HZ, PV280, PV280FAST, PV280FAST2, PV280FAST-2BIO, PV280FAST2HZ23, PV280FASTCH, PV280FASTHB, PV280HZ23		



1

Part No.	346848	Ref. No.	226111
description	element holder dimensions 25x25mm ID ø 21.4mm grey		



1

Part No.	345602	Ref. No.	226073
description	element holder double mounting measurements 28.5x52.6mm black for push buttons 23x23mm		
For models:	350F, 350FD, 350R, 350RD, 35-ELECTRONIC, 35F, 35FD, 35R, 35RD, 400F, 400FD, 400R, 400RD, 40-ELECTRONIC, 40F, 40FD, 40R, 40RD		



1

Part No.	345577	Ref. No.	226122
description	element holder mounting measurements 19.3x12.9mm black arched for push buttons 11x15.8		
For models:	GLS40H, GLS40HP, GSP50, GSP50P, HM1		
accessories for	345577		



1

Part No.	345578	Ref. No.	227078
description	push button mounting measurements 11x15.8mm orange for Element carrier		



1

Part No.	345627	Ref. No.	226101
description	element holder mounting measurements 20.6x16.4mm black arched for push buttons 13x17mm		



1

Part No.	345537	Ref. No.	226114
description	element holder mounting measurements 20.6x16.4mm grey arched for push buttons 13x17mm		
For models:	Fast181, ST70FASTHZ23		



1

Part No.	347150	Ref. No.	226113
description	element holder mounting measurements 23.6x14.6mm grey arched for push buttons 11x21mm		
For models:	913289, 913290, 913291, 913292, 913297, 913298, 913299, 913300, 913356, 913357, 913360, 913361, 913363, 913364, 913372, 913373, 913374, 913375, 913376, 913377, 913391, 913392, 913416, 913418, 913435, 913544, 913545, 913546, 913547, 913578, 913611, 913665, 913666, 913667, 913668, 913684, 913685, 913771, 913772, 913773, 913774, 913832, 913837, 913932, 913933, 913948, 914326, 914331, 914386, 914387...(Other models you can see in the webshop)		



1


Part No.	347151	Ref. No.	226121
description	element holder mounting measurements 23.6x14.6mm white arched for push buttons 11x21mm		
For models:	915160, 915161, 915162, 915175, 915176, 915177, 915319, 915338, 915341, 915418, 915419, 915611, 915612, 915613, 915663, 915670, 915686, 915687, 915688, 915689, 915690, 915691, 915692, 915693, 915694, 915695, 915696, 915697, 915698, 915699, 915700, 915701, 915702, 915729, 915756, 915799, 915800, 915816, 915817, 915818, 915819, 915830, 915842, 916162, FAST-135, Fast135CT, FAST-135CT, Fast135D, FAST-135D, Fast135H...(Other models you can see in the webshop)		





1


Part No.	345536	Ref. No.	226096
description	element holder mounting ø 16mm flat black		
For models:	MC201CL, MC501E, MC501EP, MC501S, MC501SP		






			
1			
Part No.	345603	Ref. No.	226074
description	element holder triple mounting measurements 28.5x77.5mm black for push buttons 23x23mm		
For models:	35-ELECTRONIC, 35F, 35FD, 35R, 35RD, 40-ELECTRONIC, 40F, 40FD, 40R, 40RD, 45, 450, 46, 460, 500F, 500FD, 50-ELECTRONIC, 50F, 50FD, 510F, 510FD, P500		


			
1			
Part No.	345601	Ref. No.	299035
description	indicator lamp holder V ø 11mm		
For models:	350F, 350FD, 350R, 350RD, 35-ELECTRONIC, 35F, 35FD, 35R, 35RD, 400F, 400FD, 400R, 400RD, 40-ELECTRONIC, 40F, 40FD, 40R, 40RD, 45, 450, 46, 460, 500F, 500FD, 50-ELECTRONIC, 50F, 50FD, 510F, 510FD, 67F, 67R, 915695, 915696, 915819, Fast145, FAST-145, Fast145D, FAST-145D, LF50, LF55, P500		


			
1			
Part No.	346241	Ref. No.	207011
description	indicator light lens ø 23.3mm yellow		
For models:	LF50, LF55		


			
1			
Part No.	345606	Ref. No.	226071
description	momentary switch unit 2CO 250V 16A connection male faston 6.3mm		
For models:	350F, 350FD, 350R, 350RD, 35-ELECTRONIC, 35F, 35FD, 35R, 35RD, 400F, 400FD, 400R, 400RD, 40-ELECTRONIC, 40F, 40FD, 40R, 40RD, 45, 450, 46, 460, 500F, 500FD, 50-ELECTRONIC, 50F, 50FD, 510F, 510FD, 67F, 67R, 915160, 915161, 915162, 915175, 915176, 915177, 915319, 915338, 915341, 915418, 915419, 915611, 915612, 915613, 915663, 915670, 915686, 915687, 915688...(Other models you can see in the webshop)		

			
1			
Part No.	345650	Ref. No.	226093 226095
description	momentary switch unit 2CO 250V 16A connection male faston 6.3mm		
For models:	2312-001, 2312-002, 913289, 913290, 913291, 913292, 913297, 913298, 913299, 913300, 913356, 913357, 913360, 913361, 913363, 913364, 913372, 913373, 913374, 913375, 913376, 913377, 913391, 913392, 913416, 913418, 913435, 913544, 913545, 913546, 913547, 913578, 913611, 913665, 913666, 913667, 913668, 913684, 913685, 913771, 913772, 913773, 913774, 913832, 913837, 913932, 913933, 913948, 914326, 914331...(Other models you can see in the webshop)		

			
1			
Part No.	345578	Ref. No.	227078
description	push button mounting measurements 11x15.8mm orange for Element carrier		
For models:	GLS40H, GLS40HP, GSP50, GSP50P, HM1		
accessories for	345578		
	Part No.	Ref. No.	226122
	 element holder mounting measurements 19.3x12.9mm black arched for push buttons 11x15.8		

			
1			
Part No.	347152	Ref. No.	227067
description	push button size 11x21mm blue		
For models:	913289, 913290, 913291, 913292, 913297, 913298, 913299, 913300, 913356, 913357, 913360, 913361, 913363, 913364, 913372, 913373, 913374, 913375, 913376, 913377, 913391, 913392, 913416, 913418, 913435, 913544, 913545, 913546, 913547, 913578, 913611, 913665, 913666, 913667, 913668, 913684, 913685, 913771, 913772, 913773, 913774, 913832, 913837, 913932, 913933, 913948, 914326, 914331, 914386, 914387...(Other models you can see in the webshop)		

			
1			
Part No.	347922	Ref. No.	227077
description	push button size 11x21mm silver		

			
1			
Part No.	345611	Ref. No.	227029
description	push button size 23x23mm black rinsing		
For models:	350F, 350FD, 350R, 350RD, 35-ELECTRONIC, 35F, 35FD, 35R, 35RD, 400F, 400FD, 400R, 400RD, 40-ELECTRONIC, 40F, 40FD, 40R, 40RD, 45, 450, 46, 460, 500F, 500FD, 50F, 50FD, 510F, 510FD		



1

Part No.	345609	Ref. No.	227027
description	push button size 23x23mm black START		
For models:	350F, 350FD, 350R, 350RD, 35-ELECTRONIC, 35F, 35FD, 35R, 35RD, 400F, 400FD, 400R, 400RD, 40-ELECTRONIC, 40F, 40FD, 40R, 40RD, 45, 450, 46, 460, 500F, 500FD, 50-ELECTRONIC, 50F, 50FD, 510F, 510FD		



1

Part No.	345661	Ref. No.	227032
description	push button size 23x23mm black timer		
For models:	P500		



1

Part No.	347878	Ref. No.	227072
description	push button size 23x23mm grey with lens		



1

Part No.	346847	Ref. No.	409003
description	rotary disc green/black disc ø 18.7mm		



1

Part No.	345608	Ref. No.	409001
description	rotary disc green/black disc ø 20.6mm		
For models:	350F, 350FD, 350R, 350RD, 35-ELECTRONIC, 35F, 35FD, 35R, 35RD, 400F, 400FD, 400R, 400RD, 40-ELECTRONIC, 40F, 40FD, 40R, 40RD, 45, 450, 46, 460, 500F, 500FD, 50-ELECTRONIC, 50F, 50FD, 510F, 510FD, 67F, 67R, LF50, LF55, P500		



1

Part No.	345605	Ref. No.	208010
description	switch 2CO 250V 16A connection male faston 6.3mm		
For models:	350F, 350FD, 350R, 350RD, 35-ELECTRONIC, 35F, 35FD, 35R, 35RD, 400F, 400FD, 400R, 400RD, 40-ELECTRONIC, 40F, 40FD, 40R, 40RD, 45, 450, 46, 460, 500F, 500FD, 50-ELECTRONIC, 50F, 50FD, 510F, 510FD, 67F, 67R, 915160, 915161, 915162, 915175, 915176, 915177, 915319, 915338, 915341, 915418, 915419, 915611, 915612, 915613, 915663, 915670, 915686, 915687, 915688...(Other models you can see in the webshop)		



1

Part No.	345651	Ref. No.	208011
description	switch 2CO 250V 16A connection male faston 6.3mm		
For models:	2312-001, 2312-002, 913289, 913290, 913291, 913292, 913297, 913298, 913299, 913300, 913356, 913357, 913360, 913361, 913363, 913364, 913372, 913373, 913374, 913375, 913376, 913377, 913391, 913392, 913416, 913418, 913435, 913544, 913545, 913546, 913547, 913578, 913611, 913665, 913666, 913667, 913668, 913684, 913685, 913771, 913772, 913773, 913774, 913832, 913837, 913932, 913933, 913948, 914326, 914331...(Other models you can see in the webshop)		



1

Part No.	346851	Ref. No.	80804
description	switch 2CO 250V 16A connection male faston 6.3mm		
For models:	CE78HZ23, E78, E78HP, Fast181, FAST-181, Fast181-230V-3Ph-60Hz, Fast181-400V-3NPh-60Hz, FAST-60, FAST-73, HM1, PLUVIA-280, Pluvia280-230V-3PH-60HZ, PS-60, PV280, PV280FAST, PV280FASTCH, PV280FASTHB, PV280HZ23, RIVER-78, RIVER-E78, ST70FAST, ST-70FASTHB, ST70FASTHB400, ST70FASTHZ23		

system switches

ELETTROBAR

fascias



1

Part No.	345652	Ref. No.	480095
description	blank grey format square mounting measurements 25x25mm		
For models:	E.35, E.35H, E.40, E.41, E.42, E.45, E.46, E.50, E.51, E.52		



push buttons



1

Part No.	345658	Ref. No.	227052
description	push button		
For models:	E.35, E.35H, E.40, E.40H, E.41, E.42, E.45, E.46, E.50, E.51, E.52, E.60, E.65, E1, E10, E100, E110, E12, E120, E14, E140		



1

Part No.	345659	Ref. No.	227051
description	push button		
For models:	E.35, E.35H, E.40, E.40H, E.41, E.42, E.45, E.46, E.50, E.51, E.52, E.60, E.65, E1, E10, E100, E110, E12, E120, E14, E140, RIVER-78, U132, U61, U61H, U70		



1

Part No.	347523	Ref. No.	227050
description	push button black ø 12mm H 7mm		
For models:	MC201CL, MC501E, MC501EP, MC501S, MC501SP, TF-503		



1

Part No.	347922	Ref. No.	227077
description	push button size 11x21mm silver		

element holders



1

Part No.	345653	Ref. No.	226098
description	element holder grey format square illuminable L.26 suitable for E35/4 E46/E50/E51		
For models:	E.35, E.35H, E.40, E.40H, E.41, E.42, E.45, E.46, E.50, E.51, E.52		

rotary switches

BREMAS

A1200 series



1

Part No.	345274	Ref. No.	213003
description	rotary switch sets of contacts 4 2 0-1 type CA0120004 380V 12A shaft ø 5x5mm shaft L 23mm shaft square connection screw		
For models:	22F, 22R, 40F, R708		



1

Part No.	300326	Ref. No.	927034
description	rotary switch sets of contacts 6 0-1-2-3 type CS012015B 400V 12A shaft ø 5x5mm shaft L 18mm		
For models:	161, 221, 271, 272, 362, CLEAN-160, CLEAN-161, CLEAN-220, CLEAN-221, CLEAN-270, CLEAN-271, CLEAN-272, CLEAN-362		

A1600 series



1

Part No.	347401	Ref. No.	205004
description	rotary switch 4 momentary switch-0-1-momentary switch sets of contacts 8 type CS0077762 600V 16A shaft ø 5x5mm shaft L 22mm shaft square connection screw		
For models:	22F, 22R, 40F, PS-60		

miscellaneous



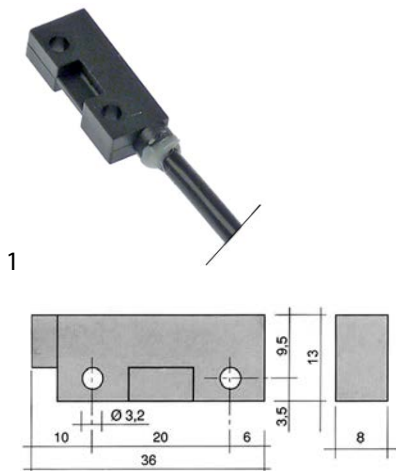
1


Part No.	347689	Ref. No.	213002
description	rotary switch sets of contacts 2 2 0-1 type CS20-00063 690V 25A shaft ø 5x5mm shaft L 22mm shaft square connection male faston 6.3mm		
For models:	10, 12, 66, CLEAN-100, CLEAN-110, CLEAN-120, R495, R499, R501, R503, R505, R507, R509, R511, R704, R706, S641, S643, S870		



magnetic switches

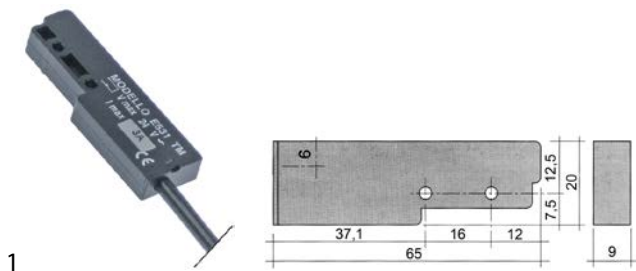
36x13mm



Part No.	345118 ¹	Ref. No.	211002 211002AG 80871
description	magnetic switch L 36mm W 13mm 1NO 250V 1A P max. 50W connection cable length 980mm		
For models:	050F, 050FP, 21F, 21FD, 21R, 21RD, 2312-001, 2312-002, 2312-007, 2312-009-CRP, 25F, 25FD, 25R, 25RD, 30F, 30FD, 30R, 30RD, 31F, 31FD, 31R, 31RD, 350F, 350FD, 350R, 350RD, 35-ELECTRONIC, 35F, 35FD, 35R, 35RD, 400F, 400FD, 400R, 400RD, 40-ELECTRONIC, 40F, 40FD, 40R, 40RD, 440F, 44F, 45, 450, 46, 460, 500F, 500FD, 50-ELECTRONIC, 50F... (Other models you can see in the webshop)		
accessories for	345118		
	Part No.	345399	Ref. No. 927088 CWM7
	magnet \varnothing 3.3mm L 40mm H 8mm W 13mm hole distance 30mm M3		


¹with coded connector

65x20mm



Part No.	347876	Ref. No.	927056
description	magnetic switch L 65mm W 20mm 1NC 24V 4A P max. 100W connection cable length 1940mm		
For models:	161, 221, 271, 272, 362, CLEAN-160, CLEAN-161, CLEAN-220, CLEAN-221, CLEAN-270, CLEAN-271, CLEAN-272, CLEAN-362		




Part No.	345116	Ref. No.	927017
description	magnetic switch L 65mm W 20mm 1NO 250V 0.4A P max. 100W connection cable length 3000mm		
For models:	161, 221, 271, 272, 362, CLEAN-160, CLEAN-161, CLEAN-220, CLEAN-221, CLEAN-270, CLEAN-271, CLEAN-272, CLEAN-361, CLEAN-361P, CLEAN-362, CLEAN-471, CLEAN-471P, RIVER-150, RV150, U132, U132E, U61, U61E, U61H, U61HE, U70, U70E		
accessories for	345116		
	Part No.	345399	Ref. No. 927088 CWM7
	magnet \varnothing 3.3mm L 40mm H 8mm W 13mm hole distance 30mm M3		

 \varnothing 6mm


Part No.	345202	Ref. No.	DEM2038
description	magnetic switch 250V 0.04A P max. 10W probe L 29mm 1NO connection plug cable length 1400mm		



Part No.	345630	Ref. No.	926195
description	magnetic switch 250V 0.04A P max. 10W probe L 29mm 1NO connection plug cable length 350mm		
For models:	E.60, E.65, E100, E110, E120, E140		
accessories for	345630		
	Part No.	345336	Ref. No. 926014
	magnet \varnothing 4.8mm L 63mm H 11mm W 18.8mm hole distance 51mm M4		

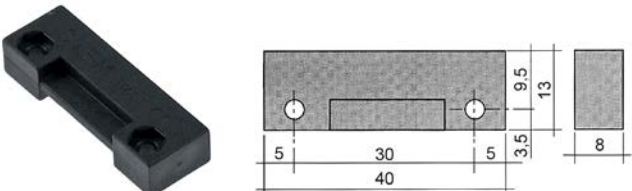


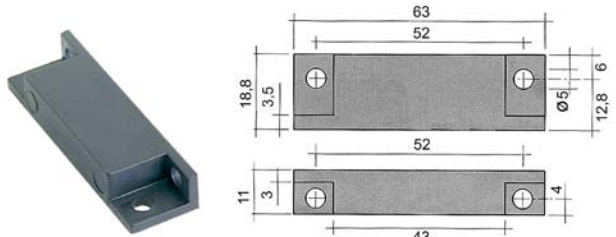
			
1			
Part No.	345146	Ref. No.	211001
description	magnetic switch 250V 1A P max. 50W probe L 29mm 1NO connection plug cable length 980mm		
For models:	10, 11F, 11FD, 11F-DVGW, 11R, 11RD, 12, 14, 22F, 22R, 2312-007, 2312-009-CRP, 40F, 914100, 914101, 914339, 914342, 914343, 914624, 914625, 914626, 914627, 914628, 914850, 914851, 914854, 914944, CLEAN-100, CLEAN-110, CLEAN-120, E1, E10, E100, E110, E12, E120, E14, E140, RIVER-48, RIVER-50, RIVER-50-CRP, RIVER-50-CRP-SP, RIVER-54, RIVER-54CRP, RIVER-54-CRP-s.p., RIVER-54-CRP-SP, RIVER-61		

			
1			
Part No.	346953	Ref. No.	999108
description	magnet ømm L 23mm H 17mm W 18mm M6 hole ø 6.5mm		
For models:	050F, 050FP, 11F, 11FD, 11R, 11RD, 2312-001, 2312-002, 45, 450, 46, 460, 500F, 500FD, 510F, 510FD, 913297, 913298, 913299, 913300, 913360, 913361, 913391, 913392, 913418, 913546, 913547, 913578, 913611, 913684, 913913, 913914, 913932, 913933, 914167, 914168, 914284, 914318, 914319, 914326, 914331, 914338, 914356, 914398, 914399, 914400, 914401, 914402, 914403, 914404...(Other models you can see in the webshop)		

accessories

magnets

			
1			
Part No.	345399	Ref. No.	927088 CWM7
description	magnet ø 3.3mm L 40mm H 8mm W 13mm hole distance 30mm M3		
For models:	161, 221, 271, 272, 362, 80, 81, 82, 914380, 914436, A3EB, A3EBD, A3EBDAKRKYK, A3EBDAKWK, A3EBDBKWK, A3EBDRKYK, A3EBDWK, A3EBDYK, A3EBSAK, A3EBSAKRK, A3EBSAKWK, A3EBSBKWKYK, A3EBSEKWK, A3EBSWK, A4EB, A4EBD, A4EBDAKEKYK, A4EBDAKRK, A4EBDAKWK, A4EBDAKZK, A4EBDBKWK, A4EBDPKWKYK, A4EBDRK, A4EBS, A4EBSAK, A4EBSAKCK, A4EBSAKEKYK, A4EBSAKRK, A4EBSAKRKPK, A4EBSAKYK, A4EBSCK, A4EBT, A4EBTSAK, A5EB, A5EBD, A5EBDAKPKWK, A5EBDAKWK, A5EBDAKYK, A5EBDRK, A5EBS...(Other models you can see in the webshop)		

			
1			
Part No.	345336	Ref. No.	926014
description	magnet ø 4.8mm L 63mm H 11mm W 18.8mm hole distance 51mm M4		
For models:	10, 12, 161, 221, 271, 272, 362, 914380, 914436, A3EB, A3EBD, A3EBDAKRKYK, A3EBDAKWK, A3EBDBKWK, A3EBDRKYK, A3EBDWK, A3EBDYK, A3EBSAK, A3EBSAKRK, A3EBSAKWK, A3EBSBKWKYK, A3EBSEKWK, A3EBSWK, A4EB, A4EBD, A4EBDAKEKYK, A4EBDAKRK, A4EBDAKWK, A4EBDAKZK, A4EBDBKWK, A4EBDPKWKYK, A4EBDRK, A4EBS, A4EBSAK, A4EBSAKCK, A4EBSAKEKYK, A4EBSAKRK, A4EBSAKRKPK, A4EBSAKYK, A4EBSCK, A4EBT, A4EBTSAK, A5EB, A5EBD, A5EBDAKPKWK, A5EBDAKWK, A5EBDAKYK, A5EBDRK, A5EBS, A5EBSAKPKWK...(Other models you can see in the webshop)		


lamps


indicator lights

indicator lights 2-piece (lens and indicator lamp)


indicator light lenses

ø12mm (type SDY-3)

			
1			
Part No.	359262	Ref. No.	926114
description	indicator light housings mounting measurements ø12mm green round Qty 1 pcs		

			
1			
Part No.	359260	Ref. No.	926115
description	indicator light housings mounting measurements ø12mm yellow round Qty 1 pcs		
For models:	161, 221, 271, 272, 362, CLEAN-161, CLEAN-221, CLEAN-271, CLEAN-272, CLEAN-362, E.60, E.65, E1, E10, E100, E110, E12, E120, E14, E140		

indicator lamps for socket type SRZ / SDK / SDY / SFK

			
1			
Part No.	359130	Ref. No.	216006 926113
description	indicator lamp 230V clear connection male faston 6.3mm ø 8mm		
For models:	350F, 350FD, 350R, 350RD, 35-ELECTRONIC, 35F, 35FD, 35R, 35RD, 400F, 400FD, 400R, 400RD, 40-ELECTRONIC, 40F, 40FD, 40R, 40RD, 45, 450, 46, 460, 500F, 500FD, 50-ELECTRONIC, 50F, 50FD, 510F, 510FD, 67F, 67R, LF50, LF55, P500		



indicator lights (complete)

ø 6mm



1

Part No.	359005	Ref. No.	216003 216025
description	indicator light ø 6mm 230V yellow cable length 400mm		
For models:	11F, 11FD, 11F-DVGW, 11R, 11RD, 2312-001, 2312-002, 913289, 913290, 913291, 913292, 913297, 913298, 913299, 913300, 913356, 913357, 913360, 913361, 913363, 913364, 913372, 913373, 913374, 913375, 913376, 913377, 913391, 913392, 913416, 913418, 913435, 913544, 913545, 913546, 913547, 913578, 913611, 913665, 913666, 913667, 913668, 913684, 913685, 913771, 913772, 913773, 913774, 913832, 913837...(Other models you can see in the webshop)		

ø12mm

with plug-in socket



1

Part No.	359041	Ref. No.	216019
description	indicator light ø 12mm green 230V connection male faston 6.3mm temp.-resist. 120°C Qty 1 pcs		
For models:	22F, 22R, 40F, 66		

28.5x28.5mm



1

Part No.	345610	Ref. No.	207007
description	indicator light lens 23x23 orange operating		
For models:	350F, 350FD, 350R, 350RD, 35-ELECTRONIC, 35F, 35FD, 35R, 35RD, 400F, 400FD, 400R, 400RD, 40-ELECTRONIC, 40F, 40FD, 40R, 40RD, 45, 450, 46, 460, 500F, 500FD, 50-ELECTRONIC, 50F, 50FD, 510F, 510FD, P500		



1

Part No.	345616	Ref. No.	207010
description	indicator light lens 23x23 orange Sinus		



1

Part No.	345614	Ref. No.	410008
description	indicator light lens orange heating		
For models:	450, 46, 460, 500F, 500FD, 50F, 50FD, 510F, 510FD		

LED

indicator lamps

mounting diameter 6mm



1

Part No.	359404	Ref. No.	216028
description	indicator light LED mounting ø 6mm 5VDC green connection cable 200mm 2mA		
For models:	CE78HZ23, E.35H, E.40H, E78, E78HP, Fast181, FAST-181, Fast181-230V-3Ph-60Hz, Fast181-400V-3NPh-60Hz, HM1, PS-60, RIVER-E78, ST70FAST, ST70FASTHB, ST70FASTHB400, ST70FASTHZ23		



1

Part No.	358098	Ref. No.	216029
description	indicator light LED mounting ø 6mm 5VDC yellow connection cable 200mm 2mA		
For models:	CE78HZ23, E.35H, E.40H, E78, E78HP, Fast180, Fast180-230V-3Ph-60Hz, Fast181, FAST-181, Fast181-230V-3Ph-60Hz, Fast181-400V-3NPh-60Hz, FAST-60, FAST-73, HM1, PLUVIA-280, Pluvia280-230V-3PH-60Hz, PS-60, PV280, PV280FAST, PV280FAST2, PV280FAST2BIO, PV280FAST2HZ23, PV280FASTCH, PV280FASTHB, PV280HZ23, RIVER-E78, ST70FAST, ST70FASTHB, ST70FASTHB400, ST70FASTHZ23		

timers


programme timers

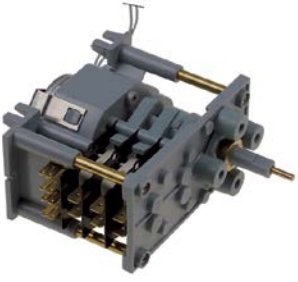








1




Part No.	360298	Ref. No.	238030
description	timer BIGATTI D94 engines 2 chambers 4 operation time 3min/6min/9min 230V shaft ømm shaft Lmm manuf. no. WE004 motor type UDS40NE1LK operation time 3/6/9min		
For models:	S950		



			
1			
Part No.	360349	Ref. No.	238046 238046.AG 238053 REB238046 REB238053
description	timer CDC 11803 engines 1 chambers 3 operation time 150s 230V shaft ømm shaft Lmm manif. no. 11803F1BEE000.0010 motor type M48R ATS type 11803F1 / 238046		
For models:	11F, 11FD, 11R, 11RD, 21F, 21FD, 21R, 21RD, 25F, 25FD, 25R, 25RD, 30F, 30FD, 30R, 30RD, 31F, 31FD, 31R, 31RD, 350F, 350FD, 350R, 350RD, 400F, 400FD, 400R, 400RD, 450, 913289, 913290, 913291, 913292, 913356, 913357, 913363, 913364, 913372, 913373, 913374, 913375, 913376, 913377, 913416, 913418, 913435, 913544, 913545, 913665, 913666...(Other models you can see in the webshop)		

			
1			
Part No.	360025	Ref. No.	238049 238050 238050.AG
description	timer CDC 7003F engines 1 chambers 3 operation time 360s 230V 50Hz shaft ø 6x7mm shaft L 26mm manif. no. 7003F3 / 360025 motor type M37LN		
For models:	10, 12, 22F, 22R, 40F, 66, CLEAN-100, CLEAN-110, CLEAN-120		
spare parts for	360025		
	Part No.	360131	Ref. No. —
	motor CDC pinion ø 5.4mm teeth 12 230V turn direction left motor ø 37mm motor type M37LN for timer		
accessories for	360025		
	Part No.	110085	Ref. No. 226051
	push button t.max.°C ø 36mm shaft ømm shaft flat grey for knob		
	Part No.	110086	Ref. No. 447089
	knob switch zero mark t.max.°C ø 45mm shaft ømm shaft flat special black		
	Part No.	110087	Ref. No. 499066
	retaining ring shaft ø 8mm DIN 471		

			
1			
Part No.	360132	Ref. No.	238060
description	timer CDC 7801 engines 1 chambers 1 operation time 20min 230V shaft ømm shaft Lmm manif. no. 7801F1 / 360132 motor type M37RN		
For models:	46, 500F, 500FD, 50F, 50FD, 510F, 510FD		
spare parts for	360132		
	Part No.	360119	Ref. No. —
	motor CDC pinion ø 5.4mm teeth 12 230V turn direction right motor ø 37mm motor type M37RN for timer		

			
1			
Part No.	360133	Ref. No.	238066
description	timer CDC 7804DV engines 2 chambers 4 operation time 60s / 20min 230V shaft ømm shaft Lmm manif. no. 7804DV / 360133 motor type M37RN/M37LN		
For models:	2312-001, 2312-002, 460, 500F, 500FD, 510F, 510FD, 913297, 913298, 913299, 913300, 913360, 913361, 913391, 913392, 913546, 913547, 913578, 913611, 913684, 913932, 913933, 914331, 914400, 914401, 914402, 914403, 914404, 914405, 914409, 914517, 914545, 914568, 914688, 914979, 915140, 915248, E.46, E.50, E.50D.PA, E.51, E.52, GSP50, GSP50P, GSP51, GSP51P, LF50, LF55, MC501E, MC501EP...(Other models you can see in the webshop)		
spare parts for	360133		
	Part No.	360119	Ref. No. —
	motor CDC pinion ø 5.4mm teeth 12 230V turn direction right motor ø 37mm motor type M37RN for timer		
	Part No.	360131	Ref. No. —
	motor CDC pinion ø 5.4mm teeth 12 230V turn direction left motor ø 37mm motor type M37LN for timer		




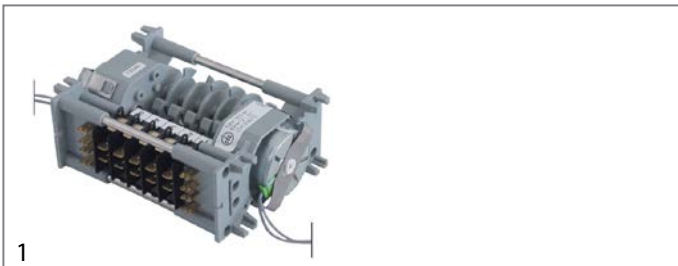


			
1			
Part No.	360134	Ref. No.	238061
description	timer CDC 7804DV engines 2 chambers 4 operation time 6s / 3min 230V shaft ømm shaft Lmm manif. no. 7804DV / 360134 motor type M37RN/M37LN		
For models:	500F, 500FD, 50F, 50FD, 510F, 510FD		
spare parts for	360134		
	Part No.	360119	Ref. No. —
	motor CDC pinion ø 5.4mm teeth 12 230V turn direction right motor ø 37mm motor type M37RN for timer		

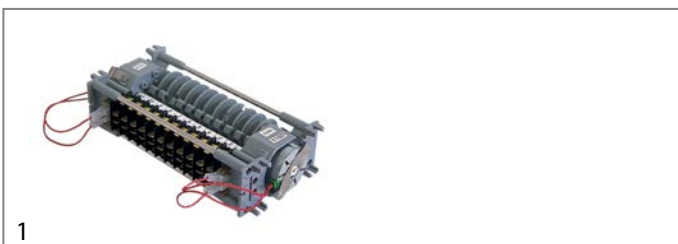
Table continues overleaf





spare parts for 360134			
	Part No.	360131	Ref. No. —
motor CDC pinion ø 5.4mm teeth 12 230V turn direction left motor ø 37mm motor type M37LN for timer			




Part No.	360264	Ref. No.	238073
description	timer CDC 7805DV engines 2 chambers 5 operation time 72s/20min 230V shaft ømm shaft Lmm manuf. no. 7805DV / 238073 motor type M37RN/M37LN		
For models:	914326, 914406, E.55		
spare parts for 360264			
	Part No.	360119	Ref. No. —
motor CDC pinion ø 5.4mm teeth 12 230V turn direction right motor ø 37mm motor type M37RN for timer			
	Part No.	360131	Ref. No. —
motor CDC pinion ø 5.4mm teeth 12 230V turn direction left motor ø 37mm motor type M37LN for timer			




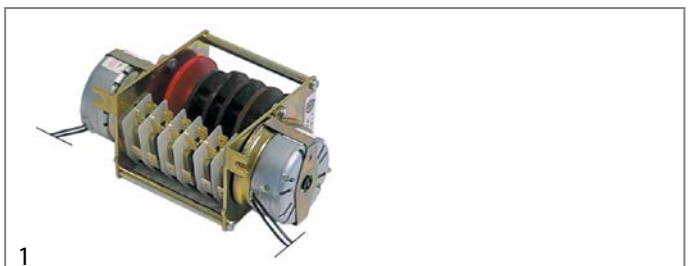
Part No.	360124	Ref. No.	238067
description	timer CDC 7811DV engines 2 chambers 11 operation time 90s / 20min 230V shaft ømm shaft Lmm manuf. no. 7811DV / 238067 motor type M37RN/M37LN		
For models:	CLEAN-3		
spare parts for 360124			
	Part No.	360119	Ref. No. —
motor CDC pinion ø 5.4mm teeth 12 230V turn direction right motor ø 37mm motor type M37RN for timer			
	Part No.	360131	Ref. No. —
motor CDC pinion ø 5.4mm teeth 12 230V turn direction left motor ø 37mm motor type M37LN for timer			





Part No.	360019	Ref. No.	DTP14
description	timer CEM HFD4M16 engines 1 chambers 4 operation time 255s 230V shaft ø 6x4.6mm shaft L 17mm manuf. no. HFD4M16 / DTP14 motor type UDS11NE1RH		
spare parts for 360019			
	Part No.	360112	Ref. No. —
motor SAIA pinion ø 4mm teeth 12 230V turn direction right motor ø 48mm motor type UDS11NE1RHZ for timer			




Part No.	360028	Ref. No.	DTP15
description	timer CEM HFD4M16 engines 1 chambers 4 operation time 270s 230V shaft ø 6x4.6mm shaft L 17mm manuf. no. HFD4M16 / DTP15 motor type UDS11NE1RH		
spare parts for 360028			
	Part No.	360112	Ref. No. —
motor SAIA pinion ø 4mm teeth 12 230V turn direction right motor ø 48mm motor type UDS11NE1RHZ for timer			



Part No.	360030	Ref. No.	DTP21
description	timer CEM HL6M16 engines 2 chambers 6 operation time 60s/120s 230V shaft ømm shaft Lmm manuf. no. HL6M16 / DTP21 motor type UDS11NE1RH / UDS11NE1LH		
spare parts for 360030			
	Part No.	360112	Ref. No. —
motor SAIA pinion ø 4mm teeth 12 230V turn direction right motor ø 48mm motor type UDS11NE1RHZ for timer			
	Part No.	360113	Ref. No. —
motor SAIA pinion ø 4mm teeth 12 230V turn direction left motor ø 48mm motor type UDS40NE1RNZ165 for timer			



Part No.	360125	Ref. No.	238069
description	timer FIBER P25 engines 1 chambers 1 operation time 15s-14.4min 230V shaft ømm shaft Lmm manuf. no. P255JC11JK7 motor type M51BJ0R6400		
For models:	CLEAN-3		
spare parts for 360125			
	Part No.	360673	Ref. No. —
motor kit pinion ø 6.8mm teeth 15 230V voltage AC 50/60Hz turn direction clockwise motor ø 48mm H 18.5mm motor type UDS-40NE1RNZ165 cable length 150mm with holder			



contactors

GENERAL ELECTRIC (AEG)

power contactors



1

Part No.	380239	Ref. No.	926040
description	power contactor resistive load 20A 230VAC (AC3/400V) 8.4A/4kW main contacts 3NO auxiliary contacts 1NC connection screw connection type LS05 01A type AEG LS05 01A type GE MC1A 301A		
For models:	12, 14		



1

Part No.	380238	Ref. No.	229032
description	power contactor resistive load 20A 230VAC (AC3/400V) 8.4A/4kW main contacts 3NO auxiliary contacts 1NO connection screw connection type LS0510A type AEG LS0510A type GE MC1A 310A		
For models:	050F, 050FP, 12, 22F, 440F, 44F, F85, F85P, FRI12, FRI12+12, FRI15, FRI15M, FRI6, FRI6+6, FRI9, FRI9+9, MISTRAL-51, NIAGARA-51, S950, U132, U61, U61H, U70		



1

Part No.	380245	Ref. No.	229010 229011 229019 929122
description	power contactor resistive load 25A 230VAC (AC3/400V) 9A/4kW main contacts 3NO auxiliary contacts 1NC connection screw connection type AEG LS4K 01A type GE CL00A 301 H 85mm		
For models:	500F, 500FD, 66, E.65, E110, E12, E120, E14, E140, FRI12, FRI12+12, FRI15, FRI15M, FRI6, FRI6+6, FRI9, FRI9+9, S651, S651P, S653, S654, S655, S810, S815, S830, S835, S850, S870, S950, SR651		



1

Part No.	381191	Ref. No.	926282 DTC112NO
description	power contactor resistive load 25A 400VAC (AC3/400V) 12A/5.5kW main contacts 3NO auxiliary contacts 1NO connection screw connection type AEG type GE CL01A310T6		
For models:	80, 81, 82, CGL74CABT, KLP105EB, KLP201DDDTEB, KLP201EB, KLP301, KLP301DDDTEB, LP105DDDTEB, LP105DDDTEBN, LP105EB, LP201DDDTEB, LP201EB, LP301, LP301EB, Niagara-283A, River-285, River-81CRP, RIVER-81-CRP, RIVER-82, River-82CRP, RIVER-82-CRP, RIVER-HL-82, RV282R, RV81CCRP, RV81CRP, RV82, RV8223, RV82C, RV82CCRP, RV82CRP, SevenL, SV72AEB, U132e, U61E, U61HE, U70e		

ISKRA (FANAL)

power contactors



1

Part No.	380423	Ref. No.	229016
description	power contactor resistive load 35A 230VAC (AC3/400V) 25A/11kW main contacts 3NO auxiliary contacts connection screw connection type Fanal DSL22 type ISKRA KNL22		
For models:	337, 338, 343, 344, 440F, 44F, ME15, ME20, ME30, ME40, S950		


SIEMENS

power contactors



1


Part No.	380957	Ref. No.	927051 927160
description	power contactor resistive load 22A 24VAC (AC3/400V) 12A/5.5kW main contacts 3NO auxiliary contacts 1NO connection screw connection type 3RT10-17-1AB01 50/60Hz		
For models:	A3EBD, A3EBDAKWK, A3EBDBKWK, A3EBDWK, A3EBDYK, A3EBSAK, A3EBSAKWK, A3EBSBKWKYK, A3EBSWK, A4EBD, A4EBS, A4EBSAKRK, A4EBSAKYK, A4EBSCK, A5EBD, A5EBDAKPKWK, A5EBDAKWK, A5EBS, A5EBSAKPKWK, A5EBSYK, CLEAN-361, CLEAN-361P, CLEAN-471, CLEAN-471P, RIVER-MULTI-2252, RIVER-MULTI-2256, RIVER-MULTI-2258		

1

Part No.	380390	Ref. No.	80351
description	power contactor resistive load 40A 230VAC (AC3/400V) 12A/5.5kW main contacts 3NO auxiliary contacts connection screw connection type 3RT10-24-1AL20 50/60Hz		
For models:	914380, 914436, FAST-181, Fast181-230V-3Ph-60Hz, Fast181-400V-3NPh-60Hz, FAST-200, GL280EB, GL280EBD, GL280EBDA, GL280EBDAE, GL280EBDAR, GL280EBDAWY, GL280EBDBW, GL280EBDY, GL280EBS, GL280EBSY, GL282EB, GL282EBCH, GL282EBCHD, GL282EBD, GL282EBDAE, GL282EBDAR, GL284EBD, GL284EBDAWY, GL284EBS, GL284EBSAR, GL286EBD, GL286EBDARY, GL286EBS, GL286EBSAW, NIAGARA-2150, NIAGARA-2152, NIAGARA-2154, NIAGARA-2156, RIVER-150, RIVER-152, RIVER-154, RIVER-298, RIVER-80, RIVER-81, RIVER-82, RV150, RV15023, RV15023DA, RV150D, RV150DA, RV150DAR, RV150DARY, RV150DAW, RV150DAWY...(Other models you can see in the webshop)		

motor protection circuit breakers



1

Part No.	381190	Ref. No.	DEI395
description	motor protection circuit breaker type 3RV1021-4AA10 setting range 11-16A contacts 3NO connection screw		

relays

power relays

with flange mounting



1


Part No.	380131	Ref. No.	2290009
description	power relays Italiana Relè 230VAC 16A 3CO connection male faston 6.3mm screw mounting manuf. no. B2-3-230AC		



1


Part No.	380130	Ref. No.	229008
description	power relays Italiana Relè 230VAC 16A 3NO connection male faston 6.3mm screw mounting manuf. no. B1-3-230AC		

with bracket mounting




1

Part No.	380312	Ref. No.	229023 229024
description	power relays FINDER 230VAC 10A 3CO connection male faston 4.8mm bracket mounting dimensions 52x32.2x36.5mm manuf. no. 60.63.8.230.0000		
For models:	10, 12, 14, 21F, 21FD, 21R, 21RD, 22F, 22R, 2312-001, 2312-002, 25F, 25FD, 25R, 25RD, 30F, 30FD, 30R, 30RD, 31F, 31FD, 31R, 31RD, 40F, 440F, 460, 500F, 500FD, 510F, 510FD, 66, 913289, 913290, 913291, 913292, 913297, 913298, 913299, 913300, 913356, 913357, 913360, 913361, 913363, 913364, 913372, 913373, 913374, 913375, 913376...(Other models you can see in the webshop)		




1

Part No.	380139	Ref. No.	926021 929115
description	power relays FINDER 230VAC 16A 2CO connection F6.3 bracket mounting dimensions 68x38.2x35.8mm manuf. no. 62.82.8.230.0000		
For models:	10, 2312-001, 2312-002, 80, 81, 82, 914380, 914436, 915747, CE78HZ23, CGL74CABT, CLEAN-100, E.50, E.51, E.60, E.65, E1, E10, E100, E110, E12, E120, E14, E140, E78, E78HP, Fast181, FAST-181, Fast181-230V-3Ph-60Hz, Fast181-400V-3NPh-60Hz, Fast200, FAST-200, Fast93, GL280EB, GL280EB23, GL280EB23DAR, GL280EB23HZ, GL280EB23HZDY, GL280EBD, GL280EBDA, GL280EBDAE, GL280EBDAR, GL280EBDARY, GL280EBDAW, GL280EBDAWY, GL280EBDAY, GL280EBDB, GL280EBDBR, GL280EBDBW, GL280EBDWY...(Other models you can see in the webshop)		


1

Part No.	380702	Ref. No.	229039 229040
description	power relays FINDER 230VAC 16A 3NO connection male faston 6.3mm flange dimensions 36x38x68mm manuf. no. 62.83.8.230.0300 230V		
For models:	913297, 913298, 913299, 913300, 913360, 913361, 913391, 913392, 913418, 913546, 913547, 913578, 913611, 913684, 913911, 913912, 913913, 913914, 913932, 913933, 913950, 913977, 913984, 913990, 913992, 913993, 914165, 914166, 914167, 914168, 914206, 914214, 914284, 914316, 914317, 914318, 914319, 914326, 914331, 914338, 914355, 914356, 914398, 914399, 914400, 914401, 914402, 914403, 914404, 914405...(Other models you can see in the webshop)		



1


Part No.	380311	Ref. No.	229030
description	power relays Italiana Relè 230VAC 20A 1NC/1NO connection F6.3 bracket mounting manuf. no. A1B-230AC-FA		
For models:	11F, 11FD, 11F-DVGW, 11R, 11RD, 21F, 21FD, 21R, 21RD, 22F, 25F, 25FD, 25R, 25RD, 30F, 30FD, 30R, 30RD, 31F, 31FD, 31R, 31RD, 350F, 350FD, 350R, 350RD, 400F, 400FD, 400R, 400RD, 440F, 44F, 450, 460, 500F, 500FD, 50F, 50FD, 510F, 510FD, CLEAN-3, E.45, E.46, E.50, E.51, E.52, TF-503, TF-513, TF-515		




1

Part No.	380185	Ref. No.	229025 229029 DER111
description	power relays Italiana Relè 230VAC 30A 1NO connection F6.3 bracket mounting dimensions 36.5x32.2x51.8mm manuf. no. A10-230AC-FA		
For models:	050F, 050FP, 10, 22F, 22R, 2312-007, 2312-009-CRP, 440F, 44F, 46, 500F, 500FD, 50-ELECTRONIC, 50F, 50FD, 510F, 510FD, 80, 81, 913297, 913298, 913299, 913300, 913360, 913361, 913391, 913392, 913546, 913547, 913578, 913611, 913684, 913913, 913914, 913932, 913933, 914100, 914101, 914284, 914318, 914319, 914326, 914331, 914338, 914339, 914342, 914343, 914356, 914400, 914401...(Other models you can see in the webshop)		


relay sockets



1

Part No.	380137	Ref. No.	927045
description	relay socket 8-pole connection plug-in connection round 8-pole dimensions 65x28x40mm 380V voltage AC 10A Italiana Relè manuf. no. ZVE8		
For models:	161, 221, 271, 272, 362, CLEAN-160, CLEAN-161, CLEAN-220, CLEAN-221, CLEAN-270, CLEAN-271, CLEAN-272, CLEAN-361, CLEAN-361P, CLEAN-362, CLEAN-471, CLEAN-471P		
accessories for	380137		
	Part No.	380805	Ref. No. —
		support bracket	

time relays




1

Part No.	380611	Ref. No.	929113
description	time relay FINDER 81.01.0.230 time range 0.1s-10h 12-230V AC/DC 16A mounting measurements DIN railmm 1CO connection grip connection		
For models:	161, 221, 271, 272, 362, CLEAN-161, CLEAN-221, CLEAN-271, CLEAN-272, CLEAN-362, E.60, E.65, E1, E10, E100, E110, E12, E120, E14, E140		

transformers

open transformers

with clamp terminal



1

Part No.	401604	Ref. No.	DET313
description	transformer primary 230/400VAC secondary 12VAC 160VA		



electronic controllers

LAE

universal controllers

built-in version



1	Part No.	378340	Ref. No.	927289
description	electronic controller LAE type AC1-5PS1RD mounting measurements 71x29mm 12V voltage AC/DC Pt100 relay outputs 1 CO-12A(4) Pt100 built-in depth 70mm protection IP54 built-in version defr. funct. -100 up to +850°C display 3 digits			

miscellaneous

electronic thermometers



1	Part No.	403327	Ref. No.	927333
description	thermometer ARTHHERMO type ROF-DIG/12 mounting measurements 58x26mm 12V voltage AC -30 jusqu'à +110°C measuring input NTC display 3 digits front measurements 64x31mm			
For models:	161, 221, 271, 272, 362, CLEAN-161, CLEAN-221, CLEAN-271, CLEAN-272, CLEAN-362			

probes

universal probes

temperature probes



1	Part No.	379142	Ref. No.	927335
description	temperature probe PTC 1kOhm cable PVC probe -50 up to +150°C cable -10 up to 100°C probe ø6x30mm cable length 1.5m without screw connection 2-wire			
For models:	161, 221, 271, 272, 362, CLEAN-161, CLEAN-221, CLEAN-271, CLEAN-272, CLEAN-362			

producer-specific probes

probes



1	Part No.	379101	Ref. No.	231006
description	temperature probe NTC 10kOhm cable PVC probe -40 up to +110°C cable -10 up to 100°C connection plug thread probe ø4.5x30mm cable length 0.35m			
For models:	35-ELECTRONIC, 35F, 35FD, 35R, 35RD, 40-ELECTRONIC, 40F, 40FD, 40R, 40RD, 44F, 45, 46, 50-ELECTRONIC, 50F, 50FD			



1	Part No.	403103	Ref. No.	927172
description	temperature probe Pt100 cable PTFE probe -100 up to 450°C cable -40 up to +250°C connection 3-wire thread probe ø6x70mm cable length 10m			

accessories

miscellaneous



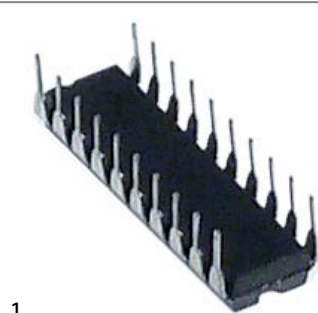
1	Part No.	379905	Ref. No.	231008
description	extension			
For models:	46, 50-ELECTRONIC, 50F, 50FD			

electronics


EPROMS



1	Part No.	400900	Ref. No.	225029
description	EPROM CODE 225029-3			
For models:	MISTRAL-40, MISTRAL-51, NIAGARA-35, NIAGARA-40, NIAGARA-51, RIVER-40, RIVER-50, RIVER-61			




1	Part No.	401917	Ref. No.	225034
description	EPROM CODE 225034			
For models:	2312-009-CRP, RIVER-40-CRP, RIVER-50-CRP			


1

Part No.	401558	Ref. No.	81000 81010
description	EPROM CODE 81000-1		
For models:	80, 81, CGL74CABT, LP60, RIVER-71, RIVER-80, River-81, RIVER-82, RV71, RV80, RV8023, RV8023HZ, RV80C, RV80HZ, RV81, RV8123, RV81A, RV81C, RV81HZ, RV81HZ23, RV81PAP, RV82, RV8223, RV82C, SevenL, U60E		




1

Part No.	403248	Ref. No.	225033
description	EPROM for dishwasher CODE 225033-1 unsuitable for MaidaId		
For models:	NIAGARA-45		




1

Part No.	401559	Ref. No.	81021
description	EPROM CODE 81000-1		
For models:	CE78HZ23, E78, E78HP, FAST-181, HM1, RIVER-E78, ST70FAST		




1

Part No.	403249	Ref. No.	225044
description	EPROM for dishwasher CODE 225044-2		
For models:	2312-007, 914624, 914625, 914627, 914850, 914851, 914854		




1

Part No.	403247	Ref. No.	225031
description	EPROM for dishwasher CODE 225031-5		
For models:	050F, 050FP, 913911, 913912, 913913, 913914, 913950, 913977, 913984, 913990, 914165, 914166, 914206, 914214, 914284, 914316, 914317, 914318, 914319, 914338, 914355, 914356, 914431, 914516, 914543, 914642, 914684, 914874, 914909, 915136, 915137, 915138, F85, F85P, MINIBAR, Mistral40, MISTRAL-40, Mistral51, MISTRAL-51, NIAGARA-35, Niagara-40, NIAGARA-51, River-39, S280		




1

Part No.	403246	Ref. No.	81006
description	EPROM for dishwasher CODE 81006-5		
For models:	PS-60		



1

Part No.	403245	Ref. No.	225032
description	EPROM for dishwasher CODE 225032-2		
For models:	914167, 914168, 914943, NIAGARA-45		





1


Part No.	403244	Ref. No.	81008
description	EPROM for dishwasher CODE 81008		
For models:	RIVER-152, River-154, RV152, RV152D, RV152DA, RV152DARY, RV152DAY, RV152DW, RV152S, RV152SA, RV152SAW, RV152SE, RV152SW, RV152SY, RV154, RV154BT, RV154BTSAE, RV154D, RV154DA, RV154DARY, RV154DAW, RV154DAY, RV154DY, RV154S, RV154SA, RV154SAW, RV154SAY, RV154SC, RV154SY		






			
1			
Part No.	403241	Ref. No.	81001
description	EPROM type U61E for dishwasher CODE 81001-3		
For models:	KLP105EB, KLP201DDDTEB, KLP201EB, KLP301, KLP301DDDTEB, LP105DDDTEB, LP105DDDTEBN, LP105EB, LP201DDDTEB, LP201EB, LP301, LP301EB, River-81CRP, RIVER-81-CRP, River-82CRP, RIVER-82-CRP, RV81CCRP, RV81CRP, RV82CCRP, RV82CRP, U132E, U61E, U61HE, U70e		


PCBs


			
1			
Part No.	400897	Ref. No.	227059 227084
description	display PCB dishwasher GS 60		
For models:	050F, 050FP, 2312-007, 2312-009-CRP, 80, 81, 82, 913911, 913912, 913913, 913914, 913950, 913977, 913984, 913990, 913992, 913993, 914100, 914101, 914165, 914166, 914167, 914168, 914206, 914214, 914284, 914316, 914317, 914318, 914319, 914338, 914339, 914342, 914343, 914355, 914356, 914431, 914516, 914543, 914583, 914592, 914612, 914613, 914624, 914625, 914626, 914627, 914628, 914642, 914684...(Other models you can see in the webshop)		
accessories for	400897		
	Part No.	403250	Ref. No. 80933 926272
	ribbon cable 10-pole L 3200mm plug type coded 2 row plug: number of poles 10		

			
1			
Part No.	403102	Ref. No.	227074
description	keypad PCB dishwasher L 170mm W 35mm with display buttons 3		
For models:	915150, 915151, 915152, 915166, 915167, 915168, 915348, 915420, 915421, 915479, 915547, 915558, 915614, 915615, 915616, 915635, 915671, 915747, 915959, NG271, NG281, NG281CDD, NG281HP, NG281HPDD, NG281HZ23, NG281HZ23DD, NG291, NG292, NG292HZ, NG293, NIAGARA-241, Niagara-251, NIAGARA-261, NIAGARA-271, NIAGARA-281, Niagara-281HP, NIAGARA-291, NIAGARA-292, Niagara-292-400V-3Ph-60Hz, NIAGARA-293		

			
1			
Part No.	402319	Ref. No.	41600
description	keypad PCB dishwasher LP10/20/30		
For models:	914380, 914436, KLP105EB, KLP201DDDTEB, KLP201EB, KLP301DDDTEB, LP105DDDTEB, LP105DDDTEBN, LP105EB, LP201DDDTEB, LP201EB, LP301EB, RIVER-150, River-152, RIVER-154, RV150, RV15023, RV15023DA, RV150D, RV150DA, RV150DAR, RV150DARY, RV150DAW, RV150DAWY, RV150DAY, RV150DE, RV150DRW, RV150DW, RV150DWY, RV150DY, RV150HZ23, RV150S, RV150SA, RV150SAC, RV150SAEW, RV150SAR, RV150SAW, RV150SAWY, RV150SAY, RV150SB, RV150SE, RV150SW, RV150SWY, RV150SY, RV152, RV152D, RV152DA, RV152DARY, RV152DAY, RV152DW...(Other models you can see in the webshop)		


			
1			
Part No.	400898	Ref. No.	80889 80899 80900
description	keypad PCB dishwasher LP10/20/30 with display		
For models:	CGL74CABT, CNT800CH, KLP301, LP301, River-295P, River-296P, RIVER-HL-82, RV295PS, RV296PS, SevenE, SevenL		
accessories for	400898		
	Part No.	402970	Ref. No. 41523
	ribbon cable 10-pole L 1200mm plug type 2 row coded Qty 1m		

			
1			
Part No.	403270	Ref. No.	227083 80929
description	keypad PCB for dishwasher River 252/262 L 220mm W 40mm with display buttons 3		
For models:	915154, 915155, 915157, 915158, 915172, 915173, 915285, 915422, 915492, 915493, 915494, 915495, 915496, 915497, 915617, 915618, 915672, 915747, 915773, 915774, 916054, Fast200, FAST-200, Fast93, GL280EB, GL280EB23, GL280EB23DAR, GL280EB23HZ, GL280EB23HZDY, GL280EBD, GL280EBDA, GL280EBDAE, GL280EBDAR, GL280EBDARY, GL280EBDAW, GL280EBDAWY, GL280EBDAY, GL280EBDB, GL280EBDBR, GL280EBDBW, GL280EBDWY, GL280EBDY, GL280EBS, GL280EBSA, GL280EBSAE, GL280EBSAEW, GL280EBSAEWY, GL280EBSAR, GL280EBSARY, GL280EBSAW...(Other models you can see in the webshop)		


1

Part No.	400157	Ref. No.	215009 215013
description	PCB dishwasher 35/40/50/350		
For models:	35-ELECTRONIC, 35F, 35FD, 35R, 35RD, 40-ELECTRONIC, 40F, 40FD, 40R, 40RD, 45, 46, 50-ELECTRONIC, 50F, 50FD		



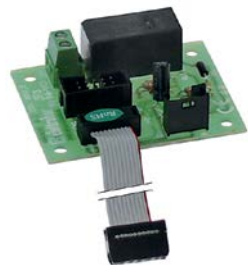
1

Part No.	403093	Ref. No.	215033 215038
description	PCB dishwasher L 135mm W 82mm		
For models:	913363, 913364, 915611, 915612, 915613, 915670, 915686, 915687, 915689, 915690, 915691, 915692, 915693, 915694, 915695, 915696, 915819, 916162, 916788, E.41, Fast135CT, Fast135D, Fast135H, Fast135HCT, Fast135HD, Fast139, Fast139CT, Fast139D, Fast140, Fast145, Fast145D, PLUVIA-240		




1

Part No.	402880	Ref. No.	215027
description	PCB dishwasher L 152mm W 80mm		
For models:	915150, 915151, 915152, 915166, 915167, 915168, 915348, 915420, 915421, 915479, 915547, 915558, 915614, 915615, 915616, 915635, 915671, 915747, 915959, NG271, NG281, NG281CDD, NG281HP, NG281HPDD, NG281HZ23, NG281HZ23DD, NG291, NG292, NG292HZ, NG293, NIAGARA-241, Niagara-251, NIAGARA-261, NIAGARA-271, NIAGARA-281, Niagara-281HP, NIAGARA-291, NIAGARA-292, Niagara-292-400V-3Ph-60Hz, NIAGARA-293		



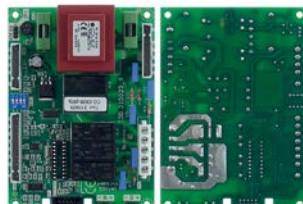
1

Part No.	401049	Ref. No.	215022
description	PCB dishwasher LP10/20/30		
For models:	2312-009-CRP, 914380, 914436, 914583, 914628, 914944, 915143, KLP105EB, KLP201DDTEB, KLP201EB, KLP301, KLP301DDTEB, LP105DDTEB, LP105DDTEBN, LP105EB, LP201DDTEB, LP201EB, LP301, LP301EB, RIVER-150, River-152, RIVER-154, RIVER-40-CRP, RIVER-44-CRP, RIVER-44-CRP-ST, RIVER-44CRP-ST, RIVER-50-CRP, RIVER-50-CRP-SP, RIVER-54CRP, River-54-CRP-s.p., RIVER-54-CRP-SP, River-81CRP, RIVER-81-CRP, River-82CRP, RIVER-82-CRP, RIVER-HL-81, RIVER-HL-82, RV150, RV15023, RV15023DA, RV150D, RV150DA, RV-150DAR, RV150DARY, RV150DAW, RV150DAWY, RV150DAY, RV150DE, RV150DRW, RV150DW...(Other models you can see in the webshop)		








1

Part No.	403509	Ref. No.	999298
description	PCB warewashing NIAGARA/SILVER		
For models:	CNT800CH, NIAGARA-283, Niagara-283A, SevenE, SV72AEB, SV72EB		



1

Part No.	400899	Ref. No.	215023
description	power PCB dishwasher LP10/20/30 without EPROM		
For models:	050F, 050FP, 2312-007, 2312-009-CRP, 80, 81, 82, 913911, 913912, 913913, 913914, 913950, 913977, 913984, 913990, 913992, 913993, 914100, 914101, 914165, 914166, 914167, 914168, 914206, 914214, 914284, 914316, 914317, 914318, 914319, 914338, 914339, 914342, 914343, 914355, 914356, 914380, 914431, 914436, 914516, 914543, 914583, 914592, 914612, 914613, 914624, 914625, 914626, 914627, 914628...(Other models you can see in the webshop)		
accessories for	400899		
	Part No.	400761	Ref. No. CN5
	plug connector 5-pole		
	Part No.	400900	Ref. No. 225029
	EPROM CODE 225029-3		
	Part No.	401558	Ref. No. 81000 81010
	EPROM CODE 81000-1		
	Part No.	403241	Ref. No. 81001
	EPROM type U61E for dishwasher CODE 81001-3		
	Part No.	550048	Ref. No. —
	female bullet		



keypads

front foils



Part No.	402166	Ref. No.	025635
description	front foil dishwasher E.50-51 L 420mm W 35mm		
For models:	913297, 913298, 913299, 913300, 913360, 913361, 913391, 913392, 913546, 913547, 913578, 913611, 913684, 913932, 913933, 914331, 914400, 914401, 914402, 914403, 914404, 914405, 914449, 914517, 914545, 914568, 914688, 914979, 915140, 915248, E.50, E.50D.PA, E.51		



Part No.	403782	Ref. No.	70704 70727
description	front foil dishwasher ELETTROBAR / NIAGARA L 258mm W 36mm		
For models:	916196, 916197, 916198, 916199, 916200, 916201, 916202, 916203, 916204, 916205, 916206, 916207, 916208, 916209, 916367, 916409, 916410, 916411, 916412, 916413, 916414, 916415, 916416, 916417, 916591, 916592, 916593, 916684, 916685, 916761, 916762, 916802, 916812, 916813, 916877, 916878, 916885, NG381, NG38123, NG-38123TERMO, NG381C, NG381CDD, NG381CFUR, NG381DDHZ23, NG381DDPS, NG381DDPSHZ23, NG381HPDD, NG381L, NG381LC, NG381LCFUR...(Other models you can see in the webshop)		



Part No.	403243	Ref. No.	025898
description	front foil dishwasher Niagara 261 blue L 448mm W 53mm		
For models:	915166, 915167, 915168, 915348, 915420, 915421, 915479, 915547, 915558, 915635, 915747, NIAGARA-261		



Part No.	401596	Ref. No.	36782
description	keypad foil dishwasher L20		



Part No.	505276	Ref. No.	36784
description	keypad foil dishwasher L25 L 494mm W 84mm buttons 4		

accessories



Part No.	346850	Ref. No.	80883
description	push button no lens blue ø 21mm		

KEYPADS/SOLENOID VALVES ELETTROBAR



Part No.	346849	Ref. No.	80884
description	push button with lens blue ø 21mm		

solenoïd valves

solenoïd valves (water)

ELBI

straight



Part No.	373017	Ref. No.	240016 240021
-----------------	--------	-----------------	------------------

description solenoid valve single straight 230VAC inlet 3/4" outlet 11.5mm DN10 ELBI

For models: 80, 81, 82, 915150, 915151, 915152, 915154, 915155, 915157, 915158, 915160, 915161, 915162, 915166, 915167, 915168, 915172, 915173, 915175, 915176, 915177, 915319, 915338, 915341, 915348, 915418, 915419, 915420, 915421, 915422, 915479, 915483, 915484, 915492, 915493, 915494, 915495, 915496, 915497, 915537, 915538, 915539, 915540, 915547, 915558, 915611, 915612, 915613, 915614, 915615... (Other models you can see in the webshop)

spare parts for 373017

Part No.	370467	Ref. No.	—
-----------------	--------	-----------------	---

description solenoid valve filter suitable for ELBI





Part No.	370315	Ref. No.	929172
-----------------	--------	-----------------	--------







description solenoid valve double straight 230VAC inlet 3/4" outlet 11.5mm input 16l/min t.max. 90°C ELBI plastic flow regulating valve inlet black
















For models: 914380, 914436, Fast200, FAST-200, Fast93, GL280EB, GL280EB23, GL280EB23DAR, GL280EB23HZ, GL280EB23HZDY, GL280EBD, GL280EBDA, GL280EBDAE, GL280EBDAR, GL280EBDARY, GL280EBDAW, GL280EBDAWY, GL280EBDAY, GL280EBDB, GL280EBDBR, GL280EBDBW, GL280EBDWY, GL280EBDY, GL280EBS, GL280EBSA, GL280EBSAE, GL280EBSAEW, GL280EBSAEWY, GL280EBSAR, GL280EBSARY, GL280EBSAW, GL280EBSAWY, GL280EBSAY, GL280EBSB, GL280EBSR, GL280EBSWY, GL280EBSY, GL282EB, GL282EB93, GL282EB93DA, GL282EB93HZ23, GL282EBCH, GL282EBCHD, GL282EBD, GL282EBDA, GL282EBDAE, GL282EBDAR, GL282EBDARW, GL282EBDAWY, GL282EBDBW...(Other models you can see in the webshop)



			
1			
Part No.	370246	Ref. No.	240010
description	solenoid valve double straight 230VAC inlet 3/4" outlet 11.5mm t.max. 90°C ELBI plastic output B 0.5l/min flow regulating valve outlet B red		
For models:	050F, 050FP, 11F, 11FD, 11R, 11RD, 2312-001, 2312-002, 2312-007, 31F, 31FD, 31R, 31RD, 350F, 350FD, 350R, 350RD, 35-ELECTRONIC, 35F, 35FD, 35R, 35RD, 400F, 400FD, 400R, 400RD, 40-ELECTRONIC, 40F, 40FD, 40R, 40RD, 46, 460, 500F, 500FD, 50-ELECTRONIC, 50F, 50FD, 510F, 510FD, 913289, 913290, 913291, 913292, 913297, 913298, 913299, 913300, 913356, 913357...(Other models you can see in the webshop)		





			
1			
Part No.	370247	Ref. No.	240002
description	solenoid valve triple straight 230VAC inlet 3/4" outlet 11.5mm t.max. 90°C ELBI plastic flow regulating valve inlet orange output B 0.5l/min flow regulating valve outlet B red		
For models:	11F, 11FD, 11F-DVGW, 11R, 11RD, 21F, 21FD, 21R, 21RD, 25F, 25FD, 25R, 25RD, 30F, 30FD, 30R, 30RD, 31F, 31FD, 31R, 31RD, 350F, 350FD, 350R, 350RD, 35-ELECTRONIC, 35F, 35FD, 35R, 35RD, 400F, 400FD, 400R, 400RD, 40-ELECTRONIC, 40F, 40FD, 40R, 40RD, 45, 450, 46, 460, 50F, 50FD, 510F, 510FD, 55, 67F, 67R...(Other models you can see in the webshop)		

<p>TP</p>  			
1			
Part No.	370021	Ref. No.	240003
description	solenoid valve double straight 230VAC inlet 3/4" outlet 11.5mm DN10 TP flow regulating valve inlet white		
For models:	11F, 11FD, 11F-DVGW, 11R, 11RD, 21F, 21FD, 21R, 21RD, 22F, 22R, 25F, 25FD, 25R, 25RD, 30F, 30FD, 30R, 30RD, 31F, 31FD, 31R, 31RD, 350F, 350FD, 350R, 350RD, 400F, 400FD, 400R, 400RD, 40-ELECTRONIC, 40F, 40FD, 40R, 40RD, 44F, 46, 460, 50F, 50FD, 510F, 510FD, 55, 66, 67F, 67R, 913363, 913364, 913376...(Other models you can see in the webshop)		
spare parts for	370021		
		Part No.	371013 Ref. No. —
accessories for	370021		
		Part No.	371220 Ref. No. —
		Part No.	371221 Ref. No. —
		Part No.	371222 Ref. No. —

accessories for	370021		
		Part No.	371223 Ref. No. —
		Part No.	371224 Ref. No. —
		Part No.	371225 Ref. No. —
		Part No.	371226 Ref. No. —
		Part No.	371230 Ref. No. —
		Part No.	371231 Ref. No. —
		Part No.	371232 Ref. No. —
		Part No.	371233 Ref. No. —
		Part No.	371234 Ref. No. —
		Part No.	371235 Ref. No. —
		Part No.	371236 Ref. No. —
		Part No.	371237 Ref. No. —
		Part No.	371238 Ref. No. —
		Part No.	371239 Ref. No. —
		Part No.	371240 Ref. No. —



			
1			
Part No.	370111	Ref. No.	927001
description	solenoid valve double straight 24VAC inlet 3/4" outlet 11.5mm DN10 TP		
For models:	161, 221, 271, 272, 362, CLEAN-160, CLEAN-161, CLEAN-220, CLEAN-221, CLEAN-270, CLEAN-271, CLEAN-272, CLEAN-362		
spare parts for	370111		
	Part No.	371035	Ref. No. —
solenoid coil 24VAC			
accessories for	370111		
	Part No.	371220	Ref. No. —
reducer TP flow rate 3l/min red tolerance ±15%			
	Part No.	371221	Ref. No. —
reducer TP flow rate 5.5l/min yellow tolerance ±15%			
	Part No.	371222	Ref. No. —
reducer TP flow rate 6l/min grey tolerance ±15%			
	Part No.	371223	Ref. No. —
reducer TP flow rate 10l/min white tolerance ±15%			
	Part No.	371224	Ref. No. —
reducer TP flow rate 12l/min bronze tolerance ±15%			
	Part No.	371225	Ref. No. —
reducer TP flow rate 16l/min light brown tolerance ±15%			
	Part No.	371226	Ref. No. —
reducer TP flow rate 20l/min red tolerance ±15%			
	Part No.	371230	Ref. No. —
reducer TP flow rate 0.25l/min red tolerance ±25%			
	Part No.	371231	Ref. No. —
reducer TP flow rate 0.35l/min violet tolerance ±25%			
	Part No.	371232	Ref. No. —
reducer TP flow rate 0.5l/min orange tolerance ±25%			
	Part No.	371233	Ref. No. —
reducer TP flow rate 0.8l/min white tolerance ±25%			
	Part No.	371234	Ref. No. —
reducer TP flow rate 1l/min light blue tolerance ±25%			
	Part No.	371235	Ref. No. —
reducer TP flow rate 1.2l/min brown tolerance ±25%			
	Part No.	371236	Ref. No. —
reducer TP flow rate 1.5l/min light brown tolerance ±25%			

accessories for	370111		
	Part No.	371237	Ref. No. —
reducer TP flow rate 2.5l/min yellow tolerance ±25%			
	Part No.	371238	Ref. No. —
reducer TP flow rate 3.4l/min dark green tolerance ±25%			
	Part No.	371239	Ref. No. —
reducer TP flow rate 5l/min black tolerance ±25%			
	Part No.	371240	Ref. No. —
reducer TP flow rate 8l/min blue tolerance ±20%			











			
1			
Part No.	370017	Ref. No.	240005 240011 240018
description	solenoid valve single straight 230VAC inlet 3/4" outlet 11.5mm DN10 TP p max 10bar		
For models:	050F, 050FP, 10, 11F, 11FD, 11F-DVGW, 11R, 11RD, 12, 14, 21F, 21FD, 21R, 21RD, 22F, 2312-001, 2312-002, 2312-007, 2312-009-CRP, 25F, 25FD, 25R, 25RD, 30F, 30FD, 30R, 30RD, 31F, 31FD, 31R, 31RD, 350F, 350FD, 350R, 350RD, 35-ELECTRONIC, 35F, 35FD, 35R, 35RD, 400F, 400FD, 400R, 400RD, 40-ELECTRONIC, 40F, 40FD, 40R, 40RD, 440F... (Other models you can see in the webshop)		
spare parts for	370017		
	Part No.	371013	Ref. No. —
solenoid coil TP 230VAC 50/60Hz			
accessories for	370017		
	Part No.	371220	Ref. No. —
reducer TP flow rate 3l/min red tolerance ±15%			
	Part No.	371221	Ref. No. —
reducer TP flow rate 5.5l/min yellow tolerance ±15%			
	Part No.	371222	Ref. No. —
reducer TP flow rate 6l/min grey tolerance ±15%			
	Part No.	371223	Ref. No. —
reducer TP flow rate 10l/min white tolerance ±15%			
	Part No.	371224	Ref. No. —
reducer TP flow rate 12l/min bronze tolerance ±15%			
	Part No.	371225	Ref. No. —
reducer TP flow rate 16l/min light brown tolerance ±15%			
	Part No.	371226	Ref. No. —
reducer TP flow rate 20l/min red tolerance ±15%			
	Part No.	371230	Ref. No. —
reducer TP flow rate 0.25l/min red tolerance ±25%			

Table continues overleaf



accessories for		370017		
Part No.	371231	Ref. No.	—	
	reducer TP flow rate 0.35l/min violet tolerance ±25%			
Part No.	371232	Ref. No.	—	
	reducer TP flow rate 0.5l/min orange tolerance ±25%			
Part No.	371233	Ref. No.	—	
	reducer TP flow rate 0.8l/min white tolerance ±25%			
Part No.	371234	Ref. No.	—	
	reducer TP flow rate 1l/min light blue tolerance ±25%			
Part No.	371235	Ref. No.	—	
	reducer TP flow rate 1.2l/min brown tolerance ±25%			
Part No.	371236	Ref. No.	—	
	reducer TP flow rate 1.5l/min light brown tolerance ±25%			
Part No.	371237	Ref. No.	—	
	reducer TP flow rate 2.5l/min yellow tolerance ±25%			
Part No.	371238	Ref. No.	—	
	reducer TP flow rate 3.4l/min dark green tolerance ±25%			
Part No.	371239	Ref. No.	—	
	reducer TP flow rate 5l/min black tolerance ±25%			
Part No.	371240	Ref. No.	—	
	reducer TP flow rate 8l/min blue tolerance ±20%			

solenoid valves with reducers			
<p>1</p>			
Part No.	370245	Ref. No.	927242 DEV34S16 LF-3120530
description	solenoid valve single straight 24VAC inlet 3/4" outlet 11.5mm input 16l/min t.max. 90°C TP plastic flow regulating valve inlet light brown		
For models:	161, 221, 271, 272, 362, A4EBSAKCK, CLEAN-160, CLEAN-161, CLEAN-220, CLEAN-221, CLEAN-270, CLEAN-271, CLEAN-272, CLEAN-361, CLEAN-361P, CLEAN-362, CLEAN-471, CLEAN-471P		

various			
<p>1</p>			
Part No.	370726	Ref. No.	999288
description	solenoid valve double straight 220-240VAC inlet 11mm outlet 11mm MILANO plastic output B red		
For models:	913364, 915150, 915151, 915152, 915154, 915155, 915157, 915158, 915160, 915161, 915162, 915166, 915167, 915168, 915172, 915173, 915175, 915285, 915319, 915348, 915418, 915419, 915420, 915421, 915422, 915479, 915483, 915484, 915492, 915493, 915494, 915495, 915496, 915497, 915537, 915538, 915539, 915540, 915547, 915558, 915611, 915612, 915613, 915614, 915615, 915616, 915617, 915618, 915635, 915663...(Other models you can see in the webshop)		

<p>1</p>			
Part No.	370636	Ref. No.	240020
description	solenoid valve single CO 230VAC outlet 10.5mm MILANO 00168401 plastic 3-ways inlet 10.5mm 50/60Hz male faston 6.3mm		
For models:	915154, 915155, 915157, 915158, 915166, 915167, 915168, 915172, 915173, 915175, 915176, 915177, 915285, 915338, 915341, 915348, 915420, 915421, 915422, 915492, 915493, 915494, 915495, 915496, 915497, 915547, 915558, 915617, 915618, 915663, 915672, 915747, 915773, 915774, 916054, 916066, 916067, 916068, 916069, 916077, 916078, 916079, 916080, 916368, 916418, 916419, 916420, 916421, 916422, 916423...(Other models you can see in the webshop)		
accessories for	370636		
Part No.	371142	Ref. No.	133009
	reducer for solenoid valve ø 8.2mm		



metal

ASCO

solenoid valves steam (water)

2-way



1

Part No.	370728	Ref. No.	927148
description	solenoid valve 2-ways 24VAC inlet 1/2" IT outlet 1/2" IT connection 1/2" L 62mm DN 12mm t.max. 85°C slide-on receptacle DIN -10 up to +85°C Asco type series E238C coil type 43005421 membranes NBR p max 10bar p min 0.3bar 50/60Hz brass		
For models:	CLEAN-361, CLEAN-361P, CLEAN-471, CLEAN-471P		

Solenoid valve - accessories



1

Part No.	371142	Ref. No.	133009
description	reducer for solenoid valve ø 8.2mm		
For models:	915166, 915167, 915168, 915175, 915176, 915177, 915338, 915341, 915348, 915420, 915421, 915547, 915558, 915663, 915747, NIAGARA-251, NIAGARA-261, PLUVIA-260, Pluvia-270		

pressure switches

for warewashing

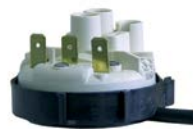
ø 58mm with male faston 6.3mm

with connection horizontal



1

Part No.	541002	Ref. No.	224002
description	pressure control pressure range 110/60mbar connection 6mm ø 58mm pressure connection horizontal warewashing pressure connection ø 6mm		
For models:	66, 80, 81, 82, CE78HZ23, E78, E78HP, HM1, LP60, NG381L, NG381LC, NG381LCFUR, NG381LDDPS, Niagara-283L-2, Niagara-381L, Niagara-381LC, R495, R499, R501, R503, R505, R507, R509, R511, R704, R706, R708, RIVER-282, River-282-2, River-282L-2, River-282LS-2TDE, River-282S-2TDE, River-285, RIVER-294, RIVER-295, River-295P, RIVER-296, River-296P, RIVER-297, RIVER-298, River-382, River-382-230V-3Ph-50Hz, River-382H, River-382L, River-382L-230V-3Ph-50Hz, River-382LNRG, River-382LTDE, River-382NRG, River-382NRG-230-3Ph-50Hz, River-382TDE...(Other models you can see in the webshop)		



1

Part No.	541102	Ref. No.	224006
description	pressure control pressure range 115/15mbar connection 6mm ø 58mm pressure connection horizontal warewashing		
For models:	915747, A4EBT, A4EBTSAK, CLEAN-3, River-multi-2256		



1

Part No.	541647	Ref. No.	224011
description	pressure control pressure range 115/85mbar connection 6mm ø 58mm pressure connection ø 6mm		
For models:	914326, 914406, 915729, E.55, FAST-63, RIVER-43		




1

Part No.	543024	Ref. No.	224026
description	pressure control pressure range 120/95mbar connection F6.3 ø 5.5mm		
For models:	915611, 915612, 915613, 915614, 915615, 915616, 915670, 915671, 915959, 916196, 916197, 916198, 916199, 916200, 916409, 916410, 916591, 916592, 916593, 916877, NIAGARA-241, Niagara-241-2, Niagara-341, Pluvia-240		




1

Part No.	541899	Ref. No.	224022 224025
description	pressure control pressure range 125/105mbar connection 6mm ø 58mm pressure connection horizontal warewashing pressure connection ø 6mm		
For models:	915150, 915151, 915152, 915154, 915155, 915157, 915158, 915160, 915161, 915162, 915166, 915167, 915168, 915175, 915176, 915177, 915319, 915338, 915341, 915348, 915418, 915419, 915420, 915421, 915479, 915492, 915493, 915494, 915495, 915547, 915558, 915635, 915663, 915747, 916201, 916202, 916203, 916204, 916205, 916206, 916207, 916208, 916209, 916365, 916366, 916367, 916411, 916412, 916413, 916414...(Other models you can see in the webshop)		


1

Part No.	541166	Ref. No.	224008
description	pressure control pressure range 140/110mbar connection 6mm ø 58mm pressure connection horizontal warewashing		
For models:	2312-009-CRP, PS-60, RIVER-40, RIVER-44, RIVER-44-CRP, RIVER-48, RIVER-50, RIVER-50-CRP, RIVER-61		




1

Part No.	543025	Ref. No.	224027
description	pressure control pressure range 155/130mbar connection F6.3 ø 5.5mm		
For models:	915611, 915612, 915613, 915614, 915615, 915616, 915670, 915671, 915959, 916196, 916197, 916198, 916199, 916200, 916409, 916410, 916591, 916592, 916593, 916877, Niagara-241, Niagara-241-2, Niagara-341, Pluvia-240		




1

Part No.	541898	Ref. No.	224023
description	pressure control pressure range 165/140mbar connection 6mm ø 58mm pressure connection horizontal warewashing pressure connection ø 6mm		
For models:	915150, 915151, 915152, 915154, 915155, 915160, 915161, 915162, 915166, 915167, 915168, 915175, 915176, 915177, 915319, 915338, 915341, 915348, 915418, 915419, 915420, 915421, 915479, 915492, 915493, 915547, 915558, 915635, 915663, 915747, 916201, 916202, 916203, 916204, 916205, 916206, 916207, 916208, 916209, 916365, 916366, 916367, 916411, 916412, 916413, 916414, 916415, 916416, 916417, 916684...(Other models you can see in the webshop)		




1

Part No.	541103	Ref. No.	224007
description	pressure control pressure range 170/140mbar connection 6mm ø 58mm pressure connection horizontal warewashing		
For models:	CLEAN-3		




1

Part No.	541105	Ref. No.	926049
description	pressure control pressure range 180/70mbar connection 6mm ø 58mm pressure connection horizontal warewashing		
For models:	12, 14, 161, 221, 271, 272, 362, 80, 81, 82, 914380, 914436, 915747, 915773, A3EB, A3EBD, A3EBDAKRKYK, A3EBDAKWK, A3EBDBKWK, A3EBDRKYK, A3EBDWK, A3EBDYK, A3EBSAK, A3EBSAKRK, A3EBSAKWK, A3EBSBKWKYK, A3EBSEKWK, A3EBSWK, A4EB, A4EBD, A4EBDAKEKYK, A4EBDAKRK, A4EBDAKWK, A4EBDAKZK, A4EBDBKRW, A4EBDPKWKYK, A4EBDRK, A4EBS, A4EBSAK, A4EBSAKCK, A4EBSAKKEYK, A4EBSAKRK, A4EBSAKRKPK, A4EBSAKYK, A4EBSCK, A4EBT, A4EBTSAK, A5EB, A5EBD, A5EBDAKPKWK...(Other models you can see in the webshop)		



1

Part No.	541778	Ref. No.	224009
description	pressure control pressure range 208/178mbar connection 6mm ø 58mm pressure connection horizontal warewashing pressure connection ø 6mm		
For models:	2312-009-CRP, RIVER-48, RIVER-50, RIVER-50-CRP, RIVER-61		




1

Part No.	541001	Ref. No.	224004
description	pressure control pressure range 35/17mbar connection 6mm ø 58mm pressure connection horizontal warewashing		
For models:	11F, 11FD, 11F-DVGW, 11R, 11RD, 2312-009-CRP, 350F, 350FD, 350R, 350RD, 35-ELECTRONIC, 35F, 35FD, 35R, 35RD, 400F, 400FD, 400R, 400RD, 40-ELECTRONIC, 40F, 40FD, 40R, 40RD, 440F, 44F, 67F, 67R, 913289, 913290, 913291, 913292, 913356, 913357, 913363, 913364, 913372, 913373, 913374, 913375, 913376, 913377, 913416, 913435, 913544, 913545, 913665, 913666, 913667, 913668...(Other models you can see in the webshop)		




1

Part No.	541010	Ref. No.	224028
description	pressure control pressure range 50/30mbar connection 6mm ø 58mm pressure connection horizontal warewashing		
For models:	915617, 915618, 915672, 915773, 915774, 916066, 916077, 916078, 916418, 916419, 916594, 916595, RIVER-242, River-242-2, River-242-2T, River-342C, River-342T		


1

Part No.	541013	Ref. No.	929039
description	pressure control pressure range 55/25mbar connection 6mm ø 58mm pressure connection horizontal warewashing		
For models:	10, 55, CLEAN-100, CLEAN-110, E.60, E.65, E1, E10, E100, E110		




1

Part No.	541003	Ref. No.	224003
description	pressure control pressure range 55/35mbar connection 6mm ø 58mm pressure connection horizontal warewashing pressure connection ø 6mm		
For models:	050F, 050FP, 21F, 21FD, 21R, 21RD, 22F, 22R, 2312-001, 2312-002, 25F, 25FD, 25R, 25RD, 30F, 30FD, 30R, 30RD, 31F, 31FD, 31R, 31RD, 40F, 440F, 44F, 45, 450, 46, 460, 500F, 500FD, 50-ELECTRONIC, 50F, 50FD, 510F, 510FD, 913297, 913298, 913299, 913300, 913360, 913361, 913391, 913392, 913418, 913546, 913547, 913578, 913611, 913684... (Other models you can see in the webshop)		




1

Part No.	541106	Ref. No.	224005
description	pressure control pressure range 90/56mbar connection 6mm ø 58mm pressure connection horizontal warewashing pressure connection ø 6mm		
For models:	050F, 050FP, 22F, 22R, 40F, 440F, 45, 450, 460, 500F, 500FD, 510F, 510FD, E.46, E.50, E.51, E.52, F85, F85P, LF50, LF55, MC501E, MC501EP, MC501S, MC501SP, NIAGARA-51, RIVER-40, RIVER-40-CRP, RIVER-44, RIVER-44-CRP, TF-503		




1

Part No.	541951	Ref. No.	224029
description	pressure control pressure range 90/60mbar connection 6mm ø 58mm pressure connection horizontal warewashing pressure connection ø 6mm		
For models:	916020, 916021, 916024, 916025, 916026, 916027, 916030, 916031, 916045, 916247, 916248, 916249, 916250, 916251, 916252, 916382, 916383, 916452, 916504, 916584, 916654, 916670, 916688, 916763, 916921, 916922, 916992, 916993, 917044, 917049, Clean161, Fast145-2, Fast150, Fast160-2, Fast160C, Fast161-2, Ocean360, Ocean360M, Ocean360-UK		



1


Part No.	541866	Ref. No.	224016
description	pressure control pressure range 90/75mbar connection 6mm ø 58mm pressure connection horizontal warewashing pressure connection ø 6mm		
For models:	2312-007, 913992, 913993, 914100, 914101, 914339, 914342, 914343, 914583, 914592, 914612, 914613, 914624, 914625, 914626, 914627, 914850, 914851, 914854, 915143, RIVER-44, River-44-CRP-ST, RIVER-44CRP-ST, River-48, RIVER-54		



1

Part No.	541017	Ref. No.	69850
description	pressure control with mounting strap pressure range 40/20mbar connection 6mm ø 58mm pressure connection horizontal warewashing		
For models:	Fast181, FAST-181, Fast181-230V-3Ph-60Hz, Fast181-400V-3NPh-60Hz, NG271, NG291, NG381, NG38123, NG38123TERMO, NG381C, NG381CDD, NG381CFUR, NG381DDHZ23, NG381DDPS, NG381D-DPSHZ23, NG381HPDD, NG381TERMO, NG381TXCDD, NIAGARA-271, NIAGARA-283, Niagara-283A, NIAGARA-291, Niagara-381, Niagara-381-230V-3Ph-50Hz, Niagara-381-230V-3Ph-60Hz, Niagara-381DP, Niagara-381HPD, RIVER-294, RV294, ST70FAST, ST70FASTHB, ST70FASTHB400, ST70FASTHZ23, SV72AEB, SV72EB		

miscellaneous



1

Part No.	541950	Ref. No.	224018 999328
description	pressure control kit pressure range 0-30mbar connection 6mm warewashing		
For models:	915172, 915173, 915285, 915422, 915496, 915497, 915617, 915618, 915672, 915773, 915774, 916054, RIVER-242, RIVER-262, RIVER-282, RV282, RV282DD		



accessories



1

Part No.	541109	Ref. No.	035031
description	Y-piece plastic hose \varnothing 8-6-8mm for pressure switch		
For models:	050F, 050FP, 22F, 22R, 2312-002, 2312-007, 2312-009-CRP, 40F, 440F, 45, 450, 460, 500F, 500FD, 510F, 510FD, 913297, 913298, 913299, 913300, 913360, 913361, 913391, 913392, 913546, 913547, 913578, 913611, 913684, 913913, 913914, 913932, 913933, 913992, 913993, 914100, 914101, 914284, 914318, 914319, 914326, 914331, 914338, 914339, 914342, 914343, 914356, 914400, 914401, 914402...(Other models you can see in the webshop)		

flow meters and flow sensors

flow meters

miscellaneous



1

Part No.	402680	Ref. No.	240017 240998
description	flow meter pressure range 0.2-10bar connection 10mm L 69mm		
For models:	80, 81, 82, MISTRAL-40, MISTRAL-51, NIAGARA-35, NIAGARA-40, NIAGARA-45, NIAGARA-51, RIVER-40, RIVER-43, RIVER-44, RIVER-48, RIVER-50, RIVER-54, RIVER-61, RIVER-80, RIVER-81, RIVER-82		

motors

gear motors

for dishwashers



1

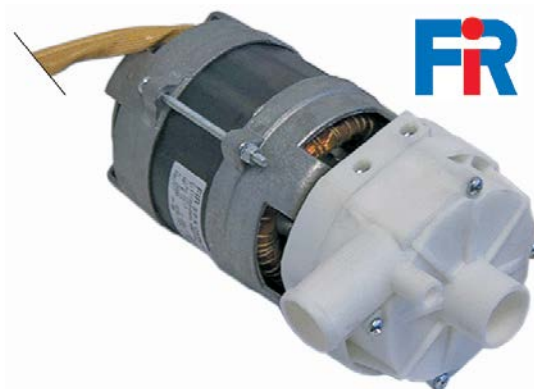
Part No.	601861	Ref. No.	927105
description	gear motor FIR type 71-B5 180W 400V voltage AC 50/60Hz 3 phase 900/1100rpm shaft \varnothing 14mm L 227mm for transport system without gearbox		
For models:	221, 271, 272, 362, A3EB, A3EBD, A3EBDAKRKYK, A3EBDAKWK, A3EBDBKWK, A3EBDRKYK, A3EBDVK, A3EBDYK, A3EBSAK, A3EBS-AKRK, A3EBSAKWK, A3EBSBKWKYK, A3EBSEKWK, A3EBSWK, A4EB, A4EBD, A4EBDAKEKYK, A4EBDAKRK, A4EBDAKWK, A4EBDAKZK, A4EBDBKRK, A4EBDPKWKYK, A4EBDRK, A4EBS, A4EBSAK, A4EBS-AKCK, A4EBSAKEKYK, A4EBSAKRK, A4EBSAKRKP, A4EBSAKYK, A4EBSCK, A4EBT, A4EBTSAK, A5EB, A5EBD, A5EBDAKPKWK, A5EBDAKWK, A5EBDAKYK, A5EBDRK, A5EBS, A5EBSAKPKWK, A5EBSAKRK, A5EBSAKRKYK, A5EBSAKWK, A5EBSAKWKYK, A5EBSBKRKP...(Other models you can see in the webshop)		

pumps

wash and rinse pumps

FIR

pumps



1











Part No.	500037	Ref. No.	929167
description	pump inlet \varnothing 28mm outlet \varnothing 26mm type 2211.1410 230V 50Hz 1 phase 0.074kW 0.1HP L 190mm rotation direction left capacitor 5 μ F FIR		
For models:	915747, KLP105EB, KLP301, KLP301DDDTTEB, LP105DDDTTEB, LP105DDDTTEBN, LP105EB, LP301, LP301EB, LP60, River-81CRP, RIVER-81-CRP, River-82CRP, RIVER-82-CRP, RV81CCRP, RV81CRP, RV82CCRP, RV82CRP, U132E, U60E, U61, U61E, U61H, U61He		
spare parts for	500037		
	Part No.	365017	Ref. No. 206008 206010
	operating capacitor capacity 5 μ F 450V tolerance 5% 50/60Hz ambient temperature max. -25 to +85°C \varnothing 28mm L 54mm M8 plastic connection male faston 6.3mm 16.10.08 protection		
	Part No.	510384	Ref. No. 116020 929182
	pump cover inlet \varnothing 28mm outlet \varnothing 26mm \varnothing 100mm ID \varnothing 76mm		

Table continues overleaf



spare parts for 500037	
	Part No. 510695 Ref. No. 927190 RAT123
mechanical shaft seal height counter ring 5.5mm ID ø 11mm	
	Part No. 521203 Ref. No. 124034 929173
impellor ø 72mm H 18mm thread M7 shaft ø 11mm shaft length 32mm blades 3	
	Part No. 521703 Ref. No. 456038 456063
pump cover gasket EPDM thickness 2.5mm ID ø 75mm Qty 1 pcs	



Part No. 499227 Ref. No. 130108	
description	pump inlet ø 28mm outlet ø 26mm type B236.1400 220-240V 50Hz 1 phase 0.14kW 0.2HP L 200mm rotation direction left capacitor 6.3µF FIR
For models:	400F, 400FD, 400R, 400RD, 40F, 40FD, 40R, 40RD, TF-503
spare parts for 499227	
	Part No. 365012 Ref. No. 206009
operating capacitor capacity 6.3µF 450V tolerance 5% 50Hz ambient temperature max. -25 to +85°C ø 30mm L 61mm M8 plastic connection male faston 6.3mm protection	
	Part No. 510384 Ref. No. 116020 929182
pump cover inlet ø 28mm outlet ø 26mm ø 100mm ID ø 76mm	
	Part No. 510695 Ref. No. 927190 RAT123
mechanical shaft seal height counter ring 5.5mm ID ø 11mm	
	Part No. 521203 Ref. No. 124034 929173
impellor ø 72mm H 18mm thread M7 shaft ø 11mm shaft length 32mm blades 3	
	Part No. 521703 Ref. No. 456038 456063
pump cover gasket EPDM thickness 2.5mm ID ø 75mm Qty 1 pcs	



Part No. 499279 Ref. No. 927137	
description	pump inlet ø 28mm outlet ø 26mm type B246.2520 230/400V 50Hz 3 phase 0.18kW 0.25HP L 265mm rotation direction right FIR
For models:	272, 362, CLEAN-161, CLEAN-221, CLEAN-271, CLEAN-272, CLEAN-361, CLEAN-361P, CLEAN-362, CLEAN-471, CLEAN-471P
spare parts for 499279	
	Part No. 510510 Ref. No. —
pump cover pump type 2212/2228/2229/2211	
	Part No. 510532 Ref. No. 80813
impellor ø 72mm H 22mm shaft ø 11mm shaft length 32mm blades 3	
	Part No. 510695 Ref. No. 927190 RAT123
mechanical shaft seal height counter ring 5.5mm ID ø 11mm	
	Part No. 521703 Ref. No. 456038 456063
pump cover gasket EPDM thickness 2.5mm ID ø 75mm Qty 1 pcs	








Part No. 500544 Ref. No. 926151	
description	pump inlet ø 60mm outlet ø 50mm type 4223.1900 230V 50Hz 1 phase 0.73kW 1HP L 225mm rotation direction right capacitor 16µF FIR
For models:	CLEAN-100, E.60, E100
spare parts for 500544	
	Part No. 365021 Ref. No. 206004
operating capacitor capacity 16µF 425V tolerance 5% 50/60Hz ambient temperature max. -25 to +85°C ø 35mm L 73mm single M8 plastic connection male faston 6.3mm 416.10.99 protection	
	Part No. 510552 Ref. No. 437049
pump cover gasket pump type 1292-2/3942/3981/3911/3983	





Table continues overleaf



spare parts for 500544			
	Part No.	510693	Ref. No.
			141002 70942 80121 RAT72
	mechanical shaft seal for shaft \varnothing 12mm slide ring ext. \varnothing 24mm slide ring H 15.5mm slide ring int. \varnothing 11mm counter ring mounting \varnothing 24mm height counter ring 8mm counter ring int. \varnothing 13.5mm		
	Part No.	518067	Ref. No.
			926152
	impellor \varnothing 103mm H 29mm M7L		
	Part No.	521512	Ref. No.
			116015
	pump cover FIR inlet \varnothing 60mm outlet \varnothing 50mm		



1

Part No.	499281	Ref. No.	80134
description	pump inlet \varnothing 60mm outlet \varnothing 50mm type 4298.1404 230V 50Hz 1 phase 1.1kW L 210mm rotation direction right capacitor 12.5 μ F FIR		
For models:	Niagara-283A, RIVER-282, River-285, RV282DD, RV282R, SV72AEB		
spare parts for	499281		
	Part No.	365014	Ref. No.
			80191
	operating capacitor capacity 12.5 μ F 450V tolerance 5%Hz ambient temperature max. -25 to +85°C \varnothing 35mm L 70mm M8 plastic connection male faston 6.3mm 45S.C3DS.12.5 protection		
	Part No.	510600	Ref. No.
			80197
	impellor \varnothing 102mm H 29mm shaft intake \varnothing 9/8mm rotation direction right blades 6		
	Part No.	510692	Ref. No.
			80193 RAT19
	mechanical shaft seal for shaft \varnothing 11mm slide ring ext. \varnothing 24mm slide ring H 13mm counter ring mounting \varnothing 26mm height counter ring 8mm counter ring int. \varnothing 14mm		
	Part No.	521702	Ref. No.
			—
	pump cover gasket thickness 3.5x4.5mm Qty 1 pcs		







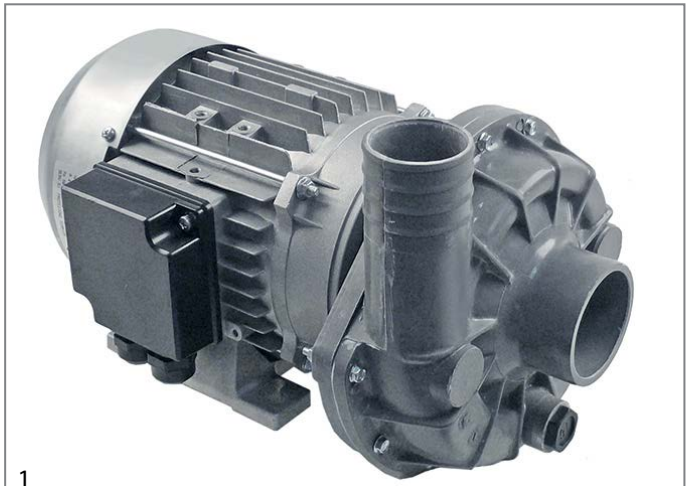
1

Part No.	499334	Ref. No.	929174
description	pump inlet \varnothing 62mm outlet \varnothing 62mm type 2250.2731 230/400V 50Hz 1 phase 3kW FIR		
For models:	KLP201DDDTEB, KLP201EB, KLP301, KLP301DDDTEB, LP201DDDTEB, LP201EB, LP301, LP301EB, RIVER-297, RIVER-298, RV297, RV298, U132, U132e, U70, U70e		
spare parts for	499334		
	Part No.	510687	Ref. No.
			929179
	mechanical shaft seal for shaft \varnothing 18mm height counter ring 8mm ID \varnothing 17mm ED \varnothing 39mm H 15mm mounting \varnothing 42mm int. \varnothing 121mm		
	Part No.	512455	Ref. No.
			929189
	fan wheel \varnothing 155mm H 18mm shaft intake \varnothing 18mm plastic blades 12		
	Part No.	521026	Ref. No.
			—
	pump cover gasket ID \varnothing 182.5mm thickness 5x4.5mm		
	Part No.	521028	Ref. No.
			—
	pump cover FIR inlet \varnothing 62mm outlet \varnothing 62mm turn direction right \varnothing 215mm ID \varnothing 175mm inner height 40mm		
	Part No.	521277	Ref. No.
			929181
	impellor \varnothing 135mm H 39mm pump type Fir 2275 - 3.6HP thread M14L		







1




Part No.	501487	Ref. No.	70100
description	pump inlet \varnothing 63mm outlet \varnothing 40mm type 4267.5050 230/400V 50Hz 3 phase 1.5kW L 300mm rotation direction right FIR		
For models:	NG381L, NG381LC, NG381LCFUR, NG381LDDPS, Niagara-283L-2, Niagara-381L, Niagara-381LC, River-282L-2, River-282LS-2TDE, River-382L, River-382L-230V-3Ph-50Hz, River-382LNRG, River-382LTDE, River-482, RV382L, RV382L23TERMO, RV382LFUR, RV382LR, RV382LS, RV382LSFUR, RV382LTX, RV382LTXR, RV482		
spare parts for	501487		
	Part No.	502273	Ref. No. 70945
	pump cover FIR inlet \varnothing 63mm outlet \varnothing 2x40mm pump type 4267.5050 turn direction right		
	Part No.	510602	Ref. No. 124002 927186
	impellor \varnothing 110mm H 34mm rotation direction right thread M8L shaft \varnothing 28mm seat \varnothing 12.2mm blades 6		
	Part No.	510693	Ref. No. 141002 70942 80121 RAT72
	mechanical shaft seal for shaft \varnothing 12mm slide ring ext. \varnothing 24mm slide ring H 15.5mm slide ring int. \varnothing 11mm counter ring mounting \varnothing 24mm height counter ring 8mm counter ring int. \varnothing 13.5mm		
	Part No.	524416	Ref. No. 70943 80120
	pump cover gasket thickness 4x4mm Qty 1 pcs		



1

Part No.	500023	Ref. No.	130025
description	pump inlet \varnothing 63mm outlet \varnothing 47mm type 1225.2725 230/400V 50Hz 3 phase 1.1kW 1.5HP L 335mm rotation direction right FIR		
For models:	66, S850		
spare parts for	500023		
	Part No.	510602	Ref. No. 124002 927186
	impellor \varnothing 110mm H 34mm rotation direction right thread M8L shaft \varnothing 28mm seat \varnothing 12.2mm blades 6		
	Part No.	510693	Ref. No. 141002 70942 80121 RAT72
	mechanical shaft seal for shaft \varnothing 12mm slide ring ext. \varnothing 24mm slide ring H 15.5mm slide ring int. \varnothing 11mm counter ring mounting \varnothing 24mm height counter ring 8mm counter ring int. \varnothing 13.5mm		
	Part No.	521513	Ref. No. 116002 80118
	pump cover FIR inlet \varnothing 63mm outlet \varnothing 47mm turn direction right ID \varnothing 150mm inner height 32mm		
	Part No.	524416	Ref. No. 70943 80120
	pump cover gasket thickness 4x4mm Qty 1 pcs		



Part No.	500117	Ref. No.	919223 926150 929201
description	pump inlet ø 63mm outlet ø 47mm type 4225.22725 230/400V 50Hz 3 phase 1.4kW 2HP L 280mm rotation direction right FIR		
For models:	A3EB, A3EBD, A3EBDAKRKYK, A3EBDAKWK, A3EBDBKWK, A3EB-DRKYK, A3EBDWK, A3EBDYK, A3EBSAK, A3EBSAKRK, A3EBSAKWK, A3EBSBKWKYK, A3EBSEKWK, A3EBSWK, A4EB, A4EBD, A4EBDAKEKYK, A4EBDAKRK, A4EBDAKWK, A4EBDAKZK, A4EBDBKRK, A4EBDPKWKYK, A4EBDRK, A4EBS, A4EBSAK, A4EBSAKCK, A4EBSAKEKYK, A4EBSA-KRK, A4EBSAKRKP, A4EBSAKYK, A4EBSCK, E.65, E14, E140, Fast200, FAST-200, Fast93, GL282EB93, GL282EB93DA, GL282EB93HZ23, GL282EBCH, GL282EBCHD, GL286EB, GL286EBD, GL286EBDA, GL286EBDAR, GL286EBDARY, GL286EBDAW, GL286EBDAY, GL286EBD-WY...(Other models you can see in the webshop)		
spare parts for	500117		
	Part No.	510602	Ref. No. 124002 927186
	impellor ø 110mm H 34mm rotation direction right thread M8L shaft ø 28mm seat ø 12.2mm blades 6		
	Part No.	510693	Ref. No. 141002 70942 80121 RAT72
	mechanical shaft seal for shaft ø 12mm slide ring ext. ø 24mm slide ring H 15.5mm slide ring int. ø 11mm counter ring mounting ø 24mm height counter ring 8mm counter ring int. ø 13.5mm		
	Part No.	521513	Ref. No. 116002 80118
	pump cover FIR inlet ø 63mm outlet ø 47mm turn direction right ID ø 150mm inner height 32mm		



Part No.	499283	Ref. No.	75175HZ
description	pump inlet ø 63mm outlet ø 47mm type 422512760 230/400V 60Hz 3 phase 1.1kW L 290mm rotation direction right FIR		
For models:	GL280EB23HZ, GL280EB23HZDY, GL282EBHZ23, GL282EBHZ23DY, GL282EBHZ23SY, GL284EBHZ23, GL284EBHZ23DBHZY, GL284EBH-Z23DBWY, GL284EBHZ23DBY, GL284EBHZ23DY, GL284EBHZ23SAP, Niagara-2150-230V-3Ph-60Hz, Niagara-2154-230-3Ph-60Hz		







Part No.	501540	Ref. No.	929123
description	pump inlet ø 63mm outlet ø 47mm type 422522726 230/400V 50Hz 3 phase 1.4kW 2HP L 280mm rotation direction right FIR		
For models:	E.65, U61, U61E, U61HE		
spare parts for	501540		
	Part No.	510602	Ref. No. 124002 927186
	impellor ø 110mm H 34mm rotation direction right thread M8L shaft ø 28mm seat ø 12.2mm blades 6		
	Part No.	510693	Ref. No. 141002 70942 80121 RAT72
	mechanical shaft seal for shaft ø 12mm slide ring ext. ø 24mm slide ring H 15.5mm slide ring int. ø 11mm counter ring mounting ø 24mm height counter ring 8mm counter ring int. ø 13.5mm		
	Part No.	521513	Ref. No. 116002 80118
	pump cover FIR inlet ø 63mm outlet ø 47mm turn direction right ID ø 150mm inner height 32mm		

Table continues overleaf








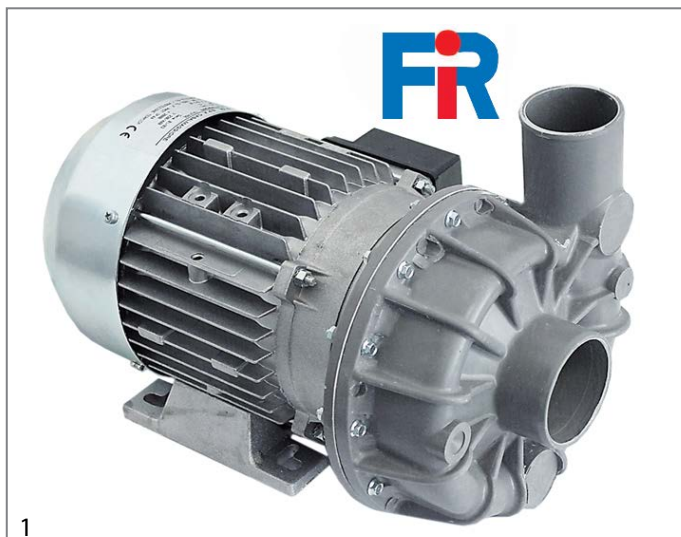
spare parts for 501540	
	Part No. 524416 Ref. No. 70943 80120
pump cover gasket thickness 4x4mm Qty 1 pcs	







1			
Part No.	499280	Ref. No.	80115
description	pump inlet \varnothing 63mm outlet \varnothing 47mm type 5295.5050 230/400V 50Hz 3 phase 1.5kW L 300mm rotation direction right FIR		
For models:	80, 82, CGL74CABT, NG292, NIAGARA-292, RIVER-295, River-295P, River-81CRP, RIVER-81-CRP, RIVER-82, River-82CRP, RIVER-82-CRP, RIVER-HL-82, RV295, RV295PS, RV81CCRP, RV81CRP, RV82, RV8223, RV82C, RV82CCRP, RV82CRP, SevenL		
spare parts for	499280		
	Part No. 502277	Ref. No.	70944 80119
impellor \varnothing 111mm H 31mm thread M8L			
	Part No. 510693	Ref. No.	141002 70942 80121 RAT72
mechanical shaft seal for shaft \varnothing 12mm slide ring ext. \varnothing 24mm slide ring H 15.5mm slide ring int. \varnothing 11mm counter ring mounting \varnothing 24mm height counter ring 8mm counter ring int. \varnothing 13.5mm			
	Part No. 521022	Ref. No.	—
fanwheel cover ID \varnothing 137mm ED \varnothing 142mm H 70mm for wash pump			
	Part No. 524416	Ref. No.	70943 80120
pump cover gasket thickness 4x4mm Qty 1 pcs			
	Part No. 698773	Ref. No.	—
pump cover inlet \varnothing 63mm outlet \varnothing 47mm turn direction right \varnothing 194mm ID \varnothing 158mm			



1			
Part No.	500119	Ref. No.	130038
description	pump inlet \varnothing 63mm outlet \varnothing 53mm type 1241.1402 230V 50Hz 1 phase 1.1kW 1.5HP L 330mm rotation direction left capacitor 31.5 μ F FIR		
For models:	S870		
spare parts for	500119		
	Part No. 365016	Ref. No.	206006
operating capacitor capacity 31.5 μ F 400V tolerance 5%Hz ambient temperature max. -25 to +85°C \varnothing 45mm L 95mm M8 plastic connection male faston 6.3mm protection			
	Part No. 510531	Ref. No.	1165005
pump cover FIR inlet \varnothing 63mm outlet \varnothing 53mm auxiliary pressure connection M16x1.5mm supporting pressure open turn direction left \varnothing 185mm ID \varnothing 150mm inner height 37mm			
	Part No. 510612	Ref. No.	927227 RAG19
impellor \varnothing 110mm H 34mm M8R			
	Part No. 510693	Ref. No.	141002 70942 80121 RAT72
mechanical shaft seal for shaft \varnothing 12mm slide ring ext. \varnothing 24mm slide ring H 15.5mm slide ring int. \varnothing 11mm counter ring mounting \varnothing 24mm height counter ring 8mm counter ring int. \varnothing 13.5mm			
	Part No. 524416	Ref. No.	70943 80120
pump cover gasket thickness 4x4mm Qty 1 pcs			








1

Part No.	500111	Ref. No.	130002
description	pump inlet \varnothing 63mm outlet \varnothing 53mm type 1241.2500 230/400V 50Hz 3 phase 1.1kW 1.5HP L 330mm rotation direction left FIR		
For models:	55, S870		
spare parts for	500111		
	Part No.	510531	Ref. No. 1165005
	pump cover FIR inlet \varnothing 63mm outlet \varnothing 53mm auxiliary pressure connection M16x1.5mm supporting pressure open turn direction left \varnothing 185mm ID \varnothing 150mm inner high 37mm		
	Part No.	510612	Ref. No. 927227 RAG19
	impellor \varnothing 110mm H 34mm M8R		
	Part No.	510693	Ref. No. 141002 70942 80121 RAT72
	mechanical shaft seal for shaft \varnothing 12mm slide ring ext. \varnothing 24mm slide ring H 15.5mm slide ring int. \varnothing 11mm counter ring mounting \varnothing 24mm height counter ring 8mm counter ring int. \varnothing 13.5mm		
	Part No.	524416	Ref. No. 70943 80120
	pump cover gasket thickness 4x4mm Qty 1 pcs		






LGB








1

Part No.	501503	Ref. No.	130166
description	pump inlet \varnothing 28mm outlet \varnothing 22/27mm type CF 2745 230V 50Hz 1 phase 0.19kW L 175mm rotation direction right capacitor 4 μ F LGB with capacitor		
For models:	915611, 915612, 915613, 915614, 915615, 915616, 915617, 915618, 915670, 915671, 915672, 915773, 915774, 915959, 916066, 916077, 916078, 916196, 916197, 916198, 916199, 916200, 916409, 916410, 916418, 916419, 916591, 916592, 916593, 916594, 916595, 916877, 916921, 916922, 916992, 916993, Fast145-2, Fast150, Niagara-241, Niagara-241-2, Niagara-341, Pluvia-240, RIVER-242, River-242-2, River-242-2T, River-342C, River-342T		
spare parts for	501503		
	Part No.	365031	Ref. No. 206013
	operating capacitor capacity 4 μ F 450V tolerance 5% 50/60Hz ambient temperature max. -25 to +85°C \varnothing 31mm L 58mm M8 plastic connection male faston 6.3mm protection		
	Part No.	509002	Ref. No. 456083 456084
	O-ring EPDM thickness 2.62mm ID \varnothing 82.22mm Qty 1 pcs		
	Part No.	510703	Ref. No. 141007 80843
	mechanical shaft seal for shaft \varnothing 13mm slide ring H 13mm height counter ring 5.5mm ED \varnothing 26mm		
	Part No.	698765	Ref. No. 124063
	impellor \varnothing 70mm H 21mm rotation direction right thread M7L suitable for LGB shaft \varnothing 13mm shaft length 20mm blades 4		
	Part No.	698770	Ref. No. 116035
	pump cover LGB inlet \varnothing 28mm outlet \varnothing 22/28mm \varnothing 108mm ID \varnothing 84mm		



Part No.	499099	Ref. No.	130163 80627
description	pump inlet \varnothing 28mm outlet \varnothing 26mm type CRC-R DX 230V 50Hz 1 phase 0.2kW L 175mm rotation direction left capacitor 4 μ F LGB		
For models:	915154, 915155, 915157, 915158, 915172, 915173, 915285, 915422, 915492, 915493, 915494, 915495, 915496, 915497, 915617, 915618, 915672, 915773, 915774, 916045, 916054, 916066, 916067, 916068, 916069, 916077, 916078, 916079, 916080, 916368, 916418, 916419, 916420, 916421, 916422, 916423, 916424, 916594, 916595, 916654, 916686, 916760, Fast160C, Ocean360-UK, River-242, River-242-2, River-242-2T, RIVER-252, River-252-2, River-252-2T...(Other models you can see in the webshop)		
spare parts for	499099		
	Part No.	365031	Ref. No. 206013
	operating capacitor capacity 4 μ F 450V tolerance 5% 50/60Hz ambient temperature max. -25 to +85°C \varnothing 31mm L 58mm M8 plastic connection male faston 6.3mm protection		
	Part No.	509002	Ref. No. 456083 456084
	O-ring EPDM thickness 2.62mm ID \varnothing 82.22mm Qty 1 pcs		
	Part No.	510703	Ref. No. 141007 80843
	mechanical shaft seal for shaft \varnothing 13mm slide ring H 13mm height counter ring 5.5mm ED \varnothing 26mm		
	Part No.	521091	Ref. No. 116040
	pump cover LGB inlet \varnothing 28mm outlet \varnothing 26mm pump type CRC-R DX		
	Part No.	521092	Ref. No. 124070
	impellor \varnothing 80mm H 25mm pump type CRC-R DX thread M6R shaft \varnothing 13mm shaft length 20mm		



Part No.	500542	Ref. No.	130097
description	pump inlet \varnothing 28mm outlet \varnothing 26mm type ZF130DX 230V 50Hz 1 phase 0.3kW 0.41HP L 190mm rotation direction left capacitor 6.3 μ F LGB		
For models:	400F, 400FD, 400R, 400RD, 40-ELECTRONIC, 40F, 40FD, 40R, 40RD		
spare parts for	500542		
	Part No.	365012	Ref. No. 206009
	operating capacitor capacity 6.3 μ F 450V tolerance 5% 50Hz ambient temperature max. -25 to +85°C \varnothing 30mm L 61mm M8 plastic connection male faston 6.3mm protection		
	Part No.	510703	Ref. No. 141007 80843
	mechanical shaft seal for shaft \varnothing 13mm slide ring H 13mm height counter ring 5.5mm ED \varnothing 26mm		
	Part No.	521107	Ref. No. —
	pump cover LGB inlet \varnothing 28mm outlet \varnothing 26mm auxiliary pressure connection 12mm ID \varnothing 77mm		
	Part No.	521228	Ref. No. 124032
	impellor \varnothing 72mm H 17mm rotation direction left thread M7R shaft \varnothing 13mm shaft length 12mm blades 3		
	Part No.	528800	Ref. No. —
	O-ring EPDM thickness 2.62mm ID \varnothing 75.87mm Qty 1 pcs		








Part No.	500094	Ref. No.	130099
description	pump inlet \varnothing 28mm outlet \varnothing 26mm type ZF131SX 230V 50Hz 1 phase 0.2kW 0.15HP L 195mm rotation direction left capacitor 6.3 μ F LGB		
For models:	350F, 350FD, 350R, 350RD, 35-ELECTRONIC		
spare parts for	500094		
	Part No.	365012	Ref. No. 206009
	operating capacitor capacity 6.3 μ F 450V tolerance 5% 50Hz ambient temperature max. -25 to +85°C \varnothing 30mm L 61mm M8 plastic connection male faston 6.3mm protection		

Table continues overleaf



spare parts for 500094				
	Part No.	502266	Ref. No.	—
pump cover inlet ø 28mm outlet ø 26mm				
	Part No.	510703	Ref. No.	141007 80843
mechanical shaft seal for shaft ø 13mm slide ring H 13mm height counter ring 5.5mm ED ø 26mm				
	Part No.	521085	Ref. No.	—
impellor ø 72mm H 17mm thread M7L shaft ø 13mm shaft length 12mm blades 3				
	Part No.	528800	Ref. No.	—
O-ring EPDM thickness 2.62mm ID ø 75.87mm Qty 1 pcs				







1

Part No.	500979	Ref. No.	130148	
description	pump inlet ø 28mm outlet ø 26mm type ZFC1121DX 230V 50Hz 1 phase 0.25kW L 198mm rotation direction left capacitor 6.3µF LGB			
For models:	2312-009-CRP, 914628, 914944, RIVER-40-CRP, RIVER-44-CRP, RIVER-44-CRP-ST, RIVER-50-CRP, RIVER-50-CRP-SP, RIVER-54CRP, River-54-CRP-s.p., RIVER-54-CRP-SP			
spare parts for	500979			
	Part No.	365012	Ref. No.	206009
operating capacitor capacity 6.3µF 450V tolerance 5% 50Hz ambient temperature max. -25 to +85°C ø 30mm L 61mm M8 plastic connection male faston 6.3mm protection				
	Part No.	510703	Ref. No.	141007 80843
mechanical shaft seal for shaft ø 13mm slide ring H 13mm height counter ring 5.5mm ED ø 26mm				
	Part No.	521098	Ref. No.	—
pump cover LGB inlet ø 28mm outlet ø 26mm auxiliary pressure connection 12mm ID ø 77mm				
	Part No.	521099	Ref. No.	—
impellor ø 72mm H 17mm thread M7R shaft ø 13mm shaft length 12mm				
	Part No.	528800	Ref. No.	—
O-ring EPDM thickness 2.62mm ID ø 75.87mm Qty 1 pcs				









1

Part No.	500351	Ref. No.	130994	
description	pump inlet ø 29mm outlet ø 39mm type X55X 230V 50Hz 1 phase 0.8kW 1.09HP L 210mm rotation direction right capacitor 16µF LGB			
For models:	2312-009-CRP, RIVER-48, RIVER-50, RIVER-50-CRP, RIVER-50-CRP-SP, RIVER-54, RIVER-54-CRP-SP, RIVER-61			
spare parts for	500351			
	Part No.	365021	Ref. No.	206004
operating capacitor capacity 16µF 425V tolerance 5% 50/60Hz ambient temperature max. -25 to +85°C ø 35mm L 73mm single M8 plastic connection male faston 6.3mm 416.10.99 protection				
	Part No.	510703	Ref. No.	141007 80843
mechanical shaft seal for shaft ø 13mm slide ring H 13mm height counter ring 5.5mm ED ø 26mm				
	Part No.	518294	Ref. No.	437087
flat gasket rubber ED ø 85mm ID ø 71mm thickness 2mm Qty 1 pcs				
	Part No.	521234	Ref. No.	124052
impellor thread M8L ED ø 93mm W 16mm				
	Part No.	523509	Ref. No.	314001
deep-groove ball bearing type 6201-2RS shaft ø 12mm ED ø 32mm W 10mm with sealing discs deep-groove ball bearing DIN 625-1				
	Part No.	532537	Ref. No.	456067
O-ring EPDM thickness 3.53mm ID ø 113.9mm Qty 1 pcs				












Part No.	499138	Ref. No.	130993 999241
description	pump inlet \varnothing 33mm outlet \varnothing 26mm type X3SX 230V 50Hz 1 phase 0.26kW L 300mm rotation direction right capacitor 6.3 μ F LGB		
For models:	913992, 913993, 914583, 914592, 914612, 914613, 915143, RIVER-40, RIVER-40-CRP, RIVER-44, RIVER-44-CRP, RIVER-44-CRP-ST, RIVER-44CRP-ST		
spare parts for	499138		
	Part No.	365012	Ref. No. 206009
	operating capacitor capacity 6.3 μ F 450V tolerance 5% 50Hz ambient temperature max. -25 to +85°C \varnothing 30mm L 61mm M8 plastic connection male faston 6.3mm protection		
	Part No.	509004	Ref. No. 124049
	impeller \varnothing 71mm H 16mm M7L rotation direction right shaft \varnothing 13mm shaft length 13mm blades 8		
	Part No.	510703	Ref. No. 141007 80843
	mechanical shaft seal for shaft \varnothing 13mm slide ring H 13mm height counter ring 5.5mm ED \varnothing 26mm		
	Part No.	521088	Ref. No. 116030
	pump cover LGB inlet \varnothing 33mm outlet \varnothing 26mm		
	Part No.	521147	Ref. No. 315024
	flange		
	Part No.	521703	Ref. No. 456038 456063
	pump cover gasket EPDM thickness 2.5mm ID \varnothing 75mm Qty 1 pcs		
	Part No.	523501	Ref. No. 314009
	deep-groove ball bearing type 608-2RS shaft \varnothing 8mm ED \varnothing 22mm W 7mm with sealing discs deep-groove ball bearing DIN 625-1		



Part No.	499190	Ref. No.	69120
description	pump inlet \varnothing 42mm outlet \varnothing 24/37mm type LA50 230V 50Hz 1 phase 0.47kW L 225mm rotation direction right capacitor 10 μ F LGB		
For models:	FAST-60, FAST-73, NG281, NG281HP, NIAGARA-281, NIAGARA-281HP, PULVIA-280, PV280, PV280FAST, PV280FASTCH		
spare parts for	499190		
	Part No.	365015	Ref. No. 206002
	operating capacitor capacity 10 μ F 400V tolerance 5%Hz ambient temperature max. -25 to +85°C \varnothing 35.5mm L 59mm M8 plastic connection male faston 6.3mm protection		
	Part No.	510702	Ref. No. —
	mechanical shaft seal height counter ring 5.5mm ID \varnothing 12mm		
	Part No.	521024	Ref. No. 124057 73053
	impeller \varnothing 88mm H 30mm rotation direction right thread M7L shaft \varnothing 12mm blades 6		
	Part No.	698767	Ref. No. 335015
	fan blade \varnothing 110mm H 18mm shaft intake \varnothing 12mm plastic blades 6		
	Part No.	698768	Ref. No. 480148
	pump cover LGB inlet \varnothing 42mm pump type LA50 AP \varnothing 115mm ID \varnothing 36mm		
	Part No.	698793	Ref. No. 73052
	pump cover outlet \varnothing 24/36mm pump type LGB		
	Part No.	698810	Ref. No. 456078
	O-ring EPDM thickness 3.56mm ID \varnothing 112mm Qty 1 pcs		
	Part No.	698827	Ref. No. 429074
	threaded ring LGB pump type LA50 \varnothing 120mm ID \varnothing 70mm		



1








Part No.	500156	Ref. No.	130098 130109
description	pump inlet ø 50mm outlet ø 50mm type ZF400SX 230V 50Hz 1 phase 0.6kW 0.8HP L 210mm rotation direction right capacitor 16µF LGB		
For models:	050F, 050FP, 2312-001, 2312-002, 46, 460, 500F, 500FD, 50-ELECTRONIC, 50F, 50FD, 913297, 913298, 913299, 913300, 913360, 913361, 913391, 913392, 913546, 913547, 913578, 913611, 913684, 913913, 913914, 913932, 913933, 914284, 914331, 914356, 914400, 914401, 914402, 914403, 914404, 914405, 914449, 914517, 914545, 914568, 914642, 914688, 914909, 914979, 915136, 915137, 915140, 915248, 915483...(Other models you can see in the webshop)		
spare parts for	500156		
	Part No.	509020	Ref. No. 124031
	impellor ø 104mm H 25mm M8L		
	Part No.	510703	Ref. No. 141007 80843
	mechanical shaft seal for shaft ø 13mm slide ring H 13mm height counter ring 5.5mm ED ø 26mm		
	Part No.	513713	Ref. No. 315017
	pump cover bottom part		
	Part No.	521548	Ref. No. 116019
	pump cover LGB inlet ø 50mm outlet ø 50mm		
	Part No.	521562	Ref. No. 116021
	pump cover		
	Part No.	521734	Ref. No. 315022
	pump cover bottom part		
	Part No.	523509	Ref. No. 314001
	deep-groove ball bearing type 6201-2RS shaft ø 12mm ED ø 32mm W 10mm with sealing discs deep-groove ball bearing DIN 625-1		
	Part No.	532623	Ref. No. 80844
	O-ring EPDM thickness 2.62mm ID ø 120.32mm Qty 1 pcs		
accessories for	500156		
	Part No.	365021	Ref. No. 206004
	operating capacitor capacity 16µF 425V tolerance 5% 50/60Hz ambient temperature max. -25 to +85°C ø 35mm L 73mm single M8 plastic connection male faston 6.3mm 416.10.99 protection		









1

Part No.	500543	Ref. No.	130126
description	pump inlet ø 50mm outlet ø 50mm type ZF400VSX 230V 50Hz 1 phase 0.85kW 1.2HP L 245mm rotation direction right capacitor 16µF LGB		
For models:	510F, 510FD, 913297, 913298, 913299, 913300, 913360, 913361, 913391, 913392, 913546, 913547, 913578, 913611, 913684, 913932, 913933, 914318, 914319, 914331, 914338, 914431, 914517, 914545, 914688, 914979, 915140, 915248, E.50, E.51, F85, F85P, GSP51, GSP51P, LF55, MC501E, MC501EP, Mistral51, MISTRAL-51, NIAGARA-51, TF-513, TF-515		
spare parts for	500543		
	Part No.	365021	Ref. No. 206004
	operating capacitor capacity 16µF 425V tolerance 5% 50/60Hz ambient temperature max. -25 to +85°C ø 35mm L 73mm single M8 plastic connection male faston 6.3mm 416.10.99 protection		
	Part No.	509020	Ref. No. 124031
	impellor ø 104mm H 25mm M8L		
	Part No.	510703	Ref. No. 141007 80843
	mechanical shaft seal for shaft ø 13mm slide ring H 13mm height counter ring 5.5mm ED ø 26mm		
	Part No.	521548	Ref. No. 116019
	pump cover LGB inlet ø 50mm outlet ø 50mm		
	Part No.	521734	Ref. No. 315022
	pump cover bottom part		
	Part No.	532623	Ref. No. 80844
	O-ring EPDM thickness 2.62mm ID ø 120.32mm Qty 1 pcs		








1				
Part No.	500361	Ref. No.	80112 926078	
description	pump inlet ø 60mm outlet ø 49mm type ZF400SX 230V 50Hz 1 phase 0.8kW 1HP L 210mm rotation direction right capacitor 16µF LGB			
For models:	10, 80, 81, CE78HZ23, CLEAN-100, E100, E78, E78HP, FAST-181, HM1, NG271, NG291, NIAGARA-271, NIAGARA-291, RIVER-294, RIVER-78, RIVER-80, RIVER-81, RIVER-E78, RV294, RV80, RV8023, RV8023HZ, RV80C, RV80HZ, ST70FAST			
spare parts for	500361			
	Part No.	365021	Ref. No.	206004
		operating capacitor capacity 16µF 425V tolerance 5% 50/60Hz ambient temperature max. -25 to +85°C ø 35mm L 73mm single M8 plastic connection male faston 6.3mm 416.10.99 protection		
	Part No.	509020	Ref. No.	124031
		impellor ø 104mm H 25mm M8L		
	Part No.	510703	Ref. No.	141007 80843
		mechanical shaft seal for shaft ø 13mm slide ring H 13mm height counter ring 5.5mm ED ø 26mm		
	Part No.	521547	Ref. No.	116013
		pump cover LGB inlet ø 60mm outlet ø 50mm supporting pressure M8 turn direction right ø 160mm ID ø 127mm inner height 36mm		
	Part No.	521736	Ref. No.	315011
		pump cover bottom part bottom part		
	Part No.	532623	Ref. No.	80844
		O-ring EPDM thickness 2.62mm ID ø 120.32mm Qty 1 pcs		
accessories for	500361			
	Part No.	513264	Ref. No.	80545
		fastening angle for wash pump		



1				
Part No.	499282	Ref. No.	77553	
description	pump inlet ø 60mm outlet ø 49mm type ZF400VSX 220-230/380-400V 50Hz 3 phase 0.7kW L 270mm rotation direction right LGB			
For models:	915747, A4EB, A4EBD, A4EBDAKEKYK, A4EBDAKRK, A4EBDAKWK, A4EBDAKZK, A4EBDBKRK, A4EBDPKWYK, A4EBDRK, A4EBS, A4EBSAK, A4EBSAKCK, A4EBSAKEKYK, A4EBSAKRK, A4EBSAKRKP, A4EBSAKYK, A4EBSCK, A4EBT, A4EBTSAK, A5EB, A5EBD, A5EBDAKPKWK, A5EBDAKWK, A5EBDAKYK, A5EBDRK, A5EBS, A5EBSAKPKWK, A5EBSAKRK, A5EBSAKRKYK, A5EBSAKWK, A5EBSAKWKYK, A5EBSBKRKPK, A5EBSBKWK, A5EBSRK, A5EBSYK, GL284EB, GL284EBD, GL284EBDA, GL284EBDAEW, GL284EBDAWY, GL284EBDPWY, GL284EBDR, GL284EBDY, GL284EBS, GL284EBSA, GL284EBSAE, GL284EBSAP, GL284EBSAR, GL284EBSAWY...(Other models you can see in the webshop)			
spare parts for	499282			
	Part No.	502279	Ref. No.	—
		impellor H 31mm ED ø 100mm blades 6		
	Part No.	510702	Ref. No.	—
		mechanical shaft seal height counter ring 5.5mm ID ø 12mm		
	Part No.	510709	Ref. No.	926255
		mechanical shaft seal		
	Part No.	521058	Ref. No.	—
		fanwheel cover suitable for LGB ID ø 138mm ED ø 142mm H 59mm plastic		
	Part No.	521547	Ref. No.	116013
		pump cover LGB inlet ø 60mm outlet ø 50mm supporting pressure M8 turn direction right ø 160mm ID ø 127mm inner height 36mm		
	Part No.	532623	Ref. No.	80844
		O-ring EPDM thickness 2.62mm ID ø 120.32mm Qty 1 pcs		








1

Part No.	500148	Ref. No.	130042 130045 130059
description	pump inlet ø 60mm outlet ø 50mm type ZA160SX 230V 50Hz 1 phase 1.1kW 1.5HP L 310mm rotation direction right capacitor 25µF LGB		
For models:	S651, S654, S810, S815, S830, S835		
spare parts for	500148		
	Part No.	365109	Ref. No. —
	operating capacitor capacity 25µF 400V tolerance 5%Hz ambient temperature max. -25 to +85°C ø 44mm L 70mm M8 plastic connection male faston 6.3mm protection		
	Part No.	510616	Ref. No. 124012
	impellor ø 104mm H 25mm shaft intake ø 10mm		
	Part No.	510703	Ref. No. 141007 80843
	mechanical shaft seal for shaft ø 13mm slide ring H 13mm height counter ring 5.5mm ED ø 26mm		
	Part No.	521547	Ref. No. 116013
	pump cover LGB inlet ø 60mm outlet ø 50mm supporting pressure M8 turn direction right ø 160mm ID ø 127mm inner height 36mm		
	Part No.	532623	Ref. No. 80844
	O-ring EPDM thickness 2.62mm ID ø 120.32mm Qty 1 pcs		



1

Part No.	500002	Ref. No.	130017 130018 130068 130069 130079 130080
description	pump inlet ø 60mm outlet ø 50mm type ZA400SX 230V 50Hz 1 phase 0.9kW 1.2HP L 300mm rotation direction right capacitor 20µF LGB		
For models:	22F, 40F, 440F, 44F, E.52, S651, S651P, S653, S654, S655, S830, S835, SR651		
spare parts for	500002		
	Part No.	365019	Ref. No. 206005
	operating capacitor capacity 20µF 400V tolerance 5% 50/60Hz ambient temperature max. -25 to +85°C ø 39.5mm L 70mm M8 plastic connection male faston 6.3mm 16.10.25. protection		
	Part No.	509020	Ref. No. 124031
	impellor ø 104mm H 25mm M8L		
	Part No.	510703	Ref. No. 141007 80843
	mechanical shaft seal for shaft ø 13mm slide ring H 13mm height counter ring 5.5mm ED ø 26mm		
	Part No.	521547	Ref. No. 116013
	pump cover LGB inlet ø 60mm outlet ø 50mm supporting pressure M8 turn direction right ø 160mm ID ø 127mm inner height 36mm		
	Part No.	532623	Ref. No. 80844
	O-ring EPDM thickness 2.62mm ID ø 120.32mm Qty 1 pcs		



1			
Part No.	499126	Ref. No.	80113
description	pump inlet ø 60mm outlet ø 50mm type ZF400SX 230V 50Hz 1 phase 1.1kW L 215mm rotation direction right capacitor 16µF LGB		
For models:	NIAGARA-283, RIVER-282, RIVER-81, River-81CRP, RIVER-81-CRP, River-82CRP, RIVER-82-CRP, RV282, RV81, RV8123, RV81A, RV81C, RV81CCRP, RV81CRP, RV81HZ, RV81HZ23, RV81PAP, RV82CCRP, RV82CRP, SV72EB		
spare parts for	499126		
	Part No.	365021	Ref. No. 206004
	operating capacitor capacity 16µF 425V tolerance 5% 50/60Hz ambient temperature max. -25 to +85°C ø 35mm L 73mm single M8 plastic connection male faston 6.3mm 416.10.99 protection		
	Part No.	510703	Ref. No. 141007 80843
	mechanical shaft seal for shaft ø 13mm slide ring H 13mm height counter ring 5.5mm ED ø 26mm		
	Part No.	521090	Ref. No. 80845
	impellor ø 101mm H 32mm thread M8L shaft ø 13mm shaft length 12mm		
	Part No.	521547	Ref. No. 116013
	pump cover LGB inlet ø 60mm outlet ø 50mm supporting pressure M8 turn direction right ø 160mm ID ø 127mm inner height 36mm		
	Part No.	532623	Ref. No. 80844
	O-ring EPDM thickness 2.62mm ID ø 120.32mm Qty 1 pcs		



1			
Part No.	500362	Ref. No.	926146
description	pump inlet ø 62mm outlet ø 50mm type CE150SX 230/400V 50Hz 3 phase 1.1kW 1.5HP L 280mm rotation direction right LGB		
For models:	CLEAN-110, E1, E110		
spare parts for	500362		
	Part No.	510551	Ref. No. 456023 926084
	pump cover gasket ID ø 158.3mm pump type 1214/1293/1225/2243/1226/1204/3473/1241 thickness 3.53mm EPDM Qty 1 pcs		

spare parts for	500362		
	Part No.	510693	Ref. No. 141002 70942 80121 RAT72
	mechanical shaft seal for shaft ø 12mm slide ring ext. ø 24mm slide ring H 15.5mm slide ring int. ø 11mm counter ring mounting ø 24mm height counter ring 8mm counter ring int. ø 13.5mm		
	Part No.	521240	Ref. No. 926085
	impellor ø 110mm H 32mm rotation direction left thread M8L shaft ø 20mm shaft length 10mm seat ø 8.2mm blades 6		
	Part No.	521536	Ref. No. 926086
	pump cover ALBA / LGB inlet ø 62mm outlet ø 50mm auxiliary pressure connection 12mm supporting pressure closed turn direction right ø 180mm ID ø 150mm inner height 38mm		
	Part No.	602013	Ref. No. —
	fan wheel ø 100mm H 28mm shaft intake ø 17.5mm plastic		




1			
Part No.	500360	Ref. No.	80114
description	pump inlet ø 62mm outlet ø 50mm type ZF522SX 230V 50Hz 1 phase 1.1kW 1.5HP L 220mm rotation direction right capacitor 16µF LGB		
For models:	80, 81, LP60, RIVER-71, RIVER-80, RIVER-81, RIVER-81-CRP, RIVER-HL-81, RV71, RV81, RV8123, RV81A, RV81C, RV81HZ, RV81HZ23, RV81PAP, U60E		
spare parts for	500360		
	Part No.	365021	Ref. No. 206004
	operating capacitor capacity 16µF 425V tolerance 5% 50/60Hz ambient temperature max. -25 to +85°C ø 35mm L 73mm single M8 plastic connection male faston 6.3mm 416.10.99 protection		
	Part No.	510551	Ref. No. 456023 926084
	pump cover gasket ID ø 158.3mm pump type 1214/1293/1225/2243/1226/1204/3473/1241 thickness 3.53mm EPDM Qty 1 pcs		
	Part No.	510693	Ref. No. 141002 70942 80121 RAT72
	mechanical shaft seal for shaft ø 12mm slide ring ext. ø 24mm slide ring H 15.5mm slide ring int. ø 11mm counter ring mounting ø 24mm height counter ring 8mm counter ring int. ø 13.5mm		
	Part No.	521280	Ref. No. —
	impellor ø 107mm H 26mm thread M8L shaft ø 20mm shaft length 15mm seat ø 8.2mm blades 6		
	Part No.	521536	Ref. No. 926086
	pump cover ALBA / LGB inlet ø 62mm outlet ø 50mm auxiliary pressure connection 12mm supporting pressure closed turn direction right ø 180mm ID ø 150mm inner height 38mm		




1

Part No.	501584	Ref. No.	65600
description	pump inlet ø 63mm outlet ø 44mm type PSA 230/400V 50Hz 3 phase 2.5kW L 340mm rotation direction right LGB		

spare parts for	500153		
	Part No.	513283	Ref. No. 437082
	gasket		
	Part No.	518177	Ref. No. 111023 116023
	drain unit thread 3/4" ID ø 35mm hose ø 24mm		
	Part No.	518204	Ref. No. 429065
	screw connection for filter ø 67mm		
	Part No.	518205	Ref. No. 437079 80182 reb437079
	flat gasket rubber ED ø 61mm ID ø 47mm thickness 2mm Qty 1 pcs		
	Part No.	521147	Ref. No. 315024
	flange		
	Part No.	521221	Ref. No. 124048
	impellor ø 67mm H 16mm rotation direction right thread M7L shaft ø 13mm shaft length 12mm blades 8		
	Part No.	528800	Ref. No. —
	O-ring EPDM thickness 2.62mm ID ø 75.87mm Qty 1 pcs		



1

Part No.	500153	Ref. No.	130139 999134
description	pump inlet ø outlet ø type W180SX 230V 50Hz 1 phase 0.19kW 0.26HP L 220mm rotation direction right capacitor 5µF LGB		
For models:	913289, 913290, 913356, 913372, 913373, 913544, 913665, 913667, 913771, 913772, 913832, 913837, 914165, 914166, 914206, 914355, 914386, 914387, 914388, 914389, 914390, 914391, 914692, 914693, 914694, 914703, 914870, 915686, 915687, 915688, 915689, 915690, 915691, 916237, 916238, 916239, 916240, 916241, 916401, 916402, 916403, 916404, 916787, E.35, E.35-Elettrobar, E.35H, E.35H-Elettrobar, Fast130, FAST-135, Fast135-2...(Other models you can see in the webshop)		
spare parts for	500153		
	Part No.	365017	Ref. No. 206008 206010
	operating capacitor capacity 5µF 450V tolerance 5% 50/60Hz ambient temperature max. -25 to +85°C ø 28mm L 54mm M8 plastic connection male faston 6.3mm 16.10.08 protection		
	Part No.	510703	Ref. No. 141007 80843
	mechanical shaft seal for shaft ø 13mm slide ring H 13mm height counter ring 5.5mm ED ø 26mm		
	Part No.	513267	Ref. No. 480054
	end cap for wash pump suitable for pump casing		









Part No.	500150	Ref. No.	130136 999135
description	pump inlet ø outlet ø type W210SX 230V 50Hz 1 phase 0.24kW 0.33HP L 230mm rotation direction right capacitor 6.3µF LGB		
For models:	913291, 913292, 913357, 913374, 913375, 913416, 913435, 913545, 913666, 913668, 913685, 913773, 913774, 913911, 913912, 913948, 913950, 913977, 913984, 913990, 914214, 914316, 914317, 914392, 914393, 914394, 914395, 914396, 914397, 914441, 914442, 914515, 914516, 914537, 914543, 914547, 914683, 914684, 914689, 914863, 914874, 915138, 915139, 915527, 915692, 915693, 915694, 916162, 916181, 916183...(Other models you can see in the webshop)		
spare parts for	500150		
	Part No.	365012	Ref. No. 206009
	operating capacitor capacity 6.3µF 450V tolerance 5% 50Hz ambient temperature max. -25 to +85°C ø 30mm L 61mm M8 plastic connection male faston 6.3mm protection		
	Part No.	509004	Ref. No. 124049
	impellor ø 71mm H 16mm M7L rotation direction right shaft ø 13mm shaft length 13mm blades 8		
	Part No.	510703	Ref. No. 141007 80843
	mechanical shaft seal for shaft ø 13mm slide ring H 13mm height counter ring 5.5mm ED ø 26mm		

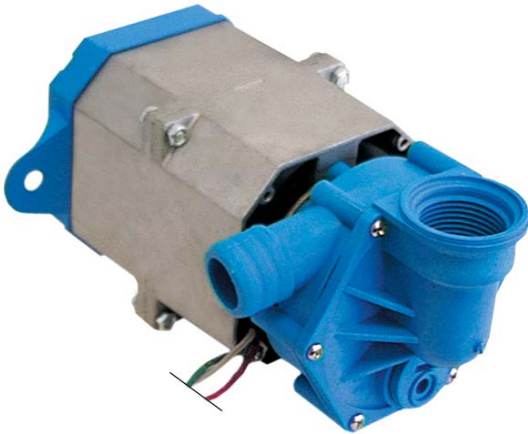
Table continues overleaf






spare parts for		500150	
	Part No.	513267	Ref. No. 480054
	end cap for wash pump suitable for pump casing		
	Part No.	513275	Ref. No. 456074
	O-ring EPDM thickness 1.78mm ID ø 82.27mm Qty 1 pcs		
	Part No.	518177	Ref. No. 111023 116023
	drain unit thread 3/4" ID ø 35mm hose ø 24mm		
	Part No.	518204	Ref. No. 429065
	screw connection for filter ø 67mm		
	Part No.	518205	Ref. No. 437079 80182 reb437079
	flat gasket rubber ED ø 61mm ID ø 47mm thickness 2mm Qty 1 pcs		
	Part No.	521147	Ref. No. 315024
	flange		



OLYMPIA

pumps









1

Part No.	500005	Ref. No.	130050 130085 130086 130087
description	pump inlet ø 1" IT outlet ø 28mm type T60 230V 50Hz 1 phase 0.19kW 0.26HP L 210mm rotation direction left capacitor 5µF OLYMPIA		
For models:	11F, 11FD, 11F-DVGW, 11R, 11RD, 913363, 913364, 913376, 913377, E.41, E.42, E.41		
spare parts for	500005		
	Part No.	365017	Ref. No. 206008 206010
	operating capacitor capacity 5µF 450V tolerance 5% 50/60Hz ambient temperature max. -25 to +85°C ø 28mm L 54mm M8 plastic connection male faston 6.3mm 16.10.08 protection		
	Part No.	509001	Ref. No. 124028
	impellor ø 75mm H 15mm pump type type C rotation direction left thread M6R shaft ø 11/12mm shaft length 25mm blades 4		
	Part No.	509003	Ref. No. 315013 999175
	pump cover OLYMPIA inlet 1" outlet ø 28mm pump type T60		

spare parts for		500005	
	Part No.	510693	Ref. No. 141002 70942 80121 RAT72
	mechanical shaft seal for shaft ø 12mm slide ring ext. ø 24mm slide ring H 15.5mm slide ring int. ø 11mm counter ring mounting ø 24mm height counter ring 8mm counter ring int. ø 13.5mm		
	Part No.	528800	Ref. No. —
	O-ring EPDM thickness 2.62mm ID ø 75.87mm Qty 1 pcs		







1

Part No.	500199	Ref. No.	130115 130116
description	pump inlet ø 32mm outlet ø 30/24mm type T80 230V 50Hz 1 phase 0.25kW 0.34HP L 205mm rotation direction left capacitor 5µF OLYMPIA		
For models:	67F, 67R		
spare parts for	500199		
	Part No.	365017	Ref. No. 206008 206010
	operating capacitor capacity 5µF 450V tolerance 5% 50/60Hz ambient temperature max. -25 to +85°C ø 28mm L 54mm M8 plastic connection male faston 6.3mm 16.10.08 protection		
	Part No.	510693	Ref. No. 141002 70942 80121 RAT72
	mechanical shaft seal for shaft ø 12mm slide ring ext. ø 24mm slide ring H 15.5mm slide ring int. ø 11mm counter ring mounting ø 24mm height counter ring 8mm counter ring int. ø 13.5mm		
	Part No.	521151	Ref. No. 124040
	impellor ø 71mm H 19mm pump type OLYMPIA thread M10R shaft ø 12mm shaft length 8mm		
	Part No.	521178	Ref. No. 315018
	pump casing OLYMPIA outlet ø 30/24mm pump type T80		
	Part No.	521552	Ref. No. 116022
	pump cover OLYMPIA inlet ø 32mm outlet ø 30/24mm ø 103mm ID ø 93mm		
	Part No.	521703	Ref. No. 456038 456063
	pump cover gasket EPDM thickness 2.5mm ID ø 75mm Qty 1 pcs		




1

Part No.	500152	Ref. No.	130122
description	pump inlet \varnothing 44mm outlet \varnothing 30mm type T90 230V 50Hz 1 phase 0.33kW 0.45HP L 220mm rotation direction left capacitor 8 μ F OLYMPIA		
For models:	45, 450, 913418, 914167, 914168, 914398, 914399, 914443, 914943, 915695, 915696, 915819, E.45, Fast145, FAST-145, Fast145D, FAST-145D, Niagara-45		
spare parts for	500152		
	Part No.	365013	Ref. No. 206001
	operating capacitor capacity 8 μ F 400V tolerance 5%Hz ambient temperature max. -25 to +85°C \varnothing 31.5mm L 55mm M8 plastic connection male faston 6.3mm protection		
	Part No.	509007	Ref. No. 124043
	impellor \varnothing 85mm H 20mm rotation direction left thread M10R shaft \varnothing 12mm shaft length 7.5mm blades 12		
	Part No.	510693	Ref. No. 141002 70942 80121 RAT72
	mechanical shaft seal for shaft \varnothing 12mm slide ring ext. \varnothing 24mm slide ring H 15.5mm slide ring int. \varnothing 11mm counter ring mounting \varnothing 24mm height counter ring 8mm counter ring int. \varnothing 13.5mm		
	Part No.	521703	Ref. No. 456038 456063
	pump cover gasket EPDM thickness 2.5mm ID \varnothing 75mm Qty 1 pcs		

booster pumps I





1









Part No.	500060	Ref. No.	130013 130049 130052
description	pump inlet \varnothing 1" outlet \varnothing 1" type PQM60 230V 50Hz 1 phase 0.37kW PEDRELLO		
For models:	R495, R497, R499, R501, R503, R505, R507, R509, R511, R704, R706, R708, S621, S623, S624, S626, S631, S633, S634, S636, S641, S643, S651, S651P, S653, S654, S655, S810, S815, S830, S835, S850, S870, S950, SR651		
accessories for	500060		
	Part No.	365015	Ref. No. 206002
	operating capacitor capacity 10 μ F 400V tolerance 5%Hz ambient temperature max. -25 to +85°C \varnothing 35.5mm L 59mm M8 plastic connection male faston 6.3mm protection		



1

Part No.	500359	Ref. No.	130143 DPE127
description	pump inlet \varnothing 12 outlet \varnothing 12 type PPL46DX 230V 50Hz 0.33kW capacitor 10 μ F LGB		
For models:	80, 81, 82, 914568, 915756, CE78HZ23, CGL74CABT, E.50D.PA, E78, E78HP, FAST-160D-PA, FAST-181, HM1, NIAGARA-283, Niagara-283A, RIVER-71, RIVER-78, RIVER-80, River-81, RIVER-82, RIVER-E78, RV71, RV80, RV8023, RV8023HZ, RV80C, RV80HZ, RV81, RV8123, RV81A, RV81C, RV81HZ, RV81HZ23, RV81PAP, RV82, RV8223, RV82C, SevenL, ST70FAST, SV72AEB, SV72EB		
spare parts for	500359		
	Part No.	698663	Ref. No. —
	impellor \varnothing 60mm H 12mm with flute shaft intake \varnothing 12mm W 60mm suitable for LGB		
accessories for	500359		
	Part No.	365015	Ref. No. 206002
	operating capacitor capacity 10 μ F 400V tolerance 5%Hz ambient temperature max. -25 to +85°C \varnothing 35.5mm L 59mm M8 plastic connection male faston 6.3mm protection		



			
1			
Part No.	500358	Ref. No.	130102 130120
description	pump inlet \varnothing 3/8" outlet \varnothing 3/8" type PS46 230V 50Hz 0.45kW \varnothing 100mm L 200mm capacitor 10 μ F LGB		
For models:	45, 450, 46, 460, 500F, 500FD, 50F, 50FD, 510F, 510FD, 913297, 913298, 913299, 913300, 913360, 913361, 913391, 913392, 913546, 913547, 913578, 913611, 913684, 913913, 913914, 913932, 913933, 914284, 914326, 914331, 914356, 914400, 914401, 914402, 914403, 914404, 914405, 914406, 914449, 914517, 914545, 914642, 914688, 914909, 914979, 915136, 915137, 915140, 915248, CLEAN-3...(Other models you can see in the webshop)		
spare parts for	500358		
	Part No.	510713	Ref. No. 141009
	slide ring for shaft \varnothing 12mm ED \varnothing 24mm H 16mm		
	Part No.	510723	Ref. No. —
	counter ring H 8mm ED \varnothing 26mm ID \varnothing 13.5mm for mechanical shaft seal		
	Part No.	698400	Ref. No. —
	pump cover gasket pump type PS46 thickness 2mm ID \varnothing 66mm Qty 1 pcs		
accessories for	500358		
	Part No.	365015	Ref. No. 206002
	operating capacitor capacity 10 μ F 400V tolerance 5%Hz ambient temperature max. -25 to +85°C \varnothing 35.5mm L 59mm M8 plastic connection male faston 6.3mm protection		
	Part No.	511279	Ref. No. —
	hose connector brass straight thread 3/8" hose \varnothing 12mm Qty 1 pcs		
	Part No.	520202	Ref. No. 927015
	hose connector nickel-plated brass straight thread 3/8" hose \varnothing 12mm Qty 1 pcs		
	Part No.	520677	Ref. No. —
	hose connector brass straight thread 3/8" hose \varnothing 13mm Qty 1 pcs		

drain pumps

ASKOLL



1

Part No.	500210	Ref. No.	130123
description	drain pump 230V 40W		
For models:	2312-007, 2312-009-CRP, 45, 450, 913289, 913290, 913291, 913292, 913356, 913357, 913363, 913364, 913372, 913373, 913374, 913375, 913376, 913377, 913416, 913418, 913435, 913544, 913545, 913665, 913666, 913667, 913668, 913685, 913771, 913772, 913773, 913774, 913832, 913837, 913911, 913912, 913948, 913950, 913977, 913984, 913990, 914100, 914101, 914165, 914166, 914167, 914168, 914206, 914214, 914316...(Other models you can see in the webshop)		



1

Part No.	501514	Ref. No.	130175
description	drain pump 40W 220-240V inlet \varnothing 30mm outlet \varnothing 22mm 50Hz ASKOLL type M231 XP		
For models:	916020, 916021, 916024, 916025, 916026, 916027, 916030, 916031, 916045, 916247, 916248, 916249, 916250, 916251, 916252, 916382, 916383, 916504, 916584, 916654, 916670, 916763, 916921, 916922, 916992, 916993, 917044, 917049, Clean161, Fast145-2, Fast150, Fast160-2, Fast160C, Fast161-2, Ocean360, Ocean360M, Ocean360-UK		



1

Part No.	501541	Ref. No.	130177
description	drain pump 40W 220-240V inlet \varnothing 30mm outlet \varnothing 22mm 50Hz ASKOLL type M231 XP		
For models:	915150, 915151, 915152, 915154, 915155, 915157, 915158, 915160, 915161, 915162, 915166, 915167, 915168, 915172, 915173, 915175, 915319, 915348, 915418, 915419, 915420, 915421, 915422, 915479, 915492, 915493, 915494, 915495, 915496, 915497, 915547, 915558, 915611, 915612, 915613, 915617, 915618, 915635, 915663, 915670, 915672, 915747, 915773, 915774, 915959, 916054, 916066, 916067, 916068, 916069...(Other models you can see in the webshop)		




1

Part No.	499315	Ref. No.	130178
description	drain pump inlet ø 24/30/35/39mm outlet ø 22/31mm 230V 40W 50Hz ASKOLL type M231 XP kit		
For models:	915686, 915687, 915689, 915690, 915691, 915692, 915693, 915694, 916162, 916181, 916183, 916184, 916185, 916237, 916238, 916239, 916240, 916241, 916242, 916243, 916244, 916245, 916246, 916401, 916402, 916403, 916404, 916405, 916406, 916407, 916408, 916583, 916751, 916787, 916788, 916991, 917042, 917043, Clean140, Clean140S, Fast130, Fast135-2, Fast135-2S, Fast135CT, Fast135D, Fast135H, Fast135H-2, Fast135H-2S, Fast135HCT, Fast135HD...(Other models you can see in the webshop)		



1


Part No.	500215	Ref. No.	130138
description	drain pump inlet ø 30mm outlet ø 22mm 230V 40W 50Hz ASKOLL type M231 XP with holder		
For models:	E.35, E.40		



1

Part No.	499245	Ref. No.	999162	
description	drain pump inlet ø 24mm outlet ø 22mm 220-240V 40W 50Hz ASKOLL type M231 XP kit			
spare parts for	499245			
	Part No.	500994	Ref. No.	—
	drain pump inlet ømm outlet ømm 230V 40W 50Hz ASKOLL type M231 XP without lid			

GRE




1

Part No.	500057	Ref. No.	130021 130022
description	drain pump inlet ø 22/30mm outlet ø 22mm 100W 230V 50Hz GRE		
For models:	R505, S621, S624, S631, S634, S651, S651P, S654, S655, S810, S815, S830, S835, SR651		



1




Part No.	499244	Ref. No.	999150	
description	drain pump inlet ø 30mm outlet ø 22mm 220-240V 40W 50Hz ASKOLL type M231 XP kit			
spare parts for	499244			
	Part No.	500994	Ref. No.	—
	drain pump inlet ømm outlet ømm 230V 40W 50Hz ASKOLL type M231 XP without lid			




1


Part No.	500087	Ref. No.	130070 130083
description	drain pump inlet ø 25mm outlet ø 21mm 100W 230V 50Hz GRE with temperature protection		
For models:	21F, 21FD, 21R, 21RD, 25F, 25FD, 25R, 25RD, 30F, 30FD, 30R, 30RD, 31F, 31FD, 31R, 31RD, S621, S623, S624, S626, S631, S633, S634, S636		




				
1				
Part No.	500213	Ref. No.	130071 130084	
description	drain pump inlet ø 30mm outlet ø 22mm 100W 230V 50Hz GRE			
For models:	22F, 22R			
spare parts for	500213			
	Part No.	500307	Ref. No.	121053
				filter
	Part No.	500899	Ref. No.	—
				pump cover inlet ø 30mm outlet ø 22mm pump type 500.213

			
1			
Part No.	500546	Ref. No.	130094
description	drain pump inlet ø 30mm outlet ø 23mm 100W 230V 50Hz GRE		
For models:	22F, 40F, 440F, 44F, E.52		



			
1			
Part No.	500247	Ref. No.	926103
description	drain pump inlet ø 34mm outlet ø 29mm 100W 230V 50Hz GRE		
For models:	E1, E10, E100, E110		

			
1			
Part No.	500350	Ref. No.	929114
description	drain pump inlet ø 34mm outlet ø 29mm 100W 230V 50Hz GRE		
For models:	E.60, E.65, E120, E140		

			
1			
Part No.	500212	Ref. No.	130112
description	drain pump inlet ømm outlet ømm 100W 230V 50Hz GRE without lid		
For models:	CLEAN-3, RIVER-43		

accessories


holders

				
1				
Part No.	513717	Ref. No.	035064	
description	fastening angle for drain pump			
For models:	050F, 050FP, 2312-002, 913297, 913298, 913299, 913300, 913360, 913361, 913391, 913392, 913546, 913547, 913578, 913611, 913684, 913913, 913914, 913932, 913933, 914284, 914318, 914319, 914331, 914338, 914356, 914400, 914401, 914402, 914403, 914404, 914405, 914431, 914449, 914517, 914545, 914568, 914642, 914688, 914909, 914979, 915136, 915137, 915140, 915248, 915483, 915484, 915528, 915537, 915538...(Other models you can see in the webshop)			
accessories for	513717			
	Part No.	518171	Ref. No.	111019 111030 111999
				opposite support mounting pos. lower for wash arm support

booster pumps II


accessories

			
1			
Part No.	365015	Ref. No.	206002
description	operating capacitor capacity 10µF 400V tolerance 5%Hz ambient temperature max. -25 to +85°C ø 35.5mm L 59mm M8 plastic connection male faston 6.3mm protection		
For models:	500F, 500FD, 50F, 50FD, 510F, 510FD, 913297, 913298, 913299, 913300, 913360, 913361, 913391, 913392, 913546, 913547, 913578, 913611, 913684, 913913, 913914, 913932, 913933, 913992, 913993, 914100, 914101, 914284, 914326, 914331, 914339, 914342, 914343, 914356, 914400, 914401, 914402, 914403, 914404, 914405, 914406, 914449, 914517, 914545, 914568, 914624, 914625, 914626, 914627, 914642...(Other models you can see in the webshop)		

1

Part No.	365017	Ref. No.	206008 206010
description	operating capacitor capacity 5µF 450V tolerance 5% 50/60Hz ambient temperature max. -25 to +85°C ø 28mm L 54mm M8 plastic connection male faston 6.3mm 16.10.08 protection		
For models:	11F, 11FD, 11F-DVGW, 11R, 11RD, 350F, 350FD, 350R, 350RD, 35-ELECTRONIC, 35F, 35FD, 35R, 35RD, 67F, 67R, 913289, 913290, 913356, 913363, 913364, 913372, 913373, 913376, 913377, 913544, 913665, 913667, 913771, 913772, 913832, 913837, 914165, 914166, 914206, 914355, 914386, 914387, 914388, 914389, 914390, 914391, 914692, 914693, 914694, 914703, 914870, 915686, 915687, 915688...(Other models you can see in the webshop)		




1

Part No.	365012	Ref. No.	206009
description	operating capacitor capacity 6.3µF 450V tolerance 5% 50Hz ambient temperature max. -25 to +85°C ø 30mm L 61mm M8 plastic connection male faston 6.3mm protection		
For models:	400F, 400FD, 400R, 400RD, 40-ELECTRONIC, 40F, 40FD, 40R, 40RD, 913291, 913292, 913357, 913374, 913375, 913416, 913435, 913545, 913666, 913668, 913685, 913773, 913774, 913911, 913912, 913948, 913950, 913977, 913984, 913990, 913992, 913993, 914214, 914316, 914317, 914392, 914393, 914394, 914395, 914396, 914397, 914441, 914442, 914515, 914516, 914537, 914543, 914547, 914583, 914592, 914612...(Other models you can see in the webshop)		

accessories


pump covers



1


Part No.	510514	Ref. No.	116009
description	pump cover pump type T110		

pump cover gaskets



1

Part No.	513283	Ref. No.	437082
description	gasket		
For models:	913289, 913290, 913356, 913372, 913373, 913544, 913665, 913667, 913771, 913772, 913832, 913837, 914165, 914166, 914206, 914355, 914386, 914387, 914388, 914389, 914390, 914391, 914692, 914693, 914694, 914703, 914870, 915686, 915687, 915688, 915689, 915690, 915691, 916237, 916238, 916239, 916240, 916241, 916401, 916402, 916403, 916404, 916787, E.35, E.35-Elettrobar, E.35H, E.35H-Elettrobar, Fast130, FAST-135, Fast135-2...(Other models you can see in the webshop)		



1

Part No.	524535	Ref. No.	929180
description	pump cover gasket thickness 4.5x4.5mm ID ø 182mm Qty 1 pcs		
For models:	KLP201DDDTEB, KLP201EB, KLP301, KLP301DDDTEB, LP201DDDTEB, LP201EB, LP301, LP301EB, RIVER-297, RIVER-298, RV297, RV298, RV298HZ, U132, U132E, U70, U70e		

condensators & interference suppression filters

operating capacitors


plastic



1


Part No.	365015	Ref. No.	206002
description	operating capacitor capacity 10µF 400V tolerance 5%Hz ambient temperature max. -25 to +85°C ø 35.5mm L 59mm M8 plastic connection male faston 6.3mm protection		
For models:	500F, 500FD, 50F, 50FD, 510F, 510FD, 913297, 913298, 913299, 913300, 913360, 913361, 913391, 913392, 913546, 913547, 913578, 913611, 913684, 913913, 913914, 913932, 913933, 913992, 913993, 914100, 914101, 914284, 914326, 914331, 914339, 914342, 914343, 914356, 914400, 914401, 914402, 914403, 914404, 914405, 914406, 914449, 914517, 914545, 914568, 914624, 914625, 914626, 914627, 914642...(Other models you can see in the webshop)		




			
1			
Part No.	365021	Ref. No.	206004
description	operating capacitor capacity 16µF 425V tolerance 5% 50/60Hz ambient temperature max. -25 to +85°C ø 35mm L 73mm single M8 plastic connection male faston 6.3mm 416.10.99 protection		
For models:	050F, 050FP, 22F, 2312-001, 2312-002, 2312-007, 2312-009-CRP, 40F, 440F, 44F, 46, 460, 500F, 500FD, 50F, 50FD, 510F, 510FD, 913297, 913298, 913299, 913300, 913360, 913361, 913391, 913392, 913546, 913547, 913578, 913611, 913684, 913913, 913914, 913932, 913933, 914100, 914101, 914284, 914318, 914319, 914331, 914338, 914339, 914342, 914343, 914356, 914400, 914401, 914402, 914403...(Other models you can see in the webshop)		

			
1			
Part No.	365019	Ref. No.	206005
description	operating capacitor capacity 20µF 400V tolerance 5% 50/60Hz ambient temperature max. -25 to +85°C ø 39.5mm L 70mm M8 plastic connection male faston 6.3mm 16.10.25. protection		
For models:	10, 440F, 44F, 80, 81, 82, 914326, 914406, 915729, CE78HZ23, CLEAN-100, E.52, E.55, E100, E78, E78HP, Fast181, FAST-181, Fast181-230V-3Ph-60Hz, Fast181-400V-3NPh-60Hz, FAST-63, HM1, LP60, NG271, NG291, NIAGARA-271, NIAGARA-283, NIAGARA-291, R706, R708, RIVER-282, RIVER-294, RIVER-71, RIVER-78, RIVER-80, RIVER-81, RIVER-81-CRP, RIVER-82-CRP, RIVER-E78, RIVER-HL-81, RIVER-HL-82, RV282, RV294, RV71, RV80, RV8023, RV8023HZ, RV80C, RV80HZ, RV81...(Other models you can see in the webshop)		

			
1			
Part No.	365016	Ref. No.	206006
description	operating capacitor capacity 31.5µF 400V tolerance 5%Hz ambient temperature max. -25 to +85°C ø 45mm L 95mm M8 plastic connection male faston 6.3mm protection		
For models:	66, S850, S870		

			
1			
Part No.	365017	Ref. No.	206008 206010
description	operating capacitor capacity 5µF 450V tolerance 5% 50/60Hz ambient temperature max. -25 to +85°C ø 28mm L 54mm M8 plastic connection male faston 6.3mm 16.10.08 protection		
For models:	11F, 11FD, 11F-DVGW, 11R, 11RD, 350F, 350FD, 350R, 350RD, 35-ELECTRONIC, 35F, 35FD, 35R, 35RD, 67F, 67R, 913289, 913290, 913356, 913363, 913364, 913372, 913373, 913376, 913377, 913544, 913665, 913667, 913771, 913772, 913832, 913837, 914165, 914166, 914206, 914355, 914386, 914387, 914388, 914389, 914390, 914391, 914692, 914693, 914694, 914703, 914870, 915686, 915687, 915688...(Other models you can see in the webshop)		

			
1			
Part No.	365012	Ref. No.	206009
description	operating capacitor capacity 6.3µF 450V tolerance 5% 50Hz ambient temperature max. -25 to +85°C ø 30mm L 61mm M8 plastic connection male faston 6.3mm protection		
For models:	400F, 400FD, 400R, 400RD, 40-ELECTRONIC, 40F, 40FD, 40R, 40RD, 913291, 913292, 913357, 913374, 913375, 913416, 913435, 913545, 913666, 913668, 913685, 913773, 913774, 913911, 913912, 913948, 913950, 913977, 913984, 913990, 913992, 913993, 914214, 914316, 914317, 914392, 914393, 914394, 914395, 914396, 914397, 914441, 914442, 914515, 914516, 914537, 914543, 914547, 914583, 914592, 914612...(Other models you can see in the webshop)		

			
1			
Part No.	365013	Ref. No.	206001
description	operating capacitor capacity 8µF 400V tolerance 5%Hz ambient temperature max. -25 to +85°C ø 31.5mm L 55mm M8 plastic connection male faston 6.3mm protection		
For models:	21F, 21FD, 21R, 21RD, 25F, 25FD, 25R, 25RD, 30F, 30FD, 30R, 30RD, 31F, 31FD, 31R, 31RD, 45, 450, 913418, 914167, 914168, 914398, 914399, 914443, 914943, 915695, 915696, 915819, CLEAN-3, E.45, Fast145, FAST-145, Fast145D, FAST-145D, NIAGARA-45, R495, R497, R499, R501, R503, R505, R507, R509, R511, R704, R706, R708, S621, S623, S624...(Other models you can see in the webshop)		

filters


interference suppression filters


			
1			
Part No.	365048	Ref. No.	212001
description	interference suppression filter type KPB7028 275V 50/60Hz conductor 2 with E connection male faston 6.3mm L 50mm ø 38mm Hmm Wmm M8 aluminium Qty 1 pcs		
For models:	050F, 050FP, 11F, 11FD, 11F-DVGW, 11R, 11RD, 21F, 21FD, 21R, 21RD, 22F, 22R, 25F, 25FD, 25R, 25RD, 30F, 30FD, 30R, 30RD, 31F, 31FD, 31R, 31RD, 350F, 350FD, 350R, 350RD, 35-ELECTRONIC, 35F, 35FD, 35R, 35RD, 400F, 400FD, 400R, 400RD, 40-ELECTRONIC, 40F, 40FD, 40R, 40RD, 440F, 44F, 45, 450, 46, 460, 500F...(Other models you can see in the webshop)		





fuses

fine fuses

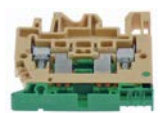
			
1			
Part No.	358530	Ref. No.	926284
description	fine fuse size ø5x20mm 0.8A fast-acting rated 250V Qty 10 pcs		
For models:	80, 81, 914380, 914436, CE78HZ23, CGL74CABT, E78, E78HP, FAST-181, HM1, KLP105EB, KLP201DDDTTEB, KLP201EB, KLP301, KLP301DDDTTEB, LP105DDDTTEB, LP105DDDTTEBN, LP105EB, LP201DDDTTEB, LP201EB, LP301, LP301EB, LP60, PS-60, RIVER-150, River-152, RIVER-154, RIVER-71, RIVER-80, River-81, River-81CRP, RIVER-81-CRP, RIVER-82, River-82CRP, RIVER-82-CRP, RIVER-E78, RIVER-HL-81, RV150, RV15023, RV15023DA, RV150D, RV150DA, RV150DAR, RV150DARY, RV150DAW, RV150DAWY, RV150DAY, RV150DE, RV150DRW, RV150DW...(Other models you can see in the webshop)		


			
1			
Part No.	358677	Ref. No.	228004 228010
description	fine fuse size ø5x20mm 4A fast-acting rated 250V Qty 10 pcs		
For models:	2312-007, 2312-009-CRP, 80, 81, 82, 913363, 913364, 913911, 913912, 913913, 913914, 913950, 913977, 913984, 913990, 913992, 913993, 914100, 914101, 914165, 914166, 914167, 914168, 914206, 914214, 914284, 914316, 914317, 914318, 914319, 914338, 914339, 914342, 914343, 914355, 914356, 914380, 914431, 914436, 914516, 914543, 914583, 914592, 914612, 914613, 914624, 914625, 914626, 914627, 914628...(Other models you can see in the webshop)		


			
1			
Part No.	358606	Ref. No.	228014
description	fine fuse size ø5x20mm 4A slow-acting rated 250V Qty 10 pcs		
For models:	916237, 916238, 916239, 916240, 916241, 916242, 916243, 916244, 916245, 916246, 916401, 916402, 916403, 916404, 916405, 916406, 916407, 916408, 916451, 916583, 916687, 916787, 916991, 917042, 917043, Clean140, Clean140S, Fast130, Fast135-2, Fast135-2S, Fast135H-2, Fast135H-2S, Fast139-2, Fast139-2S, Fast139H-2, Fast139H-2S, Fast140		

			
1			
Part No.	358760	Ref. No.	926283
description	fine fuse size ø6.3x32mm 0.315A medium lag rated 250V Qty 10 pcs		
For models:	80, 81, 914380, 914436, CE78HZ23, CGL74CABT, E78, E78HP, FAST-181, HM1, KLP105EB, KLP201DDDTTEB, KLP201EB, KLP301, KLP301DDDTTEB, LP105DDDTTEB, LP105DDDTTEBN, LP105EB, LP201DDDTTEB, LP201EB, LP301, LP301EB, LP60, PS-60, RIVER-150, River-152, RIVER-154, RIVER-71, RIVER-80, River-81, River-81CRP, RIVER-81-CRP, RIVER-82, River-82CRP, RIVER-82-CRP, RIVER-E78, RIVER-HL-81, RV150, RV15023, RV15023DA, RV150D, RV150DA, RV150DAR, RV150DARY, RV150DAW, RV150DAWY, RV150DAY, RV150DE, RV150DRW, RV150DW...(Other models you can see in the webshop)		

fine fuse holders

			
1			
Part No.	551234	Ref. No.	210010
description	fuse holder suitable fuse ø5x20mm 1-pole 6.3A rated 600V L 52mm W 8mm H 51mm connection screw clamp cross section 4mm ²		
For models:	913913, 913914, 913992, 913993, 914100, 914101, 914167, 914168, 914284, 914318, 914319, 914338, 914356, 914431, 914583, 914592, 914612, 914613, 914624, 914625, 914627, 914628, 914642, 914850, 914851, 914854, 914909, 914943, 914944, 915136, 915137, 915143, 915150, 915151, 915152, 915160, 915161, 915162, 915166, 915167, 915168, 915175, 915176, 915177, 915319, 915338, 915341, 915348, 915418, 915419...(Other models you can see in the webshop)		

			
1			
Part No.	550499	Ref. No.	H.228047
description	fuse holder suitable fuse ø5x20mm 6.3A rated 500V		
For models:	2312-007, 2312-009-CRP, 80, 81, 82, 913911, 913912, 913950, 913977, 913984, 913990, 914165, 914166, 914206, 914214, 914316, 914317, 914339, 914342, 914343, 914355, 914380, 914436, 914516, 914543, 914626, 914684, 914874, 915138, A3EB, A3EBD, A3EBDAKRKYK, A3EB-DAKWK, A3EBDBKWK, A3EBDRKYK, A3EBDVK, A3EBDYK, A3EBSAK, A3EBSAKRK, A3EBSAKWK, A3EBSBKWKYK, A3EBSEKWK, A3EBSWK, A4EB, A4EBD, A4EBDAKEKYK, A4EBDAKRK, A4EBDAKWK, A4EBDAKZK, A4EBDBKRK...(Other models you can see in the webshop)		


			
1			
Part No.	550519	Ref. No.	H.228048
description	cover plate suitable fuseA ratedV connection for fuse holder		
For models:	2312-007, 2312-009-CRP, 80, 81, 82, 913911, 913912, 913950, 913977, 913984, 913990, 914165, 914166, 914206, 914214, 914316, 914317, 914339, 914342, 914343, 914355, 914380, 914436, 914516, 914543, 914626, 914684, 914874, 915138, CE78HZ23, CGL74CABT, CNT800CH, E78, E78HP, Fast180, Fast180-230V-3Ph-60Hz, Fast181, FAST-181, Fast181-230V-3Ph-60Hz, Fast181-400V-3NPh-60Hz, Fast200, FAST-200, FAST-60, FAST-73, Fast93, GL280EB, GL280EB23, GL280EB23DAR, GL280EB23HZ, GL280EB23HZDY...(Other models you can see in the webshop)		

electric accessories


cables


ribbon cables

group 1




			
1			
Part No.	402970	Ref. No.	41523
description	ribbon cable 10-pole L 1200mm plug type 2 row coded Qty 1m		
For models:	KLP301, LP301		



			
Part No.	400903	Ref. No.	211009
description	ribbon cable 10-pole L 2290mm plug type FC-10P raster size 2.54mm		
For models:	050F, 050FP, 2312-007, 2312-009-CRP, 913911, 913912, 913913, 913914, 913950, 913977, 913984, 913990, 914100, 914101, 914165, 914166, 914167, 914168, 914206, 914214, 914284, 914316, 914317, 914318, 914319, 914338, 914339, 914342, 914343, 914355, 914356, 914431, 914516, 914543, 914624, 914625, 914626, 914627, 914628, 914642, 914684, 914850, 914851, 914854, 914874, 914909, 914943, 914944, 915136, 915137...(Other models you can see in the webshop)		


			
Part No.	400902	Ref. No.	80934 926281 DWS90
description	ribbon cable 10-pole L 750mm plug type FC-10P raster size 2.54mm		
For models:	915747, CNT800CH, Fast180, Fast180-230V-3Ph-60Hz, Fast181, Fast200, FAST-200, Fast93, GL280EB, GL280EB23, GL280EB23DAR, GL280EB23HZ, GL280EB23HZDY, GL280EBD, GL280EBDA, GL280EBDAE, GL280EBDAR, GL280EBDARY, GL280EBDAW, GL280EBDAWY, GL280EBDAY, GL280EBDB, GL280EBDBR, GL280EBDBW, GL280EBDWWY, GL280EBDY, GL280EBS, GL280EBSA, GL280EBSAE, GL280EBSAEW, GL280EBSAEWY, GL280EBSAR, GL280EBSARY, GL280EBSAW, GL280EBSAWY, GL280EBSAY, GL280EBSB, GL280EBSR, GL280EBSWY, GL280EBSY, GL282EB, GL282EB93, GL282EB93DA, GL282EB93HZ23, GL282EBCH, GL282EBCHD, GL282EBD, GL282EBDA, GL282EBDAE, GL282EBDAR...(Other models you can see in the webshop)		


plug connectors


			
Part No.	400761	Ref. No.	CN5
description	plug connector 5-pole		
For models:	2312-007, 913911, 913912, 913913, 913914, 913950, 913977, 913984, 913990, 913992, 913993, 914100, 914101, 914165, 914166, 914167, 914168, 914206, 914214, 914284, 914316, 914317, 914318, 914319, 914338, 914339, 914342, 914343, 914355, 914356, 914431, 914516, 914543, 914583, 914592, 914612, 914613, 914624, 914625, 914626, 914627, 914628, 914642, 914684, 914850, 914851, 914854, 914874, 914909, 914943...(Other models you can see in the webshop)		
accessories for	400761		
	Part No.	550048	Ref. No. —
	female bullet		
	Part No.	551394	Ref. No. CN7
	female bullet \varnothing 2.8mm CuZn gal Sn Qty 1 pcs suitable for CN5		

terminals

connection terminals with screw/faston connections


			
Part No.	550278	Ref. No.	921044
description	power terminal block 3-pole max. 40A max 400V connection \varnothing 6mm ² / F6.3 temp.-resist. 150°C cross section 6mm ²		

			
Part No.	550349	Ref. No.	220010
description	power terminal block 4-pole max. 40A max 400V connection \varnothing 6mm ² / F6.3 temp.-resist. 150°C cross section 6mm ²		
For models:	11F, 11FD, 11R, 11RD, 350F, 350FD, 350R, 350RD, 35F, 35FD, 35R, 35RD, 400F, 400FD, 400R, 400RD, 40F, 40FD, 40R, 40RD, 45, 450, 500F, 500FD, 50-ELECTRONIC, 50F, 50FD, 67F, 67R, 913418, 913992, 913993, 914167, 914168, 914398, 914399, 914443, 914583, 914592, 914612, 914613, 914943, 915143, 915611, 915612, 915613, 915614, 915615, 915616, 915617...(Other models you can see in the webshop)		

			
Part No.	550411	Ref. No.	220011 921057
description	power terminal block 6-pole max. 40A max 450V connection \varnothing 6mm ² / F6.3 temp.-resist. 150°C cross section 6mm ²		
For models:	050F, 050FP, 10, 12, 14, 22F, 2312-001, 2312-002, 2312-007, 2312-009-CRP, 440F, 44F, 46, 460, 500F, 500FD, 50-ELECTRONIC, 50F, 50FD, 510F, 510FD, 80, 81, 82, 913297, 913298, 913299, 913300, 913360, 913361, 913391, 913392, 913546, 913547, 913578, 913611, 913684, 913913, 913914, 913932, 913933, 914100, 914101, 914284, 914318, 914319, 914326, 914331, 914338, 914339...(Other models you can see in the webshop)		




connection boxes

 <p>1</p>			
Part No.	550300	Ref. No.	459018
description	power terminal block 3-pole contacts P+N+E		
For models:	913289, 913290, 913291, 913292, 913356, 913357, 913363, 913364, 913372, 913373, 913374, 913375, 913376, 913377, 913416, 913435, 913544, 913545, 913665, 913666, 913667, 913668, 913685, 913771, 913772, 913773, 913774, 913832, 913837, 913911, 913912, 913948, 913950, 913977, 913984, 913990, 914165, 914166, 914206, 914214, 914316, 914317, 914355, 914386, 914387, 914388, 914389, 914390, 914391, 914392...(Other models you can see in the webshop)		

rail-mounted terminals

miscellaneous

 <p>1</p>			
Part No.	551234	Ref. No.	210010
description	fuse holder suitable fuse ø5x20mm 1-pole 6.3A rated 600V L 52mm W 8mm H 51mm connection screw clamp cross section 4mm ²		
For models:	913913, 913914, 913992, 913993, 914100, 914101, 914167, 914168, 914284, 914318, 914319, 914338, 914356, 914431, 914583, 914592, 914612, 914613, 914624, 914625, 914627, 914628, 914642, 914850, 914851, 914854, 914909, 914943, 914944, 915136, 915137, 915143, 915150, 915151, 915152, 915160, 915161, 915162, 915166, 915167, 915168, 915175, 915176, 915177, 915319, 915338, 915341, 915348, 915418, 915419...(Other models you can see in the webshop)		

equipmentspecific units

miscellaneous


 <p>1</p>			
Part No.	699128	Ref. No.	927095
description	shaft sealing ED ø 40mm ID ø 30mm H 7mm plastic for vegetable slicer		
For models:	161, 221, 271, 272, 362, CLEAN-160, CLEAN-161, CLEAN-220, CLEAN-221, CLEAN-270, CLEAN-271, CLEAN-272, CLEAN-361, CLEAN-361P, CLEAN-362, CLEAN-471, CLEAN-471P		

steam/water taps

steam/water pipes

accessories

gaskets


 <p>1</p>			
Part No.	510893	Ref. No.	456015
description	O-ring EPDM thickness 2.62mm ID ø 9.92mm Qty 1 pcs		
For models:	050F, 050FP, 2312-001, 2312-002, 31F, 31FD, 31R, 31RD, 500F, 500FD, 50F, 50FD, 510F, 510FD, 67F, 67R, 913297, 913298, 913299, 913300, 913360, 913361, 913363, 913364, 913376, 913377, 913391, 913392, 913418, 913546, 913547, 913578, 913611, 913684, 913913, 913914, 913932, 913933, 914167, 914168, 914284, 914318, 914319, 914326, 914331, 914338, 914356, 914398, 914399, 914400...(Other models you can see in the webshop)		

for dishwashers

drain and intake components

ELETTROBAR


drain /intake bodies


 <p>1</p>			
Part No.	518190	Ref. No.	463009
description	drain connection thread 3/4" H 35mm hose ø 25mm		
For models:	350F, 350FD, 350R, 350RD, 35-ELECTRONIC, 35F, 35FD, 35R, 35RD, 400F, 400FD, 400R, 400RD, 40-ELECTRONIC, 40F, 40FD, 40R, 40RD		


 <p>1</p>			
Part No.	507539	Ref. No.	42185
description	drain fitting complete thread 1½" ED ø 68mm ID ø 41mm		
For models:	914380, 914436, A3EBD, A3EBDAKWK, A3EBDBKWK, A3EBDWK, A3EBDYK, A3EBSAK, A3EBSAKWK, A3EBSBKWKYK, A3EBSWK, A4EBD, A4EBS, A4EBSAKRK, A4EBSAKYK, A4EBSCK, A5EBD, A5EBDAKPKWK, A5EBDAKWK, A5EBS, A5EBSAKPKWK, A5EBSYK, FAST-200, GL280EB, GL280EBD, GL280EBDA, GL280EBDAE, GL280EBDAR, GL280EBDA-WY, GL280EBDBW, GL280EBDY, GL280EBS, GL280EBSY, GL282EB, GL282EBCH, GL282EBCHD, GL282EBD, GL282EBDAE, GL282EBDAR, GL284EBD, GL284EBDAWY, GL284EBS, GL284EBSAR, GL286EBD, GL286EBDARY, GL286EBS, GL286EBSAW, KLP201DDDTTEB, KLP201EB, KLP301...(Other models you can see in the webshop)		







			
1			
Part No.	518194	Ref. No.	136023
description	drain fitting thread 1 1/4" hose ø 30mm		
For models:	050F, 050FP, 2312-001, 2312-002, 272, 362, 45, 450, 46, 460, 500F, 500FD, 50F, 50FD, 510F, 510FD, 913297, 913298, 913299, 913300, 913360, 913361, 913391, 913392, 913418, 913546, 913547, 913578, 913611, 913684, 913913, 913914, 913932, 913933, 914167, 914168, 914284, 914318, 914319, 914331, 914338, 914356, 914398, 914399, 914400, 914401, 914402, 914403, 914404, 914405...(Other models you can see in the webshop)		
accessories for	518194		
	Part No.	513059	Ref. No. 437063
	flat gasket rubber ED ø 52mm ID ø 40mm thickness 3mm Qty 1 pcs		
	Part No.	513103	Ref. No. 417081
	screw connection thread 1 1/4" H 10mm		


			
1			
Part No.	518187	Ref. No.	429036 429048
description	drain fitting thread 3/4" ID ø 22mm		
For models:	11F-DVGW, 11R, 11RD, 2312-009-CRP, 350F, 350FD, 350R, 350RD, 35-ELECTRONIC, 35F, 35FD, 35R, 35RD, 400F, 400FD, 400R, 400RD, 40-ELECTRONIC, 40F, 40FD, 40R, 40RD, 913992, 913993, 914100, 914101, 914339, 914342, 914343, 914583, 914624, 914625, 914626, 914627, 914628, 914850, 914851, 914854, 914944, 915143, 915747, A4EBT, A4EBTSAK, CLEAN-3, E.41, E.42, KLP105EB, KLP201DDTTEB, KLP201EB, KLP301...(Other models you can see in the webshop)		


			
1			
Part No.	510046	Ref. No.	999009
description	drain unit complete		
For models:	R495		

			
1			
Part No.	510101	Ref. No.	999067
description	drain unit complete thread 3/4" hose ø 25mm		
For models:	11F, 11FD, 11R, 11RD		


			
1			
Part No.	518177	Ref. No.	111023 116023
description	drain unit thread 3/4" ID ø 35mm hose ø 24mm		
For models:	913289, 913290, 913291, 913292, 913356, 913357, 913372, 913373, 913374, 913375, 913416, 913435, 913544, 913545, 913665, 913666, 913667, 913668, 913685, 913771, 913772, 913773, 913774, 913832, 913837, 913911, 913912, 913948, 913950, 913977, 913984, 913990, 914165, 914166, 914206, 914214, 914316, 914317, 914355, 914386, 914387, 914388, 914389, 914390, 914391, 914392, 914393, 914394, 914395, 914396...(Other models you can see in the webshop)		
accessories for	518177		
	Part No.	513266	Ref. No. 417104
	nut		
	Part No.	518176	Ref. No. 3243685 478056
	rinse pipe		


			
1			
Part No.	510074	Ref. No.	437025
description	flat gasket FIBER ED ø 35mm ID ø 27mm thickness 1.5mm Qty 1 pcs		
For models:	11F, 11FD, 11F-DVGW, 11R, 11RD, 2312-009-CRP, 350F, 350FD, 35-ELECTRONIC, 35F, 35FD, 400F, 400FD, 400R, 400RD, 40-ELECTRONIC, 40F, 40FD, 40R, 40RD, 67F, 67R, 913363, 913364, 913376, 913377, 913992, 913993, 914100, 914101, 914339, 914342, 914343, 914583, 914624, 914625, 914626, 914627, 914628, 914850, 914851, 914854, 914944, 915143, 915747, A4EBT, A4EBTSAK, CLEAN-3, E.41, E.42...(Other models you can see in the webshop)		


			
1			
Part No.	510080	Ref. No.	437027
description	flat gasket fibre ED ø 44.5mm ID ø 33mm thickness 2mm Qty 1 pcs		
For models:	11F, 11FD, 11F-DVGW, 11R, 11RD, 66, 67F, 67R, 913363, 913364, 913376, 913377, E.41, E.42, E.41, R495, R497, R499, R501, R503, R505, R507, R509, R511, R704, R706, R708, S651, S654, S810, S815, S830, S835, S870, S950		


			
1			
Part No.	513059	Ref. No.	437063
description	flat gasket rubber ED ø 52mm ID ø 40mm thickness 3mm Qty 1 pcs		
For models:	050F, 050FP, 12, 14, 161, 221, 2312-001, 2312-002, 271, 272, 362, 45, 450, 46, 460, 500F, 500FD, 50-ELECTRONIC, 50F, 50FD, 510F, 510FD, 55, 913297, 913298, 913299, 913300, 913360, 913361, 913391, 913392, 913418, 913546, 913547, 913578, 913611, 913684, 913913, 913914, 913932, 913933, 914167, 914168, 914284, 914318, 914319, 914331, 914338, 914356, 914398...(Other models you can see in the webshop)		






			
Part No.	510070	Ref. No.	437038
description	flat gasket rubber ED ø 61mm ID ø 41.5mm thickness 3mm Qty 1 pcs		
For models:	350F, 350FD, 350R, 350RD, 35-ELECTRONIC, 35F, 35FD, 35R, 35RD, 400F, 400FD, 400R, 400RD, 40-ELECTRONIC, 40F, 40FD, 40R, 40RD, 66, R497, R499, R501, R503, R505, R507, R509, R511, R704, R706, R708, S641, S643, S651, S651P, S653, S654, S655, S810, S815, S830, S835, S850, S870, S950, SR651		


			
Part No.	518205	Ref. No.	437079 80182 reb437079
description	flat gasket rubber ED ø 61mm ID ø 47mm thickness 2mm Qty 1 pcs		
For models:	2312-007, 2312-009-CRP, 80, 81, 82, 913289, 913290, 913291, 913292, 913356, 913357, 913372, 913373, 913374, 913375, 913416, 913435, 913544, 913545, 913665, 913666, 913667, 913668, 913685, 913771, 913772, 913773, 913774, 913832, 913837, 913911, 913912, 913948, 913950, 913977, 913984, 913990, 913992, 913993, 914100, 914101, 914165, 914166, 914206, 914214, 914316, 914317, 914339, 914342, 914343...(Other models you can see in the webshop)		

			
Part No.	518060	Ref. No.	456040
description	gasket rubber ED ø 132mm ID ø 122mm thickness 5mm		
For models:	10, 22F, 22R, 40F, 44F, 80, 81, 82, 914326, 914406, 915729, CE78HZ23, CGL74CABT, CLEAN-100, CLEAN-110, E.52, E.55, E.60, E.65, E1, E10, E100, E110, E78, E78HP, Fast181, FAST-181, Fast181-230V-3Ph-60Hz, Fast181-400V-3NPh-60Hz, FAST-63, HM1, KLP105EB, LP105DDDTTEB, LP105DDDTTEBN, LP105EB, LP60, NG271, NG291, NG292, NG292HZ, NG293, NIAGARA-271, NIAGARA-283, Niagara-283A, NIAGARA-291, NIAGARA-292, Niagara-292-400V-3Ph-60Hz, NIAGARA-293, RIVER-282, River-285...(Other models you can see in the webshop)		



			
Part No.	518210	Ref. No.	437015
description	gasket with 6 holes ED ø 99mm ID ø 51mm		
For models:	050F, 050FP, 2312-001, 2312-002, 45, 450, 46, 460, 500F, 500FD, 50F, 50FD, 510F, 510FD, 913297, 913298, 913299, 913300, 913360, 913361, 913391, 913392, 913546, 913547, 913578, 913611, 913684, 913913, 913914, 913932, 913933, 914284, 914318, 914319, 914331, 914338, 914356, 914400, 914401, 914402, 914403, 914404, 914405, 914431, 914449, 914517, 914545, 914568, 914642, 914688...(Other models you can see in the webshop)		

			
Part No.	513726	Ref. No.	468152
description	hose connector plastic ø 24mm		
For models:	2312-001, 2312-002, 913297, 913298, 913299, 913300, 913360, 913361, 913391, 913392, 913546, 913547, 913578, 913611, 913684, 913913, 913914, 913932, 913933, 914284, 914318, 914319, 914331, 914338, 914356, 914400, 914401, 914402, 914403, 914404, 914405, 914431, 914449, 914517, 914545, 914568, 914642, 914688, 914909, 914979, 915136, 915137, 915140, 915150, 915151, 915152, 915154, 915155, 915157, 915158...(Other models you can see in the webshop)		

			
Part No.	513257	Ref. No.	144003
description	hose connector with exhaust ventilation plastic		
For models:	050F, 050FP, 2312-001, 2312-002, 2312-007, 2312-009-CRP, 913297, 913298, 913299, 913300, 913360, 913361, 913391, 913392, 913546, 913547, 913578, 913611, 913684, 913913, 913914, 913932, 913933, 913992, 913993, 914100, 914101, 914284, 914318, 914319, 914326, 914331, 914338, 914339, 914342, 914343, 914356, 914400, 914401, 914402, 914403, 914404, 914405, 914406, 914431, 914449, 914517, 914545, 914568, 914624...(Other models you can see in the webshop)		
accessories for	513257		
	Part No.	513269	Ref. No.
			423024
	 hose holder		

			
Part No.	513269	Ref. No.	423024
description	hose holder		
For models:	050F, 050FP, 2312-001, 2312-002, 913297, 913298, 913299, 913300, 913360, 913361, 913391, 913392, 913546, 913547, 913578, 913611, 913684, 913913, 913914, 913932, 913933, 914284, 914318, 914319, 914326, 914331, 914338, 914356, 914400, 914401, 914402, 914403, 914404, 914405, 914406, 914431, 914449, 914517, 914545, 914568, 914642, 914688, 914909, 914979, 915136, 915137, 915140, 915248, 915483, 915484...(Other models you can see in the webshop)		

			
Part No.	518064	Ref. No.	136020
description	intake body ED ø 140mm ID ø 102mm hose ø 50/60mm		
For models:	10, 22F, 22R, 40F, 44F, 80, 81, 82, 914326, 914406, 915729, CE78HZ23, CGL74CABT, CLEAN-100, CLEAN-110, E.52, E.55, E.60, E.65, E1, E10, E100, E110, E78, E78HP, Fast181, FAST-181, Fast181-230V-3Ph-60Hz, Fast181-400V-3NPh-60Hz, FAST-63, HM1, KLP105EB, LP105DDDTTEB, LP105DDDTTEBN, LP105EB, LP60, NG271, NG291, NG292, NG292HZ, NG293, NIAGARA-271, NIAGARA-283, Niagara-283A, NIAGARA-291, NIAGARA-292, Niagara-292-400V-3Ph-60Hz, NIAGARA-293, RIVER-282, River-285...(Other models you can see in the webshop)		

			
Part No.	518093	Ref. No.	136028
description	intake body ED ø 155mm ID ø 117mm hose ø 30/42mm		
For models:	915150, 915151, 915152, 915154, 915155, 915157, 915158, 915160, 915161, 915162, 915166, 915167, 915168, 915172, 915173, 915175, 915176, 915177, 915285, 915319, 915338, 915341, 915348, 915418, 915419, 915420, 915421, 915422, 915479, 915492, 915493, 915494, 915495, 915496, 915497, 915547, 915558, 915635, 915663, 915747, 916054, 916067, 916068, 916069, 916079, 916080, 916201, 916202, 916203, 916204...(Other models you can see in the webshop)		
accessories for	518093		
	Part No.	532543	Ref. No.
			456076
	 O-ring EPDM thickness 5.34mm ID ø 136.5mm Qty 1 pcs		

2 mechanical components, equipment accessories



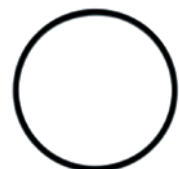
1

Part No.	518503	Ref. No.	463008
description	intake body thread 3/4" H 54mm hose ø 25mm		
For models:	11F, 11FD, 11F-DVGW, 11R, 11RD, 67F, 67R, 913363, 913364, 913376, 913377, E.41, E.42, E41		



1

Part No.	518092	Ref. No.	429072
description	opposite support ED ø 185mm ID ø 92mm		
For models:	915150, 915151, 915152, 915154, 915155, 915157, 915158, 915160, 915161, 915162, 915166, 915167, 915168, 915172, 915173, 915175, 915176, 915177, 915285, 915319, 915338, 915341, 915348, 915418, 915419, 915420, 915421, 915422, 915479, 915492, 915493, 915494, 915495, 915496, 915497, 915547, 915558, 915635, 915663, 915747, 916020, 916021, 916024, 916025, 916026, 916027, 916030, 916031, 916045, 916054...(Other models you can see in the webshop)		



1

Part No.	510009	Ref. No.	456001
description	O-ring EPDM thickness 3.53mm ID ø 101.2mm Qty 1 pcs		
For models:	21F, 21FD, 21R, 21RD, 25F, 25FD, 25R, 25RD, 30F, 30FD, 30R, 30RD, 31F, 31FD, 31R, 31RD, 913418, 914398, 914399, 914443, E.45, S621, S623, S624, S626, S631, S633, S634, S636		



1

Part No.	513103	Ref. No.	417081
description	screw connection thread 1 1/4" H 10mm		
For models:	050F, 050FP, 161, 221, 2312-001, 2312-002, 271, 272, 362, 45, 450, 46, 460, 500F, 500FD, 50-ELECTRONIC, 50F, 50FD, 510F, 510FD, 55, 913297, 913298, 913299, 913300, 913360, 913361, 913391, 913392, 913418, 913546, 913547, 913578, 913611, 913684, 913913, 913914, 913932, 913933, 914167, 914168, 914284, 914318, 914319, 914331, 914338, 914356, 914398, 914399, 914400...(Other models you can see in the webshop)		

filters



1

Part No.	511998	Ref. No.	121135
description	drain filter ø 190mm H 100mm		
For models:	915157, 915158, 915172, 915173, 915285, 915422, 915494, 915495, 915496, 915497, 916054, 916067, 916068, 916069, 916079, 916080, 916368, 916420, 916421, 916422, 916423, 916424, 916686, 916760, River-252-2, River-252-2T, River-253, RIVER-262, River-262-2, River-262-2T, River-272, River-282-2, River-282L-2, River-282LS-2TDE, River-282S-2TDE, River-285, River-352C, River-352T, River-362C, River-362C-230V-3Ph-50Hz, River-362T, River-362T-230V-3Ph-50Hz, River-372, River-382, River-382-230V-3Ph-50Hz, River-382H, River-382L, River-382L-230V-3Ph-50Hz, River-382LNRG, River-382LTDE...(Other models you can see in the webshop)		



1

Part No.	524376	Ref. No.	121120
description	drain filter ø 190mm H 100mm		
For models:	915150, 915151, 915152, 915154, 915155, 915160, 915161, 915162, 915166, 915167, 915168, 915175, 915176, 915177, 915319, 915338, 915341, 915348, 915418, 915419, 915420, 915421, 915479, 915492, 915493, 915494, 915495, 915496, 915497, 915547, 915558, 915635, 915663, 915747, 916020, 916021, 916024, 916025, 916026, 916027, 916030, 916031, 916045, 916201, 916202, 916203, 916204, 916205, 916206, 916207, 916208, 916209, 916247, 916248...(Other models you can see in the webshop)		



1


Part No.	519576	Ref. No.	429076
description	filter for ventilation H 15mm ø 14mm WS 18		
For models:	915150, 915151, 915152, 915154, 915155, 915157, 915158, 915160, 915161, 915162, 915166, 915167, 915168, 915172, 915173, 915175, 915176, 915177, 915285, 915319, 915338, 915341, 915348, 915418, 915419, 915420, 915421, 915422, 915479, 915492, 915493, 915494, 915495, 915496, 915497, 915547, 915558, 915635, 915663, 915747, 916054, FAST-60, FAST-73, NG281, NG281HP, NIAGARA-251, Niagara-261, NIAGARA-281, NIAGARA-281HP, PLUVIA-260...(Other models you can see in the webshop)		




1

Part No.	518105	Ref. No.	927223
description	filter H 130mm L 385mm W 141mm		
For models:	271, 362, CLEAN-161, CLEAN-221, CLEAN-270, CLEAN-271, CLEAN-272, CLEAN-362		




			
1			
Part No.	518106	Ref. No.	60377
description	filter H 135mm L 485mm W 95mm		
For models:	161, 221, 271, 272, 362, CLEAN-161, CLEAN-221, CLEAN-271, CLEAN-272, CLEAN-362		

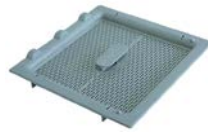
			
1			
Part No.	518107	Ref. No.	60385
description	filter H 33mm L 490mm W 310mm		
For models:	161, 221, 271, 272, 362, CLEAN-161, CLEAN-221, CLEAN-271, CLEAN-272, CLEAN-362		

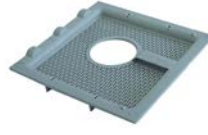
			
1			
Part No.	518065	Ref. No.	429038 429067 80470
description	filter support H 140mm ø 140mm		
For models:	10, 22F, 22R, 40F, 440F, 44F, 80, 81, 82, 914326, 914406, 915729, CE78HZ23, CGL74CABT, CLEAN-100, CLEAN-110, E.52, E.55, E.60, E.65, E1, E10, E100, E110, E78, E78HP, Fast181, FAST-181, Fast181-230V-3Ph-60Hz, Fast181-400V-3NPh-60Hz, FAST-63, HM1, KLP105EB, LP105DDDTTEB, LP105DDDTTEBN, LP105EB, LP60, NG271, NG291, NG292, NG292HZ, NG293, NIAGARA-271, NIAGARA-283, Niagara-283A, NIAGARA-291, NIAGARA-292, Niagara-292-400V-3Ph-60Hz, NIAGARA-293, RIVER-282...(Other models you can see in the web-shop)		

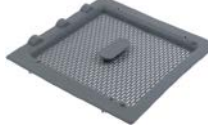
			
1			
Part No.	513187	Ref. No.	80152 80415
description	filter support ø 133mm L 545mm W 275mm		
For models:	80, 82, CGL74CABT, River-81CRP, RIVER-81-CRP, RIVER-82, River-82CRP, RIVER-82-CRP, RIVER-HL-82, RV81CCRP, RV81CRP, RV82, RV8223, RV82C, RV82CCRP, RV82CRP, SevenL		

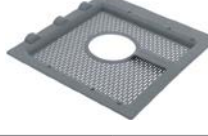
			
1			
Part No.	508374	Ref. No.	80259
description	flat filter H 35mm L 540mm W 274mm		
For models:	CE78HZ23, E78, E78HP, Fast181, FAST-181, Fast181-230V-3Ph-60Hz, Fast181-400V-3NPh-60Hz, HM1, NG271, NG291, NIAGARA-271, NIAGARA-291, RIVER-78, RIVER-E78, ST70FAST, ST70FASTHB, ST70FASTHB400, ST70FASTHZ23		

			
1			
Part No.	518352	Ref. No.	121109
description	flat filter H 90mm L 210mm W 155mm		
For models:	2312-007, 2312-009-CRP, 914100, 914101, 914339, 914342, 914343, 914624, 914625, 914626, 914627, 914850, 914851, 914854, PS-60, RIVER-48, RIVER-50, RIVER-50-CRP, RIVER-54, RIVER-61		


			
1			
Part No.	510025	Ref. No.	121056
description	flat filter L 245mm W 245mm		
For models:	10, 22F, 22R, 40F, CLEAN-100, CLEAN-110, E.52, E1, E10, E100		


			
1			
Part No.	510026	Ref. No.	121057
description	flat filter L 245mm W 245mm		
For models:	22F, 22R, 40F, E.52		

			
1			
Part No.	510641	Ref. No.	121111
description	flat filter L 265mm W 245mm		
For models:	914326, 914406, 915729, E.55, FAST-63		


			
1			
Part No.	510642	Ref. No.	121112
description	flat filter L 265mm W 245mm		
For models:	914326, 914406, 915729, E.55, FAST-63		





			
1			
Part No.	518094	Ref. No.	121123
description	flat filter L 485mm W 225mm		
For models:	915150, 915151, 915152, 915154, 915155, 915157, 915158, 915160, 915161, 915162, 915166, 915167, 915168, 915172, 915173, 915175, 915176, 915177, 915285, 915319, 915338, 915341, 915348, 915418, 915419, 915420, 915421, 915422, 915479, 915492, 915493, 915494, 915495, 915496, 915497, 915547, 915558, 915635, 915663, 915747, 916054, CNT800CH, FAST-60, FAST-73, NG281, NG281CDD, NG281HP, NG281HPDD, NG281HZ23, NG281HZ23DD...(Other models you can see in the webshop)		

			
2			
Part No.	518099	Ref. No.	43039
description	flat filter L 625mm W 525mm		
For models:	KLP301, KLP301DDDTEB, LP301, LP301EB, RIVER-298, RV298, RV298HZ, U132E		


			
1			
Part No.	510042	Ref. No.	121047 121076
description	round filters ø 110mm H 50mm		
For models:	11F, 11FD, 11F-DVGW, 11R, 11RD, 67F, 67R, 913363, 913364, 913376, 913377, E.41, E.42, E.41		


			
1			
Part No.	510041	Ref. No.	121016 121055
description	round filters ø 136mm H 75mm		
For models:	21F, 21FD, 21R, 21RD, 25F, 25FD, 25R, 25RD, 30F, 30FD, 30R, 30RD, 31F, 31FD, 31R, 31RD, S621, S623, S624, S626, S631, S633, S634, S636		

			
1			
Part No.	510022	Ref. No.	121052 121081
description	round filters ø 153mm H 120mm		
For models:	050F, 050FP, 10, 22F, 22R, 2312-001, 2312-002, 40F, 440F, 44F, 500F, 500FD, 50-ELECTRONIC, 50F, 50FD, 510F, 510FD, 80, 81, 82, 913297, 913298, 913299, 913300, 913360, 913361, 913391, 913392, 913418, 913546, 913547, 913578, 913611, 913684, 913913, 913914, 913932, 913933, 914167, 914168, 914284, 914318, 914319, 914326, 914331, 914338, 914356, 914398, 914399, 914400...(Other models you can see in the webshop)		


			
1			
Part No.	518192 ¹	Ref. No.	121078
description	round filters ø 60mm H 118mm		
For models:	050F, 050FP, 2312-001, 2312-002, 45, 450, 46, 460, 500F, 500FD, 50F, 50FD, 510F, 510FD, 913297, 913298, 913299, 913300, 913360, 913361, 913391, 913392, 913418, 913546, 913547, 913578, 913611, 913684, 913913, 913914, 913932, 913933, 914167, 914168, 914284, 914318, 914319, 914331, 914338, 914356, 914398, 914399, 914400, 914401, 914402, 914403, 914404, 914405, 914431, 914443...(Other models you can see in the webshop)		


¹for drain pump


			
1			
Part No.	518204	Ref. No.	429065
description	screw connection for filter ø 67mm		
For models:	913289, 913290, 913291, 913292, 913356, 913357, 913372, 913373, 913374, 913375, 913416, 913435, 913544, 913545, 913665, 913666, 913667, 913668, 913685, 913771, 913772, 913773, 913774, 913832, 913837, 913911, 913912, 913948, 913950, 913977, 913984, 913990, 913992, 913993, 914165, 914166, 914206, 914214, 914316, 914317, 914355, 914386, 914387, 914388, 914389, 914390, 914391, 914392, 914393, 914394...(Other models you can see in the webshop)		


			
1			
Part No.	518293	Ref. No.	429068
description	screw connection for filter ø 98mm		
For models:	2312-007, 2312-009-CRP, 914100, 914101, 914339, 914342, 914343, 914624, 914625, 914626, 914627, 914628, 914850, 914851, 914854, 914944, PS-60, RIVER-48, RIVER-50, RIVER-50-CRP, RIVER-50-CRP-SP, River-54, RIVER-54CRP, River-54-CRP-s.p., RIVER-54-CRP-SP, RIVER-61		




			
1			
Part No.	518101	Ref. No.	43044
description	strainer insert H 205mm L 405mm W 160mm		
For models:	KLP301, KLP301DDDTEB, LP301, LP301EB, RIVER-298, RV298, RV298HZ, U132E		


overflow pipes			
			
1			
Part No.	510061	Ref. No.	480019
description	cover ø 60mm H 38mm overflow pipe connection ø 35mm		
For models:	66, S850		


			
1			
Part No.	528919	Ref. No.	456010
description	O-ring EPDM thickness 2.62mm ID ø 20.24mm Qty 1 pcs		
For models:	11F, 11FD, 11R, 11RD, 21F, 21FD, 21R, 21RD, 25F, 25FD, 25R, 25RD, 30F, 30FD, 30R, 30RD, 31F, 31FD, 31R, 31RD, S621, S623, S624, S626, S631, S633, S634, S636, S870		


			
1			
Part No.	510072	Ref. No.	456016
description	O-ring EPDM thickness 3.53mm ID ø 32.93mm Qty 1 pcs		
For models:	050F, 050FP, 10, 11F, 11FD, 11F-DVGW, 11R, 11RD, 21F, 21FD, 21R, 21RD, 22F, 22R, 25F, 25FD, 25R, 25RD, 30F, 30FD, 30R, 30RD, 31F, 31FD, 31R, 31RD, 350F, 350FD, 350R, 350RD, 35-ELECTRONIC, 35F, 35FD, 35R, 35RD, 400F, 400FD, 400R, 400RD, 40-ELECTRONIC, 40F, 40FD, 40R, 40RD, 440F, 44F, 45, 450, 46, 460...(Other models you can see in the webshop)		

			
1			
Part No.	518502 ¹	Ref. No.	142037
description	overflow pipe L 100mm ø 21mm		
For models:	913363, 913364, 913376, 913377, E.41, E.42, E41		

¹for drain pump



			
1			
Part No.	518193	Ref. No.	142052
description	overflow pipe L 148mm ø 36mm		
For models:	050F, 050FP, 2312-001, 2312-002, 913297, 913298, 913299, 913300, 913360, 913361, 913391, 913392, 913418, 913546, 913547, 913578, 913611, 913684, 913913, 913914, 913932, 913933, 914167, 914168, 914284, 914318, 914319, 914331, 914338, 914356, 914398, 914399, 914400, 914401, 914402, 914403, 914404, 914405, 914431, 914443, 914449, 914517, 914545, 914568, 914642, 914688, 914909, 914943, 914979, 915136...(Other models you can see in the webshop)		


			
1			
Part No.	518186	Ref. No.	142038
description	overflow pipe L 153mm ø 24mm		
For models:	350F, 350FD, 350R, 350RD, 35-ELECTRONIC, 35F, 35FD, 35R, 35RD		

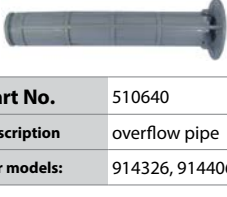

			
1			
Part No.	510023	Ref. No.	142011
description	overflow pipe L 160mm ø 38mm		
For models:	R509, R511, R704, S641, S643, S651, S651P, S653, S654, S655, S830, S835, SR651		


			
1			
Part No.	510038	Ref. No.	142008 142023
description	overflow pipe L 190mm ø 25mm		
For models:	21F, 21FD, 21R, 21RD, 25F, 25FD, 25R, 25RD, 30F, 30FD, 30R, 30RD, 31F, 31FD, 31R, 31RD, S621, S623, S624, S626, S631, S633, S634, S636		
accessories for	510038		
	Part No.	Ref. No.	
	528919	456010	
	 O-ring EPDM thickness 2.62mm ID ø 20.24mm Qty 1 pcs		






			
1			
Part No.	518095	Ref. No.	142058
description	overflow pipe L 205mm ø 36mm		
For models:	915150, 915151, 915152, 915154, 915155, 915160, 915161, 915162, 915166, 915167, 915168, 915175, 915176, 915177, 915319, 915338, 915341, 915348, 915418, 915419, 915420, 915421, 915479, 915492, 915493, 915547, 915558, 915635, 915663, 915747, 916020, 916021, 916024, 916025, 916026, 916027, 916030, 916031, 916045, 916201, 916202, 916203, 916204, 916205, 916206, 916207, 916208, 916209, 916247, 916248...(Other models you can see in the webshop)		
accessories for	518095		
	Part No.	504561	Ref. No. 456073
O-ring EPDM thickness 2.62mm ID ø 29.82mm Qty 1 pcs			

			
1			
Part No.	518291	Ref. No.	142054
description	overflow pipe L 215mm ø 32mm		
For models:	2312-007, 2312-009-CRP, 914100, 914101, 914339, 914342, 914343, 914624, 914625, 914626, 914627, 914850, 914851, 914854, PS-60, RIVER-48, RIVER-50, RIVER-50-CRP, RIVER-54, RIVER-61		

			
1			
Part No.	510640	Ref. No.	142057
description	overflow pipe L 218mm ø 39mm		
For models:	914326, 914406, 915729, E.55, FAST-63		
accessories for	510640		
	Part No.	510072	Ref. No. 456016
O-ring EPDM thickness 3.53mm ID ø 32.93mm Qty 1 pcs			

			
1			
Part No.	517557	Ref. No.	142024 REB142024
description	overflow pipe L 225mm ø 40mm		
For models:	66		

			
1			
Part No.	510020	Ref. No.	142022
description	overflow pipe L 240mm ø 39mm		
For models:	10, 22F, 40F, 440F, 44F, CLEAN-100, CLEAN-110, E.52, E.60, E.65, E1, E10, E100, E110		
accessories for	510020		
	Part No.	510072	Ref. No. 456016
O-ring EPDM thickness 3.53mm ID ø 32.93mm Qty 1 pcs			


			
1			
Part No.	517556	Ref. No.	80354
description	overflow pipe L 285mm ø 36mm		
For models:	Fast181, FAST-181, NG271, NG291, NIAGARA-271, NIAGARA-283, Niagara-283A, NIAGARA-291, ST70FAST, ST70FASTHZ23, SV72AEB, SV72EB		
accessories for	517556		
	Part No.	528155	Ref. No. 927337 CGR4131NT
O-ring Viton thickness 3.53mm ID ø 32.93mm Qty 1 pcs			

			
1			
Part No.	513180	Ref. No.	80249
description	overflow pipe L 287mm ø 38mm		
For models:	80, 81, CE78HZ23, E78, E78HP, FAST-181, Fast181-230V-3Ph-60Hz, Fast181-400V-3NPh-60Hz, HM1, LP60, RIVER-294, RIVER-71, RIVER-78, RIVER-80, River-81, River-81CRP, RIVER-81-CRP, River-82CRP, RIVER-82-CRP, RIVER-E78, RIVER-HL-81, RV294, RV71, RV80, RV8023, RV8023HZ, RV80C, RV80HZ, RV81, RV8123, RV81A, RV81C, RV81CCRP, RV81CRP, RV81HZ, RV81HZ23, RV81PAP, RV82CCRP, RV82CRP, ST70FASTHB, ST70FASTHB400, U60E		
accessories for	513180		
	Part No.	510072	Ref. No. 456016
O-ring EPDM thickness 3.53mm ID ø 32.93mm Qty 1 pcs			




1 

Part No.	513181	Ref. No.	80250
description	overflow pipe L 387mm ø 37mm		
For models:	80, 82, CGL74CABT, KLP105EB, LP105DDDDTEB, LP105DDDDTEBN, LP105EB, NG292, NG292HZ, NG293, NIAGARA-292, Niagara-292-400V-3Ph-60Hz, NIAGARA-293, RIVER-295, River-295P, RIVER-296, River-296P, River-81CRP, RIVER-81-CRP, RIVER-82, River-82CRP, RIVER-82-CRP, RIVER-HL-82, RV295, RV295PS, RV296, RV296PS, RV81CCR, RV81CRP, RV82, RV8223, RV82C, RV82CCR, RV82CRP, SevenL, U61E, U61HE		
accessories for	513181		
	Part No.	510072	Ref. No. 456016
	O-ring EPDM thickness 3.53mm ID ø 32.93mm Qty 1 pcs		

1 


Part No.	517553	Ref. No.	42181
description	overflow pipe L 480mm ø 40mm		
For models:	KLP201DDDDTEB, KLP201EB, KLP301, KLP301DDDDTEB, LP201DDDDTEB, LP201EB, LP301, LP301EB, RIVER-297, RIVER-298, RV297, RV298, RV298HZ, U132E, U70e		

1 

Part No.	510027	Ref. No.	142014
description	overflow pipe L 98mm ø 21mm		
For models:	11F, 11FD, 11F-DVGW, 11R, 11RD, 67F, 67R, 913363, 913364, 913376, 913377, E.41, E.42, E41		

containers

container lids

1 

Part No.	518073	Ref. No.	480023
description	container lid		
For models:	11F, 11FD, 11F-DVGW, 11R, 11RD, 22F, 22R, 40F, 44F, 913992, 913993, CLEAN-3, E.52, RIVER-40, RIVER-43, S651, S654, S810, S815, S830, S835		

1 

Part No.	510109	Ref. No.	480006
description	lid for salt tank		
For models:	11F, 11FD, 11R, 11RD, 21F, 21FD, 21R, 21RD, 2312-007, 2312-009-CRP, 25F, 25FD, 25R, 25RD, 30F, 30FD, 30R, 30RD, 31F, 31FD, 31R, 31RD, 913363, 913364, 913376, 913377, 913992, 913993, 914100, 914101, 914339, 914342, 914343, 914583, 914592, 914612, 914613, 914624, 914625, 914626, 914627, 914628, 914850, 914851, 914854, 914944, 915143, E.41, E.42, E41...(Other models you can see in the webshop)		

1 

Part No.	510110	Ref. No.	429012
description	lid for salt tank		
For models:	11F, 11FD, 11R, 11RD, 21F, 21FD, 2312-007, 2312-009-CRP, 25F, 25FD, 30F, 30FD, 31F, 31FD, 31R, 31RD, 913363, 913364, 913376, 913377, 913992, 913993, 914100, 914101, 914339, 914342, 914343, 914583, 914592, 914612, 914613, 914624, 914625, 914626, 914627, 914628, 914850, 914851, 914854, 914944, 915143, E.41, E.42, E41, R501, R503, R505, R507, R509, R511...(Other models you can see in the webshop)		

dosing containers

1 

Part No.	510019	Ref. No.	114997
description	rinse aid container		
For models:	22F, 22R, 40F, 44F, E.52, S651, S654, S810, S815, S830, S835		
spare parts for	510019		
	Part No.	518073	Ref. No. 480023
	container lid		



salt tanks



1


Part No.	524177	Ref. No.	480005
-----------------	--------	-----------------	--------

description lid ø 69mm H 20mm for salt tank ID ø 50mm

For models: 050F, 050FP, 11F, 11FD, 11R, 11RD, 21F, 21FD, 21R, 21RD, 2312-001, 2312-002, 2312-007, 25F, 25FD, 25R, 25RD, 30F, 30FD, 30R, 30RD, 31F, 31FD, 31R, 31RD, 350F, 350FD, 35-ELECTRONIC, 35R, 35RD, 400F, 400FD, 400R, 400RD, 40-ELECTRONIC, 40F, 40FD, 40R, 40RD, 45, 450, 46, 460, 500F, 500FD, 50-ELECTRONIC, 50F, 50FD, 510F, 510FD...(Other models you can see in the webshop)

accessories for 524177

Part No.	524148	Ref. No.	—
-----------------	--------	-----------------	---

 O-ring EPDM thickness 3.53mm ID ø 40.86mm Qty 1 pcs



1

Part No.	510018	Ref. No.	429011
-----------------	--------	-----------------	--------

description nut ø 92mm H 10.5mm for salt tank ID ø 64mm

For models: 050F, 050FP, 11F, 11FD, 21F, 21FD, 21R, 21RD, 2312-001, 2312-002, 2312-007, 25F, 25FD, 25R, 25RD, 30F, 30FD, 30R, 30RD, 31F, 31FD, 31R, 31RD, 350F, 350FD, 350R, 350RD, 35-ELECTRONIC, 35F, 35FD, 35R, 35RD, 400F, 400FD, 400R, 400RD, 40-ELECTRONIC, 40F, 40FD, 40R, 40RD, 45, 450, 46, 460, 500F, 500FD, 50-ELECTRONIC, 50F, 50FD...(Other models you can see in the webshop)



1


Part No.	510929	Ref. No.	406999
-----------------	--------	-----------------	--------

description salt tank ø 120mm H 117mm hose ø 10mm mounting ø 70mm overall height 157mm

For models: R495, R497, R499, R501, R503, R505, R507, R509, R511, R704, R706, R708, S621, S623, S624, S626, S631, S633, S634, S636, S641, S643, S651, S651P, S653, S654, S655, S810, S815, S830, S835, S850, S870, S950, SR651


spare parts for 510929

Part No.	506015	Ref. No.	456052
-----------------	--------	-----------------	--------


 O-ring EPDM thickness 3.53mm ID ø 39.69mm Qty 1 pcs

spare parts for 510929

Part No.	510018	Ref. No.	429011
-----------------	--------	-----------------	--------


 nut ø 92mm H 10.5mm for salt tank ID ø 64mm

Part No.	524177	Ref. No.	480005
-----------------	--------	-----------------	--------


 lid ø 69mm H 20mm for salt tank ID ø 50mm

accessories for 510929


Part No.	510071	Ref. No.	437034
-----------------	--------	-----------------	--------

 flat gasket rubber ED ø 81mm ID ø 68mm thickness 3mm for salt tank Qty 1 pcs

Part No.	510654	Ref. No.	—
-----------------	--------	-----------------	---

 gasket H 6mm D1 ø 82mm D2 ø 68mm

Part No.	510883	Ref. No.	—
-----------------	--------	-----------------	---

 gasket rubber ED ø 86mm ID ø 66mm thickness 2mm for salt tank Qty 1 pcs



1


Part No.	510032	Ref. No.	406998
-----------------	--------	-----------------	--------

description salt tank without gasket new model


For models: 050F, 050FP, 11F, 11FD, 11R, 11RD, 21F, 21FD, 2312-001, 2312-002, 2312-007, 25F, 25FD, 30F, 30FD, 31F, 31FD, 31R, 31RD, 350F, 350FD, 35-ELECTRONIC, 35F, 35FD, 400F, 400FD, 400R, 400RD, 40-ELECTRONIC, 40F, 40FD, 40R, 40RD, 45, 450, 46, 460, 500F, 500FD, 50-ELECTRONIC, 50F, 50FD, 510F, 510FD, 67F, 67R, 913289, 913290, 913291, 913292...(Other models you can see in the webshop)

spare parts for 510032


Part No.	506015	Ref. No.	456052
-----------------	--------	-----------------	--------

 O-ring EPDM thickness 3.53mm ID ø 39.69mm Qty 1 pcs

Part No.	510018	Ref. No.	429011
-----------------	--------	-----------------	--------

 nut ø 92mm H 10.5mm for salt tank ID ø 64mm

Part No.	510071	Ref. No.	437034
-----------------	--------	-----------------	--------

 flat gasket rubber ED ø 81mm ID ø 68mm thickness 3mm for salt tank Qty 1 pcs

Part No.	524177	Ref. No.	480005
-----------------	--------	-----------------	--------

 lid ø 69mm H 20mm for salt tank ID ø 50mm



accessories



1

Part No.	510071	Ref. No.	437034
description	flat gasket rubber ED ø 81mm ID ø 68mm thickness 3mm for salt tank Qty 1 pcs		
For models:	050F, 050FP, 11F, 11FD, 11R, 11RD, 2312-001, 2312-002, 2312-007, 2312-009-CRP, 31F, 31FD, 31R, 31RD, 350F, 350FD, 35-ELECTRONIC, 35F, 35FD, 400F, 400FD, 400R, 400RD, 40-ELECTRONIC, 40F, 40FD, 40R, 40RD, 45, 450, 46, 460, 500F, 500FD, 50-ELECTRONIC, 50F, 50FD, 510F, 510FD, 67F, 67R, 913289, 913290, 913291, 913292, 913297, 913298, 913299, 913300, 913356...(Other models you can see in the webshop)		



1

Part No.	511457	Ref. No.	799002
description	funnel for salt		

boilers

boilers for dishwashers



1

Part No.	513241	Ref. No.	926026
description	boiler		
For models:	10, CLEAN-100, CLEAN-110, E.60, E1, E10, E100, E110, E140		



1

Part No.	513242	Ref. No.	926055
description	boiler		
For models:	12, 14, CLEAN-120, E.60, E.65, E12, E120, E14, E140		



1

Part No.	513243	Ref. No.	80389
description	boiler		
For models:	80, 81, 82, CE78HZ23, CGL74CABT, E78, E78HP, Fast181, FAST-181, Fast181-230V-3Ph-60Hz, Fast181-400V-3NPh-60Hz, HM1, NG292, NG293, NIAGARA-283, Niagara-283A, NIAGARA-292, NIAGARA-293, RIVER-71, RIVER-78, RIVER-80, River-81, RIVER-82, RIVER-E78, RIVER-HL-81, RIVER-HL-82, RV71, RV80, RV8023, RV8023HZ, RV80C, RV80HZ, RV81, RV8123, RV81A, RV81C, RV81HZ, RV81HZ23, RV81PAP, RV82, RV8223, RV82C, SevenL, ST70FAST, ST70FASTHB, ST70FASTHB400, ST70FASTHZ23, SV72AEB, SV72EB		



1

Part No.	518378	Ref. No.	104030
description	boiler		
For models:	22F, 500F, 500FD, 50F, 50FD, 510F, 510FD, 914326, 914406, E.50, E.51, E.52, E.55, TF-503, TF-513, TF-515		



1

Part No.	518576	Ref. No.	104050
description	boiler		
For models:	913297, 913298, 913299, 913300, 913360, 913361, 913391, 913392, 913546, 913547, 913578, 913611, 913684, 913932, 913933, 914318, 914319, 914331, 914338, 914431, 914517, 914545, 914688, 914979, 915140, 915248, E.50, E.51, F85, F85P, GSP51, GSP51P, LF55, MC501E, MC501EP, Mistral51, MISTRAL-51, NIAGARA-271, NIAGARA-51, PS-60		



1

Part No.	513709	Ref. No.	104056
description	boiler ø 110mm L 295mm		
For models:	913291, 913292, 913357, 913374, 913375, 913416, 913435, 913545, 913666, 913668, 913685, 913773, 913774, 913911, 913912, 913948, 913950, 913977, 913984, 913990, 914165, 914166, 914206, 914214, 914316, 914317, 914355, 914392, 914393, 914394, 914395, 914396, 914397, 914441, 914442, 914515, 914516, 914537, 914543, 914547, 914683, 914684, 914689, 914863, 914874, 915138, 915139, 915527, 915611, 915612...(Other models you can see in the webshop)		










			
1			
Part No.	518377	Ref. No.	104026
description	boiler ø 150mm L 360mm		
For models:	050F, 050FP, 2312-001, 2312-002, 46, 460, 500F, 500FD, 50-ELECTRONIC, 50F, 50FD, 510F, 510FD, 913297, 913298, 913299, 913300, 913360, 913361, 913391, 913392, 913546, 913547, 913578, 913611, 913684, 913932, 913933, 914331, 914517, 914545, 914688, 914979, 915140, 915248, E.46, E.50, E.51, F85, F85P, GSP50, GSP50P, GSP51, GSP51P, LF50, LF55, MC501E, MC501EP, MC501S, MC501SP...(Other models you can see in the webshop)		

			
2			
Part No.	517447	Ref. No.	982019
description	boiler ø 155mm L 405mm inlet ø 11		
For models:	2312-009-CRP, 914628, 914944, RIVER-50-CRP, RIVER-50-CRP-SP, RIVER-54CRP, River-54-CRP-s.p., RIVER-54-CRP-SP		



			
1			
Part No.	518111	Ref. No.	80582
description	boiler ø 190mm L 425mm		


			
1			
Part No.	517455	Ref. No.	41230
description	boiler ø 210mm L 405mm		
For models:	U132E, U70E		

			
1			
Part No.	518588	Ref. No.	104039 999244
description	boiler with heating element 2600W 230V ø 110mm L 295mm		
For models:	E.35, E.40		
spare parts for	518588		
	Part No.	513709	Ref. No. 104056
boiler ø 110mm L 295mm			


			
1			
Part No.	518098	Ref. No.	104043.SO 104044.SO 104906
description	boiler with safety thermostat 2600W 230V ø 110mm L 295mm W 110mm H 115mm connection 11mm hose ø 6mm with thermostat inlet ø 11mm		
For models:	913289, 913290, 913356, 913372, 913373, 913544, 913665, 913667, 913771, 913772, 913832, 913837, 914386, 914387, 914388, 914389, 914390, 914391, 914692, 914693, 914694, 914703, 914870, E.35, E.35-Elettrobar, E.35H, E.35H-Elettrobar, E.40, E.40H, MC201CL, MINIBAR, MISTRAL-40, NIAGARA-35, NIAGARA-40, S280		
spare parts for	518098		
	Part No.	390233	Ref. No. 236039 926189
bi-metal safety thermostat hole distance 24mm switch-off temp. 110°C 1NC 1-pole 16A connection F6.3 2 hole fixing without holder			
	Part No.	390319	Ref. No. 236048
bi-metal thermostat hole distance 23.8mm switch-off temp. 80°C 1NC 1-pole 16A connection F6.3 2 hole fixing			
	Part No.	418642	Ref. No. 230113
heating element 2600W 230V mounting ø 38.5mm heating circuits 1 L 260mm W 33mm H 24mm number of thermostat sleeves 1 thermostat sleeves ø 7mm length thermostat sleeves 175mm thermostat sleeve eccentric, non clinging tube ø 6.5mm hole distance 57mm 3 hole flange connection male faston 6.3mm immersion heater			
	Part No.	521120	Ref. No. 456075
O-ring EPDM thickness 5.34mm ID ø 37.47mm Qty 1 pcs			

accessories

			
1			
Part No.	511459	Ref. No.	468027
description	connecting fitting for boiler		
For models:	S621, S623, S624, S626, S631, S633, S634, S636		
accessories for	511459		
	Part No.	511460	Ref. No. 468003
connecting fitting for boiler			


			
1			
Part No.	511460	Ref. No.	468003
description	connecting fitting for boiler		




			
1			
Part No.	518348	Ref. No.	468117
description	hose connector		
For models:	050F, 050FP, 10, 12, 14, 21F, 21FD, 21R, 21RD, 22F, 22R, 25F, 25FD, 25R, 25RD, 30F, 30FD, 30R, 30RD, 31F, 31FD, 31R, 31RD, 40F, 440F, 44F, 46, 460, 500F, 500FD, 50-ELECTRONIC, 50F, 50FD, 510F, 510FD, 66, CLEAN-100, CLEAN-110, CLEAN-3, E.46, E.50, E.51, E.52, E.60, E.65, E1, E10, E100, E110, E12...(Other models you can see in the webshop)		


rotation plates

rotation plates

			
1			
Part No.	516264	Ref. No.	319003
description	rotation plate ø 350mm grey seat ø 21.7mm		
For models:	350R, 350RD, 35-ELECTRONIC, 35R, 35RD		


rotation plate bearings


			
1			
Part No.	519426	Ref. No.	322006
description	spindle for rotation plate		
For models:	11R, 11RD		

			
1			
Part No.	519427	Ref. No.	322007
description	spindle for rotation plate		
For models:	350R, 350RD, 35-ELECTRONIC, 35R, 35RD, 400R, 400RD, 40-ELECTRONIC, 40R, 40RD, 67R, E.42		

softener cartridges


softening columns


			
1			
Part No.	530000	Ref. No.	117001
description	softener 4-fold L 380mm W 180mm		

			
1			
Part No.	530395	Ref. No.	117007
description	softener 4-fold L 380mm W 180mm		
For models:	915150, 915151, 915152, 915160, 915161, 915162, 915166, 915167, 915168, 915175, 915319, 915348, 915418, 915419, 915420, 915421, 915479, 915483, 915484, 915537, 915538, 915539, 915540, 915547, 915558, 915611, 915612, 915613, 915614, 915615, 915616, 915635, 915663, 915664, 915670, 915671, 915686, 915687, 915688, 915689, 915690, 915691, 915692, 915693, 915694, 915695, 915696, 915697, 915698, 915699...(Other models you can see in the webshop)		

housing and bezels

miscellaneous

			
1			
Part No.	513000	Ref. No.	480057
description	lid rubber ED ø 27mm		
For models:	050F, 050FP, 11F, 11FD, 11R, 11RD, 12, 14, 22F, 22R, 2312-001, 2312-002, 350F, 350FD, 350R, 350RD, 35F, 35FD, 35R, 35RD, 400F, 400FD, 400R, 400RD, 40F, 40FD, 40R, 40RD, 440F, 44F, 500F, 500FD, 50F, 50FD, 510F, 510FD, 913297, 913298, 913299, 913300, 913360, 913361, 913391, 913392, 913418, 913546, 913547, 913578, 913611, 913684...(Other models you can see in the webshop)		

			
1			
Part No.	513708	Ref. No.	480058
description	lid rubber ø 17mm mounting ø 17mm		
For models:	11F, 11FD, 11R, 11RD, 22F, 2312-001, 2312-002, 350F, 350FD, 350R, 350RD, 35F, 35FD, 35R, 35RD, 400F, 400FD, 400R, 400RD, 40F, 40FD, 40R, 40RD, 440F, 44F, 45, 450, 46, 460, 500F, 500FD, 50F, 50FD, 510F, 510FD, 66, 913297, 913298, 913299, 913300, 913360, 913361, 913391, 913392, 913546, 913547, 913578, 913611, 913684, 913913...(Other models you can see in the webshop)		

gearboxes

			
1			
Part No.	699357	Ref. No.	65921
description	gearbox motor shaft ø 14mm flange ø 160mm transmission 1/30 drive shaft ø 25mm type SW 050		



hood mechanics for dishwashers

bolts



1

Part No.	513200	Ref. No.	80131
description	screw bolt hood mechanics		
For models:	80, 81, 82, CGL74CABT, River-80, RIVER-81, River-81CRP, RIVER-81-CRP, RIVER-82, River-82CRP, RIVER-82-CRP, RIVER-HL-81, RIVER-HL-82, RV80, RV8023, RV8023HZ, RV80C, RV80HZ, RV81, RV8123, RV81A, RV81C, RV81CCRP, RV81CRP, RV81HZ, RV81HZ23, RV81PAP, RV82, RV8223, RV82C, RV82CCRP, RV82CRP, SevenL		

springs



1

Part No.	517448	Ref. No.	926108
description	tension spring \varnothing 30mm total length 505mm wire gauge \varnothing 5.5mm for hood mechanics Qty 1 pcs		
For models:	80, 81, 82, CGL74CABT, NG281, NG281CDD, NG281HP, NG281HPDD, NG281HZ23, NG281HZ23DD, NG381, NG38123, NG38123TERMO, NG381C, NG381CDD, NG381CFUR, NG381DDHZ23, NG381DDPS, NG381DDPSHZ23, NG381HPDD, NG381L, NG381LC, NG381LCFUR, NG381LDDPS, NG381TERMO, NG381TXCDD, NIAGARA-281, Niagara-281-2, Niagara-281HP, NIAGARA-283, Niagara-283L-2, Niagara-381, Niagara-381-230V-3Ph-50Hz, Niagara-381-230V-3Ph-60Hz, Niagara-381DP, Niagara-381HPD, Niagara-381L, Niagara-381LC, OC380, OC380FUR, OC380HZ23, Ocean380, RIVER-282, River-282-2, River-282L-2, River-282LS-2TDE, River-282S-2TDE, River-285, River-382, River-382-230V-3Ph-50Hz...(Other models you can see in the webshop)		

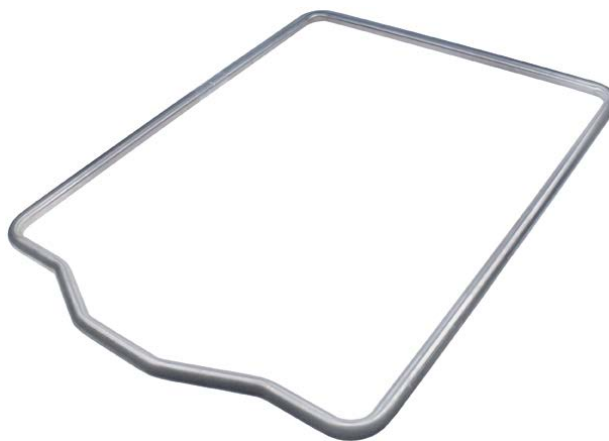
guide bars



1

Part No.	513724	Ref. No.	80068 80069
description	guide bar L 590mm hood mechanics		
For models:	80, 81, 82, CE78HZ23, CGL74CABT, CNT800CH, E78, E78HP, Fast180, Fast180-230V-3Ph-60Hz, Fast181, FAST-181, Fast181-230V-3Ph-60Hz, Fast181-400V-3NPh-60Hz, FAST-60, FAST-73, HM1, NG281, NG281CDD, NG281HP, NG281HPDD, NG281HZ23, NG281HZ23DD, Niagara-281, Niagara-281-2, Niagara-281HP, NIAGARA-283, Niagara-283A, OC380, OC380FUR, OC380HZ23, Ocean380, PLUVIA-280, Pluvia280-230V-3Ph-60Hz, PS-60, PV280, PV280FAST, PV280FAST2, PV280FAST2BIO, PV280FAST2HZ23, PV280FASTCH, PV280FASTHB, PV280HZ23, RIVER-282, River-285, RIVER-78, RIVER-80, RIVER-81, River-81CRP, RIVER-81-CRP...(Other models you can see in the webshop)		

hood handles



1

Part No.	513719	Ref. No.	80027
description	hood handle		
For models:	80, 81, 82, CE78HZ23, CGL74CABT, CNT800CH, E78, E78HP, Fast180, Fast180-230V-3Ph-60Hz, Fast181, FAST-181, Fast181-230V-3Ph-60Hz, Fast181-400V-3NPh-60Hz, FAST-60, FAST-73, HM1, NG281, NG281HP, NG281HPDD, NG281HZ23, NG281HZ23DD, NIAGARA-281, Niagara-281-2, Niagara-281HP, Niagara-283A, OC380, OC380FUR, OC380HZ23, Ocean380, PLUVIA-280, Pluvia280-230V-3Ph-60Hz, PS-60, PV280, PV280FAST, PV280FAST2, PV280FAST2BIO, PV280FAST2HZ23, PV280FASTCH, PV280FASTHB, PV280HZ23, RIVER-78, RIVER-80, River-81, River-81CRP, RIVER-81-CRP, RIVER-82, River-82CRP, RIVER-82-CRP, RIVER-E78...(Other models you can see in the webshop)		

hood handle supports



1

Part No.	513202	Ref. No.	80190
description	bearing for hood handle plastic		
For models:	80, 81, 82, CE78HZ23, CGL74CABT, CNT800CH, E78, E78HP, Fast180, Fast180-230V-3Ph-60Hz, Fast181, FAST-181, Fast181-230V-3Ph-60Hz, Fast181-400V-3NPh-60Hz, FAST-60, FAST-73, HM1, NG281, NG281CDD, NG281HP, NG281HPDD, NG281HZ23, NG281HZ23DD, Niagara-281, Niagara-281-2, Niagara-281HP, NIAGARA-283, Niagara-283A, OC380, OC380FUR, OC380HZ23, Ocean380, PLUVIA-280, Pluvia280-230V-3Ph-60Hz, PS-60, PV280, PV280FAST, PV280FAST2, PV280FAST2BIO, PV280FAST2HZ23, PV280FASTCH, PV280FASTHB, PV280HZ23, RIVER-282, River-285, RIVER-78, RIVER-80, River-81, River-81CRP, RIVER-81-CRP...(Other models you can see in the webshop)		





1


Part No.	513116	Ref. No.	DWD2X
description	connecting piece hood mechanics		




rollers


			
1			
Part No.	510067	Ref. No.	999073
description	roller		


			
1			
Part No.	518539	Ref. No.	926006
description	roller hood mechanics complete		
For models:	10, CLEAN-100, CLEAN-110, CLEAN-120, E1, E10, E100, E110, E12, E120, E14, E140		


			
1			
Part No.	513201	Ref. No.	80132
description	roller ø 36/42mm H 34mm hood mechanics plastic grey hole ø 12mm		
For models:	CGL74CABT, SevenL		

miscellaneous

			
1			
Part No.	513198	Ref. No.	80130
description	base for roller ED ø 64mm ID ø 8.5mm hood mechanics grey		
For models:	CGL74CABT, SevenL		


			
1			
Part No.	508375	Ref. No.	80105
description	fixing support		
For models:	80, 81, 82, CE78HZ23, CGL74CABT, CNT800CH, E78, E78HP, Fast180, Fast180-230V-3Ph-60Hz, Fast181, FAST-181, Fast181-230V-3Ph-60Hz, Fast181-400V-3NPh-60Hz, FAST-60, FAST-73, HM1, LP60, NG271, NG281, NG281CDD, NG281HP, NG281HPDD, NG281HZ23, NG281HZ23DD, NG291, NIAGARA-271, NIAGARA-281, Niagara-281-2, Niagara-281HP, NIAGARA-283, Niagara-283A, NIAGARA-291, OC380, OC380FUR, OC380HZ23, Ocean380, PLUVIA-280, Pluvia280-230V-3PH-60HZ, PS-60, PV280, PV280FAST, PV280FAST2, PV280FAST2BIO, PV280FAST2HZ23, PV280FASTCH, PV280FASTHB, PV280HZ23, RIVER-282, River-285...(Other models you can see in the webshop)		

			
1			
Part No.	513274	Ref. No.	80998
description	hexagonal screw thread M4 plastic WS 7 thread L 6mm		
For models:	80, 81, 82, CE78HZ23, CGL74CABT, CNT800CH, E78, E78HP, Fast180, Fast180-230V-3Ph-60Hz, Fast181, FAST-181, Fast181-230V-3Ph-60Hz, Fast181-400V-3NPh-60Hz, FAST-60, FAST-73, HM1, NG281, NG281CDD, NG281HP, NG281HPDD, NG281HZ23, NG281HZ23DD, Niagara-281, Niagara-281-2, Niagara-281HP, NIAGARA-283, Niagara-283A, OC380, OC380FUR, OC380HZ23, Ocean380, PLUVIA-280, Pluvia280-230V-3PH-60HZ, PS-60, PV280, PV280FAST, PV280FAST2, PV280FAST2BIO, PV280FAST2HZ23, PV280FASTCH, PV280FASTHB, PV280HZ23, RIVER-282, River-285, RIVER-78, RIVER-80, River-81, River-81CRP, RIVER-81-CRP...(Other models you can see in the webshop)		

			
1			
Part No.	518538	Ref. No.	926002
description	opposite support hood mechanics		
For models:	10, 12, 14, CLEAN-100, CLEAN-110, CLEAN-120, E1, E10, E100, E110, E12, E120, E14, E140		


basket guides

basket holders

			
1			
Part No.	699344	Ref. No.	75058
description	roller for basket H 35mm ø 45mm		
For models:	914380, 914436, A3EB, A3EBD, A3EBDAKRKYK, A3EBDAKWK, A3EBDB-KWK, A3EBDRKYK, A3EBDVK, A3EBDYK, A3EBSAK, A3EBSAKRK, A3EBSAKWK, A3EBSBKWKYK, A3EBSEKWK, A3EBSWK, A4EB, A4EBD, A4EBDAKEYK, A4EBDAKRK, A4EBDAKWK, A4EBDAKZK, A4EBDBKRK, A4EBDPKWKYK, A4EBDRK, A4EBS, A4EBSAK, A4EBSAKCK, A4EBSA-KEYK, A4EBSAKRK, A4EBSAKRKP, A4EBSAKYK, A4EBSCK, A4EBT, A4EBTSAK, A5EB, A5EBD, A5EBDAKPKWK, A5EBDAKWK, A5EBDAKYK, A5EBDRK, A5EBS, A5EBSAKPKWK, A5EBSAKRK, A5EBSAKRKYK, A5EBS-AKWK, A5EBSAKWKYK, A5EBSBKRKP, A5EBSBKWK, A5EBSRK...(Other models you can see in the webshop)		


air traps




air traps






			
1			
Part No.	518232	Ref. No.	107006
description	air trap		
For models:	CLEAN-3, RIVER-43		





			
1			
Part No.	518488	Ref. No.	107005
description	air trap		
For models:	2312-001, 2312-002, 350F, 350FD, 350R, 350RD, 35F, 35FD, 35R, 35RD, 40F, 40FD, 40R, 40RD, 67F, 67R, 913289, 913290, 913291, 913292, 913297, 913298, 913299, 913300, 913356, 913357, 913360, 913361, 913363, 913364, 913372, 913373, 913374, 913375, 913376, 913377, 913391, 913392, 913416, 913418, 913435, 913544, 913545, 913546, 913547, 913578, 913611, 913665, 913666, 913667...(Other models you can see in the webshop)		
accessories for	518488		
	Part No.	504618	Ref. No. 456026
	O-ring EPDM thickness 2.62mm ID ø 15.54mm Qty 1 pcs		
	Part No.	510075	Ref. No. 437019
	flat gasket rubber ED ø 22mm ID ø 13mm thickness 1.5mm Qty 1 pcs		
	Part No.	510106	Ref. No. 468029
	hose connector for air trap		

			
1			
Part No.	518641	Ref. No.	984007
description	air trap complete ø 34mm H 70mm hose ø 6mm		
For models:	916020, 916021, 916024, 916025, 916026, 916027, 916030, 916031, 916045, 916247, 916248, 916249, 916250, 916251, 916252, 916382, 916383, 916452, 916504, 916584, 916654, 916670, 916688, 916763, 916921, 916922, 916992, 916993, 917044, 917049, Clean161, Fast145-2, Fast150, Fast160-2, Fast160C, Fast161-2, Ocean360, Ocean360M, Ocean360-UK		


			
1			
Part No.	519499	Ref. No.	107012
description	air trap L 46mm W 35mm H 72mm thread 3/4" hose ø 5.5mm plastic		
For models:	2312-007, 913992, 913993, 914100, 914101, 914339, 914342, 914343, 914583, 914592, 914612, 914613, 914624, 914625, 914626, 914627, 914628, 914850, 914851, 914854, 914944, 915143, Fast181, FAST-181, Fast181-230V-3Ph-60Hz, Fast181-400V-3NPh-60Hz, NG271, NG291, NG292, NG292HZ, NG293, NG381, NG38123, NG38123TERMO, NG381C, NG381CDD, NG381CFUR, NG381DDHZ23, NG381DDPS, NG381DDPSHZ23, NG381HPDD, NG381L, NG381LC, NG381LCFUR, NG381LDDPS, NG381TERMO, NG381TXCDD, NIAGARA-271, NIAGARA-283, Niagara-283A...(Other models you can see in the webshop)		
accessories for	519499		
	Part No.	516261	Ref. No. 437098
	flat gasket rubber ED ø 33mm ID ø 25mm thickness 2.5mm for air trap Qty 1 pcs		
	Part No.	519498	Ref. No. 417120
	nut thread 3/4" H 10mm WS 30 plastic Qty 1 pcs		


			
1			
Part No.	510103	Ref. No.	984001
description	air trap L 85mm W 20mm H 80mm hose ø 6mm plastic		
For models:	050F, 050FP, 11F, 11FD, 11F-DVGW, 11R, 11RD, 21F, 21FD, 21R, 21RD, 22F, 22R, 25F, 25FD, 25R, 25RD, 30F, 30FD, 30R, 30RD, 31F, 31FD, 31R, 31RD, 40F, 440F, 44F, 500F, 500FD, 50-ELECTRONIC, 50F, 50FD, 510F, 510FD, 66, E.52, F85, F85P, S621, S623, S624, S626, S631, S633, S634, S636, S651, S651P, S653...(Other models you can see in the webshop)		
spare parts for	510103		
	Part No.	505045	Ref. No. 456009
	O-ring EPDM thickness 1.78mm ID ø 5.28mm Qty 1 pcs		
	Part No.	505094	Ref. No. —
	air trap		
	Part No.	510016	Ref. No. 486002
	eye bolt for rinse aid container connection		
	Part No.	510105	Ref. No. 468053
	hose connector for air trap		

			
1			
Part No.	510111	Ref. No.	984002
description	air trap ø 34mm H 130mm hose ø 6mm plastic		
For models:	R495, R499, R501, R503, R505, R507, R509, R511, R704, R706, R708, S641, S643, S870, S950		
spare parts for	510111		
	Part No.	504618	Ref. No. 456026
	O-ring EPDM thickness 2.62mm ID ø 15.54mm Qty 1 pcs		
	Part No.	510075	Ref. No. 437019
	flat gasket rubber ED ø 22mm ID ø 13mm thickness 1.5mm Qty 1 pcs		
	Part No.	510106	Ref. No. 468029
	hose connector for air trap		




			
1			
Part No.	518200	Ref. No.	984005
description	air trap ø 34mm H 78mm hose ø 6mm plastic		
For models:	10, 12, 14, 161, 221, 2312-001, 2312-002, 271, 272, 350F, 350FD, 350R, 350RD, 35-ELECTRONIC, 35F, 35FD, 35R, 35RD, 362, 400F, 400FD, 400R, 400RD, 40-ELECTRONIC, 40F, 40FD, 40R, 40RD, 45, 450, 46, 460, 67F, 67R, 80, 81, 82, 913289, 913290, 913291, 913292, 913297, 913298, 913299, 913300, 913356, 913357, 913360, 913361, 913363...(Other models you can see in the webshop)		
spare parts for	518200		
	Part No.	504618	Ref. No. 456026
	O-ring EPDM thickness 2.62mm ID ø 15.54mm Qty 1 pcs		
	Part No.	510075	Ref. No. 437019
	flat gasket rubber ED ø 22mm ID ø 13mm thickness 1.5mm Qty 1 pcs		
	Part No.	510106	Ref. No. 468029
	hose connector for air trap		



			
1			
Part No.	511959	Ref. No.	107014
description	air trap ø 42mm hose ø 6mm plastic		
For models:	915150, 915151, 915152, 915154, 915155, 915160, 915161, 915162, 915166, 915167, 915168, 915175, 915176, 915177, 915319, 915338, 915341, 915348, 915418, 915419, 915420, 915421, 915479, 915492, 915493, 915547, 915558, 915611, 915612, 915613, 915614, 915615, 915616, 915635, 915663, 915670, 915671, 915747, 915959, 916196, 916197, 916198, 916199, 916200, 916201, 916202, 916203, 916204, 916205, 916206...(Other models you can see in the webshop)		


			
1			
Part No.	511993	Ref. No.	107013
description	air trap ø 43mm H 33mm hose ø 6mm plastic		
For models:	915150, 915151, 915152, 915154, 915155, 915157, 915158, 915160, 915161, 915162, 915166, 915167, 915168, 915172, 915173, 915175, 915176, 915177, 915285, 915319, 915338, 915341, 915348, 915418, 915419, 915420, 915421, 915422, 915479, 915492, 915493, 915494, 915495, 915496, 915497, 915547, 915558, 915611, 915612, 915613, 915614, 915615, 915616, 915617, 915618, 915635, 915663, 915670, 915671, 915672...(Other models you can see in the webshop)		

			
1			
Part No.	524810	Ref. No.	144027 144032
description	air trap W 95mm H 150mm hose ø 6/8mm plastic		
For models:	915154, 915155, 915157, 915158, 915172, 915173, 915285, 915422, 915492, 915493, 915494, 915495, 915496, 915497, 915617, 915618, 915672, 915773, 915774, 916045, 916054, 916066, 916067, 916068, 916069, 916077, 916078, 916079, 916080, 916368, 916418, 916419, 916420, 916421, 916422, 916423, 916424, 916594, 916595, 916654, 916686, 916760, Fast160C, Ocean360-UK, River-242, River-242-2, River-242-2T, River-252, River-252-2, River-252-2T...(Other models you can see in the webshop)		

air trap accessories

			
1			
Part No.	510075	Ref. No.	437019
description	flat gasket rubber ED ø 22mm ID ø 13mm thickness 1.5mm Qty 1 pcs		
For models:	10, 12, 14, 22F, 22R, 2312-001, 2312-002, 350F, 350FD, 350R, 350RD, 35-ELECTRONIC, 35F, 35FD, 35R, 35RD, 400F, 400FD, 400R, 400RD, 40-ELECTRONIC, 40F, 40FD, 40R, 40RD, 44F, 45, 450, 46, 460, 67F, 67R, 913289, 913290, 913291, 913292, 913297, 913298, 913299, 913300, 913356, 913357, 913360, 913361, 913363, 913364, 913372, 913373, 913374, 913375...(Other models you can see in the webshop)		

			
1			
Part No.	510105	Ref. No.	468053
description	hose connector for air trap		
For models:	050F, 050FP, 11F, 11FD, 11F-DVGW, 21F, 21FD, 21R, 21RD, 22F, 22R, 25F, 25FD, 25R, 25RD, 30F, 30FD, 30R, 30RD, 31F, 31FD, 31R, 31RD, 40F, 440F, 44F, 500F, 500FD, 50-ELECTRONIC, 50F, 50FD, 510F, 510FD, 66, E.52, F85, F85P, S621, S623, S624, S626, S631, S633, S634, S636, S651, S654, S810, S815, S830...(Other models you can see in the webshop)		
spare parts for	510105		
	Part No.	510017	Ref. No. 468007
	union screw		

			
1			
Part No.	510106	Ref. No.	468029
description	hose connector for air trap		
For models:	10, 12, 14, 22F, 22R, 2312-001, 2312-002, 350F, 350FD, 350R, 350RD, 40-ELECTRONIC, 40F, 40FD, 40R, 40RD, 44F, 913289, 913290, 913291, 913292, 913297, 913298, 913299, 913300, 913356, 913357, 913360, 913361, 913363, 913364, 913372, 913373, 913374, 913375, 913376, 913377, 913391, 913392, 913416, 913418, 913435, 913544, 913545, 913546, 913547, 913578, 913611, 913665, 913666...(Other models you can see in the webshop)		



mechanics for flight type dishwashers



1

Part No.	699351	Ref. No.	75231 K75649
description	cover for eccentrics plastic D1 ø 147mm D2 ø 32.6mm		
For models:	914380, 914436, A3EB, A3EBD, A3EBDAKRKYK, A3EBDAKWK, A3EBDBKWK, A3EBDRKYK, A3EBDWK, A3EBDYK, A3ESAK, A3ESAKRK, A3ESAKWK, A3ESBKWKYK, A3EBSEKWK, A3ESBWK, A4EB, A4EBD, A4EBDAKEYK, A4EBDAKRK, A4EBDAKWK, A4EBDAKZK, A4EBDBKRK, A4EBDPKWYK, A4EBDRK, A4EBS, A4ESAK, A4ESAKCK, A4ESAKKEYK, A4ESAKRK, A4ESAKRKP, A4ESAKYK, A4ESCK, A4EBT, A4EBTSAK, A5EB, A5EBD, A5EBDAKPKWK, A5EBDAKWK, A5EBDAKYK, A5EBDRK, A5EBS, A5ESAKPKWK, A5ESAKRK, A5ESAKRKYK, A5ESAKWK, A5ESAKWKYK, A5ESBKRPK, A5ESBKWK, A5ESRK...(Other models you can see in the webshop)		



1

Part No.	504423	Ref. No.	927048
description	protector L 230mm W 95mm H 16mm hole ø 25x7mm thickness 4mm		
For models:	161, 221, 271, 272, 362, A3EB, A3EBD, A3EBDAKRKYK, A3EBDAKWK, A3EBDBKWK, A3EBDRKYK, A3EBDWK, A3EBDYK, A3ESAK, A3ESAKRK, A3ESAKWK, A3ESBKWKYK, A3EBSEKWK, A3ESBWK, A4EB, A4EBD, A4EBDAKEYK, A4EBDAKRK, A4EBDAKWK, A4EBDAKZK, A4EBDBKRK, A4EBDPKWYK, A4EBDRK, A4EBS, A4ESAK, A4ESAKCK, A4ESAKKEYK, A4ESAKRK, A4ESAKRKP, A4ESAKYK, A4ESCK, A4EBT, A4EBTSAK, A5EB, A5EBD, A5EBDAKPKWK, A5EBDAKWK, A5EBDAKYK, A5EBDRK, A5EBS, A5ESAKPKWK, A5ESAKRK, A5ESAKRKYK, A5ESAKWK, A5ESAKWKYK...(Other models you can see in the webshop)		



1

Part No.	504389	Ref. No.	927092
description	roller for transport system L 30mm ID ø 16mm ED ø 30mm		
For models:	161, 221, 271, 272, 362, CLEAN-160, CLEAN-161, CLEAN-220, CLEAN-221, CLEAN-270, CLEAN-271, CLEAN-272, CLEAN-361, CLEAN-361P, CLEAN-362, CLEAN-471, CLEAN-471P		



1

Part No.	524511	Ref. No.	927082
description	roller for transport system W 20mm ED ø 24.5mm hole ø 8mm		
For models:	161, 221, 271, 272, 362, CLEAN-160, CLEAN-161, CLEAN-220, CLEAN-221, CLEAN-270, CLEAN-271, CLEAN-272, CLEAN-361, CLEAN-361P, CLEAN-362, CLEAN-471, CLEAN-471P		



1

Part No.	505305	Ref. No.	DND29
description	spacer bush for transport system L 28.5mm ø 13.5mm ID ø 8mm		



1

Part No.	504422	Ref. No.	DNS18
description	tappet for dishwasher L 84mm W 29.5mm H 26mm ø 14mm hole ø 9/10mm		



1

Part No.	511994	Ref. No.	927288
description	tappet for dishwasher L 84mm W 30mm H 98mm		



1

Part No.	511996	Ref. No.	927083
description	tappet for dishwasher right L 62mm W 52mm H 19mm hole ø 12mm		
For models:	161, 221, 271, 272, 362, CLEAN-160, CLEAN-161, CLEAN-220, CLEAN-221, CLEAN-270, CLEAN-271, CLEAN-272, CLEAN-361, CLEAN-361P, CLEAN-362, CLEAN-471, CLEAN-471P		

backflow preventers

backflow preventers



1

Part No.	518297	Ref. No.	144011
description	backflow preventer		
For models:	050F, 050FP, 2312-001, 2312-002, 913297, 913298, 913299, 913300, 913360, 913361, 913391, 913392, 913546, 913547, 913578, 913611, 913684, 913913, 913914, 913932, 913933, 913992, 913993, 914284, 914318, 914319, 914331, 914338, 914356, 914400, 914401, 914402, 914403, 914404, 914405, 914431, 914449, 914517, 914545, 914592, 914612, 914613, 914642, 914688, 914909, 914979, 915136, 915137, 915140, 915248...(Other models you can see in the webshop)		



1

Part No.	518486	Ref. No.	144010 144010NT
description	backflow preventer connection 1/2" dishwasher hose ø 12mm		
For models:	161, 221, 2312-007, 271, 272, 31F, 31FD, 31R, 31RD, 362, 80, 81, 82, 913289, 913290, 913291, 913292, 913356, 913357, 913372, 913373, 913374, 913375, 913416, 913418, 913435, 913544, 913545, 913665, 913666, 913667, 913668, 913685, 913771, 913772, 913773, 913774, 913832, 913837, 913911, 913912, 913948, 913950, 913977, 913984, 913990, 914100, 914101, 914165, 914166...(Other models you can see in the webshop)		

2

Part No.	517572	Ref. No.	144992
description	backflow preventer for drain hose ø 31/21mm		
For models:	915611, 915612, 915613, 915614, 915615, 915616, 915617, 915618, 915670, 915671, 915672, 915773, 915774, 915959, 916020, 916021, 916024, 916025, 916026, 916027, 916030, 916031, 916045, 916066, 916077, 916078, 916196, 916197, 916198, 916199, 916200, 916247, 916248, 916249, 916250, 916251, 916252, 916382, 916383, 916409, 916410, 916418, 916419, 916452, 916504, 916584, 916591, 916592, 916593, 916594...(Other models you can see in the webshop)		

accessories

1

Part No.	511997	Ref. No.	476008
description	ball for back flow restrictor ø 8mm plastic		
For models:	913992, 913993, 914583, 914592, 914612, 914613, 914628, 914944, 915143, 915150, 915151, 915152, 915154, 915155, 915157, 915158, 915160, 915161, 915162, 915166, 915167, 915168, 915172, 915173, 915175, 915176, 915177, 915285, 915319, 915338, 915341, 915348, 915418, 915419, 915420, 915421, 915422, 915479, 915492, 915493, 915494, 915495, 915496, 915497, 915547, 915558, 915611, 915612, 915613, 915614...(Other models you can see in the webshop)		

miscellaneous

1

Part No.	513139	Ref. No.	DWP725
description	connecting fitting		

1

Part No.	518241	Ref. No.	480087
description	cover		
For models:	913291, 913292, 913357, 913374, 913375, 913416, 913435, 913545, 913666, 913668, 913685, 913773, 913774, 913911, 913912, 913948, 913950, 913977, 913984, 913990, 913992, 913993, 914214, 914316, 914317, 914392, 914393, 914394, 914395, 914396, 914397, 914441, 914442, 914515, 914516, 914537, 914543, 914547, 914583, 914592, 914612, 914613, 914683, 914684, 914689, 914863, 914874, 915138, 915139, 915143...(Other models you can see in the webshop)		

1

Part No.	511995	Ref. No.	927146
description	water distributor for cold water brass L 170mm W 30mm H 30mm thread 1/2" IT		
For models:	CLEAN-361, CLEAN-361P, CLEAN-471, CLEAN-471P, RIVER-150, RV150		

door mechanics

spring holders

1

Part No.	551324	Ref. No.	307014
description	spring holder H 16mm L 17mm W 20mm		
For models:	915150, 915151, 915152, 915154, 915155, 915157, 915158, 915160, 915161, 915162, 915166, 915167, 915168, 915172, 915173, 915175, 915176, 915177, 915285, 915319, 915338, 915341, 915348, 915418, 915419, 915420, 915421, 915422, 915479, 915492, 915493, 915494, 915495, 915496, 915497, 915547, 915558, 915635, 915663, 915747, 916054, 916067, 916068, 916069, 916079, 916080, 916201, 916202, 916203, 916204...(Other models you can see in the webshop)		

springs

tension springs

1

Part No.	701154	Ref. No.	449059 449063
description	tension spring ø 10.5mm total length 200mm wire gauge ø 1.3mm for door mechanism		
For models:	915160, 915161, 915162, 915166, 915167, 915168, 915172, 915173, 915175, 915176, 915177, 915285, 915319, 915338, 915341, 915348, 915418, 915419, 915420, 915421, 915422, 915479, 915496, 915497, 915547, 915558, 915635, 915663, 915747, 916054, 916068, 916069, 916080, 916205, 916206, 916207, 916208, 916209, 916365, 916366, 916367, 916368, 916414, 916415, 916416, 916417, 916422, 916423, 916424, 916684...(Other models you can see in the webshop)		



Part No.	701227	Ref. No.	449057 H.227855 H.231937
description	tension spring ø 10mm total length 155mm wire gauge ø 1.1mm L1 60mm L2 11mm for door mechanism		
For models:	2312-007, 2312-009-CRP, 914100, 914101, 914339, 914342, 914343, 914624, 914625, 914626, 914627, 914628, 914850, 914851, 914854, 914944, RIVER-48, RIVER-50, RIVER-50-CRP, RIVER-50-CRP-SP, RIVER-54, RIVER-54CRP, RIVER-54-CRP-s.p., RIVER-54-CRP-SP, RIVER-61		

linkage



Part No.	518558	Ref. No.	929016 999229 DAT43
description	door pin complete with threaded shaft tie bar		
For models:	55, E.65		



Part No.	518362	Ref. No.	304024
description	door pin door pin		
For models:	2312-007, 2312-009-CRP, 914100, 914101, 914339, 914342, 914343, 914624, 914625, 914626, 914627, 914628, 914850, 914851, 914854, 914944, RIVER-48, RIVER-50, RIVER-50-CRP, RIVER-50-CRP-SP, RIVER-54, RIVER-54CRP, RIVER-54-CRP-s.p., RIVER-54-CRP-SP, RIVER-61		



Part No.	518355	Ref. No.	304021
description	door pin stop rod		
For models:	050F, 050FP, 2312-001, 2312-002, 45, 450, 46, 460, 500F, 500FD, 50F, 50FD, 510F, 510FD, 913297, 913298, 913299, 913300, 913360, 913361, 913391, 913392, 913418, 913546, 913547, 913578, 913611, 913684, 913913, 913914, 913932, 913933, 914167, 914168, 914284, 914318, 914319, 914326, 914331, 914338, 914356, 914398, 914399, 914400, 914401, 914402, 914403, 914404, 914405, 914406...(Other models you can see in the webshop)		

sliding plates



Part No.	519407	Ref. No.	929210
description	sliding plate dimensions 60x15mm		
accessories for	519407		
	Part No.	Ref. No.	929209
	gasket for sliding plate dimensions 69x16mm		



Part No.	518356	Ref. No.	307003
description	sliding plate sliding plate		
For models:	050F, 050FP, 22F, 22R, 2312-001, 2312-002, 40F, 440F, 44F, 45, 450, 46, 460, 500F, 500FD, 50F, 50FD, 510F, 510FD, 913297, 913298, 913299, 913300, 913360, 913361, 913391, 913392, 913418, 913546, 913547, 913578, 913611, 913684, 913913, 913914, 913932, 913933, 914167, 914168, 914284, 914318, 914319, 914326, 914331, 914338, 914356, 914398, 914399, 914400, 914401...(Other models you can see in the webshop)		



Part No.	518353	Ref. No.	307005
description	stop plastic for door L 60mm W 12.5mm H 10mm		
For models:	400F, 400FD, 400R, 400RD, 40-ELECTRONIC, 40F, 40FD, 40R, 40RD, 67F, 67R, 913291, 913292, 913357, 913374, 913375, 913416, 913435, 913545, 913666, 913668, 913685, 913773, 913774, 913911, 913912, 913948, 913950, 913977, 913984, 913990, 914214, 914316, 914317, 914392, 914393, 914394, 914395, 914396, 914397, 914441, 914442, 914515, 914516, 914537, 914543, 914547, 914683, 914684, 914689...(Other models you can see in the webshop)		

hinges




Part No.	518253	Ref. No.	311001.CR
description	door hinge hinge mounting pos. right		
For models:	31F, 31FD, 31R, 31RD		




Part No.	518301	Ref. No.	311019
description	door hinge mounting pos. left/right		
For models:	913297, 913298, 913299, 913300, 913360, 913361, 913391, 913392, 913418, 913546, 913547, 913578, 913611, 913684, 913913, 913914, 913932, 913933, 914167, 914168, 914284, 914326, 914331, 914356, 914398, 914399, 914400, 914401, 914402, 914403, 914404, 914405, 914406, 914443, 914449, 914517, 914545, 914568, 914642, 914688, 914909, 914943, 914979, 915136, 915137, 915140, 915248, 915483, 915484, 915528...(Other models you can see in the webshop)		





			
1			
Part No.	518122	Ref. No.	030157
description	hinge complete for dishwasher L 588mm		
For models:	2312-007, 2312-009-CRP		


			
1			
Part No.	510090	Ref. No.	449036
description	spring door lock spring mounting pos. door lock		
For models:	11F, 11FD, 11F-DVGW, 11R, 11RD, 350F, 350FD, 350R, 350RD, 35-ELECTRONIC, 35F, 35FD, 35R, 35RD, 400F, 400FD, 400R, 400RD, 40-ELECTRONIC, 40F, 40FD, 40R, 40RD, 46, 500F, 500FD, 50-ELECTRONIC, 50F, 50FD, 510F, 510FD, 67F, 67R, 913289, 913290, 913291, 913292, 913356, 913357, 913363, 913364, 913372, 913373, 913374, 913375, 913376, 913377, 913416, 913435, 913544...(Other models you can see in the webshop)		


hinge camps			
			
1			
Part No.	518257	Ref. No.	307002 307002.CR
description	hinge camp mounting pos. left		
For models:	21F, 21FD, 21R, 21RD, 25F, 25FD, 25R, 25RD, 30F, 30FD, 30R, 30RD, 31F, 31FD, 31R, 31RD, 440F, 44F, S621, S623, S624, S626, S631, S633, S634, S636, S651, S651P, S653, S654, S655, S810, S815, S830, S835, SR651		


			
1			
Part No.	518262	Ref. No.	311009
description	hinge camp mounting pos. left		
For models:	350F, 350FD, 350R, 350RD, 35-ELECTRONIC, 35F, 35FD, 35R, 35RD, 400F, 400FD, 400R, 400RD, 40-ELECTRONIC, 40F, 40FD, 40R, 40RD, 67F, 67R, 913289, 913290, 913291, 913292, 913356, 913357, 913372, 913373, 913374, 913375, 913416, 913435, 913544, 913545, 913665, 913666, 913667, 913668, 913685, 913771, 913772, 913773, 913774, 913832, 913837, 913911, 913912, 913948, 913950, 913977...(Other models you can see in the webshop)		

			
1			
Part No.	518553	Ref. No.	307008
description	hinge camp mounting pos. left		
For models:	11F, 11FD, 11F-DVGW, 11R, 11RD, 22F, 22R, 40F, 913363, 913364, 913376, 913377, E.41, E.42, E.52, E41		

			
1			
Part No.	518261	Ref. No.	311008
description	hinge camp mounting pos. right		
For models:	67F, 67R, 913289, 913290, 913291, 913292, 913356, 913357, 913372, 913373, 913374, 913375, 913416, 913435, 913544, 913545, 913665, 913666, 913667, 913668, 913685, 913771, 913772, 913773, 913774, 913832, 913837, 913911, 913912, 913948, 913950, 913977, 913984, 913990, 914165, 914166, 914206, 914214, 914316, 914317, 914355, 914386, 914387, 914388, 914389, 914390, 914391, 914392, 914393, 914394...(Other models you can see in the webshop)		

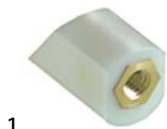
			
1			
Part No.	518552	Ref. No.	307009
description	hinge camp mounting pos. right		
For models:	11F, 11FD, 11F-DVGW, 11R, 11RD, 22F, 22R, 40F, 913363, 913364, 913376, 913377, E.41, E.42, E.52, E41		

hinge pins			
			
1			
Part No.	518555	Ref. No.	325033
description	hinge pin hinge pin		
For models:	11F, 11FD, 11F-DVGW, 11R, 11RD, 22F, 913363, 913364, 913376, 913377, E.41, E.42, E.52, E41		

door frames			
			
1			
Part No.	901694	Ref. No.	41197
description	frame for door mounting pos. upper W 34mm L 595mm SS mounting distance 225mm		
For models:	KLP105EB, LP105DDDTEB, LP105DDDTEBN, LP105EB, NG292, NG293, NIAGARA-292, NIAGARA-293, RIVER-295, RIVER-296, RV295, RV296, U61E, U61HE		



door bumpers



1

Part No.	518066	Ref. No.	417041
description	door bumper end stop		
For models:	050F, 050FP, 22F, 22R, 2312-001, 2312-002, 40F, 440F, 44F, 45, 450, 46, 460, 500F, 500FD, 50F, 50FD, 510F, 510FD, 913297, 913298, 913299, 913300, 913360, 913361, 913391, 913392, 913418, 913546, 913547, 913578, 913611, 913684, 913913, 913914, 913932, 913933, 914167, 914168, 914284, 914318, 914319, 914326, 914331, 914338, 914356, 914398, 914399, 914400, 914401...(Other models you can see in the webshop)		




2

Part No.	518354	Ref. No.	028078
description	door bumper slotted hole disc		
For models:	400F, 400FD, 400R, 400RD, 40-ELECTRONIC, 40F, 40FD, 40R, 40RD, 67F, 67R, 913291, 913292, 913357, 913374, 913375, 913416, 913435, 913545, 913666, 913668, 913685, 913773, 913774, 913911, 913912, 913948, 913950, 913977, 913984, 913990, 914100, 914101, 914214, 914316, 914317, 914392, 914393, 914394, 914395, 914396, 914397, 914441, 914442, 914515, 914516, 914537, 914543, 914547, 914624...(Other models you can see in the webshop)		

door shafts



1

Part No.	518556	Ref. No.	929018
description	door shaft		
For models:	55, E.65		
accessories for	518556		
	Part No.	Ref. No.	929017
	retaining ring E D1 ø 5mm D2 ø 11mm SS DIN 6799 thickness 0.7mm		

locks



1

Part No.	513138	Ref. No.	994012
description	door catch with nut door locking catch		
For models:	2312-001, 2312-002, 500F, 500FD, 50F, 50FD, 510F, 510FD, 913297, 913298, 913299, 913300, 913360, 913361, 913391, 913392, 913418, 913546, 913547, 913578, 913611, 913684, 913913, 913914, 913932, 913933, 914167, 914168, 914284, 914326, 914331, 914356, 914398, 914399, 914400, 914401, 914402, 914403, 914404, 914405, 914406, 914443, 914449, 914517, 914545, 914568, 914642, 914688, 914909, 914943...(Other models you can see in the webshop)		



1

Part No.	519575	Ref. No.	927278
description	snap lock mounting pos. upper L 53mm W 14mm H 14mm thread M12		



1

Part No.	518245	Ref. No.	325030
description	spigot door catch		
For models:	22F, 22R, 2312-001, 2312-002, 40F, 440F, 44F, 45, 450, 46, 460, 500F, 500FD, 50F, 50FD, 510F, 510FD, 913297, 913298, 913299, 913300, 913360, 913361, 913391, 913392, 913418, 913546, 913547, 913578, 913611, 913684, 913913, 913914, 913932, 913933, 914167, 914168, 914284, 914326, 914331, 914356, 914398, 914399, 914400, 914401, 914402, 914403, 914404, 914405, 914406...(Other models you can see in the webshop)		

miscellaneous



1

Part No.	513203	Ref. No.	80277
description	bracket for lever		
For models:	80, 81, 82, CE78HZ23, CGL74CABT, CNT800CH, E78, E78HP, Fast180, Fast180-230V-3Ph-60Hz, Fast181, FAST-181, Fast181-230V-3Ph-60Hz, Fast181-400V-3NPh-60Hz, FAST-60, FAST-73, HM1, NG281, NG281CDD, NG281HP, NG281HPDD, NG281HZ23, NG281HZ23DD, Niagara-281, Niagara-281-2, Niagara-281HP, NIAGARA-283, Niagara-283A, OC380, OC380FUR, OC380HZ23, Ocean380, PLUVIA-280, Pluvia280-230V-3PH-60HZ, PS-60, PV280, PV280FAST, PV280FAST2, PV280FAST2BIO, PV280FAST2HZ23, PV280FASTCH, PV280FASTHB, PV280HZ23, RIVER-282, River-285, RIVER-78, RIVER-80, River-81, River-81CRP, RIVER-81-CRP...(Other models you can see in the webshop)		




1

Part No.	519406	Ref. No.	929209
description	gasket for sliding plate dimensions 69x16mm		




1

Part No.	513204	Ref. No.	80275
description	opposite support for spring \varnothing 28mm L 100mm		
For models:	80, 81, 82, CE78HZ23, CGL74CABT, CNT800CH, E78, E78HP, Fast180, Fast180-230V-3Ph-60Hz, Fast181, FAST-181, Fast181-230V-3Ph-60Hz, Fast181-400V-3NPh-60Hz, FAST-60, FAST-73, HM1, NG281, NG281CDD, NG281HP, NG281HPDD, NG281HZ23, NG281HZ23DD, Niagara-281, Niagara-281-2, Niagara-281HP, NIAGARA-283, Niagara-283A, OC380, OC380FUR, OC380HZ23, Ocean380, PLUVIA-280, Pluvia280-230V-3Ph-60Hz, PS-60, PV280, PV280FAST, PV280FAST2, PV280FAST2BIO, PV280FAST2HZ23, PV280FASTCH, PV280FASTHB, PV280HZ23, RIVER-282, River-285, RIVER-78, RIVER-80, River-81, River-81CRP, RIVER-81-CRP...(Other models you can see in the webshop)		



2

Part No.	698708	Ref. No.	486224
description	screw ED \varnothing 8.5mm ID \varnothing 4.8mm L 12mm thread M5		
For models:	2312-007, 2312-009-CRP, 914100, 914101, 914624, 914625, 914627, 914628, 914850, 914851, 914854, 914944, RIVER-50, RIVER-50-CRP, RIVER-50-CRP-SP, RIVER-54, RIVER-54CRP, River-54-CRP-s.p., RIVER-54-CRP-SP, RIVER-61		

screw connections



1

Part No.	519498	Ref. No.	417120
description	nut thread 3/4" H 10mm WS 30 plastic Qty 1 pcs		
For models:	2312-007, 913992, 913993, 914100, 914101, 914339, 914342, 914343, 914583, 914592, 914612, 914613, 914624, 914625, 914626, 914627, 914628, 914850, 914851, 914854, 914944, 915143, Fast181, FAST-181, Fast181-230V-3Ph-60Hz, Fast181-400V-3NPh-60Hz, NG271, NG291, NG292, NG292HZ, NG293, NG381, NG38123, NG38123TERMO, NG381C, NG381CDD, NG381CFUR, NG381DDHZ23, NG381DDPS, NG381DDPSHZ23, NG381HPDD, NG381L, NG381LC, NG381LCFUR, NG381LDDPS, NG381TERMO, NG381TXCDD, NIAGARA-271, NIAGARA-283, Niagara-283A...(Other models you can see in the webshop)		

curtains



1


Part No.	533008	Ref. No.	75120
description	curtain W 540mm H 405mm plastic thickness 1.3mm		
For models:	914380, 914436, A3EB, A3EBD, A3EBDAKRKYK, A3EBDAKWK, A3EBDBKWK, A3EBDRKYK, A3EBDVK, A3EBDYK, A3EBSAK, A3EBSAKRK, A3EBSAKWK, A3EBSBKWKYK, A3EBSEKWK, A3EBSWK, A4EB, A4EBD, A4EBDAKEKYK, A4EBDAKRK, A4EBDAKWK, A4EBDAKZK, A4EBDBKWK, A4EBDPKWKYK, A4EBDRK, A4EBS, A4EBSAK, A4EBSAKCK, A4EBSAKKEYK, A4EBSAKRK, A4EBSAKRKP, A4EBSAKYK, A4EBSCK, A4EBT, A4EBTSAK, A5EB, A5EBD, A5EBDAKPKWK, A5EBDAKWK, A5EBDAKYK, A5EBDRK, A5EBS, A5EBSAKPKWK, A5EBSAKRK, A5EBSAKRKYK, A5EBSAKWK, A5EBSAKWKYK, A5EBSBKRPK, A5EBSBKWK, A5EBSRK...(Other models you can see in the webshop)		
accessories for	533008		
	Part No.	Ref. No.	75121
	curtain rod L 545mm \varnothing 8mm		

washing and rinsing systems



1





Part No.	513271	Ref. No.	412028
description	connector holder grey		
For models:	2312-001, 2312-002, E.35, E.35H, E.40, E.40H, E.50, E.51, GLS40H, GLS40HP, MC201CL, MISTRAL-40, MISTRAL-51, NIAGARA-35, NIAGARA-40, NIAGARA-51		





1


Part No.	517568	Ref. No.	41064
description	counterflange for wash arm support \varnothing 69mm ID \varnothing 63mm H 35mm mounting distance 64mm hole \varnothing 7mm		
For models:	KLP105EB, KLP201DDTEB, KLP201EB, KLP301, KLP301DDTEB, LP105DDTEB, LP105DDTEBN, LP105EB, LP201DDTEB, LP201EB, LP301, LP301EB, NG292, NG292HZ, NG293, NIAGARA-292, Niagara-292-400V-3Ph-60Hz, NIAGARA-293, RIVER-295, River-295P, RIVER-296, River-296P, RIVER-297, RIVER-298, RV295, RV295PS, RV296, RV296PS, RV297, RV298, RV298HZ, U132E, U61E, U61HE, U70e		
accessories for	517568		
	Part No.	Ref. No.	42053
	extension for rinsing shaft \varnothing 16mm H 122mm thread L 12mm WS 19		
	Part No.	Ref. No.	926252
	O-ring EPDM thickness 3.53mm ID \varnothing 69.85mm Qty 1 pcs		
	Part No.	Ref. No.	41185
	throttle disc \varnothing 71.5mm hole \varnothing 17/22mm		




			
1			
Part No.	517441	Ref. No.	41064CP C.41064CP
description	counterflange for wash arm support with throttle disc ϕ 70mm ID ϕ 63mm L 110mm W 89mm H 35mm		
For models:	KLP105EB, KLP201DDDTEB, KLP201EB, KLP301, KLP301DDDTEB, LP105DDDTEB, LP105DDDTEBN, LP105EB, LP201DDDTEB, LP201EB, LP301, LP301EB, NG292, NG292HZ, NG293, NIAGARA-292, Niagara-292-400V-3Ph-60Hz, NIAGARA-293, RIVER-295, River-295P, RIVER-296, River-296P, RIVER-297, RIVER-298, RV295, RV295PS, RV296, RV296PS, RV297, RV298, RV298HZ, U132, U132E, U61, U61E, U61H, U61HE, U70, U70e		
spare parts for	517441		
	Part No.	698750	Ref. No. 41185
	throttle disc ϕ 71.5mm hole ϕ 17/22mm		
accessories for	517441		
	Part No.	531605	Ref. No. 42053
	extension for rinsing shaft ϕ 16mm H 122mm thread L 12mm WS 19		
	Part No.	532603	Ref. No. 926252
	O-ring EPDM thickness 3.53mm ID ϕ 69.85mm Qty 1 pcs		


			
1			
Part No.	510016	Ref. No.	486002
description	eye bolt for rinse aid container connection		
For models:	050F, 050FP, 11F, 11FD, 11F-DVGW, 11R, 11RD, 21F, 21FD, 21R, 21RD, 22F, 22R, 25F, 25FD, 25R, 25RD, 30F, 30FD, 30R, 30RD, 31F, 31FD, 31R, 31RD, 40F, 440F, 44F, 500F, 500FD, 50-ELECTRONIC, 50F, 50FD, 510F, 510FD, 66, E.52, F85, F85P, S621, S623, S624, S626, S631, S633, S634, S636, S651, S651P, S653...(Other models you can see in the webshop)		

			
1			
Part No.	507545	Ref. No.	437091
description	flat gasket PTFE ED ϕ 13mm ID ϕ 7mm thickness 0.65mm Qty 1 pcs		
For models:	2312-007, 2312-009-CRP, 913992, 913993, 914100, 914101, 914339, 914342, 914343, 914583, 914592, 914612, 914613, 914624, 914625, 914626, 914627, 914628, 914850, 914851, 914854, 914944, 915143, E.55, RIVER-40, RIVER-40-CRP, RIVER-43, RIVER-44, RIVER-44-CRP, RIVER-44-CRP-ST, RIVER-44CRP-ST, RIVER-48, RIVER-50, RIVER-50-CRP, RIVER-50-CRP-SP, RIVER-54, RIVER-54CRP, River-54-CRP-s.p., RIVER-54-CRP-SP, RIVER-61		


			
1			
Part No.	518240	Ref. No.	437078
description	flat gasket rubber ED ϕ 33mm ID ϕ 17mm thickness 1.5mm Qty 1 pcs		
For models:	2312-009-CRP, 67R, 913289, 913290, 913291, 913292, 913356, 913357, 913363, 913364, 913372, 913373, 913374, 913375, 913376, 913377, 913416, 913435, 913544, 913545, 913665, 913666, 913667, 913668, 913685, 913771, 913772, 913773, 913774, 913832, 913837, 913911, 913912, 913948, 913950, 913977, 913984, 913990, 913992, 913993, 914165, 914166, 914206, 914214, 914316, 914317, 914355, 914386, 914387, 914388...(Other models you can see in the webshop)		

			
1			
Part No.	507541	Ref. No.	437102
description	flat gasket rubber ED ϕ 74mm ID ϕ 57mm thickness 2mm Qty 1 pcs		
For models:	915150, 915151, 915152, 915154, 915155, 915157, 915158, 915160, 915161, 915162, 915166, 915167, 915168, 915172, 915173, 915175, 915176, 915177, 915285, 915319, 915338, 915341, 915348, 915418, 915419, 915420, 915421, 915422, 915479, 915492, 915493, 915494, 915495, 915496, 915497, 915547, 915558, 915617, 915618, 915635, 915663, 915672, 915747, 915773, 915774, 916020, 916021, 916024, 916025, 916026...(Other models you can see in the webshop)		


			
1			
Part No.	518444	Ref. No.	199051 480008
description	flow control valve for wash arm ϕ 16mm H 20mm		
For models:	67R, 913291, 913292, 913357, 913374, 913375, 913416, 913435, 913545, 913666, 913668, 913685, 913773, 913774, 913911, 913912, 913948, 913950, 913977, 913984, 913990, 914214, 914316, 914317, 914392, 914393, 914394, 914395, 914396, 914397, 914441, 914442, 914515, 914516, 914537, 914543, 914547, 914683, 914684, 914689, 914863, 914874, 915138, 915139, 915527, 915692, 915693, 915694, 915816, 916162...(Other models you can see in the webshop)		


			
1			
Part No.	513277	Ref. No.	437080
description	gasket		
For models:	67F, 67R, 913291, 913292, 913357, 913363, 913364, 913374, 913375, 913376, 913377, 913416, 913435, 913545, 913666, 913668, 913685, 913773, 913774, 913911, 913912, 913948, 913950, 913977, 913984, 913990, 914214, 914316, 914317, 914392, 914393, 914394, 914395, 914396, 914397, 914441, 914442, 914515, 914516, 914537, 914543, 914547, 914683, 914689, 914863, 914874, 915138, 915139, 915150, 915151...(Other models you can see in the webshop)		




			
1			
Part No.	518594	Ref. No.	437037
description	gasket for rinse connection		
For models:	21F, 21FD, 21R, 21RD, 25F, 25FD, 25R, 25RD, 30F, 30FD, 30R, 30RD, 31F, 31FD, 31R, 31RD, 45, 450, 913418, 914167, 914168, 914398, 914399, 914443, 914943, 915695, 915696, 915819, E.45, Fast145, FAST-145, Fast145D, FAST-145D, Niagara-45, S621, S623, S624, S626, S631, S633, S634, S636		


			
1			
Part No.	518071	Ref. No.	80178
description	gasket for wash arm support L 109mm W 68mm		
For models:	80, 81, 82, CE78HZ23, CGL74CABT, CNT800CH, E78, E78HP, Fast180, Fast180-230V-3Ph-60Hz, Fast181, FAST-181, Fast181-230V-3Ph-60Hz, Fast181-400V-3NPh-60Hz, FAST-60, FAST-73, HM1, NG281, NG281CDD, NG281HP, NG281HPDD, NG281HZ23, NG281HZ23DD, NG381, NG38123, NG38123TERMO, NG381C, NG381CDD, NG381C-FUR, NG381DDHZ23, NG381DDPS, NG381DDPSHZ23, NG381HPDD, NG381L, NG381LC, NG381LCFUR, NG381LDDPS, NG381TERMO, NG381TXCDD, Niagara-281, Niagara-281-2, Niagara-281HP, NIA-GARA-283, Niagara-283A, Niagara-283L-2, Niagara-381, Niagara-381-230V-3Ph-50Hz, Niagara-381-230V-3Ph-60Hz, Niagara-381DP, Niagara-381HPD...(Other models you can see in the webshop)		


			
1			
Part No.	518595	Ref. No.	111001
description	hose connector double		
For models:	21F, 21FD, 21R, 21RD, 25F, 25FD, 25R, 25RD, 30F, 30FD, 30R, 30RD, 31F, 31FD, 31R, 31RD, 45, 450, 913418, 914167, 914168, 914398, 914399, 914443, 914943, 915695, 915696, 915819, E.45, Fast145, FAST-145, Fast145D, FAST-145D, Niagara-45, S621, S623, S624, S626, S631, S633, S634, S636		

			
1			
Part No.	518286	Ref. No.	472068
description	knurled nut		
For models:	2312-007, 2312-009-CRP, 914100, 914101, 914339, 914342, 914343, 914624, 914625, 914626, 914627, 914628, 914850, 914851, 914854, 914944, E.55, RIVER-48, RIVER-50, RIVER-50-CRP, RIVER-50-CRP-SP, River-54, RIVER-54CRP, River-54-CRP-s.p., RIVER-54-CRP-SP, RIVER-61		

			
1			
Part No.	518665	Ref. No.	454006
description	knurled nut mounting pos. upper/lateral ø 19.65mm H 4mm thread M5		
For models:	913289, 913290, 913291, 913292, 913297, 913298, 913299, 913300, 913356, 913357, 913360, 913361, 913372, 913373, 913374, 913375, 913391, 913392, 913416, 913418, 913435, 913544, 913545, 913546, 913547, 913578, 913611, 913665, 913666, 913667, 913668, 913684, 913685, 913771, 913772, 913773, 913774, 913832, 913837, 913911, 913912, 913913, 913914, 913932, 913933, 913948, 913950, 913977, 913984, 913990...(Other models you can see in the webshop)		

			
1			
Part No.	518238	Ref. No.	143173 143268
description	manifold ø 12mm L 98mm		
For models:	050F, 050FP, 10, 12, 14, 2312-001, 2312-002, 2312-009-CRP, 31F, 31FD, 31R, 31RD, 350F, 350FD, 350R, 350RD, 35-ELECTRONIC, 35F, 35FD, 35R, 35RD, 400F, 400FD, 400R, 400RD, 40-ELECTRONIC, 40F, 40FD, 40R, 40RD, 45, 450, 46, 460, 500F, 500FD, 50-ELECTRONIC, 50F, 50FD, 510F, 510FD, 67F, 67R, 80, 81, 82, 913418, 913992, 913993, 914167...(Other models you can see in the webshop)		

			
1			
Part No.	510104	Ref. No.	991002
description	mixer for rinse aid		
For models:	R499, R501, R503, R505, R507, S641, S643, S950		

			
1			
Part No.	518593	Ref. No.	417039
description	nut for rinse pipe		
For models:	21F, 21FD, 21R, 21RD, 25F, 25FD, 25R, 25RD, 30F, 30FD, 30R, 30RD, 31F, 31FD, 31R, 31RD, 45, 450, 913418, 914167, 914168, 914398, 914399, 914443, 914943, 915695, 915696, 915819, E.45, Fast145, FAST-145, Fast145D, FAST-145D, Niagara-45, S621, S623, S624, S626, S631, S633, S634, S636		

			
1			
Part No.	517454	Ref. No.	308031
description	nut for wash arm ED ø 35mm thickness 11mm plastic		
For models:	2312-007, 914100, 914101, 914339, 914342, 914343, 914568, 914624, 914625, 914626, 914627, 914628, 914850, 914851, 914854, 914944, 915830, E.50D.PA, Fast160DP, FAST-160DP, RIVER-48, RIVER-54, RIVER-54CRP, River-54-CRP-s.p.		

mechanical components, equipment accessories



1

Part No.	518637	Ref. No.	429073
description	nut for wash arm support thread M56x2		
For models:	915150, 915151, 915152, 915154, 915155, 915157, 915158, 915160, 915161, 915162, 915166, 915167, 915168, 915172, 915173, 915175, 915176, 915177, 915285, 915319, 915338, 915341, 915348, 915418, 915419, 915420, 915421, 915422, 915479, 915492, 915493, 915494, 915495, 915496, 915497, 915547, 915558, 915617, 915618, 915635, 915663, 915672, 915747, 915773, 915774, 916020, 916021, 916024, 916025, 916026...(Other models you can see in the webshop)		



1

Part No.	518596	Ref. No.	417038
description	nut wash pipe		
For models:	21F, 21FD, 21R, 21RD, 25F, 25FD, 25R, 25RD, 30F, 30FD, 30R, 30RD, 31F, 31FD, 31R, 31RD, 45, 450, 67F, 67R, 913291, 913292, 913357, 913363, 913364, 913374, 913375, 913376, 913377, 913416, 913418, 913435, 913545, 913666, 913668, 913685, 913773, 913774, 913911, 913912, 913948, 913950, 913977, 913984, 913990, 914167, 914168, 914214, 914316, 914317...(Other models you can see in the webshop)		



1

Part No.	518091	Ref. No.	80181
description	opposite support		
For models:	RIVER-71		



1

Part No.	518089	Ref. No.	80184
description	retaining ring for wash arm ID ø 40mm ED ø 44mm thickness 3mm		
For models:	Fast180, Fast180-230V-3Ph-60Hz, Fast181, FAST-181, Fast181-230V-3Ph-60Hz, Fast181-400V-3NPh-60Hz, LP60, NG291, NG381, NG38123, NG38123TERMO, NG381C, NG381CDD, NG381CFUR, NG381DDHZ23, NG381DDPS, NG381DDPSHZ23, NG381HPDD, NG381L, NG381LC, NG381LCFUR, NG381LDDPS, NG381TERMO, NG381TXCDD, Niagara-281-2, Niagara-283L-2, NIAGARA-291, Niagara-381, Niagara-381-230V-3Ph-50Hz, Niagara-381-230V-3Ph-60Hz, Niagara-381DP, Niagara-381HPD, Niagara-381L, Niagara-381LC, OC380, OC380FUR, OC380HZ23, Ocean380, PS-60, PV280FAST2, PV280FAST2BIO, PV280FAST2HZ23, River-282-2, River-282L-2, River-282LS-2TDE, River-282S-2TDE, River-285, RIVER-294, River-382, River-382-230V-3Ph-50Hz...(Other models you can see in the webshop)		



1

Part No.	698715	Ref. No.	80622
description	ring for wash arm ø 22mm ID ø 11.5mm thickness 1mm		



1

Part No.	513259	Ref. No.	111026
description	rinse arm support mounting pos. upper		
For models:	67F, 67R, 913291, 913292, 913357, 913363, 913364, 913374, 913375, 913376, 913377, 913416, 913435, 913545, 913666, 913668, 913685, 913773, 913774, 913911, 913912, 913948, 913950, 913977, 913984, 913990, 914214, 914316, 914317, 914392, 914393, 914394, 914395, 914396, 914397, 914441, 914442, 914515, 914516, 914537, 914543, 914547, 914683, 914684, 914689, 914863, 914874, 915138, 915139, 915527...(Other models you can see in the webshop)		



1

Part No.	518434	Ref. No.	429050
description	rinse arm support mounting pos. upper		
For models:	22F, 2312-009-CRP, 350F, 350FD, 350R, 350RD, 35-ELECTRONIC, 35F, 35FD, 35R, 35RD, 400F, 400FD, 400R, 400RD, 40-ELECTRONIC, 40F, 40FD, 40R, 40RD, 67R, 913289, 913290, 913291, 913292, 913356, 913357, 913363, 913364, 913372, 913373, 913374, 913375, 913376, 913377, 913416, 913435, 913544, 913545, 913665, 913666, 913667, 913668, 913771, 913772, 913773, 913774, 913832, 913837, 913911, 913912, 913948, 913950, 913977, 913984, 913990, 914165, 914166, 914206, 914214, 914316, 914317, 914355, 914386, 914387, 914388, 914389, 914390...(Other models you can see in the webshop)		



1


Part No.	518443	Ref. No.	468165
description	rinse arm support mounting pos. upper		
For models:	2312-009-CRP, 67R, 913289, 913290, 913291, 913292, 913356, 913357, 913363, 913364, 913372, 913373, 913374, 913375, 913376, 913377, 913416, 913435, 913544, 913545, 913665, 913666, 913667, 913668, 913685, 913771, 913772, 913773, 913774, 913832, 913837, 913911, 913912, 913948, 913950, 913977, 913984, 913990, 914165, 914166, 914206, 914214, 914316, 914317, 914355, 914386, 914387, 914388, 914389, 914390...(Other models you can see in the webshop)		




1


Part No.	518471	Ref. No.	926065
description	rinse pipe		
For models:	12, 14, CLEAN-120, E12, E120, E14, E140		





 <p>1</p>			
Part No.	518003	Ref. No.	447030 447128
description	screw cap		
For models:	050F, 050FP, 11F, 11FD, 11F-DVGW, 21F, 21FD, 2312-001, 2312-002, 25F, 25FD, 30F, 30FD, 31F, 31FD, 400F, 400FD, 40-ELECTRONIC, 40F, 40FD, 45, 450, 46, 460, 500F, 500FD, 50F, 50FD, 510F, 510FD, 67R, 913363, 913364, 913376, 913377, 914568, 915830, E.41, E.42, E.45, E.46, E.50, E.50D.PA, E.51, E41, F85, F85P, FAST-160DP, GSP50, GSP50P...(Other models you can see in the webshop)		


 <p>1</p>			
Part No.	513127	Ref. No.	80285
description	screw connection		
For models:	Fast181, ST70FASTHZ23		


 <p>1</p>			
Part No.	518288	Ref. No.	429069
description	screw connection		
For models:	2312-007, 2312-009-CRP, 80, 81, 82, 914100, 914101, 914326, 914339, 914342, 914343, 914406, 914624, 914625, 914626, 914627, 914628, 914850, 914851, 914854, 914944, 915150, 915151, 915152, 915154, 915155, 915157, 915158, 915160, 915161, 915162, 915166, 915167, 915168, 915172, 915173, 915175, 915176, 915177, 915285, 915319, 915338, 915341, 915348, 915418, 915419, 915420, 915421, 915422, 915479...(Other models you can see in the webshop)		


 <p>1</p>			
Part No.	510011	Ref. No.	429008
description	screw connection plastic		
For models:	11F, 11FD, 11F-DVGW, 21F, 21FD, 25F, 25FD, 30F, 30FD, 31F, 31FD, 350F, 350FD, 35-ELECTRONIC, 35F, 35FD, 400F, 400FD, 40-ELECTRONIC, 40F, 40FD, 45, 450, 913289, 913290, 913291, 913292, 913356, 913357, 913363, 913364, 913372, 913373, 913374, 913375, 913376, 913377, 913416, 913418, 913435, 913544, 913545, 913665, 913666, 913667, 913668, 913685, 913771, 913772, 913773...(Other models you can see in the webshop)		

 <p>1</p>			
Part No.	518012	Ref. No.	308015
description	slide ring ED ø 65mm ID ø 50mm thickness 1.8mm		
For models:	S651, S654, S810, S815, S830, S835		


 <p>1</p>			
Part No.	517443	Ref. No.	437117 80623
description	slide ring for rinse arm mounting pos. upper/lower PTFE ED ø 22mm ID ø 9.5mm thickness 1mm		
For models:	915160, 915161, 915162, 915175, 915319, 915611, 915612, 915613, 915663, 915670, 915830, 916020, 916021, 916024, 916025, 916026, 916027, 916030, 916031, 916045, 916066, 916067, 916068, 916069, 916077, 916078, 916079, 916080, 916181, 916183, 916184, 916185, 916196, 916197, 916198, 916199, 916200, 916201, 916202, 916203, 916204, 916205, 916206, 916207, 916208, 916209, 916237, 916238, 916239, 916240...(Other models you can see in the webshop)		


 <p>1</p>			
Part No.	510058	Ref. No.	199018
description	throttle disc		
For models:	11F, 11FD, 11F-DVGW, 66, 67R, 913363, 913364, 913376, 913377, E.41, E.42, E41		


 <p>1</p>			
Part No.	513270	Ref. No.	80316
description	throttle disc		
For models:	80, 81, 82, CE78HZ23, CGL74CABT, E78, E78HP, Fast181, FAST-181, Fast181-230V-3Ph-60Hz, Fast181-400V-3NPh-60Hz, HM1, LP60, NG271, NG291, NIAGARA-271, NIAGARA-283, Niagara-283A, NIAGARA-291, RIVER-282, River-285, RIVER-294, RIVER-71, RIVER-78, RIVER-80, River-81, River-81CRP, RIVER-81-CRP, RIVER-82, River-82CRP, RIVER-82-CRP, RIVER-E78, RIVER-HL-81, RIVER-HL-82, RV282, RV282DD, RV282R, RV294, RV71, RV80, RV8023, RV8023HZ, RV80C, RV80HZ, RV81, RV8123, RV81A, RV81C, RV81CCRP, RV81CRP...(Other models you can see in the webshop)		

 <p>1</p>			
Part No.	518015	Ref. No.	199001
description	throttle disc		
For models:	S651, S654, S810, S815, S830, S835		





			
1			
Part No.	518284	Ref. No.	199053
description	throttle disc		
For models:	2312-007, 2312-009-CRP, 914100, 914101, 914339, 914342, 914343, 914624, 914625, 914626, 914627, 914628, 914850, 914851, 914854, 914944, PS-60, RIVER-48, RIVER-50, RIVER-50-CRP, RIVER-50-CRP-SP, RIVER-54, RIVER-54CRP, RIVER-54-CRP-s.p., RIVER-54-CRP-SP, RIVER-61		


			
1			
Part No.	518337	Ref. No.	199039
description	throttle disc		
For models:	46, 460, E.46, GSP50, GSP50P, GSP51, GSP51P, P500, TF-503, TF-513, TF-515		



			
1			
Part No.	518458	Ref. No.	199045
description	throttle disc		
For models:	2312-001, 2312-002, 500F, 500FD, 50F, 50FD, 510F, 510FD, E.50, E.51, E.52, E.60, E.65, E1, E110, LF50, LF55, MC501E, MC501EP, MC501S, MC501SP, MISTRAL-51, NIAGARA-51		


			
1			
Part No.	518459	Ref. No.	199043 3243693
description	throttle disc		
For models:	2312-001, 2312-002, 500F, 500FD, 50F, 50FD, 510F, 510FD, CLEAN-100, CLEAN-110, CLEAN-120, E.50, E.51, E.52, E.60, E.65, E1, E10, E100, E110, E12, E120, E14, E140, LF50, LF55, MC501E, MC501EP, MC501S, MC501SP, MISTRAL-51, NIAGARA-51		

			
1			
Part No.	518032	Ref. No.	199027
description	throttle disc ED ø 34mm ID ø 13.2mm thickness 1mm		
For models:	050F, 050FP, 22F, 40F, 440F, 44F, 500F, 500FD, 50F, 50FD, 510F, 510FD, F85, F85P		


			
1			
Part No.	510112	Ref. No.	454002
description	Thumb screw thread M10 thread L 10mm ø 22mm H 4.5mm SS		
For models:	050F, 050FP, 11F, 11FD, 11F-DVGW, 21F, 21FD, 2312-001, 2312-002, 25F, 25FD, 30F, 30FD, 31F, 31FD, 400F, 400FD, 40-ELECTRONIC, 40F, 40FD, 45, 450, 46, 460, 500F, 500FD, 50F, 50FD, 510F, 510FD, 67R, 913363, 913364, 913376, 913377, 914568, 915830, E.41, E.42, E.45, E.46, E.50, E.50D.PA, E.51, E41, F85, F85P, FAST-160DP, GSP50, GSP50P... (Other models you can see in the webshop)		

			
1			
Part No.	518484	Ref. No.	449045
description	wash arm support for stationary arms mounting pos. upper		
For models:	21F, 21FD, 25F, 25FD, 30F, 30FD, 31F, 31FD, 31R, 31RD, 350R, 350RD, 35-ELECTRONIC, 35R, 35RD, 400F, 400FD, 400R, 400RD, 40-ELECTRONIC, 40F, 40FD, 40R, 40RD, 45, 450, 67R, 913291, 913292, 913357, 913363, 913364, 913374, 913375, 913376, 913377, 913416, 913418, 913435, 913545, 913666, 913668, 913685, 913773, 913774, 913911, 913912, 913948, 913950, 913977... (Other models you can see in the webshop)		

			
1			
Part No.	513714	Ref. No.	80237
description	wash pipe		
For models:	80, 81, 82, CE78HZ23, CGL74CABT, E78, E78HP, Fast181, FAST-181, Fast181-230V-3Ph-60Hz, Fast181-400V-3NPh-60Hz, HM1, NIAGARA-283, Niagara-283A, RIVER-282, RIVER-285, RIVER-78, RIVER-80, RIVER-81, RIVER-81CRP, RIVER-81-CRP, RIVER-82, RIVER-82CRP, RIVER-82-CRP, RIVER-E78, RIVER-HL-81, RIVER-HL-82, RV282, RV282DD, RV282R, RV80, RV8023, RV8023HZ, RV80C, RV80HZ, RV81, RV8123, RV81A, RV81C, RV81CCRP, RV81CRP, RV81HZ, RV81HZ23, RV81PAP, RV82, RV8223, RV82C, RV82CCRP, RV82CRP, SevenL... (Other models you can see in the webshop)		
spare parts for	513714		
		Part No.	518141
		Ref. No.	80179
	wash arm support thread M46x2 ø 44mm ID ø 39mm L 112.5mm W 86mm hole ø 12mm		










			
1			
Part No.	518633	Ref. No.	115128 115139
description	wash pipe		
For models:	2312-007, 2312-009-CRP, 914100, 914101, 914339, 914342, 914343, 914624, 914625, 914626, 914627, 914628, 914850, 914851, 914854, 914944, RIVER-48, RIVER-50, RIVER-50-CRP, RIVER-50-CRP-SP, RIVER-54, RIVER-54CRP, RIVER-54-CRP-s.p., RIVER-54-CRP-SP, RIVER-61		






			
Part No.	519493	Ref. No.	75165
description	wash pipe ø 48mm L 617mm plastic		
For models:	914380, 914436, 915747, A4EB, A4EBD, A4EBDAKEKYK, A4EBDAKRK, A4EBDAKWK, A4EBDAKZK, A4EBDBKRK, A4EBDPKWKYK, A4EBDRK, A4EBS, A4EBSAK, A4EBSAKCK, A4EBSAKEKYK, A4EBSAKRK, A4EBS-AKRKPK, A4EBSAKYK, A4EBSCK, A4EBT, A4EBTSAK, A5EB, A5EBD, A5EBDAKPKWK, A5EBDAKWK, A5EBDAKYK, A5EBDRK, A5EBS, A5EBS-AKPKWK, A5EBSAKRK, A5EBSAKRKYK, A5EBSAKWK, A5EBSAKWKYK, A5EBSBKRKPK, A5EBSBKWK, A5EBSRK, A5EBSYK, Fast200, FAST-200, Fast93, GL280EB, GL280EB23, GL280EB23DAR, GL280EB23HZ, GL280EB23HZDY, GL280EBD, GL280EBDA, GL280EBDAE, GL280EB-DAR...(Other models you can see in the webshop)		


washing and rinsing systems (sorted by produc- er)



ELETTROBAR


			
Part No.	518269	Ref. No.	990061 990108
description	wash and rinse arm wash arm L 495mm rinse arm L 490mm w. jets 9 r. jets 5 mounting ø 16.5mm mounting pos. upper		
For models:	050F, 050FP, 2312-001, 2312-002, 914568, 915830, E.50, E.50D.PA, E.51, F85, F85P, FAST-160DP, GSP50, GSP50P, GSP51, GSP51P, LF50, LF55, MC501E, MC501EP, MC501S, MC501SP, MISTRAL-51, NIAGARA-51, P500, RIVER-E78		
spare parts for	518269		
	Part No.	510010	Ref. No. 129003 129039
	wash arm boss L1 64mm L2 60mm mounting ø 16.5mm		
	Part No.	510139	Ref. No. 140007
	rinse jet		
	Part No.	513262	Ref. No. 499009
	blank nozzle		
	Part No.	518004	Ref. No. 140008
	wash jet		
	Part No.	518053	Ref. No. 429006.TN 429039
	union nut for rinse jet		
	Part No.	518272	Ref. No. 429040
	union nut for wash jet		
	Part No.	518332	Ref. No. 106008
	wash arm mounting pos. right L 220mm mounting ø 24mm nozzles 5		
	Part No.	518333	Ref. No. 106006
	wash arm mounting pos. left L 220mm mounting ø 24mm nozzles 4		

spare parts for	518269		
	Part No.	518334	Ref. No. 106007
	rinse arm mounting pos. right L 220mm mounting ø 13mm nozzles 3		
	Part No.	518335	Ref. No. 106005
	rinse arm mounting pos. left L 220mm mounting ø 13mm nozzles 3		


			
Part No.	518335	Ref. No.	106005
description	rinse arm mounting pos. left L 220mm mounting ø 13mm nozzles 3		
For models:	050F, 050FP, 2312-001, 2312-002, 914568, 915830, E.50, E.50D.PA, E.51, F85, F85P, FAST-160DP, GSP50, GSP50P, GSP51, GSP51P, LF50, LF55, MC501E, MC501EP, MC501S, MC501SP, MISTRAL-51, NIAGARA-51, P500, PS-60, S651, S651P, S653, S654, S655, S830, S835, S850, SR651, TF-503, TF-513, TF-515		

			
Part No.	518334	Ref. No.	106007
description	rinse arm mounting pos. right L 220mm mounting ø 13mm nozzles 3		
For models:	050F, 050FP, 2312-001, 2312-002, 914568, 915830, E.50, E.50D.PA, E.51, F85, F85P, FAST-160DP, GSP50, GSP50P, GSP51, GSP51P, LF50, LF55, MC501E, MC501EP, MC501S, MC501SP, MISTRAL-51, NIAGARA-51, P500, PS-60, S651, S651P, S653, S654, S655, S830, S835, S850, SR651		

			
Part No.	510139	Ref. No.	140007
description	rinse jet		
For models:	050F, 050FP, 10, 11F, 11FD, 11F-DVGW, 11R, 11RD, 12, 21F, 21FD, 21R, 21RD, 22F, 2312-001, 2312-002, 25F, 25FD, 25R, 25RD, 30F, 30FD, 30R, 30RD, 31F, 31FD, 31R, 31RD, 350F, 350FD, 350R, 350RD, 35-ELECTRONIC, 35F, 35FD, 35R, 35RD, 400F, 400FD, 400R, 400RD, 40-ELECTRONIC, 40F, 40FD, 40R, 40RD, 440F, 44F, 45, 450...(Other models you can see in the webshop)		
accessories for	510139		
	Part No.	510130	Ref. No. 429006
	union nut for rinse jet		


			
Part No.	518053	Ref. No.	429006.TN 429039
description	union nut for rinse jet		
For models:	050F, 050FP, 45, 450, 46, 460, 67R, 914684, E.50, E.51, F85, F85P, LF50, LF55, MC501E, MC501EP, MC501S, MC501SP, MISTRAL-51, NIAGARA-51, RIVER-39, TF-503, TF-513, TF-515		




			
1			
Part No.	518272	Ref. No.	429040
description	union nut for wash jet		
For models:	050F, 050FP, 45, 450, 46, 460, 67R, 914684, E.50, E.51, F85, F85P, LF50, LF55, MC501E, MC501EP, MC501S, MC501SP, MISTRAL-51, NIAGARA-51, RIVER-39, TF-503, TF-513, TF-515		

			
1			
Part No.	518333	Ref. No.	106006
description	wash arm mounting pos. left L 220mm mounting ø 24mm nozzles 4		
For models:	050F, 050FP, 2312-001, 2312-002, 914568, 915830, E.50, E.50D.PA, E.51, F85, F85P, FAST-160DP, GSP50, GSP50P, GSP51, GSP51P, LF50, LF55, MC501E, MC501EP, MC501S, MC501SP, MISTRAL-51, NIAGARA-51, P500, PS-60, S651, S651P, S653, S654, S655, S830, S835, S850, SR651, TF-503, TF-513, TF-515		
accessories for	518333		
	Part No.	518004	Ref. No. 140008
			wash jet
	Part No.	518272	Ref. No. 429040
			union nut for wash jet

			
1			
Part No.	518332	Ref. No.	106008
description	wash arm mounting pos. right L 220mm mounting ø 24mm nozzles 5		
For models:	050F, 050FP, 2312-001, 2312-002, 914568, 915830, E.50, E.50D.PA, E.51, F85, F85P, FAST-160DP, GSP50, GSP50P, GSP51, GSP51P, LF50, LF55, MC501E, MC501EP, MC501S, MC501SP, MISTRAL-51, NIAGARA-51, P500, PS-60, S651, S651P, S653, S654, S655, S830, S835, S850, SR651		
accessories for	518332		
	Part No.	518004	Ref. No. 140008
			wash jet
	Part No.	518272	Ref. No. 429040
			union nut for wash jet

			
1			
Part No.	510010	Ref. No.	129003 129039
description	wash arm boss L1 64mm L2 60mm mounting ø 16.5mm		
For models:	050F, 050FP, 11F, 11FD, 11F-DVGW, 21F, 21FD, 2312-001, 2312-002, 25F, 25FD, 30F, 30FD, 31F, 31FD, 400F, 400FD, 40-ELECTRONIC, 40F, 40FD, 45, 450, 46, 460, 500F, 500FD, 50F, 50FD, 510F, 510FD, 67R, 913363, 913364, 913376, 913377, 914568, 915830, E.41, E.42, E.45, E.46, E.50, E.50D.PA, E.51, E.41, F85, F85P, FAST-160DP, GSP50, GSP50P... (Other models you can see in the webshop)		

			
1			
Part No.	518004	Ref. No.	140008
description	wash jet		
For models:	050F, 050FP, 11R, 11RD, 21F, 21FD, 21R, 21RD, 2312-001, 2312-002, 25F, 25FD, 25R, 25RD, 30F, 30FD, 30R, 30RD, 31F, 31FD, 31R, 31RD, 500F, 500FD, 50F, 50FD, 510F, 510FD, 67R, 914568, 915830, E.42, E.50, E.50D.PA, E.51, F85, F85P, FAST-160DP, GSP50, GSP50P, GSP51, GSP51P, LF50, LF55, MC501E, MC501EP, MC501S, MC501SP, MISTRAL-51, NIAGARA-51...(Other models you can see in the webshop)		



















			
1			
Part No.	510119	Ref. No.	990008
description	wash and rinse arm wash arm L 410mm rinse arm L 410mm w. jets 7 r. jets 5 mounting ø 16.5mm mounting pos. lower		
For models:	21F, 21FD, 25F, 25FD, 30F, 30FD, 31F, 31FD, S621, S623, S624, S626, S631, S633, S634, S636		
spare parts for	510119		
	Part No.	510010	Ref. No. 129003 129039
			wash arm boss L1 64mm L2 60mm mounting ø 16.5mm
	Part No.	510130	Ref. No. 429006
			union nut for rinse jet
	Part No.	510131	Ref. No. 429007
			union nut for wash jet
	Part No.	510138	Ref. No. 114013 140013 140020
			wash jet fine groove
	Part No.	510139	Ref. No. 140007
			rinse jet
	Part No.	518004	Ref. No. 140008
			wash jet
	Part No.	518382	Ref. No. 106009
			wash arm mounting pos. right L 175mm mounting ø 24mm nozzles 4
	Part No.	518383	Ref. No. 106010
			rinse arm mounting pos. left L 175mm mounting ø 13mm nozzles 2
	Part No.	518384	Ref. No. 106011
			rinse arm mounting pos. right L 175mm mounting ø 13mm nozzles 3
	Part No.	518631	Ref. No. 106012
			wash arm mounting pos. left L 170mm nozzles mounting ø 24mm
accessories for	510119		
	Part No.	510108	Ref. No. 327006
			rinse arm shaft
	Part No.	510112	Ref. No. 454002
			Thumb screw thread M10 thread L 10mm ø 22mm H 4.5mm SS



Table continues overleaf







accessories for 510119				
	Part No.	518003	Ref. No.	447030 447128
	screw cap			
	Part No.	518008	Ref. No.	437016
	gasket D1 ø 43mm D2 ø 78mm thickness 2mm with 6 holes wash arm support			
	Part No.	518036	Ref. No.	127012
	formed hose angled warewashing			


	1			
Part No.	518383	Ref. No.	106010	
description	rinse arm mounting pos. left L 175mm mounting ø 13mm nozzles 2			
For models:	11F, 11FD, 11F-DVGW, 21F, 21FD, 25F, 25FD, 30F, 30FD, 31F, 31FD, 400F, 400FD, 40-ELECTRONIC, 40F, 40FD, 913363, 913364, 913376, 913377, E.41, E.42, E.46, E.41, S621, S623, S624, S626, S631, S633, S634, S636			


	1			
Part No.	518384	Ref. No.	106011	
description	rinse arm mounting pos. right L 175mm mounting ø 13mm nozzles 3			
For models:	11F, 11FD, 11F-DVGW, 21F, 21FD, 25F, 25FD, 30F, 30FD, 31F, 31FD, 400F, 400FD, 40-ELECTRONIC, 40F, 40FD, 913363, 913364, 913376, 913377, E.41, E.42, E.46, E.41, S621, S623, S624, S626, S631, S633, S634, S636			


	1			
Part No.	510139	Ref. No.	140007	
description	rinse jet			
For models:	050F, 050FP, 10, 11F, 11FD, 11F-DVGW, 11R, 11RD, 12, 21F, 21FD, 21R, 21RD, 22F, 2312-001, 2312-002, 25F, 25FD, 25R, 25RD, 30F, 30FD, 30R, 30RD, 31F, 31FD, 31R, 31RD, 350F, 350FD, 350R, 350RD, 35-ELECTRONIC, 35F, 35FD, 35R, 35RD, 400F, 400FD, 400R, 400RD, 40-ELECTRONIC, 40F, 40FD, 40R, 40RD, 440F, 44F, 45, 450...(Other models you can see in the webshop)			
accessories for 510139				
	Part No.	510130	Ref. No.	429006
	union nut for rinse jet			

	1			
Part No.	510130	Ref. No.	429006	
description	union nut for rinse jet			
For models:	10, 11F, 11FD, 11F-DVGW, 11R, 11RD, 12, 21F, 21FD, 21R, 21RD, 22F, 2312-001, 2312-002, 25F, 25FD, 25R, 25RD, 30F, 30FD, 30R, 30RD, 31F, 31FD, 31R, 31RD, 350F, 350FD, 350R, 350RD, 35-ELECTRONIC, 35F, 35FD, 35R, 35RD, 400F, 400FD, 400R, 400RD, 40-ELECTRONIC, 40F, 40FD, 40R, 40RD, 440F, 44F, 500F, 500FD, 50-ELECTRONIC, 50F...(Other models you can see in the webshop)			
accessories for 510130				
	Part No.	510139	Ref. No.	140007
	rinse jet			

	1			
Part No.	510131	Ref. No.	429007	
description	union nut for wash jet			
For models:	11F, 11FD, 11F-DVGW, 11R, 11RD, 21F, 21FD, 21R, 21RD, 2312-001, 2312-002, 25F, 25FD, 25R, 25RD, 30F, 30FD, 30R, 30RD, 31F, 31FD, 31R, 31RD, 350F, 350FD, 350R, 350RD, 35-ELECTRONIC, 35F, 35FD, 35R, 35RD, 400F, 400FD, 40-ELECTRONIC, 40F, 40FD, 500F, 500FD, 50F, 50FD, 510F, 510FD, 913363, 913364, 913376, 913377, 914568, 915830, E.35...(Other models you can see in the webshop)			
accessories for 510131				
	Part No.	510138	Ref. No.	114013 140013 140020
	wash jet fine groove			

	1			
Part No.	518631	Ref. No.	106012	
description	wash arm mounting pos. left L 170mm nozzles mounting ø 24mm			
For models:	11F, 11FD, 11F-DVGW, 21F, 21FD, 25F, 25FD, 30F, 30FD, 31F, 31FD, 400F, 400FD, 40-ELECTRONIC, 40F, 40FD, 913363, 913364, 913376, 913377, E.41, E.42, E.46, E.41, S621, S623, S624, S626, S631, S633, S634, S636			

	1			
Part No.	518382	Ref. No.	106009	
description	wash arm mounting pos. right L 175mm mounting ø 24mm nozzles 4			
For models:	11F, 11FD, 11F-DVGW, 21F, 21FD, 25F, 25FD, 30F, 30FD, 31F, 31FD, 400F, 400FD, 40-ELECTRONIC, 40F, 40FD, 913363, 913364, 913376, 913377, E.41, E.42, E.45, E.46, E.41, NIAGARA-45, S621, S623, S624, S626, S631, S633, S634, S636			

	1			
Part No.	510010	Ref. No.	129003 129039	
description	wash arm boss L1 64mm L2 60mm mounting ø 16.5mm			
For models:	050F, 050FP, 11F, 11FD, 11F-DVGW, 21F, 21FD, 2312-001, 2312-002, 25F, 25FD, 30F, 30FD, 31F, 31FD, 400F, 400FD, 40-ELECTRONIC, 40F, 40FD, 45, 450, 46, 460, 500F, 500FD, 50F, 50FD, 510F, 510FD, 67R, 913363, 913364, 913376, 913377, 914568, 915830, E.41, E.42, E.45, E.46, E.50, E.50D.PA, E.51, E.41, F85, F85P, FAST-160DP, GSP50, GSP50P...(Other models you can see in the webshop)			




1

Part No.	518004	Ref. No.	140008
description	wash jet		
For models:	050F, 050FP, 11R, 11RD, 21F, 21FD, 21R, 21RD, 2312-001, 2312-002, 25F, 25FD, 25R, 25RD, 30F, 30FD, 30R, 30RD, 31F, 31FD, 31R, 31RD, 500F, 500FD, 50F, 50FD, 510F, 510FD, 67R, 914568, 915830, E.42, E.50, E.50D.PA, E.51, F85, F85P, FAST-160DP, GSP50, GSP50P, GSP51, GSP51P, LF50, LF55, MC501E, MC501EP, MC501S, MC501SP, MISTRAL-51, NIAGARA-51...(Other models you can see in the webshop)		



1


Part No.	510139	Ref. No.	140007
description	rinse jet		
For models:	050F, 050FP, 10, 11F, 11FD, 11F-DVGW, 11R, 11RD, 12, 21F, 21FD, 21R, 21RD, 22F, 2312-001, 2312-002, 25F, 25FD, 25R, 25RD, 30F, 30FD, 30R, 30RD, 31F, 31FD, 31R, 31RD, 350F, 350FD, 350R, 350RD, 35-ELECTRONIC, 35F, 35FD, 35R, 35RD, 400F, 400FD, 400R, 400RD, 40-ELECTRONIC, 40F, 40FD, 40R, 40RD, 440F, 44F, 45, 450...(Other models you can see in the webshop)		


accessories for	510139			
	Part No.	510130	Ref. No.	429006
	union nut for rinse jet			



1

Part No.	518411	Ref. No.	990077
description	wash and rinse arm wash arm L 410mm rinse arm L 415mm w. jets 7 r. jets 5 mounting ø 17/52mm mounting pos. upper		
For models:	46, 460, TF-503, TF-513, TF-515		
spare parts for	518411		


	Part No.	510138	Ref. No.	114013 140013 140020
	wash jet fine groove			

	Part No.	510139	Ref. No.	140007
	rinse jet			

	Part No.	518053	Ref. No.	429006.TN 429039
	union nut for rinse jet			

	Part No.	518272	Ref. No.	429040
	union nut for wash jet			

accessories for	518411			
	Part No.	510112	Ref. No.	454002
	Thumb screw thread M10 thread L 10mm ø 22mm H 4.5mm SS			

	Part No.	518003	Ref. No.	447030 447128
	screw cap			



1

Part No.	518053	Ref. No.	429006.TN 429039
description	union nut for rinse jet		
For models:	050F, 050FP, 45, 450, 46, 460, 67R, 914684, E.50, E.51, F85, F85P, LF50, LF55, MC501E, MC501EP, MC501S, MC501SP, MISTRAL-51, NIAGARA-51, RIVER-39, TF-503, TF-513, TF-515		



1

Part No.	518272	Ref. No.	429040
description	union nut for wash jet		
For models:	050F, 050FP, 45, 450, 46, 460, 67R, 914684, E.50, E.51, F85, F85P, LF50, LF55, MC501E, MC501EP, MC501S, MC501SP, MISTRAL-51, NIAGARA-51, RIVER-39, TF-503, TF-513, TF-515		



1

Part No.	518413	Ref. No.	106091
description	wash arm mounting pos. left mounting ø 24mm nozzles 3		
For models:	46, 460		



1


Part No.	518412	Ref. No.	106090
description	wash arm mounting pos. right mounting ø 24mm nozzles 4		
For models:	46, 460		





1



Part No.	518415	Ref. No.	106047
description	rinse arm mounting pos. left mounting ø 19mm nozzles 2		
For models:	46, 460, TF-503, TF-513, TF-515		






			
1			
Part No.	510010	Ref. No.	129003 129039
description	wash arm boss L1 64mm L2 60mm mounting ø 16.5mm		
For models:	050F, 050FP, 11F, 11FD, 11F-DVGW, 21F, 21FD, 2312-001, 2312-002, 25F, 25FD, 30F, 30FD, 31F, 31FD, 400F, 400FD, 40-ELECTRONIC, 40F, 40FD, 45, 450, 46, 460, 500F, 500FD, 50F, 50FD, 510F, 510FD, 67R, 913363, 913364, 913376, 913377, 914568, 915830, E.41, E.42, E.45, E.46, E.50, E.50D.PA, E.51, E.41, F.85, F.85P, FAST-160DP, GSP50, GSP50P... (Other models you can see in the webshop)		



			
2			
Part No.	510138	Ref. No.	114013 140013 140020
description	wash jet fine groove		
For models:	11F, 11FD, 11F-DVGW, 350F, 350FD, 350R, 350RD, 35-ELECTRONIC, 35F, 35FD, 35R, 35RD, 400F, 400FD, 40-ELECTRONIC, 40F, 40FD, 45, 450, 46, 460, 67R, 913363, 913364, 913376, 913377, E.35, E.35H, E.40, E.40H, E.41, E.42, E.45, E.46, E.41, GLS40H, GLS40HP, GSP50, GSP50P, GSP51, GSP51P, MC201CL, MISTRAL-40, NIAGARA-35, NIAGARA-40, NIAGARA-45, P500, PS-60, TF-503, TF-513...(Other models you can see in the webshop)		
accessories for	510138		
	Part No.	510131	Ref. No.
			429007
	 union nut for wash jet		



			
1			
Part No.	518449	Ref. No.	990078 990097
description	wash and rinse arm wash arm L 435mm rinse arm L 445mm w. jets 8 r. jets 5 mounting ø 16.5mm mounting pos. lower		
For models:	45, 450, 46, 460, E.45, E.46, NIAGARA-45		
spare parts for	518449		
	Part No.	510010	Ref. No.
			129003 129039
	wash arm boss L1 64mm L2 60mm mounting ø 16.5mm		
	Part No.	510130	Ref. No.
			429006
	 union nut for rinse jet		
	Part No.	510131	Ref. No.
			429007
	 union nut for wash jet		
	Part No.	510138	Ref. No.
			114013 140013 140020
	wash jet fine groove		
	Part No.	510139	Ref. No.
			140007
	 rinse jet		
	Part No.	513262	Ref. No.
			499009
	 blank nozzle		

spare parts for	518449		
	Part No.	518382	Ref. No.
			106009
	 wash arm mounting pos. right L 175mm mounting ø 24mm nozzles 4		
	Part No.	518451	Ref. No.
			106107
	 rinse arm mounting pos. right L 200mm mounting ø 13mm nozzles 3		


			
1			
Part No.	518451	Ref. No.	106107
description	rinse arm mounting pos. right L 200mm mounting ø 13mm nozzles 3		
For models:	E.45, E.46, NIAGARA-45		


			
1			
Part No.	510139	Ref. No.	140007
description	rinse jet		
For models:	050F, 050FP, 10, 11F, 11FD, 11F-DVGW, 11R, 11RD, 12, 21F, 21FD, 21R, 21RD, 22F, 2312-001, 2312-002, 25F, 25FD, 25R, 25RD, 30F, 30FD, 30R, 30RD, 31F, 31FD, 31R, 31RD, 350F, 350FD, 350R, 350RD, 35-ELECTRONIC, 35F, 35FD, 35R, 35RD, 400F, 400FD, 400R, 400RD, 40-ELECTRONIC, 40F, 40FD, 40R, 40RD, 440F, 44F, 45, 450...(Other models you can see in the webshop)		
accessories for	510139		
	Part No.	510130	Ref. No.
			429006
	 union nut for rinse jet		



			
1			
Part No.	510130	Ref. No.	429006
description	union nut for rinse jet		
For models:	10, 11F, 11FD, 11F-DVGW, 11R, 11RD, 12, 21F, 21FD, 21R, 21RD, 22F, 2312-001, 2312-002, 25F, 25FD, 25R, 25RD, 30F, 30FD, 30R, 30RD, 31F, 31FD, 31R, 31RD, 350F, 350FD, 350R, 350RD, 35-ELECTRONIC, 35F, 35FD, 35R, 35RD, 400F, 400FD, 400R, 400RD, 40-ELECTRONIC, 40F, 40FD, 40R, 40RD, 440F, 44F, 500F, 500FD, 50-ELECTRONIC, 50F...(Other models you can see in the webshop)		
accessories for	510130		
	Part No.	510139	Ref. No.
			140007
	 rinse jet		



			
1			
Part No.	510131	Ref. No.	429007
description	union nut for wash jet		
For models:	11F, 11FD, 11F-DVGW, 11R, 11RD, 21F, 21FD, 21R, 21RD, 2312-001, 2312-002, 25F, 25FD, 25R, 25RD, 30F, 30FD, 30R, 30RD, 31F, 31FD, 31R, 31RD, 350F, 350FD, 350R, 350RD, 35-ELECTRONIC, 35F, 35FD, 35R, 35RD, 400F, 400FD, 40-ELECTRONIC, 40F, 40FD, 500F, 500FD, 50F, 50FD, 510F, 510FD, 913363, 913364, 913376, 913377, 914568, 915830, E.35...(Other models you can see in the webshop)		
accessories for	510131		
	Part No.	510138	Ref. No.
			114013 140013 140020
	 wash jet fine groove		




			
1			
Part No.	518382	Ref. No.	106009
description	wash arm mounting pos. right L 175mm mounting ø 24mm nozzles 4		
For models:	11F, 11FD, 11F-DVGW, 21F, 21FD, 25F, 25FD, 30F, 30FD, 31F, 31FD, 400F, 400FD, 40-ELECTRONIC, 40F, 40FD, 913363, 913364, 913376, 913377, E.41, E.42, E.45, E.46, E41, NIAGARA-45, S621, S623, S624, S626, S631, S633, S634, S636		


			
1			
Part No.	510010	Ref. No.	129003 129039
description	wash arm boss L1 64mm L2 60mm mounting ø 16.5mm		
For models:	050F, 050FP, 11F, 11FD, 11F-DVGW, 21F, 21FD, 2312-001, 2312-002, 25F, 25FD, 30F, 30FD, 31F, 31FD, 400F, 400FD, 40-ELECTRONIC, 40F, 40FD, 45, 450, 46, 460, 500F, 500FD, 50F, 50FD, 510F, 510FD, 67R, 913363, 913364, 913376, 913377, 914568, 915830, E.41, E.42, E.45, E.46, E.50, E.50D.PA, E.51, E41, F85, F85P, FAST-160DP, GSP50, GSP50P... (Other models you can see in the webshop)		



			
1			
Part No.	510138	Ref. No.	114013 140013 140020
description	wash jet fine groove		
For models:	11F, 11FD, 11F-DVGW, 350F, 350FD, 350R, 350RD, 35-ELECTRONIC, 35F, 35FD, 35R, 35RD, 400F, 400FD, 40-ELECTRONIC, 40F, 40FD, 45, 450, 46, 460, 67R, 913363, 913364, 913376, 913377, E.35, E.35H, E.40, E.40H, E.41, E.42, E.45, E.46, E41, GLS40H, GLS40HP, GSP50, GSP50P, GSP51, GSP51P, MC201CL, MISTRAL-40, NIAGARA-35, NIAGARA-40, NIAGARA-45, P500, PS-60, TF-503, TF-513... (Other models you can see in the webshop)		
accessories for	510138		
	Part No.	510131	Ref. No. 429007
			union nut for wash jet

			
1			
Part No.	513711	Ref. No.	990075
description	wash and rinse arm wash arm L 495mm rinse arm L 460mm w. jets 9 r. jets 5 mounting ø 16.5mm mounting pos. lower		
For models:	GSP50, GSP50P, GSP51, GSP51P, P500, TF-503, TF-513, TF-515		
spare parts for	513711		
	Part No.	510010	Ref. No. 129003 129039
			wash arm boss L1 64mm L2 60mm mounting ø 16.5mm
	Part No.	510138	Ref. No. 114013 140013 140020
			wash jet fine groove
	Part No.	510139	Ref. No. 140007
			rinse jet



spare parts for	513711		
	Part No.	513262	Ref. No. 499009
			blank nozzle
	Part No.	518053	Ref. No. 429006.TN 429039
			union nut for rinse jet
	Part No.	518272	Ref. No. 429040
			union nut for wash jet
	Part No.	518332	Ref. No. 106008
			wash arm mounting pos. right L 220mm mounting ø 24mm nozzles 5
	Part No.	518333	Ref. No. 106006
			wash arm mounting pos. left L 220mm mounting ø 24mm nozzles 4
	Part No.	518334	Ref. No. 106007
			rinse arm mounting pos. right L 220mm mounting ø 13mm nozzles 3



			
1			
Part No.	518409	Ref. No.	106094
description	rinse arm mounting pos. left L 190mm mounting ø 19mm nozzles 3		
For models:	45, 450, 46, 460, GSP50, GSP50P, GSP51, GSP51P, NIAGARA-45, P500		

			
1			
Part No.	518334	Ref. No.	106007
description	rinse arm mounting pos. right L 220mm mounting ø 13mm nozzles 3		
For models:	050F, 050FP, 2312-001, 2312-002, 914568, 915830, E.50, E.50D.PA, E.51, F85, F85P, FAST-160DP, GSP50, GSP50P, GSP51, GSP51P, LF50, LF55, MC501E, MC501EP, MC501S, MC501SP, MISTRAL-51, NIAGARA-51, P500, PS-60, S651, S651P, S653, S654, S655, S830, S835, S850, SR651		

			
1			
Part No.	510139	Ref. No.	140007
description	rinse jet		
For models:	050F, 050FP, 10, 11F, 11FD, 11F-DVGW, 11R, 11RD, 12, 21F, 21FD, 21R, 21RD, 22F, 2312-001, 2312-002, 25F, 25FD, 25R, 25RD, 30F, 30FD, 30R, 30RD, 31F, 31FD, 31R, 31RD, 350F, 350FD, 350R, 350RD, 35-ELECTRONIC, 35F, 35FD, 35R, 35RD, 400F, 400FD, 400R, 400RD, 40-ELECTRONIC, 40F, 40FD, 40R, 40RD, 440F, 44F, 45, 450... (Other models you can see in the webshop)		
accessories for	510139		
	Part No.	510130	Ref. No. 429006
			union nut for rinse jet






			
1			
Part No.	510130	Ref. No.	429006
description	union nut for rinse jet		
For models:	10, 11F, 11FD, 11F-DVGW, 11R, 11RD, 12, 21F, 21FD, 21R, 21RD, 22F, 2312-001, 2312-002, 25F, 25FD, 25R, 25RD, 30F, 30FD, 30R, 30RD, 31F, 31FD, 31R, 31RD, 350F, 350FD, 350R, 350RD, 35-ELECTRONIC, 35F, 35FD, 35R, 35RD, 400F, 400FD, 400R, 400RD, 40-ELECTRONIC, 40F, 40FD, 40R, 40RD, 440F, 44F, 500F, 500FD, 50-ELECTRONIC, 50F...(Other models you can see in the webshop)		
accessories for	510130		
			
Part No.	510139	Ref. No.	140007
description	rinse jet		

			
1			
Part No.	510131	Ref. No.	429007
description	union nut for wash jet		
For models:	11F, 11FD, 11F-DVGW, 11R, 11RD, 21F, 21FD, 21R, 21RD, 2312-001, 2312-002, 25F, 25FD, 25R, 25RD, 30F, 30FD, 30R, 30RD, 31F, 31FD, 31R, 31RD, 350F, 350FD, 350R, 350RD, 35-ELECTRONIC, 35F, 35FD, 35R, 35RD, 400F, 400FD, 40-ELECTRONIC, 40F, 40FD, 500F, 500FD, 50F, 50FD, 510F, 510FD, 913363, 913364, 913376, 913377, 914568, 915830, E.35...(Other models you can see in the webshop)		
accessories for	510131		
			
Part No.	510138	Ref. No.	114013 140013 140020
description	wash jet fine groove		


















			
1			
Part No.	518333	Ref. No.	106006
description	wash arm mounting pos. left L 220mm mounting ø 24mm nozzles 4		
For models:	050F, 050FP, 2312-001, 2312-002, 914568, 915830, E.50, E.50D.PA, E.51, F85, F85P, FAST-160DP, GSP50, GSP50P, GSP51, GSP51P, LF50, LF55, MC501E, MC501EP, MC501S, MC501SP, MISTRAL-51, NIAGARA-51, P500, PS-60, S651, S651P, S653, S654, S655, S830, S835, S850, SR651, TF-503, TF-513, TF-515		
accessories for	518333		
			
Part No.	518004	Ref. No.	140008
description	wash jet		
			
Part No.	518272	Ref. No.	429040
description	union nut for wash jet		


			
1			
Part No.	518332	Ref. No.	106008
description	wash arm mounting pos. right L 220mm mounting ø 24mm nozzles 5		
For models:	050F, 050FP, 2312-001, 2312-002, 914568, 915830, E.50, E.50D.PA, E.51, F85, F85P, FAST-160DP, GSP50, GSP50P, GSP51, GSP51P, LF50, LF55, MC501E, MC501EP, MC501S, MC501SP, MISTRAL-51, NIAGARA-51, P500, PS-60, S651, S651P, S653, S654, S655, S830, S835, S850, SR651		
accessories for	518332		
			
Part No.	518004	Ref. No.	140008
description	wash jet		
			
Part No.	518272	Ref. No.	429040
description	union nut for wash jet		


			
1			
Part No.	510010	Ref. No.	129003 129039
description	wash arm boss L1 64mm L2 60mm mounting ø 16.5mm		
For models:	050F, 050FP, 11F, 11FD, 11F-DVGW, 21F, 21FD, 2312-001, 2312-002, 25F, 25FD, 30F, 30FD, 31F, 31FD, 400F, 400FD, 40-ELECTRONIC, 40F, 40FD, 45, 450, 46, 460, 500F, 500FD, 50F, 50FD, 510F, 510FD, 67R, 913363, 913364, 913376, 913377, 914568, 915830, E.41, E.42, E.45, E.46, E.50, E.50D.PA, E.51, E.41, F85, F85P, FAST-160DP, GSP50, GSP50P...(Other models you can see in the webshop)		


			
1			
Part No.	510138	Ref. No.	114013 140013 140020
description	wash jet fine groove		
For models:	11F, 11FD, 11F-DVGW, 350F, 350FD, 350R, 350RD, 35-ELECTRONIC, 35F, 35FD, 35R, 35RD, 400F, 400FD, 40-ELECTRONIC, 40F, 40FD, 45, 450, 46, 460, 67R, 913363, 913364, 913376, 913377, E.35, E.35H, E.40, E.40H, E.41, E.42, E.45, E.46, E.41, GLS40H, GLS40HP, GSP50, GSP50P, GSP51, GSP51P, MC201CL, MISTRAL-40, NIAGARA-35, NIAGARA-40, NIAGARA-45, P500, PS-60, TF-503, TF-513...(Other models you can see in the webshop)		
accessories for	510138		
			
Part No.	510131	Ref. No.	429007
description	union nut for wash jet		







			
1			
Part No.	518001	Ref. No.	990046
description	wash and rinse arm wash arm L 410mm rinse arm L 410mm w. jets 7 r. jets 5 mounting ø 16.5mm mounting pos. lower		
For models:	11F, 11FD, 11F-DVGW, 400F, 400FD, 40-ELECTRONIC, 40F, 40FD, 913363, 913364, 913376, 913377, E.41, E.42, E.46, E41		
spare parts for	518001		
	Part No.	510010	Ref. No. 129003 129039
	wash arm boss L1 64mm L2 60mm mounting ø 16.5mm		
	Part No.	510130	Ref. No. 429006
	union nut for rinse jet		
	Part No.	510131	Ref. No. 429007
	union nut for wash jet		
	Part No.	510138	Ref. No. 114013 140013 140020
	wash jet fine groove		
	Part No.	510139	Ref. No. 140007
	rinse jet		
	Part No.	518382	Ref. No. 106009
	wash arm mounting pos. right L 175mm mounting ø 24mm nozzles 4		
	Part No.	518383	Ref. No. 106010
	rinse arm mounting pos. left L 175mm mounting ø 13mm nozzles 2		
	Part No.	518384	Ref. No. 106011
	rinse arm mounting pos. right L 175mm mounting ø 13mm nozzles 3		
	Part No.	518631	Ref. No. 106012
	wash arm mounting pos. left L 170mm nozzles mounting ø 24mm		
accessories for	518001		
	Part No.	510037	Ref. No. 115035
	wash arm support		
	Part No.	510054	Ref. No. 437046
	gasket D1 ø 65mm D2 ø 35.5mm thickness 2.5mm with 5 holes wash arm support		
	Part No.	510056	Ref. No. 325025
	rinse arm shaft		
	Part No.	510057	Ref. No. 111009
	opposite support for wash arm support mounting pos. lower Mod. 111009 suitable for 11R		
	Part No.	510058	Ref. No. 199018
	throttle disc		
	Part No.	510108	Ref. No. 327006
	rinse arm shaft		
	Part No.	518003	Ref. No. 447030 447128
	screw cap		

accessories for	518001		
	Part No.	518421	Ref. No. 111015
	opposite support for wash arm support mounting pos. lower Mod. 111015		



1			
Part No.	518383	Ref. No.	106010
description	rinse arm mounting pos. left L 175mm mounting ø 13mm nozzles 2		
For models:	11F, 11FD, 11F-DVGW, 21F, 21FD, 25F, 25FD, 30F, 30FD, 31F, 31FD, 400F, 400FD, 40-ELECTRONIC, 40F, 40FD, 913363, 913364, 913376, 913377, E.41, E.42, E.46, E41, S621, S623, S624, S626, S631, S633, S634, S636		



1			
Part No.	518384	Ref. No.	106011
description	rinse arm mounting pos. right L 175mm mounting ø 13mm nozzles 3		
For models:	11F, 11FD, 11F-DVGW, 21F, 21FD, 25F, 25FD, 30F, 30FD, 31F, 31FD, 400F, 400FD, 40-ELECTRONIC, 40F, 40FD, 913363, 913364, 913376, 913377, E.41, E.42, E.46, E41, S621, S623, S624, S626, S631, S633, S634, S636		


1			
Part No.	510139	Ref. No.	140007
description	rinse jet		
For models:	050F, 050FP, 10, 11F, 11FD, 11F-DVGW, 11R, 11RD, 12, 21F, 21FD, 21R, 21RD, 22F, 2312-001, 2312-002, 25F, 25FD, 25R, 25RD, 30F, 30FD, 30R, 30RD, 31F, 31FD, 31R, 31RD, 350F, 350FD, 350R, 350RD, 35-ELECTRONIC, 35F, 35FD, 35R, 35RD, 400F, 400FD, 400R, 400RD, 40-ELECTRONIC, 40F, 40FD, 40R, 40RD, 440F, 44F, 45, 450...(Other models you can see in the webshop)		
accessories for	510139		
	Part No.	510130	Ref. No. 429006
	union nut for rinse jet		


1			
Part No.	510130	Ref. No.	429006
description	union nut for rinse jet		
For models:	10, 11F, 11FD, 11F-DVGW, 11R, 11RD, 12, 21F, 21FD, 21R, 21RD, 22F, 2312-001, 2312-002, 25F, 25FD, 25R, 25RD, 30F, 30FD, 30R, 30RD, 31F, 31FD, 31R, 31RD, 350F, 350FD, 350R, 350RD, 35-ELECTRONIC, 35F, 35FD, 35R, 35RD, 400F, 400FD, 400R, 400RD, 40-ELECTRONIC, 40F, 40FD, 40R, 40RD, 440F, 44F, 500F, 500FD, 50-ELECTRONIC, 50F...(Other models you can see in the webshop)		
accessories for	510130		
	Part No.	510139	Ref. No. 140007
	rinse jet		





			
1			
Part No.	510131	Ref. No.	429007
description	union nut for wash jet		
For models:	11F, 11FD, 11F-DVGW, 11R, 11RD, 21F, 21FD, 21R, 21RD, 2312-001, 2312-002, 25F, 25FD, 25R, 25RD, 30F, 30FD, 30R, 30RD, 31F, 31FD, 31R, 31RD, 350F, 350FD, 350R, 350RD, 35-ELECTRONIC, 35F, 35FD, 35R, 35RD, 400F, 400FD, 40-ELECTRONIC, 40F, 40FD, 500F, 500FD, 50F, 50FD, 510F, 510FD, 913363, 913364, 913376, 913377, 914568, 915830, E.35...(Other models you can see in the webshop)		
accessories for	510131		
		Part No.	510138
		Ref. No.	114013 140013 140020
	wash jet fine groove		


			
1			
Part No.	510138	Ref. No.	114013 140013 140020
description	wash jet fine groove		
For models:	11F, 11FD, 11F-DVGW, 350F, 350FD, 350R, 350RD, 35-ELECTRONIC, 35F, 35FD, 35R, 35RD, 400F, 400FD, 40-ELECTRONIC, 40F, 40FD, 45, 450, 46, 460, 67R, 913363, 913364, 913376, 913377, E.35, E.35H, E.40, E.40H, E.41, E.42, E.45, E.46, E.41, GLS40H, GLS40HP, GSP50, GSP50P, GSP51, GSP51P, MC201CL, MISTRAL-40, NIAGARA-35, NIAGARA-40, NIAGARA-45, P500, PS-60, TF-503, TF-513...(Other models you can see in the webshop)		
accessories for	510138		
		Part No.	510131
		Ref. No.	429007
	union nut for wash jet		



			
1			
Part No.	518631	Ref. No.	106012
description	wash arm mounting pos. left L 170mm nozzles mounting ø 24mm		
For models:	11F, 11FD, 11F-DVGW, 21F, 21FD, 25F, 25FD, 30F, 30FD, 31F, 31FD, 400F, 400FD, 40-ELECTRONIC, 40F, 40FD, 913363, 913364, 913376, 913377, E.41, E.42, E.46, E.41, S621, S623, S624, S626, S631, S633, S634, S636		

			
1			
Part No.	518335	Ref. No.	106005
description	rinse arm mounting pos. left L 220mm mounting ø 13mm nozzles 3		
For models:	050F, 050FP, 2312-001, 2312-002, 914568, 915830, E.50, E.50D.PA, E.51, F85, F85P, FAST-160DP, GSP50, GSP50P, GSP51, GSP51P, LF50, LF55, MC501E, MC501EP, MC501S, MC501SP, MISTRAL-51, NIAGARA-51, P500, PS-60, S651, S651P, S653, S654, S655, S830, S835, S850, SR651, TF-503, TF-513, TF-515		



			
1			
Part No.	518382	Ref. No.	106009
description	wash arm mounting pos. right L 175mm mounting ø 24mm nozzles 4		
For models:	11F, 11FD, 11F-DVGW, 21F, 21FD, 25F, 25FD, 30F, 30FD, 31F, 31FD, 400F, 400FD, 40-ELECTRONIC, 40F, 40FD, 913363, 913364, 913376, 913377, E.41, E.42, E.45, E.46, E.41, NIAGARA-45, S621, S623, S624, S626, S631, S633, S634, S636		



			
1			
Part No.	518334	Ref. No.	106007
description	rinse arm mounting pos. right L 220mm mounting ø 13mm nozzles 3		
For models:	050F, 050FP, 2312-001, 2312-002, 914568, 915830, E.50, E.50D.PA, E.51, F85, F85P, FAST-160DP, GSP50, GSP50P, GSP51, GSP51P, LF50, LF55, MC501E, MC501EP, MC501S, MC501SP, MISTRAL-51, NIAGARA-51, P500, PS-60, S651, S651P, S653, S654, S655, S830, S835, S850, SR651		

			
1			
Part No.	510010	Ref. No.	129003 129039
description	wash arm boss L1 64mm L2 60mm mounting ø 16.5mm		
For models:	050F, 050FP, 11F, 11FD, 11F-DVGW, 21F, 21FD, 2312-001, 2312-002, 25F, 25FD, 30F, 30FD, 31F, 31FD, 400F, 400FD, 40-ELECTRONIC, 40F, 40FD, 45, 450, 46, 460, 500F, 500FD, 50F, 50FD, 510F, 510FD, 67R, 913363, 913364, 913376, 913377, 914568, 915830, E.41, E.42, E.45, E.46, E.50, E.50D.PA, E.51, E.41, F85, F85P, FAST-160DP, GSP50, GSP50P...(Other models you can see in the webshop)		

			
1			
Part No.	510139	Ref. No.	140007
description	rinse jet		
For models:	050F, 050FP, 10, 11F, 11FD, 11F-DVGW, 11R, 11RD, 12, 21F, 21FD, 21R, 21RD, 22F, 2312-001, 2312-002, 25F, 25FD, 25R, 25RD, 30F, 30FD, 30R, 30RD, 31F, 31FD, 31R, 31RD, 350F, 350FD, 350R, 350RD, 35-ELECTRONIC, 35F, 35FD, 35R, 35RD, 400F, 400FD, 400R, 400RD, 40-ELECTRONIC, 40F, 40FD, 40R, 40RD, 440F, 44F, 45, 450...(Other models you can see in the webshop)		
accessories for	510139		
		Part No.	510130
		Ref. No.	429006
	union nut for rinse jet		





			
1			
Part No.	510130	Ref. No.	429006
description	union nut for rinse jet		
For models:	10, 11F, 11FD, 11F-DVGW, 11R, 11RD, 12, 21F, 21FD, 21R, 21RD, 22F, 2312-001, 2312-002, 25F, 25FD, 25R, 25RD, 30F, 30FD, 30R, 30RD, 31F, 31FD, 31R, 31RD, 350F, 350FD, 350R, 350RD, 35-ELECTRONIC, 35F, 35FD, 35R, 35RD, 400F, 400FD, 400R, 400RD, 40-ELECTRONIC, 40F, 40FD, 40R, 40RD, 440F, 44F, 500F, 500FD, 50-ELECTRONIC, 50F...(Other models you can see in the webshop)		
accessories for	510130		
	Part No.	510139	Ref. No. 140007
	rinse jet		

			
1			
Part No.	510131	Ref. No.	429007
description	union nut for wash jet		
For models:	11F, 11FD, 11F-DVGW, 11R, 11RD, 21F, 21FD, 21R, 21RD, 2312-001, 2312-002, 25F, 25FD, 25R, 25RD, 30F, 30FD, 30R, 30RD, 31F, 31FD, 31R, 31RD, 350F, 350FD, 350R, 350RD, 35-ELECTRONIC, 35F, 35FD, 35R, 35RD, 400F, 400FD, 40-ELECTRONIC, 40F, 40FD, 500F, 500FD, 50F, 50FD, 510F, 510FD, 913363, 913364, 913376, 913377, 914568, 915830, E.35...(Other models you can see in the webshop)		
accessories for	510131		
	Part No.	510138	Ref. No. 114013 140013 140020
	wash jet fine groove		

			
1			
Part No.	518333	Ref. No.	106006
description	wash arm mounting pos. left L 220mm mounting ø 24mm nozzles 4		
For models:	050F, 050FP, 2312-001, 2312-002, 914568, 915830, E.50, E.50D.PA, E.51, F85, F85P, FAST-160DP, GSP50, GSP50P, GSP51, GSP51P, LF50, LF55, MC501E, MC501EP, MC501S, MC501SP, MISTRAL-51, NIAGARA-51, P500, PS-60, S651, S651P, S653, S654, S655, S830, S835, S850, SR651, TF-503, TF-513, TF-515		
accessories for	518333		
	Part No.	518004	Ref. No. 140008
	wash jet		
	Part No.	518272	Ref. No. 429040
	union nut for wash jet		

			
1			
Part No.	518332	Ref. No.	106008
description	wash arm mounting pos. right L 220mm mounting ø 24mm nozzles 5		
For models:	050F, 050FP, 2312-001, 2312-002, 914568, 915830, E.50, E.50D.PA, E.51, F85, F85P, FAST-160DP, GSP50, GSP50P, GSP51, GSP51P, LF50, LF55, MC501E, MC501EP, MC501S, MC501SP, MISTRAL-51, NIAGARA-51, P500, PS-60, S651, S651P, S653, S654, S655, S830, S835, S850, SR651		
accessories for	518332		
	Part No.	518004	Ref. No. 140008
	wash jet		
	Part No.	518272	Ref. No. 429040
	union nut for wash jet		

			
1			
Part No.	510010	Ref. No.	129003 129039
description	wash arm boss L1 64mm L2 60mm mounting ø 16.5mm		
For models:	050F, 050FP, 11F, 11FD, 11F-DVGW, 21F, 21FD, 2312-001, 2312-002, 25F, 25FD, 30F, 30FD, 31F, 31FD, 400F, 400FD, 40-ELECTRONIC, 40F, 40FD, 45, 450, 46, 460, 500F, 500FD, 50F, 50FD, 510F, 510FD, 67R, 913363, 913364, 913376, 913377, 914568, 915830, E.41, E.42, E.45, E.46, E.50, E.50D.PA, E.51, E.41, F85, F85P, FAST-160DP, GSP50, GSP50P...(Other models you can see in the webshop)		

			
1			
Part No.	518004	Ref. No.	140008
description	wash jet		
For models:	050F, 050FP, 11R, 11RD, 21F, 21FD, 21R, 21RD, 2312-001, 2312-002, 25F, 25FD, 25R, 25RD, 30F, 30FD, 30R, 30RD, 31F, 31FD, 31R, 31RD, 500F, 500FD, 50F, 50FD, 510F, 510FD, 67R, 914568, 915830, E.42, E.50, E.50D.PA, E.51, F85, F85P, FAST-160DP, GSP50, GSP50P, GSP51, GSP51P, LF50, LF55, MC501E, MC501EP, MC501S, MC501SP, MISTRAL-51, NIAGARA-51...(Other models you can see in the webshop)		






			
1			
Part No.	524077	Ref. No.	79040
description	wash and rinse arm wash arm L 490mm rinse arm L 495mm w. jets 8 r. jets 6 mounting ø 16.5mm mounting pos. upper/lower		
For models:	PS-60		
spare parts for	524077		
	Part No.	510139	Ref. No. 140007
	rinse jet		
	Part No.	518004	Ref. No. 140008
	wash jet		



Table continues overleaf







spare parts for 524077			
	Part No. 518053	Ref. No. 429006.TN 429039	
union nut for rinse jet			
	Part No. 518272	Ref. No. 429040	
union nut for wash jet			
	Part No. 518332	Ref. No. 106008	
wash arm mounting pos. right L 220mm mounting ø 24mm nozzles 5			
	Part No. 518333	Ref. No. 106006	
wash arm mounting pos. left L 220mm mounting ø 24mm nozzles 4			
	Part No. 518334	Ref. No. 106007	
rinse arm mounting pos. right L 220mm mounting ø 13mm nozzles 3			
	Part No. 518335	Ref. No. 106005	
rinse arm mounting pos. left L 220mm mounting ø 13mm nozzles 3			




	Part No. 518335	Ref. No. 106005	
description rinse arm mounting pos. left L 220mm mounting ø 13mm nozzles 3			
For models: 050F, 050FP, 2312-001, 2312-002, 914568, 915830, E.50, E.50D.PA, E.51, F85, F85P, FAST-160DP, GSP50, GSP50P, GSP51, GSP51P, LF50, LF55, MC501E, MC501EP, MC501S, MC501SP, MISTRAL-51, NIAGARA-51, P500, PS-60, S651, S651P, S653, S654, S655, S830, S835, S850, SR651, TF-503, TF-513, TF-515			

	Part No. 518334	Ref. No. 106007	
description rinse arm mounting pos. right L 220mm mounting ø 13mm nozzles 3			
For models: 050F, 050FP, 2312-001, 2312-002, 914568, 915830, E.50, E.50D.PA, E.51, F85, F85P, FAST-160DP, GSP50, GSP50P, GSP51, GSP51P, LF50, LF55, MC501E, MC501EP, MC501S, MC501SP, MISTRAL-51, NIAGARA-51, P500, PS-60, S651, S651P, S653, S654, S655, S830, S835, S850, SR651			

	Part No. 510139	Ref. No. 140007	
description rinse jet			
For models: 050F, 050FP, 10, 11F, 11FD, 11F-DVGW, 11R, 11RD, 12, 21F, 21FD, 21R, 21RD, 22F, 2312-001, 2312-002, 25F, 25FD, 25R, 25RD, 30F, 30FD, 30R, 30RD, 31F, 31FD, 31R, 31RD, 350F, 350FD, 350R, 350RD, 35-ELECTRONIC, 35F, 35FD, 35R, 35RD, 400F, 400FD, 400R, 400RD, 40-ELECTRONIC, 40F, 40FD, 40R, 40RD, 440F, 44F, 45, 450...(Other models you can see in the webshop)			
accessories for 510139			
	Part No. 510130	Ref. No. 429006	
union nut for rinse jet			

	Part No. 510130	Ref. No. 429006	
description union nut for rinse jet			
For models: 10, 11F, 11FD, 11F-DVGW, 11R, 11RD, 12, 21F, 21FD, 21R, 21RD, 22F, 2312-001, 2312-002, 25F, 25FD, 25R, 25RD, 30F, 30FD, 30R, 30RD, 31F, 31FD, 31R, 31RD, 350F, 350FD, 350R, 350RD, 35-ELECTRONIC, 35F, 35FD, 35R, 35RD, 400F, 400FD, 400R, 400RD, 40-ELECTRONIC, 40F, 40FD, 40R, 40RD, 440F, 44F, 500F, 500FD, 50-ELECTRONIC, 50F...(Other models you can see in the webshop)			
accessories for 510130			
	Part No. 510139	Ref. No. 140007	
rinse jet			


	Part No. 510131	Ref. No. 429007	
description union nut for wash jet			
For models: 11F, 11FD, 11F-DVGW, 11R, 11RD, 21F, 21FD, 21R, 21RD, 2312-001, 2312-002, 25F, 25FD, 25R, 25RD, 30F, 30FD, 30R, 30RD, 31F, 31FD, 31R, 31RD, 350F, 350FD, 350R, 350RD, 35-ELECTRONIC, 35F, 35FD, 35R, 35RD, 400F, 400FD, 40-ELECTRONIC, 40F, 40FD, 500F, 500FD, 50F, 50FD, 510F, 510FD, 913363, 913364, 913376, 913377, 914568, 915830, E.35...(Other models you can see in the webshop)			
accessories for 510131			
	Part No. 510138	Ref. No. 114013 140013 140020	
wash jet fine groove			


	Part No. 518333	Ref. No. 106006	
description wash arm mounting pos. left L 220mm mounting ø 24mm nozzles 4			
For models: 050F, 050FP, 2312-001, 2312-002, 914568, 915830, E.50, E.50D.PA, E.51, F85, F85P, FAST-160DP, GSP50, GSP50P, GSP51, GSP51P, LF50, LF55, MC501E, MC501EP, MC501S, MC501SP, MISTRAL-51, NIAGARA-51, P500, PS-60, S651, S651P, S653, S654, S655, S830, S835, S850, SR651, TF-503, TF-513, TF-515			
accessories for 518333			
	Part No. 518004	Ref. No. 140008	
wash jet			
	Part No. 518272	Ref. No. 429040	
union nut for wash jet			





			
1			
Part No.	518332	Ref. No.	106008
description	wash arm mounting pos. right L 220mm mounting \varnothing 24mm nozzles 5		
For models:	050F, 050FP, 2312-001, 2312-002, 914568, 915830, E.50, E.50D.PA, E.51, F85, F85P, FAST-160DP, GSP50, GSP50P, GSP51, GSP51P, LF50, LF55, MC501E, MC501EP, MC501S, MC501SP, MISTRAL-51, NIAGARA-51, P500, PS-60, S651, S651P, S653, S654, S655, S830, S835, S850, SR651		
accessories for	518332		
	Part No.	518004	Ref. No. 140008
			wash jet
	Part No.	518272	Ref. No. 429040
			union nut for wash jet

			
1			
Part No.	518426	Ref. No.	990096
description	wash and rinse arm wash arm L 350mm rinse arm L 350mm w. jets 6 r. jets 4 mounting \varnothing 14/37mm mounting pos. lower		
For models:	E.35		
spare parts for	518426		
	Part No.	510130	Ref. No. 429006
			union nut for rinse jet
	Part No.	510131	Ref. No. 429007
			union nut for wash jet
	Part No.	510138	Ref. No. 114013 140013 140020
			wash jet fine groove
	Part No.	510139	Ref. No. 140007
			rinse jet
	Part No.	513271	Ref. No. 412028
			connector holder grey
	Part No.	518028	Ref. No. 454004
			knurled nut thread M5 \varnothing 25mm H 4mm SS
	Part No.	518428	Ref. No. 106095
			wash arm mounting pos. right L 160mm mounting \varnothing 19mm nozzles 3
	Part No.	518429	Ref. No. 106096
			wash arm mounting pos. left L 155mm mounting \varnothing 15mm nozzles 3
	Part No.	518430	Ref. No. 106098
			rinse arm mounting pos. right L 165mm mounting \varnothing 14mm nozzles 2
	Part No.	518431	Ref. No. 106097
			rinse arm mounting pos. left L 165mm mounting \varnothing 14mm nozzles 2

			
1			
Part No.	510010	Ref. No.	129003 129039
description	wash arm boss L1 64mm L2 60mm mounting \varnothing 16.5mm		
For models:	050F, 050FP, 11F, 11FD, 11F-DVGW, 21F, 21FD, 2312-001, 2312-002, 25F, 25FD, 30F, 30FD, 31F, 31FD, 400F, 400FD, 40-ELECTRONIC, 40F, 40FD, 45, 450, 46, 460, 500F, 500FD, 50F, 50FD, 510F, 510FD, 67R, 913363, 913364, 913376, 913377, 914568, 915830, E.41, E.42, E.45, E.46, E.50, E.50D.PA, E.51, E.41, F85, F85P, FAST-160DP, GSP50, GSP50P... (Other models you can see in the webshop)		

			
1			
Part No.	517561	Ref. No.	79021
description	wash arm boss mounting pos. upper/lower mounting \varnothing 45mm L 84mm W 75mm H 50mm		
For models:	PS-60		

			
1			
Part No.	510138	Ref. No.	114013 140013 140020
description	wash jet fine groove		
For models:	11F, 11FD, 11F-DVGW, 350F, 350FD, 350R, 350RD, 35-ELECTRONIC, 35F, 35FD, 35R, 35RD, 400F, 400FD, 40-ELECTRONIC, 40F, 40FD, 45, 450, 46, 460, 67R, 913363, 913364, 913376, 913377, E.35, E.35H, E.40, E.40H, E.41, E.42, E.45, E.46, E.41, GLS40H, GLS40HP, GSP50, GSP50P, GSP51, GSP51P, MC201CL, MISTRAL-40, NIAGARA-35, NIAGARA-40, NIAGARA-45, P500, PS-60, TF-503, TF-513... (Other models you can see in the webshop)		
accessories for	510138		
	Part No.	510131	Ref. No. 429007
			union nut for wash jet







			
1			
Part No.	513712	Ref. No.	990103
description	wash and rinse arm wash arm L 350mm rinse arm L 350mm w. jets 6 r. jets 4 mounting \varnothing 14/41mm mounting pos. lower		
For models:	E.35, E.35H, MC201CL, NIAGARA-35		
spare parts for	513712		
	Part No.	510130	Ref. No. 429006
			union nut for rinse jet
	Part No.	510131	Ref. No. 429007
			union nut for wash jet



Table continues overleaf







spare parts for 513712				
	Part No.	510138	Ref. No.	114013 140013 140020
	wash jet fine groove			
	Part No.	510139	Ref. No.	140007
	rinse jet			
	Part No.	513261	Ref. No.	129056
	wash arm boss			
	Part No.	513271	Ref. No.	412028
	connector holder grey			
	Part No.	518028	Ref. No.	454004
	knurled nut thread M5 ø 25mm H 4mm SS			
	Part No.	518428	Ref. No.	106095
	wash arm mounting pos. right L 160mm mounting ø 19mm nozzles 3			
	Part No.	518429	Ref. No.	106096
	wash arm mounting pos. left L 155mm mounting ø 15mm nozzles 3			
	Part No.	518430	Ref. No.	106098
	rinse arm mounting pos. right L 165mm mounting ø 14mm nozzles 2			
	Part No.	518431	Ref. No.	106097
	rinse arm mounting pos. left L 165mm mounting ø 14mm nozzles 2			


	Part No.	518431	Ref. No.	106097
	rinse arm mounting pos. left L 165mm mounting ø 14mm nozzles 2			
For models:	350F, 350FD, 350R, 350RD, 35F, 35FD, 35R, 35RD, E.35, E.35H, MC-201CL, NIAGARA-35			


	Part No.	518430	Ref. No.	106098
	rinse arm mounting pos. right L 165mm mounting ø 14mm nozzles 2			
For models:	E.35, E.35H, MC201CL, NIAGARA-35			


	Part No.	510139	Ref. No.	140007
	rinse jet			
For models:	050F, 050FP, 10, 11F, 11FD, 11F-DVGW, 11R, 11RD, 12, 21F, 21FD, 21R, 21RD, 22F, 2312-001, 2312-002, 25F, 25FD, 25R, 25RD, 30F, 30FD, 30R, 30RD, 31F, 31FD, 31R, 31RD, 350F, 350FD, 350R, 350RD, 35-ELECTRONIC, 35F, 35FD, 35R, 35RD, 400F, 400FD, 400R, 400RD, 40-ELECTRONIC, 40F, 40FD, 40R, 40RD, 440F, 44F, 45, 450...(Other models you can see in the webshop)			
accessories for	510139			
	Part No.	510130	Ref. No.	429006
	union nut for rinse jet			

	Part No.	510130	Ref. No.	429006
	description union nut for rinse jet			
For models:	10, 11F, 11FD, 11F-DVGW, 11R, 11RD, 12, 21F, 21FD, 21R, 21RD, 22F, 2312-001, 2312-002, 25F, 25FD, 25R, 25RD, 30F, 30FD, 30R, 30RD, 31F, 31FD, 31R, 31RD, 350F, 350FD, 350R, 350RD, 35-ELECTRONIC, 35F, 35FD, 35R, 35RD, 400F, 400FD, 400R, 400RD, 40-ELECTRONIC, 40F, 40FD, 40R, 40RD, 440F, 44F, 500F, 500FD, 50-ELECTRONIC, 50F...(Other models you can see in the webshop)			
accessories for	510130			
	Part No.	510139	Ref. No.	140007
	rinse jet			



	Part No.	510131	Ref. No.	429007
	description union nut for wash jet			
For models:	11F, 11FD, 11F-DVGW, 11R, 11RD, 21F, 21FD, 21R, 21RD, 2312-001, 2312-002, 25F, 25FD, 25R, 25RD, 30F, 30FD, 30R, 30RD, 31F, 31FD, 31R, 31RD, 350F, 350FD, 350R, 350RD, 35-ELECTRONIC, 35F, 35FD, 35R, 35RD, 400F, 400FD, 40-ELECTRONIC, 40F, 40FD, 500F, 500FD, 50F, 50FD, 510F, 510FD, 913363, 913364, 913376, 913377, 914568, 915830, E.35...(Other models you can see in the webshop)			
accessories for	510131			
	Part No.	510138	Ref. No.	114013 140013 140020
	wash jet fine groove			












	Part No.	518429	Ref. No.	106096
	description wash arm mounting pos. left L 155mm mounting ø 15mm nozzles 3			
For models:	350F, 350FD, 350R, 350RD, 35F, 35FD, 35R, 35RD, E.35, E.35H, MC-201CL, NIAGARA-35			


	Part No.	518428	Ref. No.	106095
	description wash arm mounting pos. right L 160mm mounting ø 19mm nozzles 3			
For models:	350F, 350FD, 350R, 350RD, 35F, 35FD, 35R, 35RD, E.35, E.35H, MC-201CL, NIAGARA-35			


	Part No.	518438	Ref. No.	129050
	description wash arm boss L 64mm mounting ø 14/37mm H 38mm W 60mm			
For models:	E.35, E.40			






	1			
Part No.	510138	Ref. No.	114013 140013 140020	
description	wash jet fine groove			
For models:	11F, 11FD, 11F-DVGW, 350F, 350FD, 350R, 350RD, 35-ELECTRONIC, 35F, 35FD, 35R, 35RD, 400F, 400FD, 40-ELECTRONIC, 40F, 40FD, 45, 450, 46, 460, 67R, 913363, 913364, 913376, 913377, E.35, E.35H, E.40, E.40H, E.41, E.42, E.45, E.46, E41, GLS40H, GLS40HP, GSP50, GSP50P, GSP51, GSP51P, MC201CL, MISTRAL-40, NIAGARA-35, NIAGARA-40, NIAGARA-45, P500, PS-60, TF-503, TF-513...(Other models you can see in the webshop)			
accessories for	510138			
	Part No.	510131	Ref. No.	429007
	union nut for wash jet			



	1			
Part No.	518437	Ref. No.	990094 990104	
description	wash and rinse arm wash arm L 400mm rinse arm L 400mm w. jets 7 r. jets 5 mounting ø 14/41mm mounting pos. lower			
For models:	E.40, E.40H, GLS40H, GLS40HP, MISTRAL-40, NIAGARA-40			
spare parts for	518437			
	Part No.	510130	Ref. No.	429006
	union nut for rinse jet			
	Part No.	510131	Ref. No.	429007
	union nut for wash jet			
	Part No.	510138	Ref. No.	114013 140013 140020
	wash jet fine groove			
	Part No.	510139	Ref. No.	140007
	rinse jet			
	Part No.	513261	Ref. No.	129056
	wash arm boss			
	Part No.	513271	Ref. No.	412028
	connector holder grey			
	Part No.	518028	Ref. No.	454004
	knurled nut thread M5 ø 25mm H 4mm SS			
	Part No.	518439	Ref. No.	106111
	wash arm mounting pos. left L 180mm mounting ø 19mm nozzles 3			
	Part No.	518440	Ref. No.	106112
	wash arm mounting pos. right L 180mm mounting ø 19mm nozzles 4			
	Part No.	518441	Ref. No.	106113
	rinse arm mounting pos. left L 190mm mounting ø 14mm nozzles 3 type A			

spare parts for	518437			
	Part No.	518442	Ref. No.	106114
	rinse arm mounting pos. right L 190mm mounting ø 14mm nozzles 2 type B			


	1			
Part No.	518441	Ref. No.	106113	
description	rinse arm mounting pos. left L 190mm mounting ø 14mm nozzles 3 type A			
For models:	E.40, E.40H, GLS40H, GLS40HP, MISTRAL-40, NIAGARA-40			


	1			
Part No.	518442	Ref. No.	106114	
description	rinse arm mounting pos. right L 190mm mounting ø 14mm nozzles 2 type B			
For models:	E.40, E.40H, GLS40H, GLS40HP, MISTRAL-40, NIAGARA-40			


	1			
Part No.	510139	Ref. No.	140007	
description	rinse jet			
For models:	050F, 050FP, 10, 11F, 11FD, 11F-DVGW, 11R, 11RD, 12, 21F, 21FD, 21R, 21RD, 22F, 2312-001, 2312-002, 25F, 25FD, 25R, 25RD, 30F, 30FD, 30R, 30RD, 31F, 31FD, 31R, 31RD, 350F, 350FD, 350R, 350RD, 35-ELECTRONIC, 35F, 35FD, 35R, 35RD, 400F, 400FD, 400R, 400RD, 40-ELECTRONIC, 40F, 40FD, 40R, 40RD, 440F, 44F, 45, 450...(Other models you can see in the webshop)			
accessories for	510139			
	Part No.	510130	Ref. No.	429006
	union nut for rinse jet			



	1			
Part No.	510130	Ref. No.	429006	
description	union nut for rinse jet			
For models:	10, 11F, 11FD, 11F-DVGW, 11R, 11RD, 12, 21F, 21FD, 21R, 21RD, 22F, 2312-001, 2312-002, 25F, 25FD, 25R, 25RD, 30F, 30FD, 30R, 30RD, 31F, 31FD, 31R, 31RD, 350F, 350FD, 350R, 350RD, 35-ELECTRONIC, 35F, 35FD, 35R, 35RD, 400F, 400FD, 400R, 400RD, 40-ELECTRONIC, 40F, 40FD, 40R, 40RD, 440F, 44F, 500F, 500FD, 50-ELECTRONIC, 50F...(Other models you can see in the webshop)			
accessories for	510130			
	Part No.	510139	Ref. No.	140007
	rinse jet			






			
1			
Part No.	518329	Ref. No.	106035
description	rinse arm mounting pos. left L 110mm mounting ø 13mm nozzles 2		
For models:	11F, 11FD, 11F-DVGW, 21F, 21FD, 25F, 25FD, 30F, 30FD, 31F, 31FD, 400F, 400FD, 40-ELECTRONIC, 40F, 40FD, 913289, 913290, 913291, 913292, 913356, 913357, 913363, 913364, 913372, 913373, 913374, 913375, 913376, 913377, 913416, 913418, 913435, 913544, 913545, 913665, 913666, 913667, 913668, 913685, 913771, 913772, 913773, 913774, 913832, 913837, 913911, 913912, 913948, 913950...(Other models you can see in the webshop)		



			
2			
Part No.	518328	Ref. No.	106036
description	rinse arm mounting pos. right L 110mm mounting ø 13mm nozzles 2		
For models:	11F, 11FD, 11F-DVGW, 21F, 21FD, 25F, 25FD, 30F, 30FD, 31F, 31FD, 350F, 350FD, 35-ELECTRONIC, 35F, 35FD, 400F, 400FD, 40-ELECTRONIC, 40F, 40FD, 913289, 913290, 913291, 913292, 913356, 913357, 913363, 913364, 913372, 913373, 913374, 913375, 913376, 913377, 913416, 913418, 913435, 913544, 913545, 913665, 913666, 913667, 913668, 913685, 913771, 913772, 913773, 913774, 913832...(Other models you can see in the webshop)		


			
1			
Part No.	518326	Ref. No.	129002
description	rinse arm boss		
For models:	11F, 11FD, 11F-DVGW, 31F, 31FD, 350F, 350FD, 35-ELECTRONIC, 35F, 35FD, 400F, 400FD, 40-ELECTRONIC, 40F, 40FD, 45, 450, 460, 67R, 913289, 913290, 913291, 913292, 913356, 913357, 913363, 913364, 913372, 913373, 913374, 913375, 913376, 913377, 913416, 913418, 913435, 913544, 913545, 913665, 913666, 913667, 913668, 913685, 913771, 913772, 913773, 913774, 913832, 913837, 913911, 913912...(Other models you can see in the webshop)		

			
1			
Part No.	510139	Ref. No.	140007
description	rinse jet		
For models:	050F, 050FP, 10, 11F, 11FD, 11F-DVGW, 11R, 11RD, 12, 21F, 21FD, 21R, 21RD, 22F, 2312-001, 2312-002, 25F, 25FD, 25R, 25RD, 30F, 30FD, 30R, 30RD, 31F, 31FD, 31R, 31RD, 350F, 350FD, 350R, 350RD, 35-ELECTRONIC, 35F, 35FD, 35R, 35RD, 400F, 400FD, 400R, 400RD, 40-ELECTRONIC, 40F, 40FD, 40R, 40RD, 440F, 44F, 45, 450...(Other models you can see in the webshop)		
accessories for	510139		
	Part No.	510130	Ref. No. 429006
	union nut for rinse jet		


			
1			
Part No.	510130	Ref. No.	429006
description	union nut for rinse jet		
For models:	10, 11F, 11FD, 11F-DVGW, 11R, 11RD, 12, 21F, 21FD, 21R, 21RD, 22F, 2312-001, 2312-002, 25F, 25FD, 25R, 25RD, 30F, 30FD, 30R, 30RD, 31F, 31FD, 31R, 31RD, 350F, 350FD, 350R, 350RD, 35-ELECTRONIC, 35F, 35FD, 35R, 35RD, 400F, 400FD, 400R, 400RD, 40-ELECTRONIC, 40F, 40FD, 40R, 40RD, 440F, 44F, 500F, 500FD, 50-ELECTRONIC, 50F...(Other models you can see in the webshop)		
accessories for	510130		
	Part No.	510139	Ref. No. 140007
	rinse jet		



			
1			
Part No.	518053	Ref. No.	429006.TN 429039
description	union nut for rinse jet		
For models:	050F, 050FP, 45, 450, 46, 460, 67R, 914684, E.50, E.51, F85, F85P, LF50, LF55, MC501E, MC501EP, MC501S, MC501SP, MISTRAL-51, NIAGARA-51, RIVER-39, TF-503, TF-513, TF-515		


			
1			
Part No.	518142	Ref. No.	990113
description	wash arm wash arm L 490mm rinse arm L 490mm w. jets 10 r. jets 5 mounting ø 14/44mm mounting pos. upper/lower Mod. E50/503 & 91-series		
For models:	913297, 913298, 913299, 913300, 913360, 913361, 913391, 913392, 913546, 913547, 913578, 913611, 913684, 913913, 913914, 913932, 913933, 914284, 914318, 914319, 914326, 914331, 914338, 914356, 914400, 914401, 914402, 914403, 914404, 914405, 914406, 914431, 914449, 914517, 914545, 914642, 914688, 914909, 914979, 915136, 915137, 915140, 915150, 915151, 915152, 915154, 915155, 915157, 915158, 915160...(Other models you can see in the webshop)		
spare parts for	518142		
	Part No.	511510	Ref. No. 456070
	O-ring EPDM thickness 2.62mm ID ø 15.54mm Qty 10 pcs		


			
1			
Part No.	511510	Ref. No.	456070
description	O-ring EPDM thickness 2.62mm ID ø 15.54mm Qty 10 pcs		
For models:	913289, 913290, 913291, 913292, 913297, 913298, 913299, 913300, 913356, 913357, 913360, 913361, 913372, 913373, 913374, 913375, 913391, 913392, 913416, 913418, 913435, 913544, 913545, 913546, 913547, 913578, 913611, 913665, 913666, 913667, 913668, 913684, 913685, 913771, 913772, 913773, 913774, 913832, 913837, 913911, 913912, 913913, 913914, 913932, 913933, 913948, 913950, 913977, 913984, 913990...(Other models you can see in the webshop)		










			
1			
Part No.	532058	Ref. No.	456071
description	O-ring EPDM thickness 2.62mm ID ø 23.81mm Qty 10 pcs		
For models:	913289, 913290, 913291, 913292, 913297, 913298, 913299, 913300, 913356, 913357, 913360, 913361, 913372, 913373, 913374, 913375, 913391, 913392, 913416, 913418, 913435, 913544, 913545, 913546, 913547, 913578, 913611, 913665, 913666, 913667, 913668, 913684, 913685, 913771, 913772, 913773, 913774, 913832, 913837, 913911, 913912, 913913, 913914, 913932, 913933, 913948, 913950, 913977, 913984, 913990...(Other models you can see in the webshop)		

			
1			
Part No.	517438	Ref. No.	106153
description	wash arm mounting pos. upper left/bottom left wash arm L 230mm rinse arm L 230mm w. jets 5 r. jets 3 mounting ø 12/27mm		
For models:	913297, 913298, 913299, 913300, 913360, 913361, 913391, 913392, 913546, 913547, 913578, 913611, 913684, 913913, 913914, 913932, 913933, 914284, 914318, 914319, 914326, 914331, 914338, 914356, 914400, 914401, 914402, 914403, 914404, 914405, 914406, 914431, 914449, 914517, 914545, 914642, 914688, 914909, 914979, 915136, 915137, 915140, 915150, 915151, 915152, 915154, 915155, 915157, 915158, 915160...(Other models you can see in the webshop)		
accessories for	517438		
	Part No.	517440	Ref. No. 129068
	wash arm boss mounting pos. upper/lower L 88mm W 63mm H 69mm		


			
1			
Part No.	517567	Ref. No.	69316
description	wash arm mounting pos. upper/lower left wash arm L 210mm rinse arm L 210mm w. jets 5 r. jets 3 mounting ø 27/17mm		
For models:	CNT800CH, Fast180, Fast180-230V-3Ph-60Hz, FAST-60, FAST-73, NG281, NG281CDD, NG281HP, NG281HPDD, NG281HZ23, NG281H-Z23DD, NIAGARA-281, Niagara-281-2, Niagara-281HP, OC380, OC380FUR, OC380HZ23, Ocean380, PLUVIA-280, Pluvia280-230V-3PH-60HZ, PV280, PV280FAST, PV280FAST2, PV280FAST2BIO, PV280FAST2HZ23, PV280FASTCH, PV280FASTHB, PV280HZ23, SevenE		

			
1			
Part No.	517562	Ref. No.	69314
description	wash arm mounting pos. upper/lower right wash arm L 210mm rinse arm L 210mm w. jets 4 r. jets 2 mounting ø 27/17mm		
For models:	CNT800CH, Fast180, Fast180-230V-3Ph-60Hz, FAST-60, FAST-73, NG281, NG281CDD, NG281HP, NG281HPDD, NG281HZ23, NG281H-Z23DD, NIAGARA-281, Niagara-281-2, Niagara-281HP, OC380, OC380FUR, OC380HZ23, Ocean380, PLUVIA-280, Pluvia280-230V-3PH-60HZ, PV280, PV280FAST, PV280FAST2, PV280FAST2BIO, PV280FAST2HZ23, PV280FASTCH, PV280FASTHB, PV280HZ23, SevenE		


			
1			
Part No.	517563	Ref. No.	106152
description	wash arm mounting pos. upper/lower right wash arm L 230mm rinse arm L 230mm w. jets 5 r. jets 2 mounting ø 27/17mm		
For models:	913297, 913298, 913299, 913300, 913360, 913361, 913391, 913392, 913546, 913547, 913578, 913611, 913684, 913913, 913914, 913932, 913933, 914284, 914318, 914319, 914326, 914331, 914338, 914356, 914400, 914401, 914402, 914403, 914404, 914405, 914406, 914431, 914449, 914517, 914545, 914642, 914688, 914909, 914979, 915136, 915137, 915140, 915150, 915151, 915152, 915154, 915155, 915157, 915158, 915160...(Other models you can see in the webshop)		
accessories for	517563		
	Part No.	504618	Ref. No. 456026
	O-ring EPDM thickness 2.62mm ID ø 15.54mm Qty 1 pcs		
	Part No.	513725	Ref. No. 437100
	flat gasket PTFE ED ø 21.2mm ID ø 19mm thickness 0.5mm Qty 1 pcs		
	Part No.	532058	Ref. No. 456071
	O-ring EPDM thickness 2.62mm ID ø 23.81mm Qty 10 pcs		


			
1			
Part No.	517440	Ref. No.	129068
description	wash arm boss mounting pos. upper/lower L 88mm W 63mm H 69mm		
For models:	913297, 913298, 913299, 913300, 913360, 913361, 913391, 913392, 913418, 913546, 913547, 913578, 913611, 913684, 913913, 913914, 913932, 913933, 914167, 914168, 914284, 914318, 914319, 914326, 914331, 914338, 914356, 914398, 914399, 914400, 914401, 914402, 914403, 914404, 914405, 914406, 914431, 914443, 914449, 914517, 914545, 914642, 914688, 914909, 914943, 914979, 915136, 915137, 915140, 915150...(Other models you can see in the webshop)		
accessories for	517440		
	Part No.	517438	Ref. No. 106153
	wash arm mounting pos. upper left/bottom left wash arm L 230mm rinse arm L 230mm w. jets 5 r. jets 3 mounting ø 12/27mm		
	Part No.	517563	Ref. No. 106152
	wash arm mounting pos. upper/lower right wash arm L 230mm rinse arm L 230mm w. jets 5 r. jets 2 mounting ø 27/17mm		







			
1			
Part No.	531272	Ref. No.	990110
description	wash arm wash arm L 405mm rinse arm L 405mm w. jets 8 r. jets 5 mounting ø 14mm mounting pos. upper/lower complete HOBART/EUROTEC warewashing E40		
For models:	913291, 913292, 913357, 913374, 913375, 913416, 913435, 913545, 913666, 913668, 913685, 913773, 913774, 913911, 913912, 913948, 913950, 913977, 913984, 913990, 914214, 914316, 914317, 914392, 914393, 914394, 914395, 914396, 914397, 914441, 914442, 914515, 914516, 914537, 914543, 914547, 914683, 914689, 914863, 914874, 915138, 915139, 915527, 915611, 915612, 915613, 915614, 915615, 915616, 915617...(Other models you can see in the webshop)		

			
2			
Part No.	518666	Ref. No.	990118
description	wash arm wash arm L 455mm w. jets 9 r. jets 5		
For models:	CE78HZ23, E78, E78HP, Fast181, FAST-181, NG271, NG381, NG38123, NG38123TERMO, NG381C, NG381CDD, NG381CFUR, NG381DDHZ23, NG381DDPS, NG381DDPSHZ23, NG381HPDD, NG381TERMO, NG381TXCDD, NIAGARA-271, NIAGARA-283, Niagara-283A, Niagara-381, Niagara-381-230V-3Ph-50Hz, Niagara-381-230V-3Ph-60Hz, Niagara-381DP, Niagara-381HPD, RIVER-282, River-282-2, River-282S-2TDE, River-285, River-382, River-382-230V-3Ph-50Hz, River-382H, River-382NRG, River-382NRG-230-3Ph-50Hz, River-382TDE, RIVER-E78, RV282, RV282DD, RV282R, RV382, RV38223TERMO, RV382AHP, RV-382FUR, RV382R, RV382R23TERMO, RV382RFUR, RV382S, RV382SFUR, RV382TERMO...(Other models you can see in the webshop)		

			
1			
Part No.	511510	Ref. No.	456070
description	O-ring EPDM thickness 2.62mm ID ø 15.54mm Qty 10 pcs		
For models:	913289, 913290, 913291, 913292, 913297, 913298, 913299, 913300, 913356, 913357, 913360, 913361, 913372, 913373, 913374, 913375, 913391, 913392, 913416, 913418, 913435, 913544, 913545, 913546, 913547, 913578, 913611, 913665, 913666, 913667, 913668, 913684, 913685, 913771, 913772, 913773, 913774, 913832, 913837, 913911, 913912, 913913, 913914, 913932, 913933, 913948, 913950, 913977, 913984, 913990...(Other models you can see in the webshop)		

			
1			
Part No.	532058	Ref. No.	456071
description	O-ring EPDM thickness 2.62mm ID ø 23.81mm Qty 10 pcs		
For models:	913289, 913290, 913291, 913292, 913297, 913298, 913299, 913300, 913356, 913357, 913360, 913361, 913372, 913373, 913374, 913375, 913391, 913392, 913416, 913418, 913435, 913544, 913545, 913546, 913547, 913578, 913611, 913665, 913666, 913667, 913668, 913684, 913685, 913771, 913772, 913773, 913774, 913832, 913837, 913911, 913912, 913913, 913914, 913932, 913933, 913948, 913950, 913977, 913984, 913990...(Other models you can see in the webshop)		


			
1			
Part No.	517565	Ref. No.	106148
description	wash arm mounting pos. upper/lower left wash arm L 185mm rinse arm L 185mm w. jets 4 r. jets 2 mounting ø 27/17mm		
For models:	913291, 913292, 913357, 913374, 913375, 913416, 913435, 913545, 913666, 913668, 913685, 913773, 913774, 913911, 913912, 913948, 913950, 913977, 913984, 913990, 914214, 914316, 914317, 914392, 914393, 914394, 914395, 914396, 914397, 914441, 914442, 914515, 914516, 914537, 914543, 914547, 914683, 914689, 914863, 914874, 915138, 915139, 915527, 915611, 915612, 915613, 915614, 915615, 915616, 915617...(Other models you can see in the webshop)		


			
1			
Part No.	517564	Ref. No.	106149
description	wash arm mounting pos. upper/lower right wash arm L 185mm rinse arm L 185mm w. jets 4 r. jets 3 mounting ø 27/17mm		
For models:	913291, 913292, 913357, 913374, 913375, 913416, 913435, 913545, 913666, 913668, 913685, 913773, 913774, 913911, 913912, 913948, 913950, 913977, 913984, 913990, 914214, 914316, 914317, 914392, 914393, 914394, 914395, 914396, 914397, 914441, 914442, 914515, 914516, 914537, 914543, 914547, 914683, 914689, 914863, 914874, 915138, 915139, 915527, 915611, 915612, 915613, 915614, 915615, 915616, 915617...(Other models you can see in the webshop)		
accessories for	517564		
	Part No.	511510	Ref. No. 456070
	O-ring EPDM thickness 2.62mm ID ø 15.54mm Qty 10 pcs		
	Part No.	532058	Ref. No. 456071
	O-ring EPDM thickness 2.62mm ID ø 23.81mm Qty 10 pcs		


			
1			
Part No.	524809	Ref. No.	990111
description	wash and rinse arm wash arm L 340mm rinse arm L 340mm w. jets 7 r. jets 4 mounting ø 14/41mm mounting pos. lower		
For models:	913289, 913290, 913356, 913372, 913373, 913544, 913665, 913667, 913771, 913772, 913832, 913837, 914165, 914166, 914206, 914355, 914386, 914387, 914388, 914389, 914390, 914391, 914692, 914693, 914694, 914703, 914870, 915686, 915687, 915688, 915689, 915690, 915691, E.35, E.35-Elettrobar, E.35H, E.35H-Elettrobar, FAST-135, Fast135CT, FAST-135CT, Fast135D, FAST-135D, Fast135H, FAST-135H, Fast135HCT, FAST-135HCT, Fast135HD, FAST-135HD, NIAGARA-35		
spare parts for	524809		
	Part No.	511510	Ref. No. 456070
	O-ring EPDM thickness 2.62mm ID ø 15.54mm Qty 10 pcs		
	Part No.	517566	Ref. No. 106146
	wash arm mounting pos. bottom right wash arm L 155mm rinse arm L 155mm w. jets 3 r. jets 2 mounting ø 27/17mm		
	Part No.	517821	Ref. No. 106147
	wash and rinse arm wash arm L 155mm rinse arm L 155mm w. jets 4 r. jets 3 mounting ø 17/22mm		


Table continues overleaf





spare parts for 524809			
	Part No.	532058	Ref. No. 456071
O-ring EPDM thickness 2.62mm ID ø 23.81mm Qty 10 pcs			


1 			
Part No.	511510	Ref. No.	456070
description	O-ring EPDM thickness 2.62mm ID ø 15.54mm Qty 10 pcs		
For models:	913289, 913290, 913291, 913292, 913297, 913298, 913299, 913300, 913356, 913357, 913360, 913361, 913372, 913373, 913374, 913375, 913391, 913392, 913416, 913418, 913435, 913544, 913545, 913546, 913547, 913578, 913611, 913665, 913666, 913667, 913668, 913684, 913685, 913771, 913772, 913773, 913774, 913832, 913837, 913911, 913912, 913913, 913914, 913932, 913933, 913948, 913950, 913977, 913984, 913990...(Other models you can see in the webshop)		


1 			
Part No.	532058	Ref. No.	456071
description	O-ring EPDM thickness 2.62mm ID ø 23.81mm Qty 10 pcs		
For models:	913289, 913290, 913291, 913292, 913297, 913298, 913299, 913300, 913356, 913357, 913360, 913361, 913372, 913373, 913374, 913375, 913391, 913392, 913416, 913418, 913435, 913544, 913545, 913546, 913547, 913578, 913611, 913665, 913666, 913667, 913668, 913684, 913685, 913771, 913772, 913773, 913774, 913832, 913837, 913911, 913912, 913913, 913914, 913932, 913933, 913948, 913950, 913977, 913984, 913990...(Other models you can see in the webshop)		


1 			
Part No.	517821	Ref. No.	106147
description	wash and rinse arm wash arm L 155mm rinse arm L 155mm w. jets 4 r. jets 3 mounting ø 17/22mm		
For models:	913289, 913290, 913356, 913372, 913373, 913544, 913665, 913667, 913771, 913772, 913832, 913837, 914165, 914166, 914206, 914355, 914386, 914387, 914388, 914389, 914390, 914391, 914692, 914693, 914694, 914703, 914870, 915686, 915687, 915688, 915689, 915690, 915691, E.35, E.35-Elettrobar, E.35H, E.35H-Elettrobar, FAST-135, Fast135CT, FAST-135CT, Fast135D, FAST-135D, Fast135H, FAST-135H, Fast135HCT, FAST-135HCT, Fast135HD, FAST-135HD, NIAGARA-35		


1 			
Part No.	517566	Ref. No.	106146
description	wash arm mounting pos. bottom right wash arm L 155mm rinse arm L 155mm w. jets 3 r. jets 2 mounting ø 27/17mm		
For models:	913289, 913290, 913356, 913372, 913373, 913544, 913665, 913667, 913771, 913772, 913832, 913837, 914165, 914166, 914206, 914355, 914386, 914387, 914388, 914389, 914390, 914391, 914692, 914693, 914694, 914703, 914870, 915686, 915687, 915688, 915689, 915690, 915691, E.35, E.35-Elettrobar, E.35H, E.35H-Elettrobar, FAST-135, Fast135CT, FAST-135CT, Fast135D, FAST-135D, Fast135H, FAST-135H, Fast135HCT, FAST-135HCT, Fast135HD, FAST-135HD, NIAGARA-35		

1 			
Part No.	518626	Ref. No.	990015
description	wash arm H 470mm L 325mm nozzles 6 mounting ø 25mm		
For models:	R497, R499, R501, R503		

1 			
Part No.	510143	Ref. No.	140003
description	wash jet		
For models:	R495, R497, R499, R501, R503, R509, R511, R704, R706, R708, S651, S651P, S653, S654, S655, S830, S835, SR651		

1 			
Part No.	518314	Ref. No.	990082
description	wash arm H 470mm L 425mm nozzles 6 mounting pos. upper		
For models:	45, 450, 913418, 914167, 914168, 914398, 914399, 914443, 914943, 915695, 915696, 915819, E.45, Fast145, FAST-145, Fast145D, FAST-145D, NIAGARA-45		

1 			
Part No.	518410	Ref. No.	441010
description	end cap		
For models:	21F, 21FD, 21R, 21RD, 25F, 25FD, 25R, 25RD, 30F, 30FD, 30R, 30RD, 31F, 31FD, 31R, 31RD, 45, 450, 67R, 913291, 913292, 913357, 913363, 913364, 913374, 913375, 913376, 913377, 913416, 913418, 913435, 913545, 913666, 913668, 913685, 913773, 913774, 913911, 913912, 913948, 913950, 913977, 913984, 913990, 914167, 914168, 914214, 914316, 914317, 914392...(Other models you can see in the webshop)		

1 			
Part No.	510135	Ref. No.	110001
description	nozzle holder		
For models:	11F, 11FD, 11F-DVGW, 21F, 21FD, 25F, 25FD, 30F, 30FD, 31F, 31FD, 400F, 400FD, 40-ELECTRONIC, 40F, 40FD, E.40, E.40H, E.41, E.42, E.45, NIAGARA-40, S621, S623, S624, S626, S631, S633, S634, S636, S651, S655, S835		



1

Part No.	510146	Ref. No.	119003
description	swirl ø 18.5mm H 7mm hole ø 2mm		
For models:	11F, 11FD, 11F-DVGW, 21F, 21FD, 25F, 25FD, 30F, 30FD, 31F, 31FD, 400F, 400FD, 40-ELECTRONIC, 40F, 40FD, 45, 450, 67R, 913291, 913292, 913357, 913363, 913364, 913374, 913375, 913376, 913377, 913416, 913418, 913435, 913545, 913666, 913668, 913685, 913773, 913774, 913911, 913912, 913948, 913950, 913977, 913984, 913990, 914167, 914168, 914214, 914316, 914317, 914392...(Other models you can see in the webshop)		



2

Part No.	510144	Ref. No.	140010
description	union nut for wash jet		
For models:	11F, 11FD, 11F-DVGW, 31F, 31FD, 400F, 400FD, 40-ELECTRONIC, 40F, 40FD, 45, 450, 67R, 913291, 913292, 913357, 913363, 913364, 913374, 913375, 913376, 913377, 913416, 913418, 913435, 913545, 913666, 913668, 913685, 913773, 913774, 913911, 913912, 913948, 913950, 913977, 913984, 913990, 914167, 914168, 914214, 914316, 914317, 914392, 914393, 914394, 914395, 914396, 914397, 914398...(Other models you can see in the webshop)		





1

Part No.	518159	Ref. No.	110010
description	wash jet holder		
For models:	21F, 21FD, 25F, 25FD, 30F, 30FD, 31F, 31FD, 45, 450, 67R, 913418, 914167, 914168, 914398, 914399, 914443, 914943, 915695, 915696, 915819, E.45, Fast145, FAST-145, Fast145D, FAST-145D, NIAGARA-45		



1

Part No.	518481	Ref. No.	929196
description	wash arm L 335mm nozzles 12 mounting ø 16mm mounting pos. upper and bottom		
For models:	KLP201DDDTEB, KLP201EB, KLP301, KLP301DDDTEB, LP201DDDTEB, LP201EB, LP301, LP301EB, RIVER-297, RIVER-298, RV297, RV298, RV298HZ, U132, U132E, U70, U70e		
accessories for	518481		
	Part No.	Ref. No.	626129 926129
	wash arm bearing mounting pos. upper/lower		
	Part No.	Ref. No.	80314 926128
	nut M24x1.5		



1

Part No.	518316	Ref. No.	129036
description	wash arm L 385mm nozzles 4 mounting ø 20mm mounting pos. upper		
For models:	913992, 913993, 914583, 914592, 914612, 914613, 915143, CLEAN-3, RIVER-40, RIVER-40-CRP, RIVER-43, RIVER-44, RIVER-44-CRP, River-44-CRP-ST, RIVER-44CRP-ST		






1

Part No.	518455	Ref. No.	990087
description	wash arm L 490mm nozzles 8 mounting ø 50mm mounting pos. lower		
For models:	2312-001, 2312-002, 500F, 500FD, 50F, 50FD, 510F, 510FD, CLEAN-100, CLEAN-110, CLEAN-120, E.50, E.51, E.52, E.60, E.65, E1, E10, E100, E110, E12, E120, E14, E140, LF50, LF55, MCS01E, MCS01EP, MCS01S, MCS01SP, MISTRAL-51, NIAGARA-51		




1


Part No.	518019	Ref. No.	990055
description	wash arm L 490mm nozzles 8 mounting ø 50mm mounting pos. upper and bottom		
For models:	10, 12, 14, 22F, 40F, 44F, 500F, 500FD, 50F, 50FD, 510F, 510FD, 55, 66, CLEAN-110, S651, S810, S830		
accessories for	518019		
	Part No.	Ref. No.	303009
	bush for wash arm mounting pos. upper and bottom H 10mm D1 ø 65mm D2 ø 54mm ID ø 50mm type 22/66		
	Part No.	Ref. No.	325011
	rinse arm shaft		
	Part No.	Ref. No.	199027
	throttle disc ED ø 34mm ID ø 13.2mm thickness 1mm		





			
1			
Part No.	518270	Ref. No.	129046 DLL160
description	wash arm L 510mm nozzles 10 mounting ø 16mm mounting pos. lower		
For models:	050F, 050FP, F85, F85P		


			
1			
Part No.	518273	Ref. No.	990107
description	wash arm L 510mm nozzles 8 mounting ø 15mm mounting pos. upper and bottom		
For models:	2312-007, 2312-009-CRP, 914100, 914101, 914339, 914342, 914343, 914624, 914625, 914626, 914627, 914628, 914850, 914851, 914854, 914944, E.55, RIVER-48, RIVER-50, RIVER-50-CRP, RIVER-50-CRP-SP, River-54, RIVER-54CRP, River-54-CRP-s.p., RIVER-54-CRP-SP, RIVER-61		


			
1			
Part No.	511143	Ref. No.	303009
description	bush for wash arm mounting pos. upper and bottom H 10mm D1 ø 65mm D2 ø 54mm ID ø 50mm type 22/66		
For models:	10, 12, 14, 22F, 2312-001, 2312-002, 40F, 440F, 44F, 500F, 500FD, 50-ELECTRONIC, 50F, 50FD, 510F, 510FD, 55, 66, CLEAN-100, CLEAN-110, CLEAN-120, E.50, E.51, E.52, E.60, E.65, E1, E10, E100, E110, E12, E120, E14, E140, LF50, LF55, MC501E, MC501EP, MC501S, MC501SP, MISTRAL-51, NIAGARA-51, S651, S810, S830		


			
1			
Part No.	518392	Ref. No.	993041
description	rinse arm L 325mm nozzles 3 mounting ø 14mm mounting pos. upper		
For models:	440F, 44F		


			
1			
Part No.	518016	Ref. No.	145001
description	end cap		
For models:	10, S651, S654, S810, S815, S830, S835, S950		

			
1			
Part No.	518017	Ref. No.	145002
description	end cap		
For models:	S651, S654, S810, S815, S830, S835, S950		


			
1			
Part No.	511150	Ref. No.	468125
description	nozzle holder for rinse jet left		
For models:	10, 12, 22F, 2312-001, 2312-002, 40F, 440F, 44F, 500F, 500FD, 50-ELECTRONIC, 50F, 50FD, 510F, 510FD, 55, 66, CLEAN-100, CLEAN-110, CLEAN-120, E.50, E.51, E.52, E.60, E1, E10, E100, E110, E12, E120, LF50, LF55, MC501E, MC501EP, MC501S, MC501SP, MISTRAL-51, NIAGARA-51		


			
1			
Part No.	511149	Ref. No.	468124
description	nozzle holder for rinse jet right		
For models:	10, 12, 22F, 2312-001, 2312-002, 40F, 440F, 44F, 500F, 500FD, 50-ELECTRONIC, 50F, 50FD, 510F, 510FD, 55, 66, CLEAN-100, CLEAN-110, CLEAN-120, E.50, E.51, E.52, E.60, E1, E10, E100, E110, E12, E120, LF50, LF55, MC501E, MC501EP, MC501S, MC501SP, MISTRAL-51, NIAGARA-51		


			
1			
Part No.	510113	Ref. No.	449029
description	opposite support for rinse jet		
For models:	10, 12, 22F, 2312-001, 2312-002, 40F, 440F, 44F, 500F, 500FD, 50-ELECTRONIC, 50F, 50FD, 510F, 510FD, 55, 66, CLEAN-100, CLEAN-110, CLEAN-120, E.50, E.51, E.52, E.60, E1, E10, E100, E110, E12, E120, LF50, LF55, MC501E, MC501EP, MC501S, MC501SP, MISTRAL-51, NIAGARA-51, S651, S654, S810, S815, S830, S835, S950		



			
1			
Part No.	518424	Ref. No.	106053.CR
description	rinse arm mounting pos. bottom right L 200mm mounting ø 14mm nozzles 1		
For models:	2312-001, 2312-002, 500F, 500FD, 50F, 50FD, 510F, 510FD, CLEAN-100, CLEAN-110, CLEAN-120, E.50, E.51, E.52, E1, E10, E100, E110, E12, E120, LF50, LF55, MC501E, MC501EP, MC501S, MC501SP, MISTRAL-51, NIAGARA-51		






			
Part No.	518423	Ref. No.	106056.CR
description	rinse arm mounting pos. upper left L 185mm mounting ø 14mm nozzles 1		
For models:	E.52		




			
Part No.	518422	Ref. No.	106055.CR
description	rinse arm mounting pos. upper right L 185mm mounting ø 14mm nozzles 1		
For models:	E.52		



			
Part No.	513219	Ref. No.	129019 DAS265
description	rinse arm boss		
For models:	050F, 050FP, 10, 12, 14, 22F, 2312-001, 2312-002, 40F, 440F, 44F, 500F, 500FD, 50F, 50FD, 510F, 510FD, 55, 66, CLEAN-100, CLEAN-110, CLEAN-120, E.50, E.51, E.52, E.60, E.65, E1, E10, E100, E110, E12, E120, E14, E140, F85, F85P, LF50, LF55, MC501E, MC501EP, MC501S, MC501SP, MISTRAL-51, NIAGARA-51, S651, S654, S810, S815, S830...(Other models you can see in the webshop)		




			
Part No.	510139	Ref. No.	140007
description	rinse jet		
For models:	050F, 050FP, 10, 11F, 11FD, 11F-DVGW, 11R, 11RD, 12, 21F, 21FD, 21R, 21RD, 22F, 2312-001, 2312-002, 25F, 25FD, 25R, 25RD, 30F, 30FD, 30R, 30RD, 31F, 31FD, 31R, 31RD, 350F, 350FD, 350R, 350RD, 35-ELECTRONIC, 35F, 35FD, 35R, 35RD, 400F, 400FD, 400R, 400RD, 40-ELECTRONIC, 40F, 40FD, 40R, 40RD, 440F, 44F, 45, 450...(Other models you can see in the webshop)		
accessories for	510139		
		Part No.	510130 Ref. No. 429006
	union nut for rinse jet		

			
Part No.	510130	Ref. No.	429006
description	union nut for rinse jet		
For models:	10, 11F, 11FD, 11F-DVGW, 11R, 11RD, 12, 21F, 21FD, 21R, 21RD, 22F, 2312-001, 2312-002, 25F, 25FD, 25R, 25RD, 30F, 30FD, 30R, 30RD, 31F, 31FD, 31R, 31RD, 350F, 350FD, 350R, 350RD, 35-ELECTRONIC, 35F, 35FD, 35R, 35RD, 400F, 400FD, 400R, 400RD, 40-ELECTRONIC, 40F, 40FD, 40R, 40RD, 440F, 44F, 500F, 500FD, 50-ELECTRONIC, 50F...(Other models you can see in the webshop)		
accessories for	510130		
		Part No.	510139 Ref. No. 140007
	rinse jet		


			
Part No.	518470	Ref. No.	929126
description	rinse arm L 500mm nozzles 7 mounting ø 14mm mounting pos. upper and bottom		
For models:	E.65		


			
Part No.	518417	Ref. No.	926168
description	blank nozzle for rinse arm		
For models:	050F, 050FP, F85, F85P, MINIBAR, S280		
accessories for	518417		
		Part No.	560062 Ref. No. —
	flat-headed bolt thread M4 thread L 10mm SS DIN 7985/ISO 7045 Qty 20 pcs intake Phillips head ø 8mm head thickness 2mm		
		Part No.	560131 Ref. No. —
	hexagonal nut thread M4 H 3.2mm WS 7 SS DIN/ISO DIN 934 / ISO 4032/8673 Qty 20 pcs		




			
Part No.	518419	Ref. No.	926132
description	end cap for rinse arm		
For models:	050F, 050FP, 2312-007, 2312-009-CRP, 80, 81, 82, 913992, 913993, 914100, 914101, 914339, 914342, 914343, 914583, 914592, 914612, 914613, 914624, 914625, 914626, 914627, 914628, 914850, 914851, 914854, 914944, 915143, 915830, CGL74CABT, E.65, E78, F85, F85P, Fast160DP, FAST-181, Fast181-230V-3Ph-60Hz, Fast181-400V-3NPh-60Hz, HM1, KLP105EB, KLP201DDDTBE, KLP201EB, KLP301, KLP301DDDTBE, LP105DDDTBE, LP105DDDTBE, LP105EB, LP201DDDTBE, LP201EB, LP301...(Other models you can see in the webshop)		
accessories for	518419		
		Part No.	528485 Ref. No. 456060
	O-ring EPDM thickness 1.78mm ID ø 6.07mm Qty 1 pcs		




			
Part No.	518416	Ref. No.	926131
description	opposite support for rinse jet		
For models:	050F, 050FP, E.65, F85, F85P, MINIBAR, S280, U132, U132E, U61, U61E, U61H, U61HE, U70, U70E		
accessories for	518416		
		Part No.	560062 Ref. No. —
	flat-headed bolt thread M4 thread L 10mm SS DIN 7985/ISO 7045 Qty 20 pcs intake Phillips head ø 8mm head thickness 2mm		
		Part No.	560131 Ref. No. —
	hexagonal nut thread M4 H 3.2mm WS 7 SS DIN/ISO DIN 934 / ISO 4032/8673 Qty 20 pcs		




 <p>1</p>			
Part No.	510303	Ref. No.	456030 CGR106
description	O-ring EPDM thickness 1.78mm ID ø 6.75mm Qty 1 pcs		
For models:	050F, 050FP, 914568, 915830, E.50D.PA, E.55, E.65, F85, F85P, FAST-160DP, Fast181-230V-3Ph-60Hz, Fast181-400V-3NPh-60Hz, MINIBAR, NG292HZ, Niagara-292-400V-3Ph-60Hz, River-295P, River-296P, RIVER-40, RIVER-43, RIVER-50, RIVER-50-CRP, RIVER-61, RIVER-80, RIVER-81, RIVER-82, RV295PS, RV296PS, S280, ST70FASTHB400, U132, U61, U61E, U61H, U61HE, U70		


 <p>1</p>			
Part No.	513219	Ref. No.	129019 DAS265
description	rinse arm boss		
For models:	050F, 050FP, 10, 12, 14, 22F, 2312-001, 2312-002, 40F, 440F, 44F, 500F, 500FD, 50F, 50FD, 510F, 510FD, 55, 66, CLEAN-100, CLEAN-110, CLEAN-120, E.50, E.51, E.52, E.60, E.65, E1, E10, E100, E110, E12, E120, E14, E140, F85, F85P, LF50, LF55, MCS01E, MCS01EP, MCS01S, MCS01SP, MISTRAL-51, NIAGARA-51, S651, S654, S810, S815, S830...(Other models you can see in the webshop)		


 <p>1</p>			
Part No.	513055	Ref. No.	926133 CSP2502
description	rinse jet		
For models:	050F, 050FP, E.65, F85, F85P, MINIBAR, S280, U132, U132E, U61, U61E, U61H, U61HE, U70, U70E		
accessories for	513055		
	Part No.	560062	Ref. No. —
	flat-headed bolt thread M4 thread L 10mm SS DIN 7985/ISO 7045 Qty 20 pcs intake Phillips head ø 8mm head thickness 2mm		
	Part No.	560131	Ref. No. —
	hexagonal nut thread M4 H 3.2mm WS 7 SS DIN/ISO DIN 934 / ISO 4032/8673 Qty 20 pcs		


 <p>1</p>			
Part No.	518320	Ref. No.	993048
description	rinse arm L 460mm nozzles 5 mounting ø 14mm mounting pos. lower		
For models:	914568, 915830, E.50D.PA, E.55, FAST-160DP, RIVER-50, RIVER-50-CRP, RIVER-61		
spare parts for	518320		
	Part No.	510303	Ref. No. 456030 CGR106
	O-ring EPDM thickness 1.78mm ID ø 6.75mm Qty 1 pcs		
	Part No.	518276	Ref. No. 140025 80373
	rinse jet		

spare parts for	518320		
	Part No.	518277	Ref. No. 140026
	rinse jet		
	Part No.	518278	Ref. No. 480086
	end cap		
	Part No.	518280	Ref. No. 412029
	connector holder for knurled nut		
	Part No.	518281	Ref. No. 454005
	knurled nut thread M6 SS ø 20mm H 4mm		
	Part No.	518327	Ref. No. 129054
	rinse arm boss		

 <p>1</p>			
Part No.	518274	Ref. No.	993047
description	rinse arm L 475mm nozzles 7 mounting ø 14mm mounting pos. upper		
For models:	E.55, RIVER-50, RIVER-50-CRP, RIVER-61		

 <p>1</p>			
Part No.	518280	Ref. No.	412029
description	connector holder for knurled nut		
For models:	2312-007, 2312-009-CRP, 913992, 913993, 914100, 914101, 914339, 914342, 914343, 914568, 914583, 914592, 914612, 914613, 914624, 914625, 914626, 914627, 914628, 914850, 914851, 914854, 914944, 915143, 915830, E.50D.PA, E.55, FAST-160DP, RIVER-40, RIVER-40-CRP, RIVER-43, RIVER-44, RIVER-44-CRP, RIVER-44-CRP-ST, RIVER-44CRP-ST, RIVER-48, RIVER-50, RIVER-50-CRP, RIVER-50-CRP-SP, RIVER-54, RIVER-54CRP, River-54-CRP-s.p., RIVER-54-CRP-SP, RIVER-61		



 <p>1</p>			
Part No.	518278	Ref. No.	480086
description	end cap		
For models:	914568, 915830, E.50D.PA, E.55, FAST-160DP, RIVER-40, RIVER-43, RIVER-50, RIVER-50-CRP, RIVER-61		

 <p>1</p>			
Part No.	518281	Ref. No.	454005
description	knurled nut thread M6 SS ø 20mm H 4mm		
For models:	2312-007, 2312-009-CRP, 80, 81, 82, 913992, 913993, 914100, 914101, 914339, 914342, 914343, 914568, 914583, 914592, 914612, 914613, 914624, 914625, 914626, 914627, 914628, 914850, 914851, 914854, 914944, 915143, 915830, CE78HZ23, CGL74CABT, E.50D.PA, E.55, E78, E78HP, FAST-160DP, HM1, LP60, NIAGARA-271, RIVER-282, RIVER-40, RIVER-40-CRP, RIVER-43, RIVER-44, RIVER-44-CRP, RIVER-44-CRP-ST, RIVER-44CRP-ST, RIVER-48, RIVER-50, RIVER-50-CRP, RIVER-50-CRP-SP... (Other models you can see in the webshop)		




Part No.	510303	Ref. No.	456030 CGR106
description	O-ring EPDM thickness 1.78mm ID ø 6.75mm Qty 1 pcs		
For models:	050F, 050FP, 914568, 915830, E.50D.PA, E.55, E.65, F85, F85P, FAST-160DP, Fast181-230V-3Ph-60Hz, Fast181-400V-3NPh-60Hz, MINIBAR, NG292HZ, Niagara-292-400V-3Ph-60Hz, River-295P, River-296P, RIVER-40, RIVER-43, RIVER-50, RIVER-50-CRP, RIVER-61, RIVER-80, RIVER-81, RIVER-82, RV295PS, RV296PS, S280, ST70FASTHB400, U132, U61, U61E, U61H, U61HE, U70		





Part No.	518327	Ref. No.	129054
description	rinse arm boss		
For models:	2312-007, 2312-009-CRP, 913992, 913993, 914100, 914101, 914339, 914342, 914343, 914568, 914583, 914592, 914612, 914613, 914624, 914625, 914626, 914627, 914628, 914850, 914851, 914854, 914944, 915143, 915830, E.50D.PA, E.55, FAST-160DP, RIVER-40, RIVER-40-CRP, RIVER-43, RIVER-44, RIVER-44-CRP, RIVER-44-CRP-ST, RIVER-44CRP-ST, RIVER-48, RIVER-50, RIVER-50-CRP, RIVER-50-CRP-SP, RIVER-54, RIVER-54CRP, River-54-CRP-s.p., RIVER-54-CRP-SP, RIVER-61		
accessories for	518327		
	Part No.	513157	Ref. No. 412030 80374
connector holder			
	Part No.	518281	Ref. No. 454005
knurled nut thread M6 SS ø 20mm H 4mm			



Part No.	518276	Ref. No.	140025 80373
description	rinse jet		
For models:	914568, 915830, E.50D.PA, E.55, FAST-160DP, FAST-181, KLP105EB, KLP201DDDTEB, KLP201EB, KLP301, KLP301DDDTEB, LP105DDDTEB, LP105DDDTEBN, LP105EB, LP201DDDTEB, LP201EB, LP301, LP301EB, NG291, NG292, NG293, NIAGARA-291, NIAGARA-292, NIAGARA-293, RIVER-294, RIVER-295, RIVER-296, RIVER-297, RIVER-298, RIVER-40, RIVER-43, RIVER-50, RIVER-50-CRP, RIVER-61, RV294, RV295, RV296, RV297, RV298, RV298HZ, ST70FASTHB, U132E, U61He, U70E		
accessories for	518276		
	Part No.	510303	Ref. No. 456030 CGR106
O-ring EPDM thickness 1.78mm ID ø 6.75mm Qty 1 pcs			



Part No.	518162	Ref. No.	113992
description	rinse arm L 370mm nozzles 4 mounting ø 13.5mm mounting pos. upper and bottom		
For models:	CLEAN-3		
spare parts for	518162		
	Part No.	518164	Ref. No. 140019
rinse jet			
	Part No.	518391	Ref. No. 480065
end cap for rinse arm			



Part No.	518391	Ref. No.	480065
description	end cap for rinse arm		
For models:	CLEAN-3		



Part No.	518164	Ref. No.	140019
description	rinse jet		
For models:	2312-007, 2312-009-CRP, 913992, 913993, 914100, 914101, 914339, 914342, 914343, 914583, 914592, 914612, 914613, 914624, 914625, 914626, 914627, 914628, 914850, 914851, 914854, 914944, 915143, CLEAN-3, RIVER-40, RIVER-40-CRP, RIVER-43, RIVER-44, RIVER-44-CRP, RIVER-44-CRP-ST, RIVER-44CRP-ST, RIVER-48, RIVER-50, RIVER-50-CRP, RIVER-50-CRP-SP, RIVER-54, RIVER-54CRP, River-54-CRP-s.p., RIVER-54-CRP-SP, RIVER-61		





Part No.	513220	Ref. No.	926063 926093
description	bush for rinse arm		
For models:	050F, 050FP, 14, E.65, E14, E140, F85, F85P, U132, U132E, U61, U61E, U61H, U61HE, U70, U70E		




Part No.	518037	Ref. No.	926062
description	end cap for rinse arm		
For models:	14, E14, E140		





			
1			
Part No.	518021	Ref. No.	926059
description	rinse arm mounting pos. upper/lower nozzles 3		
For models:	14, E14, E140		


			
1			
Part No.	510147	Ref. No.	119004
description	swirl ø 27mm H 12mm		
For models:	22F, 22R, 400R, 400RD, 40-ELECTRONIC, 40F, 40R, 40RD, 440F, 44F, E.52, S651, S654, S810, S815, S830, S835		

			
1			
Part No.	510007	Ref. No.	140014
description	union nut for wash jet		
For models:	22F, 22R, 400R, 400RD, 40-ELECTRONIC, 40F, 40R, 40RD, 440F, 44F, E.52		


			
1			
Part No.	517552	Ref. No.	927011
description	wash arm mounting pos. upper/lower L 495mm nozzles 5		
For models:	161, 221, 271, 272, 362, CLEAN-160, CLEAN-161, CLEAN-220, CLEAN-221, CLEAN-270, CLEAN-271, CLEAN-272, CLEAN-361, CLEAN-361P, CLEAN-362, CLEAN-471, CLEAN-471P		



			
1			
Part No.	524812	Ref. No.	927012
description	end cap for wash arm mounting pos. upper/lower ø 45mm H 28mm		
For models:	161, 221, 271, 272, 362, CLEAN-160, CLEAN-161, CLEAN-220, CLEAN-221, CLEAN-270, CLEAN-271, CLEAN-272, CLEAN-361, CLEAN-361P, CLEAN-362, CLEAN-471, CLEAN-471P		

			
1			
Part No.	528155	Ref. No.	927337 CGR4131NT
description	O-ring Viton thickness 3.53mm ID ø 32.93mm Qty 1 pcs		
For models:	161, 221, 271, 272, 362, 915747, 915773, A3EB, A3EBDAKRKYK, A3EBDRKYK, A3EBSAKRK, A3EBSEKWK, A4EB, A4EBDAKEKYK, A4EBDAKRK, A4EBDAKWK, A4EBDAKZK, A4EBDBKRK, A4EBDPKWKYK, A4EBDRK, A4EBSAK, A4EBSAKCK, A4EBSAKEKYK, A4EBSAKRKP, A4EBT, A4EBTSAK, A5EB, A5EBDAKYK, A5EBDRK, A5EBSAKRK, A5EBSAKRKYK, A5EBSAKWK, A5EBSAKWKYK, A5EBSBKRKP, A5EBSBKWK, A5EBSRK, CLEAN-161, CLEAN-221, CLEAN-271, CLEAN-272, CLEAN-362, Fast181, FAST-181, Fast181-230V-3Ph-60Hz, Fast181-400V-3NPh-60Hz, Fast200, Fast93, GL280EB, GL280EB23, GL280EB23DAR...(Other models you can see in the webshop)		

			
1			
Part No.	517434	Ref. No.	75125
description	rinse arm mounting pos. lower L 565mm W 20mm H 40mm nozzles 4		
For models:	914380, 914436, 915747, A3EB, A3EBD, A3EBDAKRKYK, A3EBDAKW, A3EBDBKWK, A3EBDRKYK, A3EBDVK, A3EBDYK, A3EBSAK, A3EBSAKRK, A3EBSAKWK, A3EBSBKWKYK, A3EBSEKWK, A3EBSWK, A4EB, A4EBD, A4EBDAKEKYK, A4EBDAKRK, A4EBDAKWK, A4EBDAKZK, A4EBDBKRK, A4EBDPKWKYK, A4EBDRK, A4EBS, A4EBSAK, A4EBSAKCK, A4EBSAKEKYK, A4EBSAKRK, A4EBSAKRKP, A4EBSAKYK, A4EBSCK, A4EBT, A4EBTSAK, A5EB, A5EBD, A5EBDAKPKWK, A5EBDAKWK, A5EBDAKYK, A5EBDRK, A5EBS, A5EBSAKPKWK, A5EBSAKRK, A5EBSAKRKYK, A5EBSAKWK, A5EBSAKWKYK, A5EBSBKRKP, A5EBSBKWK... (Other models you can see in the webshop)		

			
1			
Part No.	517436	Ref. No.	927069
description	rinse arm mounting pos. upper/lower L 545mm W 20mm H 40mm nozzles 4 without nozzles		
For models:	161, 221, 271, 272, 362, CLEAN-160, CLEAN-161, CLEAN-220, CLEAN-221, CLEAN-270, CLEAN-271, CLEAN-272, CLEAN-361, CLEAN-361P, CLEAN-362, CLEAN-471, CLEAN-471P		

			
1			
Part No.	524536	Ref. No.	75133
description	rinse jet thread M5 ø 8.5mm H 12mm WS 7		
For models:	914380, 914436, 915747, A3EB, A3EBD, A3EBDAKRKYK, A3EBDAKW, A3EBDBKWK, A3EBDRKYK, A3EBDVK, A3EBDYK, A3EBSAK, A3EBSAKRK, A3EBSAKWK, A3EBSBKWKYK, A3EBSEKWK, A3EBSWK, A4EB, A4EBD, A4EBDAKEKYK, A4EBDAKRK, A4EBDAKWK, A4EBDAKZK, A4EBDBKRK, A4EBDPKWKYK, A4EBDRK, A4EBS, A4EBSAK, A4EBSAKCK, A4EBSAKEKYK, A4EBSAKRK, A4EBSAKRKP, A4EBSAKYK, A4EBSCK, A4EBT, A4EBTSAK, A5EB, A5EBD, A5EBDAKPKWK, A5EBDAKWK, A5EBDAKYK, A5EBDRK, A5EBS, A5EBSAKPKWK, A5EBSAKRK, A5EBSAKRKYK, A5EBSAKWK, A5EBSAKWKYK, A5EBSBKRKP, A5EBSBKWK... (Other models you can see in the webshop)		

miscellaneous			
			
1			
Part No.	510132	Ref. No.	110002
description	nozzle holder for rinse jet		
For models:	22R, R495, R497, R499, R501, R503, R505, R507, R509, R511, R704, R706, R708, S651, S651P, S653, S654, S655, S815, S830, S835, S870, SR651		
accessories for	510132		
	Part No.	510113	Ref. No. 449029
	opposite support for rinse jet		



Part No.	513038	Ref. No.	929074
description	rinse jet		
For models:	55		



Part No.	513255	Ref. No.	929075
description	rinse jet		
For models:	55		

wash arm supports



Part No.	518289	Ref. No.	115117
description	opposite support for wash arm		
For models:	2312-007, 2312-009-CRP, 914339, 914342, 914343, 914626, PS-60, RIVER-48, RIVER-50, RIVER-50-CRP, RIVER-50-CRP-SP, RIVER-54, RIVER-54-CRP-SP, RIVER-61		
accessories for	518289		



Part No.	518205	Ref. No.	437079 80182 reb437079
-----------------	--------	-----------------	------------------------------

flat gasket rubber ED ϕ 61mm ID ϕ 47mm thickness 2mm Qty 1 pcs

Part No.	518108	Ref. No.	115102
description	opposite support for wash arm support		
For models:	67R		



Part No.	518343	Ref. No.	111031
description	opposite support mounting pos. lower for wash arm support		
For models:	050F, 050FP, 2312-001, 2312-002, E.50, E.51, E.55, F85, F85P, LF50, LF55, MC501E, MC501EP, MC501S, MC501SP, MISTRAL-51, NIAGARA-51, P500		



Part No.	518427	Ref. No.	115087
description	opposite support mounting pos. lower for wash arm support		
For models:	350F, 350FD, 350R, 350RD, 35-ELECTRONIC, 35F, 35FD, 35R, 35RD, 400F, 400FD, 400R, 400RD, 40-ELECTRONIC, 40F, 40FD, 40R, 40RD		



Part No.	513102	Ref. No.	926052
description	opposite support mounting pos. upper		
For models:	12, 14, 45, 450, 915695, 915696, 915819, CLEAN-120, E.45, E12, E120, E14, E140, Fast145, Fast145D		

accessories for 513102

Part No.	518025	Ref. No.	437014
-----------------	--------	-----------------	--------

gasket D1 ϕ 50mm D2 ϕ 82mm thickness 2mm with 6 holes wash arm support equiv. no. 437014 suitable for COLGED

Part No.	518471	Ref. No.	926065
-----------------	--------	-----------------	--------

rinse pipe



Part No.	510037	Ref. No.	115035
description	wash arm support		
For models:	11F, 11FD, 11F-DVGW		



Part No.	518069	Ref. No.	80177
description	wash arm support		


For models: 80, 81, 82, CE78HZ23, CGL74CABT, CNT800CH, E78, E78HP, FAST-181, Fast181-230V-3Ph-60Hz, Fast181-400V-3NPh-60Hz, FAST-60, FAST-73, HM1, NG281, NG281CDD, NG281HP, NG281HPDD, NG281HZ23, NG281HZ23DD, NG291, NIAGARA-281, Niagara-281HP, NIAGARA-283, Niagara-283A, NIAGARA-291, PLUVIA-280, Pluvia280-230V-3PH-60HZ, PS-60, PV280, PV280FAST, PV280FASTCH, PV280FASTHB, PV280HZ23, RIVER-282, River-285, RIVER-294, River-482, RIVER-71, RIVER-78, RIVER-80, River-81, River-81CRP, RIVER-81-CRP, RIVER-82, River-82CRP, RIVER-82-CRP, RIVER-E78, RIVER-HL-81, RIVER-HL-82...(Other models you can see in the webshop)


accessories for 518069



Part No.	518071	Ref. No.	80178
-----------------	--------	-----------------	-------


gasket for wash arm support L 109mm W 68mm





			
1			
Part No.	518096	Ref. No.	4206301
description	wash arm support mounting pos. lower		
For models:	KLP105EB, KLP201DDDTEB, KLP201EB, KLP301, KLP301DDDTEB, LP105DDDTEB, LP105DDDTEBN, LP105EB, LP201DDDTEB, LP201EB, LP301, LP301EB, NG292, NG292HZ, NG293, NIAGARA-292, Niagara-292-400V-3Ph-60Hz, NIAGARA-293, RIVER-295, River-295P, RIVER-296, River-296P, RIVER-297, RIVER-298, RV295, RV295PS, RV296, RV296PS, RV297, RV298, RV298HZ, U132E, U61E, U61HE, U70e		



			
1			
Part No.	518174	Ref. No.	115110
description	wash arm support mounting pos. lower D1 ø 38mm D2 ø 59mm H 69mm ID ø 13mm		
For models:	913289, 913290, 913291, 913292, 913356, 913357, 913372, 913373, 913374, 913375, 913416, 913435, 913544, 913545, 913665, 913666, 913667, 913668, 913685, 913771, 913772, 913773, 913774, 913832, 913837, 913911, 913912, 913948, 913950, 913977, 913984, 913990, 914165, 914166, 914206, 914214, 914316, 914317, 914355, 914386, 914387, 914388, 914389, 914390, 914391, 914392, 914393, 914394, 914395, 914396...(Other models you can see in the webshop)		



			
1			
Part No.	518168	Ref. No.	115094
description	wash arm support mounting pos. lower		
For models:	45, 450, E.45, NIAGARA-45		
accessories for	518168		
	Part No.	518025	Ref. No. 437014
	gasket D1 ø 50mm D2 ø 82mm thickness 2mm with 6 holes wash arm support equiv. no. 437014 suitable for COLGED		

			
1			
Part No.	518024	Ref. No.	115076 DAS2596
description	wash arm support mounting pos. lower H 126.5mm		
For models:	050F, 050FP, 10, 46, 460, CLEAN-100, CLEAN-110, CLEAN-120, E.46, E.60, E.65, E1, E10, E100, E110, E12, E120, F85, F85P, GSP50, GSP50P, GSP51, GSP51P, P500		


			
1			
Part No.	518445	Ref. No.	115107
description	wash arm support mounting pos. lower		
For models:	913363, 913364, 913376, 913377, E.41, E.42, E41		


			
1			
Part No.	513167	Ref. No.	115144
description	wash arm support mounting pos. lower H 145mm ID ø 24mm		
For models:	915611, 915612, 915613, 915614, 915615, 915616, 915617, 915618, 915670, 915671, 915672, 915773, 915774, 915959, 916066, 916077, 916078, 916196, 916197, 916198, 916199, 916200, 916409, 916410, 916418, 916419, 916591, 916592, 916593, 916594, 916595, 916877, 916921, 916922, 916992, 916993, Fast145-2, Fast150, Niagara-241, Niagara-241-2, Niagara-341, Pluvia-240, RIVER-242, River-242-2, River-242-2T, River-342C, River-342T		


			
1			
Part No.	518636	Ref. No.	115143
description	wash arm support mounting pos. lower		
For models:	915150, 915151, 915152, 915154, 915155, 915157, 915158, 915160, 915161, 915162, 915166, 915167, 915168, 915172, 915173, 915175, 915176, 915177, 915285, 915319, 915338, 915341, 915348, 915418, 915419, 915420, 915421, 915422, 915479, 915492, 915493, 915494, 915495, 915496, 915497, 915547, 915558, 915635, 915663, 915747, 916020, 916021, 916024, 916025, 916026, 916027, 916030, 916031, 916045, 916054...(Other models you can see in the webshop)		
accessories for	518636		
	Part No.	518637	Ref. No. 429073
	nut for wash arm support thread M56x2		


			
1			
Part No.	517793	Ref. No.	75648
description	wash arm support mounting pos. lower ø 40mm L1 62mm ID ø 28mm		
For models:	915747, A3EB, A3EBDAKRKYK, A3EBDRKYK, A3EBSAKRK, A3EBSEKWK, A4EB, A4EBDAKEKYK, A4EBDAKRK, A4EBDAKWK, A4EBDAKZK, A4EBDBKRRK, A4EBDPKWKYK, A4EBDRK, A4EBSAK, A4EBSAKCK, A4EBSAKEKYK, A4EBSAKRKP, A4EBT, A4EBTSAK, A5EB, A5EBDAKYK, A5EBDRK, A5EBSAKRK, A5EBSAKRKYK, A5EBSAKWK, A5EBSAKWKYK, A5EBSBKRPK, A5EBSBKWK, A5EBSRK, Fast200, Fast93, GL280EB, GL280EB23, GL280EB23DAR, GL280EB23HZ, GL280EB23HZDY, GL280EBDARY, GL280EBDAW, GL280EBDAY, GL280EBDB, GL280EBDBR, GL280EBDWY, GL280EBSA, GL280EBSAE, GL280EBSAEW, GL280EBSAEWY, GL280EBSAR, GL280EBSARY, GL280EBSAW...(Other models you can see in the webshop)		
accessories for	517793		
	Part No.	528155	Ref. No. 927337 CGR4131NT
	O-ring Viton thickness 3.53mm ID ø 32.93mm Qty 1 pcs		




			
1			
Part No.	518401	Ref. No.	108007
description	wash arm support mounting pos. upper		
For models:	22F, 22R, 40F, 440F, 44F, E.52, TF-503, TF-513, TF-515		

			
1			
Part No.	518403	Ref. No.	127028
description	wash arm support mounting pos. upper		
For models:	22F, 22R, 40F, 440F, 44F, E.52		



			
1			
Part No.	517569	Ref. No.	75144 75169 75645
description	wash arm support mounting pos. upper ø 40mm L1 62mm ID ø 28mm		
For models:	914380, 914436, 915747, A3EB, A3EBD, A3EBDAKRKYK, A3EBDAKW, A3EBDBKWK, A3EBDRKYK, A3EBDVK, A3EBDYK, A3EBSAK, A3EBSAKRK, A3EBSAKWK, A3EBSBKWKYK, A3EBSEKWK, A3EBSWK, A4EB, A4EBD, A4EBDAKEKYK, A4EBDAKRK, A4EBDAKWK, A4EBDAKZK, A4EBDBKRK, A4EBDPKWKYK, A4EBDRK, A4EBS, A4EBSAK, A4EBSAKCK, A4EBSAKEKYK, A4EBSAKRK, A4EBSAKRKP, A4EBSAKYK, A4EBSCK, A4EBT, A4EBTSAK, A5EB, A5EBD, A5EBDAKPKWK, A5EBDAKWK, A5EBDAKYK, A5EBDRK, A5EBS, A5EBSAKPKWK, A5EBSAKRK, A5EBSAKRKYK, A5EBSAKWK, A5EBSAKWKYK, A5EBSBKRPK, A5EBSBKWK... (Other models you can see in the webshop)		

			
1			
Part No.	518338	Ref. No.	115074 41550
description	wash arm support mounting pos. upper ø 49mm		
For models:	46, 460, 500F, 500FD, 50F, 50FD, 510F, 510FD, E.46, E.50, E.51, E.60, E.65, TF-503, TF-513, TF-515, U61, U61E		


			
1			
Part No.	520646	Ref. No.	75155
description	wash arm support ø 33mm hose ø 35mm		
For models:	914380, 914436, 915747, A3EB, A3EBD, A3EBDAKRKYK, A3EBDAKW, A3EBDBKWK, A3EBDRKYK, A3EBDVK, A3EBDYK, A3EBSAK, A3EBSAKRK, A3EBSAKWK, A3EBSBKWKYK, A3EBSEKWK, A3EBSWK, A4EB, A4EBD, A4EBDAKEKYK, A4EBDAKRK, A4EBDAKWK, A4EBDAKZK, A4EBDBKRK, A4EBDPKWKYK, A4EBDRK, A4EBS, A4EBSAK, A4EBSAKCK, A4EBSAKEKYK, A4EBSAKRK, A4EBSAKRKP, A4EBSAKYK, A4EBSCK, A4EBT, A4EBTSAK, A5EB, A5EBD, A5EBDAKPKWK, A5EBDAKWK, A5EBDAKYK, A5EBDRK, A5EBS, A5EBSAKPKWK, A5EBSAKRK, A5EBSAKRKYK, A5EBSAKWK, A5EBSAKWKYK, A5EBSBKRPK, A5EBSBKWK... (Other models you can see in the webshop)		



			
1			
Part No.	501450	Ref. No.	111024
description	wash arm support thread M12 L 100mm mounting ø 70mm ID ø 35mm		
For models:	913363, 913364, 913376, 913377, E.41, E.42, E41		



			
1			
Part No.	518141	Ref. No.	80179
description	wash arm support thread M46x2 ø 44mm ID ø 39mm L 112.5mm W 86mm hole ø 12mm		
For models:	CGL74CABT, NG271, NG291, NIAGARA-271, NIAGARA-283, Niagara-283A, NIAGARA-291, RIVER-282, River-285, RIVER-294, RIVER-80, River-81, RV282, RV282DD, RV282R, RV294, RV80, RV8023, RV8023HZ, RV80C, RV80HZ, RV81, RV8123, RV81A, RV81C, RV81HZ, RV81HZ23, RV81PAP, SevenL, SV72AEB, SV72EB		
accessories for	518141		
	Part No.	513286	Ref. No. 80281
	screw connection		
	Part No.	518205	Ref. No. 437079 80182 reb437079
	flat gasket rubber ED ø 61mm ID ø 47mm thickness 2mm Qty 1 pcs		

			
1			
Part No.	513124	Ref. No.	80314 926128
description	nut M24x1.5		
For models:	2312-001, 2312-002, 2312-009-CRP, 80, 81, 82, 914583, 914628, 914944, 915143, CGL74CABT, E.50, E.51, E78, FAST-181, Fast181-230V-3Ph-60Hz, Fast181-400V-3NPh-60Hz, HM1, LP60, MISTRAL-51, NG291, NG292, NG292HZ, NG293, NIAGARA-291, NIAGARA-292, Niagara-292-400V-3Ph-60Hz, NIAGARA-293, NIAGARA-51, RIVER-294, RIVER-295, River-295P, RIVER-296, River-296P, RIVER-40-CRP, RIVER-44-CRP, RIVER-44-CRP-ST, RIVER-44CRP-ST, RIVER-50-CRP, RIVER-50-CRP-SP, RIVER-54CRP, River-54-CRP-s.p., RIVER-54-CRP-SP, RIVER-71, RIVER-78, RIVER-80, River-81, River-81CRP, RIVER-81-CRP, RIVER-82... (Other models you can see in the webshop)		
accessories for	513124		
	Part No.	513123	Ref. No. 626129 926129
	wash arm bearing mounting pos. upper/lower		





			
1			
Part No.	518090	Ref. No.	417111
description	wash arm bearing		
For models:	2312-007, 914100, 914101, 914339, 914342, 914343, 914568, 914624, 914625, 914626, 914627, 914628, 914850, 914851, 914854, 914944, 915830, E.50D.PA, Fast160DP, FAST-160DP, RIVER-48, RIVER-54, RIVER-54CRP, River-54-CRP-s.p.		


			
1			
Part No.	513161	Ref. No.	80310
description	wash arm bearing mounting pos. upper		
For models:	80, 81, 82, CGL74CABT, E78, FAST-181, Fast181-230V-3Ph-60Hz, Fast181-400V-3NPh-60Hz, HM1, LP60, NG291, NG292, NG292HZ, NG293, NIAGARA-291, NIAGARA-292, Niagara-292-400V-3Ph-60Hz, NIAGARA-293, RIVER-294, RIVER-295, River-295P, RIVER-296, River-296P, RIVER-71, RIVER-78, RIVER-80, River-81, River-81CRP, RIVER-81-CRP, RIVER-82, River-82CRP, RIVER-82-CRP, RIVER-E78, RIVER-HL-81, RIVER-HL-82, RV294, RV295, RV295PS, RV296, RV296PS, RV71, RV80, RV8023, RV8023HZ, RV80C, RV80HZ, RV81, RV8123, RV81A, RV81C... (Other models you can see in the webshop)		
accessories for	513161		
	Part No.	513124	Ref. No. 80314 926128
	nut M24x1.5		


			
1			
Part No.	513123	Ref. No.	626129 926129
description	wash arm bearing mounting pos. upper/lower		
For models:	2312-001, 2312-002, 2312-009-CRP, 914583, 914628, 914944, 915143, E.50, E.51, LP60, MISTRAL-51, NG292HZ, Niagara-292-400V-3Ph-60Hz, NIAGARA-51, River-295P, River-296P, RIVER-40-CRP, RIVER-44-CRP, RIVER-44-CRP-ST, RIVER-44CRP-ST, RIVER-50-CRP, RIVER-50-CRP-SP, RIVER-54CRP, River-54-CRP-s.p., RIVER-54-CRP-SP, River-81CRP, RIVER-81-CRP, River-82CRP, RIVER-82-CRP, RV295PS, RV296PS, RV81CCRP, RV81CRP, RV82CCRP, RV82CRP, U132, U132E, U60E, U61, U61E, U61H, U61HE, U70, U70E		
accessories for	513123		
	Part No.	513124	Ref. No. 80314 926128
	nut M24x1.5		


rinse arm shafts


			
1			
Part No.	518048	Ref. No.	325039
description	extension for rinse arm shaft		
For models:	400F, 400FD, 40-ELECTRONIC, 40F, 40FD		


			
1			
Part No.	510013	Ref. No.	325001
description	rinse arm shaft		
For models:	11F, 11FD, 11F-DVGW, 21F, 21FD, 25F, 25FD, 30F, 30FD, 31F, 31FD, 350F, 350FD, 35-ELECTRONIC, 35F, 35FD, 400F, 400FD, 40-ELECTRONIC, 40F, 40FD, 45, 450, 67R, 913289, 913290, 913291, 913292, 913356, 913357, 913363, 913364, 913372, 913373, 913374, 913375, 913376, 913377, 913416, 913418, 913435, 913544, 913545, 913665, 913666, 913667, 913668, 913685, 913771, 913772...(Other models you can see in the webshop)		

			
1			
Part No.	510056	Ref. No.	325025
description	rinse arm shaft		
For models:	11F, 11FD, 11F-DVGW, 11R, 11RD, 67F, 67R, 913363, 913364, 913376, 913377, E.41, E.42, E.41		


			
1			
Part No.	510108	Ref. No.	327006
description	rinse arm shaft		
For models:	050F, 050FP, 11F, 11FD, 11F-DVGW, 21F, 21FD, 2312-001, 2312-002, 25F, 25FD, 30F, 30FD, 31F, 31FD, 400F, 400FD, 40-ELECTRONIC, 40F, 40FD, 45, 450, 46, 460, 500F, 500FD, 50-ELECTRONIC, 50F, 50FD, 510F, 510FD, 67R, 913363, 913364, 913376, 913377, 914568, 915830, E.41, E.42, E.45, E.46, E.50, E.50D.PA, E.51, E.41, F85, F85P, FAST-160DP, GSP50...(Other models you can see in the webshop)		


			
1			
Part No.	513101	Ref. No.	DLP940
description	rinse arm shaft		


			
1			
Part No.	513122	Ref. No.	926130 DLP52
description	rinse arm shaft		
For models:	050F, 050FP, CLEAN-100, CLEAN-110, CLEAN-120, E.60, E.65, E1, E10, E100, E110, E12, E120, E14, E140, F85, F85P, U132, U132E, U61, U61E, U61H, U61HE, U70, U70E		


			
1			
Part No.	513159	Ref. No.	80380
description	rinse arm shaft		
For models:	80, 81, 82, CGL74CABT, E78, FAST-181, HM1, KLP105EB, KL-P201DDDTBE, KLP201EB, KLP301, KLP301DDDTBE, LP105DDDTBE, LP105DDDTBE, LP105EB, LP201DDDTBE, LP201EB, LP301, LP301EB, LP60, NG291, NG292, NG293, NIAGARA-291, NIAGARA-292, NIAGARA-293, RIVER-294, RIVER-295, RIVER-296, RIVER-297, RIVER-298, RIVER-71, RIVER-78, RIVER-80, RIVER-81, River-81CRP, RIVER-81-CRP, RIVER-82, River-82CRP, RIVER-82-CRP, RIVER-E78, RIVER-HL-81, RIVER-HL-82, RV294, RV295, RV296, RV297, RV298, RV298HZ, RV71...(Other models you can see in the webshop)		





			
Part No.	513160	Ref. No.	80282
description	rinse arm shaft		
For models:	80, 81, 82, CE78HZ23, CGL74CABT, E78, E78HP, FAST-181, Fast181-230V-3Ph-60Hz, Fast181-400V-3NPh-60Hz, HM1, NG291, NG292, NG292HZ, NG293, NIAGARA-291, NIAGARA-292, Niagara-292-400V-3Ph-60Hz, NIAGARA-293, RIVER-294, RIVER-295, River-295P, RIVER-296, River-296P, RIVER-71, RIVER-78, RIVER-80, RIVER-81, River-81CRP, RIVER-81-CRP, RIVER-82, River-82CRP, RIVER-82-CRP, RIVER-E78, RIVER-HL-81, RIVER-HL-82, RV294, RV295, RV295PS, RV296, RV296PS, RV71, RV80, RV8023, RV8023HZ, RV80C, RV80HZ, RV81, RV8123, RV81A...(Other models you can see in the webshop)		


			
Part No.	518014	Ref. No.	325011
description	rinse arm shaft		
For models:	12, 14, 22F, 350R, 350RD, 35-ELECTRONIC, 35R, 35RD, 40F, 440F, 44F, 500F, 500FD, 50F, 50FD, 510F, 510FD, 66, S651, S654, S810, S815, S830, S835		


			
Part No.	518172	Ref. No.	325064
description	rinse arm shaft		
For models:	914684, E.35, E.35H, E.40, E.40H, GLS40H, GLS40HP, MC201CL, MINIBAR, MISTRAL-40, NIAGARA-35, NIAGARA-40, RIVER-39, S280		


			
Part No.	518185	Ref. No.	325048
description	rinse arm shaft		
For models:	913992, 913993, 914583, 914592, 914612, 914613, 915143, CLEAN-3, RIVER-40, RIVER-40-CRP, RIVER-43, RIVER-44, RIVER-44-CRP, River-44-CRP-ST, RIVER-44CRP-ST		

			
Part No.	518283	Ref. No.	325069
description	rinse arm shaft		
For models:	2312-007, 2312-009-CRP, 914100, 914101, 914339, 914342, 914343, 914624, 914625, 914626, 914627, 914628, 914850, 914851, 914854, 914944, RIVER-48, RIVER-50, RIVER-50-CRP, RIVER-50-CRP-SP, River-54, RIVER-54CRP, River-54-CRP-s.p., RIVER-54-CRP-SP, RIVER-61		


			
Part No.	518287	Ref. No.	325070
description	rinse arm shaft		
For models:	2312-007, 2312-009-CRP, 914100, 914101, 914339, 914342, 914343, 914624, 914625, 914626, 914627, 914628, 914850, 914851, 914854, 914944, E.55, RIVER-48, RIVER-50, RIVER-50-CRP, RIVER-50-CRP-SP, River-54, RIVER-54CRP, River-54-CRP-s.p., RIVER-54-CRP-SP, RIVER-61		


			
Part No.	518420	Ref. No.	926154
description	rinse arm shaft		
For models:	050F, 050FP, CLEAN-100, CLEAN-110, CLEAN-120, E.60, E.65, E1, E10, E100, E110, E12, E120, E14, E140, F85, F85P		

			
Part No.	517571	Ref. No.	325078
description	rinse arm shaft H 67mm thread M5 thread L 4.5mm		
For models:	913289, 913290, 913291, 913292, 913356, 913357, 913372, 913373, 913374, 913375, 913416, 913435, 913544, 913545, 913665, 913666, 913667, 913668, 913685, 913771, 913772, 913773, 913774, 913832, 913837, 913911, 913912, 913948, 913950, 913977, 913984, 913990, 914165, 914166, 914206, 914214, 914316, 914317, 914355, 914386, 914387, 914388, 914389, 914390, 914391, 914392, 914393, 914394, 914395, 914396...(Other models you can see in the webshop)		

			
Part No.	518405	Ref. No.	325045
description	rinse arm shaft mounting pos. lower		
For models:	46, 460, E.46, GSP50, GSP50P, GSP51, GSP51P, P500, RIVER-40		

			
Part No.	524096	Ref. No.	80283
description	rinse arm shaft mounting pos. lower ø 16mm H 38mm thread M12x1.75		
For models:	80, 81, 82, CE78HZ23, CGL74CABT, E78, E78HP, Fast181, FAST-181, Fast181-230V-3Ph-60Hz, Fast181-400V-3NPh-60Hz, HM1, NG291, NIAGARA-291, RIVER-294, RIVER-78, RIVER-80, River-81, River-81CRP, RIVER-81-CRP, RIVER-82, River-82CRP, RIVER-82-CRP, RIVER-E78, RIVER-HL-81, RIVER-HL-82, RV294, RV71, RV80, RV8023, RV8023HZ, RV80C, RV80HZ, RV81, RV8123, RV81A, RV81C, RV81CCR, RV81CRP, RV81HZ, RV81HZ23, RV81PAP, RV82, RV8223, RV82C, RV82CCR, RV82CRP, SevenL, ST70FAST, ST70FASTHB...(Other models you can see in the webshop)		

			
Part No.	513224	Ref. No.	926127
description	rinse arm shaft mounting pos. upper		
For models:	CLEAN-100, CLEAN-110, CLEAN-120, E1, E10, E100, E110, E12, E120, E14, E140		

			
Part No.	517445	Ref. No.	80700
description	rinse arm shaft mounting pos. upper/lower H 36mm thread M10x1 thread L 9mm		
For models:	915830, Fast160DP		



knobs

producer-specific knobs

ELETTROBAR



1

Part No.	110086	Ref. No.	447089
-----------------	--------	-----------------	--------

description knob switch zero mark t.max.°C ø 45mm shaft ømm shaft flat special black

For models: 10, 12, 22F, 22R, 40F, 66, CLEAN-100, CLEAN-110, CLEAN-120

accessories for 110086



Part No.	110085	Ref. No.	226051
-----------------	--------	-----------------	--------

description push button t.max.°C ø 36mm shaft ømm shaft flat grey for knob



1

Part No.	110085	Ref. No.	226051
-----------------	--------	-----------------	--------

description push button t.max.°C ø 36mm shaft ømm shaft flat grey for knob

For models: 10, 12, 22F, 22R, 40F, 66, CLEAN-100, CLEAN-110, CLEAN-120

pullouts

rollers

rollers



1

Part No.	518363	Ref. No.	499078
-----------------	--------	-----------------	--------

description roller rollerø 36mm B1 10mm overall width 22mm A 36mm B 10mm C 22mm ø 20.5mm plastic tread plastic

For models: 2312-007, 2312-009-CRP, 913992, 913993, 914100, 914101, 914339, 914342, 914343, 914583, 914592, 914612, 914613, 914624, 914625, 914626, 914627, 914628, 914850, 914851, 914854, 914944, 915143, CLEAN-3, RIVER-40, RIVER-40-CRP, RIVER-43, RIVER-44, RIVER-44-CRP, RIVER-44-CRP-ST, RIVER-44CRP-ST, RIVER-48, RIVER-50, RIVER-50-CRP, RIVER-50-CRP-SP, RIVER-54, RIVER-54CRP, RIVER-54-CRP-s.p., RIVER-54-CRP-SP, RIVER-61

equipment feet and end caps

screw-in feet



1

Part No.	695601	Ref. No.	461010
-----------------	--------	-----------------	--------

description equipment foot thread M17 thread L 23mm ø 24mm H 11mm plastic WS 24 Qty 1 pcs

For models: 11F, 11FD, 11F-DVGW, 11R, 11RD, 21F, 21FD, 21R, 21RD, 25F, 25FD, 25R, 25RD, 30F, 30FD, 30R, 30RD, 31F, 31FD, 31R, 31RD, 350F, 350FD, 350R, 350RD, 35-ELECTRONIC, 35F, 35FD, 35R, 35RD, 67F, 67R, 913289, 913290, 913291, 913292, 913356, 913357, 913363, 913364, 913372, 913373, 913374, 913375, 913376, 913377, 913416, 913435, 913544, 913545...(Other models you can see in the webshop)



1

Part No.	513284	Ref. No.	461019
-----------------	--------	-----------------	--------

description equipment foot thread M8 thread L 20mm ø 30mm H 12mm Qty 1 pcs

For models: 050F, 050FP, 2312-001, 2312-002, 2312-007, 2312-009-CRP, 45, 450, 46, 460, 500F, 500FD, 50F, 50FD, 510F, 510FD, 913297, 913298, 913299, 913300, 913360, 913361, 913391, 913392, 913418, 913546, 913547, 913578, 913611, 913684, 913913, 913914, 913932, 913933, 913992, 913993, 914100, 914101, 914167, 914168, 914284, 914318, 914319, 914331, 914338, 914339, 914342, 914343, 914356, 914398...(Other models you can see in the webshop)

baskets

warewashing baskets

steel wire baskets round

mix baskets



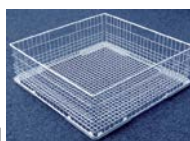
1

Part No.	970320	Ref. No.	983015
-----------------	--------	-----------------	--------

description mix basket ED ø 370mm H 170mm seat ømm

steel wire baskets octagonal

mix baskets



1

Part No.	971016 ¹	Ref. No.	983036
-----------------	---------------------	-----------------	--------

description mix basket L 382mm W 382mm H 130mm mesh type close-meshed

¹fine-meshed



1

Part No.	971015 ¹	Ref. No.	983001
description	mix basket L 382mm W 382mm H 200mm mesh type wide-meshed		

¹wide-meshed

1

Part No.	971013 ¹	Ref. No.	938055 983039 983055
description	mix basket L 382mm W 382mm H 90mm mesh type wide-meshed		

¹wide-meshed

1

Part No.	970072 ¹	Ref. No.	983032
description	mix basket L 500mm W 500mm H 100mm mesh type wide-meshed		

¹wide-meshed

1

Part No.	970074 ¹	Ref. No.	983033
description	mix basket L 500mm W 500mm H 130mm mesh type close-meshed		

¹fine-meshed

1

Part No.	971089 ¹	Ref. No.	41301 706125
description	mix basket L 610mm W 550mm H 175mm		

¹wide-meshed

plate baskets



1

Part No.	970071	Ref. No.	983031
description	plate basket L 500mm W 500mm H 100mm plates 18 plate ø 250mm		



1


Part No.	971127	Ref. No.	983027
description	plate basket L 500mm W 500mm H 105mm plates 16 plate ø 240mm		

glass basket



1

Part No.	971017	Ref. No.	983041 988041
description	glass basket L 382mm W 382mm H 170mm number of rows 3 rows spacing 120mm		

spare parts for	971017		
	Part No.	970001	Ref. No.
			—
	sliding corner wire gauge ø 5mm L 120mm W 120mm H 12mm L-shape		



1

Part No.	971018	Ref. No.	938038 983038
description	glass basket L 382mm W 382mm H 170mm number of rows 4 rows spacing 85mm inclined bottom		

plastic baskets octagonal

tray baskets



1

Part No.	970829	Ref. No.	780106
description	tray rack L 500mm W 500mm H 110mm mesh type wide-meshed for 8 trays for size 530x370		


accessories

cutlery inserts



1

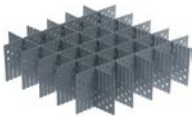
Part No.	976013	Ref. No.	712001 712003 712019
description	cutlery insert L 105mm W 105mm ømm H 140mm		

1

Part No.	976016	Ref. No.	780068
description	cutlery insert L 110mm W 110mm ømm H 130mm		


section inserts for glasses



1

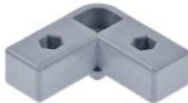
Part No.	970302	Ref. No.	712006
description	section insert for glasses L 400mm W 400mm H 105mm 10-piece		

sliding corners



1

Part No.	970830	Ref. No.	461003
description	sliding corner L 120mm W 120mm L-shape for 970829		
For models:	S621, S623, S631, S633, S641, S643, S651, S651P, S653, S810, S830, S850, S870		



1


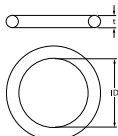
Part No.	970820	Ref. No.	75075
description	sliding corner L 44mm W 44mm H 17mm		
For models:	914380, 914436, A3EB, A3EBD, A3EBDAKRKYK, A3EBDAKWK, A3EBDBKWK, A3EBDRKYK, A3EBDVK, A3EBDYK, A3EBSAK, A3EBSAKRK, A3EBSAKWK, A3EBSBKWKYK, A3EBSEKWK, A3EBSWK, A4EB, A4EBD, A4EBDAKEYK, A4EBDAKRK, A4EBDAKWK, A4EBDAKZK, A4EBDBKRK, A4EBDPKWKYK, A4EBDRK, A4EBS, A4EBSAK, A4EBSAKCK, A4EBSAKKEYK, A4EBSAKRK, A4EBSAKRKP, A4EBSAKYK, A4EBSCK, A4EBT, A4EBTSAK, A5EB, A5EBD, A5EBDAKPKWK, A5EBDAKWK, A5EBDAKYK, A5EBDRK, A5EBS, A5EBSAKPKWK, A5EBSAKRK, A5EBSAKRKYK, A5EBSAKWK, A5EBSAKWKYK, A5EBSBKRPK, A5EBSBKWK, A5EBSRK... (Other models you can see in the webshop)		

gaskets

O-rings


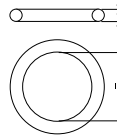
EPDM

ø1.78mm


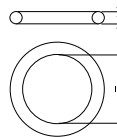
1

Part No.	529545	Ref. No.	456051
description	O-ring EPDM thickness 1.78mm ID ø 10.82mm Qty 1 pcs		
For models:	67F, 67R, 913363, 913364, 913376, 913377, E.41, E.42, E.41		


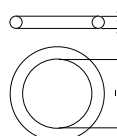
1

Part No.	504512	Ref. No.	456017
description	O-ring EPDM thickness 1.78mm ID ø 14mm Qty 1 pcs		
For models:	66, R495, R497, R499, R501, R503, R505, R507, R509, R511, R704, R706, R708, S621, S623, S624, S626, S631, S633, S634, S636, S641, S643, S651, S651P, S653, S654, S655, S810, S815, S830, S835, S850, S870, S950, SR651		

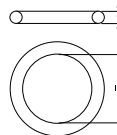
1

Part No.	511500	Ref. No.	456014
description	O-ring EPDM thickness 1.78mm ID ø 2.9mm Qty 10 pcs		
For models:	21F, 21FD, 21R, 21RD, 25F, 25FD, 25R, 25RD, 30F, 30FD, 30R, 30RD, 31F, 31FD, 31R, 31RD, 44F		

1

Part No.	528485	Ref. No.	456060
description	O-ring EPDM thickness 1.78mm ID ø 6.07mm Qty 1 pcs		
For models:	2312-007, 2312-009-CRP, 80, 81, 82, 913992, 913993, 914100, 914101, 914339, 914342, 914343, 914583, 914592, 914612, 914613, 914624, 914625, 914626, 914627, 914628, 914850, 914851, 914854, 914944, 915143, 915830, E78, Fast160DP, FAST-181, HM1, KLP105EB, KLP201DDDTTEB, KLP201EB, KLP301, KLP301DDDTTEB, LP105DDDTTEB, LP105DDDTTEBN, LP105EB, LP201DDDTTEB, LP201EB, LP301, LP301EB, NG291, NG292, NG293, NIAGARA-291, NIAGARA-292, NIAGARA-293, RIVER-294... (Other models you can see in the webshop)		

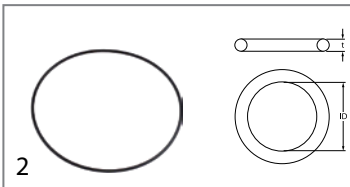



1

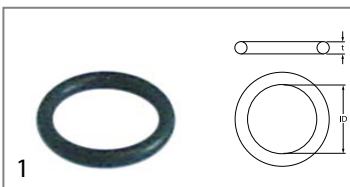
Part No.	510303	Ref. No.	456030 CGR106
description	O-ring EPDM thickness 1.78mm ID ø 6.75mm Qty 1 pcs		
For models:	050F, 050FP, 914568, 915830, E.50D.PA, E.55, E.65, F85, F85P, FAST-160DP, Fast181-230V-3Ph-60Hz, Fast181-400V-3NPh-60Hz, MINIBAR, NG292HZ, Niagara-292-400V-3Ph-60Hz, River-295P, River-296P, RIVER-40, RIVER-43, RIVER-50, RIVER-50-CRP, RIVER-61, RIVER-80, RIVER-81, RIVER-82, RV295PS, RV296PS, S280, ST70FASTHB400, U132, U61, U61E, U61H, U61HE, U70		



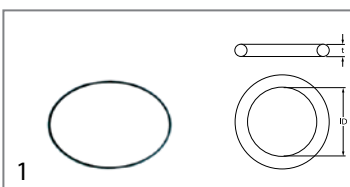

Part No.	510177	Ref. No.	456018 CGR2031
description	O-ring EPDM thickness 1.78mm ID \varnothing 7.66mm Qty 1 pcs		
For models:	10, 11F, 11FD, 11F-DVGW, 11R, 11RD, 12, 14, 161, 21F, 21FD, 21R, 21RD, 221, 22R, 25F, 25FD, 25R, 25RD, 271, 272, 30F, 30FD, 30R, 30RD, 31F, 31FD, 31R, 31RD, 362, 440F, 44F, 46, 460, 500F, 500FD, 50F, 50FD, 510F, 510FD, A4EBT, A4EBTSAK, C13, CLEAN-100, CLEAN-110, CLEAN-120, CLEAN-160, CLEAN-161, CLEAN-220, CLEAN-221...(Other models you can see in the webshop)		



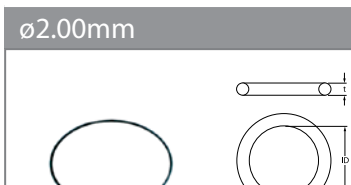
Part No.	513275	Ref. No.	456074
description	O-ring EPDM thickness 1.78mm ID \varnothing 82.27mm Qty 1 pcs		
For models:	913289, 913290, 913291, 913292, 913356, 913357, 913372, 913373, 913374, 913375, 913416, 913435, 913544, 913545, 913665, 913666, 913667, 913668, 913685, 913771, 913772, 913773, 913774, 913777, 913778, 913832, 913837, 913911, 913912, 913948, 913950, 913977, 913984, 913990, 914165, 914166, 914206, 914214, 914316, 914317, 914355, 914386, 914387, 914388, 914389, 914390, 914391, 914392, 914393, 914394, 914395, 914396...(Other models you can see in the webshop)		




Part No.	504574	Ref. No.	456019
description	O-ring EPDM thickness 1.78mm ID \varnothing 9.25mm Qty 1 pcs		
For models:	11F, 11FD, 11F-DVGW, 11R, 11RD, 44F, 913289, 913290, 913291, 913292, 913356, 913357, 913372, 913373, 913374, 913375, 913416, 913435, 913544, 913545, 913665, 913666, 913667, 913668, 913685, 913771, 913772, 913773, 913774, 913832, 913837, 913911, 913912, 913948, 913950, 913977, 913984, 913990, 914165, 914166, 914206, 914214, 914316, 914317, 914355, 914386, 914387, 914388, 914389, 914390...(Other models you can see in the webshop)		



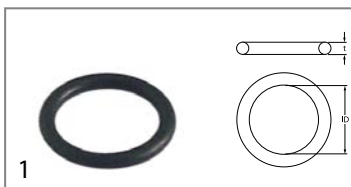
Part No.	510556	Ref. No.	456022
description	O-ring EPDM thickness 1.78mm ID \varnothing 94.97mm Qty 1 pcs pump type T110		
For models:	CLEAN-3, RIVER-43, S651, S651P, S653, S654, S655, S830, S835, SR651		



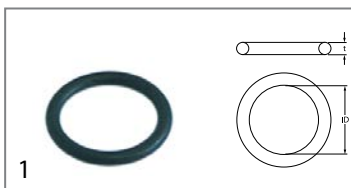
Part No.	510554	Ref. No.	456024
description	O-ring EPDM thickness 2mm ID \varnothing 120mm Qty 1 pcs		
For models:	440F, 44F, 46, 460, 500F, 500FD, 50-ELECTRONIC, 50F, 50FD, E.46, E.50, E.52, R497, R499, R501, R503, R505, R507, R509, R511, R704, R706, R708, S641, S643		



Part No.	529412	Ref. No.	456006 456048
description	O-ring EPDM thickness 2.62mm ID \varnothing 10.78mm Qty 1 pcs		
For models:	050F, 050FP, 11F, 11FD, 11F-DVGW, 11R, 11RD, 21F, 21FD, 21R, 21RD, 22F, 22R, 25F, 25FD, 25R, 25RD, 30F, 30FD, 30R, 30RD, 31F, 31FD, 31R, 31RD, 40F, 440F, 44F, 500F, 500FD, 50-ELECTRONIC, 50F, 50FD, 510F, 510FD, 55, 66, 913289, 913290, 913291, 913292, 913356, 913357, 913372, 913373, 913374, 913375, 913416, 913435, 913544...(Other models you can see in the webshop)		



Part No.	504618	Ref. No.	456026
description	O-ring EPDM thickness 2.62mm ID \varnothing 15.54mm Qty 1 pcs		
For models:	10, 12, 14, C15, CLEAN-100, CLEAN-110, CLEAN-120		



Part No.	511510	Ref. No.	456070
description	O-ring EPDM thickness 2.62mm ID \varnothing 15.54mm Qty 10 pcs		
For models:	913289, 913290, 913291, 913292, 913297, 913298, 913299, 913300, 913356, 913357, 913360, 913361, 913372, 913373, 913374, 913375, 913391, 913392, 913416, 913418, 913435, 913544, 913545, 913546, 913547, 913578, 913611, 913665, 913666, 913667, 913668, 913684, 913685, 913771, 913772, 913773, 913774, 913832, 913837, 913911, 913912, 913913, 913914, 913932, 913933, 913948, 913950, 913977, 913984, 913990...(Other models you can see in the webshop)		



Part No.	528919	Ref. No.	456010
description	O-ring EPDM thickness 2.62mm ID ϕ 20.24mm Qty 1 pcs		
For models:	11F, 11FD, 11R, 11RD, 21F, 21FD, 21R, 21RD, 25F, 25FD, 25R, 25RD, 30F, 30FD, 30R, 30RD, 31F, 31FD, 31R, 31RD, S621, S623, S624, S626, S631, S633, S634, S636, S870		

Part No.	532058	Ref. No.	456071
description	O-ring EPDM thickness 2.62mm ID ϕ 23.81mm Qty 10 pcs		
For models:	913289, 913290, 913291, 913292, 913297, 913298, 913299, 913300, 913356, 913357, 913360, 913361, 913372, 913373, 913374, 913375, 913391, 913392, 913416, 913418, 913435, 913544, 913545, 913546, 913547, 913578, 913611, 913665, 913666, 913667, 913668, 913684, 913685, 913771, 913772, 913773, 913774, 913832, 913837, 913911, 913912, 913913, 913914, 913932, 913933, 913948, 913950, 913977, 913984, 913990...(Other models you can see in the webshop)		

Part No.	504561	Ref. No.	456073
description	O-ring EPDM thickness 2.62mm ID ϕ 29.82mm Qty 1 pcs		
For models:	915150, 915151, 915152, 915154, 915155, 915157, 915158, 915160, 915161, 915162, 915166, 915167, 915168, 915172, 915173, 915175, 915176, 915177, 915285, 915319, 915338, 915341, 915348, 915418, 915419, 915420, 915421, 915422, 915479, 915492, 915493, 915494, 915495, 915496, 915497, 915547, 915558, 915611, 915612, 915613, 915614, 915615, 915616, 915617, 915618, 915635, 915663, 915670, 915671, 915672...(Other models you can see in the webshop)		

Part No.	518275	Ref. No.	456066
description	O-ring EPDM thickness 2.62mm ID ϕ 6.02mm Qty 1 pcs		

Part No.	510893	Ref. No.	456015
description	O-ring EPDM thickness 2.62mm ID ϕ 9.92mm Qty 1 pcs		
For models:	050F, 050FP, 2312-001, 2312-002, 31F, 31FD, 31R, 31RD, 500F, 500FD, 50F, 50FD, 510F, 510FD, 67F, 67R, 913297, 913298, 913299, 913300, 913360, 913361, 913363, 913364, 913376, 913377, 913391, 913392, 913418, 913546, 913547, 913578, 913611, 913684, 913913, 913914, 913932, 913933, 914167, 914168, 914284, 914318, 914319, 914326, 914331, 914338, 914356, 914398, 914399, 914400...(Other models you can see in the webshop)		

ϕ 3.53mm

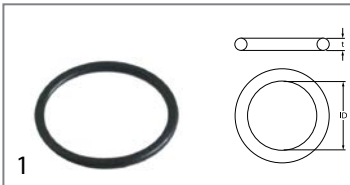
Part No.	510009	Ref. No.	456001
description	O-ring EPDM thickness 3.53mm ID ϕ 101.2mm Qty 1 pcs		
For models:	21F, 21FD, 21R, 21RD, 25F, 25FD, 25R, 25RD, 30F, 30FD, 30R, 30RD, 31F, 31FD, 31R, 31RD, 913418, 914398, 914399, 914443, E.45, S621, S623, S624, S626, S631, S633, S634, S636		

Part No.	532537	Ref. No.	456067
description	O-ring EPDM thickness 3.53mm ID ϕ 113.9mm Qty 1 pcs		
For models:	2312-007, 2312-009-CRP, 914100, 914101, 914339, 914342, 914343, 914624, 914625, 914626, 914627, 914628, 914850, 914851, 914854, 914944, PS-60, RIVER-48, RIVER-50, RIVER-50-CRP, RIVER-50-CRP-SP, RIVER-54, RIVER-54CRP, River-54-CRP-s.p., RIVER-54-CRP-SP, RIVER-61		

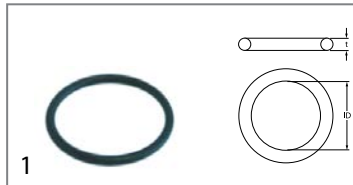
Part No.	513016	Ref. No.	929050
description	O-ring EPDM thickness 3.53mm ID ϕ 26.58mm Qty 1 pcs		
For models:	55		

Part No.	510072	Ref. No.	456016
description	O-ring EPDM thickness 3.53mm ID ϕ 32.93mm Qty 1 pcs		
For models:	050F, 050FP, 10, 11F, 11FD, 11F-DVGW, 11R, 11RD, 21F, 21FD, 21R, 21RD, 22F, 22R, 25F, 25FD, 25R, 25RD, 30F, 30FD, 30R, 30RD, 31F, 31FD, 31R, 31RD, 350F, 350FD, 350R, 350RD, 35-ELECTRONIC, 35F, 35FD, 35R, 35RD, 400F, 400FD, 400R, 400RD, 40-ELECTRONIC, 40F, 40FD, 40R, 40RD, 440F, 44F, 45, 450, 46, 460...(Other models you can see in the webshop)		

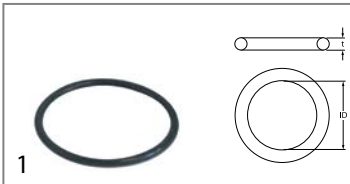
Part No.	510895	Ref. No.	456043
description	O-ring EPDM thickness 3.53mm ID ϕ 34.52mm Qty 1 pcs		

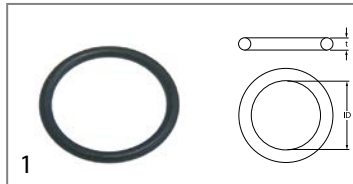
Part No.	506015	Ref. No.	456052
description	O-ring EPDM thickness 3.53mm ID ø 39.69mm Qty 1 pcs		
For models:	2312-001, 2312-002, 2312-007, 350F, 350FD, 350R, 350RD, 35-ELECTRONIC, 35F, 35FD, 35R, 35RD, 400F, 400FD, 400R, 400RD, 40-ELECTRONIC, 40F, 40FD, 40R, 40RD, 55, 913289, 913290, 913291, 913292, 913297, 913298, 913299, 913300, 913356, 913357, 913360, 913361, 913363, 913364, 913372, 913373, 913374, 913375, 913376, 913377, 913391, 913392, 913416, 913418, 913435, 913544, 913545, 913546... (Other models you can see in the webshop)		



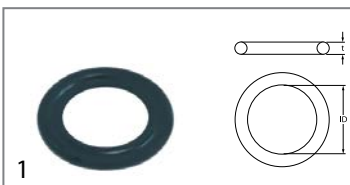
Part No.	521120	Ref. No.	456075
description	O-ring EPDM thickness 5.34mm ID ø 37.47mm Qty 1 pcs		
For models:	913289, 913290, 913291, 913292, 913356, 913357, 913363, 913364, 913372, 913373, 913374, 913375, 913376, 913377, 913416, 913418, 913435, 913544, 913545, 913665, 913666, 913667, 913668, 913685, 913771, 913772, 913773, 913774, 913832, 913837, 913911, 913912, 913948, 913950, 913977, 913984, 913990, 914165, 914166, 914167, 914168, 914206, 914214, 914316, 914317, 914355, 914386, 914387, 914388, 914389... (Other models you can see in the webshop)		



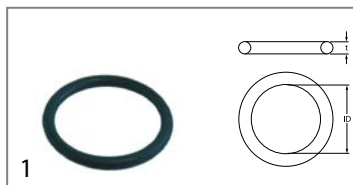
Part No.	518175	Ref. No.	456061 REB456061
description	O-ring EPDM thickness 3.53mm ID ø 49.21mm Qty 1 pcs		
For models:	913289, 913290, 913291, 913292, 913356, 913357, 913372, 913373, 913374, 913375, 913416, 913435, 913544, 913545, 913665, 913666, 913667, 913668, 913685, 913771, 913772, 913773, 913774, 913832, 913837, 913911, 913912, 913948, 913950, 913977, 913984, 913990, 914165, 914166, 914206, 914214, 914316, 914317, 914355, 914386, 914387, 914388, 914389, 914390, 914391, 914392, 914393, 914394, 914395, 914396... (Other models you can see in the webshop)		



Part No.	510408	Ref. No.	456002 456079
description	O-ring EPDM thickness 5.34mm ID ø 47mm Qty 1 pcs		
For models:	10, 12, 14, 21F, 21FD, 21R, 21RD, 22F, 22R, 25F, 25FD, 25R, 25RD, 30F, 30FD, 30R, 30RD, 31F, 31FD, 31R, 31RD, 40F, 440F, 44F, 50F, 50FD, 510F, 510FD, 66, 80, 81, 82, 913297, 913298, 913299, 913300, 913360, 913361, 913391, 913392, 913546, 913547, 913578, 913611, 913684, 913913, 913914, 913932, 913933, 913992... (Other models you can see in the webshop)		

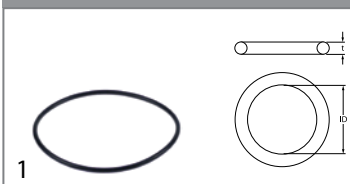


Part No.	532498	Ref. No.	456047
description	O-ring EPDM thickness 3.53mm ID ø 9.12mm Qty 1 pcs		
For models:	22F, 440F, 44F, 500F, 500FD, 50F, 50FD, 66, CLEAN-100, CLEAN-120, E.46, E100		



Part No.	510410	Ref. No.	456008
description	O-ring EPDM thickness 5.34mm ID ø 75.57mm Qty 1 pcs		
For models:	66, S651, S651P, S653, S654, S655, S810, S815, S830, S835, S850, SR651		

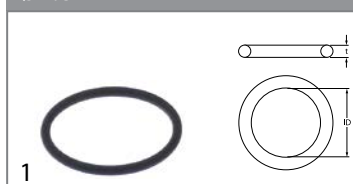
ø5.34mm



Part No.	532543	Ref. No.	456076
description	O-ring EPDM thickness 5.34mm ID ø 136.5mm Qty 1 pcs		
For models:	915150, 915151, 915152, 915154, 915155, 915157, 915158, 915160, 915161, 915162, 915166, 915167, 915168, 915172, 915173, 915175, 915176, 915177, 915285, 915319, 915338, 915341, 915348, 915418, 915419, 915420, 915421, 915422, 915479, 915492, 915493, 915494, 915495, 915496, 915497, 915547, 915558, 915635, 915663, 915747, 916020, 916021, 916024, 916025, 916026, 916027, 916030, 916031, 916045, 916054... (Other models you can see in the webshop)		

Viton

ø2.62mm



Part No.	532625	Ref. No.	456081 5037072
description	O-ring Viton thickness 2.62mm ID ø 28.25mm Qty 1 pcs		
For models:	915150, 915151, 915152, 915154, 915155, 915160, 915161, 915162, 915166, 915167, 915168, 915175, 915176, 915177, 915319, 915338, 915341, 915348, 915418, 915419, 915420, 915421, 915479, 915492, 915493, 915547, 915558, 915635, 915663, 915747, 916020, 916021, 916024, 916025, 916026, 916027, 916030, 916031, 916045, 916201, 916202, 916203, 916204, 916205, 916206, 916207, 916208, 916209, 916247, 916248... (Other models you can see in the webshop)		



ø3.53mm

Part No.	528155	Ref. No.	927337 CGR4131NT
description	O-ring Viton thickness 3.53mm ID ø 32.93mm Qty 1 pcs		
For models:	161, 221, 271, 272, 362, 915747, 915773, A3EB, A3EBDAKRKYK, A3EB-DRKYK, A3EBSAKRK, A3EBSEKWK, A4EB, A4EBDAKEKYK, A4EBDAKRK, A4EBDAKWK, A4EBDAKZK, A4EBDBKRK, A4EBDPKWKYK, A4EBDRK, A4EBSAK, A4EBSAKCK, A4EBSAKEKYK, A4EBSAKRKP, A4EBT, A4EBTSAK, A5EB, A5EBDAKYK, A5EBDRK, A5EBSAKRK, A5EBSAKRKYK, A5EBSAKWK, A5EBSAKWKYK, A5EBSBKRKP, A5EBSBKWK, A5EBSRK, CLEAN-161, CLEAN-221, CLEAN-271, CLEAN-272, CLEAN-362, Fast181, FAST-181, Fast181-230V-3Ph-60Hz, Fast181-400V-3NPh-60Hz, Fast200, Fast93, GL280EB, GL280EB23, GL280EB23DAR...(Other models you can see in the webshop)		

sealing washers

fibre gaskets

Part No.	518541	Ref. No.	437021
description	flat gasket FIBER ED ø 12mm ID ø 8mm thickness 1.5mm Qty 1 pcs		
For models:	050F, 050FP, 11R, 11RD, 12, 14, 21F, 21FD, 21R, 21RD, 22F, 22R, 25F, 25FD, 25R, 25RD, 30F, 30FD, 30R, 30RD, 31F, 31FD, 31R, 31RD, 40F, 440F, 44F, 46, 460, 500F, 500FD, 50-ELECTRONIC, 50F, 50FD, 510F, 510FD, 66, CLEAN-100, CLEAN-110, CLEAN-120, CLEAN-3, E.46, E.50, E.51, E.52, E.60, E.65, E1, E10, E100...(Other models you can see in the webshop)		

Part No.	529349	Ref. No.	437030
description	flat gasket FIBER ED ø 22mm ID ø 16.5mm thickness 2mm for thread 3/8" Qty 1 pcs		
For models:	11F, 11FD, 11R, 11RD, 2312-001, 2312-002, 55, 67F, 67R, 913297, 913298, 913299, 913300, 913360, 913361, 913391, 913392, 913418, 913546, 913547, 913578, 913611, 913684, 913932, 913933, 914326, 914331, 914398, 914399, 914400, 914401, 914402, 914403, 914404, 914405, 914406, 914443, 914449, 914517, 914545, 914568, 914688, 914979, 915140, 915248, 915483, 915484, 915528, 915537, 915538...(Other models you can see in the webshop)		

Part No.	506241	Ref. No.	CGF17
description	flat gasket FIBER ED ø 24mm ID ø 16mm thickness 2mm Qty 1 pcs		
For models:	A3EB, A3EBD, A3EBDAKRKYK, A3EBDAKWK, A3EBDBKWK, A3EB-DRKYK, A3EBDWK, A3EBDYK, A3EBSAK, A3EBSAKRK, A3EBSAKWK, A3EBSBKWKYK, A3EBSEKWK, A3EBSWK, A4EB, A4EBD, A4EBDAKEKYK, A4EBDAKRK, A4EBDAKWK, A4EBDAKZK, A4EBDBKRK, A4EBDPKWKYK, A4EBDRK, A4EBS, A4EBSAK, A4EBSAKCK, A4EBSAKEKYK, A4EBSA-KRK, A4EBSAKRKP, A4EBSAKYK, A4EBSCK, A4EBT, A4EBTSAK, A5EB, A5EBD, A5EBDAKPKWK, A5EBDAKWK, A5EBDAKYK, A5EBDRK, A5EBS, A5EBSAKPKWK, A5EBSAKRK, A5EBSAKRKYK, A5EBSAKWK, A5EBSAK-WKYK, A5EBSBKRKP, A5EBSBKWK, A5EBSRK, A5EBSYK, River-multi-2252...(Other models you can see in the webshop)		

Part No.	518393	Ref. No.	437042
description	flat gasket FIBER ED ø 24mm ID ø 17mm thickness 2mm Qty 1 pcs		
For models:	10, 11F, 11FD, 11R, 11RD, 12, 14, 21F, 21FD, 21R, 21RD, 22F, 22R, 25F, 25FD, 25R, 25RD, 30F, 30FD, 30R, 30RD, 31F, 31FD, 31R, 31RD, 40F, 440F, 44F, 500F, 500FD, 50-ELECTRONIC, 50F, 50FD, 510F, 510FD, 55, 913297, 913298, 913299, 913300, 913360, 913361, 913391, 913392, 913546, 913547, 913578, 913611, 913684, 913913...(Other models you can see in the webshop)		

Part No.	510074	Ref. No.	437025
description	flat gasket FIBER ED ø 35mm ID ø 27mm thickness 1.5mm Qty 1 pcs		
For models:	11F, 11FD, 11F-DVGW, 11R, 11RD, 2312-009-CRP, 350F, 350FD, 35-ELECTRONIC, 35F, 35FD, 400F, 400FD, 400R, 400RD, 40-ELECTRO-NIC, 40F, 40FD, 40R, 40RD, 67F, 67R, 913363, 913364, 913376, 913377, 913992, 913993, 914100, 914101, 914339, 914342, 914343, 914583, 914624, 914625, 914626, 914627, 914628, 914850, 914851, 914854, 914944, 915143, 915747, A4EBT, A4EBTSAK, CLEAN-3, E.41, E.42...(Other models you can see in the webshop)		

Part No.	510416	Ref. No.	437022
description	flat gasket fibre ED ø 19mm ID ø 10.5mm thickness 1.5mm for thread M10 Qty 1 pcs		
For models:	S621, S623, S624, S626, S631, S633, S634, S636		

Part No.	510417	Ref. No.	437002 437024
description	flat gasket fibre ED ø 20mm ID ø 14mm thickness 2mm Qty 1 pcs		
For models:	11F, 11FD, 11F-DVGW, 11R, 11RD, 12, 14, 21F, 21FD, 21R, 21RD, 22F, 22R, 25F, 25FD, 25R, 25RD, 30F, 30FD, 30R, 30RD, 31F, 31FD, 31R, 31RD, 40F, 440F, 44F, 450, 46, 460, 500F, 500FD, 50F, 50FD, 510F, 510FD, CLEAN-100, CLEAN-110, CLEAN-120, E.45, E.46, E.50, E.51, E.52, E1, E10, E100, E110, E12...(Other models you can see in the webshop)		

Part No.	510080	Ref. No.	437027
description	flat gasket fibre ED ø 44.5mm ID ø 33mm thickness 2mm Qty 1 pcs		
For models:	11F, 11FD, 11F-DVGW, 11R, 11RD, 66, 67F, 67R, 913363, 913364, 913376, 913377, E.41, E.42, E41, R495, R497, R499, R501, R503, R505, R507, R509, R511, R704, R706, R708, S651, S654, S810, S815, S830, S835, S870, S950		



1

Part No.	510405	Ref. No.	437028
description	flat gasket fibre ED ϕ 56mm ID ϕ 42mm thickness 2mm for thread 1 1/4" Qty 1 pcs		
For models:	R497, R499, R501, R503, R505, R507, R509, R511, R704, S641, S643		



1

Part No.	510081	Ref. No.	437029
description	sealing ring fibre ED ϕ 60mm ID ϕ 48mm thickness 1.5mm Qty 1 pcs		
For models:	R706, R708, S870		

rubber gaskets



1

Part No.	519547	Ref. No.	437041
description	flat gasket rubber ED ϕ 14.4mm ID ϕ 15.5mm thickness 2mm Qty 1 pcs size 3/4"		
For models:	050F, 050FP, 10, 11F, 11FD, 11F-DVGW, 11R, 11RD, 12, 14, 21F, 21FD, 21R, 21RD, 22F, 22R, 2312-001, 2312-002, 2312-007, 2312-009-CRP, 25F, 25FD, 25R, 25RD, 30F, 30FD, 30R, 30RD, 31F, 31FD, 31R, 31RD, 350F, 350FD, 350R, 350RD, 35-ELECTRONIC, 35F, 35FD, 35R, 35RD, 400F, 400FD, 400R, 400RD, 40-ELECTRONIC, 40F, 40FD, 40R, 40RD... (Other models you can see in the webshop)		



1

Part No.	510075	Ref. No.	437019
description	flat gasket rubber ED ϕ 22mm ID ϕ 13mm thickness 1.5mm Qty 1 pcs		
For models:	10, 12, 14, 22F, 22R, 2312-001, 2312-002, 350F, 350FD, 350R, 350RD, 35-ELECTRONIC, 35F, 35FD, 35R, 35RD, 400F, 400FD, 400R, 400RD, 40-ELECTRONIC, 40F, 40FD, 40R, 40RD, 44F, 45, 450, 46, 460, 67F, 67R, 913289, 913290, 913291, 913292, 913297, 913298, 913299, 913300, 913356, 913357, 913360, 913361, 913363, 913364, 913372, 913373, 913374, 913375... (Other models you can see in the webshop)		



1

Part No.	507544	Ref. No.	75402
description	flat gasket rubber ED ϕ 29mm ID ϕ 17mm thickness 1mm Qty 1 pcs		
For models:	RIVER-282, River-282-2, River-282L-2, River-282LS-2TDE, River-282S-2TDE, River-285, River-382, River-382-230V-3Ph-50Hz, River-382H, River-382L, River-382L-230V-3Ph-50Hz, River-382LNRG, River-382LTDE, River-382NRG, River-382NRG-230-3Ph-50Hz, River-382TDE, River-482, RV282DD, RV282R, RV382, RV38223TERMO, RV382AHP, RV382FUR, RV382L, RV382L23TERMO, RV382LFUR, RV382LR, RV382LS, RV382LSFUR, RV382LTX, RV382LTXR, RV382R, RV382R23TERMO, RV382RFUR, RV382S, RV382SFUR, RV382TERMO, RV382TX, RV382TXR, RV482		



1

Part No.	505397	Ref. No.	437083
description	flat gasket rubber ED ϕ 32mm ID ϕ 19.5mm thickness 1.5mm Qty 1 pcs		
For models:	913992, 913993, 914583, 914592, 914612, 914613, 914628, 914944, 915143, 915150, 915151, 915152, 915154, 915155, 915157, 915158, 915160, 915161, 915162, 915166, 915167, 915168, 915172, 915173, 915175, 915176, 915177, 915285, 915319, 915338, 915341, 915348, 915418, 915419, 915420, 915421, 915422, 915479, 915492, 915493, 915494, 915495, 915496, 915497, 915547, 915558, 915611, 915612, 915613, 915614... (Other models you can see in the webshop)		



1

Part No.	518240	Ref. No.	437078
description	flat gasket rubber ED ϕ 33mm ID ϕ 17mm thickness 1.5mm Qty 1 pcs		
For models:	2312-009-CRP, 67R, 913289, 913290, 913291, 913292, 913356, 913357, 913363, 913364, 913372, 913373, 913374, 913375, 913376, 913377, 913416, 913435, 913544, 913545, 913665, 913666, 913667, 913668, 913685, 913771, 913772, 913773, 913774, 913832, 913837, 913911, 913912, 913948, 913950, 913977, 913984, 913990, 913992, 913993, 914165, 914166, 914206, 914214, 914316, 914317, 914355, 914386, 914387, 914388... (Other models you can see in the webshop)		



1


Part No.	516261	Ref. No.	437098
description	flat gasket rubber ED ϕ 33mm ID ϕ 25mm thickness 2.5mm for air trap Qty 1 pcs		
For models:	2312-007, 913992, 913993, 914100, 914101, 914339, 914342, 914343, 914583, 914592, 914612, 914613, 914624, 914625, 914626, 914627, 914628, 914850, 914851, 914854, 914944, 915143, Fast181, FAST-181, Fast181-230V-3Ph-60Hz, Fast181-400V-3NPh-60Hz, NG271, NG291, NG292, NG292HZ, NG293, NG381, NG38123, NG38123TERMO, NG381C, NG381CDD, NG381CFUR, NG381DDHZ23, NG381DDPS, NG381DDPSHZ23, NG381HPDD, NG381L, NG381LC, NG381LCFUR, NG381LDDPS, NG381TERMO, NG381TXCDD, NIAGARA-271, NIAGARA-283, Niagara-283A... (Other models you can see in the webshop)		





1


Part No.	513059	Ref. No.	437063
description	flat gasket rubber ED ϕ 52mm ID ϕ 40mm thickness 3mm Qty 1 pcs		
For models:	050F, 050FP, 12, 14, 161, 221, 2312-001, 2312-002, 271, 272, 362, 45, 450, 46, 460, 500F, 500FD, 50-ELECTRONIC, 50F, 50FD, 510F, 510FD, 55, 913297, 913298, 913299, 913300, 913360, 913361, 913391, 913392, 913418, 913546, 913547, 913578, 913611, 913684, 913913, 913914, 913932, 913933, 914167, 914168, 914284, 914318, 914319, 914331, 914338, 914356, 914398... (Other models you can see in the webshop)		





			
1			
Part No.	510070	Ref. No.	437038
description	flat gasket rubber ED ø 61mm ID ø 41.5mm thickness 3mm Qty 1 pcs		
For models:	350F, 350FD, 350R, 350RD, 35-ELECTRONIC, 35F, 35FD, 35R, 35RD, 400F, 400FD, 400R, 400RD, 40-ELECTRONIC, 40F, 40FD, 40R, 40RD, 66, R497, R499, R501, R503, R505, R507, R509, R511, R704, R706, R708, S641, S643, S651, S651P, S653, S654, S655, S810, S815, S830, S835, S850, S870, S950, SR651		

			
2			
Part No.	518205	Ref. No.	437079 80182 reb437079
description	flat gasket rubber ED ø 61mm ID ø 47mm thickness 2mm Qty 1 pcs		
For models:	2312-007, 2312-009-CRP, 80, 81, 82, 913289, 913290, 913291, 913292, 913356, 913357, 913372, 913373, 913374, 913375, 913416, 913435, 913544, 913545, 913665, 913666, 913667, 913668, 913685, 913771, 913772, 913773, 913774, 913832, 913837, 913911, 913912, 913948, 913950, 913977, 913984, 913990, 913992, 913993, 914100, 914101, 914165, 914166, 914206, 914214, 914316, 914317, 914339, 914342, 914343...(Other models you can see in the webshop)		


			
1			
Part No.	507541	Ref. No.	437102
description	flat gasket rubber ED ø 74mm ID ø 57mm thickness 2mm Qty 1 pcs		
For models:	915150, 915151, 915152, 915154, 915155, 915157, 915158, 915160, 915161, 915162, 915166, 915167, 915168, 915172, 915173, 915175, 915176, 915177, 915285, 915319, 915338, 915341, 915348, 915418, 915419, 915420, 915421, 915422, 915479, 915492, 915493, 915494, 915495, 915496, 915497, 915547, 915558, 915617, 915618, 915635, 915663, 915672, 915747, 915773, 915774, 916020, 916021, 916024, 916025, 916026...(Other models you can see in the webshop)		


			
1			
Part No.	510071	Ref. No.	437034
description	flat gasket rubber ED ø 81mm ID ø 68mm thickness 3mm for salt tank Qty 1 pcs		
For models:	050F, 050FP, 11F, 11FD, 11R, 11RD, 2312-001, 2312-002, 2312-007, 2312-009-CRP, 31F, 31FD, 31R, 31RD, 350F, 350FD, 35-ELECTRONIC, 35F, 35FD, 400F, 400FD, 400R, 400RD, 40-ELECTRONIC, 40F, 40FD, 40R, 40RD, 45, 450, 46, 460, 500F, 500FD, 50-ELECTRONIC, 50F, 50FD, 510F, 510FD, 67F, 67R, 913289, 913290, 913291, 913292, 913297, 913298, 913299, 913300, 913356...(Other models you can see in the webshop)		


			
1			
Part No.	518294	Ref. No.	437087
description	flat gasket rubber ED ø 85mm ID ø 71mm thickness 2mm Qty 1 pcs		
For models:	2312-007, 2312-009-CRP, 914100, 914101, 914339, 914342, 914343, 914624, 914625, 914626, 914627, 914628, 914850, 914851, 914854, 914944, PS-60, RIVER-48, RIVER-50, RIVER-50-CRP, RIVER-50-CRP-SP, River-54, RIVER-54CRP, River-54-CRP-s.p., RIVER-54-CRP-SP, RIVER-61		

			
1			
Part No.	518060	Ref. No.	456040
description	gasket rubber ED ø 132mm ID ø 122mm thickness 5mm		
For models:	10, 22F, 22R, 40F, 44F, 80, 81, 82, 914326, 914406, 915729, CE78HZ23, CGL74CABT, CLEAN-100, CLEAN-110, E.52, E.55, E.60, E.65, E1, E10, E100, E110, E78, E78HP, Fast181, FAST-181, Fast181-230V-3Ph-60Hz, Fast181-400V-3NPh-60Hz, FAST-63, HM1, KLP105EB, LP105DDDTBE, LP105DDDTBEN, LP105EB, LP60, NG271, NG291, NG292, NG292HZ, NG293, NIAGARA-271, NIAGARA-283, Niagara-283A, NIAGARA-291, NIAGARA-292, Niagara-292-400V-3Ph-60Hz, NIAGARA-293, RIVER-282, River-285...(Other models you can see in the webshop)		


PTFE gaskets


			
1			
Part No.	507545	Ref. No.	437091
description	flat gasket PTFE ED ø 13mm ID ø 7mm thickness 0.65mm Qty 1 pcs		
For models:	2312-007, 2312-009-CRP, 913992, 913993, 914100, 914101, 914339, 914342, 914343, 914583, 914592, 914612, 914613, 914624, 914625, 914626, 914627, 914628, 914850, 914851, 914854, 914944, 915143, E.55, RIVER-40, RIVER-40-CRP, RIVER-43, RIVER-44, RIVER-44-CRP, RIVER-44-CRP-ST, RIVER-44CRP-ST, RIVER-48, RIVER-50, RIVER-50-CRP, RIVER-50-CRP-SP, RIVER-54, RIVER-54CRP, River-54-CRP-s.p., RIVER-54-CRP-SP, RIVER-61		

			
1			
Part No.	510012	Ref. No.	437008
description	flat gasket PTFE ED ø 16.5mm ID ø 12.5mm thickness 1.5mm Qty 1 pcs equiv. no. 437008		
For models:	11F, 11FD, 11F-DVGW, 21F, 21FD, 25F, 25FD, 30F, 30FD, 31F, 31FD, 350F, 350FD, 35-ELECTRONIC, 35F, 35FD, 400F, 400FD, 40-ELECTRONIC, 40F, 40FD, 45, 450, 67R, 913289, 913290, 913291, 913292, 913356, 913357, 913363, 913364, 913372, 913373, 913374, 913375, 913376, 913377, 913416, 913418, 913435, 913544, 913545, 913665, 913666, 913667, 913668, 913685, 913771, 913772...(Other models you can see in the webshop)		

			
1			
Part No.	513725	Ref. No.	437100
description	flat gasket PTFE ED ø 21.2mm ID ø 19mm thickness 0.5mm Qty 1 pcs		
For models:	913297, 913298, 913299, 913300, 913360, 913361, 913391, 913392, 913546, 913547, 913578, 913611, 913684, 913913, 913914, 913932, 913933, 914284, 914318, 914319, 914326, 914331, 914338, 914356, 914400, 914401, 914402, 914403, 914404, 914405, 914406, 914431, 914449, 914517, 914545, 914568, 914642, 914688, 914909, 914979, 915136, 915137, 915140, 915150, 915151, 915152, 915154, 915155, 915157, 915158...(Other models you can see in the webshop)		




			
1			
Part No.	518346	Ref. No.	437090
description	flat gasket PTFE ED ø 22mm ID ø 9.2mm thickness 1mm Qty 1 pcs equiv. no. 437090 suitable for COLGED		
For models:	2312-007, 2312-009-CRP, 913992, 913993, 914100, 914101, 914339, 914342, 914343, 914583, 914592, 914612, 914613, 914624, 914625, 914626, 914627, 914628, 914850, 914851, 914854, 914944, 915143, E.55, RIVER-40, RIVER-40-CRP, RIVER-43, RIVER-44, RIVER-44-CRP, RIVER-44-CRP-ST, RIVER-44CRP-ST, RIVER-48, RIVER-50, RIVER-50-CRP, RIVER-50-CRP-SP, RIVER-54, RIVER-54CRP, RIVER-54-CRP-s.p., RIVER-54-CRP-SP, RIVER-61		

			
1			
Part No.	518180	Ref. No.	303018
description	flat gasket PTFE ED ø 40mm ID ø 35mm thickness 3mm Qty 1 pcs equiv. no. 303018/371450-166 suitable for COLGED, HOBART		
For models:	913289, 913290, 913291, 913292, 913356, 913357, 913372, 913373, 913374, 913375, 913416, 913435, 913544, 913545, 913665, 913666, 913667, 913668, 913685, 913771, 913772, 913773, 913774, 913832, 913837, 913911, 913912, 913948, 913950, 913977, 913984, 913990, 913992, 913993, 914165, 914166, 914206, 914214, 914316, 914317, 914355, 914386, 914387, 914388, 914389, 914390, 914391, 914392, 914393, 914394...(Other models you can see in the webshop)		

shaft gaskets

v-rings

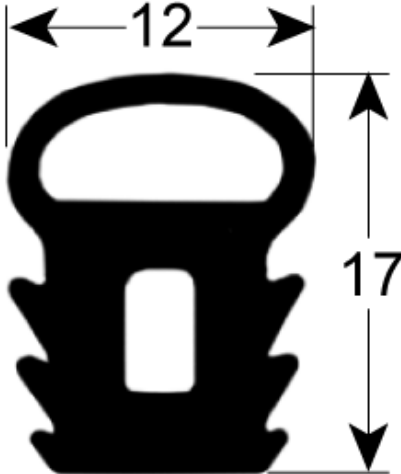
			
1			
Part No.	696554	Ref. No.	499018
description	V-ring for shaft ø 18mm ID ø 16.5mm ED ø 22mm thickness 7.5mm		
For models:	11R, 11RD, 21R, 21RD, 22R, 25R, 25RD, 30R, 30RD, 31R, 31RD, 67R, E.42, R495, R497, R499, R501, R503, R505, R507, S624, S626, S634, S636, S651, S654, S655, S815, S835		

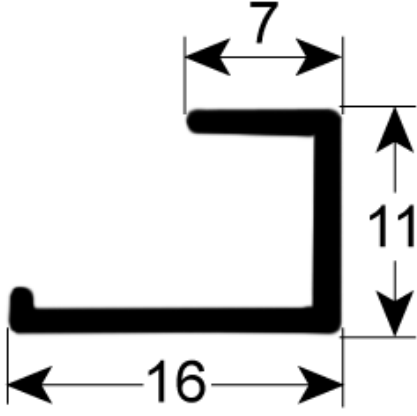
shaft gaskets

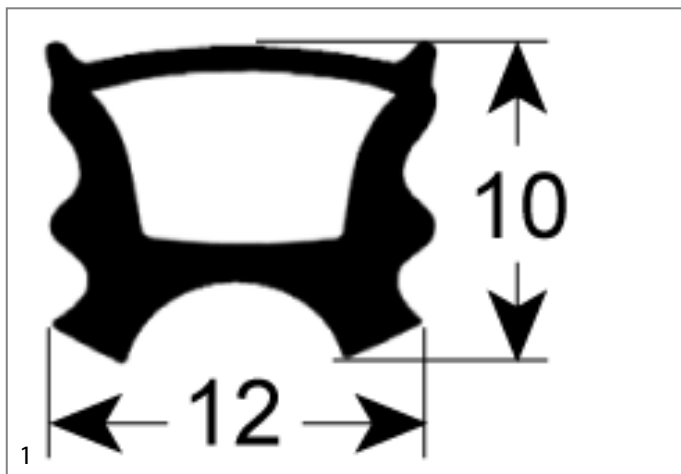
			
1			
Part No.	699128	Ref. No.	927095
description	shaft sealing ED ø 40mm ID ø 30mm H 7mm plastic for vegetable slicer		
For models:	161, 221, 271, 272, 362, CLEAN-160, CLEAN-161, CLEAN-220, CLEAN-221, CLEAN-270, CLEAN-271, CLEAN-272, CLEAN-361, CLEAN-361P, CLEAN-362, CLEAN-471, CLEAN-471P		

special gaskets

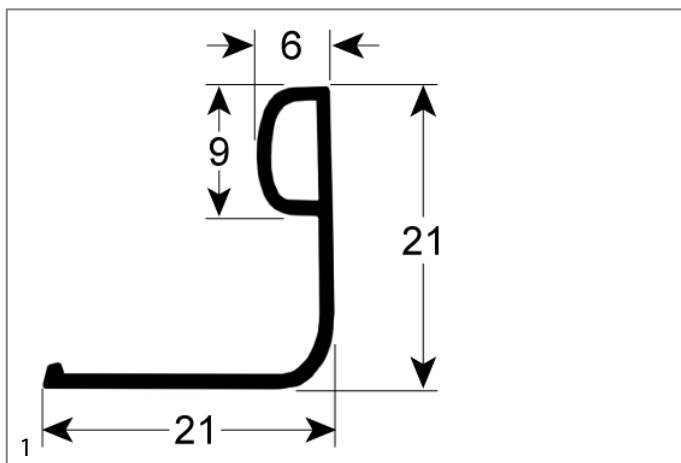
door seals for dishwashers

			
1			
Part No.	518252	Ref. No.	437071
description	door seal L 1165mm dishwasher		
For models:	913992, 913993, 914583, 914592, 914612, 914613, 915143, CLEAN-3, RIVER-40, RIVER-40-CRP, RIVER-43, RIVER-44, RIVER-44-CRP, RIVER-44-CRP-ST, RIVER-44CRP-ST		

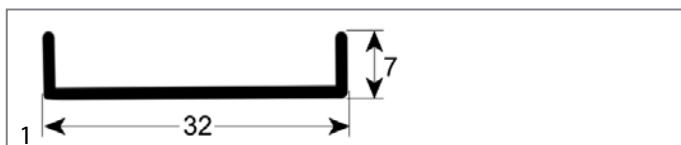
			
1			
Part No.	518248	Ref. No.	437058
description	door seal L 430mm dishwasher suitable for ELETTRORBAR, WOLK equiv. no. 437058		
For models:	400F, 400FD, 400R, 400RD, 40-ELECTRONIC, 40F, 40FD, 40R, 40RD, 67F, 67R, 913291, 913292, 913357, 913374, 913375, 913416, 913435, 913545, 913666, 913668, 913685, 913773, 913774, 913911, 913912, 913948, 913950, 913977, 913984, 913990, 914392, 914393, 914394, 914395, 914396, 914397, 914441, 914442, 914515, 914516, 914537, 914543, 914547, 914683, 914684, 914689, 914863, 915138, 915139...(Other models you can see in the webshop)		



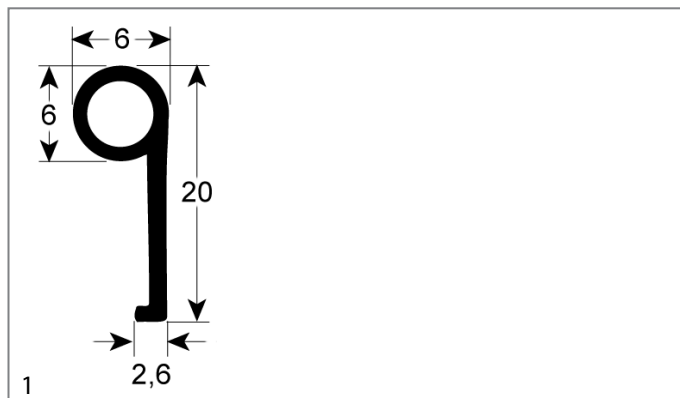
Part No.	518613	Ref. No.	437103
description	door seal L 555mm W 395mm for dishwasher 3-sided		
For models:	915150, 915151, 915152, 915154, 915155, 915157, 915158, 915160, 915161, 915162, 915166, 915167, 915168, 915172, 915173, 915175, 915176, 915177, 915285, 915319, 915338, 915341, 915348, 915418, 915419, 915420, 915421, 915422, 915479, 915492, 915493, 915494, 915495, 915496, 915497, 915547, 915558, 915635, 915663, 915747, 916054, 916067, 916068, 916069, 916079, 916080, 916201, 916202, 916203, 916204...(Other models you can see in the webshop)		



Part No.	518300	Ref. No.	437075
description	door seal L 590mm dishwasher suitable for ELETTROBAR, WOLK equiv. no. 437075		
For models:	E.65		



Part No.	518536	Ref. No.	437052 437081
description	door seal L 590mm W 32mm dishwasher suitable for ELETTROBAR, WOLK equiv. no. 437052		
For models:	050F, 050FP, 22F, 22R, 2312-001, 2312-002, 40F, 913297, 913298, 913299, 913300, 913360, 913361, 913391, 913392, 913546, 913547, 913578, 913611, 913684, 913913, 913914, 913932, 913933, 914284, 914326, 914331, 914356, 914400, 914401, 914402, 914403, 914404, 914405, 914406, 914449, 914517, 914545, 914568, 914642, 914688, 914909, 914979, 915136, 915137, 915140, 915248, 915483, 915484, 915528...(Other models you can see in the webshop)		



Part No.	902025	Ref. No.	41247MT
description	door seal W 6mm H 20mm		

miscellaneous



Part No.	511999	Ref. No.	75168
description	gasket for flange ED ø 123mm ID ø 46mm rubber thickness 3mm hole distance 53mm		
For models:	914380, 914436, A3EB, A3EBD, A3EBDAKRKYK, A3EBDAKWK, A3EBDB-KWK, A3EBDRKYK, A3EBDVK, A3EBDYK, A3EBSAK, A3EBSAKRK, A3EBSAKWK, A3EBSBKWKYK, A3EBSEKWK, A3EBSWK, A4EB, A4EBD, A4EBDAKEKYK, A4EBDAKRK, A4EBDAKWK, A4EBDAKZK, A4EBDBKRK, A4EBDPKWKYK, A4EBDRK, A4EBS, A4EBSAK, A4EBSAKCK, A4EBSA-KEKYK, A4EBSAKRK, A4EBSAKRKP, A4EBSAKYK, A4EBSCK, A4EBT, A4EBTSAK, A5EB, A5EBD, A5EBDAKPKWK, A5EBDAKWK, A5EBDAKYK, A5EBDRK, A5EBS, A5EBSAKPKWK, A5EBSAKRK, A5EBSAKRKYK, A5EBS-AKWK, A5EBSAKWKYK, A5EBSBKRPK, A5EBSBKWK, A5EBSRK...(Other models you can see in the webshop)		



Part No.	518221	Ref. No.	437072
description	gasket for lid		
For models:	CLEAN-3, RIVER-43		



Part No.	519406	Ref. No.	929209
description	gasket for sliding plate dimensions 69x16mm		



Part No.	510014	Ref. No.	437036
description	gasket suitable for HOBART equiv. no. 139321-155 L 84mm W 40mm thickness 2.5mm		
For models:	21F, 21FD, 21R, 21RD, 25F, 25FD, 25R, 25RD, 30F, 30FD, 30R, 30RD, 31F, 31FD, 31R, 31RD, S621, S623, S624, S626, S631, S633, S634, S636, S651, S651P, S653, S654, S655, S830, S835, SR651		

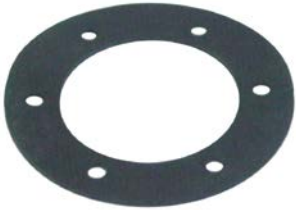


gaskets for wash arm support



1

Part No.	518008	Ref. No.	437016
description	gasket D1 \varnothing 43mm D2 \varnothing 78mm thickness 2mm with 6 holes wash arm support		
For models:	66, S651, S651P, S653, S654, S655, S810, S815, S830, S835, S850, SR651		



1

Part No.	518025	Ref. No.	437014
description	gasket D1 \varnothing 50mm D2 \varnothing 82mm thickness 2mm with 6 holes wash arm support equiv. no. 437014 suitable for COLGED		
For models:	050F, 050FP, 10, 12, 14, 22F, 22R, 2312-001, 2312-002, 40F, 440F, 44F, 45, 450, 46, 460, 500F, 500FD, 50F, 50FD, 510F, 510FD, 66, 913297, 913298, 913299, 913300, 913360, 913361, 913391, 913392, 913418, 913546, 913547, 913578, 913611, 913684, 913913, 913914, 913932, 913933, 914167, 914168, 914284, 914318, 914319, 914326, 914331, 914338, 914356...(Other models you can see in the webshop)		



1

Part No.	510054	Ref. No.	437046
description	gasket D1 \varnothing 65mm D2 \varnothing 35.5mm thickness 2.5mm with 5 holes wash arm support		
For models:	11F, 11FD, 11F-DVGW, 11R, 11RD, 67F, 67R, 913363, 913364, 913376, 913377, E.41, E.42, E.41		



1

Part No.	518339	Ref. No.	437064
description	gasket D2 \varnothing 50mm thickness 2mm with 3 screw holes wash arm support equiv. no. 437064 suitable for COLGED hole \varnothing 50mm hole distance 67mm		
For models:	050F, 050FP, 2312-001, 2312-002, 46, 460, 500F, 500FD, 50F, 50FD, 510F, 510FD, 913297, 913298, 913299, 913300, 913360, 913361, 913391, 913392, 913546, 913547, 913578, 913611, 913684, 913913, 913914, 913932, 913933, 914284, 914318, 914319, 914331, 914338, 914356, 914400, 914401, 914402, 914403, 914404, 914405, 914431, 914449, 914517, 914545, 914568, 914642, 914688, 914909, 914979...(Other models you can see in the webshop)		



1

Part No.	518402	Ref. No.	437050
description	gasket with 3 screw holes wash arm support hole distance 61mm D2 \varnothing 34mm thickness 2.5mm hole \varnothing 34mm		
For models:	22F, 22R, 40F, 440F, 44F, 914380, 914436, 915747, A3EB, A3EBD, A3EBDAKRKYK, A3EBDAKWK, A3EBDBKWK, A3EBDRKYK, A3EBDVK, A3EBDYK, A3EBSAK, A3EBSAKRK, A3EBSAKWK, A3EBSBKWKYK, A3EBSEKWK, A3EBSWK, A4EB, A4EBD, A4EBDAKEYKYK, A4EBDAKRK, A4EBDAKWK, A4EBDAKZK, A4EBDBKRK, A4EBDPKWKYK, A4EBDRK, A4EBS, A4EBSAK, A4EBSAKCK, A4EBSAKEKYK, A4EBSAKRK, A4EBSAKRKP, A4EBSAKYK, A4EBSCK, A4EBT, A4EBTSAK, A5EB, A5EBD, A5EBDAKPKWK, A5EBDAKWK, A5EBDAKYK, A5EBDRK, A5EBS, A5EBSAKPKWK, A5EBSAKRK...(Other models you can see in the webshop)		

transmission technology and ball bearings

ball bearings

deep-groove ball bearings 2RS



1

Part No.	523501	Ref. No.	314009
description	deep-groove ball bearing type 608-2RS shaft \varnothing 8mm ED \varnothing 22mm W 7mm with sealing discs deep-groove ball bearing DIN 625-1		
For models:	350F, 350FD, 350R, 350RD, 35-ELECTRONIC, 35F, 35FD, 35R, 35RD, 400F, 400FD, 400R, 400RD, 40-ELECTRONIC, 40F, 40FD, 40R, 40RD, 913289, 913290, 913291, 913292, 913356, 913357, 913372, 913373, 913374, 913375, 913416, 913435, 913544, 913545, 913665, 913666, 913667, 913668, 913685, 913771, 913772, 913773, 913774, 913832, 913837, 913911, 913912, 913948, 913950, 913977, 913984, 913990...(Other models you can see in the webshop)		



1

Part No.	523509	Ref. No.	314001
description	deep-groove ball bearing type 6201-2RS shaft \varnothing 12mm ED \varnothing 32mm W 10mm with sealing discs deep-groove ball bearing DIN 625-1		
For models:	050F, 050FP, 10, 11F, 11FD, 11F-DVGW, 11R, 11RD, 21F, 21FD, 21R, 21RD, 2312-001, 2312-002, 2312-007, 2312-009-CRP, 25F, 25FD, 25R, 25RD, 30F, 30FD, 30R, 30RD, 31F, 31FD, 31R, 31RD, 45, 450, 46, 460, 500F, 500FD, 50-ELECTRONIC, 50F, 50FD, 510F, 510FD, 67F, 67R, 913297, 913298, 913299, 913300, 913360, 913361, 913363, 913364, 913376...(Other models you can see in the webshop)		



1			
Part No.	523511	Ref. No.	314003
description	deep-groove ball bearing type 6203-2RS shaft ϕ 17mm ED ϕ 40mm W 12mm with sealing discs deep-groove ball bearing DIN 625-1		
For models:	22F, 40F, 440F, 44F, 55, 66, CLEAN-120, E.52, E12, E120, E14, E140, S651, S654, S810, S815, S830, S835, S850, S870		

springs

spring compressors

1			
Part No.	513119	Ref. No.	926009
description	spring compressor		
For models:	10, 12, 14, 80, 81, 82, CE78HZ23, CGL74CABT, CNT800CH, E100, E110, E120, E140, E78, E78HP, Fast180, Fast180-230V-3Ph-60Hz, Fast181, FAST-181, Fast181-230V-3Ph-60Hz, Fast181-400V-3NPh-60Hz, FAST-60, FAST-73, HM1, NG281, NG281CDD, NG281HP, NG281HPDD, NG281HZ23, NG281HZ23DD, NG381, NG38123, NG38123TERMO, NG381C, NG381CDD, NG381CFUR, NG381DDHZ23, NG381DDPS, NG381DDPSHZ23, NG381HPDD, NG381L, NG381LC, NG381LCFUR, NG381LDDPS, NG381TERMO, NG381TXCDD, Niagara-281, Niagara-281-2, Niagara-281HP, NIAGARA-283...(Other models you can see in the webshop)		

gas tension springs

gas tension springs

1			
Part No.	701299	Ref. No.	35070
description	gas tension spring 50N hub 150mm D1 ϕ 15mm D2 ϕ 6mm hole distance 365.5mm hole ϕ 6.5mm L 380mm		
For models:	914214, 914316, 914317, 914318, 914319, 914338, 914431, 914874, LP60, Mistral40, MISTRAL-40, Mistral51, MISTRAL-51, NG271, NG291, NIAGARA-271, NIAGARA-291, RIVER-294, RIVER-71, RV294, RV71, U60E		

roller springs

roller springs

1			
Part No.	511910	Ref. No.	927267
description	roller spring complete incl. holder W 39mm ID ϕ mm lug length 67mm		
For models:	161, 221, 271, 272, 362, CLEAN-160, CLEAN-161, CLEAN-220, CLEAN-221, CLEAN-270, CLEAN-271, CLEAN-272, CLEAN-361, CLEAN-361P, CLEAN-362, CLEAN-471, CLEAN-471P		

1			
Part No.	517449	Ref. No.	75271
description	roller spring L 95mm W 66mm		
For models:	914380, 914436, A3EB, A3EBD, A3EBDAKRKYK, A3EBDAKWK, A3EBDB-KWK, A3EBDRKYK, A3EBDVK, A3EBDYK, A3EBSAK, A3EBSAKRK, A3EBSAKWK, A3EBSBKWKYK, A3EBSEKWK, A3EBSWK, A4EB, A4EBD, A4EBDAKEKYK, A4EBDAKRK, A4EBDAKWK, A4EBDAKZK, A4EBDBKRK, A4EBDPKWYK, A4EBDRK, A4EBS, A4EBSAK, A4EBSAKCK, A4EBSA-KEYK, A4EBSAKRK, A4EBSAKRKP, A4EBSAKYK, A4EBSCK, A4EBT, A4EBTSAK, A5EB, A5EBD, A5EBDAKPKWK, A5EBDAKWK, A5EBDAKYK, A5EBDRK, A5EBS, A5EBSAKPKWK, A5EBSAKRK, A5EBSAKRKYK, A5EBS-AKWK, A5EBSAKWKYK, A5EBSBKRPK, A5EBSBKWK, A5EBSRK...(Other models you can see in the webshop)		

1			
Part No.	517452	Ref. No.	927020
description	roller spring W 38.5mm ID ϕ 24mm lug lengthmm mounting distance 22mm		
For models:	CLEAN-160, CLEAN-220, CLEAN-270, CLEAN-271, CLEAN-361, CLEAN-361P, CLEAN-471, CLEAN-471P		

1			
Part No.	517453	Ref. No.	927310
description	roller spring W 51mm ID ϕ 28mm lug lengthmm mounting distance 22mm		




mechanical components, equipment accessories




Part No.	517450	Ref. No.	77560
description	roller spring W 51mm ID Ø 31mm lug length 90mm		
For models:	A4EB, A4EBD, A4EBDAKEKYK, A4EBDAKRK, A4EBDAKWK, A4EBDAKZK, A4EBDBKRK, A4EBDPKWYK, A4EBDRK, A4EBS, A4EBSAK, A4EBS-AKCK, A4EBSAKEKYK, A4EBSAKRK, A4EBSAKRKP, A4EBSAKYK, A4EBS-SCK, A4EBT, A4EBTSAK, A5EB, A5EBD, A5EBDAKPKWK, A5EBDAKWK, A5EBDAKYK, A5EBDRK, A5EBS, A5EBSAKPKWK, A5EBSAKRK, A5EBS-AKRKYK, A5EBSAKWK, A5EBSAKWKYK, A5EBSBKRKP, A5EBSBKWK, A5EBSRK, A5EBSYK, GL284EB, GL284EBD, GL284EBDA, GL284EB-DAEW, GL284EBDAWY, GL284EBDPWY, GL284EBDR, GL284EBDY, GL284EBHZ23, GL284EBHZ23DBHZY, GL284EBHZ23DBWY, GL284EB-HZ23DBY, GL284EBHZ23DY, GL284EBHZ23SAP, GL284EBS...(Other models you can see in the webshop)		


tension springs




Part No.	701154	Ref. No.	449059 449063
description	tension spring Ø 10.5mm total length 200mm wire gauge Ø 1.3mm for door mechanism		
For models:	915160, 915161, 915162, 915166, 915167, 915168, 915172, 915173, 915175, 915176, 915177, 915285, 915319, 915338, 915341, 915348, 915418, 915419, 915420, 915421, 915422, 915479, 915496, 915497, 915547, 915558, 915635, 915663, 915747, 916054, 916068, 916069, 916080, 916205, 916206, 916207, 916208, 916209, 916365, 916366, 916367, 916368, 916414, 916415, 916416, 916417, 916422, 916423, 916424, 916684...(Other models you can see in the webshop)		




Part No.	518260	Ref. No.	449049
description	tension spring Ø 10mm total length 145mm wire gauge Ø 1mm		
For models:	2312-007, 2312-009-CRP, 67R, 913992, 913993, 914100, 914101, 914214, 914316, 914317, 914318, 914319, 914338, 914339, 914342, 914343, 914431, 914583, 914592, 914612, 914613, 914624, 914625, 914626, 914627, 914628, 914850, 914851, 914854, 914874, 914944, 915143, 915150, 915151, 915152, 915154, 915155, 915157, 915158, 915492, 915493, 915494, 915495, 916067, 916079, 916201, 916202, 916203, 916204, 916411...(Other models you can see in the webshop)		




Part No.	701227	Ref. No.	449057 H.227855 H.231937
description	tension spring Ø 10mm total length 155mm wire gauge Ø 1.1mm L1 60mm L2 11mm for door mechanism		
For models:	2312-007, 2312-009-CRP, 914100, 914101, 914339, 914342, 914343, 914624, 914625, 914626, 914627, 914628, 914850, 914851, 914854, 914944, RIVER-48, RIVER-50, RIVER-50-CRP, RIVER-50-CRP-SP, RIVER-54, RIVER-54CRP, RIVER-54-CRP-s.p., RIVER-54-CRP-SP, RIVER-61		



Part No.	513206	Ref. No.	926007
description	tension spring Ø 29.8mm total length 513mm wire gauge Ø 5.8mm		
For models:	10, 12, 14, 80, 81, 82, CE78HZ23, CGL74CABT, CLEAN-100, CLEAN-110, CLEAN-120, CNT800CH, E1, E10, E100, E110, E12, E120, E14, E140, E78, E78HP, Fast180, Fast180-230V-3Ph-60Hz, Fast181, FAST-181, Fast181-230V-3Ph-60Hz, Fast181-400V-3NPh-60Hz, FAST-60, FAST-73, HM1, Niagara-283A, PLUVIA-280, Pluvia280-230V-3PH-60HZ, PS-60, PV280, PV280FAST, PV280FAST2, PV280FAST2BIO, PV280FAST2HZ23, PV-280FASTCH, PV280FASTHB, PV280HZ23, RIVER-78, RIVER-80, RIVER-81, RIVER-81CRP, RIVER-81-CRP, RIVER-82, RIVER-82CRP...(Other models you can see in the webshop)		



Part No.	517448	Ref. No.	926108
description	tension spring Ø 30mm total length 505mm wire gauge Ø 5.5mm for hood mechanics Qty 1 pcs		
For models:	80, 81, 82, CGL74CABT, NG281, NG281CDD, NG281HP, NG281HPDD, NG281HZ23, NG281HZ23DD, NG381, NG38123, NG38123TERMO, NG381C, NG381CDD, NG381CFUR, NG381DDHZ23, NG381DDPS, NG381DDPSHZ23, NG381HPDD, NG381L, NG381LC, NG381LCFUR, NG381LDDPS, NG381TERMO, NG381TXCDD, NIAGARA-281, Niagara-281-2, Niagara-281HP, NIAGARA-283, Niagara-283L-2, Niagara-381, Niagara-381-230V-3Ph-50Hz, Niagara-381-230V-3Ph-60Hz, Niagara-381DP, Niagara-381HPD, Niagara-381L, Niagara-381LC, OC380, OC380FUR, OC380HZ23, Ocean380, RIVER-282, RIVER-282-2, RIVER-282L-2, RIVER-282LS-2TDE, RIVER-282S-2TDE, RIVER-285, RIVER-382, RIVER-382-230V-3Ph-50Hz...(Other models you can see in the webshop)		




Part No.	517451	Ref. No.	35020
description	tension spring Ø 8mm total length 150mm wire gauge Ø 1mm Qty 1 pcs		
For models:	LP60, NG271, NG291, NIAGARA-271, NIAGARA-291, RIVER-294, RIVER-71, RV294, RV71, U60E		

dosing pumps

peristaltic dosing pumps

- BORES
- built-in version
- with flow control















Part No.	361027	Ref. No.	209009
description	dosing pump BORES flow control 0.72l/h 230VAC detergent hose Ø 4x6mm hose type 361130 hose Santoprene type Perios CODE P1D		
For models:	45, 450, 46, 460		
spare parts for	361027		
	Part No.	Ref. No.	—
	pump hose Perios detergent hose Ø 4x7mm hose type Santoprene L 120mm		
	Part No.	Ref. No.	143181
	pump hose Perios detergent hose Ø 4x7mm hose type Santoprene		



Table continues overleaf





spare parts for 361027			
	Part No.	361464	Ref. No. —
roller assembly rinse aid/detergent hose type Santoprene/silicone pump type Perios			
accessories for 361027			
	Part No.	361142	Ref. No. —
mounting set detergent hose type 4x6mm hose length 2m PVC 2x hose/container filter/tank intake transparent			
	Part No.	520090	Ref. No. 143194
PVC hose ID ø 4mm ED ø 6mm L 2m thickness 1mm t.max. 60°C transparent			
	Part No.	520091	Ref. No. —
nylon hose ID ø 4mm ED ø 6mm L 2m thickness 1mm operating p. 10bar burst p. 50bar t.max. 100°C transparent			

with time control			
			
1			
Part No.	361216	Ref. No.	DWD11
description	dosing pump time control rinse aid type PD2.0 230V voltage AC hose ø 4x6mm hose silicone		

GERMAC			
built-in version			
without control			
			
1			
Part No.	361022	Ref. No.	209014
description	dosing pump GERMAC without control 2l/h 230VAC detergent hose ø 4x6mm hose thermoplastic type G200 built-in version dimensions 55x70x88mm		
spare parts for	361022		
	Part No.	361263	Ref. No. —
roller assembly GERMAC suitable for G80/82/150/152/200/202/250 /252/600			
	Part No.	361554	Ref. No. —
pump hose GERMAC detergent hose type thermoplastic hose ø 5x8mm for model G200/G250/G252			
accessories for	361022		
	Part No.	520090	Ref. No. 143194
PVC hose ID ø 4mm ED ø 6mm L 2m thickness 1mm t.max. 60°C transparent			
	Part No.	520091	Ref. No. —
nylon hose ID ø 4mm ED ø 6mm L 2m thickness 1mm operating p. 10bar burst p. 50bar t.max. 100°C transparent			

SEKO			
built-in version			
with frequency control			
			
1			
Part No.	361767 ¹	Ref. No.	209021
description	dosing pump SEKO 3l/h 230VAC detergent hose ø 4x6mm hose type K hose Santoprene suction level 1.5m type NBR 3 8W built-in version peristaltic pump		
For models:	913291, 913292, 913297, 913298, 913299, 913300, 913357, 913360, 913361, 913363, 913364, 913374, 913375, 913376, 913377, 913391, 913392, 913416, 913418, 913435, 913545, 913546, 913547, 913578, 913611, 913666, 913668, 913684, 913685, 913773, 913774, 913911, 913912, 913913, 913914, 913932, 913933, 913948, 913950, 913977, 913984, 913990, 913992, 913993, 914100, 914101, 914165, 914166, 914167, 914168...(Other models you can see in the webshop)		
spare parts for	361767		
	Part No.	361815	Ref. No. —
pump hose detergent hose ø 6x10mm hose ø 4x6mm hose type K hose Santoprene type SEKO			

¹incl. inlet and conveyor hose


			
1			
Part No.	361948	Ref. No.	209029 209038
description	dosing pump SEKO frequency control 3l/h 230VAC detergent hose ø 4x6mm hose type L hose Santoprene suction level 1.5m type NBR 3		
For models:	913363, 913364, 915160, 915161, 915162, 915175, 915319, 915479, 915611, 915612, 915613, 915614, 915615, 915616, 915635, 915663, 915670, 915671, 915686, 915687, 915688, 915689, 915690, 915691, 915692, 915693, 915694, 915695, 915696, 915697, 915698, 915699, 915700, 915701, 915702, 915747, 915756, 915799, 915800, 915819, 915830, 915959, 916162, 916237, 916238, 916239, 916240, 916241, 916242, 916243...(Other models you can see in the webshop)		
spare parts for	361948		
	Part No.	362004	Ref. No. 143267
dosing hose SEKO detergent hose ø 6x9mm hose length 138mm hose ø 4x6mm hose type L hose Santoprene			



without control



1

Part No.	361902	Ref. No.	209028 209039 999296
description	dosing pump SEKO 31/h 230VAC detergent hose ø 4x6mm hose type L hose Santoprene suction level 1.5m type NPG 3		
For models:	915154, 915155, 915157, 915158, 915172, 915173, 915285, 915422, 915492, 915493, 915494, 915495, 915496, 915497, 915617, 915618, 915672, 915773, 915774, 916020, 916021, 916024, 916025, 916026, 916027, 916030, 916031, 916045, 916054, 916066, 916067, 916068, 916069, 916077, 916078, 916079, 916080, 916181, 916183, 916184, 916185, 916196, 916197, 916198, 916199, 916200, 916201, 916202, 916203, 916204...(Other models you can see in the webshop)		
spare parts for	361902		
	Part No.	362004	Ref. No. 143267
	dosing hose SEKO detergent hose ø 6x9mm hose length 138mm hose ø 4x6mm hose type L hose Santoprene		

spare parts



1

Part No.	698712	Ref. No.	143219 143258
description	dosing hose SEKO detergent hose ø 4x8.6mm hose ø 4x6mm hose type H hose Santoprene		
For models:	2312-001, 2312-002, 2312-007, 2312-009-CRP, 913289, 913290, 913291, 913292, 913297, 913298, 913299, 913300, 913356, 913357, 913360, 913361, 913372, 913373, 913374, 913375, 913391, 913392, 913416, 913418, 913435, 913544, 913545, 913546, 913547, 913578, 913611, 913665, 913666, 913667, 913668, 913684, 913685, 913771, 913772, 913773, 913774, 913832, 913837, 913911, 913912, 913913, 913914, 913932, 913933, 913948...(Other models you can see in the webshop)		

piston pumps

spare parts



1

Part No.	361113	Ref. No.	201002
description	solenoid coil 230VAC for type DB2		
For models:	10, 11F, 11FD, 11F-DVGW, 11R, 11RD, 12, 21F, 21FD, 21R, 21RD, 22F, 22R, 25F, 25FD, 25R, 25RD, 30F, 30FD, 30R, 30RD, 31F, 31FD, 31R, 31RD, 350F, 350FD, 350R, 350RD, 35-ELECTRONIC, 35F, 35FD, 35R, 35RD, 400F, 400FD, 400R, 400RD, 40-ELECTRONIC, 40F, 40FD, 40R, 40RD, 440F, 44F, 45, 450, 46, 460, 500F...(Other models you can see in the webshop)		



1

Part No.	361365	Ref. No.	201020
description	solenoid coil 230VAC for type EV1		
For models:	10, 11F, 11FD, 11F-DVGW, 11R, 11RD, 12, 14, 21F, 21FD, 21R, 21RD, 22F, 22R, 25F, 25FD, 25R, 25RD, 30F, 30FD, 30R, 30RD, 31F, 31FD, 31R, 31RD, 40F, 440F, 44F, 46, 460, 66, CLEAN-100, CLEAN-110, CLEAN-120, CLEAN-3, E.45, E.46, TF-503, TF-513, TF-515		



1

Part No.	510298	Ref. No.	144012 144026
description	lip valve dosing pump suitable for DB2/DS5		
For models:	050F, 050FP, 2312-007, 913992, 913993, E.35, E.35H, E.40, E.40H, E.50, E.51, E.55, F85, F85P, LF50, LF55, MC201CL, MC501E, MC501EP, MC501S, MC501SP, MINIBAR, MISTRAL-51, NIAGARA-40, NIAGARA-51, RIVER-40, RIVER-50, RIVER-61, S280		


membrane dosing pumps

self-priming

SEKO










1

Part No.	361364 ¹	Ref. No.	209025 926278 DWD3
description	dosing pump type DIB5E self-sucking rinse aid pump rate 0-5cm ³ per stroke pressure connection ø 4x6mm suction connection ø 4x6mm SEKO supporting pressure closed		
For models:	80, 81, 82, 913291, 913292, 913297, 913298, 913299, 913300, 913357, 913360, 913361, 913374, 913375, 913391, 913392, 913416, 913418, 913435, 913545, 913546, 913547, 913578, 913611, 913666, 913668, 913684, 913685, 913773, 913774, 913911, 913912, 913913, 913914, 913932, 913933, 913948, 913950, 913977, 913984, 913990, 913992, 913993, 914100, 914101, 914167, 914168, 914214, 914284, 914316...(Other models you can see in the webshop)		
spare parts for	361364		
	Part No.	361301	Ref. No. —
	hose connector for type DIB3E/DIB5E		
	Part No.	361302	Ref. No. —
	valve bush for type DIB3E/DIB5E		
	Part No.	361304	Ref. No. 456042
	O-ring EPDM ID ø 11.11mm thickness 1.78mm Qty 1 pcs for type DIB3E/DIB5E		


¹auxiliary pressure connection closed
Table continues overleaf



spare parts for 361364				
	Part No.	361305	Ref. No.	—
	valve disc for type DIB3E/DIB5E DIB3P/DIB5P			
	Part No.	361306	Ref. No.	—
	membrane for type DIB3E/DIB5E ø 49mm hole ø 5mm			
	Part No.	361307	Ref. No.	—
	membrane dosing pump ø 68mm hole ø 6mm for type DIB3P/DIB5P			
	Part No.	361459	Ref. No.	—
	hose connector ø 6mm for dosing pump			
	Part No.	361481	Ref. No.	—
	lip valve for type DIB3P/DIB5P DIB3E/DIB5E			
accessories for 361364				
	Part No.	361240	Ref. No.	—
	hose connector 1-way hose ø 6mm plastic connection M10x1			
	Part No.	361241	Ref. No.	—
	hose connector 1-way hose ø 9mm plastic connection M10x1			


various


spare parts


	1			
Part No.	510298	Ref. No.	144012 144026	
description	lip valve dosing pump suitable for DB2/DS5			
For models:	050F, 050FP, 2312-007, 913992, 913993, E.35, E.35H, E.40, E.40H, E.50, E.51, E.55, F85, F85P, LF50, LF55, MC201CL, MC501E, MC501EP, MC501S, MC501SP, MINIBAR, MISTRAL-51, NIAGARA-40, NIAGARA-51, River-40, RIVER-50, RIVER-61, S280			

self-priming with supporting pressure

	1			
Part No.	361362	Ref. No.	209985 987023	
description	dosing pump rinse aid pressure connection ø 6mm pressure connection 6			
For models:	050F, 050FP, 2312-001, 2312-002, 2312-007, 2312-009-CRP, 913289, 913290, 913356, 913372, 913373, 913544, 913665, 913667, 913771, 913772, 913832, 913837, 913992, 913993, 914165, 914166, 914206, 914339, 914342, 914343, 914355, 914386, 914387, 914388, 914389, 914390, 914391, 914626, 914692, 914693, 914694, 914703, 914870, 915686, 915687, 915688, 915689, 915690, 915691, E.35, E.35-Elettrobar, E.35H, E.35H-Elettrobar, E.40...(Other models you can see in the webshop)			
spare parts for 361362				
	Part No.	361363	Ref. No.	199012
	membrane			


spare parts for 361362				
	Part No.	510298	Ref. No.	144012 144026
	lip valve dosing pump suitable for DB2/DS5			

	1			
Part No.	510298	Ref. No.	144012 144026	
description	lip valve dosing pump suitable for DB2/DS5			
For models:	050F, 050FP, 2312-007, 913992, 913993, E.35, E.35H, E.40, E.40H, E.50, E.51, E.55, F85, F85P, LF50, LF55, MC201CL, MC501E, MC501EP, MC501S, MC501SP, MINIBAR, MISTRAL-51, NIAGARA-40, NIAGARA-51, River-40, RIVER-50, RIVER-61, S280			

	1			
Part No.	361363	Ref. No.	199012	
description	membrane			
For models:	050F, 050FP, 2312-007, 913289, 913290, 913356, 913372, 913373, 913544, 913665, 913667, 913771, 913772, 913832, 913837, 913992, 913993, 914165, 914166, 914206, 914339, 914342, 914343, 914355, 914386, 914387, 914388, 914389, 914390, 914391, 914626, 914692, 914693, 914694, 914703, 914870, 915686, 915687, 915688, 915689, 915690, 915691, E.35, E.35-Elettrobar, E.35H, E.35H-Elettrobar, E.40, E.40H, E.50, E.51...(Other models you can see in the webshop)			

GERMAC

spare parts

	1			
Part No.	510298	Ref. No.	144012 144026	
description	lip valve dosing pump suitable for DB2/DS5			
For models:	050F, 050FP, 2312-007, 913992, 913993, E.35, E.35H, E.40, E.40H, E.50, E.51, E.55, F85, F85P, LF50, LF55, MC201CL, MC501E, MC501EP, MC501S, MC501SP, MINIBAR, MISTRAL-51, NIAGARA-40, NIAGARA-51, River-40, RIVER-50, RIVER-61, S280			



SEKO



1			
Part No.	362013	Ref. No.	929198
description	dosing pump type DIB P with auxiliary pressure connection for dishwashers pump rate 0-3cm ³ per stroke pressure connection ø 4x6mm suction connection ø 4x6mm auxiliary pressure connection 10mm SEKO		
For models:	914583, 914628, 914944, 915143, 915611, 915612, 915613, 915614, 915615, 915616, 915670, 915671, 915959, KLP105EB, KLP201DDDDTEB, KLP201EB, LP105DDDDTEB, LP105DDDDTEBN, LP105EB, LP201DDDDTEB, LP201EB, LP60, NIAGARA-241, PLUVIA-240, River-44-CRP-ST, RIVER-44CRP-ST, RIVER-54CRP, River-54-CRP-s.p., River-81CRP, RIVER-81-CRP, River-82CRP, RIVER-82-CRP, RV81CCRP, RV81CRP, RV82CCRP, RV82CRP, U132, U60E, U61, U61E, U61H, U61HE, U70, U70e		

accessories

container filters



1			
Part No.	513043	Ref. No.	121017
description	container filter hose ø 4mm		
For models:	050F, 050FP, 10, 12, 14, 22F, 22R, 2312-001, 2312-002, 2312-007, 2312-009-CRP, 31F, 31FD, 31R, 31RD, 350F, 350FD, 350R, 350RD, 35-ELECTRONIC, 35F, 35FD, 35R, 35RD, 400F, 400FD, 400R, 400RD, 40-ELECTRONIC, 40F, 40FD, 40R, 40RD, 440F, 44F, 45, 450, 46, 460, 500F, 500FD, 50-ELECTRONIC, 50F, 50FD, 510F, 510FD, 55, 66, 67F, 67R...(Other models you can see in the webshop)		



1			
Part No.	361141	Ref. No.	121075
description	container filter with weight ceramic hose ø 4mm		
For models:	2312-001, 2312-002, 2312-007, 2312-009-CRP, 31F, 31FD, 31R, 31RD, 913289, 913290, 913291, 913292, 913297, 913298, 913299, 913300, 913356, 913357, 913360, 913361, 913363, 913364, 913372, 913373, 913374, 913375, 913376, 913377, 913391, 913392, 913416, 913418, 913435, 913544, 913545, 913546, 913547, 913578, 913611, 913665, 913666, 913667, 913668, 913684, 913685, 913771, 913772, 913773, 913774, 913832...(Other models you can see in the webshop)		

intake lances



1			
Part No.	698713	Ref. No.	999257
description	intake lance plastic L 380mm with plug tube ø 9mm hose ø 5mm cable length 1500mm		

hoses

PVC hoses



1			
Part No.	520090	Ref. No.	143194
description	PVC hose ID ø 4mm ED ø 6mm L 2m thickness 1mm t.max. 60°C transparent		
For models:	2312-001, 2312-002, 2312-007, 2312-009-CRP, 31F, 31FD, 31R, 31RD, 67F, 67R, 913289, 913290, 913291, 913292, 913297, 913298, 913299, 913300, 913356, 913357, 913360, 913361, 913363, 913364, 913372, 913373, 913374, 913375, 913376, 913377, 913391, 913392, 913416, 913418, 913435, 913544, 913545, 913546, 913547, 913578, 913611, 913665, 913666, 913667, 913668, 913684, 913685, 913771, 913772, 913773...(Other models you can see in the webshop)		

accessories for	520090			
	Part No.	361058	Ref. No.	—
	description	container filter with non-return valve SS hose ø 4x6mm ø 20mm L 56mm		
	Part No.	361066	Ref. No.	—
	description	container filter straight SS hose ø 4x6mm L 37mm non return valve ball valve		
	Part No.	361106	Ref. No.	—
	description	container filter with weight and non-return valve SS hose ø 4x6mm ø 21mm L 51mm non return valve lip valve		
	Part No.	361141	Ref. No.	121075
	description	container filter with weight ceramic hose ø 4mm		
	Part No.	361230	Ref. No.	—
	description	container filter with weight stainless steel hose ø 4x6mm		
	Part No.	361462	Ref. No.	121993
	description	container filter with weight SS hose ø 4x6mm		
	Part No.	361728	Ref. No.	—
	description	container filter with 4m 4x6 hose SS hose ø 4x6mm hose length 4000mm		



miscellaneous



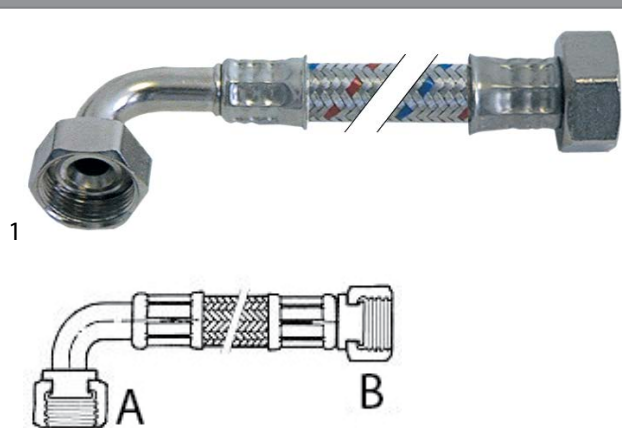
Part No.	521735	Ref. No.	466005
description	spacer piece for rinse aid pump		
For models:	2312-007, 2312-009-CRP, 913289, 913290, 913356, 913372, 913373, 913544, 913665, 913667, 913771, 913772, 913832, 913837, 913992, 913993, 914165, 914166, 914206, 914339, 914342, 914343, 914355, 914386, 914387, 914388, 914389, 914390, 914391, 914626, 914692, 914693, 914694, 914703, 914870, 915686, 915687, 915688, 915689, 915690, 915691, E.35, E.35-Elettrobar, E.35H, E.35H-Elettrobar, E.40, E.40H, FAST-135, FAST-135CT, FAST-135D...(Other models you can see in the webshop)		


hoses

supply hoses

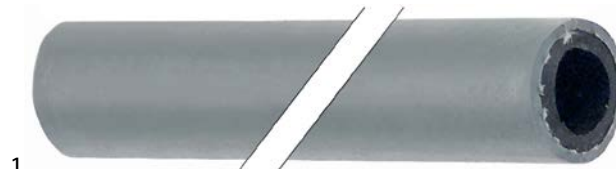
stainless steel flexi hoses


universal hoses



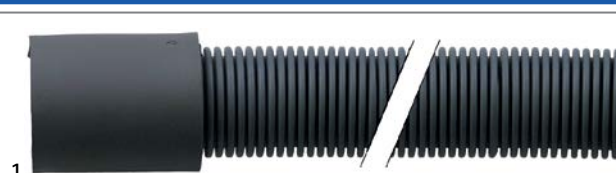
Part No.	520008	Ref. No.	143016 143112
description	flex hose SS braid straight-curved DN12 connection 1: 3/4" connection 2: 3/4" L 1500mm operating p. 10bar test pressure 32bar burst p. 95bar		
For models:	10, 12, 14, 22F, 22R, 40F, 44F, 66, 913363, 913364, 913992, 913993, 914592, 914612, 914613, 916045, CLEAN-100, CLEAN-110, CLEAN-120, E.52, E1, E10, E100, E110, E12, E120, E14, E140, E41, Ocean360-UK, River-40, River-44, S651, S654, S810, S815, S830, S835, S850, S870, S950, TF-503, TF-513, TF-515		
accessories for	520008		
	Part No.	520054	Ref. No. —
	flat gasket rubber ED ø 23.5mm ID ø 14mm thickness 2.3mm Qty 10 pcs		

PVC supply hoses



Part No.	520015	Ref. No.	143004
description	supply hose ID ø 10mm ED ø 17mm L 5m operating p. 20bar burst p. 60bar t.max. 95°C grey Qty 5m		
For models:	050F, 050FP, 10, 11F, 11FD, 11F-DVGW, 11R, 11RD, 12, 14, 21F, 21FD, 21R, 21RD, 22F, 22R, 2312-001, 2312-002, 2312-007, 2312-009-CRP, 25F, 25FD, 25R, 25RD, 30F, 30FD, 30R, 30RD, 31F, 31FD, 31R, 31RD, 350F, 350FD, 350R, 350RD, 35-ELECTRONIC, 35F, 35FD, 35R, 35RD, 400F, 400FD, 400R, 400RD, 40-ELECTRONIC, 40F, 40FD, 40R, 40RD...(Other models you can see in the webshop)		
accessories for	520015		
	Part No.	504377	Ref. No. —
	hose connector grommet ø 23mm grommet length 25mm total length 55mm for water filling		


drain hoses



Part No.	513718	Ref. No.	143120
description	drain hose DN19 L 1500mm straight ø inside 24mm straight ext. ø 28mm outer hose ø 23mm		
For models:	11F, 11FD, 11F-DVGW, 11R, 11RD, 21F, 21FD, 21R, 21RD, 25F, 25FD, 25R, 25RD, 30F, 30FD, 30R, 30RD, 31F, 31FD, 31R, 31RD, 350F, 350FD, 350R, 350RD, 35-ELECTRONIC, 35F, 35FD, 35R, 35RD, 400F, 400FD, 400R, 400RD, 40-ELECTRONIC, 40F, 40FD, 40R, 40RD, 67F, 67R, 913289, 913290, 913291, 913292, 913356, 913357, 913363, 913364, 913372...(Other models you can see in the webshop)		




Part No.	518068	Ref. No.	143136 929200
description	drain hose DN34 L 2000mm elbow ø inside 50mm elbow ext. ø 59mm inner hose ø 35mm outer hose ø 42mm PVC		
For models:	10, 12, 14, 22F, 22R, 40F, 44F, 80, 81, 82, 914326, 914406, 915729, CE78HZ23, CGL74CABT, CLEAN-100, CLEAN-110, CLEAN-120, E.55, E.60, E.65, E1, E10, E100, E110, E12, E120, E14, E140, E78, E78HP, Fast181, FAST-181, Fast181-230V-3Ph-60Hz, Fast181-400V-3NPh-60Hz, FAST-63, HM1, KLP105EB, LP105DDDTTEB, LP105DDDTTEBN, LP105EB, LP60, NG271, NG291, NG292, NG292HZ, NG293, NIAGARA-271, NIAGARA-283, Niagara-283A...(Other models you can see in the webshop)		


1

Part No.	518518	Ref. No.	143178
description	drain hose DN19 L 1500mm A int. ø 21mm A ext. ø 27mm B int. ø 29mm B ext. ø 35mm outer hose ø 25mm		



1

Part No.	513258	Ref. No.	127044
description	drain hose DN19 L 270mm A int. ø 22mm A ext. ø 28mm B int. ø 24mm B ext. ø 28mm outer hose ø 22mm		
For models:	2312-001, 2312-002, 913297, 913298, 913299, 913300, 913360, 913361, 913391, 913392, 913546, 913547, 913578, 913611, 913684, 913913, 913914, 913932, 913933, 914284, 914318, 914319, 914331, 914338, 914356, 914400, 914401, 914402, 914403, 914404, 914405, 914431, 914449, 914517, 914545, 914568, 914642, 914688, 914909, 914979, 915136, 915137, 915140, 915248, 915483, 915484, 915528, 915537, 915538, 915539...(Other models you can see in the webshop)		



1

Part No.	518219	Ref. No.	127037
description	drain hose DN19 L 630mm A int. ø 20mm A ext. ø 27mm B int. ø 21mm B ext. ø 28mm outer hose ø 24mm		
For models:	2312-001, 2312-002, 2312-007, 2312-009-CRP, 913297, 913298, 913299, 913300, 913360, 913361, 913391, 913392, 913546, 913547, 913578, 913611, 913684, 913913, 913914, 913932, 913933, 913992, 913993, 914100, 914101, 914284, 914318, 914319, 914326, 914331, 914338, 914339, 914342, 914343, 914356, 914400, 914401, 914402, 914403, 914404, 914405, 914406, 914431, 914449, 914517, 914545, 914568, 914624, 914625, 914626...(Other models you can see in the webshop)		




1

Part No.	530819	Ref. No.	143137
description	drain hose DN20 L 2500mm straight ø inside 19mm straight ext. ø 24mm elbow ø inside 22mm elbow ext. ø 27mm outer hose ø 24mm		
For models:	050F, 050FP, 21F, 21FD, 21R, 21RD, 22F, 22R, 25F, 25FD, 25R, 25RD, 30F, 30FD, 30R, 30RD, 31F, 31FD, 31R, 31RD, 40F, 440F, 44F, 45, 450, 46, 460, 500F, 500FD, 50-ELECTRONIC, 50F, 50FD, 510F, 510FD, 913289, 913290, 913291, 913292, 913356, 913357, 913363, 913364, 913372, 913373, 913374, 913375, 913376, 913377, 913416, 913418...(Other models you can see in the webshop)		



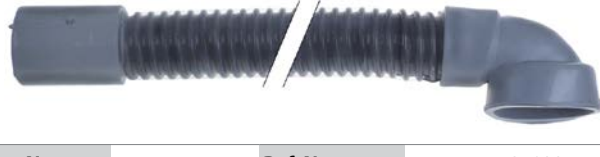
1

Part No.	518638	Ref. No.	143252
description	drain hose DN24 L 1700mm straight ø inside 28mm straight ext. ø 34mm elbow ø inside 28mm elbow ext. ø 34mm outer hose ø 30mm		
For models:	915150, 915151, 915152, 915154, 915155, 915160, 915161, 915162, 915166, 915167, 915168, 915175, 915176, 915177, 915319, 915338, 915341, 915348, 915418, 915419, 915420, 915421, 915479, 915492, 915493, 915547, 915558, 915635, 915663, 915747, 916020, 916021, 916024, 916025, 916026, 916027, 916030, 916031, 916045, 916201, 916202, 916203, 916204, 916205, 916206, 916207, 916208, 916209, 916247, 916248...(Other models you can see in the webshop)		



1

Part No.	506208	Ref. No.	143183
description	drain hose DN25 L 1500mm straight ø inside 25mm straight ext. ø 30mm elbow ø inside 40mm elbow ext. ø 46mm outer hose ø 32mm		
For models:	22F, 440F, 44F, E.52		




1

Part No.	518078	Ref. No.	127032
description	drain hose DN34 L 500mm straight ø inside 40mm straight ext. ø 48mm elbow ø inside 50mm elbow ext. ø 58mm outer hose ø 42mm		
For models:	22F, 440F, 44F, E.52, E1, E10, E100, E110, E12, E120, E14, E140		

industrial hoses

Niplaflex hoses



1

Part No.	530562	Ref. No.	143010
description	pressure hose ID ø 13mm ED ø 21mm L 5m operating p. 10bar burst p. 30bar t.max. 110°C		
For models:	161, 221, 271, 272, 362, 80, 81, 82, 914380, 914436, 915747, A3EB, A3EBD, A3EBDAKRKYK, A3EBDAKWK, A3EBDBKWK, A3EBDRKYK, A3EBDVK, A3EBDYK, A3EBSAK, A3EBSAKRK, A3EBSAKWK, A3EBSB-KWKYK, A3EBSEKWK, A3EBSWK, A4EB, A4EBD, A4EBDAKEYK, A4EBDAKRK, A4EBDAKWK, A4EBDAKZK, A4EBDBKWK, A4EBDPKWKYK, A4EBDRK, A4EBS, A4EBSAK, A4EBSAKCK, A4EBSAKEKYK, A4EBSA-KRK, A4EBSAKRKP, A4EBSAKYK, A4EBSCK, A4EBT, A4EBTSAK, A5EB, A5EBD, A5EBDAKPKWK, A5EBDAKWK, A5EBDAKYK, A5EBDRK...(Other models you can see in the webshop)		



PVC hoses

PVC hoses without fabric



Part No.	520383	Ref. No.	H.775601
description	PVC hose ID ø 4mm ED ø 6mm L 2m thickness 1mm t.max. 60°C blue		
For models:	913291, 913292, 913297, 913298, 913299, 913300, 913357, 913360, 913361, 913363, 913364, 913374, 913375, 913391, 913392, 913416, 913418, 913435, 913545, 913546, 913547, 913578, 913611, 913666, 913668, 913684, 913685, 913773, 913774, 913911, 913912, 913913, 913914, 913932, 913933, 913948, 913950, 913977, 913984, 913990, 914214, 914284, 914316, 914317, 914318, 914319, 914326, 914331, 914338, 914356...(Other models you can see in the webshop)		

accessories for	520383		
	Part No.	Ref. No.	
	361058		—
	container filter with non-return valve SS hose ø 4x6mm ø 20mm L 56mm		
	Part No.	Ref. No.	
	361066		—
	container filter straight SS hose ø 4x6mm L 37mm non return valve ball valve		
	Part No.	Ref. No.	
	361106		—
	container filter with weight and non-return valve SS hose ø 4x6mm ø 21mm L 51mm non return valve lip valve		
	Part No.	Ref. No.	
	361141		121075
	container filter with weight ceramic hose ø 4mm		
	Part No.	Ref. No.	
	361230		—
	container filter with weight stainless steel hose ø 4x6mm		
	Part No.	Ref. No.	
	361462		121993
	container filter with weight SS hose ø 4x6mm		
	Part No.	Ref. No.	
	361728		—
	container filter with 4m 4x6 hose SS hose ø 4x6mm hose length 4000mm		



Part No.	520090	Ref. No.	143194
description	PVC hose ID ø 4mm ED ø 6mm L 2m thickness 1mm t.max. 60°C transparent		
For models:	2312-001, 2312-002, 2312-007, 2312-009-CRP, 31F, 31FD, 31R, 31RD, 67F, 67R, 913289, 913290, 913291, 913292, 913297, 913298, 913299, 913300, 913356, 913357, 913360, 913361, 913363, 913364, 913372, 913373, 913374, 913375, 913376, 913377, 913391, 913392, 913416, 913418, 913435, 913544, 913545, 913546, 913547, 913578, 913611, 913665, 913666, 913667, 913668, 913684, 913685, 913771, 913772, 913773...(Other models you can see in the webshop)		

accessories for	520090		
	Part No.	Ref. No.	
	361058		—
	container filter with non-return valve SS hose ø 4x6mm ø 20mm L 56mm		
	Part No.	Ref. No.	
	361066		—
	container filter straight SS hose ø 4x6mm L 37mm non return valve ball valve		
	Part No.	Ref. No.	
	361106		—
	container filter with weight and non-return valve SS hose ø 4x6mm ø 21mm L 51mm non return valve lip valve		

accessories for	520090		
	Part No.	Ref. No.	
	361141		121075
	container filter with weight ceramic hose ø 4mm		
	Part No.	Ref. No.	
	361230		—
	container filter with weight stainless steel hose ø 4x6mm		
	Part No.	Ref. No.	
	361462		121993
	container filter with weight SS hose ø 4x6mm		
	Part No.	Ref. No.	
	361728		—
	container filter with 4m 4x6 hose SS hose ø 4x6mm hose length 4000mm		



Part No.	520027	Ref. No.	143013 143028
description	PVC hose ID ø 4mm ED ø 7mm L 10m thickness 1.5mm t.max. 60°C transparent		
For models:	050F, 050FP, 10, 11F, 11FD, 11F-DVGW, 11R, 11RD, 12, 14, 21F, 21FD, 21R, 21RD, 22F, 22R, 2312-001, 2312-002, 2312-007, 2312-009-CRP, 25F, 25FD, 25R, 25RD, 30F, 30FD, 30R, 30RD, 31F, 31FD, 31R, 31RD, 350F, 350FD, 350R, 350RD, 35-ELECTRONIC, 35F, 35FD, 35R, 35RD, 400F, 400FD, 400R, 400RD, 40-ELECTRONIC, 40F, 40FD, 40R, 40RD...(Other models you can see in the webshop)		

formed hoses

straight





Part No.	518303	Ref. No.	127065
description	formed hose		
For models:	2312-007, 2312-009-CRP, 914100, 914101, 914339, 914342, 914343, 914624, 914625, 914626, 914627, 914628, 914850, 914851, 914854, 914944, RIVER-48, RIVER-50, RIVER-50-CRP, RIVER-50-CRP-SP, River-54, RIVER-54CRP, River-54-CRP-s.p., RIVER-54-CRP-SP, RIVER-61		




Part No.	518519	Ref. No.	127054
description	formed hose dishwasher straight equiv. no. 127054		
For models:	913289, 913290, 913291, 913292, 913356, 913357, 913372, 913373, 913374, 913375, 913416, 913435, 913544, 913545, 913665, 913666, 913667, 913668, 913685, 913771, 913772, 913773, 913774, 913832, 913837, 913911, 913912, 913948, 913950, 913977, 913984, 913990, 914165, 914166, 914206, 914214, 914316, 914317, 914355, 914386, 914387, 914388, 914389, 914390, 914391, 914392, 914393, 914394, 914395, 914396...(Other models you can see in the webshop)		




			
Part No.	518213	Ref. No.	143009
description	formed hose dishwasher straight equiv. no. 143009		
For models:	350R, 350RD, 35-ELECTRONIC, 35R, 35RD, 400F, 400FD, 400R, 400RD, 40-ELECTRONIC, 40F, 40FD, 40R, 40RD, 45, 450, 67F, 67R, 913418, 914167, 914168, 914398, 914399, 914443, 914943, 915695, 915696, 915819, E.45, Fast145, FAST-145, Fast145D, FAST-145D, NIAGARA-45, S641, S643		

			
Part No.	518380	Ref. No.	127036 80189
description	formed hose ext. ø 53 ID ø 43mm L 65mm dishwasher straight mounting pos. upper equiv. no. 127036		
For models:	22F, 2312-001, 2312-002, 440F, 44F, 46, 460, 500F, 500FD, 50-ELECTRONIC, 50F, 50FD, 510F, 510FD, 80, 81, 82, 913297, 913298, 913299, 913300, 913360, 913361, 913391, 913392, 913546, 913547, 913611, 913684, 913913, 913914, 913932, 913933, 914284, 914318, 914319, 914331, 914338, 914356, 914400, 914401, 914402, 914403, 914404, 914405, 914431, 914449, 914517, 914545...(Other models you can see in the webshop)		

form L


			
Part No.	518302	Ref. No.	127064
description	formed hose		
For models:	2312-007, 2312-009-CRP, 914100, 914101, 914339, 914342, 914343, 914624, 914625, 914626, 914627, 914628, 914850, 914851, 914854, 914944, PS-60, RIVER-48, RIVER-50, RIVER-50-CRP, RIVER-50-CRP-SP, RIVER-54, RIVER-54CRP, River-54-CRP-s.p., RIVER-54-CRP-SP, RIVER-61		

			
Part No.	518639	Ref. No.	143237
description	formed hose end piece A ext. ø 18mm end piece A int. ø 11mm AD2 ø 18mm end piece B 11mm L 460mm		
For models:	913289, 913290, 913291, 913292, 913356, 913357, 913372, 913373, 913374, 913375, 913416, 913435, 913544, 913545, 913665, 913666, 913667, 913668, 913685, 913771, 913772, 913773, 913774, 913832, 913837, 913911, 913912, 913948, 913950, 913977, 913984, 913990, 914165, 914166, 914206, 914214, 914316, 914317, 914355, 914386, 914387, 914388, 914389, 914390, 914391, 914392, 914393, 914394, 914395, 914396...(Other models you can see in the webshop)		

			
Part No.	513251	Ref. No.	80187
description	formed hose end piece A ext. ø 59mm end piece A int. ø 47mm AD2 ø 58mm end piece B 46mm warewashing L-shape equiv. no. 80187 mounting pos. upper		
For models:	80, 81, 82, 915747, CGL74CABT, Fast200, FAST-200, Fast93, GL280EB, GL280EB23, GL280EB23DAR, GL280EB23HZ, GL280EB23HZDY, GL280EBD, GL280EBDA, GL280EBDAE, GL280EBDAR, GL280EBDARY, GL280EBDAW, GL280EBDAWY, GL280EBDAY, GL280EBDB, GL280EBDBR, GL280EBDBW, GL280EBDWW, GL280EBDY, GL280EBS, GL280EBSA, GL280EBSAE, GL280EBSAEW, GL280EBSAEWY, GL280EBSAR, GL280EBSARY, GL280EBSAW, GL280EBSAWY, GL280EBSAY, GL280EBSB, GL280EBSR, GL280EBSWY, GL280EBSY, GL282EB, GL282EB93, GL282EB93DA, GL282EB93HZ23, GL282EBCH, GL282EBCHD, GL282EBD, GL282EBDA, GL282EBDAE, GL282EBDAR...(Other models you can see in the webshop)		


			
Part No.	513250	Ref. No.	80188
description	formed hose ID ø 48mm ED ø 60mm thickness 6mm L1 235mm L2 140mm L-shape		
For models:	80, 81, 82, 914380, 914436, A3EB, A3EBD, A3EBDAKRYKY, A3EBDAKWK, A3EBDBKWK, A3EBDRYKY, A3EBDWW, A3EBDYK, A3EBSAK, A3EBSAKRK, A3EBSAKWK, A3EBSBKWKYKY, A3EBSKWK, A3EBSWK, A4EB, A4EBD, A4EBDAKEKYKY, A4EBDAKWK, A4EBDAKWK, A4EBDAKZK, A4EBDBKWK, A4EBDPKWKYKY, A4EBDRK, A4EBS, A4EBSAK, A4EBSAKCK, A4EBSAKEKYKY, A4EBSAKRK, A4EBSAKRKPK, A4EBSAKYKY, A4EBSCK, A4EBT, A4EBTSAK, A5EB, A5EBD, A5EBDAKPKWK, A5EBDAKWK, A5EBDAKYKY, A5EBDRK, A5EBS, A5EBSAKPKWK, A5EBSAKRK, A5EBSAKRKYKY, A5EBSAKWK, A5EBSAKWKYKY...(Other models you can see in the webshop)		

			
Part No.	513254	Ref. No.	80186
description	formed hose L 340mm warewashing L-shape equiv. no. 80186 ID ø 60mm		
For models:	80, 81, 82, 915747, A4EB, A4EBD, A4EBDAKEKYKY, A4EBDAKWK, A4EBDAKWK, A4EBDAKZK, A4EBDBKWK, A4EBDPKWKYKY, A4EBDRK, A4EBS, A4EBSAK, A4EBSAKCK, A4EBSAKEKYKY, A4EBSAKRK, A4EBSAKRKPK, A4EBSAKYKY, A4EBSCK, A4EBT, A4EBTSAK, A5EB, A5EBD, A5EBDAKPKWK, A5EBDAKWK, A5EBDAKYKY, A5EBDRK, A5EBS, A5EBSAKPKWK, A5EBSAKRK, A5EBSAKRKYKY, A5EBSAKWK, A5EBSAKWKYKY, A5EBSBKWK, A5EBSRK, A5EBSYK, CE78HZ23, CGL74CABT, E78, E78HP, Fast181, FAST-181, Fast181-230V-3Ph-60Hz, Fast181-400V-3NPh-60Hz, GL284EB, GL284EBD, GL284EBDA...(Other models you can see in the webshop)		


1

Part No.	518216	Ref. No.	127001
description	formed hose warewashing L-shape equiv. no. 127001 mounting pos. upper		
For models:	21F, 21FD, 21R, 21RD, 22F, 22R, 25F, 25FD, 25R, 25RD, 30F, 30FD, 30R, 30RD, 31F, 31FD, 31R, 31RD, 40F, 440F, 44F, 45, 450, 67F, 67R, 913418, 914167, 914168, 914398, 914399, 914443, 914943, 915695, 915696, 915819, E.45, E.52, Fast145, FAST-145, Fast145D, FAST-145D, Niagra-45, S621, S623, S624, S626, S631, S633, S634, S636		




1

Part No.	518520	Ref. No.	127005
description	formed hose warewashing L-shape equiv. no. 127005		
For models:	11F, 11FD, 11R, 11RD, 21F, 21FD, 21R, 21RD, 25F, 25FD, 25R, 25RD, 30F, 30FD, 30R, 30RD, 31F, 31FD, 31R, 31RD, 913363, 913364, 913376, 913377, E.41, E.42, E41, S621, S623, S624, S626, S631, S633, S634, S636		




1

Part No.	513134	Ref. No.	926034
description	formed hose warewashing L-shape equiv. no. 926034, DZG47		
For models:	10, 12, 14, 82, CLEAN-100, CLEAN-110, CLEAN-120, E.60, E.65, E1, E10, E100, E110		



1


Part No.	513135	Ref. No.	926056
description	formed hose warewashing L-shape equiv. no. 926056, DZG461		
For models:	12, 14, 161, 221, 271, 272, 362, 914380, 914436, 915747, A3EB, A3EBD, A3EBDAKRYK, A3EBDAKWK, A3EBDBKWK, A3EBDRYK, A3EBDWK, A3EBDYK, A3ESAK, A3ESAKRK, A3ESAKWK, A3ESBKWKYK, A3EBSEKWK, A3ESBWK, A4EB, A4EBD, A4EBDAKEYK, A4EBDAKWK, A4EBDAKWK, A4EBDAKZK, A4EBDBKWK, A4EBDPKWKYK, A4EBDRK, A4EBS, A4ESAK, A4ESAKCK, A4ESAKEKYK, A4ESAKRK, A4ESAKRKP, A4ESAKYK, A4ESBCK, A4EBT, A4EBTSAK, A5EB, A5EBD, A5EBDAKPKWK, A5EBDAKWK, A5EBDAKYK, A5EBDRK, A5EBS...(Other models you can see in the webshop)		



1

Part No.	513246	Ref. No.	926157
description	formed hose warewashing L-shape equiv. no. 926157, DZG6162		
For models:	CLEAN-100, CLEAN-110, E1, E10, E100, E110		


with branch



1

Part No.	511929	Ref. No.	143239
description	formed hose ext. ø 17 L 430mm plastic black Qty 1		
For models:	913289, 913290, 913291, 913292, 913356, 913357, 913363, 913364, 913372, 913373, 913374, 913375, 913376, 913377, 913416, 913435, 913544, 913545, 913665, 913666, 913667, 913668, 913685, 913771, 913772, 913773, 913774, 913832, 913833, 913837, 913911, 913912, 913948, 913950, 913977, 913984, 913990, 914165, 914166, 914206, 914214, 914316, 914317, 914355, 914386, 914387, 914388, 914389, 914390, 914391, 914392...(Other models you can see in the webshop)		


form S



1

Part No.	513244	Ref. No.	926033
description	formed hose S-shape warewashing equiv. no. 926033, DZG63		
For models:	10, CLEAN-100, CLEAN-110, E1, E10, E100, E110		

form U



1

Part No.	513260	Ref. No.	143242
description	formed hose warewashing		
For models:	913289, 913290, 913291, 913292, 913356, 913357, 913372, 913373, 913374, 913375, 913416, 913435, 913544, 913545, 913665, 913666, 913667, 913668, 913685, 913771, 913772, 913773, 913774, 913832, 913837, 913911, 913912, 913948, 913950, 913977, 913984, 913990, 914165, 914166, 914206, 914214, 914316, 914317, 914355, 914386, 914387, 914388, 914389, 914390, 914391, 914392, 914393, 914394, 914395, 914396...(Other models you can see in the webshop)		



miscellaneous



1

Part No.	518036	Ref. No.	127012
description	formed hose angled warewashing		
For models:	21F, 21FD, 25F, 25FD, 30F, 30FD, 31F, 31FD, 31R, 31RD, S621, S623, S624, S626, S631, S633, S634, S636		



1

Part No.	513716	Ref. No.	127053
description	pressure hose warewashing		
For models:	913291, 913292, 913357, 913363, 913364, 913374, 913375, 913376, 913377, 913416, 913435, 913545, 913666, 913668, 913685, 913773, 913774, 913911, 913912, 913948, 913950, 913977, 913984, 913990, 914214, 914316, 914317, 914392, 914393, 914394, 914395, 914396, 914397, 914441, 914442, 914515, 914516, 914537, 914543, 914547, 914683, 914684, 914689, 914863, 914874, 915138, 915139, 915527, 915692, 915693...(Other models you can see in the webshop)		

for dishwashers

ventilation hoses



1

Part No.	513265	Ref. No.	143189
description	ventilation hose ext. ϕ 17 ID ϕ 14mm L 75mm warewashing back-flow restrictor		
For models:	050F, 050FP, 2312-001, 2312-002, 350F, 350FD, 350R, 350RD, 35F, 35FD, 35R, 35RD, 400F, 400FD, 400R, 400RD, 40F, 40FD, 40R, 40RD, 45, 450, 46, 460, 500F, 500FD, 50F, 50FD, 510F, 510FD, 913297, 913298, 913299, 913300, 913360, 913361, 913391, 913392, 913546, 913547, 913578, 913611, 913684, 913913, 913914, 913932, 913933, 913992, 913993, 914284...(Other models you can see in the webshop)		

miscellaneous



1

Part No.	530770	Ref. No.	929171
description	hose ED ϕ 30mm ID ϕ 20mm L 1050mm rubber black Qty 1		
For models:	KLP105EB, KLP201DDDTEB, KLP201EB, KLP301, KLP301DDDTEB, LP105DDDTEB, LP105DDDTEBN, LP105EB, LP201DDDTEB, LP201EB, LP301, LP301EB, LP60, River-282-2, River-282L-2, River-282LS-2TDE, River-282S-2TDE, River-285, RIVER-294, RIVER-295, River-295P, RIVER-296, River-296P, RIVER-297, RIVER-298, River-382, River-382-230V-3Ph-50Hz, River-382H, River-382L, River-382L-230V-3Ph-50Hz, River-382LNRG, River-382LTDE, River-382NRG, River-382NRG-230-3Ph-50Hz, River-382TDE, River-482, River-81CRP, RIVER-81-CRP, River-82CRP, RIVER-82-CRP, RV282R, RV294, RV295, RV295PS, RV296, RV296PS, RV297, RV298, RV298HZ, RV382...(Other models you can see in the webshop)		

fittings, hose and pipe connectors

hose connectors

without screw connection



1

Part No.	541109	Ref. No.	035031
description	Y-piece plastic hose ϕ 8-6-8mm for pressure switch		
For models:	050F, 050FP, 22F, 22R, 2312-002, 2312-007, 2312-009-CRP, 40F, 440F, 45, 450, 460, 500F, 500FD, 510F, 510FD, 913297, 913298, 913299, 913300, 913360, 913361, 913391, 913392, 913546, 913547, 913578, 913611, 913684, 913913, 913914, 913932, 913933, 913992, 913993, 914100, 914101, 914284, 914318, 914319, 914326, 914331, 914338, 914339, 914342, 914343, 914356, 914400, 914401, 914402...(Other models you can see in the webshop)		

hose connectors

brass



1

Part No.	513253	Ref. No.	108006
description	hose connector brass angled thread 1/4" hose ϕ 12mm Qty 1 pcs		
For models:	10, 11F, 11FD, 11R, 11RD, 12, 14, 161, 21F, 21FD, 21R, 21RD, 221, 22F, 22R, 25F, 25FD, 25R, 25RD, 271, 272, 30F, 30FD, 30R, 30RD, 31F, 31FD, 31R, 31RD, 362, 40F, 440F, 44F, 500F, 500FD, 50F, 50FD, 510F, 510FD, 66, 913297, 913298, 913299, 913300, 913360, 913361, 913391, 913392, 913546, 913547...(Other models you can see in the webshop)		



producer-specific

			
1			
Part No.	504388	Ref. No.	468205
description	hose connector grommet ø 10.5mm grommet length 15mm total length 26mm plastic for drain hose		
For models:	915150, 915151, 915152, 915154, 915155, 915157, 915158, 915160, 915161, 915162, 915166, 915167, 915168, 915172, 915173, 915175, 915319, 915348, 915418, 915419, 915420, 915421, 915422, 915479, 915492, 915493, 915494, 915495, 915496, 915497, 915547, 915558, 915617, 915618, 915635, 915663, 915672, 915747, 915773, 915774, 916054, 916066, 916067, 916068, 916069, 916077, 916078, 916079, 916080, 916201...(Other models you can see in the webshop)		

supply filters


			
1			
Part No.	520261	Ref. No.	927078
description	supply filter thread 1/2" IT - 1/2" IT total length 58mm red brass mesh opening 0.4mm		
For models:	161, 221, 271, 272, 362, CLEAN-160, CLEAN-161, CLEAN-220, CLEAN-221, CLEAN-270, CLEAN-271, CLEAN-272, CLEAN-361, CLEAN-361P, CLEAN-362, CLEAN-471, CLEAN-471P		

water cycle components

pressure reduction valves

pressure reduction valves

universal

			
1			
Part No.	520868	Ref. No.	927150
description	pressure reduction valve OR series PN40 connection 1/2" setting range 1-7bar p max 40bar t.max. 80°C brass		
For models:	161, 221, 271, 272, 362, 914380, 914436, A3EB, A3EBD, A3EBDAKRYK, A3EBDAKWK, A3EBDBKWK, A3EBDRKYK, A3EBDWK, A3EBDYK, A3EBSAK, A3EBSAKRK, A3EBSAKWK, A3EBSBKWKYK, A3EBSEKWK, A3EBSWK, A4EB, A4EBD, A4EBDAKEYK, A4EBDAKRK, A4EBDAKWK, A4EBDAKZK, A4EBDBKRK, A4EBDPKWYK, A4EBDRK, A4EBS, A4EBSAK, A4EBSAKCK, A4EBSAKEKYK, A4EBSAKRK, A4EBSAKRKP, A4EBSAKYK, A4EBSCK, A5EB, A5EBD, A5EBDAKPKWK, A5EBDAKWK, A5EBDAKYK, A5EBDRK, A5EBS, A5EBSAKPKWK, A5EBSAKRK, A5EBSAKRKYK, A5EBSAKWK, A5EBSAKWKYK...(Other models you can see in the webshop)		

ancillary products


clamps

hose clamps

DIN 3017 - W4

			
1			
Part No.	520120	Ref. No.	927322
description	hose clamp SS W4 ø 12-20mm width 9mm Qty 1 pcs DIN 3017		
For models:	CLEAN-161, CLEAN-221, CLEAN-271, CLEAN-272, CLEAN-362, CNT800CH, Fast180, Fast180-230V-3Ph-60Hz, FAST-60, FAST-73, NG271, NG281, NG281CDD, NG281HP, NG281HPDD, NG281HZ23, NG281HZ23DD, NG291, NG292, NG292HZ, NG293, NG381, NG38123, NG38123TERMO, NG381C, NG381CDD, NG381CFUR, NG381DDHZ23, NG381DDPS, NG381DDPSHZ23, NG381HPDD, NG381L, NG381LC, NG381LCFUR, NG381LDDPS, NG381TERMO, NG381TXCDD, NIAGARA-271, NIAGARA-281, Niagara-281-2, Niagara-281HP, Niagara-283L-2, NIAGARA-291, NIAGARA-292, Niagara-292-400V-3Ph-60Hz, NIAGARA-293, Niagara-381, Niagara-381-230V-3Ph-50Hz, Niagara-381-230V-3Ph-60Hz, Niagara-381DP...(Other models you can see in the webshop)		

double wire clamps

			
1			
Part No.	513268	Ref. No.	423011
description	hose clamp ø 8-10mm wire gauge ø 1mm Qty 1 pcs		
For models:	050F, 050FP, 2312-001, 2312-002, 2312-007, 2312-009-CRP, 31F, 31FD, 31R, 31RD, 500F, 500FD, 50F, 50FD, 510F, 510FD, 67F, 67R, 913297, 913298, 913299, 913300, 913360, 913361, 913391, 913392, 913546, 913547, 913578, 913611, 913684, 913913, 913914, 913932, 913933, 914100, 914101, 914284, 914318, 914319, 914326, 914331, 914338, 914356, 914400, 914401, 914402, 914403, 914404, 914405...(Other models you can see in the webshop)		



measuring equipment

thermometers

built-in thermometers



1

Part No.	541095	Ref. No.	926100
description	thermometer mounting measurements 58x25.5mm 0 up to +120°C capillary pipe 3000mm probe ø 6.5mm probe L 20mm		
For models:	CLEAN-160, CLEAN-220, CLEAN-270, CLEAN-271		

ø60mm



1

Part No.	542106	Ref. No.	DET1L
description	thermometer mounting ø 60mm t.max. 120°C 0-120°C probe ø 8.5mm probe L 35mm capillary pipe 5000mm connection M10x1		

fastening material

screws

hexagonal screws



1

Part No.	506447	Ref. No.	486041
description	hexagonal screw thread M8 thread L 16mm SS WS 13 Qty 1 pcs DIN 933 / ISO 4017		

knurled screws



1

Part No.	510112	Ref. No.	454002
description	Thumb screw thread M10 thread L 10mm ø 22mm H 4.5mm SS		
For models:	050F, 050FP, 11F, 11FD, 11F-DVGW, 21F, 21FD, 2312-001, 2312-002, 25F, 25FD, 30F, 30FD, 31F, 31FD, 400F, 400FD, 40-ELECTRONIC, 40F, 40FD, 45, 450, 46, 460, 500F, 500FD, 50F, 50FD, 510F, 510FD, 67R, 913363, 913364, 913376, 913377, 914568, 915830, E.41, E.42, E.45, E.46, E.50, E.50D.PA, E.51, E.41, F.85, F.85P, FAST-160DP, GSP50, GSP50P... (Other models you can see in the webshop)		

nuts

knurled nuts



1

Part No.	518028	Ref. No.	454004
description	knurled nut thread M5 ø 25mm H 4mm SS		
For models:	050F, 050FP, 10, 12, 14, 22F, 2312-001, 2312-002, 350F, 350FD, 350R, 350RD, 35-ELECTRONIC, 35F, 35FD, 35R, 35RD, 40F, 440F, 44F, 500F, 500FD, 50-ELECTRONIC, 50F, 50FD, 510F, 510FD, 55, 66, 914684, CLEAN-100, CLEAN-110, CLEAN-120, E.35, E.35H, E.40, E.40H, E.50, E.51, E.52, E.60, E.65, E1, E10, E100, E110, E12, E120, E14, E140... (Other models you can see in the webshop)		

hexagonal nuts

DIN 934 / ISO 4032/8673



1

Part No.	560340	Ref. No.	CDI204
description	hexagonal nut thread M4 H 3.2mm WS 7 SS DIN/ISO DIN 934 / ISO 4032/8673 Qty 1 pcs		

DIN 985



1

Part No.	560518	Ref. No.	926087
description	hexagonal nut thread M8 H 9.2mm SS WS 13 self-locking Qty 1 pcs		
For models:	12, 14, CLEAN-110, CLEAN-120, E1, E110		

hexagonal nuts metric (without norm)



1

Part No.	513266	Ref. No.	417104
description	nut		
For models:	913289, 913290, 913291, 913292, 913356, 913357, 913372, 913373, 913374, 913375, 913416, 913435, 913544, 913545, 913665, 913666, 913667, 913668, 913685, 913771, 913772, 913773, 913774, 913832, 913837, 913911, 913912, 913948, 913950, 913977, 913984, 913990, 914165, 914166, 914206, 914214, 914316, 914317, 914355, 914386, 914387, 914388, 914389, 914390, 914391, 914392, 914393, 914394, 914395, 914396... (Other models you can see in the webshop)		



hexagonal nuts inch thread



Part No.	503042	Ref. No.	CDO138C
description	nut thread 3/8" H 6mm brass WS 22 Qty 1 pcs		

washers

washers

miscellaneous



Part No.	513223	Ref. No.	926249
description	disc		

fasteners

clamps

hose clamps

DIN 3017 - W4



Part No.	520120	Ref. No.	927322
description	hose clamp SS W4 ø 12-20mm width 9mm Qty 1 pcs DIN 3017		
For models:	CLEAN-161, CLEAN-221, CLEAN-271, CLEAN-272, CLEAN-362, CNT800CH, Fast180, Fast180-230V-3Ph-60Hz, FAST-60, FAST-73, NG271, NG281, NG281CDD, NG281HP, NG281HPDD, NG281HZ23, NG281HZ23DD, NG291, NG292, NG292HZ, NG293, NG381, NG38123, NG38123TERMO, NG381C, NG381CDD, NG381CFUR, NG381DDHZ23, NG381DDPS, NG381DDPSHZ23, NG381HPDD, NG381L, NG381LC, NG381LCFUR, NG381LDDPS, NG381TERMO, NG381TXCDD, NIAGARA-271, NIAGARA-281, Niagara-281-2, Niagara-281HP, Niagara-283L-2, NIAGARA-291, NIAGARA-292, Niagara-292-400V-3Ph-60Hz, NIAGARA-293, Niagara-381, Niagara-381-230V-3Ph-50Hz, Niagara-381-230V-3Ph-60Hz, Niagara-381DP...(Other models you can see in the webshop)		

double wire clamps



Part No.	513268	Ref. No.	423011
description	hose clamp ø 8-10mm wire gauge ø 1mm Qty 1 pcs		
For models:	050F, 050FP, 2312-001, 2312-002, 2312-007, 2312-009-CRP, 31F, 31FD, 31R, 31RD, 500F, 500FD, 50F, 50FD, 510F, 510FD, 67F, 67R, 913297, 913298, 913299, 913300, 913360, 913361, 913391, 913392, 913546, 913547, 913578, 913611, 913684, 913913, 913914, 913932, 913933, 914100, 914101, 914284, 914318, 914319, 914326, 914331, 914338, 914356, 914400, 914401, 914402, 914403, 914404, 914405...(Other models you can see in the webshop)		

retaining rings

DIN 6799



Part No.	507015	Ref. No.	929014 CWA5D7
description	retaining ring E D1 ø 7mm D2 ø 14mm SS DIN 6799 thickness 0.9mm for shaft ø 8-11mm		
For models:	55, E.65		

consumables

fuses

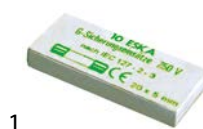
fine fuses



Part No.	358530	Ref. No.	926284
description	fine fuse size ø5x20mm 0.8A fast-acting rated 250V Qty 10 pcs		
For models:	80, 81, 914380, 914436, CE78HZ23, CGL74CABT, E78, E78HP, FAST-181, HM1, KLP105EB, KLP201DDDTEB, KLP201EB, KLP301, KLP301DDDTEB, LP105DDDTEB, LP105DDDTEBN, LP105EB, LP201DDDTEB, LP201EB, LP301, LP301EB, LP60, PS-60, RIVER-150, River-152, RIVER-154, RIVER-71, RIVER-80, River-81, River-81CRP, RIVER-81-CRP, RIVER-82, River-82CRP, RIVER-82-CRP, RIVER-E78, RIVER-HL-81, RV150, RV15023, RV15023DA, RV150D, RV150DA, RV150DAR, RV150DARY, RV150DAW, RV150DAWY, RV150DAY, RV150DE, RV150DRW, RV150DW...(Other models you can see in the webshop)		



Part No.	358677	Ref. No.	228004 228010
description	fine fuse size ø5x20mm 4A fast-acting rated 250V Qty 10 pcs		
For models:	2312-007, 2312-009-CRP, 80, 81, 82, 913363, 913364, 913911, 913912, 913913, 913914, 913950, 913977, 913984, 913990, 913992, 913993, 914100, 914101, 914165, 914166, 914167, 914168, 914206, 914214, 914284, 914316, 914317, 914318, 914319, 914338, 914339, 914342, 914343, 914355, 914356, 914380, 914431, 914436, 914516, 914543, 914583, 914592, 914612, 914613, 914624, 914625, 914626, 914627, 914628...(Other models you can see in the webshop)		



Part No.	358606	Ref. No.	228014
description	fine fuse size ø5x20mm 4A slow-acting rated 250V Qty 10 pcs		
For models:	916237, 916238, 916239, 916240, 916241, 916242, 916243, 916244, 916245, 916246, 916401, 916402, 916403, 916404, 916405, 916406, 916407, 916408, 916451, 916583, 916687, 916787, 916991, 917042, 917043, Clean140, Clean140S, Fast130, Fast135-2, Fast135-2S, Fast135H-2, Fast135H-2S, Fast139-2, Fast139-2S, Fast139H-2, Fast139H-2S, Fast140		



ø6.3x32mm 250V



1

Part No.	358760	Ref. No.	926283
description	fine fuse size ø6.3x32mm 0.315A medium lag rated 250V Qty 10 pcs		
For models:	80, 81, 914380, 914436, CE78HZ23, CGL74CABT, E78, E78HP, FAST-181, HM1, KLP105EB, KLP201DDDTEB, KLP201EB, KLP301, KLP301DDDTEB, LP105DDDTEB, LP105DDDTEBN, LP105EB, LP201DDDTEB, LP201EB, LP301, LP301EB, LP60, PS-60, RIVER-150, River-152, RIVER-154, RIVER-71, RIVER-80, River-81, River-81CRP, RIVER-81-CRP, RIVER-82, River-82CRP, RIVER-82-CRP, RIVER-E78, RIVER-HL-81, RV150, RV15023, RV15023DA, RV150D, RV150DA, RV150DAR, RV150DARY, RV150DAW, RV150DAWY, RV150DAY, RV150DE, RV150DRW, RV150DW...(Other models you can see in the webshop)		

fine fuse holders



1


Part No.	550519	Ref. No.	H.228048
description	cover plate suitable fuseA ratedV connection for fuse holder		
For models:	2312-007, 2312-009-CRP, 80, 81, 82, 913911, 913912, 913950, 913977, 913984, 913990, 914165, 914166, 914206, 914214, 914316, 914317, 914339, 914342, 914343, 914355, 914380, 914436, 914516, 914543, 914626, 914684, 914874, 915138, CE78HZ23, CGL74CABT, CNT800CH, E78, E78HP, Fast180, Fast180-230V-3Ph-60Hz, Fast181, FAST-181, Fast181-230V-3Ph-60Hz, Fast181-400V-3NPh-60Hz, Fast200, FAST-200, FAST-60, FAST-73, Fast93, GL280EB, GL280EB23, GL280EB23DAR, GL280EB23HZ, GL280EB23HZDY...(Other models you can see in the webshop)		



GASTROPARTS

GASTROPARTS Sp. J.
Klonowica 37
87-100 Toruń

www.gastroparts.com 

gastroparts@gastroparts.com 

tel. +48 56 657 00 68 

[/gastroparts.global](https://www.facebook.com/gastroparts.global) 

[/gastroparts.global](https://www.instagram.com/gastroparts.global) 