



**GASTROPARTS**

Universal Catalogue › Water Technology ›

# **[EN]** Dosing pumps

**[DE]** Dosiergeräte

**[ES]** Dosificadores

**[FR]** Doseurs

**[IT]** Dosatori

**[PL]** Dozowniki

**[RU]** Дозаторы

✉ [gastroparts@gastroparts.com](mailto:gastroparts@gastroparts.com)

☎ tel. +48 56 657 00 66

📘 [fb.com/gastroparts.global](https://fb.com/gastroparts.global)

**GASTROPARTS.COM**





# dosing pumps

# 4

peristaltic dosing pumps.	122
piston pumps.	132
membrane dosing pumps.	133
electronic controllers.	138
accessories.	138



## dosing pumps

## peristaltic dosing pumps

ASF/THOMAS

built-in version

without control

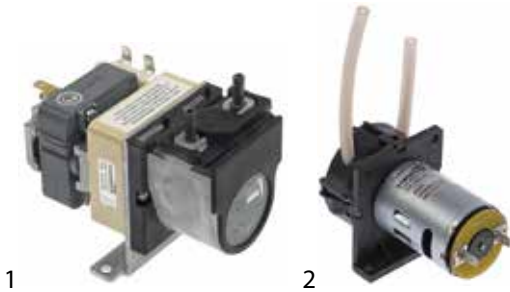

fig.	Part No.	pump rate (l/h)	supply	application	HCø (mm)	hose	type
1	361248	2	230 VAC	detergent	4x7	silicone	SR25
1	361249	4	230 VAC	detergent	4x7	silicone	SR25
1	361271	6	230 VAC	detergent	5x8	silicone	SR25
2	361324	4	12VDC	detergent	2x5.2	Pharmed	SR10/50
2	361968	4	12VDC	rinse aid	2.5x5.7	silicone	SR10/50
2	361917	6	12VDC	rinse aid	2.5x1.6	silicone	SR10/50



fig.	Part No.	pump rate (l/h)	supply	application	HCø (mm)	hose	type
3	361330	4	12VDC	rinse aid	2x5.2	silicone	SR10/50

## spare parts



fig.	Part No.	description	type	application	HCø (mm)	hose type
1	361297	pump hose	SR10/50	detergent	2.4x1.6	Pharmed
1	361296	pump hose	SR10/50	detergent	2x1.6	Pharmed



fig.	Part No.	description	type	application	HCø (mm)	hose type
2	361295	pump hose	SR10/50	rinse aid	2.5x1.6	silicone
2	361294	pump hose	SR10/50	rinse aid	2x5.2	silicone



fig.	Part No.	description	type	application	HCø (mm)	hose type
3	361333	pump hose	SR25	detergent	4x1.5	silicone



fig.	Part No.	description	type	application	HCø (mm)	hose type
4	361334	pump hose	SR25	detergent	5x8	silicone



fig.	Part No.	description	type	pump rate (l/h)
1	361470	roller assembly	SR25	12
1	361469	roller assembly	SR25	2/4/6



fig.	Part No.	description	type	application	hose type	pump rate (l/h)
1	361328	pump head	SR10/50	detergent	Pharmed	6
2	361293	pump head	SR10/50	rinse aid	silicone	6
3	361335	hose guide	SR25	for detergent	-	-

## BORES

## wall-mounted version

## with time control

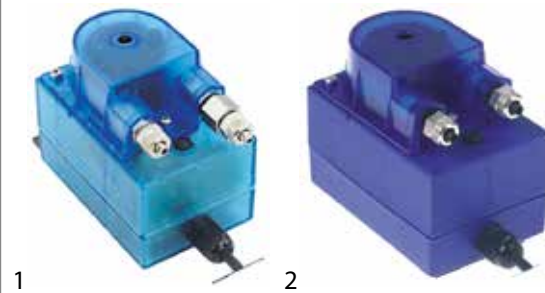

fig.	Part No.	pump rate (l/h)	supply	application	HCø (mm)	hose	type
1	361588	1	230 VAC	rinse aid	4x6	silicone	Mybo
2	361592	3.3	230 VAC	detergent	4x6	Santoprene	PDM3.3



fig.	Part No.	pump rate (l/h)	supply	application	HCø (mm)	hose	type
3	361380	4	24 VAC	detergent	4x6	Santoprene	Mybo



without control

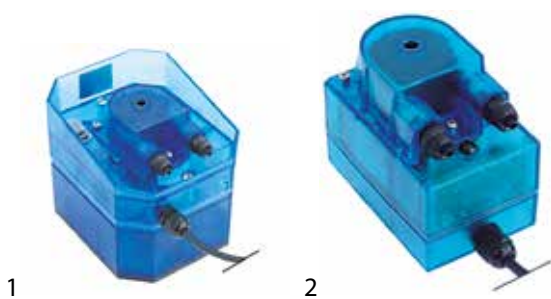

fig.	Part No.	pump rate (l/h)	supply	application	HCø (mm)	hose	type
1	361397	2	230 VAC	detergent	4x6	Santoprene	Protho
2	361382	4	24 VAC	detergent	4x6	Santoprene	Mybo

with frequency control

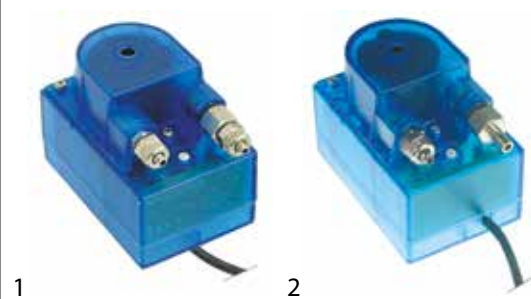

fig.	Part No.	pump rate (l/h)	supply	application	HCø (mm)	hose	type
1	361406 <sup>1</sup>	1	230 VAC	rinse aid	4x6	silicone	Mybo
2	361580 <sup>1</sup>	1	230 VAC	rinse aid	4x6	silicone	Mybo

<sup>1</sup>with integrated back flow preventer

built-in version

twin pump



fig.	Part No.	pump rate (l/h)	supply	application	HCø (mm)	hose	type
1	361577 <sup>1</sup>	0.16/0.07	230VAC	detergent/rinse aid	4x6	Santoprene	Perios

<sup>1</sup>with integrated back flow preventer



fig.	Part No.	pump rate (l/h)	supply	application	HCø (mm)	hose	type
3	361405	3.3	230 VAC	detergent	4x6	Santoprene	Mybo

with flow control



fig.	Part No.	pump rate (l/h)	supply	application	HCø (mm)	hose	type
1	361816	0.39	230 VAC	rinse aid	4x6	silicone	Perios
2	361027	0.72	230 VAC	detergent	4x6	Santoprene	Perios

without control



fig.	Part No.	pump rate (l/h)	supply	application	HCø (mm)	hose type	type
1	361743	0.4	230 VAC	rinse aid	4x6	silicone	PB0.2P
2	361283 <sup>1</sup>	0.4	230 VAC	rinse aid	4x6	silicone	Protho
2	361280	1.5	230 VAC	detergent	4x6	Santoprene	Protho
2	361281	2	230 VAC	detergent	4x6	Santoprene	Protho
2	361282	3.3	230 VAC	detergent	4x6	Santoprene	Protho

<sup>1</sup>with integrated back flow preventer

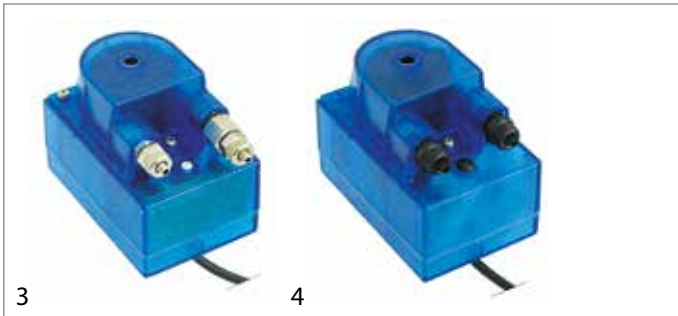

fig.	Part No.	pump rate (l/h)	supply	application	HCø (mm)	hose type	type
3	361408 <sup>1</sup>	1	230 VAC	rinse aid	4x6	silicone	Mybo
4	361407	3.3	230 VAC	detergent	4x6	Santoprene	Mybo

spare parts

fig.	Part No.	description	type	application	HCø (mm)	hose type
1	361128	pump hose	Perios	detergent	4x7	Santoprene

fig.	Part No.	description	type	application	HCø (mm)	hose type
2	361130	pump hose	Perios	detergent	4x7	Santoprene

fig.	Part No.	description	type	application	HCø (mm)	hose type
3	361127	pump hose	Perios	rinse aid	3x6	silicone

fig.	Part No.	description	type	application	HCø (mm)	hose type
4	361129	pump hose	Perios	rinse aid	3x6	silicone

fig.	Part No.	description	type	application	HCø (mm)	hose type
5	361290	pump hose	PROTHO/MYBO	detergent	7x10	Santoprene

fig.	Part No.	description	type	application	HCø (mm)	hose type
6	361291	pump hose	PROTHO/MYBO	rinse aid	2x6	silicone

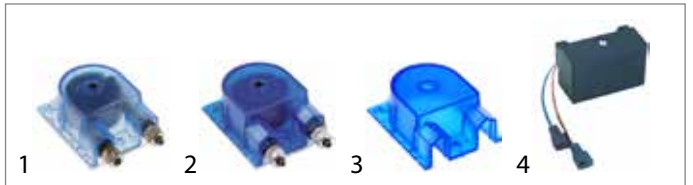

fig.	Part No.	description
1	361409	pump head pump type PROTHO/MYBO hose type Santoprene detergent hose ø 7x10mm
2	361410 <sup>1</sup>	pump head pump type PROTHO/MYBO hose type silicone rinse aid hose ø 3x7mm
3	361234	cover pump type PROTHO/MYBO
4	361223	electronic controller BORES 230V connection male faston 6.3mm

<sup>1</sup>with integrated back flow preventer

GERMAC

wall-mounted version

twin pump

**technical data:**  
application detergent/rinse aid

fig.	Part No.	pump rate (l/h)	supply	HCø (mm)	type
1	361773	3-5/0.6-1.2	230 VAC	6	G705

with frequency and speed control

fig.	Part No.	pump rate (l/h)	supply	application	HCø (mm)	hose	type
1	361277	9	230 VAC	detergent	4x6	TP	G53

with frequency/conductivity regulation

fig.	Part No.	pump rate (l/h)	supply	application	HCø (mm)	hose	type
1	361279	14	230 VAC	detergent	4x6	TP	G55





with frequency control



fig.	Part No.	pump rate (l/h)	supply	application	HCø (mm)	hose	type
1	361275	3	230 VAC	detergent	4x6	TP	G43

built-in version

with frequency control



fig.	Part No.	pump rate (l/h)	supply	application	HCø (mm)	hose	type
1	361266	0.6	230 VAC	rinse aid	4x6	silicone	G82
2	361518	0.7	230 VAC	rinse aid	4x6	silicone	G302



fig.	Part No.	pump rate (l/h)	supply	application	HCø (mm)	hose	type
3	361472	0.8	230 VAC	detergent	4x6	TP	G82
3	361619	1.5	230 VAC	detergent	4x6	TP	G152
3	361267	2	230 VAC	detergent	4x6	TP	G202
3	361620	2.5	230 VAC	detergent	4x6	TP	G252
4	361268	3	230 VAC	detergent	4x6	TP	G300
4	361517	5.5	230 VAC	detergent	4x6	TP	G305



fig.	Part No.	pump rate (l/h)	supply	application	HCø (mm)	hose	type
5	361862	3	230 VAC	detergent	4x6	TP	G300E

without control



fig.	Part No.	pump rate (l/h)	supply	application	HCø (mm)	hose	type
1	361466	0.6	230 VAC	rinse aid	4x6	silicone	G80
2	361020	0.8	230 VAC	detergent	4x6	TP	G80
2	361021	1.5	230 VAC	detergent	4x6	TP	G150
2	361022	2	230 VAC	detergent	4x6	TP	G200

spare parts

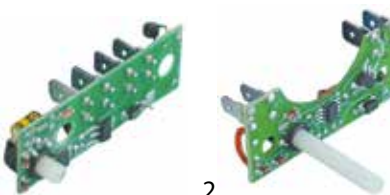

fig.	Part No.	description
1	361557	control PCB type G300/G302/G305 GERMAC
2	361556	control PCB type G82/G152/G202/G252 GERMAC



fig.	Part No.	description	hose type	HCø (mm)	for model
1	361822	pump hose	silicone	4	DC035DP/DC070DP



fig.	Part No.	description	hose type	HCø (mm)	for model
2	361555	pump hose	silicone	4x6	G42/G302
2	361060	pump hose	silicone	4x6	G80/G82/G600



fig.	Part No.	description	hose type	HCø (mm)	for model
3	361554	pump hose	TP	5x8	G200/G250/G252
3	361467	pump hose	TP	6x10	G43/G45/G53/G54/G55/G300/G305

1

fig.	Part No.	description	suitable for
1	361589	roller assembly	G42/43/45/53/54/55/300/302/305/705
1	361263	roller assembly	G80/82/150/152/200/202/250/252/600

**GIADOS**  
built-in version  
with frequency control



1 2

fig.	Part No.	pump rate (l/h)	supply	application	HCø (mm)	hose	type
1	361525 <sup>1</sup>	0.4	230VAC	rinse aid	4x6	silicone	6449
2	361930 <sup>1</sup>	1.5	230VAC	detergent	4x6	Santoprene	6671
2	361931 <sup>1</sup>	3	230VAC	detergent	4x6	Santoprene	6223

<sup>1</sup>incl. inlet and conveyor hose

without control



1 2

fig.	Part No.	pump rate (l/h)	supply	application	HCø (mm)	hose	type
1	361935 <sup>1</sup>	0.4	230VAC	rinse aid	4x6	silicone	5633
2	361933 <sup>1</sup>	1.5	230VAC	detergent	4x6	Santoprene	1206
2	361934 <sup>1</sup>	3	230VAC	detergent	4x6	Santoprene	4880

<sup>1</sup>incl. inlet and conveyor hose

spare parts



1

fig.	Part No.	description	application	hose type	HCø (mm)
1	361526	pump hose	detergent	Santoprene	4x6



2

fig.	Part No.	description	application	hose type	HCø (mm)
2	361527	pump hose	rinse aid	silicone	4x6

**MICRODOS**

wall-mounted version

with speed control

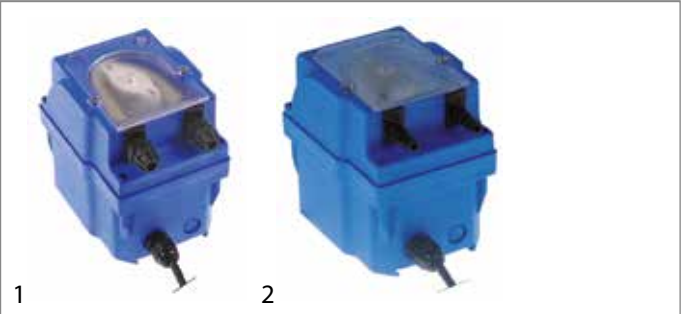

fig.	Part No.	pump rate (l/h)	supply	application	HCø (mm)	hose	type
1	361749	1	24 VAC	rinse aid	4x6	silicone	MP2-R
1	361956 <sup>1</sup>	1	24 VAC	rinse aid	4x6	silicone	MP2-R
1	361748	1	230 VAC	rinse aid	4x6	silicone	MP2-R
1	361962 <sup>1</sup>	1	230 VAC	rinse aid	4x6	silicone	MP2-R
1	361775	4	24 VAC	detergent	4x6	Santoprene	MP2-R
1	361957 <sup>1</sup>	4	24 VAC	detergent	4x6	Santoprene	MP2-R
1	361774	4	230 VAC	detergent	4x6	Santoprene	MP2-R
1	361963 <sup>1</sup>	4	230 VAC	detergent	4x6	Santoprene	MP2-R
1	361777	7	24 VAC	detergent	4x6	Santoprene	MP2-R
1	361776	7	230 VAC	detergent	4x6	Santoprene	MP2-R
1	361964 <sup>1</sup>	7	230 VAC	detergent	4x6	Santoprene	MP2-R
2	361786 <sup>1</sup>	1	230 VAC	rinse aid	6	silicone	MP2-R
2	361598	7	230 VAC	detergent	6	Santoprene	MP2-R
2	361787	18	230 VAC	detergent	8	Santoprene	MP2-R

<sup>1</sup>with accessories

with conductivity control



pos.	Part No.	pump rate (l/h)	supply	application	HCø (mm)	hose	type
1	361788 <sup>1</sup>	6	230 VAC	detergent	4x6	Santoprene	MP2-C1
2	361789	9	230 VAC	detergent	4x6	Santoprene	MP2-C1
3	361965 <sup>2</sup>	9	230 VAC	detergent	4x6	Santoprene	MP2-C1

<sup>1</sup>incl. conductivity probe <sup>2</sup>with accessories



with time control



fig.	Part No.	pump rate (l/h)	supply	application	HCø (mm)	hose	type
1	361785	0.5	24VAC	rinse aid	4x6	silicone	MP2-1T
1	361784	0.5	230 VAC	rinse aid	4x6	silicone	MP2-1T
1	361961 <sup>1</sup>	0.5	230 VAC	rinse aid	4x6	silicone	MP2-1T

without control



fig.	Part No.	pump rate (l/h)	supply	application	HCø (mm)	hose	type
1	361778	0.5	230 VAC	rinse aid	4x6	silicone	MP2-B
1	361958 <sup>1</sup>	0.5	230 VAC	rinse aid	4x6	silicone	MP2-B
1	361780	1.5	230 VAC	detergent	4x6	Santoprene	MP2-B
1	361959 <sup>1</sup>	1.5	230 VAC	detergent	4x6	Santoprene	MP2-B
1	361782	3	230 VAC	detergent	4x6	Santoprene	MP2-B
1	361960 <sup>1</sup>	3	230 VAC	detergent	4x6	Santoprene	MP2-B

<sup>1</sup>with accessories

built-in version

with speed control



pos.	Part No.	pump rate (l/h)	supply	application	HCø (mm)	hose	type
1	361747	3	24 VAC	detergent	4x6	Santoprene	MP3-BT
2	361618	3	230 VAC	detergent	4x6	Santoprene	MP3-BT

with frequency control



fig.	Part No.	pump rate (l/h)	supply	application	HCø (mm)	hose	type
1	361746	1.5	24 VAC	detergent	4x6	Santoprene	MP3-BT
1	361617	1.5	230 VAC	detergent	4x6	Santoprene	MP3-BT
2	361803	4	230VAC	detergent	4x6	Santoprene	MP3-T

with time control



fig.	Part No.	pump rate (l/h)	supply	application	HCø (mm)	hose	type
1	361613	0.5	230 VAC	rinse aid	4x6	silicone	MP3-B1T
1	361614	1	230 VAC	rinse aid	4x6	silicone	MP3-B1T
2	361793	0.5	230 VAC	rinse aid	4x6	silicone	MP3-T
2	361000	3	230 VAC	detergent	4x6	Santoprene	MP3-T



fig.	Part No.	pump rate (l/h)	supply	application	HCø (mm)	hose	type
3	361915	1	230 VAC	rinse aid	4x6	silicone	MP3-T

without control



fig.	Part No.	pump rate (l/h)	supply	application	HCø (mm)	hose	type
1	361599	0.5	24 VAC	rinse aid	4x6	silicone	MP3
1	361097	0.5	230 VAC	rinse aid	4x6	silicone	MP3
1	361600	1.5	24 VAC	detergent	4x6	Santoprene	MP3
1	361098	1.5	230 VAC	detergent	4x6	Santoprene	MP3
1	361745	3	24 VAC	detergent	4x6	Santoprene	MP3
1	361685	3	230 VAC	detergent	4x6	Santoprene	MP3





spare parts

1



fig.	Part No.	description	application	HCø (mm)	hose type
1	361936	pump hose	detergent	5	Santoprene
1	361807	pump hose	detergent	6	Santoprene
1	361809	pump hose	detergent	8	Santoprene

2



fig.	Part No.	description	application	HCø (mm)	hose type
2	361549	pump hose	detergent	6	Santoprene

3



fig.	Part No.	description	application	HCø (mm)	hose type
3	361284	pump hose	detergent	4x6	Santoprene

4



fig.	Part No.	description	application	HCø (mm)	hose type
4	361595	pump hose	rinse aid	6	silicone

5



fig.	Part No.	description	application	HCø (mm)	hose type
5	361487	pump hose	rinse aid	4x6	silicone
5	361808	pump hose	rinse aid	4x6	silicone

1 2



fig.	Part No.	description	application	hose type
1	361514	roller assembly	detergent	Santoprene
2	361515	roller assembly	rinse aid	silicone

SAIER

wall-mounted version

with speed/time control

1 2





fig.	Part No.	pump rate (l/h)	supply	application	HCø (mm)	type
1	361664	0.6	230 VAC	rinse aid	5x8	COMPACT K
1	361663	4.5	230 VAC	detergent	5x8	COMPACT R
2	361660	6.0	230 VAC	detergent	6x2/6x3	DSP 2010 mcs

with conductivity/speed/time control

1



**technical data:**  
hose connector 6x2/6x3mm

fig.	Part No.	pump rate (l/h)	supply	application	type
1	361658	10	230 VAC	detergent	DSP 9905 mcs

2



**technical data:**  
hose connector 6x2/6x3mm

fig.	Part No.	pump rate (l/h)	supply	application	type
2	361918	up to 9.0	230 VAC	detergent	Concept 2105 mcs
2	361919	up to 9.0	230 VAC	rinse aid	Concept 2105 mcs

with conductivity control

1 2





fig.	Part No.	pump rate (l/h)	supply	application	HCø (mm)	type
1	361662	6	230 VAC	detergent	5x8	COMPACT L PLUS
2	361659	10	230 VAC	detergent	6x2/6x3	DSP9630 mcs

3

fig.	Part No.	pump rate (l/h)	supply	application	HCø (mm)	type
3	361920	up to 9.0	230 VAC	detergent	6x2/6x3	Concept 2114 mcs

**built-in version**  
**without control**



1 2

fig.	Part No.	pump rate (l/h)	supply	application	HCø (mm)	type
1	361830 <sup>1</sup>	10	230 VAC	detergent	6.3	DSP9911/10-E
2	361329	10	230 VAC	detergent	5x8	DSP9911E

<sup>1</sup>with accessories

**spare parts**



1

fig.	Part No.	description	application	HCø (mm)
1	361332	pump hose	detergent	4.8x8mm



2

fig.	Part No.	description	application	HCø (mm)
2	361674	pump hose	detergent	5x8



3

fig.	Part No.	description	application	HCø (mm)
3	361670	pump hose	rinse aid	3.2x6.4
3	361673	pump hose	rinse aid	4.8x9.6



1 2

fig.	Part No.	description	HCø (mm)
1	361671	hose holder	4.8
2	361676	hose holder	3.2-5x1.5



1

fig.	Part No.	description
1	361672	roller assembly



1 2

fig.	Part No.	description	application	HCø (mm)
1	361946	service kit	detergent	6x4
2	361947	service kit	rinse aid	6x4

**accessories**



1 2 3 4

fig.	Part No.	description
1	361669	conductivity probe 3/8" mounting ø 17mm
2	361921	conductivity probe bore ø 17mm detergent/rinse aid
3	361678	non-return valve inlet 5x8mm outlet 1/8" L 70mm
4	361677	tank inlet M10 stainless steel hose ø 5mm

**SEKO**  
**wall-mounted version**

**twin pump**



1 2

fig.	Part No.	pump rate (l/h)	supply	application	HCø (mm)	hose type
1	361220	7	24/230VAC	detergent/rinse aid	4x6	D/K
2	361442 <sup>1</sup>	1-4	24/230VAC	detergent/rinse aid	4x6	D/K

<sup>1</sup>with accessories



with speed control



fig.	Part No.	pump rate (l/h)	supply	application	HCø (mm)	hose type	hose	type
1	361163 <sup>1</sup>	0.15-1	230 VAC	rinse aid	4x6	D	Sekobril	PR
1	361434 <sup>1</sup>	0.6-4	24 VAC	detergent	4x6	K	Santoprene	PR
1	361156 <sup>1</sup>	0.6-4	230 VAC	detergent	4x6	K	Santoprene	PR
1	361435 <sup>1</sup>	1-7	24 VAC	detergent	4x6	K	Santoprene	PR
1	361157	1-7	230 VAC	detergent	4x6	K	Santoprene	PR
1	361907 <sup>1</sup>	1-7	230 VAC	detergent	4x6	K	Santoprene	PR
2	361246	0.5-1	230 VAC	rinse aid	6	C	Sekobril	PR
2	361247	1-7	230 VAC	detergent	6	I	Santoprene	PR
2	361436 <sup>1</sup>	3-18	230 VAC	detergent	8	J	Santoprene	PR

with conductivity control



fig.	Part No.	pump rate (l/h)	supply	application	HCø (mm)	hose type	hose	type
1	361161 <sup>1</sup>	6	230 VAC	detergent	4x6	K	Santoprene	PA
1	361162 <sup>1</sup>	9	230 VAC	detergent	4x6	K	Santoprene	PA

<sup>1</sup>with accessories

with time control



fig.	Part No.	pump rate (l/h)	supply	application	HCø (mm)	hose type	hose	type
1	361437 <sup>1</sup>	0.4	24 VAC	rinse aid	4x6	D	Sekobril	PM
1	361158 <sup>1</sup>	0.4	230 VAC	rinse aid	4x6	D	Sekobril	PM
1	361770 <sup>2</sup>	6	230 VAC	detergent	4x6	K	Santoprene	PM
2	361160 <sup>1</sup>	6	230 VAC	detergent	4x6	K	Santoprene	HP
2	361214 <sup>1</sup>	10	230 VAC	detergent	4x6	K	Santoprene	HP

<sup>1</sup>with accessories <sup>2</sup>incl. inlet and conveyor hose

without control

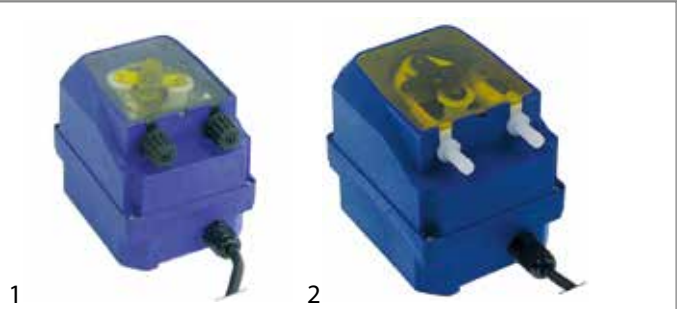

fig.	Part No.	pump rate (l/h)	supply	application	HCø (mm)	hose type	hose	type
1	361430 <sup>1</sup>	0.4	24 VAC	rinse aid	4x6	D	Sekobril	PE
1	361153 <sup>1</sup>	0.4	230 VAC	rinse aid	4x6	D	Sekobril	PE
1	361431 <sup>1</sup>	1.5	24 VAC	detergent	4x6	K	Santoprene	PE
1	361154 <sup>1</sup>	1.5	230 VAC	detergent	4x6	K	Santoprene	PE
1	361155 <sup>1</sup>	3	230 VAC	detergent	4x6	K	Santoprene	PE
2	361823	18	230 VAC	detergent	6.5	I	Santoprene	PE 18

<sup>1</sup>with accessories

built-in version

with frequency control



fig.	Part No.	pump rate (l/h)	supply	application	HCø (mm)	hose type	hose	type
1	361949	0.4	230 VAC	rinse aid	4x6	E	Sekobril	NBR 0.4
2	361948	3	230 VAC	detergent	4x6	H	Santoprene	NBR 3



fig.	Part No.	pump rate (l/h)	supply	application	HCø (mm)	hose type	hose	type
3	361767 <sup>1</sup>	3	230 VAC	detergent	4x6	K	Santoprene	NBR 3
4	361923	0.1-3	230 VAC	detergent	6	I	Santoprene	PBR

<sup>1</sup>incl. inlet and conveyor hose



fig.	Part No.	pump rate (l/h)	supply	application	HCø (mm)	hose type	hose	type
5	361215	0.3-3.0	230 VAC	detergent	4x6	K	Santoprene	PBR



with time control



fig.	Part No.	pump rate (l/h)	supply	application	HCø (mm)	hose type	hose	type
1	361768 <sup>1</sup>	0.4	230 VAC	rinse aid	4x6	D	Sekobril	NBM 0.4
2	361211 <sup>1</sup>	0.4	230 VAC	rinse aid	4x6	D	Sekobril	PBM

<sup>1</sup>with accessories



fig.	Part No.	pump rate (l/h)	supply	application	HCø (mm)	hose type	hose	type
3	361887	0.7	230 VAC	rinse aid	6	C	Sekobril	PBM
4	361250 <sup>1</sup>	0.7	230 VAC	rinse aid	4x6	B	Sekobril	PBM

<sup>1</sup>with accessories

without control



fig.	Part No.	pump rate (l/h)	supply	application	HCø (mm)	hose type	hose	type
1	361867	0.4	230 VAC	rinse aid	4x6	D	Sekobril	NPG 0.4
1	361929 <sup>1</sup>	0.4	230 VAC	rinse aid	4x6	E	Sekobril	NPG 0.4
1	361902	3	230 VAC	detergent	4x6	H	Santoprene	NPG 3
1	361954	3	230 VAC	detergent	4x6	K	Santoprene	NPG 3
2	361150 <sup>1</sup>	0.4	230 VAC	rinse aid	4x6	D	Sekobril	PG
2	361151 <sup>1</sup>	1.5	230 VAC	detergent	4x6	K	Santoprene	PG
2	361484 <sup>1</sup>	3	24 VAC	detergent	4x6	K	Santoprene	PG
2	361152 <sup>1</sup>	3	230 VAC	detergent	4x6	K	Santoprene	PG
2	361868	3	230 VAC	detergent	4x6	K	Santoprene	PG

<sup>1</sup>with accessories

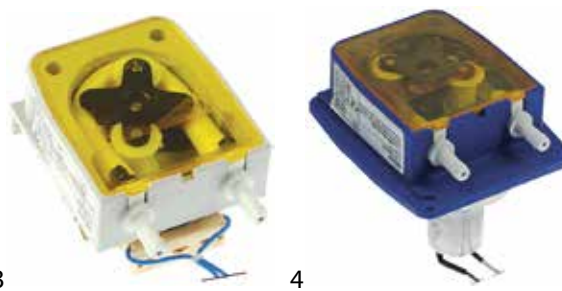

fig.	Part No.	pump rate (l/h)	supply	application	HCø (mm)	hose type	hose	type
3	361772 <sup>1</sup>	0.4	230 VAC	rinse aid	4x6	D	Sekobril	PG
3	361771 <sup>1</sup>	3	230 VAC	detergent	6	K	Santoprene	PG
4	361322 <sup>1</sup>	1	24VDC	rinse aid	6	B	Sekobril	PP
4	361884 <sup>1</sup>	1.25	24VDC	rinse aid	6	A	Sekobril	PP
4	361321 <sup>1</sup>	7	24VDC	detergent	6	I	Santoprene	PP

<sup>1</sup>with accessories

spare parts



fig.	Part No.	description	application	hose ø (mm)	HCø (mm)	hose type	hose
1	698712	dosing hose	detergent	4x8.6mm	4x6	H	Santoprene



fig.	Part No.	description	application	hose ø (mm)	HCø (mm)	hose type	hose
2	361238	pump hose	detergent	6x10	6	I	Santoprene



fig.	Part No.	description	application	hose ø (mm)	HCø (mm)	hose type	hose
3	361445	pump hose	detergent	6x10	10	J	Santoprene



fig.	Part No.	description	application	hose ø (mm)	HCø (mm)	hose type	hose
4	361815	pump hose	detergent	6x10	4x6	K	Santoprene



fig.	Part No.	description	application	hose ø (mm)	HCø (mm)	hose type	hose
5	361239	pump hose	rinse aid	3x7	6	A	Sekobril



fig.	Part No.	description	application	hose ø (mm)	HCø (mm)	hose type	hose
6	361882	pump hose	rinse aid	3x7.4	6	B	Sekobril





7



fig.	Part No.	description	application	hose ø (mm)	HCø (mm)	hose type	hose
7	361890	pump hose	rinse aid	3x8	6	C	Sekobril

8



fig.	Part No.	description	application	hose ø (mm)	HCø (mm)	hose type	hose
8	361925 <sup>1</sup>	pump hose	rinse aid	3x8	6	E	Sekobril

<sup>1</sup>with backflow preventer

9



fig.	Part No.	description	application	hose ø (mm)	HCø (mm)	hose type	hose
9	361135	pump hose	rinse aid	3x8	4x6	D	Sekobril

10



fig.	Part No.	description	application	hose ø (mm)	HCø (mm)	hose type	hose
10	698710 <sup>1</sup>	dosing hose	rinse aid	5x10	4x6	F	Sekobril

<sup>1</sup>with backflow preventer

11



fig.	Part No.	description	application	hose ø (mm)	HCø (mm)	hose type	hose
11	698711	dosing hose	rinse aid	6x10	4x6	G	Sekobril

1



fig.	Part No.	description
1	361136	roller assembly for dosing pump hole ø 4.8x4mm

**piston pumps**

**dosing pumps**

1 2



fig.	Part No.	type	volt. (V)	application	inlet (mm)	outlet (mm)
1	361941	14825-645	230	detergent	7	9
2	361260	BR3	230	detergent	6	6

3 4



fig.	Part No.	type	volt. (V)	application	inlet (mm)	outlet (mm)
3	361597	DB	115-230	rinse aid	6	6
4	361596	DT	115-230	detergent	6	6

5 6



fig.	Part No.	type	volt. (V)	application	inlet (mm)	outlet (mm)
5	361800	EKP-R/E	230	detergent	8x12	8x12
6	361235 <sup>1</sup>	ELT 20	180-260	rinse aid/detergent	6	6

<sup>1</sup>with accessories

7



fig.	Part No.	type	volt. (V)	application	inlet (mm)	outlet (mm)
7	361838	TTE	200-240	detergent	5.5	5.5

**with solenoid coil**

1



**technical data:**  
voltage 230V  
duty cycle 25%

fig.	Part No.	inlet (mm)	outlet (mm)	application	type
1	361004	5	5	rinse aid	DB2

2



**technical data:**  
voltage 230V  
duty cycle 25%

fig.	Part No.	inlet (mm)	outlet (mm)	application	type
2	361013	4x6	5	rinse aid	EKP-M





spare parts



fig.	Part No.	description
1	361113	solenoid coil 230 VAC for type DB2
2	361482	solenoid coil 230 VAC for type EKP-M



fig.	Part No.	description
1	361654	hose tail suitable for EKP-R
2	510298	lip valve dosing pump suitable for DB2/DS5
3	361653	olive suitable for EKP-R
4	361655	O-ring suitable for EKP-R



fig.	Part No.	description
5	361366	PCB dishwasher 11F suitable for DB2 type DB2/EV1/EKP-M
6	361047	pressure/suction valve suitable for EKP-R
7	361652	union nut suitable for EKP-R T1: 3/8"

membrane dosing pumps

electric dosing pumps

Delta



fig.	Part No.	volt. (V)	duty cycle (%)	type	valve
1	361003	220	25	EL-1	lip valve
2	361861	220	25	ELT 10	with piston
3	361001	220	100	DELTA	lip valve
3	361023 <sup>1</sup>	230	100	DELTA	lips/SS valve

<sup>1</sup>lip valve SS

spare parts



fig.	Part No.	description
1	361188	disc type DELTA
2	361319	gasket rubber ID ø 9mm ED ø 14,5mm thickness 1mm type DELTA
3	361169	hose connector type DELTA
4	361950	lip valve DELTA
5	361122	lip valve type DELTA



fig.	Part No.	description
6	361123	membrane type DELTA
7	361168	valve type DELTA

self-priming

LANG



fig.	Part No.	type	application	p conn. ø (mm)	suction connection ø (mm)
1	361032	N6	rinse aid	angled, 4x6	angled, 4x6
2	361008 <sup>1</sup>	N6	rinse aid	angled, 4x6	straight, 4x6

<sup>1</sup>with accessories



fig.	Part No.	type	application	p conn. ø (mm)	suction connection ø (mm)
3	361916	N6	rinse aid	angled, 6	angled, 6
4	361221	N6	rinse aid	straight, 4x6	6x8



fig.	Part No.	type	application	p conn. ø (mm)	suction connection ø (mm)
5	361575	N6	rinse aid	straight, 4x6	angled, 6
6	361817	N6	rinse aid	straight, 4x6	angled, 6



fig.	Part No.	description
5	361086	hose connector with union nut elbow connection
6	361316	hose connector with union nut T1: 3/8"
7	101286	olive ID ø 6mm Qty 1 pcs
7	102586	olive ID ø 6mm Qty 10 pcs
8	361475	screw connection pressure connection SS



fig.	Part No.	type	application	p conn. ø (mm)	suction connection ø (mm)
7	361009	N6	rinse aid	straight, 4x6	straight, 4x6
8	361056	N6	rinse aid	VA steel	straight, 4x6



fig.	Part No.	description
9	361313	screw connection spring adapter
10	361076	strengthening pipe L 18mm thickness 0,5mm
11	361083	union nut T1: M10x1 for hose 6mm
12	361072	union screw SST1: M10x1

spare parts



fig.	Part No.	description
1	361309	ball for type N5/N6
2	361310	bracket for type N6 ball guide
3	361311	O-ring EPDM thickness 2mm ID ø 6mm Qty 1 pcs
4	361317	sealing disc for type N6

SEKO



fig.	Part No.	type	application	pump rate	p conn. ø (mm)	suction connection ø (mm)
1	361217	DIB3E	rinse aid	0-3cm³ per stroke	4x6	4x6
2	361594	DIB3E	rinse aid	0-3cm³ per stroke	4x6	4x6



fig.	Part No.	description
5	361079	spring for type N5/N6 for ball
6	361314	valve ring for type N6 holder for O-ring

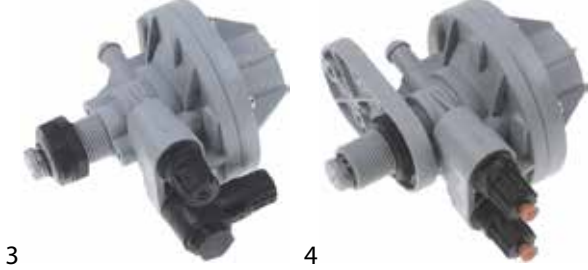

fig.	Part No.	type	application	pump rate	p conn. ø (mm)	suction connection ø (mm)
3	361837 <sup>1</sup>	DIB5E	rinse aid	0-5cm³ per stroke	4x6	6
4	361038 <sup>1</sup>	DIB5E	rinse aid	0-5cm³ per stroke	4x6	4x6

<sup>1</sup>auxiliary pressure connection closed

accessories



fig.	Part No.	description
1	361473	hose connector angled hose ø 6mm
2	361476	hose connector elbow connection
3	361318	hose connector T1: 3/8" mounting pos. pump outlet
4	361081	hose connector T1: M16x1.5 hose ø 4mm



fig.	Part No.	type	application	pump rate	p conn. ø (mm)	suction connection ø (mm)
5	361364 <sup>1</sup>	DIB5E	rinse aid	0-5cm <sup>3</sup> per stroke	4x6	4x6

<sup>1</sup>auxiliary pressure connection closed



fig.	Part No.	application	inlet (mm)	outlet (mm)	p conn. ø (mm)	suction connection ø (mm)
3	361002	rinse aid	6x8	4x6	4x6	6x8
4	361015	rinse aid	6x8	4x6	4x6	6x8

spare parts



fig.	Part No.	description
1	361301	hose connector for type DIB3E/DIB5E
2	361481	lip valve for type DIB3P/DIB5P DIB3E/DIB5E
3	361307	membrane dosing pump ø 68mm hole ø 6mm for type DIB3P/DIB5P
4	361306	membrane for type DIB3E/DIB5E ø 49mm hole ø 5mm

spare parts



fig.	Part No.	description
1	510916	filter for dosing pump
2	510870	filter support for dosing pump
3	510847	gasket polishing agent dosing ID ø 22mm ED ø 32mm
4	361459	hose connector ø 6mm for dosing pump



fig.	Part No.	description
5	361304	O-ring for type DIB3E/DIB5E EPDM ID ø 11,11mm thickness 1,78mm Qty 1 pcs
6	361302	valve bush for type DIB3E/DIB5E
7	361305	valve disc for type DIB3E/DIB5E DIB3P/DIB5P



fig.	Part No.	description
5	510298	lip valve dosing pump suitable for DB2/DS5
6	361132	membrane dosing pump
7	361307	membrane dosing pump ø 68mm hole ø 6mm
8	510297	membrane for dosing pump ED ø 83mm thickness 1mm

accessories



fig.	Part No.	description
1	361240	hose connector 1-way hose ø 6mm plastic
1	361241	hose connector 1-way hose ø 9mm plastic



fig.	Part No.	description
9	510229	T-piece dosing pump ø 28mm L 70mm
10	510338	union nut dosing pump thread 1/2" ø 32mm H 15mm

various



fig.	Part No.	application	inlet (mm)	outlet (mm)	p conn. ø (mm)	suction connection ø (mm)
1	361731	rinse aid	4	8	8	4
2	361370	rinse aid	4x6	4x6	4x6	4x6



## self-priming with supporting pressure

## DIHR

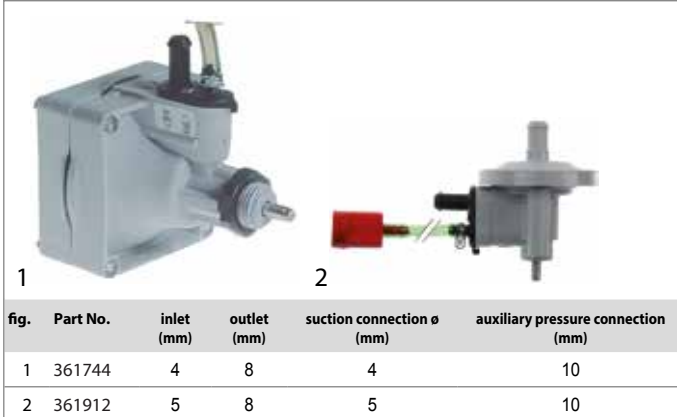

fig.	Part No.	inlet (mm)	outlet (mm)	suction connection ø (mm)	auxiliary pressure connection (mm)
1	361744	4	8	4	10
2	361912	5	8	5	10

## ELETTOBAR



fig.	Part No.	application	p conn. ø (mm)
1	361362	rinse aid	6

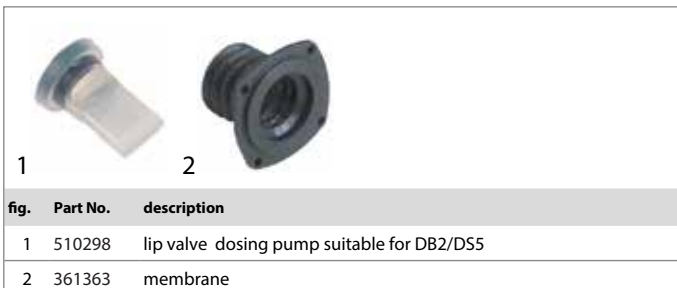

fig.	Part No.	description
1	510298	lip valve dosing pump suitable for DB2/DS5
2	361363	membrane

## GERMAC

## type 1000

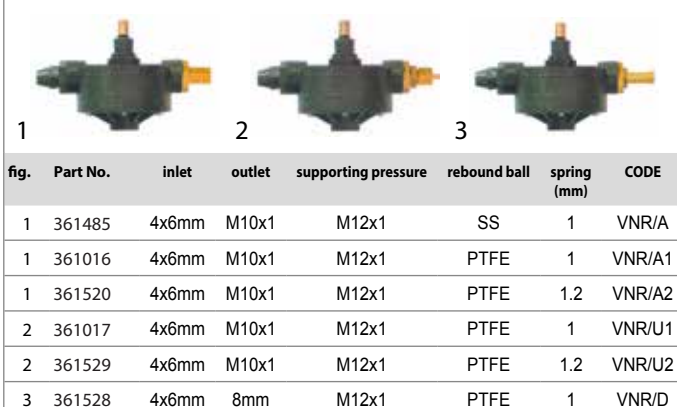

fig.	Part No.	inlet	outlet	supporting pressure	rebound ball	spring (mm)	CODE
1	361485	4x6mm	M10x1	M12x1	SS	1	VNR/A
1	361016	4x6mm	M10x1	M12x1	PTFE	1	VNR/A1
1	361520	4x6mm	M10x1	M12x1	PTFE	1.2	VNR/A2
2	361017	4x6mm	M10x1	M12x1	PTFE	1	VNR/U1
2	361529	4x6mm	M10x1	M12x1	PTFE	1.2	VNR/U2
3	361528	4x6mm	8mm	M12x1	PTFE	1	VNR/D

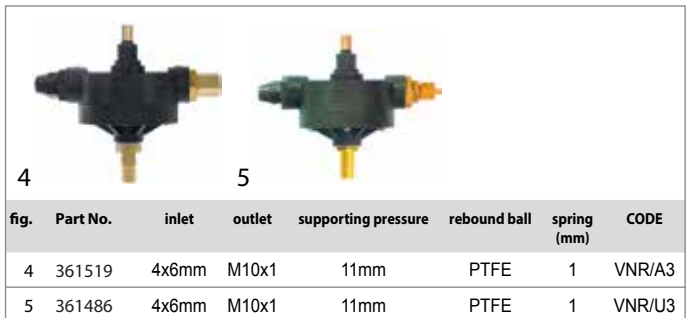

fig.	Part No.	inlet	outlet	supporting pressure	rebound ball	spring (mm)	CODE
4	361519	4x6mm	M10x1	11mm	PTFE	1	VNR/A3
5	361486	4x6mm	M10x1	11mm	PTFE	1	VNR/U3

## type 2000

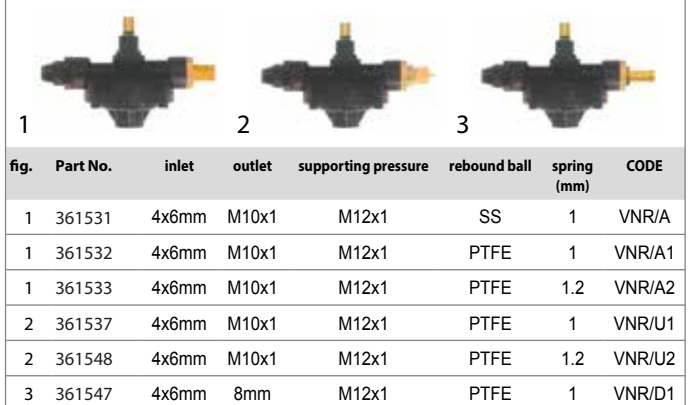

fig.	Part No.	inlet	outlet	supporting pressure	rebound ball	spring (mm)	CODE
1	361531	4x6mm	M10x1	M12x1	SS	1	VNR/A
1	361532	4x6mm	M10x1	M12x1	PTFE	1	VNR/A1
1	361533	4x6mm	M10x1	M12x1	PTFE	1.2	VNR/A2
2	361537	4x6mm	M10x1	M12x1	PTFE	1	VNR/U1
2	361548	4x6mm	M10x1	M12x1	PTFE	1.2	VNR/U2
3	361547	4x6mm	8mm	M12x1	PTFE	1	VNR/D1

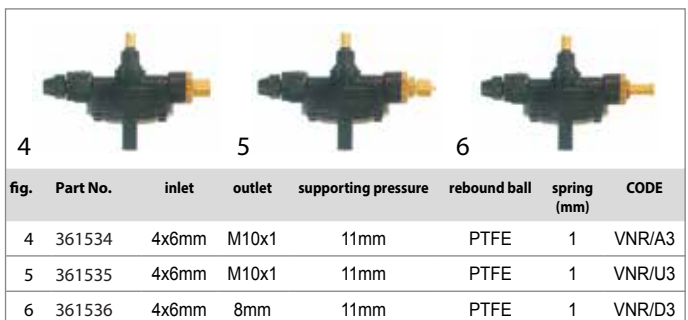

fig.	Part No.	inlet	outlet	supporting pressure	rebound ball	spring (mm)	CODE
4	361534	4x6mm	M10x1	11mm	PTFE	1	VNR/A3
5	361535	4x6mm	M10x1	11mm	PTFE	1	VNR/U3
6	361536	4x6mm	8mm	11mm	PTFE	1	VNR/D3

## type 2001

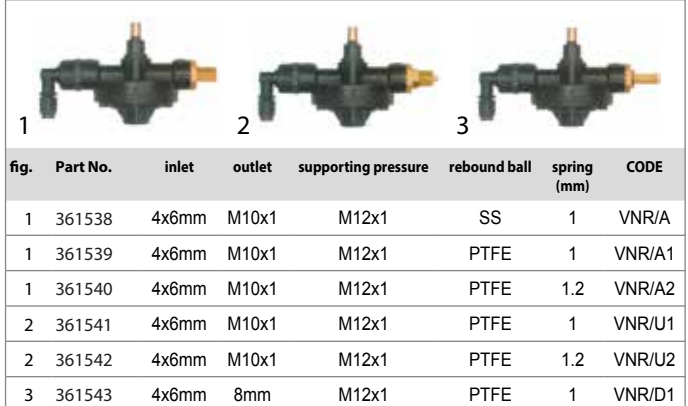

fig.	Part No.	inlet	outlet	supporting pressure	rebound ball	spring (mm)	CODE
1	361538	4x6mm	M10x1	M12x1	SS	1	VNR/A
1	361539	4x6mm	M10x1	M12x1	PTFE	1	VNR/A1
1	361540	4x6mm	M10x1	M12x1	PTFE	1.2	VNR/A2
2	361541	4x6mm	M10x1	M12x1	PTFE	1	VNR/U1
2	361542	4x6mm	M10x1	M12x1	PTFE	1.2	VNR/U2
3	361543	4x6mm	8mm	M12x1	PTFE	1	VNR/D1

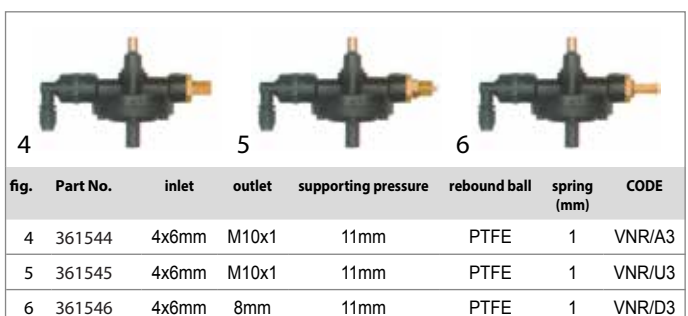

fig.	Part No.	inlet	outlet	supporting pressure	rebound ball	spring (mm)	CODE
4	361544	4x6mm	M10x1	11mm	PTFE	1	VNR/A3
5	361545	4x6mm	M10x1	11mm	PTFE	1	VNR/U3
6	361546	4x6mm	8mm	11mm	PTFE	1	VNR/D3





spare parts



fig.	Part No.	description
1	361551	compression spring wire gauge $\phi$ 1mm
2	361705	gasket for hose connector M12x1
3	361702	hose connector brass hose $\phi$ 4x6mm
4	361704	hose connector brass straight thread M12x1



fig.	Part No.	description
5	361550	hose connector hose $\phi$ 4x6mm
6	361700	hose connector rotary hose $\phi$ 4x6mm plastic
7	361703	hose connector thread M10x1 brass
8	361701	hose connector thread M10x1 grommet $\phi$ 7,5mm

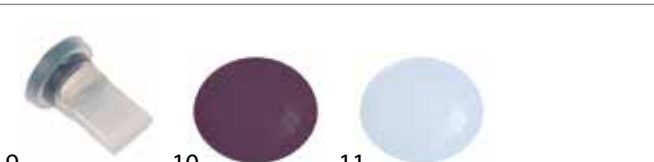

fig.	Part No.	description
9	510298	lip valve dosing pump suitable for DB2/D55
10	361553	membrane EPDM
11	510296	membrane silicone

GIADOS



fig.	Part No.	application	p conn. $\phi$ (mm)	suction connection $\phi$ (mm)	auxiliary pressure connection (mm)
1	361883	rinse aid	4x6	4x6	12

HOONVED



fig.	Part No.	application	p conn. $\phi$ (mm)	suction connection $\phi$ (mm)	auxiliary pressure connection (mm)
1	361908	rinse aid	7	5	10
1	361387	rinse aid	8	4	10
2	361010	rinse aid	4x6	4	10



fig.	Part No.	description	fig.	Part No.	description
1	361383	lip valve rinse aid	2	361384	membrane rinse aid

OMNIWASH



fig.	Part No.	application	p conn. $\phi$ (mm)	suction connection $\phi$ (mm)	auxiliary pressure connection (mm)
1	361054	rinse aid	6	6	10



fig.	Part No.	description	fig.	Part No.	description
1	361348	lip valve rinse aid	2	361308	membrane rinse aid

SEKO



**technical data:**  
auxiliary pressure connection 10mm

fig.	Part No.	type	application	pump rate (l/h)	suction connection $\phi$ (mm)
1	361218	DIB3P	rinse aid	0-3cm <sup>3</sup> per stroke	4x6



**technical data:**  
auxiliary pressure connection 10mm

fig.	Part No.	type	application	pump rate (l/h)	suction connection $\phi$ (mm)
2	361039	DIB5P	rinse aid	0-5cm <sup>3</sup> per stroke	4x6



fig.	Part No.	description	for type
1	361301	hose connector	DIB3E/DIB5E
2	361306	membrane	DIB3E/DIB5E
3	361304	O-ring	DIB3E/DIB5E
4	361302	valve bush	DIB3E/DIB5E





fig.	Part No.	description	for type
5	361305	valve disc	DIB3E/DIB5E
6	361481	lip valve	DIB3P/DIB5P
7	361307	membrane	DIB3P/DIB5P

## electronic controllers



fig.	Part No.	volt. (V)	fig.	Part No.	volt. (V)
1	361223	230	2	361261	230

## accessories

### container filters

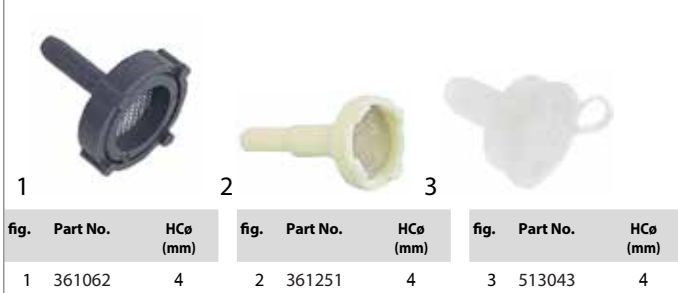

fig.	Part No.	HCø (mm)	fig.	Part No.	HCø (mm)	fig.	Part No.	HCø (mm)
1	361062	4	2	361251	4	3	513043	4



fig.	Part No.	HCø (mm)	fig.	Part No.	HCø (mm)	fig.	Part No.	HCø (mm)
1	361141	4	2	361829	5	3	361230	4x6

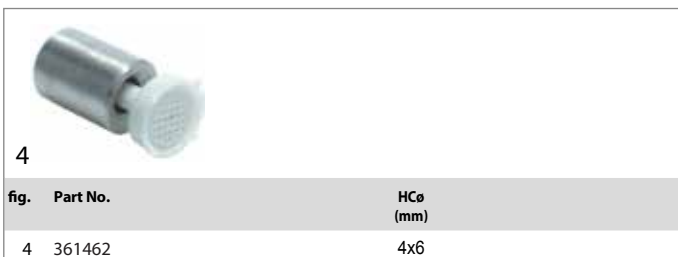

fig.	Part No.	HCø (mm)
4	361462	4x6

### container filters with non-return valve



fig.	Part No.	HCø (mm)	L (mm)	fig.	Part No.	HCø (mm)	L (mm)
1	361106	4x6	51	3	361888	4x6	56
2	361058	4x6	56				

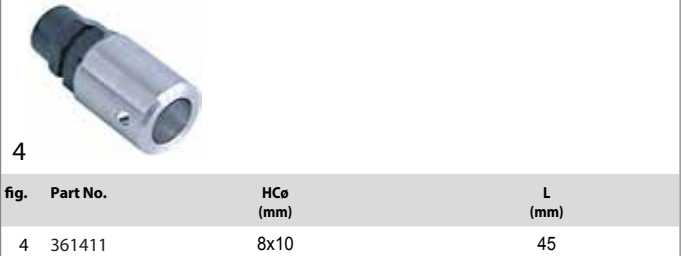

fig.	Part No.	HCø (mm)	L (mm)
4	361411	8x10	45

### filter weights

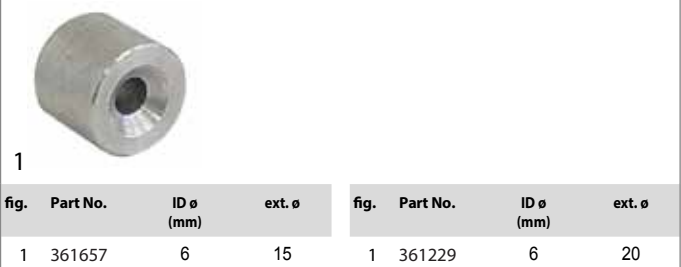

fig.	Part No.	ID ø (mm)	ext. ø	fig.	Part No.	ID ø (mm)	ext. ø
1	361657	6	15	2	361229	6	20

### electrodes for conductivity control



fig.	Part No.	mounting ø (mm)	fig.	Part No.	mounting ø (mm)
1	361068	12	3	361669	17
2	361274	17			



fig.	Part No.	mounting ø (mm)	fig.	Part No.	mounting ø (mm)
4	361149	21	5	361414	22



non-return valves



fig.	Part No.	inlet (mm)	outlet	L (mm)
1	361899	-	-	9
2	361886	-	-	12.7
3	361898	6	6mm	48
4	361578	6	4x6mm	40



fig.	Part No.	inlet (mm)	outlet	L (mm)
5	361489	6	4x6mm	50
6	361488	4x6	1/8"	40
7	361147	4x6	1/8"	50
8	361821	4x6	1/4"	45



fig.	Part No.	inlet (mm)	outlet	L (mm)
9	508326	4x6	M10x1 IT	56
10	361678	5x8	1/8"	70

intake lances

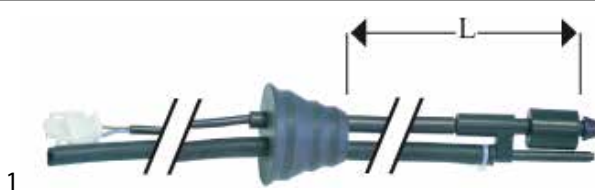

fig.	Part No.	L (mm)	version	HCø (mm)	CL (mm)
1	361911	165	NC	4.5	1750
1	361582	345	NC	6x8	1500
1	361581	345	NO	6x8	1500
1	361583	355	NC	6x8	1500
1	698713	380	with plug	5	1500
1	361262	445	NO	6x8	1500



fig.	Part No.	L (mm)	tube ø (mm)	HCø (mm)	CL (mm)
1	361118	415	10	4x6	-



fig.	Part No.	L (mm)	tube ø (mm)	HCø (mm)	CL (mm)
1	361164	500	21	4x6	-
1	361165	500	21	4x6	2500



fig.	Part No.	L (mm)	tube ø (mm)	HCø (mm)	CL (mm)
1	361904	425	25	5/7	3000
1	361889	425	25	6x8	3000



fig.	Part No.	L (mm)	tube ø (mm)	CL (mm)
1	361790	430	6	-



fig.	Part No.	L (mm)	tube ø (mm)	HCø (mm)	fig.	Part No.	L (mm)	tube ø (mm)	HCø (mm)
1	361412	450	10	JG 6	1	361413	450	10	JG 10

hoses

hoses Santoprene



pos.	Part No.	ID ø (mm)	ED ø (mm)	Shore (°)	Qty (m)
1	361631	2.4	5.6	64	5
2	361632	3	5	64	5
3	361633	3.2	6.4	64	5
4	361634	4	6	64	5
5	361635	4	7	64	5
6	361636	4	8	64	5
7	361637	5	8	64	5
8	361638	6	9	64	5
9	361639	6	10	64	5
10	361549	6	10.5	55	1
11	361640	7	10	64	5

silicone hoses



pos.	Part No.	ID ø (mm)	ED ø (mm)	L (m)	t.max. (°C)	Shore A (°)
1	361601	2	5.2	5	200	55
2	570601	2	5.2	100	200	55
3	361602	2.5	5.7	5	200	55
4	570602	2.5	5.7	100	200	55
5	361603	3	5	5	200	55

Table continues overleaf



pos.	Part No.	ID ø (mm)	ED ø (mm)	L (m)	t.max. (°C)	Shore A (°)
6	570603	3	5	100	200	55
7	361604	3	6	5	200	55
8	570604	3	6	100	200	55
9	361605	3	7	5	200	55
10	570605	3	7	100	200	55
11	520242	4	7	5	200	55
12	570606	4	7	100	200	55
13	361607	4	7.2	5	200	55
14	361608	4	8	5	200	55
15	570608	4	8	100	200	55
16	570611 <sup>1</sup>	5	8	-	200	55
17	361609	5	8	5	200	55
18	570609	5	8	100	200	55
19	361610	5	9	5	200	55
20	570550	6	10	100	200	55

<sup>1</sup>by the meter

## PVC hoses



pos.	Part No.	ID ø (mm)	ED ø (mm)	L (m)	pos.	Part No.	ID ø (mm)	ED ø (mm)	L (m)
1	520090	4	6	2	3	570127	4	6	4
2	570123	4	6	3.5					

## hose connectors



fig.	Part No.	version	hose ø (mm)	fig.	Part No.	version	hose ø (mm)
1	361494	2-way	4-4	1	361496	2-way	8-8
1	361497	2-way	4-6	1	361679	2-way	10-10
1	361498	2-way	4-8	1	361680	2-way	12-12
1	361495	2-way	6-6	1	361681	2-way	13-13
1	361499	2-way	6-8	1	361682	2-way	19-19

## hose couplings

## plastic



fig.	Part No.	hose ø (mm)	version	fig.	Part No.	hose ø (mm)	version
1	361094	4x6-4x6	straight	1	361095	6x8-6x8	straight
1	361096	4x6-6x8	straight				



fig.	Part No.	hose ø (mm)	connection	fig.	Part No.	hose ø (mm)	connection
1	361099	4	M10x1	3	361240	6	M10x1
1	361100	6	M10x1	3	361241	9	M10x1
2	361101	4	M10x1	4	361566	8	M15x1.5
2	361102	6	M10x1				



fig.	Part No.	hose ø (mm)	connection	fig.	Part No.	hose ø (mm)	connection
5	361845	10	3/8"	7	361091	6x8	M10x1
6	361493	6x8	1/8"	8	361700	4x6	M10x1
7	361090	4x6	M10x1				

## metal



fig.	Part No.	hose ø (mm)	fig.	Part No.	hose ø (mm)	fig.	Part No.	hose ø (mm)
1	361176	4x6	2	361177	4x6	3	361180	4x6
1	361508	6x8	2	361509	6x8	3	361510	6x8



fig.	Part No.	hose ø (mm)	TS	fig.	Part No.	hose ø (mm)	TS
1	361253	6	1/8"	3	361175	4/6	3/8"
2	361170	4/6	1/8"	3	361503	6/8	1/8"
2	361171	4/6	1/4"	3	361504	6/8	1/4"
2	361172	4/6	3/8"	4	361178	4/6	1/8"
2	361500	6/8	1/8"	4	361179	4/6	1/4"
2	361501	6/8	1/4"	4	361506	6/8	1/8"
3	361173	4/6	1/8"	4	361507	6/8	1/4"
3	361174	4/6	1/4"				



fig.	Part No.	TS	WS	material
1	361181	1/8"	14	nickel-plated brass
1	361182	1/4"	17	nickel-plated brass
1	361183	3/8"	20	nickel-plated brass
1	361184	1/2"	24	nickel-plated brass



T-pieces

with non-return valve



fig.	Part No.	version	HCø (mm)
1	361103	with non-return valve	10-4-6
2	361415	with non-return valve	13-4-6

without non-return valve



fig.	Part No.	version	HCø (mm)	fig.	Part No.	version	HCø (mm)
1	361107	3-way	11-4-11	3	361490	3-way	10-8-10
2	508123	3-way	13-5-13	3	361492	3-way	12-8-12
3	361491	3-way	12-6-12	3	519217	3-way	12-9-12
3	516082	3-way	12-7-12	4	361189	3-way	12-12

tank inlets



fig.	Part No.	material	mounting	HCø (mm)
1	508301	plastic	M9x1.5	4
2	361858	plastic	M10	5.5
3	361057	plastic	M10	4x6
4	361105	plastic	M10	4x6



fig.	Part No.	material	mounting	HCø (mm)
5	510816	stainless steel	M10	4
6	361677	stainless steel	M10	5
7	361855	stainless steel	M10	4/5/6
7	361856	stainless steel	M12	4/5/6
8	361656	stainless steel	M10x1.5	4

mounting sets



fig.	1
Part No.	361891
app.	detergent
hose type	4x6mm
hose length (m)	2
material	PVC
scope of delivery	2x hose/container filter/tank intake



fig.	2
Part No.	361142
app.	detergent
hose type	4x6mm
hose length (m)	2
material	PVC
scope of delivery	2x hose/container filter/tank intake



fig.	3
Part No.	361222 <sup>1</sup>
app.	detergent
hose type	4x6mm
hose length (m)	2
material	PVC
scope of delivery	2x hose/container filter/tank intake

<sup>1</sup>with hose connector



fig.	4
Part No.	361143
app.	detergent
hose type	4x6mm
hose length (m)	2
material	PVC
scope of delivery	2x hose/container filter/tank intake/electrode



5	
<b>fig.</b>	5
<b>Part No.</b>	361511
<b>app.</b>	detergent
<b>hose type</b>	6x9mm
<b>hose length (m)</b>	2
<b>material</b>	PVC
<b>scope of delivery</b>	2x hose/container filter/tank intake



7	
<b>fig.</b>	7
<b>Part No.</b>	361144
<b>app.</b>	rinse aid
<b>hose type</b>	4x6mm
<b>hose length (m)</b>	2
<b>material</b>	PVC/nylon hose
<b>scope of delivery</b>	container filter/non-return valve



6	
<b>fig.</b>	6
<b>Part No.</b>	361942
<b>app.</b>	detergent/rinse aid
<b>hose type</b>	6x9mm
<b>hose length (m)</b>	2x2
<b>material</b>	PVC
<b>scope of delivery</b>	incl. container filter and screw connection



**GASTROPARTS.COM**

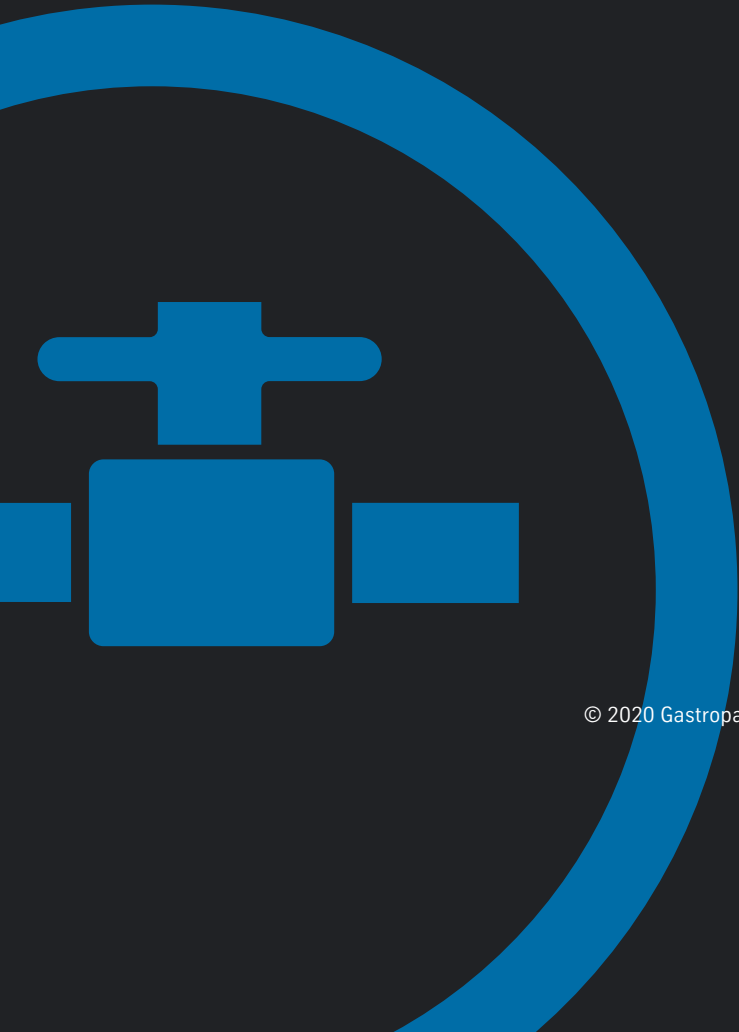

© 2020 Gastroparts Sp. J. All rights reserved.