



**GASTROPARTS**

Universal Catalogue › Wash and rinse pumps ›

# FIR

✉ [gastroparts@gastroparts.com](mailto:gastroparts@gastroparts.com)

☎ tel. +48 56 657 00 66

📘 [fb.com/gastroparts.global](https://fb.com/gastroparts.global)

**GASTROPARTS.COM**





## pumps

## wash and rinse pumps

FIR

pumps







1

<b>Part No.</b>	499004	<b>Ref. No.</b>	1291.1670
<b>description</b>	pump inlet $\varnothing$ 28mm outlet $\varnothing$ 26mm type 1291.1670 230V 50Hz 1 phase 0,07kW 0,1HP L 195mm rotation direction right capacitor 5 $\mu$ F FIR		
<b>spare parts for</b>	499004		
	<b>Part No.</b>	365017	<b>Ref. No.</b> —
	operating capacitor capacity 5 $\mu$ F 450V		



1

<b>Part No.</b>	500387	<b>Ref. No.</b>	2211.1408
<b>description</b>	pump inlet $\varnothing$ 28mm outlet $\varnothing$ 26mm type 2211.1408 220V 50Hz 1 phase 0,074kW 0,1HP L 190mm rotation direction left capacitor 5 $\mu$ F FIR 2600rpm		
<b>spare parts for</b>	500387		
	<b>Part No.</b>	365017	<b>Ref. No.</b> —
	operating capacitor capacity 5 $\mu$ F 450V		
	<b>Part No.</b>	510384	<b>Ref. No.</b> N/A
	pump cover inlet $\varnothing$ 28 mm outlet $\varnothing$ 26 mm $\varnothing$ 100 mm		
	<b>Part No.</b>	510695	<b>Ref. No.</b> N/A
	mechanical shaft seal height counter ring 5,5 mm		

<b>spare parts for</b>	500387		
	<b>Part No.</b>	521203	<b>Ref. No.</b> N/A
	impellor $\varnothing$ 72 mm H 18 mm thread M7 shaft $\varnothing$ 11 mm		
	<b>Part No.</b>	521703	<b>Ref. No.</b> N/A
	pump cover gasket EPDM thickness 2,5 mm ID $\varnothing$ 75 mm		



1

<b>Part No.</b>	500037	<b>Ref. No.</b>	2211.1402 2211.1410
<b>description</b>	pump inlet $\varnothing$ 28mm outlet $\varnothing$ 26mm type 2211.1410 230V 50Hz 1 phase 0.074kW 0,1HP L 190mm rotation direction left capacitor 5 $\mu$ F FIR		
<b>spare parts for</b>	500037		
	<b>Part No.</b>	365017	<b>Ref. No.</b> —
	operating capacitor capacity 5 $\mu$ F 450V		
	<b>Part No.</b>	510384	<b>Ref. No.</b> N/A
	pump cover inlet $\varnothing$ 28 mm outlet $\varnothing$ 26 mm $\varnothing$ 100 mm		
	<b>Part No.</b>	510695	<b>Ref. No.</b> N/A
	mechanical shaft seal height counter ring 5,5 mm		
	<b>Part No.</b>	521203	<b>Ref. No.</b> N/A
	impellor $\varnothing$ 72 mm H 18 mm thread M7 shaft $\varnothing$ 11 mm		
	<b>Part No.</b>	521703	<b>Ref. No.</b> N/A
	pump cover gasket EPDM thickness 2,5 mm ID $\varnothing$ 75 mm		



1

<b>Part No.</b>	499079	<b>Ref. No.</b>	2211.1610
<b>description</b>	pump inlet $\varnothing$ 28mm outlet $\varnothing$ 26mm type 2211.1610 220-240V 50Hz 1 phase 0,07kW 0,1HP rotation direction left capacitor 5 $\mu$ F FIR		
<b>spare parts for</b>	499079		
	Part No.	365017	Ref. No. —
	operating capacitor capacity 5 $\mu$ F 450V		
	Part No.	510384	Ref. No. N/A
	pump cover inlet $\varnothing$ 28 mm outlet $\varnothing$ 26 mm $\varnothing$ 100 mm		
	Part No.	510695	Ref. No. N/A
	mechanical shaft seal height counter ring 5,5 mm		
	Part No.	521203	Ref. No. N/A
	impellor $\varnothing$ 72 mm H 18 mm thread M7 shaft $\varnothing$ 11 mm		
	Part No.	521703	Ref. No. N/A
	pump cover gasket EPDM thickness 2,5 mm ID $\varnothing$ 75 mm		



1

<b>Part No.</b>	500457	<b>Ref. No.</b>	2213.1417
<b>description</b>	pump inlet $\varnothing$ 28mm outlet $\varnothing$ 26mm type 2213.1417 230V 50Hz 1 phase 0,15kW 0,2HP L 198mm rotation direction left capacitor 6,3 $\mu$ F FIR		
<b>spare parts for</b>	500457		
	Part No.	365012	Ref. No. —
	operating capacitor capacity 6,3 $\mu$ F 450V		

<b>spare parts for</b>	500457		
	Part No.	510384	Ref. No. N/A
	pump cover inlet $\varnothing$ 28 mm outlet $\varnothing$ 26 mm $\varnothing$ 100 mm		
	Part No.	510695	Ref. No. N/A
	mechanical shaft seal height counter ring 5,5 mm		
	Part No.	521703	Ref. No. N/A
	pump cover gasket EPDM thickness 2,5 mm ID $\varnothing$ 75 mm		



1





<b>Part No.</b>	500465	<b>Ref. No.</b>	2213.1601
<b>description</b>	pump inlet $\varnothing$ 28mm outlet $\varnothing$ 26mm type 2213.1601 230V 50Hz 1 phase 0,11kW 0,15HP L 195mm rotation direction left capacitor 5 $\mu$ F FIR		
<b>spare parts for</b>	500465		
	Part No.	365017	Ref. No. —
	operating capacitor capacity 5 $\mu$ F 450V		
	Part No.	510384	Ref. No. N/A
	pump cover inlet $\varnothing$ 28 mm outlet $\varnothing$ 26 mm $\varnothing$ 100 mm		
	Part No.	510695	Ref. No. N/A
	mechanical shaft seal height counter ring 5,5 mm		
	Part No.	511711	Ref. No. —
	O-ring EPDM thickness 3,53mm ID $\varnothing$ 78,97mm		
	Part No.	521266	Ref. No. N/A
	impellor $\varnothing$ 67 mm H 18 mm thread M7 shaft $\varnothing$ 11 mm		



1

<b>Part No.</b>	500028	<b>Ref. No.</b>	2213.1912
<b>description</b>	pump inlet $\varnothing$ 28mm outlet $\varnothing$ 26mm type 2213.1912 230V 50Hz 1 phase 0,11kW 0,15HP L 195mm rotation direction left capacitor 6,3 $\mu$ F FIR		

<b>spare parts for</b> 500028			
	<b>Part No.</b>	365012	<b>Ref. No.</b> —
	operating capacitor capacity 6,3 $\mu$ F 450V		

	<b>Part No.</b>	510384	<b>Ref. No.</b> N/A
			
			
			





1

<b>Part No.</b>	500685	<b>Ref. No.</b>	2214.1403
<b>description</b>	pump inlet $\varnothing$ 28mm outlet $\varnothing$ 26mm type 2214.1403 230V 50Hz 1 phase 0,11kW 0,15HP L 197mm rotation direction right capacitor 6,3 $\mu$ F FIR		

<b>spare parts for</b> 500685			
	<b>Part No.</b>	365012	<b>Ref. No.</b> —
	operating capacitor capacity 6,3 $\mu$ F 450V		

	<b>Part No.</b>	510510	<b>Ref. No.</b> X2212-HP,0,10_ (1)
	pump cover pump type 2212/2228/2229/2211		

	<b>Part No.</b>	510695	<b>Ref. No.</b> N/A
	mechanical shaft seal height counter ring 5,5 mm		

<b>spare parts for</b> 500685			
	<b>Part No.</b>	521203	<b>Ref. No.</b> N/A
	impellor $\varnothing$ 72 mm H 18 mm thread M7 shaft $\varnothing$ 11 mm		
	<b>Part No.</b>	521703	<b>Ref. No.</b> N/A
	pump cover gasket EPDM thickness 2,5 mm ID $\varnothing$ 75 mm		





1

<b>Part No.</b>	500948	<b>Ref. No.</b>	2214.1600
<b>description</b>	pump inlet $\varnothing$ 28mm outlet $\varnothing$ 26mm type 2214.1600 230V 50Hz 1 phase 0,11kW 0,15HP L 197mm rotation direction right capacitor 6,3 $\mu$ F FIR		

<b>spare parts for</b> 500948			
	<b>Part No.</b>	365012	<b>Ref. No.</b> —
	operating capacitor capacity 6,3 $\mu$ F 450V		

	<b>Part No.</b>	510510	<b>Ref. No.</b> X2212-HP,0,10_ (1)
	pump cover pump type 2212/2228/2229/2211		

	<b>Part No.</b>	510695	<b>Ref. No.</b> N/A
	mechanical shaft seal height counter ring 5,5 mm		

	<b>Part No.</b>	521203	<b>Ref. No.</b> N/A
	impellor $\varnothing$ 72 mm H 18 mm thread M7 shaft $\varnothing$ 11 mm		

	<b>Part No.</b>	521703	<b>Ref. No.</b> N/A
	pump cover gasket EPDM thickness 2,5 mm ID $\varnothing$ 75 mm		







1

<b>Part No.</b>	499090	<b>Ref. No.</b>	2222.1900
<b>description</b>	pump inlet ø 28mm outlet ø 26mm type 2222.1900 230V 50Hz 1 phase 0,22kW 0,3HP L 191mm rotation direction left capacitor 5µF FIR		
<b>spare parts for</b>	499090		
	<b>Part No.</b>	365017	<b>Ref. No.</b> —
	operating capacitor capacity 5µF 450V		
	<b>Part No.</b>	510384	<b>Ref. No.</b> N/A
	pump cover inlet ø 28 mm outlet ø 26 mm ø 100 mm		
	<b>Part No.</b>	510532	<b>Ref. No.</b> X2228-HP0,20_(1)
	impellor ø 72 mm H 22 mm pump type B229 thread M7		
	<b>Part No.</b>	510695	<b>Ref. No.</b> N/A
	mechanical shaft seal height counter ring 5,5 mm		
	<b>Part No.</b>	521703	<b>Ref. No.</b> N/A
	pump cover gasket EPDM thickness 2,5 mm ID ø 75 mm		



1

<b>Part No.</b>	500015	<b>Ref. No.</b>	2228.1900
<b>description</b>	pump inlet ø 28mm outlet ø 26mm type 2228.1900 230V 50Hz 1 phase 0,15kW 0,2HP L 190mm rotation direction right capacitor 5µF FIR		
<b>spare parts for</b>	500015		
	<b>Part No.</b>	365017	<b>Ref. No.</b> —
	operating capacitor capacity 5µF 450V		
	<b>Part No.</b>	510510	<b>Ref. No.</b> X2212-HP0,10_(1)
	pump cover pump type 2212/2228/2229/2211		
	<b>Part No.</b>	510532	<b>Ref. No.</b> X2228-HP0,20_(1)
	impellor ø 72 mm H 22 mm pump type B229 thread M7		

<b>spare parts for</b>	500015		
	<b>Part No.</b>	510695	<b>Ref. No.</b> N/A
	mechanical shaft seal height counter ring 5,5 mm		
	<b>Part No.</b>	521703	<b>Ref. No.</b> N/A
	pump cover gasket EPDM thickness 2,5 mm ID ø 75 mm		







1

<b>Part No.</b>	500399	<b>Ref. No.</b>	4208.1910
<b>description</b>	pump inlet ø 28mm outlet ø 26mm type 4208.1910 230V 50Hz 1 phase 0,075kW 0,1HP L 190mm rotation direction left capacitor 5µF FIR		
<b>spare parts for</b>	500399		
	<b>Part No.</b>	365017	<b>Ref. No.</b> —
	operating capacitor capacity 5µF 450V		
	<b>Part No.</b>	510384	<b>Ref. No.</b> N/A
	pump cover inlet ø 28 mm outlet ø 26 mm ø 100 mm		
	<b>Part No.</b>	510695	<b>Ref. No.</b> N/A
	mechanical shaft seal height counter ring 5,5 mm		
	<b>Part No.</b>	521203	<b>Ref. No.</b> N/A
	impellor ø 72 mm H 18 mm thread M7 shaft ø 11 mm		
	<b>Part No.</b>	521703	<b>Ref. No.</b> N/A
	pump cover gasket EPDM thickness 2,5 mm ID ø 75 mm		







1

<b>Part No.</b>	500394	<b>Ref. No.</b>	4213.1500
<b>description</b>	pump inlet $\varnothing$ 28mm outlet $\varnothing$ 26mm type 4213.1500 230V 50Hz 1 phase 0,28kW 0,38HP L 195mm rotation direction left capacitor 6,3 $\mu$ F FIR		
<b>spare parts for</b>	500394		
	<b>Part No.</b>	365012	<b>Ref. No.</b> —
	operating capacitor capacity 6,3 $\mu$ F 450V		
	<b>Part No.</b>	510384	<b>Ref. No.</b> N/A
	pump cover inlet $\varnothing$ 28 mm outlet $\varnothing$ 26 mm $\varnothing$ 100 mm		
	<b>Part No.</b>	510532	<b>Ref. No.</b> X2228-HP,0,20_(1)
	impellor $\varnothing$ 72 mm H 22 mm pump type B229 thread M7		
	<b>Part No.</b>	510695	<b>Ref. No.</b> N/A
	mechanical shaft seal height counter ring 5,5 mm		
	<b>Part No.</b>	521703	<b>Ref. No.</b> N/A
	pump cover gasket EPDM thickness 2,5 mm ID $\varnothing$ 75 mm		



1

<b>Part No.</b>	501446	<b>Ref. No.</b>	4213E2250
<b>description</b>	pump inlet $\varnothing$ 28mm outlet $\varnothing$ 26mm type 4213E2250 220-240V 50Hz 1 phase 0,19kW 0,26HP L 190mm rotation direction left capacitor 5 $\mu$ F FIR		
<b>spare parts for</b>	501446		
	<b>Part No.</b>	365017	<b>Ref. No.</b> —
	operating capacitor capacity 5 $\mu$ F 450V		
	<b>Part No.</b>	510384	<b>Ref. No.</b> N/A
	pump cover inlet $\varnothing$ 28 mm outlet $\varnothing$ 26 mm $\varnothing$ 100 mm		
	<b>Part No.</b>	510695	<b>Ref. No.</b> N/A
	mechanical shaft seal height counter ring 5,5 mm		

**spare parts for** 501446





<b>Part No.</b>	521203	<b>Ref. No.</b>	N/A
-----------------	--------	-----------------	-----

impellor  $\varnothing$  72 mm H 18 mm thread M7 shaft  $\varnothing$  11 mm

<b>Part No.</b>	521703	<b>Ref. No.</b>	N/A
-----------------	--------	-----------------	-----





pump cover gasket EPDM thickness 2,5 mm ID  $\varnothing$  75 mm

1

<b>Part No.</b>	500030	<b>Ref. No.</b>	4226.2540
<b>description</b>	pump inlet $\varnothing$ 28mm outlet $\varnothing$ 26mm type 4226.2540 230/400V 50Hz 3 phase 0,35kW 0,5HP L 260mm rotation direction right FIR		
<b>spare parts for</b>	500030		
	<b>Part No.</b>	510510	<b>Ref. No.</b> X2212-HP,0,10_(1)
	pump cover pump type 2212/2228/2229/2211		
	<b>Part No.</b>	510690	<b>Ref. No.</b> N/A
	mechanical shaft seal for shaft $\varnothing$ 8 mm ED $\varnothing$ 24 mm		
	<b>Part No.</b>	521202	<b>Ref. No.</b> N/A
	impellor $\varnothing$ 72 mm H 17 mm thread M5L		
	<b>Part No.</b>	521703	<b>Ref. No.</b> N/A
	pump cover gasket EPDM thickness 2,5 mm ID $\varnothing$ 75 mm		







1

<b>Part No.</b>	500999	<b>Ref. No.</b>	4226.2541
<b>description</b>	pump inlet ø 28mm outlet ø 26mm type 4226.2541 230/400V 50Hz 3 phase 0,35kW 0,5HP L 260mm rotation direction right FIR		
<b>spare parts for</b>	500999		
	Part No.	510510	Ref. No. X2212-HP0,10_(1)
	pump cover pump type 2212/2228/2229/2211		
	Part No.	510690	Ref. No. N/A
	mechanical shaft seal for shaft ø 8 mm ED ø 24 mm		
	Part No.	521279	Ref. No. N/A
	impellor ø 64 mm H 17 mm thread M5L blades 3		
	Part No.	521703	Ref. No. N/A
	pump cover gasket EPDM thickness 2,5 mm ID ø 75 mm		



1

<b>Part No.</b>	500019	<b>Ref. No.</b>	B229.1405
<b>description</b>	pump inlet ø 28mm outlet ø 26mm type B229.1405 230V 50Hz 1 phase 0,22kW 0,3HP L 200mm rotation direction right capacitor 5µF FIR		
<b>spare parts for</b>	500019		
	Part No.	365017	Ref. No. —
	operating capacitor capacity 5µF 450V		
	Part No.	510510	Ref. No. X2212-HP0,10_(1)
	pump cover pump type 2212/2228/2229/2211		
	Part No.	510532	Ref. No. X2228-HP0,20_(1)
	impellor ø 72 mm H 22 mm pump type B229 thread M7		

<b>spare parts for</b>	500019		
	Part No.	510695	Ref. No. N/A
	mechanical shaft seal height counter ring 5,5 mm		
	Part No.	521703	Ref. No. N/A
	pump cover gasket EPDM thickness 2,5 mm ID ø 75 mm		



1

<b>Part No.</b>	499227	<b>Ref. No.</b>	B236.1400
<b>description</b>	pump inlet ø 28mm outlet ø 26mm type B236.1400 220-240V 50Hz 1 phase 0,14kW 0,2HP L 200mm rotation direction left capacitor 6,3µF FIR		
<b>spare parts for</b>	499227		
	Part No.	365012	Ref. No. —
	operating capacitor capacity 6,3µF 450V		
	Part No.	510384	Ref. No. N/A
	pump cover inlet ø 28 mm outlet ø 26 mm ø 100 mm		
	Part No.	510695	Ref. No. N/A
	mechanical shaft seal height counter ring 5,5 mm		
	Part No.	521203	Ref. No. N/A
	impellor ø 72 mm H 18 mm thread M7 shaft ø 11 mm		
	Part No.	521703	Ref. No. N/A
	pump cover gasket EPDM thickness 2,5 mm ID ø 75 mm		



1

<b>Part No.</b>	499279	<b>Ref. No.</b>	B246.2520
<b>description</b>	pump inlet $\varnothing$ 28mm outlet $\varnothing$ 26mm type B246.2520 230/400V 50Hz 3 phase 0,18kW 0,25HP L 265mm rotation direction right FIR		

<b>spare parts for</b>	499279		
<b>Part No.</b>	510510	<b>Ref. No.</b>	X2212-HP,0,10_(1)

<b>Part No.</b>	<b>Ref. No.</b>
-----------------	-----------------

<b>Part No.</b>	<b>Ref. No.</b>
-----------------	-----------------

<b>Part No.</b>	<b>Ref. No.</b>
-----------------	-----------------



1

<b>Part No.</b>	499262	<b>Ref. No.</b>	5213.2450
<b>description</b>	pump inlet $\varnothing$ 30mm outlet $\varnothing$ 26mm type 5213.2450 220-240V 50Hz 1 phase 0,28kW L 195mm rotation direction left capacitor 6,3 $\mu$ F FIR		



1

<b>Part No.</b>	499266	<b>Ref. No.</b>	5213.3951
<b>description</b>	pump inlet $\varnothing$ 30mm outlet $\varnothing$ 26mm type 5213.3951 400V 50Hz 1 phase 0,28kW L 195mm rotation direction left capacitor 6,3 $\mu$ F FIR		



1

<b>Part No.</b>	499261	<b>Ref. No.</b>	5213.2160
<b>description</b>	pump inlet $\varnothing$ 30mm outlet $\varnothing$ 26mm type 5213.2160 208-240V 60Hz 1 phase 0,28kW L 195mm rotation direction left capacitor 6,3 $\mu$ F FIR		





1

<b>Part No.</b>	500598	<b>Ref. No.</b>	5213EB2450 5213EB2451
<b>description</b>	pump inlet $\varnothing$ 30mm outlet $\varnothing$ 26mm type 5213E2450 230V 50Hz 1 phase 0,22kW 0,1HP L 190mm rotation direction left capacitor 5 $\mu$ F FIR		
<b>spare parts for</b> 500598			
	<b>Part No.</b>	365017	<b>Ref. No.</b> —
	operating capacitor capacity 5 $\mu$ F 450V		
	<b>Part No.</b>	502265	<b>Ref. No.</b> 5213EB2450
	pump cover inlet $\varnothing$ 30 mm outlet $\varnothing$ 26 mm ID $\varnothing$ 89 mm		
	<b>Part No.</b>	510695	<b>Ref. No.</b> N/A
	mechanical shaft seal height counter ring 5,5 mm		
	<b>Part No.</b>	521203	<b>Ref. No.</b> N/A
	impellor $\varnothing$ 72 mm H 18 mm thread M7 shaft $\varnothing$ 11 mm		



1

<b>Part No.</b>	499137	<b>Ref. No.</b>	5213E2452 5213EB2450
<b>description</b>	pump inlet $\varnothing$ 30mm outlet $\varnothing$ 26mm type 5213E2452 220/240V 50Hz 1 phase 0,07kW 0,1HP L 195mm rotation direction left capacitor 5 $\mu$ F FIR		
<b>spare parts for</b> 499137			
	<b>Part No.</b>	365017	<b>Ref. No.</b> —
	operating capacitor capacity 5 $\mu$ F 450V		
	<b>Part No.</b>	502250	<b>Ref. No.</b> —
	O-ring EPDM thickness 4mm ID $\varnothing$ 74mm Qty 1 pcs		
	<b>Part No.</b>	502265	<b>Ref. No.</b> 5213EB2450
	pump cover inlet $\varnothing$ 30 mm outlet $\varnothing$ 26 mm ID $\varnothing$ 89 mm		

<b>spare parts for</b> 499137			
	<b>Part No.</b>	510695	<b>Ref. No.</b> N/A
	mechanical shaft seal height counter ring 5,5 mm		
	<b>Part No.</b>	521203	<b>Ref. No.</b> N/A
	impellor $\varnothing$ 72 mm H 18 mm thread M7 shaft $\varnothing$ 11 mm		
	<b>Part No.</b>	532718	<b>Ref. No.</b> N/A
	O-ring EPDM thickness 4 mm ID $\varnothing$ 80 mm Qty 1 pcs		





1

<b>Part No.</b>	500686	<b>Ref. No.</b>	1252.1401
<b>description</b>	pump inlet $\varnothing$ 30mm outlet $\varnothing$ 30mm type 1252.1401 230V 50Hz 1 phase 0,19kW 0,25HP L 180mm rotation direction right capacitor 10 $\mu$ F FIR		
<b>spare parts for</b> 500686			
	<b>Part No.</b>	365015	<b>Ref. No.</b> —
	operating capacitor capacity 10 $\mu$ F 400V		
	<b>Part No.</b>	510605	<b>Ref. No.</b> N/A
	impellor $\varnothing$ 80 mm H 21 mm M7L		
	<b>Part No.</b>	510702	<b>Ref. No.</b> N/A
	mechanical shaft seal height counter ring 5,5 mm		
	<b>Part No.</b>	521571	<b>Ref. No.</b> 2240303
	pump cover FIR inlet $\varnothing$ 30 mm outlet $\varnothing$ 30 mm		
	<b>Part No.</b>	521701	<b>Ref. No.</b> N/A
	pump cover gasket		





1



<b>Part No.</b>	500267	<b>Ref. No.</b>	1267.1400
<b>description</b>	pump inlet ø 30mm outlet ø 30mm type 1267.1400 230V 50Hz 1 phase 0,18kW 0,25HP L 185mm rotation direction right capacitor 10µF FIR		
<b>spare parts for</b>	500267		
	<b>Part No.</b>	365015	<b>Ref. No.</b> —
	operating capacitor capacity 10µF 400V		
	<b>Part No.</b>	510605	<b>Ref. No.</b> N/A
	impellor ø 80 mm H 21 mm M7L		
	<b>Part No.</b>	510702	<b>Ref. No.</b> N/A
	mechanical shaft seal height counter ring 5,5 mm		
	<b>Part No.</b>	521501	<b>Ref. No.</b> N/A
	pump cover inlet ø 30 mm outlet ø 30 mm		
	<b>Part No.</b>	521701	<b>Ref. No.</b> N/A
	pump cover gasket		



1





<b>Part No.</b>	500261	<b>Ref. No.</b>	1267.1405
<b>description</b>	pump inlet ø 30mm outlet ø 30mm type 1267.1405 230V 50Hz 1 phase 0,18kW 0,25HP L 180mm rotation direction right capacitor 10µF FIR		
<b>spare parts for</b>	500261		
	<b>Part No.</b>	365015	<b>Ref. No.</b> —
	operating capacitor capacity 10µF 400V		
	<b>Part No.</b>	510605	<b>Ref. No.</b> N/A
	impellor ø 80 mm H 21 mm M7L		
	<b>Part No.</b>	510702	<b>Ref. No.</b> N/A
	mechanical shaft seal height counter ring 5,5 mm		

**spare parts for** 500261

	<b>Part No.</b>	521571	<b>Ref. No.</b>	2240303
	pump cover FIR inlet ø 30 mm outlet ø 30 mm			
	<b>Part No.</b>	521701	<b>Ref. No.</b>	N/A
	pump cover gasket			







1

<b>Part No.</b>	500262	<b>Ref. No.</b>	1268.1401	
<b>description</b>	pump inlet ø 30mm outlet ø 30mm type 1268.1401 230V 50Hz 1 phase 0,22kW 0,3HP L 185mm rotation direction right capacitor 10µF FIR			
<b>spare parts for</b>	500262			
	<b>Part No.</b>	365015	<b>Ref. No.</b> —	
	operating capacitor capacity 10µF 400V			
	<b>Part No.</b>	510609	<b>Ref. No.</b> N/A	
	impellor ø 84 mm H 21 mm M7L			
	<b>Part No.</b>	510702	<b>Ref. No.</b> N/A	
	mechanical shaft seal height counter ring 5,5 mm			
	<b>Part No.</b>	521571	<b>Ref. No.</b>	2240303
	pump cover FIR inlet ø 30 mm outlet ø 30 mm			
	<b>Part No.</b>	521701	<b>Ref. No.</b>	N/A
	pump cover gasket			







1

<b>Part No.</b>	500270	<b>Ref. No.</b>	1272/A
<b>description</b>	pump inlet ø 30mm outlet ø 30mm type 1272 230V 50Hz 1 phase 0,37kW 0,5HP L 195mm rotation direction right capacitor 12,5µF FIR		
<b>spare parts for</b>	500270		
	<b>Part No.</b>	365014	<b>Ref. No.</b> —
	operating capacitor capacity 12,5µF 400V		
	<b>Part No.</b>	510605	<b>Ref. No.</b> N/A
	impellor ø 80 mm H 21 mm M7L		
	<b>Part No.</b>	510702	<b>Ref. No.</b> N/A
	mechanical shaft seal height counter ring 5,5 mm		
	<b>Part No.</b>	521571	<b>Ref. No.</b> 2240303
	pump cover FIR inlet ø 30 mm outlet ø 30 mm		
	<b>Part No.</b>	521701	<b>Ref. No.</b> N/A
	pump cover gasket		



1

<b>Part No.</b>	500268	<b>Ref. No.</b>	1272/A
<b>description</b>	pump inlet ø 30mm outlet ø 30mm type 1272/A 230V 50Hz 1 phase 0,37kW 0,5HP L 195mm rotation direction right capacitor 12,5µF FIR		
<b>spare parts for</b>	500268		
	<b>Part No.</b>	365014	<b>Ref. No.</b> —
	operating capacitor capacity 12,5µF 400V		
	<b>Part No.</b>	510605	<b>Ref. No.</b> N/A
	impellor ø 80 mm H 21 mm M7L		
	<b>Part No.</b>	510702	<b>Ref. No.</b> N/A
	mechanical shaft seal height counter ring 5,5 mm		
	<b>Part No.</b>	521501	<b>Ref. No.</b> N/A
	pump cover inlet ø 30 mm outlet ø 30 mm		

<b>spare parts for</b>	500268		
	<b>Part No.</b>	521701	<b>Ref. No.</b> N/A
	pump cover gasket		



1

<b>Part No.</b>	500383	<b>Ref. No.</b>	1286.1406
<b>description</b>	pump inlet ø 30mm outlet ø 30mm type 1286.1406 230V 50Hz 1 phase 0,18kW 0,25HP rotation direction right FIR		



1











<b>Part No.</b>	499171	<b>Ref. No.</b>	2240.1411
<b>description</b>	pump inlet ø 30mm outlet ø 30mm type 2240.1411 230V 50Hz 1 phase 0,24kW 0,33HP L 183mm rotation direction right capacitor 10µF FIR		
<b>spare parts for</b>	499171		
	<b>Part No.</b>	365015	<b>Ref. No.</b> —
	operating capacitor capacity 10µF 400V		
	<b>Part No.</b>	510607	<b>Ref. No.</b> N/A
	impellor ø 85 mm H 29 mm shaft intake ø 9x8mm		
	<b>Part No.</b>	510695	<b>Ref. No.</b> N/A
	mechanical shaft seal height counter ring 5,5 mm		
	<b>Part No.</b>	521571	<b>Ref. No.</b> 2240303
	pump cover FIR inlet ø 30 mm outlet ø 30 mm		

Table continues overleaf









spare parts for 499171			
	Part No.	521701	Ref. No. N/A
	pump cover gasket		
	Part No.	521707	Ref. No. N/A
	pump cover gasket		



1			
<b>Part No.</b>	499105	<b>Ref. No.</b>	2286D1405
<b>description</b>	pump inlet $\varnothing$ 30mm outlet $\varnothing$ 30mm type 2286D1405 220/240V 50Hz 1 phase 0,18kW 0,25HP L 180mm rotation direction right capacitor 10 $\mu$ F FIR		
spare parts for 499105			
	Part No.	365015	Ref. No. —
	operating capacitor capacity 10 $\mu$ F 400V		
	Part No.	510605	Ref. No. N/A
	impellor $\varnothing$ 80 mm H 21 mm M7L		
	Part No.	510702	Ref. No. N/A
	mechanical shaft seal height counter ring 5,5 mm		
	Part No.	521571	Ref. No. 2240303
	pump cover FIR inlet $\varnothing$ 30 mm outlet $\varnothing$ 30 mm		
	Part No.	521701	Ref. No. N/A
	pump cover gasket		



1			
<b>Part No.</b>	500331	<b>Ref. No.</b>	B286.1650
<b>description</b>	pump inlet $\varnothing$ 30mm outlet $\varnothing$ 30mm type B286.1650 230V 50Hz 1 phase 0,37kW 0,5HP L 195mm rotation direction right capacitor 12,5 $\mu$ F FIR		
spare parts for 500331			
	Part No.	365014	Ref. No. —
	operating capacitor capacity 12,5 $\mu$ F 400V		
	Part No.	510607	Ref. No. N/A
	impellor $\varnothing$ 85 mm H 29 mm shaft intake $\varnothing$ 9x8mm		
	Part No.	510695	Ref. No. N/A
	mechanical shaft seal height counter ring 5,5 mm		
	Part No.	521571	Ref. No. 2240303
	pump cover FIR inlet $\varnothing$ 30 mm outlet $\varnothing$ 30 mm		
	Part No.	521701	Ref. No. N/A
	pump cover gasket		
	Part No.	521707	Ref. No. N/A
	pump cover gasket		



1			
<b>Part No.</b>	500327	<b>Ref. No.</b>	B287.1650
<b>description</b>	pump inlet $\varnothing$ 30mm outlet $\varnothing$ 30mm type B287.1650 230V 50Hz 1 phase 0,24kW 0,33HP L 180mm rotation direction right capacitor 10 $\mu$ F FIR		
spare parts for 500327			
	Part No.	365015	Ref. No. —
	operating capacitor capacity 10 $\mu$ F 400V		

Table continues overleaf





spare parts for 500327			
	Part No.	510607	Ref. No. N/A
impellor ø 85 mm H 29 mm shaft intake ø 9x8mm			
	Part No.	510695	Ref. No. N/A
mechanical shaft seal height counter ring 5,5 mm			
	Part No.	521571	Ref. No. 2240303
pump cover FIR inlet ø 30 mm outlet ø 30 mm			
	Part No.	521701	Ref. No. N/A
pump cover gasket			
	Part No.	521707	Ref. No. N/A
pump cover gasket			





1	<b>Part No.</b>	499327	<b>Ref. No.</b>	5215.4150
<b>description</b> pump inlet ø 30mm outlet ø 35mm type 5215.4150 200-254/346-440VV 50Hz 3 phase				
<b>spare parts for</b> 499327				
	Part No.	521079	Ref. No.	—
fanwheel cover ø 155mm H 70mm plastic				



1	<b>Part No.</b>	499321	<b>Ref. No.</b>	B242C2702
<b>description</b> pump inlet ø 30mm outlet ø 35mm type B242C2702 230V 50Hz 3 phase 0,55kW L 300mm rotation direction right FIR				



1	<b>Part No.</b>	500020	<b>Ref. No.</b>	4134.1402
<b>description</b> pump inlet ø 32mm outlet ø 32mm type 4134.1402 230V 50Hz 1 phase 0,18kW 0,25HP L 180mm rotation direction right capacitor 10µF FIR				
<b>spare parts for</b> 500020				
	Part No.	510506	Ref. No.	—
pump cover pump type 4333/1265				
<b>accessories for</b> 500020				
	Part No.	504329	Ref. No.	—
blind plug H 17,5mm thread M16x1.5 plastic WS 22				







1	<b>Part No.</b>	500558	<b>Ref. No.</b>	B226H1500
<b>description</b> pump inlet ø 33mm outlet ø 30/28mm type B266H1500 230V 50Hz 1 phase 0,22kW 0,3HP L 195mm rotation direction right capacitor 5µF FIR				
<b>spare parts for</b> 500558				
	Part No.	365017	Ref. No.	—
operating capacitor capacity 5µF 450V				
	Part No.	510693	Ref. No.	N/A
mechanical shaft seal for shaft ø 12 mm				
	Part No.	521545	Ref. No.	N/A
pump cover FIR type B226H inlet ø 33 mm				

Table continues overleaf









<b>spare parts for</b> 500558				
image not available	Part No.	521565	Ref. No.	N/A
	pump cover gasket pump type B226H			
	Part No.	521566	Ref. No.	N/A
	impellor ø 80 mm H 15 mm M7L pump type B226H			







1

<b>Part No.</b>	500561	<b>Ref. No.</b>	B221A	
<b>description</b>	pump inlet ø 33mm outlet ø 30mm type B221A 230V 50Hz 1 phase 0,15kW 0,2HP L 195mm rotation direction left capacitor 6,3µF FIR			
<b>spare parts for</b> 500561				
	Part No.	365012	Ref. No.	—
operating capacitor capacity 6,3µF 450V				
	Part No.	501309	Ref. No.	N/A
impellor ø 80 mm H 19 mm M7R pump type type D1				
	Part No.	501310	Ref. No.	—
pump cover				
	Part No.	510693	Ref. No.	N/A
mechanical shaft seal for shaft ø 12 mm				



1

<b>Part No.</b>	500274	<b>Ref. No.</b>	B221A1500	
<b>description</b>	pump inlet ø 33mm outlet ø 30mm type B221A1500 230V 50Hz 1 phase 0,15kW 0,2HP L 195mm rotation direction left capacitor 6,3µF FIR			
<b>spare parts for</b> 500274				
	Part No.	365012	Ref. No.	—
operating capacitor capacity 6,3µF 450V				
	Part No.	501309	Ref. No.	N/A
impellor ø 80 mm H 19 mm M7R pump type type D1				
	Part No.	510693	Ref. No.	N/A
mechanical shaft seal for shaft ø 12 mm				
image not available	Part No.	521500	Ref. No.	N/A
pump cover				
	Part No.	521700	Ref. No.	N/A
pump cover gasket				
	Part No.	551223	Ref. No.	—
housing 4-pole size 6,3mm straight nylon				



1









<b>Part No.</b>	500388	<b>Ref. No.</b>	B265.1500	
<b>description</b>	pump inlet ø 33mm outlet ø 30mm type B265.1500 230V 50Hz 1 phase 0,22kW 0,3HP L 265mm rotation direction left capacitor 6,3µF FIR			
<b>spare parts for</b> 500388				
	Part No.	365012	Ref. No.	—
operating capacitor capacity 6,3µF 450V				

Table continues overleaf

<b>spare parts for</b> 500388			
	Part No.	501309	Ref. No. N/A
impellor ø 80 mm H 19 mm M7R pump type type D1			
	Part No.	510702	Ref. No. N/A
mechanical shaft seal height counter ring 5,5 mm			
image not available	Part No.	521500	Ref. No. N/A
pump cover			
	Part No.	521700	Ref. No. N/A
pump cover gasket			



1

<b>Part No.</b>	500127	<b>Ref. No.</b>	4247.1900
<b>description</b>	pump inlet ø 37mm outlet ø 41mm type 4247.1900 230V 50Hz 1 phase 0,44kW 0,6HP L 200mm rotation direction right capacitor 10µF FIR		
<b>spare parts for</b> 500127			
	Part No.	365015	Ref. No. —
operating capacitor capacity 10µF 400V			
	Part No.	510608	Ref. No. N/A
impellor ø 93 mm H 32 mm shaft intake ø 9/8mm			
	Part No.	510692	Ref. No. N/A
mechanical shaft seal for shaft ø 11 mm			
	Part No.	521505	Ref. No. X4247-HP0,6_(1)
pump cover FIR inlet ø 37 mm outlet ø 40 mm			
	Part No.	521702	Ref. No. N/A
pump cover gasket thickness 3.5x4.5mm Qty 1 pcs			



1

<b>Part No.</b>	499170	<b>Ref. No.</b>	4243.1400
<b>description</b>	pump inlet ø 45mm outlet ø 1" IT type 4243.1400 230V 1 phase 0,55kW 0,75HP L 310mm rotation direction right capacitor 12,5µF FIR		



1

<b>Part No.</b>	500463	<b>Ref. No.</b>	2253
<b>description</b>	pump inlet ø 45mm outlet ø 30mm type 2253 230V 50Hz 1 phase 0,24kW 0,33HP L 160mm rotation direction right FIR		
<b>spare parts for</b> 500463			
image not available	Part No.	521148	Ref. No. —
pump cover pump type Fir 2253(500.463)			







1

<b>Part No.</b>	500125	<b>Ref. No.</b>	2253
<b>description</b>	pump inlet $\varnothing$ 45mm outlet $\varnothing$ 30mm type 2253 230V 50Hz 1 phase 0,24kW 0,33HP L 175mm rotation direction right capacitor 10 $\mu$ F FIR inlet $\varnothing$ 45mm outlet $\varnothing$ 30mm		



1

<b>Part No.</b>	499165	<b>Ref. No.</b>	1297.1900
<b>description</b>	pump inlet $\varnothing$ 45mm outlet $\varnothing$ 32mm type 1297.1900 230V 50Hz 1 phase 0,29kW 0,4HP L 165mm rotation direction right capacitor 8 $\mu$ F FIR		
<b>spare parts for</b>	499165		
	<b>Part No.</b>	365013	<b>Ref. No.</b> —
	operating capacitor capacity 8 $\mu$ F 400V		
	<b>Part No.</b>	510512	<b>Ref. No.</b> —
	pump cover OLYMPIA inlet $\varnothing$ 45 mm outlet $\varnothing$ 31 mm		
	<b>Part No.</b>	510554	<b>Ref. No.</b> —
	O-ring EPDM thickness 2 mm ID $\varnothing$ 120 mm Qty 1 pcs		
	<b>Part No.</b>	510615	<b>Ref. No.</b> —
	impellor $\varnothing$ 90 mm H 22 mm rotation direction right		
	<b>Part No.</b>	510693	<b>Ref. No.</b> N/A
	mechanical shaft seal for shaft $\varnothing$ 12 mm		



1

<b>Part No.</b>	501464	<b>Ref. No.</b>	3910.1423
<b>description</b>	pump inlet $\varnothing$ 45mm outlet $\varnothing$ 39mm type 3910.1423 230V 50Hz 1 phase 0,4kW L 220mm rotation direction right capacitor 10 $\mu$ F FIR		
<b>spare parts for</b>	501464		
	<b>Part No.</b>	365015	<b>Ref. No.</b> —
	operating capacitor capacity 10 $\mu$ F 400V		
	<b>Part No.</b>	510508	<b>Ref. No.</b> N/A
	pump cover FIR inlet $\varnothing$ 45 mm outlet $\varnothing$ 40 mm		
	<b>Part No.</b>	510607	<b>Ref. No.</b> N/A
	impellor $\varnothing$ 85 mm H 29 mm shaft intake $\varnothing$ 9x8mm		
	<b>Part No.</b>	510692	<b>Ref. No.</b> N/A
	mechanical shaft seal for shaft $\varnothing$ 11 mm		
	<b>Part No.</b>	521702	<b>Ref. No.</b> N/A
	pump cover gasket thickness 3.5x4.5mm Qty 1 pcs		







1

<b>Part No.</b>	500710	<b>Ref. No.</b>	1217/A
<b>description</b>	pump inlet $\varnothing$ 45mm outlet $\varnothing$ 40mm type 1217/A 230V 50Hz 1 phase 0,56kW 0,75HP L 295mm rotation direction right capacitor 12,5 $\mu$ F FIR		







1

<b>Part No.</b>	500017	<b>Ref. No.</b>	1219.1405
<b>description</b>	pump inlet $\varnothing$ 45mm outlet $\varnothing$ 40mm type 1219.1405 230V 50Hz 1 phase 0,73kW 1HP L 300mm rotation direction right capacitor 12,5 $\mu$ F FIR		
<b>spare parts for</b>	500017		
	<b>Part No.</b>	365014	<b>Ref. No.</b> —
	operating capacitor capacity 12,5 $\mu$ F 400V		
	<b>Part No.</b>	510600	<b>Ref. No.</b> N/A
	impellor $\varnothing$ 102 mm H 29 mm shaft intake $\varnothing$ 9/8mm		
	<b>Part No.</b>	510692	<b>Ref. No.</b> N/A
	mechanical shaft seal for shaft $\varnothing$ 11 mm		
	<b>Part No.</b>	521539	<b>Ref. No.</b> N/A
	pump cover FIR inlet $\varnothing$ 45 mm outlet $\varnothing$ 40 mm		
	<b>Part No.</b>	521702	<b>Ref. No.</b> N/A
	pump cover gasket thickness 3.5x4.5mm Qty 1 pcs		







1

<b>Part No.</b>	499140	<b>Ref. No.</b>	1219.2504
<b>description</b>	pump inlet $\varnothing$ 45mm outlet $\varnothing$ 40mm type 1219.2504 220/380-240/415V 50Hz 3 phase 1,1kW 1,5HP L 290mm rotation direction right FIR		
<b>spare parts for</b>	499140		
	<b>Part No.</b>	502007	<b>Ref. No.</b> N/A
	pump cover gasket		

<b>spare parts for</b>	499140		
	<b>Part No.</b>	510529	<b>Ref. No.</b> N/A
	impellor $\varnothing$ 103 mm H 30 mm shaft intake $\varnothing$ 9/8mm		
	<b>Part No.</b>	510692	<b>Ref. No.</b> N/A
	mechanical shaft seal for shaft $\varnothing$ 11 mm		
	<b>Part No.</b>	511187	<b>Ref. No.</b> N/A
	pump cover FIR inlet $\varnothing$ 45 mm outlet $\varnothing$ 40 mm		



1





<b>Part No.</b>	500004	<b>Ref. No.</b>	1219.2521
<b>description</b>	pump inlet $\varnothing$ 45mm outlet $\varnothing$ 40mm type 1219.2521 230/400V 50Hz 3 phase 1,1kW 1,5HP L 300mm rotation direction right capacitor $\mu$ F FIR		
<b>spare parts for</b>	500004		
	<b>Part No.</b>	502007	<b>Ref. No.</b> N/A
	pump cover gasket		
	<b>Part No.</b>	510529	<b>Ref. No.</b> N/A
	impellor $\varnothing$ 103 mm H 30 mm shaft intake $\varnothing$ 9/8mm		
	<b>Part No.</b>	510692	<b>Ref. No.</b> N/A
	mechanical shaft seal for shaft $\varnothing$ 11 mm		
	<b>Part No.</b>	511187	<b>Ref. No.</b> N/A
	pump cover FIR inlet $\varnothing$ 45 mm outlet $\varnothing$ 40 mm		





1



<b>Part No.</b>	500033	<b>Ref. No.</b>	1221.1400
<b>description</b>	pump inlet ø 45mm outlet ø 40mm type 1221.1400 230V 50Hz 1 phase 0,37kW 0,5HP L 210mm rotation direction right capacitor 12,5µF FIR		

<b>spare parts for</b> 500033				
	Part No.	365014	Ref. No.	—
	operating capacitor capacity 12,5µF 400V			
	Part No.	502007	Ref. No.	N/A
	pump cover gasket			
	Part No.	510607	Ref. No.	N/A
	impellor ø 85 mm H 29 mm shaft intake ø 9x8mm			
	Part No.	510692	Ref. No.	N/A
	mechanical shaft seal for shaft ø 11 mm			
	Part No.	511187	Ref. No.	N/A
	pump cover FIR inlet ø 45 mm outlet ø 40 mm			





1

<b>Part No.</b>	500009	<b>Ref. No.</b>	1222.1406
<b>description</b>	pump inlet ø 45mm outlet ø 40mm type 1222.1406 230V 50Hz 1 phase 0,37kW 0,5HP L 275mm rotation direction right capacitor 12,5µF FIR		

<b>spare parts for</b> 500009				
	Part No.	365014	Ref. No.	—
	operating capacitor capacity 12,5µF 400V			
	Part No.	502007	Ref. No.	N/A
	pump cover gasket			





**spare parts for** 500009

	Part No.	510607	Ref. No.	N/A
	impellor ø 85 mm H 29 mm shaft intake ø 9x8mm			
	Part No.	510692	Ref. No.	N/A
	mechanical shaft seal for shaft ø 11 mm			
	Part No.	511187	Ref. No.	N/A
	pump cover FIR inlet ø 45 mm outlet ø 40 mm			



1

<b>Part No.</b>	499071	<b>Ref. No.</b>	1222.2800
<b>description</b>	pump inlet ø 45mm outlet ø 40mm type 1222.2800 440V 60Hz 0,37kW 0,5HP L 275mm rotation direction right FIR		

<b>spare parts for</b> 499071				
	Part No.	502007	Ref. No.	N/A
	pump cover gasket			
	Part No.	510528	Ref. No.	—
	flange suitable for pump			
	Part No.	510692	Ref. No.	N/A
	mechanical shaft seal for shaft ø 11 mm			
	Part No.	511187	Ref. No.	N/A
	pump cover FIR inlet ø 45 mm outlet ø 40 mm			









1

<b>Part No.</b>	500086	<b>Ref. No.</b>	1223.1400
<b>description</b>	pump inlet ø 45mm outlet ø 40mm type 1223.1400 230V 50Hz 1 phase 0,55kW 0,75HP L 275mm rotation direction right capacitor 12,5µF FIR		
<b>spare parts for</b>	500086		
	<b>Part No.</b>	365014	<b>Ref. No.</b> —
	operating capacitor capacity 12,5µF 400V		
	<b>Part No.</b>	502007	<b>Ref. No.</b> N/A
	pump cover gasket		
	<b>Part No.</b>	510608	<b>Ref. No.</b> N/A
	impeller ø 93 mm H 32 mm shaft intake ø 9/8mm		
	<b>Part No.</b>	510692	<b>Ref. No.</b> N/A
	mechanical shaft seal for shaft ø 11 mm		
	<b>Part No.</b>	511187	<b>Ref. No.</b> N/A
	pump cover FIR inlet ø 45 mm outlet ø 40 mm		
	<b>Part No.</b>	521022	<b>Ref. No.</b> —
	fanwheel cover ID ø 137mm ED ø 142mm H 70mm		



1

<b>Part No.</b>	500254	<b>Ref. No.</b>	1266.1400
<b>description</b>	pump inlet ø 45mm outlet ø 40mm type 1266.1400 230V 50Hz 1 phase 0,37kW 0,5HP L 205mm rotation direction right capacitor 12,5µF FIR		
<b>spare parts for</b>	500254		
	<b>Part No.</b>	365014	<b>Ref. No.</b> —
	operating capacitor capacity 12,5µF 400V		
	<b>Part No.</b>	510508	<b>Ref. No.</b> N/A
	pump cover FIR inlet ø 45 mm outlet ø 40 mm		
	<b>Part No.</b>	510692	<b>Ref. No.</b> N/A
	mechanical shaft seal for shaft ø 11 mm		
	<b>Part No.</b>	521210	<b>Ref. No.</b> N/A
	impeller ø 96 mm H 30 mm shaft intake ø 9/8mm		
	<b>Part No.</b>	521702	<b>Ref. No.</b> N/A
	pump cover gasket thickness 3.5x4.5mm Qty 1 pcs		



1





<b>Part No.</b>	500256	<b>Ref. No.</b>	1270/A
<b>description</b>	pump inlet ø 45mm outlet ø 40mm type 1270 230V 50Hz 1 phase 0,55kW 0,75HP L 205mm rotation direction right capacitor 12,5µF FIR		
<b>spare parts for</b>	500256		
	<b>Part No.</b>	365014	<b>Ref. No.</b> —
	operating capacitor capacity 12,5µF 400V		
	<b>Part No.</b>	510508	<b>Ref. No.</b> N/A
	pump cover FIR inlet ø 45 mm outlet ø 40 mm		





Table continues overleaf



spare parts for 500256			
	Part No.	510692	Ref. No. N/A
mechanical shaft seal for shaft $\varnothing$ 11 mm			
	Part No.	521210	Ref. No. N/A
impellor $\varnothing$ 96 mm H 30 mm shaft intake $\varnothing$ 9/8mm			
	Part No.	521702	Ref. No. N/A
pump cover gasket thickness 3.5x4.5mm Qty 1 pcs			







1

Part No.	500252	Ref. No.	1270.1402
<b>description</b>	pump inlet $\varnothing$ 45mm outlet $\varnothing$ 40mm type 1270/A 230V 50Hz 1 phase 0,55kW 0,75HP L 205mm rotation direction right capacitor 12,5 $\mu$ F FIR		
<b>spare parts for 500252</b>			
	Part No.	365014	Ref. No. —
operating capacitor capacity 12,5 $\mu$ F 400V			
	Part No.	510508	Ref. No. N/A
pump cover FIR inlet $\varnothing$ 45 mm outlet $\varnothing$ 40 mm			
	Part No.	510692	Ref. No. N/A
mechanical shaft seal for shaft $\varnothing$ 11 mm			
	Part No.	521210	Ref. No. N/A
impellor $\varnothing$ 96 mm H 30 mm shaft intake $\varnothing$ 9/8mm			
	Part No.	521702	Ref. No. N/A
pump cover gasket thickness 3.5x4.5mm Qty 1 pcs			



1

Part No.	500289	Ref. No.	1276.2530
<b>description</b>	pump inlet $\varnothing$ 45mm outlet $\varnothing$ 40mm type 1276.2530 230/400V 50Hz 3 phase 0,55kW 0,75HP L 270mm rotation direction right FIR		
<b>spare parts for 500289</b>			
	Part No.	501314	Ref. No. N/A
impellor $\varnothing$ 75 mm			
	Part No.	502007	Ref. No. N/A
pump cover gasket			
	Part No.	502014	Ref. No. N/A
pump cover FIR inlet $\varnothing$ 45 mm outlet $\varnothing$ 40 mm			
	Part No.	510692	Ref. No. N/A
mechanical shaft seal for shaft $\varnothing$ 11 mm			



1





Part No.	500707	Ref. No.	1278.1401
<b>description</b>	pump inlet $\varnothing$ 45mm outlet $\varnothing$ 40mm type 1278.1401 230V 50Hz 1 phase 0,75kW 1HP L 210mm rotation direction right capacitor 12,5 $\mu$ F FIR		
<b>spare parts for 500707</b>			
	Part No.	365014	Ref. No. —
operating capacitor capacity 12,5 $\mu$ F 400V			
	Part No.	510508	Ref. No. N/A
pump cover FIR inlet $\varnothing$ 45 mm outlet $\varnothing$ 40 mm			

Table continues overleaf







<b>spare parts for</b> 500707			
	Part No.	510610	Ref. No. N/A
impellor ø 95,5 mm H 23 mm shaft intake ø 9/8mm			
	Part No.	510692	Ref. No. N/A
mechanical shaft seal for shaft ø 11 mm			
	Part No.	521702	Ref. No. N/A
pump cover gasket thickness 3.5x4.5mm Qty 1 pcs			



<b>Part No.</b>	500027	<b>Ref. No.</b>	1292.1400
<b>description</b>	pump inlet ø 45mm outlet ø 40mm type 1292.1400 230V 50Hz 1 phase 0,56kW 0,75HP L 200mm rotation direction right capacitor 12,5µF FIR		
<b>spare parts for</b> 500027			
	Part No.	365014	Ref. No. —
operating capacitor capacity 12,5µF 400V			
	Part No.	510600	Ref. No. N/A
impellor ø 102 mm H 29 mm shaft intake ø 9/8mm			
	Part No.	510692	Ref. No. N/A
mechanical shaft seal for shaft ø 11 mm			
	Part No.	521506	Ref. No. N/A
pump cover FIR inlet ø 45 mm outlet ø 40 mm			
	Part No.	521702	Ref. No. N/A
pump cover gasket thickness 3.5x4.5mm Qty 1 pcs			



<b>Part No.</b>	500684	<b>Ref. No.</b>	1299.1402
<b>description</b>	pump inlet ø 45mm outlet ø 40mm type 1299.1402 230V 50Hz 1 phase 0,37kW 0,5HP L 208mm rotation direction right capacitor 12,5µF FIR		
<b>spare parts for</b> 500684			
	Part No.	365014	Ref. No. —
operating capacitor capacity 12,5µF 400V			
	Part No.	510508	Ref. No. N/A
pump cover FIR inlet ø 45 mm outlet ø 40 mm			
	Part No.	510607	Ref. No. N/A
impellor ø 85 mm H 29 mm shaft intake ø 9x8mm			
	Part No.	510692	Ref. No. N/A
mechanical shaft seal for shaft ø 11 mm			
	Part No.	521702	Ref. No. N/A
pump cover gasket thickness 3.5x4.5mm Qty 1 pcs			







<b>Part No.</b>	500549	<b>Ref. No.</b>	2220
<b>description</b>	pump inlet ø 45mm outlet ø 40mm type 2220 230V 50Hz 1 phase 0,73kW 1HP L 235mm rotation direction right capacitor 16µF FIR		
<b>spare parts for</b> 500549			
	Part No.	365021	Ref. No. —
operating capacitor capacity 16µF 425V			





Table continues overleaf



spare parts for 500549			
	Part No.	502007	Ref. No. N/A
	pump cover gasket		
	Part No.	502014	Ref. No. N/A
	pump cover FIR inlet $\varnothing$ 45 mm outlet $\varnothing$ 40 mm		
	Part No.	510529	Ref. No. N/A
	impellor $\varnothing$ 103 mm H 30 mm shaft intake $\varnothing$ 9/8mm		
	Part No.	510692	Ref. No. N/A
	mechanical shaft seal for shaft $\varnothing$ 11 mm		







1

Part No.	500118	Ref. No.	2236.1400
<b>description</b>	pump inlet $\varnothing$ 45mm outlet $\varnothing$ 40mm type 2236.1400 230V 50Hz 1 phase 0,74kW 1HP L 235mm rotation direction right capacitor 16 $\mu$ F FIR		
<b>spare parts for 500118</b>			
	Part No.	365021	Ref. No. —
	operating capacitor capacity 16 $\mu$ F 425V		
	Part No.	510508	Ref. No. N/A
	pump cover FIR inlet $\varnothing$ 45 mm outlet $\varnothing$ 40 mm		
	Part No.	510600	Ref. No. N/A
	impellor $\varnothing$ 102 mm H 29 mm shaft intake $\varnothing$ 9/8mm		
	Part No.	510692	Ref. No. N/A
	mechanical shaft seal for shaft $\varnothing$ 11 mm		
	Part No.	521702	Ref. No. N/A
	pump cover gasket thickness 3.5x4.5mm Qty 1 pcs		



1

Part No.	500702	Ref. No.	2246.1400
<b>description</b>	pump inlet $\varnothing$ 45mm outlet $\varnothing$ 40mm type 2246.1400 230V 50Hz 1 phase 0,24kW 0,33HP L 195mm rotation direction right capacitor 10 $\mu$ F FIR		
<b>spare parts for 500702</b>			
	Part No.	365015	Ref. No. —
	operating capacitor capacity 10 $\mu$ F 400V		
	Part No.	510607	Ref. No. N/A
	impellor $\varnothing$ 85 mm H 29 mm shaft intake $\varnothing$ 9x8mm		
	Part No.	510692	Ref. No. N/A
	mechanical shaft seal for shaft $\varnothing$ 11 mm		
	Part No.	521539	Ref. No. N/A
	pump cover FIR inlet $\varnothing$ 45 mm outlet $\varnothing$ 40 mm		
	Part No.	521702	Ref. No. N/A
	pump cover gasket thickness 3.5x4.5mm Qty 1 pcs		



1





Part No.	500287	Ref. No.	2256.1420
<b>description</b>	pump inlet $\varnothing$ 45mm outlet $\varnothing$ 40mm type 2256.1420 230V 50Hz 1 phase 0,73kW 1HP L 200mm rotation direction right capacitor 16 $\mu$ F FIR		
<b>spare parts for 500287</b>			
	Part No.	365021	Ref. No. —
	operating capacitor capacity 16 $\mu$ F 425V		





Table continues overleaf



spare parts for 500287			
	Part No.	501313	Ref. No. N/A
impellor ø 103 mm H 28 mm shaft intake ø 9/8mm			
	Part No.	502007	Ref. No. N/A
pump cover gasket			
	Part No.	502014	Ref. No. N/A
pump cover FIR inlet ø 45 mm outlet ø 40 mm			
	Part No.	510692	Ref. No. N/A
mechanical shaft seal for shaft ø 11 mm			



<b>Part No.</b>	499216	<b>Ref. No.</b>	2256T2550
<b>description</b>	pump inlet ø 45mm outlet ø 40mm type 2256T2550 180-253V 50Hz 1 phase 0,75kW 1HP L 250mm rotation direction right capacitor 20µF FIR		

spare parts for 499216			
	Part No.	365019	Ref. No. —
operating capacitor capacity 20µF 400V			
	Part No.	501313	Ref. No. N/A
impellor ø 103 mm H 28 mm shaft intake ø 9/8mm			
	Part No.	502007	Ref. No. N/A
pump cover gasket			
	Part No.	502014	Ref. No. N/A
pump cover FIR inlet ø 45 mm outlet ø 40 mm			
	Part No.	510692	Ref. No. N/A
mechanical shaft seal for shaft ø 11 mm			



<b>Part No.</b>	499069	<b>Ref. No.</b>	2256V1425
<b>description</b>	pump inlet ø 45mm outlet ø 40mm type 2256V1425 230V 50Hz 1 phase 0,74kW 1HP L 235mm rotation direction right capacitor 16µF FIR		

spare parts for 499069			
	Part No.	365021	Ref. No. —
operating capacitor capacity 16µF 425V			
	Part No.	499188	Ref. No. 2256V1425
pump inlet ø 45mm outlet ø 40mm type 2256V1425			
	Part No.	510529	Ref. No. N/A
impellor ø 103 mm H 30 mm shaft intake ø 9/8mm			
	Part No.	510692	Ref. No. N/A
mechanical shaft seal for shaft ø 11 mm			
	Part No.	521539	Ref. No. N/A
pump cover FIR inlet ø 45 mm outlet ø 40 mm			
	Part No.	521702	Ref. No. N/A
pump cover gasket thickness 3.5x4.5mm Qty 1 pcs			



<b>Part No.</b>	499188	<b>Ref. No.</b>	2256V1425
<b>description</b>	pump inlet ø 45mm outlet ø 40mm type 2256V1425 230V 50Hz 1 phase 0,75kW 1HP L 235mm rotation direction right capacitor 16µF FIR		













spare parts for 499188			
	Part No.	365021	Ref. No. —
operating capacitor capacity 16µF 425V			





Table continues overleaf





spare parts for 499188			
	Part No.	499188	Ref. No. 2256V1425
pump inlet $\varnothing$ 45mm outlet $\varnothing$ 40mm type 2256V1425			
	Part No.	510529	Ref. No. N/A
impellor $\varnothing$ 103 mm H 30 mm shaft intake $\varnothing$ 9/8mm			
	Part No.	510692	Ref. No. N/A
mechanical shaft seal for shaft $\varnothing$ 11 mm			
	Part No.	521539	Ref. No. N/A
pump cover FIR inlet $\varnothing$ 45 mm outlet $\varnothing$ 40 mm			
	Part No.	521702	Ref. No. N/A
pump cover gasket thickness 3.5x4.5mm Qty 1 pcs			

			
1			
<b>Part No.</b>	500269	<b>Ref. No.</b>	2265.1920
<b>description</b>	pump inlet $\varnothing$ 45mm outlet $\varnothing$ 40mm type 2265.1920 230V 50Hz 1 phase 0,55kW 0,75HP L 245mm rotation direction right capacitor 16 $\mu$ F FIR		
<b>spare parts for</b>	500269		
	Part No.	365021	Ref. No. —
operating capacitor capacity 16 $\mu$ F 425V			
	Part No.	510508	Ref. No. N/A
pump cover FIR inlet $\varnothing$ 45 mm outlet $\varnothing$ 40 mm			
	Part No.	510600	Ref. No. N/A
impellor $\varnothing$ 102 mm H 29 mm shaft intake $\varnothing$ 9/8mm			
	Part No.	510692	Ref. No. N/A
mechanical shaft seal for shaft $\varnothing$ 11 mm			
	Part No.	521023	Ref. No. —
fanwheel cover ED $\varnothing$ 150mm H 70mm for wash pump			
	Part No.	521702	Ref. No. N/A
pump cover gasket thickness 3.5x4.5mm Qty 1 pcs			

			
1			
<b>Part No.</b>	500263	<b>Ref. No.</b>	2265.1921
<b>description</b>	pump inlet $\varnothing$ 45mm outlet $\varnothing$ 40mm type 2265.1921 230V 50Hz 1 phase 0,55kW 0,75HP L 250mm rotation direction right capacitor 16 $\mu$ F FIR		
<b>spare parts for</b>	500263		
	Part No.	365021	Ref. No. —
operating capacitor capacity 16 $\mu$ F 425V			
	Part No.	510508	Ref. No. N/A
pump cover FIR inlet $\varnothing$ 45 mm outlet $\varnothing$ 40 mm			
	Part No.	510600	Ref. No. N/A
impellor $\varnothing$ 102 mm H 29 mm shaft intake $\varnothing$ 9/8mm			
	Part No.	510692	Ref. No. N/A
mechanical shaft seal for shaft $\varnothing$ 11 mm			
	Part No.	521023	Ref. No. —
fanwheel cover ED $\varnothing$ 150mm H 70mm for wash pump			
	Part No.	521702	Ref. No. N/A
pump cover gasket thickness 3.5x4.5mm Qty 1 pcs			



1

<b>Part No.</b>	499134	<b>Ref. No.</b>	2282
<b>description</b>	pump inlet $\varnothing$ 45mm outlet $\varnothing$ 40mm type 2282 230V 50Hz 0,37kW 0,5HP L 205mm rotation direction right capacitor 12,5 $\mu$ F auxiliary pressure connection 11mm supporting pressure open FIR		
<b>spare parts for</b>	499134		
	<b>Part No.</b>	<b>Ref. No.</b>	—
	365014		
	operating capacitor capacity 12,5 $\mu$ F 400V		
	<b>Part No.</b>	<b>Ref. No.</b>	N/A
	510607		
	impellor $\varnothing$ 85 mm H 29 mm shaft intake $\varnothing$ 9x8mm		
	<b>Part No.</b>	<b>Ref. No.</b>	N/A
	510692		
	mechanical shaft seal for shaft $\varnothing$ 11 mm		
	<b>Part No.</b>	<b>Ref. No.</b>	N/A
	521539		
	pump cover FIR inlet $\varnothing$ 45 mm outlet $\varnothing$ 40 mm		
	<b>Part No.</b>	<b>Ref. No.</b>	N/A
	521702		
	pump cover gasket thickness 3.5x4.5mm Qty 1 pcs		



1

<b>Part No.</b>	500010	<b>Ref. No.</b>	2292.1400 2292.1506
<b>description</b>	pump inlet $\varnothing$ 45mm outlet $\varnothing$ 40mm type 2292.1506 230V 50Hz 1 phase 0,55kW 0,75HP L 238mm rotation direction right capacitor 12,5 $\mu$ F FIR		
<b>spare parts for</b>	500010		
	<b>Part No.</b>	<b>Ref. No.</b>	—
	365014		
	operating capacitor capacity 12,5 $\mu$ F 400V		

<b>spare parts for</b>	500010		
	<b>Part No.</b>	<b>Ref. No.</b>	N/A
	510600		
	impellor $\varnothing$ 102 mm H 29 mm shaft intake $\varnothing$ 9/8mm		
	<b>Part No.</b>	<b>Ref. No.</b>	N/A
	510692		
	mechanical shaft seal for shaft $\varnothing$ 11 mm		
	<b>Part No.</b>	<b>Ref. No.</b>	—
	521023		
	fanwheel cover ED $\varnothing$ 150mm H 70mm for wash pump		
	<b>Part No.</b>	<b>Ref. No.</b>	N/A
	521506		
	pump cover FIR inlet $\varnothing$ 45 mm outlet $\varnothing$ 40 mm		
	<b>Part No.</b>	<b>Ref. No.</b>	N/A
	521702		
	pump cover gasket thickness 3.5x4.5mm Qty 1 pcs		



1

<b>Part No.</b>	499151	<b>Ref. No.</b>	3910.1421
<b>description</b>	pump inlet $\varnothing$ 45mm outlet $\varnothing$ 40mm type 3910.1421 230V 50Hz 1 phase 0,37kW 0,5HP L 190mm rotation direction right capacitor 10 $\mu$ F FIR		
<b>spare parts for</b>	499151		
	<b>Part No.</b>	<b>Ref. No.</b>	—
	365015		
	operating capacitor capacity 10 $\mu$ F 400V		
	<b>Part No.</b>	<b>Ref. No.</b>	N/A
	510508		
	pump cover FIR inlet $\varnothing$ 45 mm outlet $\varnothing$ 40 mm		
	<b>Part No.</b>	<b>Ref. No.</b>	N/A
	510607		
	impellor $\varnothing$ 85 mm H 29 mm shaft intake $\varnothing$ 9x8mm		
	<b>Part No.</b>	<b>Ref. No.</b>	N/A
	510692		
	mechanical shaft seal for shaft $\varnothing$ 11 mm		
	<b>Part No.</b>	<b>Ref. No.</b>	N/A
	521702		
	pump cover gasket thickness 3.5x4.5mm Qty 1 pcs		







1

<b>Part No.</b>	500389	<b>Ref. No.</b>	3911
<b>description</b>	pump inlet $\varnothing$ 45mm outlet $\varnothing$ 40mm type 3911 230V 50Hz 1 phase 0,55kW 0,75HP rotation direction right FIR		



1





<b>Part No.</b>	500249	<b>Ref. No.</b>	3911.1421
<b>description</b>	pump inlet $\varnothing$ 45mm outlet $\varnothing$ 40mm type 3911.1421 230V 50Hz 1 phase 0,55kW 0,75HP L 205mm rotation direction right capacitor 12,5 $\mu$ F FIR		

<b>spare parts for</b>	500249			
	<b>Part No.</b>	365014	<b>Ref. No.</b>	—
		operating capacitor capacity 12,5 $\mu$ F 400V		
	<b>Part No.</b>	502007	<b>Ref. No.</b>	N/A
		pump cover gasket		
	<b>Part No.</b>	502014	<b>Ref. No.</b>	N/A
		pump cover FIR inlet $\varnothing$ 45 mm outlet $\varnothing$ 40 mm		
	<b>Part No.</b>	510610	<b>Ref. No.</b>	N/A
		impellor $\varnothing$ 95,5 mm H 23 mm shaft intake $\varnothing$ 9/8mm		
	<b>Part No.</b>	510692	<b>Ref. No.</b>	N/A
		mechanical shaft seal for shaft $\varnothing$ 11 mm		



1

<b>Part No.</b>	500479	<b>Ref. No.</b>	3911.1423
<b>description</b>	pump inlet $\varnothing$ 45mm outlet $\varnothing$ 40mm type 3911.1423 230V 50Hz 1 phase 0,56kW 0,75HP L 204mm rotation direction right capacitor 10 $\mu$ F FIR		

<b>spare parts for</b>	500479			
	<b>Part No.</b>	365015	<b>Ref. No.</b>	—
		operating capacitor capacity 10 $\mu$ F 400V		
	<b>Part No.</b>	510508	<b>Ref. No.</b>	N/A
		pump cover FIR inlet $\varnothing$ 45 mm outlet $\varnothing$ 40 mm		
	<b>Part No.</b>	510610	<b>Ref. No.</b>	N/A
		impellor $\varnothing$ 95,5 mm H 23 mm shaft intake $\varnothing$ 9/8mm		
	<b>Part No.</b>	510692	<b>Ref. No.</b>	N/A
		mechanical shaft seal for shaft $\varnothing$ 11 mm		
	<b>Part No.</b>	521702	<b>Ref. No.</b>	N/A
		pump cover gasket thickness 3.5x4.5mm Qty 1 pcs		



1

<b>Part No.</b>	500038	<b>Ref. No.</b>	3911.1425
<b>description</b>	pump inlet $\varnothing$ 45mm outlet $\varnothing$ 40mm type 3911.1425 230V 50Hz 1 phase 0,55kW 0,75HP L 205mm rotation direction right capacitor 10 $\mu$ F FIR		





<b>spare parts for</b>	500038			
	<b>Part No.</b>	365015	<b>Ref. No.</b>	—
		operating capacitor capacity 10 $\mu$ F 400V		

Table continues overleaf

spare parts for 500038			
	Part No.	510508	Ref. No. N/A
pump cover FIR inlet ø 45 mm outlet ø 40 mm			
	Part No.	510610	Ref. No. N/A
impellor ø 95,5 mm H 23 mm shaft intake ø 9/8mm			
	Part No.	510692	Ref. No. N/A
mechanical shaft seal for shaft ø 11 mm			
	Part No.	521702	Ref. No. N/A
pump cover gasket thickness 3.5x4.5mm Qty 1 pcs			



1

spare parts for 499189			
	Part No.	365014	Ref. No. —
operating capacitor capacity 12,5µF 400V			
	Part No.	510508	Ref. No. N/A
pump cover FIR inlet ø 45 mm outlet ø 40 mm			
	Part No.	510610	Ref. No. N/A
impellor ø 95,5 mm H 23 mm shaft intake ø 9/8mm			
	Part No.	510692	Ref. No. N/A
mechanical shaft seal for shaft ø 11 mm			
	Part No.	521702	Ref. No. N/A
pump cover gasket thickness 3.5x4.5mm Qty 1 pcs			



1

spare parts for 499335			
	Part No.	365014	Ref. No. —
operating capacitor capacity 12,5µF 400V			
	Part No.	510508	Ref. No. N/A
pump cover FIR inlet ø 45 mm outlet ø 40 mm			
	Part No.	510610	Ref. No. N/A
impellor ø 95,5 mm H 23 mm shaft intake ø 9/8mm			
	Part No.	510692	Ref. No. N/A
mechanical shaft seal for shaft ø 11 mm			
	Part No.	521702	Ref. No. N/A
pump cover gasket thickness 3.5x4.5mm Qty 1 pcs			



1





spare parts for 501502			
	Part No.	365014	Ref. No. —
operating capacitor capacity 12,5µF 400V			
	Part No.	510508	Ref. No. N/A
pump cover FIR inlet ø 45 mm outlet ø 40 mm			



Table continues overleaf





<b>spare parts for</b> 501502			
	Part No.	510610	Ref. No. N/A
impellor ø 95,5 mm H 23 mm shaft intake ø 9/8mm			
	Part No.	510692	Ref. No. N/A
mechanical shaft seal for shaft ø 11 mm			
	Part No.	521702	Ref. No. N/A
pump cover gasket thickness 3.5x4.5mm Qty 1 pcs			



<b>Part No.</b>	499207	<b>Ref. No.</b>	3911K2533
<b>description</b>	pump inlet ø 45mm outlet ø 40mm type 3911K2533 180-253V 50Hz 1 phase 0,55kW 0,75HP L 205mm rotation direction right capacitor 12,5µF FIR		
<b>spare parts for</b> 499207			
	Part No.	365014	Ref. No. —
operating capacitor capacity 12,5µF 400V			
	Part No.	510508	Ref. No. N/A
pump cover FIR inlet ø 45 mm outlet ø 40 mm			
	Part No.	510610	Ref. No. N/A
impellor ø 95,5 mm H 23 mm shaft intake ø 9/8mm			
	Part No.	510692	Ref. No. N/A
mechanical shaft seal for shaft ø 11 mm			
	Part No.	521702	Ref. No. N/A
pump cover gasket thickness 3.5x4.5mm Qty 1 pcs			



<b>Part No.</b>	500025	<b>Ref. No.</b>	3981.1400
<b>description</b>	pump inlet ø 45mm outlet ø 40mm type 3981.1400 230V 50Hz 1 phase 0,24kW 0,33HP rotation direction right FIR		





<b>Part No.</b>	500550	<b>Ref. No.</b>	3983
<b>description</b>	pump inlet ø 45mm outlet ø 40mm type 3983 230V 50Hz 1 phase 0,37kW 0,5HP L 210mm rotation direction right capacitor 12,5µF FIR		
<b>spare parts for</b> 500550			
	Part No.	502014	Ref. No. N/A
pump cover FIR inlet ø 45 mm outlet ø 40 mm			





1

<b>Part No.</b>	499043	<b>Ref. No.</b>	3983.1409
<b>description</b>	pump inlet ø 45mm outlet ø 40mm type 3983.1409 230V 50Hz 1 phase 0,37kW 0,51HP L 205mm rotation direction right capacitor 12,5µF FIR incl. capacitor		
<b>spare parts for</b>	499043		
	<b>Part No.</b>	365014	<b>Ref. No.</b> —
	operating capacitor capacity 12,5µF 400V		
	<b>Part No.</b>	510607	<b>Ref. No.</b> N/A
	impellor ø 85 mm H 29 mm shaft intake ø 9x8mm		
	<b>Part No.</b>	510692	<b>Ref. No.</b> N/A
	mechanical shaft seal for shaft ø 11 mm		
	<b>Part No.</b>	521539	<b>Ref. No.</b> N/A
	pump cover FIR inlet ø 45 mm outlet ø 40 mm		
	<b>Part No.</b>	521702	<b>Ref. No.</b> N/A
	pump cover gasket thickness 3.5x4.5mm Qty 1 pcs		



1

<b>Part No.</b>	500375	<b>Ref. No.</b>	3983
<b>description</b>	pump inlet ø 45mm outlet ø 40mm type 3983.1411 230V 50Hz 1 phase 0,37kW 0,5HP L 200mm rotation direction right capacitor 12,5µF FIR		





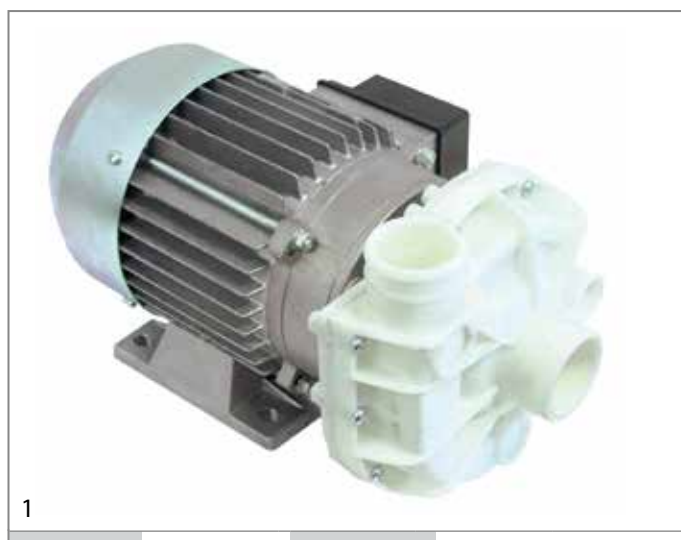

1

<b>Part No.</b>	500464	<b>Ref. No.</b>	4217
<b>description</b>	pump inlet ø 45mm outlet ø 40mm type 4217 230V 50Hz 1 phase 0,56kW 0,75HP L 290mm rotation direction right capacitor 12,5µF FIR		
<b>spare parts for</b>	500464		
	<b>Part No.</b>	365014	<b>Ref. No.</b> —
	operating capacitor capacity 12,5µF 400V		



1

<b>Part No.</b>	500264	<b>Ref. No.</b>	4217.2100
<b>description</b>	pump inlet ø 45mm outlet ø 40mm type 4217.2100 400V 50Hz 3 phase 0,55kW 0,75HP L 285mm rotation direction right FIR		
<b>spare parts for</b>	500264		
	<b>Part No.</b>	510610	<b>Ref. No.</b> N/A
	impellor ø 95,5 mm H 23 mm shaft intake ø 9/8mm		
	<b>Part No.</b>	510692	<b>Ref. No.</b> N/A
	mechanical shaft seal for shaft ø 11 mm		
	<b>Part No.</b>	521506	<b>Ref. No.</b> N/A
	pump cover FIR inlet ø 45 mm outlet ø 40 mm		
	<b>Part No.</b>	521702	<b>Ref. No.</b> N/A
	pump cover gasket thickness 3.5x4.5mm Qty 1 pcs		







1

<b>Part No.</b>	500266	<b>Ref. No.</b>	4217/A1 4217B2720
-----------------	--------	-----------------	----------------------

**description** pump inlet  $\varnothing$  45mm outlet  $\varnothing$  40mm type 4217B2720 230/400V 50Hz 3 phase 0,075kW 1HP L 290mm rotation direction right FIR

**spare parts for** 500266

	Part No.	510508	Ref. No.	N/A
pump cover FIR inlet $\varnothing$ 45 mm outlet $\varnothing$ 40 mm				
	Part No.	510600	Ref. No.	N/A
impellor $\varnothing$ 102 mm H 29 mm shaft intake $\varnothing$ 9/8mm				
	Part No.	510692	Ref. No.	N/A
mechanical shaft seal for shaft $\varnothing$ 11 mm				
	Part No.	521702	Ref. No.	N/A
pump cover gasket thickness 3.5x4.5mm Qty 1 pcs				





1



<b>Part No.</b>	499128	<b>Ref. No.</b>	4228.1503
-----------------	--------	-----------------	-----------

**description** pump inlet  $\varnothing$  45mm outlet  $\varnothing$  40mm type 4228.1503 230V 50Hz 0,55kW L 207mm rotation direction right capacitor 12,5 $\mu$ F FIR

**spare parts for** 499128

	Part No.	365014	Ref. No.	—
operating capacitor capacity 12,5 $\mu$ F 400V				
	Part No.	510508	Ref. No.	N/A
pump cover FIR inlet $\varnothing$ 45 mm outlet $\varnothing$ 40 mm				

**spare parts for** 499128

	Part No.	510693	Ref. No.	N/A
mechanical shaft seal for shaft $\varnothing$ 12 mm				
	Part No.	521702	Ref. No.	N/A
pump cover gasket thickness 3.5x4.5mm Qty 1 pcs				
	Part No.	524358	Ref. No.	N/A
impellor $\varnothing$ 96 mm H 23 mm shaft intake $\varnothing$ M7Lmm				







1

<b>Part No.</b>	500400	<b>Ref. No.</b>	4255.1600
-----------------	--------	-----------------	-----------

**description** pump inlet  $\varnothing$  45mm outlet  $\varnothing$  40mm type 4255.1600 230V 50Hz 1 phase 0,55kW 0,75HP L 215mm rotation direction right capacitor 12,5 $\mu$ F FIR

**spare parts for** 500400

	Part No.	365014	Ref. No.	—
operating capacitor capacity 12,5 $\mu$ F 400V				
	Part No.	510692	Ref. No.	N/A
mechanical shaft seal for shaft $\varnothing$ 11 mm				
	Part No.	521210	Ref. No.	N/A
impellor $\varnothing$ 96 mm H 30 mm shaft intake $\varnothing$ 9/8mm				
	Part No.	521506	Ref. No.	N/A
pump cover FIR inlet $\varnothing$ 45 mm outlet $\varnothing$ 40 mm				
	Part No.	521702	Ref. No.	N/A
pump cover gasket thickness 3.5x4.5mm Qty 1 pcs				



1

<b>Part No.</b>	499045	<b>Ref. No.</b>	4268.2350
<b>description</b>	pump inlet ø 45mm outlet ø 40mm type 4268.2350 230V 50Hz 1 phase 0,45kW 0,6HP L 205mm rotation direction right capacitor 12,5µF FIR		



1





<b>Part No.</b>	500981	<b>Ref. No.</b>	4281.2350
<b>description</b>	pump inlet ø 45mm outlet ø 40mm type 4281.2350 230V 50Hz 1 phase 0,55kW 0,75HP L 230mm rotation direction right capacitor 12,5µF FIR		



1



<b>Part No.</b>	499123	<b>Ref. No.</b>	4296.2350
<b>description</b>	pump inlet ø 45mm outlet ø 40mm type 4296.2350 230V 50Hz 1 phase 0,75kW L 250mm rotation direction right capacitor 16µF FIR		
<b>spare parts for</b>	499123		
		Part No. 365021	Ref. No. —
	operating capacitor capacity 16µF 425V		

**spare parts for** 499123

	Part No. 510608	Ref. No.	N/A
	impellor ø 93 mm H 32 mm shaft intake ø 9/8mm		
	Part No. 510692	Ref. No.	N/A
	mechanical shaft seal for shaft ø 11 mm		
	Part No. 521539	Ref. No.	N/A
	pump cover FIR inlet ø 45 mm outlet ø 40 mm		
	Part No. 521702	Ref. No.	N/A
	pump cover gasket thickness 3.5x4.5mm Qty 1 pcs		



1

<b>Part No.</b>	501401	<b>Ref. No.</b>	5283
<b>description</b>	pump inlet ø 45mm outlet ø 40mm type 5283 230V 50Hz 1 phase 0,37kW L 205mm FIR		
<b>spare parts for</b>	501401		
		Part No. 365014	Ref. No. —
	operating capacitor capacity 12,5µF 400V		
	Part No. 510608	Ref. No.	N/A
	impellor ø 93 mm H 32 mm shaft intake ø 9/8mm		
	Part No. 510692	Ref. No.	N/A
	mechanical shaft seal for shaft ø 11 mm		
	Part No. 521506	Ref. No.	N/A
	pump cover FIR inlet ø 45 mm outlet ø 40 mm		
	Part No. 521702	Ref. No.	N/A
	pump cover gasket thickness 3.5x4.5mm Qty 1 pcs		





1





<b>Part No.</b>	501400	<b>Ref. No.</b>	B206.1500
<b>description</b>	pump inlet ø 45mm outlet ø 40mm type B206.1500 230V 50Hz 1 phase 0,55kW L 235mm FIR		
<b>spare parts for</b>	501400		
	<b>Part No.</b>	365014	<b>Ref. No.</b> —
	operating capacitor capacity 12,5µF 400V		
	<b>Part No.</b>	510508	<b>Ref. No.</b> N/A
	pump cover FIR inlet ø 45 mm outlet ø 40 mm		
	<b>Part No.</b>	510600	<b>Ref. No.</b> N/A
	impellor ø 102 mm H 29 mm shaft intake ø 9/8mm		
	<b>Part No.</b>	510692	<b>Ref. No.</b> N/A
	mechanical shaft seal for shaft ø 11 mm		
	<b>Part No.</b>	521023	<b>Ref. No.</b> —
	fanwheel cover ED ø 150mm H 70mm for wash pump		
	<b>Part No.</b>	521702	<b>Ref. No.</b> N/A
	pump cover gasket thickness 3.5x4.5mm Qty 1 pcs		



1





<b>Part No.</b>	500396	<b>Ref. No.</b>	B257.1605 B257.1700
<b>description</b>	pump inlet ø 45mm outlet ø 40mm type B257.1700 230V 50Hz 1 phase 0,75kW 1HP L 220mm rotation direction right capacitor 16µF FIR		
<b>spare parts for</b>	500396		
	<b>Part No.</b>	365021	<b>Ref. No.</b> —
	operating capacitor capacity 16µF 425V		

**spare parts for** 500396

	<b>Part No.</b>	510508	<b>Ref. No.</b>	N/A
	pump cover FIR inlet ø 45 mm outlet ø 40 mm			
	<b>Part No.</b>	510692	<b>Ref. No.</b>	N/A
	mechanical shaft seal for shaft ø 11 mm			
	<b>Part No.</b>	521001	<b>Ref. No.</b>	N/A
	impellor ø 91 mm H 30 mm pump type B267.4050			
	<b>Part No.</b>	521702	<b>Ref. No.</b>	N/A
	pump cover gasket thickness 3.5x4.5mm Qty 1 pcs			



1

<b>Part No.</b>	500370	<b>Ref. No.</b>	B267.2350
<b>description</b>	pump inlet ø 45mm outlet ø 40mm type B267.2350 230V 50Hz 1 phase 0,55kW 0,75HP L 230mm rotation direction right capacitor 16µF FIR		
<b>spare parts for</b>	500370		
	<b>Part No.</b>	365021	<b>Ref. No.</b> —
	operating capacitor capacity 16µF 425V		
	<b>Part No.</b>	510693	<b>Ref. No.</b> N/A
	mechanical shaft seal for shaft ø 12 mm		
	<b>Part No.</b>	521506	<b>Ref. No.</b> N/A
	pump cover FIR inlet ø 45 mm outlet ø 40 mm		
	<b>Part No.</b>	521702	<b>Ref. No.</b> N/A
	pump cover gasket thickness 3.5x4.5mm Qty 1 pcs		





1

<b>Part No.</b>	500369	<b>Ref. No.</b>	B267.4050
<b>description</b>	pump inlet ø 45mm outlet ø 40mm type B267.4050 230/400V 50Hz 3 phase 0,75kW 1HP L 230mm rotation direction right FIR		
<b>spare parts for</b>	500369		
	<b>Part No.</b>	510692	<b>Ref. No.</b> N/A
	mechanical shaft seal for shaft ø 11 mm		
	<b>Part No.</b>	521001	<b>Ref. No.</b> N/A
	impellor ø 91 mm H 30 mm pump type B267.4050		
	<b>Part No.</b>	521506	<b>Ref. No.</b> N/A
	pump cover FIR inlet ø 45 mm outlet ø 40 mm		
	<b>Part No.</b>	521702	<b>Ref. No.</b> N/A
	pump cover gasket thickness 3.5x4.5mm Qty 1 pcs		



1

<b>Part No.</b>	499304	<b>Ref. No.</b>	3983.1409
<b>description</b>	pump inlet ø 45mm outlet ø 41mm type 3983.1409 230V 50Hz 1 phase 0,37kW 0,5HP L 200mm rotation direction right capacitor 12,5µF FIR kit		
<b>spare parts for</b>	499304		
	<b>Part No.</b>	365014	<b>Ref. No.</b> —
	operating capacitor capacity 12,5µF 400V		
	<b>Part No.</b>	510607	<b>Ref. No.</b> N/A
	impellor ø 85 mm H 29 mm shaft intake ø 9x8mm		
	<b>Part No.</b>	510692	<b>Ref. No.</b> N/A
	mechanical shaft seal for shaft ø 11 mm		
	<b>Part No.</b>	521539	<b>Ref. No.</b> N/A
	pump cover FIR inlet ø 45 mm outlet ø 40 mm		
	<b>Part No.</b>	521702	<b>Ref. No.</b> N/A
	pump cover gasket thickness 3.5x4.5mm Qty 1 pcs		



1

<b>Part No.</b>	499285	<b>Ref. No.</b>	4242.1400
<b>description</b>	pump inlet ø 45mm outlet ø 43mm type 4242.1400 230V 50Hz 1 phase 0,37kW 0,5HP L 270mm rotation direction right FIR		



1

<b>Part No.</b>	500989	<b>Ref. No.</b>	4242.1500
<b>description</b>	pump inlet ø 45mm outlet ø 43mm type 4242.1500 230V 50Hz 1 phase 0,55kW 0,75HP L 275mm rotation direction right capacitor 12,5µF FIR 2800rpm		
<b>spare parts for</b>	500989		
	<b>Part No.</b>	365014	<b>Ref. No.</b> —
	operating capacitor capacity 12,5µF 400V		



1

<b>Part No.</b>	500560	<b>Ref. No.</b>	B250.1500
-----------------	--------	-----------------	-----------

<b>description</b>	pump inlet $\varnothing$ 50mm outlet $\varnothing$ 37mm type B250.1500 230V 50Hz 1 phase 0,9kW 1,2HP L 265mm rotation direction left capacitor 12,5 $\mu$ F FIR		
--------------------	---	--	--

**spare parts for** 500560

<b>Part No.</b>	365014	<b>Ref. No.</b>	—
-----------------	--------	-----------------	---

operating capacitor capacity 12,5 $\mu$ F 400V

<b>Part No.</b>	510693	<b>Ref. No.</b>	N/A
-----------------	--------	-----------------	-----

mechanical shaft seal for shaft  $\varnothing$  12 mm

<b>Part No.</b>	521273	<b>Ref. No.</b>	N/A
-----------------	--------	-----------------	-----

impellor  $\varnothing$  103 mm H 27 mm rotation direction left

<b>Part No.</b>	521567	<b>Ref. No.</b>	N/A
-----------------	--------	-----------------	-----

pump cover FIR inlet  $\varnothing$  50 mm outlet  $\varnothing$  37 mm

<b>Part No.</b>	521702	<b>Ref. No.</b>	N/A
-----------------	--------	-----------------	-----



pump cover gasket thickness 3.5x4.5mm Qty 1 pcs

**spare parts for** 499055

<b>Part No.</b>	509031	<b>Ref. No.</b>	—
-----------------	--------	-----------------	---

impellor  $\varnothing$  93 mm H 31 mm shaft  $\varnothing$  12 mm

<b>Part No.</b>	510552	<b>Ref. No.</b>	N/A
-----------------	--------	-----------------	-----



pump cover gasket

<b>Part No.</b>	510692	<b>Ref. No.</b>	N/A
-----------------	--------	-----------------	-----

mechanical shaft seal for shaft  $\varnothing$  11 mm

<b>Part No.</b>	513713	<b>Ref. No.</b>	—
-----------------	--------	-----------------	---



pump cover bottom part

<b>Part No.</b>	521562	<b>Ref. No.</b>	—
-----------------	--------	-----------------	---



pump cover

<b>Part No.</b>	523509	<b>Ref. No.</b>	—
-----------------	--------	-----------------	---



deep-groove ball bearing type 6201-2RS



1

<b>Part No.</b>	500927	<b>Ref. No.</b>	0213.1600
-----------------	--------	-----------------	-----------

<b>description</b>	pump inlet $\varnothing$ 53mm outlet $\varnothing$ 44mm type 0213.1600 230V 50/60Hz 1 phase 1kW 1,36HP L 290mm rotation direction right capacitor 12,5 $\mu$ F FIR		
--------------------	--	--	--

**spare parts for** 500927

<b>Part No.</b>	365014	<b>Ref. No.</b>	—
-----------------	--------	-----------------	---

operating capacitor capacity 12,5 $\mu$ F 400V

<b>Part No.</b>	509010	<b>Ref. No.</b>	N/A
-----------------	--------	-----------------	-----

impellor  $\varnothing$  105 mm H 20 mm M10L

<b>Part No.</b>	510693	<b>Ref. No.</b>	N/A
-----------------	--------	-----------------	-----

mechanical shaft seal for shaft  $\varnothing$  12 mm

<b>Part No.</b>	521543	<b>Ref. No.</b>	—
-----------------	--------	-----------------	---

pump cover ELFRAMO inlet  $\varnothing$  53 mm outlet  $\varnothing$  44 mm

<b>Part No.</b>	521717	<b>Ref. No.</b>	—
-----------------	--------	-----------------	---

O-ring EPDM thickness 1,78 mm ID  $\varnothing$  120,37 mm

1

<b>Part No.</b>	499055	<b>Ref. No.</b>	0237
-----------------	--------	-----------------	------

<b>description</b>	pump inlet $\varnothing$ 50mm outlet $\varnothing$ 49mm type 0237 220-240V 50Hz 1 phase 0,6kW 0,8HP L 230mm rotation direction right capacitor 16 $\mu$ F FIR		
--------------------	---	--	--



**spare parts for** 499055

<b>Part No.</b>	365021	<b>Ref. No.</b>	—
-----------------	--------	-----------------	---

operating capacitor capacity 16 $\mu$ F 425V







1

<b>Part No.</b>	500278	<b>Ref. No.</b>	AF90L/2C-12
<b>description</b>	pump inlet ø 57mm outlet ø 49mm type AF90L/2C-12 400V 50Hz 3 phase 2,7kW 3,7HP L 400mm rotation direction right FIR inlet ø 57mm outlet ø 49mm		
<b>spare parts for</b>	500278		
	<b>Part No.</b>	502002	<b>Ref. No.</b> —
	gasket set		
	<b>Part No.</b>	502008	<b>Ref. No.</b> —
	impellor ø 137 mm H 45 mm		



1

<b>Part No.</b>	499091	<b>Ref. No.</b>	2233S1500
<b>description</b>	pump inlet ø 60mm outlet ø 47mm type 2233S1500 230V 50Hz 1 phase 0,89kW 1,22HP L 251mm rotation direction right capacitor 16µF FIR		
<b>spare parts for</b>	499091		
	<b>Part No.</b>	365021	<b>Ref. No.</b> —
	operating capacitor capacity 16µF 425V		
	<b>Part No.</b>	510552	<b>Ref. No.</b> N/A
	pump cover gasket		
	<b>Part No.</b>	510693	<b>Ref. No.</b> N/A
	mechanical shaft seal for shaft ø 12 mm		
	<b>Part No.</b>	521067	<b>Ref. No.</b> N/A
	service kit for pump type 2233S1500		
	<b>Part No.</b>	521512	<b>Ref. No.</b> N/A
	pump cover FIR inlet ø 60 mm outlet ø 50 mm		



1

<b>Part No.</b>	500527	<b>Ref. No.</b>	2233.B140
<b>description</b>	pump inlet ø 60mm outlet ø 50/30mm type 2233.B140 230V 50Hz 1 phase 0,55kW 0,75HP L 210mm rotation direction right capacitor 12,5µF FIR inlet ø 60mm		
<b>spare parts for</b>	500527		
	<b>Part No.</b>	365014	<b>Ref. No.</b> —
	operating capacitor capacity 12,5µF 400V		
	<b>Part No.</b>	510552	<b>Ref. No.</b> N/A
	pump cover gasket		
	<b>Part No.</b>	510608	<b>Ref. No.</b> N/A
	impellor ø 93 mm H 32 mm shaft intake ø 9/8mm		
	<b>Part No.</b>	510692	<b>Ref. No.</b> N/A
	mechanical shaft seal for shaft ø 11 mm		
	<b>Part No.</b>	521511	<b>Ref. No.</b> N/A
	pump cover inlet ø 60 mm outlet ø 50/30mm		



1





<b>Part No.</b>	500683	<b>Ref. No.</b>	2233.U150
<b>description</b>	pump inlet ø 60mm outlet ø 50mm type 2233.U150 230V 50Hz 1 phase 0,89kW 1,2HP L 260mm rotation direction right capacitor 16µF FIR		
<b>spare parts for</b>	500683		
	<b>Part No.</b>	365021	<b>Ref. No.</b> —
	operating capacitor capacity 16µF 425V		

Table continues overleaf





spare parts for 500683			
	Part No.	510552	Ref. No. N/A
	pump cover gasket		
	Part No.	510600	Ref. No. N/A
	impellor $\varnothing$ 102 mm H 29 mm shaft intake $\varnothing$ 9/8mm		
	Part No.	510692	Ref. No. N/A
	mechanical shaft seal for shaft $\varnothing$ 11 mm		
	Part No.	521511	Ref. No. N/A
	pump cover inlet $\varnothing$ 60 mm outlet $\varnothing$ 50/30mm		



1			
Part No.	499231	Ref. No.	2233A2350
description	pump inlet $\varnothing$ 60mm outlet $\varnothing$ 50mm type 2233A2350 230V 50Hz 1 phase 0,75kW L 255mm rotation direction right capacitor 16 $\mu$ F FIR inlet $\varnothing$ 60mm outlet $\varnothing$ 50mm		
spare parts for 499231			
	Part No.	365021	Ref. No. —
	operating capacitor capacity 16 $\mu$ F 425V		
	Part No.	510529	Ref. No. N/A
	impellor $\varnothing$ 103 mm H 30 mm shaft intake $\varnothing$ 9/8mm		
	Part No.	510552	Ref. No. N/A
	pump cover gasket		
	Part No.	510692	Ref. No. N/A
	mechanical shaft seal for shaft $\varnothing$ 11 mm		
	Part No.	521512	Ref. No. N/A
	pump cover FIR inlet $\varnothing$ 60 mm outlet $\varnothing$ 50 mm		



1			
Part No.	500709	Ref. No.	2278A2251
description	pump inlet $\varnothing$ 60mm outlet $\varnothing$ 50mm type 2278 230V 50Hz 1 phase 0,75kW 1HP L 300mm rotation direction right capacitor 16 $\mu$ F FIR		



1			
Part No.	500544	Ref. No.	4223.1900
description	pump inlet $\varnothing$ 60mm outlet $\varnothing$ 50mm type 4223.1900 230V 50Hz 1 phase 0,73kW 1HP L 225mm rotation direction right capacitor 16 $\mu$ F FIR		
spare parts for 500544			
	Part No.	365021	Ref. No. —
	operating capacitor capacity 16 $\mu$ F 425V		
	Part No.	510552	Ref. No. N/A
	pump cover gasket		
	Part No.	510693	Ref. No. N/A
	mechanical shaft seal for shaft $\varnothing$ 12 mm		
	Part No.	518067	Ref. No. N/A
	impellor $\varnothing$ 103 mm H 29 mm M7L		
	Part No.	521512	Ref. No. N/A
	pump cover FIR inlet $\varnothing$ 60 mm outlet $\varnothing$ 50 mm		





1

<b>Part No.</b>	500528	<b>Ref. No.</b>	4233.1500
<b>description</b>	pump inlet $\varnothing$ 60mm outlet $\varnothing$ 50mm type 4233.1500 230V 50Hz 1 phase 0,74kW 1HP L 220mm rotation direction right capacitor 16 $\mu$ F FIR		
<b>spare parts for</b>	500528		
	<b>Part No.</b>	365021	<b>Ref. No.</b> —
	operating capacitor capacity 16 $\mu$ F 425V		
	<b>Part No.</b>	510552	<b>Ref. No.</b> N/A
	pump cover gasket		
	<b>Part No.</b>	510693	<b>Ref. No.</b> N/A
	mechanical shaft seal for shaft $\varnothing$ 12 mm		
	<b>Part No.</b>	517319	<b>Ref. No.</b> —
	hose connector T1: M12x1.75 hose $\varnothing$ 11mm brass		
	<b>Part No.</b>	521177	<b>Ref. No.</b> N/A
	impellor $\varnothing$ 93 mm H 23 mm thread M10L		
	<b>Part No.</b>	521511	<b>Ref. No.</b> N/A
	pump cover inlet $\varnothing$ 60 mm outlet $\varnothing$ 50/30mm		



1

<b>Part No.</b>	499281	<b>Ref. No.</b>	4298.1404
<b>description</b>	pump inlet $\varnothing$ 60mm outlet $\varnothing$ 50mm type 4298.1404 230V 50Hz 1 phase 1,1kW L 210mm rotation direction right capacitor 12,5 $\mu$ F FIR		
<b>spare parts for</b>	499281		
	<b>Part No.</b>	365014	<b>Ref. No.</b> —
	operating capacitor capacity 12,5 $\mu$ F 400V		

<b>spare parts for</b>	499281		
	<b>Part No.</b>	510600	<b>Ref. No.</b> N/A
	impellor $\varnothing$ 102 mm H 29 mm shaft intake $\varnothing$ 9/8mm		
	<b>Part No.</b>	510692	<b>Ref. No.</b> N/A
	mechanical shaft seal for shaft $\varnothing$ 11 mm		
	<b>Part No.</b>	521702	<b>Ref. No.</b> N/A
	pump cover gasket thickness 3.5x4.5mm Qty 1 pcs		
	<b>Part No.</b>	698762	<b>Ref. No.</b> N/A
	pump cover FIR inlet $\varnothing$ 60mmmm outlet $\varnothing$ 50mmmm		



1

<b>Part No.</b>	499336	<b>Ref. No.</b>	2250.2732
<b>description</b>	pump inlet $\varnothing$ 62 outlet $\varnothing$ 62 type 2250.2732 230/400V 50Hz 2,95kW 4HP		
<b>spare parts for</b>	499336		
	<b>Part No.</b>	510687	<b>Ref. No.</b> N/A
	mechanical shaft seal for shaft $\varnothing$ 18 mm		
	<b>Part No.</b>	521026	<b>Ref. No.</b> N/A
	pump cover gasket ID $\varnothing$ 182,5 mm thickness 5x4.5mm		
	<b>Part No.</b>	521028	<b>Ref. No.</b> N/A
	pump cover FIR inlet $\varnothing$ 62 mm outlet $\varnothing$ 62 mm		
	<b>Part No.</b>	521277	<b>Ref. No.</b> N/A
	impellor $\varnothing$ 135 mm H 39 mm		



1

<b>Part No.</b>	500098	<b>Ref. No.</b>	B215.2500
-----------------	--------	-----------------	-----------

**description** pump inlet  $\varnothing$  62mm outlet  $\varnothing$  49mm type B215.2500 230/400V 50/60Hz 3 phase 1,5kW 2HP L 332mm rotation direction right FIR

**spare parts for** 500098

	<b>Part No.</b>	510693	<b>Ref. No.</b>	N/A
---	-----------------	--------	-----------------	-----

mechanical shaft seal for shaft  $\varnothing$  12 mm

	<b>Part No.</b>	511148	<b>Ref. No.</b>	—
---	-----------------	--------	-----------------	---

impellor  $\varnothing$  118 mm H 20 mm M10L

	<b>Part No.</b>	521544	<b>Ref. No.</b>	N/A
---	-----------------	--------	-----------------	-----

pump cover inlet  $\varnothing$  63 mm outlet  $\varnothing$  50 mm

	<b>Part No.</b>	521718	<b>Ref. No.</b>	N/A
---	-----------------	--------	-----------------	-----

O-ring EPDM thickness 3,53 mm ID  $\varnothing$  164,7 mm



1

<b>Part No.</b>	499051	<b>Ref. No.</b>	B214.1600
-----------------	--------	-----------------	-----------

**description** pump inlet  $\varnothing$  62mm outlet  $\varnothing$  50mm type B214 230V 50/60Hz 1 phase 1kW rotation direction right capacitor 12,5 $\mu$ F FIR

**spare parts for** 499051

	<b>Part No.</b>	365014	<b>Ref. No.</b>	—
---	-----------------	--------	-----------------	---

operating capacitor capacity 12,5 $\mu$ F 400V





	<b>Part No.</b>	509010	<b>Ref. No.</b>	N/A
---	-----------------	--------	-----------------	-----

impellor  $\varnothing$  105 mm H 20 mm M10L

	<b>Part No.</b>	510693	<b>Ref. No.</b>	N/A
---	-----------------	--------	-----------------	-----

mechanical shaft seal for shaft  $\varnothing$  12 mm

**spare parts for** 499051

	<b>Part No.</b>	517174	<b>Ref. No.</b>	—
nut thread M8 H 6,5mm WS 13 SS				
	<b>Part No.</b>	521544	<b>Ref. No.</b>	N/A
pump cover inlet $\varnothing$ 63 mm outlet $\varnothing$ 50 mm				
	<b>Part No.</b>	521718	<b>Ref. No.</b>	N/A
O-ring EPDM thickness 3,53 mm ID $\varnothing$ 164,7 mm				
	<b>Part No.</b>	560312	<b>Ref. No.</b>	—
plain washer ID $\varnothing$ 10,5mm ED $\varnothing$ 20mm thickness 2mm				



1

<b>Part No.</b>	499268	<b>Ref. No.</b>	4290.6600
-----------------	--------	-----------------	-----------

**description** pump inlet  $\varnothing$  62mm outlet  $\varnothing$  61mm type 4290.6600 220-254/380-440V 60Hz 3 phase 1,5kW L 350mm rotation direction right FIR



1

<b>Part No.</b>	499334	<b>Ref. No.</b>	2250.2731 2250/C
-----------------	--------	-----------------	---------------------

**description** pump inlet  $\varnothing$  62mm outlet  $\varnothing$  62mm type 2250.2731 230/400V 50Hz 1 phase 3kW FIR

**spare parts for** 499334



	<b>Part No.</b>	510687	<b>Ref. No.</b>	N/A
---	-----------------	--------	-----------------	-----

mechanical shaft seal for shaft  $\varnothing$  18 mm

	<b>Part No.</b>	512455	<b>Ref. No.</b>	—
---	-----------------	--------	-----------------	---

fan wheel  $\varnothing$  155mm H 18mm shaft intake  $\varnothing$  18mm





Table continues overleaf

<b>spare parts for</b> 499334			
	Part No.	521026	Ref. No. N/A
	pump cover gasket ID ø 182,5 mm thickness 5x4.5mm		
	Part No.	521028	Ref. No. N/A
	pump cover FIR inlet ø 62 mm outlet ø 62 mm		
	Part No.	521277	Ref. No. N/A
	impellor ø 135 mm H 39 mm		



<b>1</b>			
<b>Part No.</b>	499139	<b>Ref. No.</b>	2275.2722
<b>description</b>	pump inlet ø 62mm outlet ø 62mm type 2275.2722 230/400V 50Hz 3 phase 2,6kW L 400mm rotation direction right FIR		
<b>spare parts for</b> 499139			
	Part No.	510687	Ref. No. N/A
	mechanical shaft seal for shaft ø 18 mm		
	Part No.	521026	Ref. No. N/A
	pump cover gasket ID ø 182,5 mm thickness 5x4.5mm		
	Part No.	521028	Ref. No. N/A
	pump cover FIR inlet ø 62 mm outlet ø 62 mm		
	Part No.	521277	Ref. No. N/A
	impellor ø 135 mm H 39 mm		
	Part No.	524676	Ref. No. —
	fan wheel ø 160mm shaft intake ø 24mm plastic		



<b>1</b>			
<b>Part No.</b>	500986	<b>Ref. No.</b>	4290.2700
<b>description</b>	pump inlet ø 62mm outlet ø 62mm type 4290.2700 220-240/380-415V 50Hz 3 phase 1,5kW 2HP L 350mm rotation direction right FIR		
<b>spare parts for</b> 500986			
	Part No.	510687	Ref. No. N/A
	mechanical shaft seal for shaft ø 18 mm		
	Part No.	521017	Ref. No. N/A
	impellor ø 120 mm H 35 mm rotation direction right		
	Part No.	521026	Ref. No. N/A
	pump cover gasket ID ø 182,5 mm thickness 5x4.5mm		
	Part No.	521028	Ref. No. N/A
	pump cover FIR inlet ø 62 mm outlet ø 62 mm		







<b>1</b>			
<b>Part No.</b>	500985	<b>Ref. No.</b>	4290.2700
<b>description</b>	pump inlet ø 62mm outlet ø 64mm type 4290.2700 220-240/380-415V 50Hz 3 phase 1,5kW 2HP L 350mm rotation direction right FIR installation kit inclusive		







1



<b>Part No.</b>	501487	<b>Ref. No.</b>	4267.5050
<b>description</b>	pump inlet $\varnothing$ 63mm outlet $\varnothing$ 40mm type 4267.5050 230/400V 50Hz 3 phase 1,5kW L 300mm rotation direction right FIR		
<b>spare parts for</b>	501487		
	<b>Part No.</b>	502273	<b>Ref. No.</b> N/A
	pump cover FIR inlet $\varnothing$ 63 mm outlet $\varnothing$ 2x40mm		
	<b>Part No.</b>	510602	<b>Ref. No.</b> 1225315/S
	impellor $\varnothing$ 110 mm H 34 mm rotation direction right		
	<b>Part No.</b>	510693	<b>Ref. No.</b> N/A
	mechanical shaft seal for shaft $\varnothing$ 12 mm		
	<b>Part No.</b>	524416	<b>Ref. No.</b> N/A
	pump cover gasket thickness 4x4mm Qty 1 pcs		



1





<b>Part No.</b>	500112	<b>Ref. No.</b>	1214.1000
<b>description</b>	pump inlet $\varnothing$ 63mm outlet $\varnothing$ 47mm 230/400V 50Hz 3 phase 0,55kW 0,75HP L 305mm rotation direction right FIR		
<b>spare parts for</b>	500112		
	<b>Part No.</b>	510601	<b>Ref. No.</b> N/A
	impellor $\varnothing$ 103 mm H 25 mm rotation direction right		
	<b>Part No.</b>	510693	<b>Ref. No.</b> N/A
	mechanical shaft seal for shaft $\varnothing$ 12 mm		

spare parts for 500112

	<b>Part No.</b>	521513	<b>Ref. No.</b>	N/A
	pump cover FIR inlet $\varnothing$ 63 mm outlet $\varnothing$ 47 mm			
	<b>Part No.</b>	524416	<b>Ref. No.</b>	N/A
	pump cover gasket thickness 4x4mm Qty 1 pcs			



1

<b>Part No.</b>	500056	<b>Ref. No.</b>	1211.2706 1211ST.10
<b>description</b>	pump inlet $\varnothing$ 63mm outlet $\varnothing$ 47mm type 1211.2706 230/400V 50Hz 3 phase 0,55kW 0,75HP L 305mm rotation direction right FIR		
<b>spare parts for</b>	500056		
	<b>Part No.</b>	510601	<b>Ref. No.</b> N/A
	impellor $\varnothing$ 103 mm H 25 mm rotation direction right		
	<b>Part No.</b>	510693	<b>Ref. No.</b> N/A
	mechanical shaft seal for shaft $\varnothing$ 12 mm		
	<b>Part No.</b>	521513	<b>Ref. No.</b> N/A
	pump cover FIR inlet $\varnothing$ 63 mm outlet $\varnothing$ 47 mm		
	<b>Part No.</b>	524416	<b>Ref. No.</b> N/A
	pump cover gasket thickness 4x4mm Qty 1 pcs		



1









<b>Part No.</b>	500687	<b>Ref. No.</b>	1211ST.10
<b>description</b>	pump inlet $\varnothing$ 63mm outlet $\varnothing$ 47mm type 1211ST.10 230/400V 50Hz 3 phase 0,55kW 0,75HP L 305mm rotation direction right FIR		
<b>spare parts for</b>	500687		
	<b>Part No.</b>	510601	<b>Ref. No.</b> N/A
	impellor $\varnothing$ 103 mm H 25 mm rotation direction right		

Table continues overleaf







<b>spare parts for</b> 500687			
	Part No.	510693	Ref. No. N/A
	mechanical shaft seal for shaft $\varnothing$ 12 mm		
	Part No.	521513	Ref. No. N/A
	pump cover FIR inlet $\varnothing$ 63 mm outlet $\varnothing$ 47 mm		
	Part No.	524416	Ref. No. N/A
	pump cover gasket thickness 4x4mm Qty 1 pcs		



<b>1</b>			
<b>Part No.</b>	500155	<b>Ref. No.</b>	1225
<b>description</b>	pump inlet $\varnothing$ 63mm outlet $\varnothing$ 47mm type 1225 230V 50Hz 1 phase 1,1kW 1,5HP L 335mm rotation direction right capacitor 31,5 $\mu$ F FIR		
<b>spare parts for</b> 500155			
	Part No.	365016	Ref. No. —
	operating capacitor capacity 31,5 $\mu$ F 400V		
	Part No.	510602	Ref. No. 1225315/S
	impellor $\varnothing$ 110 mm H 34 mm rotation direction right		
	Part No.	510693	Ref. No. N/A
	mechanical shaft seal for shaft $\varnothing$ 12 mm		
	Part No.	521513	Ref. No. N/A
	pump cover FIR inlet $\varnothing$ 63 mm outlet $\varnothing$ 47 mm		
	Part No.	524416	Ref. No. N/A
	pump cover gasket thickness 4x4mm Qty 1 pcs		



<b>1</b>			
<b>Part No.</b>	500708	<b>Ref. No.</b>	1225.1420
<b>description</b>	pump inlet $\varnothing$ 63mm outlet $\varnothing$ 47mm type 1225.1420 230V 50Hz 1 phase 1,1kW 1,5HP L 335mm rotation direction right capacitor 31,5 $\mu$ F FIR		
<b>spare parts for</b> 500708			
	Part No.	365016	Ref. No. —
	operating capacitor capacity 31,5 $\mu$ F 400V		
	Part No.	510602	Ref. No. 1225315/S
	impellor $\varnothing$ 110 mm H 34 mm rotation direction right		
	Part No.	510693	Ref. No. N/A
	mechanical shaft seal for shaft $\varnothing$ 12 mm		
	Part No.	524416	Ref. No. N/A
	pump cover gasket thickness 4x4mm Qty 1 pcs		







<b>1</b>			
<b>Part No.</b>	500023	<b>Ref. No.</b>	1225.2725
<b>description</b>	pump inlet $\varnothing$ 63mm outlet $\varnothing$ 47mm type 1225.2725 230/400V 50Hz 3 phase 1,1kW 1,5HP L 335mm rotation direction right FIR		
<b>spare parts for</b> 500023			
	Part No.	510602	Ref. No. 1225315/S
	impellor $\varnothing$ 110 mm H 34 mm rotation direction right		
	Part No.	510693	Ref. No. N/A
	mechanical shaft seal for shaft $\varnothing$ 12 mm		

Table continues overleaf



<b>spare parts for</b> 500023			
	<b>Part No.</b> 521513	<b>Ref. No.</b>	N/A
pump cover FIR inlet $\varnothing$ 63 mm outlet $\varnothing$ 47 mm			
	<b>Part No.</b> 524416	<b>Ref. No.</b>	N/A
pump cover gasket thickness 4x4mm Qty 1 pcs			



1

<b>Part No.</b>	499187	<b>Ref. No.</b>	1226.2530
<b>description</b>	pump inlet $\varnothing$ 63mm outlet $\varnothing$ 47mm type 1226.2530 230/400V 50Hz 3 phase 1,5kW 2HP L 335mm rotation direction right FIR		







1

<b>Part No.</b>	500742	<b>Ref. No.</b>	1226.2602
<b>description</b>	pump inlet $\varnothing$ 63mm outlet $\varnothing$ 47mm type 1226.2602 230/400V 50Hz 3 phase 1,5kW 2HP L 333mm rotation direction left FIR		



1

<b>Part No.</b>	500533	<b>Ref. No.</b>	1226.2820
<b>description</b>	pump inlet $\varnothing$ 63mm outlet $\varnothing$ 47mm type 1226.2820 230/400V 50Hz 3 phase 1,5kW 2HP L 335mm rotation direction right FIR		

<b>spare parts for</b> 500533			
	<b>Part No.</b> 510693	<b>Ref. No.</b>	N/A
mechanical shaft seal for shaft $\varnothing$ 12 mm			
	<b>Part No.</b> 521215	<b>Ref. No.</b>	N/A
impellor $\varnothing$ 118 mm H 34 mm rotation direction right			
	<b>Part No.</b> 521513	<b>Ref. No.</b>	N/A
pump cover FIR inlet $\varnothing$ 63 mm outlet $\varnothing$ 47 mm			
	<b>Part No.</b> 524416	<b>Ref. No.</b>	N/A
pump cover gasket thickness 4x4mm Qty 1 pcs			



1

<b>Part No.</b>	501513	<b>Ref. No.</b>	1227.2711M10
<b>description</b>	pump inlet $\varnothing$ 63mm outlet $\varnothing$ 47mm type 1227.2711M10 230/400V 50Hz 3 phase 1,7kW L 340mm rotation direction right FIR		









<b>spare parts for</b> 501513			
	<b>Part No.</b> 510693	<b>Ref. No.</b>	N/A
mechanical shaft seal for shaft $\varnothing$ 12 mm			

Table continues overleaf

<b>spare parts for</b> 501513			
	Part No.	511667	Ref. No. —
fan wheel $\varnothing$ 123mm H 17mm shaft intake $\varnothing$ 15mm			
	Part No.	521513	Ref. No. N/A
pump cover FIR inlet $\varnothing$ 63 mm outlet $\varnothing$ 47 mm			
	Part No.	524416	Ref. No. N/A
pump cover gasket thickness 4x4mm Qty 1 pcs			
	Part No.	698772	Ref. No. N/A
impellor $\varnothing$ 113 mm H 34 mm M10L			



<b>1</b>			
<b>Part No.</b>	500323	<b>Ref. No.</b>	1227.2721
<b>description</b>	pump inlet $\varnothing$ 63mm outlet $\varnothing$ 47mm type 1227.2721 230/400V 50Hz 3 phase 2kW 2,7HP L 335mm rotation direction right FIR		
<b>spare parts for</b> 500323			
	Part No.	510599	Ref. No. N/A
impellor $\varnothing$ 123 mm H 34 mm M8L			
	Part No.	510693	Ref. No. N/A
mechanical shaft seal for shaft $\varnothing$ 12 mm			
	Part No.	521513	Ref. No. N/A
pump cover FIR inlet $\varnothing$ 63 mm outlet $\varnothing$ 47 mm			
	Part No.	524416	Ref. No. N/A
pump cover gasket thickness 4x4mm Qty 1 pcs			



<b>1</b>			
<b>Part No.</b>	500035	<b>Ref. No.</b>	1293.1402
<b>description</b>	pump inlet $\varnothing$ 63mm outlet $\varnothing$ 47mm type 1293.1402 230V 50Hz 1 phase 0,55kW 0,75HP L 295mm rotation direction right capacitor 12,5 $\mu$ F FIR inlet $\varnothing$ 63mm outlet $\varnothing$ 48mm		
<b>spare parts for</b> 500035			
	Part No.	365014	Ref. No. —
operating capacitor capacity 12,5 $\mu$ F 400V			
	Part No.	510601	Ref. No. N/A
impellor $\varnothing$ 103 mm H 25 mm rotation direction right			
	Part No.	510693	Ref. No. N/A
mechanical shaft seal for shaft $\varnothing$ 12 mm			
	Part No.	521513	Ref. No. N/A
pump cover FIR inlet $\varnothing$ 63 mm outlet $\varnothing$ 47 mm			
	Part No.	524416	Ref. No. N/A
pump cover gasket thickness 4x4mm Qty 1 pcs			







<b>1</b>			
<b>Part No.</b>	500325	<b>Ref. No.</b>	1293.1603
<b>description</b>	pump inlet $\varnothing$ 63mm outlet $\varnothing$ 47mm type 1293.1603 230V 50Hz 1 phase 0,55kW 0,75HP L 300mm rotation direction right capacitor 12,5 $\mu$ F FIR		
<b>spare parts for</b> 500325			
	Part No.	365014	Ref. No. —
operating capacitor capacity 12,5 $\mu$ F 400V			

Table continues overleaf







spare parts for 500325			
	Part No.	510601	Ref. No. N/A
	impellor ø 103 mm H 25 mm rotation direction right		
	Part No.	510693	Ref. No. N/A
	mechanical shaft seal for shaft ø 12 mm		
	Part No.	521513	Ref. No. N/A
	pump cover FIR inlet ø 63 mm outlet ø 47 mm		
	Part No.	524416	Ref. No. N/A
	pump cover gasket thickness 4x4mm Qty 1 pcs		

			
1			
<b>Part No.</b>	499228	<b>Ref. No.</b>	1293.2725
<b>description</b>	pump inlet ø 63mm outlet ø 47mm type 1293.2725 220-240/380-415V 50Hz 3 phase 0,55kW L 302mm rotation direction right FIR		

			
1			
<b>Part No.</b>	500034	<b>Ref. No.</b>	1293.3500
<b>description</b>	pump inlet ø 63mm outlet ø 47mm type 1293.3500 230/400V 50Hz 3 phase 0,55kW 0,75HP L 300mm rotation direction right FIR		
spare parts for 500034			
	Part No.	510601	Ref. No. N/A
	impellor ø 103 mm H 25 mm rotation direction right		
	Part No.	510693	Ref. No. N/A
	mechanical shaft seal for shaft ø 12 mm		

spare parts for 500034			
	Part No.	521513	Ref. No. N/A
	pump cover FIR inlet ø 63 mm outlet ø 47 mm		
	Part No.	524416	Ref. No. N/A
	pump cover gasket thickness 4x4mm Qty 1 pcs		

			
1			
<b>Part No.</b>	500257	<b>Ref. No.</b>	1295
<b>description</b>	pump inlet ø 63mm outlet ø 47mm type 1295 230/400V 50Hz 3 phase 0,88kW 1,2HP L 300mm rotation direction right FIR		
accessories for 500257			
	Part No.	521213	Ref. No. N/A
	impellor ø 117 mm H 24 mm M8L		









			
1			
<b>Part No.</b>	500330	<b>Ref. No.</b>	1295.1409
<b>description</b>	pump inlet ø 63mm outlet ø 47mm type 1295.1409 230V 50Hz 1 phase 0,88kW 1,2HP L 305mm rotation direction right capacitor 12,5µF FIR		
spare parts for 500330			
	Part No.	365014	Ref. No. —
	operating capacitor capacity 12,5µF 400V		
	Part No.	510693	Ref. No. N/A
	mechanical shaft seal for shaft ø 12 mm		

Table continues overleaf







<b>spare parts for</b> 500330			
	Part No.	521213	Ref. No. N/A
impellor ø 117 mm H 24 mm M8L			
	Part No.	521513	Ref. No. N/A
pump cover FIR inlet ø 63 mm outlet ø 47 mm			
	Part No.	524416	Ref. No. N/A
pump cover gasket thickness 4x4mm Qty 1 pcs			



<b>1</b>			
<b>Part No.</b>	500029	<b>Ref. No.</b>	1295.2502 1295.2503
<b>description</b>	pump inlet ø 63mm outlet ø 47mm type 1295.2503 230/400V 50Hz 3 phase 0,88kW 1,2HP L 305mm rotation direction right FIR		
<b>spare parts for</b> 500029			
	Part No.	510693	Ref. No. N/A
mechanical shaft seal for shaft ø 12 mm			
	Part No.	521213	Ref. No. N/A
impellor ø 117 mm H 24 mm M8L			
	Part No.	521513	Ref. No. N/A
pump cover FIR inlet ø 63 mm outlet ø 47 mm			
	Part No.	524416	Ref. No. N/A
pump cover gasket thickness 4x4mm Qty 1 pcs			



<b>1</b>			
<b>Part No.</b>	500706	<b>Ref. No.</b>	2237.2522
<b>description</b>	pump inlet ø 63mm outlet ø 47mm type 2237.2522 230/400V 50Hz 3 phase 2kW 2,7HP L 330mm rotation direction right FIR		
<b>spare parts for</b> 500706			
	Part No.	510599	Ref. No. N/A
impellor ø 123 mm H 34 mm M8L			
	Part No.	510693	Ref. No. N/A
mechanical shaft seal for shaft ø 12 mm			
	Part No.	521513	Ref. No. N/A
pump cover FIR inlet ø 63 mm outlet ø 47 mm			
	Part No.	524416	Ref. No. N/A
pump cover gasket thickness 4x4mm Qty 1 pcs			







<b>1</b>			
<b>Part No.</b>	500117	<b>Ref. No.</b>	1226 422522725
<b>description</b>	pump inlet ø 63mm outlet ø 47mm type 4225.22725 230/400V 50Hz 3 phase 1,4kW 2HP L 280mm rotation direction right FIR		
<b>spare parts for</b> 500117			
	Part No.	510602	Ref. No. 1225315/S
impellor ø 110 mm H 34 mm rotation direction right			





Table continues overleaf



spare parts for 500117			
	Part No.	510693	Ref. No. N/A
	mechanical shaft seal for shaft $\varnothing$ 12 mm		
	Part No.	521513	Ref. No. N/A
	pump cover FIR inlet $\varnothing$ 63 mm outlet $\varnothing$ 47 mm		
	Part No.	524416	Ref. No. N/A
	pump cover gasket thickness 4x4mm Qty 1 pcs		



1

Part No.	500570	Ref. No.	422512725
description	pump inlet $\varnothing$ 63mm outlet $\varnothing$ 47mm type 422512725 230/400V 50Hz 3 phase 1,1kW 1,5HP L 285mm rotation direction right FIR		
spare parts for 500570			
	Part No.	510693	Ref. No. N/A
	mechanical shaft seal for shaft $\varnothing$ 12 mm		
	Part No.	521082	Ref. No. N/A
	impellor $\varnothing$ 96 mm H 32 mm rotation direction right		
	Part No.	521513	Ref. No. N/A
	pump cover FIR inlet $\varnothing$ 63 mm outlet $\varnothing$ 47 mm		
	Part No.	524416	Ref. No. N/A
	pump cover gasket thickness 4x4mm Qty 1 pcs		







1

Part No.	499283	Ref. No.	422512760
description	pump inlet $\varnothing$ 63mm outlet $\varnothing$ 47mm type 422512760 230/400V 60Hz 3 phase 1,1kW L 290mm rotation direction right FIR		



1

Part No.	501540	Ref. No.	422522726
description	pump inlet $\varnothing$ 63mm outlet $\varnothing$ 47mm type 422522726 230/400V 50Hz 3 phase 1,4kW 2HP L 280mm rotation direction right FIR		
spare parts for 501540			
	Part No.	510602	Ref. No. 1225315/S
	impellor $\varnothing$ 110 mm H 34 mm rotation direction right		
	Part No.	510693	Ref. No. N/A
	mechanical shaft seal for shaft $\varnothing$ 12 mm		
	Part No.	521513	Ref. No. N/A
	pump cover FIR inlet $\varnothing$ 63 mm outlet $\varnothing$ 47 mm		
	Part No.	524416	Ref. No. N/A
	pump cover gasket thickness 4x4mm Qty 1 pcs		







1

<b>Part No.</b>	499280	<b>Ref. No.</b>	5295.5050
<b>description</b>	pump inlet $\varnothing$ 63mm outlet $\varnothing$ 47mm type 5295.5050 230/400V 50Hz 3 phase 1,5kW L 300mm rotation direction right FIR		
<b>spare parts for</b>	499280		
	<b>Part No.</b>	502277	<b>Ref. No.</b> N/A
	impellor $\varnothing$ 111 mm H 31 mm thread M8L		
	<b>Part No.</b>	510693	<b>Ref. No.</b> N/A
	mechanical shaft seal for shaft $\varnothing$ 12 mm		
	<b>Part No.</b>	521022	<b>Ref. No.</b> —
	fanwheel cover ID $\varnothing$ 137mm ED $\varnothing$ 142mm H 70mm		
	<b>Part No.</b>	524416	<b>Ref. No.</b> N/A
	pump cover gasket thickness 4x4mm Qty 1 pcs		
	<b>Part No.</b>	698773	<b>Ref. No.</b> N/A
	pump cover inlet $\varnothing$ 63 mm outlet $\varnothing$ 47 mm		







1

<b>Part No.</b>	501452	<b>Ref. No.</b>	1204
<b>description</b>	pump inlet $\varnothing$ 63mm outlet $\varnothing$ 53mm type 1204 220-240V 50Hz 1 phase 1,5kW 2HP L 34mm capacitor internal $\mu$ F FIR		
<b>spare parts for</b>	501452		
	<b>Part No.</b>	510531	<b>Ref. No.</b> N/A
	pump cover FIR inlet $\varnothing$ 63 mm outlet $\varnothing$ 53 mm		
	<b>Part No.</b>	510604	<b>Ref. No.</b> N/A
	impellor $\varnothing$ 118 mm H 34 mm M8R		
	<b>Part No.</b>	510693	<b>Ref. No.</b> N/A
	mechanical shaft seal for shaft $\varnothing$ 12 mm		

<b>spare parts for</b>	501452		
	<b>Part No.</b>	524416	<b>Ref. No.</b> N/A
	pump cover gasket thickness 4x4mm Qty 1 pcs		



1

<b>Part No.</b>	501457	<b>Ref. No.</b>	1204
<b>description</b>	pump inlet $\varnothing$ 63mm outlet $\varnothing$ 53mm type 1204 230/400V 50Hz 3 phase 1,5kW 2HP L 328mm rotation direction left FIR		
<b>spare parts for</b>	501457		
	<b>Part No.</b>	502013	<b>Ref. No.</b> N/A
	pump cover FIR inlet $\varnothing$ 63mm outlet $\varnothing$ 53mm		
	<b>Part No.</b>	510604	<b>Ref. No.</b> N/A
	impellor $\varnothing$ 118 mm H 34 mm M8R		
	<b>Part No.</b>	510693	<b>Ref. No.</b> N/A
	mechanical shaft seal for shaft $\varnothing$ 12 mm		
	<b>Part No.</b>	524416	<b>Ref. No.</b> N/A
	pump cover gasket thickness 4x4mm Qty 1 pcs		







1



<b>Part No.</b>	500018	<b>Ref. No.</b>	1204.2528
<b>description</b>	pump inlet $\varnothing$ 63mm outlet $\varnothing$ 53mm type 1204.2528 230/400V 50Hz 3 phase 1,5kW 2HP L 328mm rotation direction left FIR		
<b>spare parts for</b>	500018		
	Part No.	510523	Ref. No. —
	fan wheel $\varnothing$ 142mm shaft intake $\varnothing$ 15mm blades 12		
	Part No.	510531	Ref. No. N/A
	pump cover FIR inlet $\varnothing$ 63 mm outlet $\varnothing$ 53 mm		
	Part No.	510604	Ref. No. N/A
	impellor $\varnothing$ 118 mm H 34 mm M8R		
	Part No.	510693	Ref. No. N/A
	mechanical shaft seal for shaft $\varnothing$ 12 mm		
	Part No.	524416	Ref. No. N/A
	pump cover gasket thickness 4x4mm Qty 1 pcs		



1

<b>Part No.</b>	500258	<b>Ref. No.</b>	1204.2725
<b>description</b>	pump inlet $\varnothing$ 63mm outlet $\varnothing$ 53mm type 1204.2725 230/400V 50Hz 3 phase 1,5kW 2,01HP L 320mm rotation direction left FIR		
<b>spare parts for</b>	500258		
	Part No.	510531	Ref. No. N/A
	pump cover FIR inlet $\varnothing$ 63 mm outlet $\varnothing$ 53 mm		
	Part No.	510604	Ref. No. N/A
	impellor $\varnothing$ 118 mm H 34 mm M8R		

**spare parts for** 500258

	Part No.	510693	Ref. No.	N/A
	mechanical shaft seal for shaft $\varnothing$ 12 mm			
	Part No.	511667	Ref. No.	—
	fan wheel $\varnothing$ 123mm H 17mm shaft intake $\varnothing$ 15mm			
	Part No.	524416	Ref. No.	N/A
	pump cover gasket thickness 4x4mm Qty 1 pcs			



1

<b>Part No.</b>	499152	<b>Ref. No.</b>	1205.2502
<b>description</b>	pump inlet $\varnothing$ 63mm outlet $\varnothing$ 53mm type 1205.2502 230/400V 50Hz 3 phase 2kW 2,7HP L 328mm rotation direction left auxiliary pressure connection 10mm FIR		



1





<b>Part No.</b>	500031	<b>Ref. No.</b>	1205.2528
<b>description</b>	pump inlet $\varnothing$ 63mm outlet $\varnothing$ 53mm type 1205.2528 230/400V 50Hz 3 phase 2kW 2,7HP L 330mm rotation direction left FIR		
<b>spare parts for</b>	500031		
	Part No.	510357	Ref. No. N/A
	impellor $\varnothing$ 124 mm H 34/16mm thread M8R blades 6		
	Part No.	510523	Ref. No. —
	fan wheel $\varnothing$ 142mm shaft intake $\varnothing$ 15mm blades 12		
	Part No.	510531	Ref. No. N/A
	pump cover FIR inlet $\varnothing$ 63 mm outlet $\varnothing$ 53 mm		
	Part No.	510693	Ref. No. N/A
	mechanical shaft seal for shaft $\varnothing$ 12 mm		

Table continues overleaf



**spare parts for** 500031

	Part No.	524416	Ref. No.	N/A
pump cover gasket thickness 4x4mm Qty 1 pcs				







1

<b>Part No.</b>	499297	<b>Ref. No.</b>	1205.2820
<b>description</b>	pump inlet ø 63mm outlet ø 53mm type 1205.2820 230/400V 50Hz 3 phase 2,7HP L 330mm rotation direction left FIR		
<b>spare parts for</b>	499297		
	Part No.	510357	Ref. No. N/A
impellor ø 124 mm H 34/16mm thread M8R blades 6			
	Part No.	510523	Ref. No. —
fan wheel ø 142mm shaft intake ø 15mm blades 12			
	Part No.	510531	Ref. No. N/A
pump cover FIR inlet ø 63 mm outlet ø 53 mm			
	Part No.	510693	Ref. No. N/A
mechanical shaft seal for shaft ø 12 mm			
	Part No.	524416	Ref. No. N/A
pump cover gasket thickness 4x4mm Qty 1 pcs			



1

<b>Part No.</b>	500111	<b>Ref. No.</b>	1241.2500 1241.2530
<b>description</b>	pump inlet ø 63mm outlet ø 53mm type 1241.2500 230/400V 50Hz 3 phase 1,1kW 1,5HP L 330mm rotation direction left FIR		
<b>spare parts for</b>	500111		
	Part No.	510531	Ref. No. N/A
pump cover FIR inlet ø 63 mm outlet ø 53 mm			
	Part No.	510612	Ref. No. N/A
impellor ø 110 mm H 34 mm M8R			
	Part No.	510693	Ref. No. N/A
mechanical shaft seal for shaft ø 12 mm			
	Part No.	524416	Ref. No. N/A
pump cover gasket thickness 4x4mm Qty 1 pcs			







1

<b>Part No.</b>	499237	<b>Ref. No.</b>	1241.2503
<b>description</b>	pump inlet ø 63mm outlet ø 53mm type 1241.2503 230/400V 50Hz 3 phase 1,1kW 1,5HP L 330mm rotation direction left FIR		





1

<b>Part No.</b>	500271	<b>Ref. No.</b>	1241.2708
<b>description</b>	pump inlet $\varnothing$ 63mm outlet $\varnothing$ 53mm type 1241.2708 230/400V 50Hz 3 phase 1,12kW 1,52HP L 330mm rotation direction left FIR		
<b>spare parts for</b>	500271		
	Part No.	510531	Ref. No. N/A
	pump cover FIR inlet $\varnothing$ 63 mm outlet $\varnothing$ 53 mm		
	Part No.	510612	Ref. No. N/A
	impellor $\varnothing$ 110 mm H 34 mm M8R		
	Part No.	510693	Ref. No. N/A
	mechanical shaft seal for shaft $\varnothing$ 12 mm		
	Part No.	524416	Ref. No. N/A
	pump cover gasket thickness 4x4mm Qty 1 pcs		



1

<b>Part No.</b>	500277	<b>Ref. No.</b>	1241.2720
<b>description</b>	pump inlet $\varnothing$ 63mm outlet $\varnothing$ 53mm type 1241.2720 230/400V 50Hz 3 phase 1,1kW 1,5HP L 335mm rotation direction left FIR		
<b>spare parts for</b>	500277		
	Part No.	502013	Ref. No. N/A
	pump cover FIR inlet $\varnothing$ 63mm outlet $\varnothing$ 53mm		
	Part No.	510612	Ref. No. N/A
	impellor $\varnothing$ 110 mm H 34 mm M8R		
	Part No.	510693	Ref. No. N/A
	mechanical shaft seal for shaft $\varnothing$ 12 mm		

spare parts for 500277

	Part No.	524416	Ref. No.	N/A
	pump cover gasket thickness 4x4mm Qty 1 pcs			





1

<b>Part No.</b>	501463	<b>Ref. No.</b>	1241.2780
<b>description</b>	pump inlet $\varnothing$ 63mm outlet $\varnothing$ 53mm type 1241.2780 230/400V 50Hz 3 phase 1,1kW 1,5HP L 335mm rotation direction left FIR		
<b>spare parts for</b>	501463		
	Part No.	502013	Ref. No. N/A
	pump cover FIR inlet $\varnothing$ 63mm outlet $\varnothing$ 53mm		
	Part No.	510523	Ref. No. —
	fan wheel $\varnothing$ 142mm shaft intake $\varnothing$ 15mm blades 12		
	Part No.	510612	Ref. No. N/A
	impellor $\varnothing$ 110 mm H 34 mm M8R		
	Part No.	510693	Ref. No. N/A
	mechanical shaft seal for shaft $\varnothing$ 12 mm		
	Part No.	524416	Ref. No. N/A
	pump cover gasket thickness 4x4mm Qty 1 pcs		



1

<b>Part No.</b>	500119	<b>Ref. No.</b>	1241.4701
<b>description</b>	pump inlet ø 63mm outlet ø 53mm type 1241.4701 230V 50Hz 1 phase 1,1kW 1,5HP L 330mm rotation direction left capacitor 31,5µF FIR		
<b>spare parts for</b>	500119		
	<b>Part No.</b>	365016	<b>Ref. No.</b> —
	operating capacitor capacity 31,5µF 400V		
	<b>Part No.</b>	510531	<b>Ref. No.</b> N/A
	pump cover FIR inlet ø 63 mm outlet ø 53 mm		
	<b>Part No.</b>	510612	<b>Ref. No.</b> N/A
	impellor ø 110 mm H 34 mm M8R		
	<b>Part No.</b>	510693	<b>Ref. No.</b> N/A
	mechanical shaft seal for shaft ø 12 mm		
	<b>Part No.</b>	524416	<b>Ref. No.</b> N/A
	pump cover gasket thickness 4x4mm Qty 1 pcs		

<b>spare parts for</b>	501459		
	<b>Part No.</b>	510612	<b>Ref. No.</b> N/A
	impellor ø 110 mm H 34 mm M8R		
	<b>Part No.</b>	510693	<b>Ref. No.</b> N/A
	mechanical shaft seal for shaft ø 12 mm		
	<b>Part No.</b>	524416	<b>Ref. No.</b> N/A
	pump cover gasket thickness 4x4mm Qty 1 pcs		





1

<b>Part No.</b>	500705	<b>Ref. No.</b>	1243.2700
<b>description</b>	pump inlet ø 63mm outlet ø 53mm type 1243 230/400V 50Hz 3 phase 2,39kW 3,2HP L 363mm rotation direction left FIR		
<b>spare parts for</b>	500705		
	<b>Part No.</b>	510357	<b>Ref. No.</b> N/A
	impellor ø 124 mm H 34/16mm thread M8R blades 6		



1

<b>Part No.</b>	501459	<b>Ref. No.</b>	1241/1
<b>description</b>	pump inlet ø 63mm outlet ø 53mm type 1241/1 230/240V 50Hz 1 phase 1,1kW 1,5HP L 330mm rotation direction left capacitor 31,5µF FIR		
<b>spare parts for</b>	501459		
	<b>Part No.</b>	365016	<b>Ref. No.</b> —
	operating capacitor capacity 31,5µF 400V		
	<b>Part No.</b>	502013	<b>Ref. No.</b> N/A
	pump cover FIR inlet ø 63mm outlet ø 53mm		



1

<b>Part No.</b>	499197	<b>Ref. No.</b>	1243
<b>description</b>	pump inlet ø 63mm outlet ø 53mm type 1243 255/440V 60Hz 3 phase 3,2HP L 370mm rotation direction left FIR		





1

<b>Part No.</b>	500324	<b>Ref. No.</b>	1243.2520 1243.2591
<b>description</b>	pump inlet ø 63mm outlet ø 53mm type 1243.2591 230/400V 50Hz 3 phase 2,35kW 3,2HP L 365mm rotation direction left FIR		
<b>spare parts for</b>	500324		
	<b>Part No.</b>	510357	<b>Ref. No.</b> N/A
	impellor ø 124 mm H 34/16mm thread M8R blades 6		
	<b>Part No.</b>	510531	<b>Ref. No.</b> N/A
	pump cover FIR inlet ø 63 mm outlet ø 53 mm		
	<b>Part No.</b>	510693	<b>Ref. No.</b> N/A
	mechanical shaft seal for shaft ø 12 mm		
	<b>Part No.</b>	524416	<b>Ref. No.</b> N/A
	pump cover gasket thickness 4x4mm Qty 1 pcs		



1

<b>Part No.</b>	500952	<b>Ref. No.</b>	1244.2527
<b>description</b>	pump inlet ø 63mm outlet ø 53mm type 1244.2527 400V 50Hz 3 phase 2,5kW 3,5HP L 360mm rotation direction left FIR		
<b>spare parts for</b>	500952		
	<b>Part No.</b>	510357	<b>Ref. No.</b> N/A
	impellor ø 124 mm H 34/16mm thread M8R blades 6		
	<b>Part No.</b>	510531	<b>Ref. No.</b> N/A
	pump cover FIR inlet ø 63 mm outlet ø 53 mm		
	<b>Part No.</b>	510693	<b>Ref. No.</b> N/A
	mechanical shaft seal for shaft ø 12 mm		

**spare parts for** 500952

	<b>Part No.</b>	524416	<b>Ref. No.</b>	N/A
	pump cover gasket thickness 4x4mm Qty 1 pcs			









1

<b>Part No.</b>	501462	<b>Ref. No.</b>	2204/D
<b>description</b>	pump inlet ø 63mm outlet ø 53mm type 2204/D 230V 50Hz 1 phase 0,73kW 1HP L 260mm rotation direction left capacitor 20µF FIR		
<b>spare parts for</b>	501462		
	<b>Part No.</b>	365019	<b>Ref. No.</b> —
	operating capacitor capacity 20µF 400V		
	<b>Part No.</b>	502013	<b>Ref. No.</b> N/A
	pump cover FIR inlet ø 63mm outlet ø 53mm		
	<b>Part No.</b>	510693	<b>Ref. No.</b> N/A
	mechanical shaft seal for shaft ø 12 mm		
	<b>Part No.</b>	521219	<b>Ref. No.</b> N/A
	impellor ø 106 mm H 27 mm thread M8R shaft ø 28 mm		
	<b>Part No.</b>	524416	<b>Ref. No.</b> N/A
	pump cover gasket thickness 4x4mm Qty 1 pcs		





1

<b>Part No.</b>	500276	<b>Ref. No.</b>	2204D1520
<b>description</b>	pump inlet ø 63mm outlet ø 53mm type 2204D1520 230V 50Hz 1 phase 0,73kW 1HP L 260mm rotation direction left capacitor 20µFµF FIR		
<b>spare parts for</b>	500276		
	<b>Part No.</b>	365019	<b>Ref. No.</b> —
	operating capacitor capacity 20µF 400V		
	<b>Part No.</b>	502013	<b>Ref. No.</b> N/A
	pump cover FIR inlet ø 63mm outlet ø 53mm		
	<b>Part No.</b>	510693	<b>Ref. No.</b> N/A
	mechanical shaft seal for shaft ø 12 mm		
	<b>Part No.</b>	521219	<b>Ref. No.</b> N/A
	impellor ø 106 mm H 27 mm thread M8R shaft ø 28 mm		
	<b>Part No.</b>	524416	<b>Ref. No.</b> N/A
	pump cover gasket thickness 4x4mm Qty 1 pcs		
	<b>Part No.</b>	524845	<b>Ref. No.</b> —
	fan wheel ø 116mm shaft intake ø 9,7mm plastic		



1

<b>Part No.</b>	500058	<b>Ref. No.</b>	2241.2500
<b>description</b>	pump inlet ø 63mm outlet ø 53mm type 2241.2500 230/400V 50Hz 3 phase 0,89kW 1,2HP L 305mm rotation direction left FIR		
<b>spare parts for</b>	500058		
	<b>Part No.</b>	510531	<b>Ref. No.</b> N/A
	pump cover FIR inlet ø 63 mm outlet ø 53 mm		
	<b>Part No.</b>	510693	<b>Ref. No.</b> N/A
	mechanical shaft seal for shaft ø 12 mm		
	<b>Part No.</b>	510834	<b>Ref. No.</b> N/A
	impellor ø 110mm H 29mm thread M8R		
	<b>Part No.</b>	524416	<b>Ref. No.</b> N/A
	pump cover gasket thickness 4x4mm Qty 1 pcs		
<b>accessories for</b>	500058		
	<b>Part No.</b>	524046	<b>Ref. No.</b> —
	vibration damper L 40mm W 25mm H 25mm for pump		



1

<b>Part No.</b>	501467	<b>Ref. No.</b>	2241.2501
<b>description</b>	pump inlet ø 63mm outlet ø 53mm type 2241.2501 230/400V 50Hz 3 phase 0,89kW 1,5HP L 305mm rotation direction left FIR		



1

<b>Part No.</b>	499293	<b>Ref. No.</b>	2241.2703
<b>description</b>	pump inlet $\varnothing$ 63mm outlet $\varnothing$ 53mm type 2241.2703 230/400V 50Hz 3 phase 0,89kW 1,2HP L 300mm rotation direction left FIR		





1



<b>Part No.</b>	499193	<b>Ref. No.</b>	2241.5800
<b>description</b>	pump inlet $\varnothing$ 63mm outlet $\varnothing$ 53mm type 2241.5800 255/440V 60Hz 3 phase 1,1kW L 305mm rotation direction left FIR		



1

<b>Part No.</b>	499108	<b>Ref. No.</b>	4205.2701 4205.2702
<b>description</b>	pump inlet $\varnothing$ 63mm outlet $\varnothing$ 53mm type 4205.2702 230/400V 50Hz 3 phase 1,38kW 1,85HP L 330mm rotation direction left FIR		

<b>spare parts for</b>	499108		
	<b>Part No.</b>	502013	<b>Ref. No.</b> N/A
	pump cover FIR inlet $\varnothing$ 63mm outlet $\varnothing$ 53mm		
	<b>Part No.</b>	502122	<b>Ref. No.</b> N/A
	impellor $\varnothing$ 119 mm H 33 mm M8R		

<b>spare parts for</b>	499108		
	<b>Part No.</b>	510693	<b>Ref. No.</b> N/A
	mechanical shaft seal for shaft $\varnothing$ 12 mm		
	<b>Part No.</b>	524416	<b>Ref. No.</b> N/A
	pump cover gasket thickness 4x4mm Qty 1 pcs		



1

<b>Part No.</b>	499251	<b>Ref. No.</b>	5223.2350
<b>description</b>	pump inlet $\varnothing$ 63mm outlet $\varnothing$ 53mm type 5223.2350 230V 50Hz 1 phase 0,74kW L 314mm rotation direction left capacitor 16 $\mu$ F FIR		

<b>spare parts for</b>	499251		
	<b>Part No.</b>	365021	<b>Ref. No.</b> —
	operating capacitor capacity 16 $\mu$ F 425V		
	<b>Part No.</b>	502274	<b>Ref. No.</b> N/A
	pump cover FIR inlet $\varnothing$ 63 mm outlet $\varnothing$ 53 mm		
	<b>Part No.</b>	502275	<b>Ref. No.</b> N/A
	impellor $\varnothing$ 100 mm H 29 mm thread M8R blades 6		
	<b>Part No.</b>	510693	<b>Ref. No.</b> N/A
	mechanical shaft seal for shaft $\varnothing$ 12 mm		
	<b>Part No.</b>	521022	<b>Ref. No.</b> —
	fanwheel cover ID $\varnothing$ 137mm ED $\varnothing$ 142mm H 70mm		
	<b>Part No.</b>	524416	<b>Ref. No.</b> N/A
	pump cover gasket thickness 4x4mm Qty 1 pcs		



1

<b>Part No.</b>	499300	<b>Ref. No.</b>	5223.4050
<b>description</b>	pump inlet ø 63mm outlet ø 53mm type 5223.4050 230/400V 50Hz 3 phase 1,1kW L 316mm rotation direction left FIR		







1

<b>Part No.</b>	499113	<b>Ref. No.</b>	5234.4050
<b>description</b>	pump inlet ø 63mm outlet ø 53mm type 5234.4050 230/400V 50Hz 3 phase 1,62kW 2,2HP L 340mm rotation direction left FIR		



1

<b>Part No.</b>	499109	<b>Ref. No.</b>	5233.4051
<b>description</b>	pump inlet ø 63mm outlet ø 53mm type 5233.4051 220-240/380-415V 50Hz 3 phase 1,1kW 1,5HP L 345mm rotation direction left FIR		

<b>spare parts for</b>	499109		
	<b>Part No.</b>	502274	<b>Ref. No.</b> N/A
	pump cover FIR inlet ø 63 mm outlet ø 53 mm		
	<b>Part No.</b>	510612	<b>Ref. No.</b> N/A
	impellor ø 110 mm H 34 mm M8R		
	<b>Part No.</b>	510693	<b>Ref. No.</b> N/A
	mechanical shaft seal for shaft ø 12 mm		
	<b>Part No.</b>	524416	<b>Ref. No.</b> N/A
	pump cover gasket thickness 4x4mm Qty 1 pcs		



1

<b>Part No.</b>	499115	<b>Ref. No.</b>	5234.4052
<b>description</b>	pump inlet ø 63mm outlet ø 53mm type 5234.4052 230/400V 50Hz 3 phase 1,62kW L 340mm rotation direction left FIR		



1

<b>Part No.</b>	500741	<b>Ref. No.</b>	5234.4055
<b>description</b>	pump inlet ø 63mm outlet ø 53mm type 5234.4055 230/400V 50Hz 3 phase 1,5kW 2HP L 340mm rotation direction left FIR		





<b>spare parts for</b>	500741		
	<b>Part No.</b>	502274	<b>Ref. No.</b> N/A
	pump cover FIR inlet ø 63 mm outlet ø 53 mm		
	<b>Part No.</b>	510604	<b>Ref. No.</b> N/A
	impellor ø 118 mm H 34 mm M8R		

Table continues overleaf









spare parts for 500741			
	Part No.	510693	Ref. No. N/A
	mechanical shaft seal for shaft $\varnothing$ 12 mm		
	Part No.	524416	Ref. No. N/A
	pump cover gasket thickness 4x4mm Qty 1 pcs		







1

<b>Part No.</b>	500244	<b>Ref. No.</b>	1241.2725
<b>description</b>	pump inlet $\varnothing$ 63mm outlet $\varnothing$ 54mm type 1241.2725 230/400V 3 phase 1,1kW 1,5HP rotation direction left FIR		
spare parts for 500244			
	Part No.	510531	Ref. No. N/A
	pump cover FIR inlet $\varnothing$ 63 mm outlet $\varnothing$ 53 mm		
	Part No.	510612	Ref. No. N/A
	impellor $\varnothing$ 110 mm H 34 mm M8R		
	Part No.	510693	Ref. No. N/A
	mechanical shaft seal for shaft $\varnothing$ 12 mm		
	Part No.	524416	Ref. No. N/A
	pump cover gasket thickness 4x4mm Qty 1 pcs		



1

<b>Part No.</b>	500397	<b>Ref. No.</b>	2254.1000
<b>description</b>	pump inlet $\varnothing$ 70mm outlet $\varnothing$ 60mm type 2254.1000 230/400V 50Hz 3 phase 1,1kW 1,5HP L 320mm rotation direction right FIR		
spare parts for 500397			
	Part No.	510693	Ref. No. N/A
	mechanical shaft seal for shaft $\varnothing$ 12 mm		

spare parts for 500397			
	Part No.	521216	Ref. No. N/A
	impellor $\varnothing$ 100 mm H 31 mm M8L		
	Part No.	521515	Ref. No. N/A
	pump cover inlet $\varnothing$ 70 mm outlet $\varnothing$ 60 mm		
	Part No.	524416	Ref. No. N/A
	pump cover gasket thickness 4x4mm Qty 1 pcs		







1

<b>Part No.</b>	500115	<b>Ref. No.</b>	2254.2560 2254.2561
<b>description</b>	pump inlet $\varnothing$ 70mm outlet $\varnothing$ 60mm type 2254.2561 230/400V 50Hz 3 phase 1,5kW 2HP L 325mm rotation direction right FIR		
spare parts for 500115			
	Part No.	504313	Ref. No. —
	hose connector thread M12x1.75 grommet $\varnothing$ 11,3mm		
	Part No.	510693	Ref. No. N/A
	mechanical shaft seal for shaft $\varnothing$ 12 mm		
	Part No.	521014	Ref. No. N/A
	impellor $\varnothing$ 110 mm H 32 mm rotation direction right		
	Part No.	521515	Ref. No. N/A
	pump cover inlet $\varnothing$ 70 mm outlet $\varnothing$ 60 mm		
	Part No.	524416	Ref. No. N/A
	pump cover gasket thickness 4x4mm Qty 1 pcs		









1

<b>Part No.</b>	499264	<b>Ref. No.</b>	2254.2562
<b>description</b>	pump inlet ø 70mm outlet ø 60mm type 2254.2562 220-240/380-415V 50Hz 3 phase 1,5kW L 322mm rotation direction right FIR		
<b>spare parts for</b>	499264		
	<b>Part No.</b>	510694	<b>Ref. No.</b> —
	mechanical shaft seal for shaft ø 13 mm		
	<b>Part No.</b>	521014	<b>Ref. No.</b> N/A
	impellor ø 110 mm H 32 mm rotation direction right		
	<b>Part No.</b>	521515	<b>Ref. No.</b> N/A
	pump cover inlet ø 70 mm outlet ø 60 mm		
	<b>Part No.</b>	524416	<b>Ref. No.</b> N/A
	pump cover gasket thickness 4x4mm Qty 1 pcs		







1

<b>Part No.</b>	499265	<b>Ref. No.</b>	2254.5881
<b>description</b>	pump inlet ø 70mm outlet ø 60mm type 2254.5881 255/440V 60Hz 3 phase 1,5kW L 322mm rotation direction right FIR		
<b>spare parts for</b>	499265		
	<b>Part No.</b>	502276	<b>Ref. No.</b> N/A
	impellor ø 90 mm H 30 mm thread M8L		
	<b>Part No.</b>	504313	<b>Ref. No.</b> —
	hose connector thread M12x1.75 grommet ø 11,3mm		
	<b>Part No.</b>	510693	<b>Ref. No.</b> N/A
	mechanical shaft seal for shaft ø 12 mm		

<b>spare parts for</b>	499265		
	<b>Part No.</b>	521515	<b>Ref. No.</b> N/A
	pump cover inlet ø 70 mm outlet ø 60 mm		
	<b>Part No.</b>	524416	<b>Ref. No.</b> N/A
	pump cover gasket thickness 4x4mm Qty 1 pcs		









1

<b>Part No.</b>	500248	<b>Ref. No.</b>	4186.1500
<b>description</b>	pump outlet ø 27mm type 4186.1500 230V 50Hz 1 phase 0,25kW 0,33HP L 170mm rotation direction right capacitor 12,5µF FIR		
<b>spare parts for</b>	500248		
	<b>Part No.</b>	365014	<b>Ref. No.</b> —
	operating capacitor capacity 12,5µF 400V		
	<b>Part No.</b>	502012	<b>Ref. No.</b> N/A
	pump cover bottom part for wash pump		
	<b>Part No.</b>	502015	<b>Ref. No.</b> N/A
	impellor ø 86 mm H 22 mm shaft intake ø 9/8mm		
	<b>Part No.</b>	503147	<b>Ref. No.</b> —
	pump cover gasket thickness 3,53 mm ID ø 148,8 mm		
	<b>Part No.</b>	510695	<b>Ref. No.</b> N/A
	mechanical shaft seal height counter ring 5,5 mm		
<b>accessories for</b>	500248		
	<b>Part No.</b>	521730	<b>Ref. No.</b> N/A
	flange gasket EPDM thickness 5 mm ID ø 155 mm		



1

<b>Part No.</b>	501460	<b>Ref. No.</b>	4186.1500
<b>description</b>	pump outlet $\varnothing$ 27mm type 4186.1500 230V 50Hz 1 phase 0,25kW 0,33HP L 170mm rotation direction right capacitor 12,5 $\mu$ F FIR outlet $\varnothing$ 27mm		
<b>spare parts for</b>	501460		
	Part No.	502012	Ref. No. N/A
	pump cover bottom part for wash pump		
	Part No.	502015	Ref. No. N/A
	impellor $\varnothing$ 86 mm H 22 mm shaft intake $\varnothing$ 9/8mm		
	Part No.	503147	Ref. No. —
	pump cover gasket thickness 3,53 mm ID $\varnothing$ 148,8 mm		
	Part No.	510695	Ref. No. N/A
	mechanical shaft seal height counter ring 5,5 mm		
<b>accessories for</b>	501460		
	Part No.	365014	Ref. No. —
	operating capacitor capacity 12,5 $\mu$ F 400V		
	Part No.	521730	Ref. No. N/A
	flange gasket EPDM thickness 5 mm ID $\varnothing$ 155 mm		



1

<b>Part No.</b>	500012	<b>Ref. No.</b>	1243
<b>description</b>	pump type 1243 50Hz rotation direction left FIR		

	1		
<b>Part No.</b>	500259	<b>Ref. No.</b>	2212.1400
<b>description</b>	pump type 2212.1400 230V 50Hz 1 phase 0,075kW 0,1HP rotation direction right FIR		
<b>spare parts for</b>	500259		
	Part No.	365017	Ref. No. —
	operating capacitor capacity 5 $\mu$ F 450V		
	Part No.	510510	Ref. No. X2212-HP,0,10_(1)
	pump cover pump type 2212/2228/2229/2211		
	Part No.	510695	Ref. No. N/A
	mechanical shaft seal height counter ring 5,5 mm		
	Part No.	521203	Ref. No. N/A
	impellor $\varnothing$ 72 mm H 18 mm thread M7 shaft $\varnothing$ 11 mm		
	Part No.	521703	Ref. No. N/A
	pump cover gasket EPDM thickness 2,5 mm ID $\varnothing$ 75 mm		



1

<b>Part No.</b>	500326	<b>Ref. No.</b>	3911
<b>description</b>	pump type 3911 230V 50Hz 1 phase 0,55kW 0,75HP rotation direction right FIR		



1

<b>Part No.</b>	500026	<b>Ref. No.</b>	3942
<b>description</b>	pump type 3942 230V 50Hz 1 phase 0,55kW 0,75HP rotation direction right FIR		



1

<b>Part No.</b>	500698	<b>Ref. No.</b>	4273.2350
<b>description</b>	pump type 4273.2350 230V 50Hz 1 phase 0,55kW 0,75HP L 170mm rotation direction left capacitor 12,5µF FIR		
<b>spare parts for</b>	500698		
	<b>Part No.</b>	365014	<b>Ref. No.</b> —
	operating capacitor capacity 12,5µF 400V		
	<b>Part No.</b>	510695	<b>Ref. No.</b> N/A
	mechanical shaft seal height counter ring 5,5 mm		
	<b>Part No.</b>	512437	<b>Ref. No.</b> —
	impellor ø 85 mm H 27 mm rotation direction right		

spare parts and accessories

mechanical shaft seals



1

<b>Part No.</b>	510692	<b>Ref. No.</b>	N/A
<b>description</b>	mechanical shaft seal for shaft ø 11mm slide ringext. ø 24mm slide ring H 13mm counter ring mounting ø 26mm height counter ring 8mm counter ring int. ø 14mm		



1

<b>Part No.</b>	510693	<b>Ref. No.</b>	N/A
<b>description</b>	mechanical shaft seal for shaft ø 12mm slide ringext. ø 24mm slide ring H 15,5mm slide ring int. ø 11mm counter ring mounting ø 24mm height counter ring 8mm counter ring int. ø 14mm		



1

<b>Part No.</b>	510703	<b>Ref. No.</b>	N/A
<b>description</b>	mechanical shaft seal for shaft ø 13mm slide ring H 13mm height counter ring 5,5mm ED ø 26mm		



1

<b>Part No.</b>	510687	<b>Ref. No.</b>	N/A
<b>description</b>	mechanical shaft seal for shaft ø 18mm height counter ring 8mm ID ø 17mm ED ø 39mm H 15mm mounting ø 42mm int. ø 121mm		



1

<b>Part No.</b>	510690	<b>Ref. No.</b>	N/A
<b>description</b>	mechanical shaft seal for shaft ø 8mm ED ø 24mm mounting ø 24/26mm		



1

<b>Part No.</b>	510695	<b>Ref. No.</b>	N/A
<b>description</b>	mechanical shaft seal height counter ring 5,5mm ID ø 11mm		



1

<b>Part No.</b>	510702	<b>Ref. No.</b>	N/A
<b>description</b>	mechanical shaft seal height counter ring 5,5mm ID ø 12mm		



## impellers



1

<b>Part No.</b>	502275	<b>Ref. No.</b>	N/A
-----------------	--------	-----------------	-----

<b>description</b>	impellor ø 100mm H 29mm thread M8R blades 6		
--------------------	---	--	--



1

<b>Part No.</b>	501313	<b>Ref. No.</b>	N/A
-----------------	--------	-----------------	-----

<b>description</b>	impellor ø 103mm H 28mm shaft intake ø 9/8mm		
--------------------	--	--	--



1

<b>Part No.</b>	521216	<b>Ref. No.</b>	N/A
-----------------	--------	-----------------	-----

<b>description</b>	impellor ø 100mm H 31mm M8L		
--------------------	-----------------------------	--	--



1

<b>Part No.</b>	518067	<b>Ref. No.</b>	N/A
-----------------	--------	-----------------	-----

<b>description</b>	impellor ø 103mm H 29mm M7L		
--------------------	-----------------------------	--	--



1

<b>Part No.</b>	510600	<b>Ref. No.</b>	N/A
-----------------	--------	-----------------	-----

<b>description</b>	impellor ø 102mm H 29mm shaft intake ø 9/8mm rotation direction right blades 6		
--------------------	--	--	--



1

<b>Part No.</b>	510529	<b>Ref. No.</b>	N/A
-----------------	--------	-----------------	-----

<b>description</b>	impellor ø 103mm H 30mm shaft intake ø 9/8mm rotation direction right blades 6		
--------------------	--	--	--



1

<b>Part No.</b>	510601	<b>Ref. No.</b>	N/A
-----------------	--------	-----------------	-----

<b>description</b>	impellor ø 103mm H 25mm rotation direction right thread M8L seat ø 12,2mm blades 6		
--------------------	--	--	--



1

<b>Part No.</b>	509010	<b>Ref. No.</b>	N/A
-----------------	--------	-----------------	-----

<b>description</b>	impellor ø 105mm H 20mm M10L rotation direction right blades 4		
--------------------	--	--	--



1

<b>Part No.</b>	521273	<b>Ref. No.</b>	N/A
-----------------	--------	-----------------	-----

<b>description</b>	impellor ø 103mm H 27mm rotation direction left thread M7R shaft ø 12mm shaft length 10mm blades 6		
--------------------	--	--	--



1

<b>Part No.</b>	521219	<b>Ref. No.</b>	N/A
-----------------	--------	-----------------	-----

<b>description</b>	impellor ø 106mm H 27mm thread M8R shaft ø 28mm shaft length 10mm seat ø 12mm blades 6		
--------------------	--	--	--



1

<b>Part No.</b>	510834	<b>Ref. No.</b>	N/A
-----------------	--------	-----------------	-----

<b>description</b>	impellor ø 110mm H 29mm thread M8R suitable for FIR		
--------------------	---	--	--







			
1			
<b>Part No.</b>	521014	<b>Ref. No.</b>	N/A
<b>description</b>	impellor ø 110mm H 32mm rotation direction right thread M8L shaft ø 28mm shaft length 3mm seat ø 12,2mm blades 6		

			
1			
<b>Part No.</b>	510612	<b>Ref. No.</b>	N/A
<b>description</b>	impellor ø 110mm H 34mm M8R		

			
1			
<b>Part No.</b>	510602	<b>Ref. No.</b>	1225315/S
<b>description</b>	impellor ø 110mm H 34mm rotation direction right thread M8L shaft ø 28mm seat ø 12,2mm blades 6		

			
1			
<b>Part No.</b>	502277	<b>Ref. No.</b>	N/A
<b>description</b>	impellor ø 111mm H 31mm thread M8L		

			
1			
<b>Part No.</b>	698772	<b>Ref. No.</b>	N/A
<b>description</b>	impellor ø 113mm H 34mm M10L pump type 1227.2711M10 rotation direction right suitable for FIR blades 6		

			
1			
<b>Part No.</b>	521213	<b>Ref. No.</b>	N/A
<b>description</b>	impellor ø 117mm H 24mm M8L		

			
1			
<b>Part No.</b>	510604	<b>Ref. No.</b>	N/A
<b>description</b>	impellor ø 118mm H 34mm M8R rotation direction left		

			
1			
<b>Part No.</b>	521215	<b>Ref. No.</b>	N/A
<b>description</b>	impellor ø 118mm H 34mm rotation direction right thread M8L seat ø 12mm blades 6		

			
1			
<b>Part No.</b>	502122	<b>Ref. No.</b>	N/A
<b>description</b>	impellor ø 119mm H 33mm M8R		

			
1			
<b>Part No.</b>	521017	<b>Ref. No.</b>	N/A
<b>description</b>	impellor ø 120mm H 35mm rotation direction right thread M14L seat ø 18mm blades 6		

			
1			
<b>Part No.</b>	510599	<b>Ref. No.</b>	N/A
<b>description</b>	impellor ø 123mm H 34mm M8L		

			
1			
<b>Part No.</b>	510357	<b>Ref. No.</b>	N/A
<b>description</b>	impellor ø 124mm H 34/16mm thread M8R blades 6		





			
1			
<b>Part No.</b>	521277	<b>Ref. No.</b>	N/A
<b>description</b>	impellor ø 135mm H 39mm pump type Fir 2275; 3.6HP thread M14L		

			
1			
<b>Part No.</b>	521200	<b>Ref. No.</b>	N/A
<b>description</b>	impellor ø 63mm H 13mm shaft ø 11mm shaft length 32mm		

			
1			
<b>Part No.</b>	521279	<b>Ref. No.</b>	N/A
<b>description</b>	impellor ø 64mm H 17mm thread M5L blades 3 metal		

			
1			
<b>Part No.</b>	521266	<b>Ref. No.</b>	N/A
<b>description</b>	impellor ø 67mm H 18mm thread M7 shaft ø 11mm shaft length 32mm blades 3		

			
1			
<b>Part No.</b>	521202	<b>Ref. No.</b>	N/A
<b>description</b>	impellor ø 72mm H 17mm thread M5L		

			
1			
<b>Part No.</b>	521201	<b>Ref. No.</b>	N/A
<b>description</b>	impellor ø 72mm H 18mm thread M7 shaft ø 11mm shaft length 32mm blades 3		

			
1			
<b>Part No.</b>	521203	<b>Ref. No.</b>	N/A
<b>description</b>	impellor ø 72mm H 18mm thread M7 shaft ø 11mm shaft length 32mm blades 3		

			
1			
<b>Part No.</b>	510532	<b>Ref. No.</b>	X2228-HP0,20_(1)
<b>description</b>	impellor ø 72mm H 22mm pump type B229 thread M7 shaft ø 11mm shaft length 32mm blades 3		

			
1			
<b>Part No.</b>	501314	<b>Ref. No.</b>	N/A
<b>description</b>	impellor ø 75mm		

			
1			
<b>Part No.</b>	521566	<b>Ref. No.</b>	N/A
<b>description</b>	impellor ø 80mm H 15mm M7L pump type B226H		





 <p>1</p>			
<b>Part No.</b>	521207	<b>Ref. No.</b>	N/A
<b>description</b>	impellor ø 80mm H 18mm shaft intake ø 9x8mm rotation direction right suitable for HOONVED blades 5		

 <p>1</p>			
<b>Part No.</b>	502015	<b>Ref. No.</b>	N/A
<b>description</b>	impellor ø 86mm H 22mm shaft intake ø 9/8mm		

 <p>1</p>			
<b>Part No.</b>	501309	<b>Ref. No.</b>	N/A
<b>description</b>	impellor ø 80mm H 19mm M7R pump type type D1		

 <p>1</p>			
<b>Part No.</b>	502276	<b>Ref. No.</b>	N/A
<b>description</b>	impellor ø 90mm H 30mm thread M8L		

 <p>1</p>			
<b>Part No.</b>	510605	<b>Ref. No.</b>	N/A
<b>description</b>	impellor ø 80mm H 21mm M7L		

 <p>1</p>			
<b>Part No.</b>	521001	<b>Ref. No.</b>	N/A
<b>description</b>	impellor ø 91mm H 30mm pump type B267.4050 rotation direction right		

 <p>1</p>			
<b>Part No.</b>	510609	<b>Ref. No.</b>	N/A
<b>description</b>	impellor ø 84mm H 21mm M7L		

 <p>1</p>			
<b>Part No.</b>	521177	<b>Ref. No.</b>	N/A
<b>description</b>	impellor ø 93mm H 23mm thread M10L suitable for FIR		

 <p>1</p>			
<b>Part No.</b>	510607	<b>Ref. No.</b>	N/A
<b>description</b>	impellor ø 85mm H 29mm shaft intake ø 9x8mm rotation direction right blades 6		

 <p>1</p>			
<b>Part No.</b>	521061	<b>Ref. No.</b>	N/A
<b>description</b>	impellor ø 93mm H 27mm shaft intake ø 9x8mm rotation direction left blades 6		

 <p>1</p>			
<b>Part No.</b>	510608	<b>Ref. No.</b>	N/A
<b>description</b>	impellor ø 93mm H 32mm shaft intake ø 9/8mm blades 6 inner height 11mm		







			
1			
<b>Part No.</b>	510610	<b>Ref. No.</b>	N/A
<b>description</b>	impellor ø 95,5mm H 23mm shaft intake ø 9/8mm rotation direction right seat ø 16mm blades 6		

			
1			
<b>Part No.</b>	524358	<b>Ref. No.</b>	N/A
<b>description</b>	impellor ø 96mm H 23mm shaft intake ø M7Lmm rotation direction right suitable for MEIKO shaft ø 12mm shaft length 9mm blades 6		

			
1			
<b>Part No.</b>	521210	<b>Ref. No.</b>	N/A
<b>description</b>	impellor ø 96mm H 30mm shaft intake ø 9/8mm seat ø 16mm blades 6		

			
1			
<b>Part No.</b>	521082	<b>Ref. No.</b>	N/A
<b>description</b>	impellor ø 96mm H 32mm rotation direction right thread M8L		

			
1			
<b>Part No.</b>	521067	<b>Ref. No.</b>	N/A
<b>description</b>	service kit for pump type 2233S1500 impellor, pump cover gasket, mechanical shaft seal		
<b>spare parts for</b>	521067		
	<b>Part No.</b>	510552	<b>Ref. No.</b> N/A
	pump cover gasket		
	<b>Part No.</b>	510693	<b>Ref. No.</b> N/A
	mechanical shaft seal for shaft ø 12 mm		

<b>pump cover gaskets</b>			
			
1			
<b>Part No.</b>	521730	<b>Ref. No.</b>	N/A
<b>description</b>	flange gasket EPDM thickness 5mm ID ø 155mm Qty 1 pcs		

			
1			
<b>Part No.</b>	509002	<b>Ref. No.</b>	N/A
<b>description</b>	O-ring EPDM thickness 2,62mm ID ø 82,22mm Qty 1 pcs		

			
1			
<b>Part No.</b>	521718	<b>Ref. No.</b>	N/A
<b>description</b>	O-ring EPDM thickness 3,53mm ID ø 164,7mm Qty 1 pcs		

			
1			
<b>Part No.</b>	532718	<b>Ref. No.</b>	N/A
<b>description</b>	O-ring EPDM thickness 4mm ID ø 80mm Qty 1 pcs		

			
1			
<b>Part No.</b>	502007	<b>Ref. No.</b>	N/A
<b>description</b>	pump cover gasket		

			
1			
<b>Part No.</b>	521700	<b>Ref. No.</b>	N/A
<b>description</b>	pump cover gasket		



			
1			
<b>Part No.</b>	521701	<b>Ref. No.</b>	N/A
<b>description</b>	pump cover gasket		

			
1			
<b>Part No.</b>	521707	<b>Ref. No.</b>	N/A
<b>description</b>	pump cover gasket		

			
1			
<b>Part No.</b>	521703	<b>Ref. No.</b>	N/A
<b>description</b>	pump cover gasket EPDM thickness 2,5mm ID ø 75mm Qty 1 pcs		

			
1			
<b>Part No.</b>	510551	<b>Ref. No.</b>	N/A
<b>description</b>	pump cover gasket ID ø 158,3mm pump type 1214/1293/1225/2243/1226/1204/3473/1241 thickness 3,53mm EPDM Qty 1 pcs		

			
1			
<b>Part No.</b>	521026	<b>Ref. No.</b>	N/A
<b>description</b>	pump cover gasket ID ø 182,5mm thickness 5x4.5mm		

			
1			
<b>Part No.</b>	510552	<b>Ref. No.</b>	N/A
<b>description</b>	pump cover gasket pump type 1292-2/3942/3981/3911/3983		

image not available			
---------------------	--	--	--

<b>Part No.</b>	521565	<b>Ref. No.</b>	N/A
<b>description</b>	pump cover gasket pump type B226H		

			
1			
<b>Part No.</b>	521702	<b>Ref. No.</b>	N/A
<b>description</b>	pump cover gasket thickness 3.5x4.5mm Qty 1 pcs		

			
1			
<b>Part No.</b>	524416	<b>Ref. No.</b>	N/A
<b>description</b>	pump cover gasket thickness 4x4mm Qty 1 pcs		

pump covers

image not available			
---------------------	--	--	--

<b>Part No.</b>	521500	<b>Ref. No.</b>	N/A
<b>description</b>	pump cover		

			
1			
<b>Part No.</b>	521571	<b>Ref. No.</b>	2240303
<b>description</b>	pump cover FIR inlet ø 30mm outlet ø 30mm turn direction right ø 128mm ID ø 100mm inner hight 21mm		





			
1			
<b>Part No.</b>	521505	<b>Ref. No.</b>	X4247-HP.0,6_(1)
<b>description</b>	pump cover FIR inlet $\varnothing$ 37mm outlet $\varnothing$ 40mm turn direction right $\varnothing$ 160mm ID $\varnothing$ 125mm inner height 25mm		

			
1			
<b>Part No.</b>	502014	<b>Ref. No.</b>	N/A
<b>description</b>	pump cover FIR inlet $\varnothing$ 45mm outlet $\varnothing$ 40mm		

			
1			
<b>Part No.</b>	521539	<b>Ref. No.</b>	N/A
<b>description</b>	pump cover FIR inlet $\varnothing$ 45mm outlet $\varnothing$ 40mm auxiliary pressure connection 10mm supporting pressure open turn direction right $\varnothing$ 160mm ID $\varnothing$ 125mm inner height 25mm		

			
1			
<b>Part No.</b>	510508	<b>Ref. No.</b>	N/A
<b>description</b>	pump cover FIR inlet $\varnothing$ 45mm outlet $\varnothing$ 40mm pump type PU 0.5/3911 turn direction right $\varnothing$ 160mm ID $\varnothing$ 125mm inner height 25mm		

			
1			
<b>Part No.</b>	511187	<b>Ref. No.</b>	N/A
<b>description</b>	pump cover FIR inlet $\varnothing$ 45mm outlet $\varnothing$ 40mm turn direction right $\varnothing$ 160mm ID $\varnothing$ 122mm inner height 21mm		

			
1			
<b>Part No.</b>	521506	<b>Ref. No.</b>	N/A
<b>description</b>	pump cover FIR inlet $\varnothing$ 45mm outlet $\varnothing$ 40mm turn direction right $\varnothing$ 160mm ID $\varnothing$ 125mm inner height 25mm		

			
1			
<b>Part No.</b>	521567	<b>Ref. No.</b>	N/A
<b>description</b>	pump cover FIR inlet $\varnothing$ 50mm outlet $\varnothing$ 37mm $\varnothing$ 150mm ID $\varnothing$ 118mm inner height 25mm		

			
1			
<b>Part No.</b>	521512	<b>Ref. No.</b>	N/A
<b>description</b>	pump cover FIR inlet $\varnothing$ 60mm outlet $\varnothing$ 50mm		

			
1			
<b>Part No.</b>	698762	<b>Ref. No.</b>	N/A
<b>description</b>	pump cover FIR inlet $\varnothing$ 60mmmm outlet $\varnothing$ 50mmmm pump type 4298.1404 turn direction right $\varnothing$ 156,5mm		

			
1			
<b>Part No.</b>	521028	<b>Ref. No.</b>	N/A
<b>description</b>	pump cover FIR inlet $\varnothing$ 62mm outlet $\varnothing$ 62mm turn direction right $\varnothing$ 215mm ID $\varnothing$ 175mm inner height 40mm		



<p>1</p>			
<b>Part No.</b>	502273	<b>Ref. No.</b>	N/A
<b>description</b>	pump cover FIR inlet ø 63mm outlet ø 2x40mm pump type 4267.5050 turn direction right		

<p>1</p>			
<b>Part No.</b>	502013	<b>Ref. No.</b>	N/A
<b>description</b>	pump cover FIR inlet ø 63mm outlet ø 53mm supporting pressure 1/2" turn direction left ø 185mm ID ø 150mm inner high 37mm		

<p>1</p>			
<b>Part No.</b>	521513	<b>Ref. No.</b>	N/A
<b>description</b>	pump cover FIR inlet ø 63mm outlet ø 47mm turn direction right ID ø 150mm inner high 32mm		
<b>spare parts for</b>	521513		
	Part No.	504329	Ref. No. —
	blind plug H 17,5mm thread M16x1.5 plastic WS 22		

<p>1</p>			
<b>Part No.</b>	521545	<b>Ref. No.</b>	N/A
<b>description</b>	pump cover FIR type B226H inlet ø 33mm outlet ø 30/28mm		

<p>1</p>			
<b>Part No.</b>	502274	<b>Ref. No.</b>	N/A
<b>description</b>	pump cover FIR inlet ø 63mm outlet ø 53mm		



<p>1</p>			
<b>Part No.</b>	510384	<b>Ref. No.</b>	N/A
<b>description</b>	pump cover inlet ø 28mm outlet ø 26mm ø 100mm ID ø 76mm		

<p>1</p>			
<b>Part No.</b>	510531	<b>Ref. No.</b>	N/A
<b>description</b>	pump cover FIR inlet ø 63mm outlet ø 53mm auxiliary pressure connection M16x1.5mm supporting pressure open turn direction left ø 185mm ID ø 150mm inner high 37mm		
<b>spare parts for</b>	510531		
	Part No.	504329	Ref. No. —
	blind plug H 17,5mm thread M16x1.5 plastic WS 22		

<p>1</p>			
<b>Part No.</b>	502265	<b>Ref. No.</b>	5213EB2450
<b>description</b>	pump cover inlet ø 30mm outlet ø 26mm ID ø 89mm inner high 35mm		

<p>1</p>			
<b>Part No.</b>	521501	<b>Ref. No.</b>	N/A
<b>description</b>	pump cover inlet ø 30mm outlet ø 30mm pump type 4134		



			
1			
<b>Part No.</b>	521511	<b>Ref. No.</b>	N/A
<b>description</b>	pump cover inlet $\varnothing$ 60mm outlet $\varnothing$ 50/30mm supporting pressure M12x1.75 supporting pressure open pump type 2233 turn direction right $\varnothing$ 160mm ID $\varnothing$ 120mm inner height 23mm		
<b>accessories for</b>	521511		
	Part No.	517319	Ref. No. —
	hose connector T1: M12x1.75 hose $\varnothing$ 11mm brass		

			
1			
<b>Part No.</b>	521515	<b>Ref. No.</b>	N/A
<b>description</b>	pump cover inlet $\varnothing$ 70mm outlet $\varnothing$ 60mm		

			
1			
<b>Part No.</b>	698773	<b>Ref. No.</b>	N/A
<b>description</b>	pump cover inlet $\varnothing$ 63mm outlet $\varnothing$ 47mm turn direction right $\varnothing$ 194mm ID $\varnothing$ 158mm		

			
1			
<b>Part No.</b>	510510	<b>Ref. No.</b>	X2212-HP0,10_(1)
<b>description</b>	pump cover pump type 2212/2228/2229/2211		

			
1			
<b>Part No.</b>	521544	<b>Ref. No.</b>	N/A
<b>description</b>	pump cover inlet $\varnothing$ 63mm outlet $\varnothing$ 50mm turn direction right $\varnothing$ 180mm ID $\varnothing$ 165mm inner height 42mm		

			
1			
<b>Part No.</b>	502012	<b>Ref. No.</b>	N/A
<b>description</b>	pump cover bottom part for wash pump		



**GASTROPARTS.COM**



© 2020 Gastroparts Sp. J. All rights reserved.