



GASTROPARTS

Universal Catalogue › Mechanical Components ›

[EN] Fittings for catering equipment

[DE] Großkocharmaturen

[ES] Griferá para cocinas

[FR] Raccords pour la cuisine

[IT] Raccordi per cucine

[PL] Armatura

[RU] Арматура для промышленных кухонь

✉ gastroparts@gastroparts.com

☎ tel. +48 56 657 00 66

📘 fb.com/gastroparts.global

GASTROPARTS.COM



drain taps

ECHTERMANN

BG-certified, nickel silver

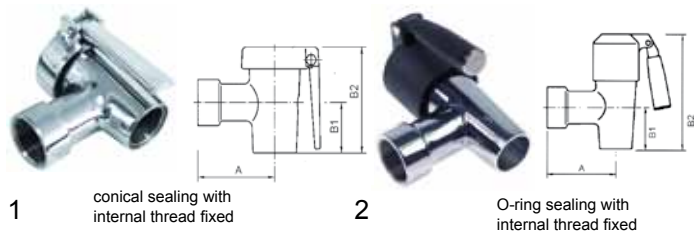

fig.	order no.	connection	A (mm)	B1 (mm)	B2 (mm)
1	540135	1"	80	42	102
1	540136	1 1/4"	90	47	112
1	540137	1 1/2"	100	52	125
1	540138	2"	120	65	148
2	541931	1 1/2"	100	65	185
2	541932	2"	120	70	202

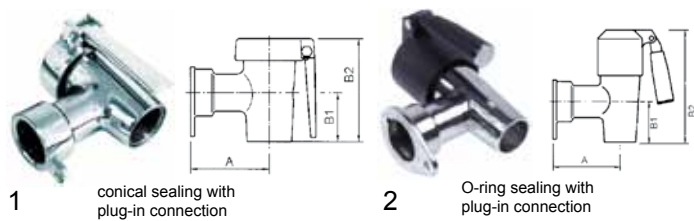

fig.	order no.	nominal size	pipe ø(mm)	A (mm)	B1 (mm)	B2 (mm)
1	540155	1 1/2"	47	100	52	125
1	540156	2"	59	120	65	148
2	541437	1 1/2"	47	100	65	185
2	541438	2"	59	120	70	202

spare parts and accessories

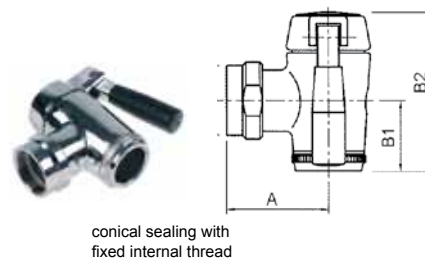

fig.	order no.	description	for drain tap
1	541531	repair kit with 4xO-ring + fitting grease	541437
1	541532	repair kit with 4xO-ring + fitting grease	541438
2	541933	plastic cap with handle	541931-932 541437-438
3	541934	rosette for 1" thread	540135
3	541935	rosette for 1 1/4" thread	540136
3	541936	rosette for 1 1/2" thread	540137 541931
3	541937	rosette for 2" thread	540138 541932



fig.	order no.	description	for drain tap
1	540083	pressure bolt	540135-138 540155-156
2	540081	handle 90mm	540135
2	540082	handle 110mm	540136-138 540155-156
3	540222	O-ring 2.62x47.30	540155
3	540119	O-ring 2.50x59.00	540156

ECO-STAR



no.	order no.	connection	A (mm)	B1 (mm)	B2 (mm)
1	541941	1 1/2"	80	55	124
2	541591	2"	110	68	145

FRIULI

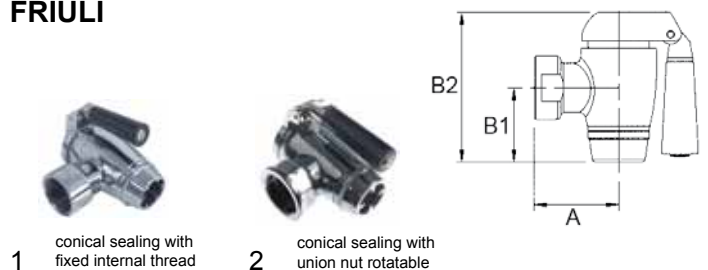

fig.	order no.	connection	A (mm)	B1 (mm)	B2 (mm)
1	541938	3/4"	65	42	98
1	540130	1"	62	51	95
1	540131	1 1/4"	95	75	140
1	540132	1 1/2"	95	75	140
1	540134	2"	115	85	165
2	541939	1 1/2"	95	75	140
2	540275	2"	88	85	150



fig.	order no.	connection	A (mm)	B1 (mm)	B2 (mm)
1	540925	1 1/2"	85	68	130
2	548001	1 1/2"	85	68	130
3	541630	2"	92	74	160

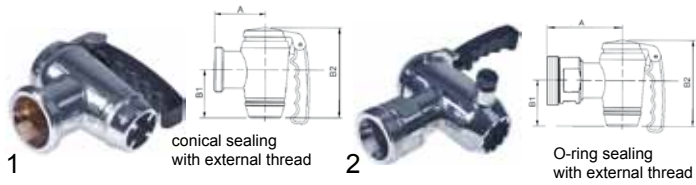

fig.	order no.	thread	pipe ø(mm)	A	(mm) B1	B2	suitable for:	ref. no.
1	540157	M78x3	50	88	83	155	Alpeninox Zanussi	0S0138 053159
2	540296	M60x2	37	105	70	130	Alpeninox Zanussi	0S0112 017215
2	540298	M68x3	40	105	70	130	Alpeninox Zanussi	0S0137 052907



fig.	order no.	description	A	B	C
1	541942	rosette 1"	33	72	8
1	541943	rosette 1¼"	44	80	10
1	541944	rosette 1½"	49	80	10
1	540958	rosette 2"	60	120	13
2	540956	fibre gasket 1½"			
2	540959	fibre gasket 2"			

spare parts and accessories



fig.	order no.	description	for drain tap
1	540212	handle for 1" drain tap	540130 541938
2	540213	handle for 1¼"/1½" drain tap	540131 540132 540925 548001 540296 540298 541939
2	540214	handle for 2" drain tap	540134 540275 541630 540157
3	540463	nut for 1" drain tap	540130
3	540464	nut for 1¼"/1½" drain tap	540131 540132
3	540465	nut for 2" drain tap	540134



fig.	order no.	description	for drain tap
1	540460	ring for 1" drain tap	540130
1	540461	ring for 1¼"/1½" drain tap	540131 540132
1	540462	ring for 2" drain tap	540134
2	505092	O-ring 5.34x43.82	540925 548001 540296 540298
2	505517	O-ring 5.34x53.65	541630



no.	order no.	description	length (mm)
1	541945	screw-in socket 1"	80
2	541946	screw-in socket 1¼"	80
3	541947	screw-in socket 1½"	80
4	541948	screw-in socket 2"	80

lubricants

fitting grease (KTW approved)



fig.	order no.	description	bundle
1	890087	silicone grease	collapsible tube 25g
1	890101	silicone grease	collapsible tube 75g
2	890237	fitting grease	collapsible tube 20g



fig.	order no.	description	bundle
1	890119	fitting grease	collapsible tube 25g
2	890118	fitting grease	can 1000g
3	890116	fitting grease	collapsible tube 60g

drain taps



1 with union nut

2

fig.	order no.	connection	A (mm)	B (mm)
1	540685	3/4"	46	40
2	541540	3/4"	38	40



1

2

fig.	order no.	connection	A (mm)	B (mm)
1	540747	1/2"	30	40
1	540699	3/4"	38	38
2	540260	1"	43	40



1 drain tap with handle and pipe connection

2 drain tap without handle and pipe connection

fig.	order no.	connection	A (mm)	suitable for
1	514207	3/4"	84	Bertos
2	540763	3/4"	84	MBM Olis
2	540776	3/4"	84	Modular

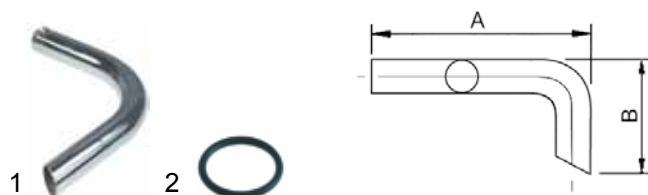

1

2

fig.	order no.	pipe ø	A (mm)	B (mm)
1	540651	22	130	150
1	540734	22	145	50
1	514006	22	190	100
2	532453	O-ring EPDM ø2.62x21.89		



1

2

3

4

fig.	order no.	description	for drain tap
1	691355	thread bolt M6	540763
2	112934	plastic handle M6	
3	110734	lever	540776
4	514217	lever	

drain taps various



1

2

3

4

5

fig.	order no.	description	suitable for	ref. no.
1	540730	drain tap 3/4"	Angelo Po	33D0170
2	540681	drain pipe 97mm	Angelo Po	36D4070
3	540684	drainage elbow	Angelo Po	33Q5020
4	540683	hole cover	Angelo Po	36D4080
5	540682	O-ring	Angelo Po	3150840



1

2

3

fig.	order no.	description	suitable for	ref. no.
1	540689	drain tap 3/4"	Angelo Po	33D1770
2	541530	drain pipe	Angelo Po	3AZ0090
3	532487	O-ring	Angelo Po	3150690



1

2

3

fig.	order no.	description	suitable for	ref. no.
1	540759	drain tap 1"	Angelo Po	33D1760
2	514153	drain pipe	Angelo Po	3AZ0100
3	504561	O-ring	Angelo Po	3151080



1

2

fig.	order no.	description	suitable for	ref. no.
1	540658	drain tap 3/4"	Bertos	32686300
2	514280	extension	Bertos	32696300



1

2

fig.	order no.	description	suitable for	ref. no.
1	540751	drain tap 1"	Elframo	13110001
2	540752	extension 165mm	Elframo	00030450
2	540753	extension 400mm	Elframo	00030470



fig.	order no.	description	suitable for	ref. no.
1	540910	drain tap 3/4"	Forved	3118

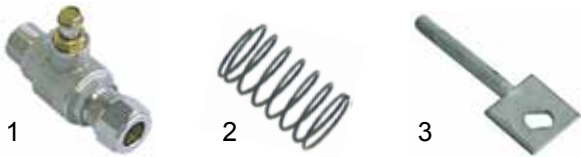

fig.	order no.	description	suitable for	ref. no.
1	540733	drain tap 1/2"	Gico	433206
2	540736	spring for lever handle	Gico	260201950
3	540735	lever	Gico	160103020



fig.	order no.	description	suitable for	ref. no.
1	514130	ball for lever	Gico	333302006
2	540746	adaptor for drain pipe	Gico	760103840
3	540734	drain pipe	Gico	760302430
4	532453	O-ring EPDM ø2.62x21.89	Gico	



fig.	order no.	description	suitable for	ref. no.
1	514212	drain tap 3/4"	Giga	0000X15300
2	514233	drain tap 3/4"	Giga	0000X15200
3	540651	drain pipe	Giga	
4	514410	lever	Giga	T30200
5	514411	handle for lever	Giga	M22200



fig.	order no.	description	suitable for	ref. no.
1	540750	drain tap 3/4"	Lotus	531001000
2	540259	drain tap 3/4"	Lotus	531000100
3	540748	lever 70mm	Lotus	533027200
4	691355	lever 64mm	Lotus	533009600



fig.	order no.	description	suitable for	ref. no.
1	112934	plastic handle	Lotus	536000300
2	514006	drain pipe	Lotus	544120300
3	106597	union screw 3/4"	Lotus	533010100
4	106598	cutting ring	Lotus	533010200



fig.	order no.	description	suitable for	ref. no.
1	540776	drain tap 3/4"	Mareno	1040424
2	691356	shaft extension	Mareno	1033720900
3	691334	lever right	Mareno	1044235100
4	514015	lever handle	Mareno	1036702000



fig.	order no.	description	suitable for	ref. no.
1	514006	drain pipe	Mareno	1033300300
2	106597	union screw 3/4"	Mareno	866000
3	106598	cutting ring	Mareno	866200



fig.	order no.	description	suitable for	ref. no.
1	514005	drain tap 3/4"	Mareno	1031024110
2	691356	shaft extension	Mareno	1033720900
3	691333	lever left	Mareno	1044235200
4	514015	lever handle	Mareno	1036702000



fig.	order no.	description	suitable for	ref. no.
1	514325	drain tap 1" (83mm)	Mareno	1950700
2	514220	drain pipe	Mareno	012000
3	514219	drain pipe	Mareno	1577500



fig.	order no.	description	suitable for	ref. no.
1	540658	drain tap ¾"	Mareno	1450500
2	514050	lever 210mm	Mareno	1515500
2	514054	lever 245mm	Mareno	1959600
3	514051	plastic handle	Mareno	32000599



fig.	order no.	description	suitable for	ref. no.
1	540977	drain tap ¾"	Zanussi	056114
2	540927	drain tap 1"	Zanussi	056885

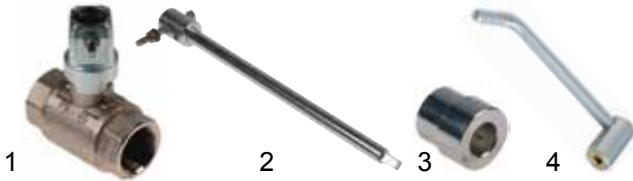

fig.	order no.	description	suitable for	ref. no.
1	514097	drain tap 1"	Mareno	CR0412260
2	514098	lever 220mm	Mareno	CM149101
3	514099	centering bush	Mareno	1515900
4	514059	lever handle	Mareno	CM155200



fig.	order no.	description	suitable for	ref. no.
1	540929	lever handle shaft 8x8	Zanussi	056887
2	540928	handle rod 8x8, 190mm	Zanussi	056985
3	514176	handle rod 165mm	Zanussi	
4	540979	handle rod 200mm	Zanussi	003377
4	514069	handle rod 335mm	Zanussi	002881
4	514070	handle rod 525mm	Zanussi	005770
4	514072	handle rod 530mm	Zanussi	002880
4	514068	handle rod 640mm	Zanussi	002883
5	540978	support plate	Zanussi	003378



fig.	order no.	description	suitable for	ref. no.
1	540776	drain tap ¾"	Mareno	1040424
2	514006	drain pipe	Mareno	1033300300
3	514074	drain tap ½"-¾"	MBM	160214



fig.	order no.	description	suitable for	ref. no.
1	514067	handle rod 575mm	Zanussi	056567
2	514324	lever rod M6, 81mm	Zanussi	055352
3	514322	handle M6	Zanussi	029898



fig.	Bestell no.	description	suitable for	ref. no.
1	520378	drain tap ¾"-½"	MKN	201092
2	520376	drain pipe ½"	MKN	205252



fig.	order no.	description	suitable for	ref. no.
1	514109	handle rod	Zanussi	003830
2	111666	star handle 7x7	Zanussi	010142
3	540978	support plate	Zanussi	003378



fig.	order no.	description	suitable for	ref. no.
1	540759	drain tap 1"	Olis	A023020
2	541529	drain pipe	Olis	9000619
3	540761	drain pipe	Olis	8217500
4	504561	O-ring	Olis	8217550



fig.	order no.	connection	suitable for	ref. no.
1	540964	drain tap ½"	Zanussi	058647
2	540975	drain tap ½"	Zanussi	058610
3	540976	drain pipe 80mm	Zanussi	004505
4	540965	drain pipe	Zanussi	002457

inlet taps



fig.	order no.	description	suitable for	ref. no.
1	514048	inlet tap 1/2" complete	Lotus	531018500
2	540871	handle with rosette	Lotus	



fig.	order no.	description	suitable for	ref. no.
1	514049	inlet tap 3/4" complete	Lotus	531020800



fig.	order no.	description	suitable for	ref. no.
1	540700	inlet tap 1/2"	Emmepi Giorik	808037 7060018
2	540701	handle	Emmepi Giorik	808432 2001250



fig.	order no.	description	suitable for	ref. no.
1	514266	inlet tap 3/8"	MBM Baron	168006 41826900960
2	514385	ball tap 3/8"	Angelo Po	3005990 33D3200



fig.	order no.	description	suitable for	ref. no.
1	514271	inlet tap 1/2" left	Baron	41853321537
1	514267	inlet tap 1/2" right	Baron	41826900070
2	514083	rosette 27x19	Baron	
3	514084	fastening nut 27x19	Baron	



fig.	order no.	description	suitable for	ref. no.
1	540930	inlet tap 1/2" left	Mareno	CM127800
1	540971	inlet tap 1/2" right	Mareno	
2	514083	rosette 27x19	Mareno	
3	514084	fastening nut 27x19	Mareno	



no.	order no.	description	suitable for	ref. no.
1	540773	inlet tap 1/2" left	Zanussi	003517 026537
2	540771	inlet tap 1/2" right	Zanussi	003516 025733



fig.	order no.	description	suitable for	ref. no.
1	540415	handle blue	Zanussi	
2	540414	handle red	Zanussi	
3	514083	rosette 27x19	Zanussi	
4	514084	fastening nut 27x19	Zanussi	



fig.	order no.	description	suitable for	ref. no.
1	540942	inlet tap ½" left, blue	Ambach	5018007357
2	540943	inlet tap ½" left, red	Ambach	5018003416 5018013782



fig.	order no.	description	suitable for	ref. no.
1	540924	tap head ½"	Ambach	5018007381
2	540951	handle	Ambach	5022913784
3	540944	rosette 26x19	Ambach	5022213783
4	540945	disc, blue	Ambach	5031400110
5	540946	disc, red	Ambach	5031400109
6	540947	cap cover	Ambach	5025000108
7	540948	screw M5x10	Ambach	5040913785



fig.	order no.	description	suitable for	ref. no.
1	514370	inlet tap ½"	Giga Star10	X18000 X18000
2	540415	handle, blue		
3	540414	handle, red		
4	514085	rosette 26x19		
5	514086	fastening nut 26x19		



fig.	order no.	description	suitable for	ref. no.
1	693107	inlet tap ½" blue	Lotus Fagor Firex Offcar	30200008 S112151000 30200008 FX30200008
2	514082	inlet tap ½" red		



fig.	order no.	description	suitable for	ref. no.
1	548169	handle, blue		
2	548168	handle, red		
3	514085	rosette 26x19		
4	514086	fastening nut 26x19		



fig.	order no.	description	suitable for	ref. no.
1	540656	inlet tap ½"	Silko	0102613 0100540
2	514085	rosette 26x19		
3	514086	fastening nut 26x19		



fig.	order no.	description	suitable for	ref. no.
1	540737	inlet tap ½"	Gico	790304640
2	540738	handle	Gico	790305070
3	514085	rosette 26x19		
4	514086	fastening nut 26x19		



fig.	order no.	description	suitable for	ref. no.
1	540941	inlet tap ½", blue	Ambach	5018007357
2	514091	inlet tap ½", red	Ambach	5018003416 5018013782



fig.	order no.	description	suitable for	ref. no.
1	540924	tap head 1/2"	Ambach	5018007381
2	540951	handle	Ambach	5022913784
3	540944	rosette 26x19	Ambach	5022213783
4	540945	disc, blue	Ambach	5031400110
5	540946	disc, red	Ambach	5031400109
6	540947	cap cover	Ambach	5025000108
7	540948	screw M5x10	Ambach	5040913785



fig.	order no.	description	suitable for	ref. no.
1	514102	inlet tap 3/4", blue	universal	
2	514103	inlet tap 3/4", red	universal	
3	514106	tap head 3/4", blue	universal	
4	514107	tap head 3/4", red	universal	



fig.	order no.	description	suitable for	ref. no.
1	514095	inlet tap 1/2" blue/red	universal	
2	547954	tap head 1/2"	universal	
3	547953	tap head, blue/red	universal	
4	547430	handle blue/red	universal	



fig.	order no.	description	suitable for	ref. no.
1	540891	inlet tap 1/2"-15mm red	universal	
2	540892	inlet tap 1/2"-15mm blue	universal	
3	540898	tap head 1/2", red	universal	
4	540899	tap head 1/2", blue	universal	



fig.	order no.	description	suitable for	ref. no.
1	514096	inlet tap 3/4" blue/red	universal	
2	547951	tap head 3/4"	universal	
3	547950	tap head, blue/red	universal	
4	547430	handle blue/red	universal	



fig.	order no.	description	suitable for	ref. no.
1	540894	inlet tap 3/4"-18mm red	universal	
2	540893	inlet tap 3/4"-18mm blue	universal	
3	540901	tap head red 3/4"	universal	
4	540900	tap head blue 3/4"	universal	



fig.	order no.	description	suitable for	ref. no.
1	514100	inlet tap 1/2", blue	universal	
2	514101	inlet tap 1/2", red	universal	
3	514104	tap head 1/2", blue	universal	
4	514105	tap head 1/2", red	universal	



fig.	order no.	description	suitable for	ref. no.
1	514269	inlet tap 1/2"-spout 100mm	Baron	826900260
1	540799	inlet tap 1/2"-spout 130mm	Zanussi	2322
2	548176	tap head 1/2"		
3	548171	handle blue		



fig.	order no.	description	suitable for	ref. no.
1	547503	inlet tap 1/2"	universal	
2	547707	tap head 1/2"	universal	
3	547713	handle blue	universal	
4	547712	handle red	universal	



fig.	order no.	description	suitable for	ref. no.
1	514052	inlet tap 1/2"-12mm	Mareno	1475300 700700
2	514244	tap head 1/2"	Mareno	955600
3	693081	handle blue	Mareno	832400



no.	order no.	description	suitable for	ref. no.
1	540660	inlet tap 12mm	Nayati	GS2305



fig.	order no.	description	suitable for	ref. no.
1	541429	inlet tap 1/2" blue/red	universal	
2	547952	inlet tap 3/4" blue/red	universal	



fig.	order no.	description	suitable for	ref. no.
1	547950	tap head 3/4" complete	universal	
2	547951	tap head 3/4"	universal	
3	547430	handle blue/red	universal	



fig.	order no.	description	suitable for	ref. no.
1	540690	inlet tap 3/8"	Angelo Po	33D0590
2	541813	handle blue	Angelo Po	36M2632
3	514383	handle red	Angelo Po	36M2641



fig.	order no.	description	suitable for	ref. no.
1	541817	inlet tap 1/2"	Angelo Po	33D2040
2	514090	handle blue/red	Angelo Po	36M4010 36M4030
3	541818	rosette 28x19	Angelo Po	



fig.	order no.	description	suitable for	ref. no.
1	540868	inlet tap with ceramic tap head	MBM	RTCP800018
2	514084	fastening nut 27x19		



fig.	order no.	description	suitable for	ref. no.
1	514355	mixer tap	Küppersbusch Thielmann	540830 144132
2	540312	tap head 3/4"		
3	547427	handle red/blue		



fig.	order no.	description	suitable for	ref. no.
1	540914	mixer tap	Juno	232270 232271

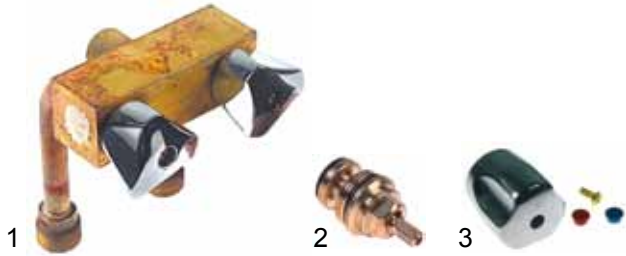

fig.	order no.	description	suitable for	ref. no.
1	540896	mixer tap	Küppersbusch Ascoblock	151603 8151603
2	540312	tap head 3/4"		
3	547427	handle red/blue		



fig.	order no.	description	suitable for	ref. no.
1	540895	mixer tap	Küppersbusch	151602 150300
2	540312	tap head 3/4"		
3	547427	handle red/blue		



no.	order no.	description	suitable for	ref. no.
1	540709	mixer tap	Mareno Mareno Gico	450100 422106 450114



fig.	order no.	description	suitable for	ref. no.
1	514336	mixer tap with flange (no spout and hoses)	Icos	110000
2	514395	mixer tap with spout and hoses	universal	



fig.	order no.	description	suitable for	ref. no.
1	514396	outlet/drain/spout	universal	
2	548180	tap head 3/4"	universal	
3	540415	handle blue	universal	
4	540414	handle red	universal	

inlet spouts

turnable spouts



fig.	order no.	T	ø(mm)	A(mm)	B1(mm)	B2(mm)	rotation angle	suitable for
1	542005	1/2"	18	105	130	70	360°	universal
1	540950	1/2"	18	105	130	70	90°	universal
1	540360	1/2"	18	105	165	110	360°	universal
1	540669	1/2"	20	105	140	55	90°	universal
1	540361	3/4"	18	110	165	110	360°	universal
1	540362	3/4"	18	110	210	150	90°	universal
2	514214	1/2"	20	90	175	135	360°	Giga



fig.	order no.	T	ø(mm)	A(mm)	B1(mm)	B2(mm)	rotation angle	suitable for
1	547900	1/2"	18	155	115	150	360°	universal
1	547901	1/2"	18	200	240	170	360°	universal
1	547902	1/2"	18	250	290	220	360°	universal
2	547903	1/2"	18	200	215	150	360°	universal
2	547904	1/2"	18	250	240	175	360°	universal
2	547905	1/2"	18	300	270	205	360°	universal



no.	order no.	T	ø(mm)	A(mm)	B1(mm)	B2(mm)	rotation angle	suitable for
1	547906	1/2"	18	200	240	175	360°	universal
2	547907	1/2"	18	250	260	195	360°	universal
3	547908	1/2"	18	300	290	225	360°	universal



fig.	order no.	T	ø(mm)	A(mm)	B1(mm)	B2(mm)	rotation angle	suitable for
1	514330	3/4"	17	180	165	40	60°	universal
2	540887	3/4"	20	100	110	40	90°	Küppersbusch Ascoblock



fig.	order no.	T	ø(mm)	A(mm)	B1(mm)	B2(mm)	rotation angle	suitable for
1	514332	3/4"	25	200	200	25	360°	Küppersbusch Thielmann
2	540890	3/4"	25	200	245	70	360°	Küppersbusch



fig.	order no.	T	ø(mm)	A(mm)	B1(mm)	B2(mm)	rotation angle	suitable for
1	514406	1/2"	18	105	115	60	90°	Olis
2	540787	1/2"	20	120	165	100	90°	Baron

fixed spouts



fig.	order no.	T	ø(mm)	A(mm)	B1(mm)	B2(mm)	suitable for
1	540940	1/2"	18	95	135	90	Ambach
2	542006	1/2" / 3/8"	16	80	90	40	MBM



fig.	order no.	T	ø(mm)	A(mm)	B1(mm)	B2(mm)	suitable for
1	514401	M16x1.5	10	48	35	15	Mareno
2	514078	3/8"	10	48	46	25	Angelo Po
3	514408	3/8"	12	50	48	25	Olis



fig.	order no.	T	A(mm)	B(mm)	rotation angle	suitable for
1	540705	1/2"	120	55	360°	Emmepi universal
2	540990	1/2"	50	50	fixed	Zanussi
3	540992	1/2" inside	23	23	fixed	Zanussi

inlet heads

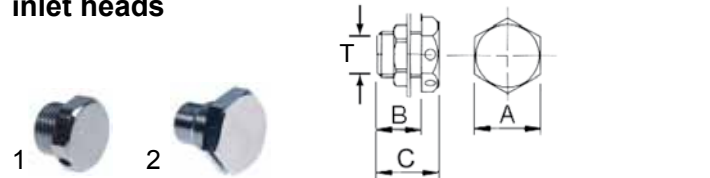

fig.	order no.	T	A(mm)	B(mm)	C(mm)	suitable for
1	693483	1/2"	27	12	20	Emainox
1	693728	1/2"	30	20	28	Nayati
2	691390	3/8" / 1/2"	30	22	29	Baron

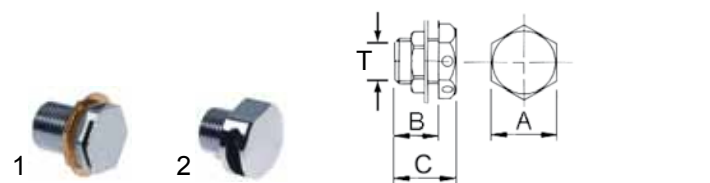

fig.	order no.	T	A(mm)	B(mm)	C(mm)	suitable for
1	691605	1/2"	27	26	32	Lohberger
2	691606	1/2"	34	15	29	universal
2	691607	1/2"	34	20	34	MKN

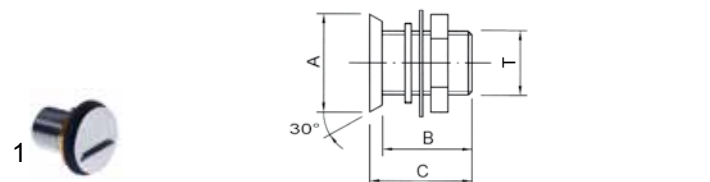

fig.	order no.	T	A(mm)	B(mm)	C(mm)	suitable for
1	691604	1/2"	32	29	33	universal

accessories

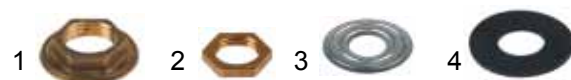

fig.	order no.	description	size	fig.	order no.	description	size
1	511469	nut	3/8"	3	511473	flat washer	3/8"
1	511470	nut	1/2"	3	511474	flat washer	1/2"
1	511471	nut	3/4"	3	511475	flat washer	3/4"
2	511472	nut	3/8"	4	511476	gasket	3/8"
2	361184	nut	1/2"	4	511477	gasket	1/2"
2	520234	nut	3/4"	4	511478	gasket	3/4"

steam taps

Echtermann

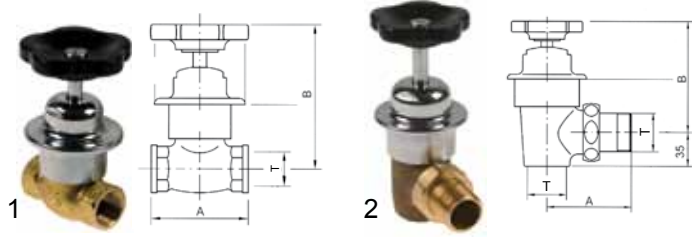

fig.	order no.	T	A(mm)	B(mm)
1	541541	3/4"	75	118
1	541542	1"	90	140
1	541543	1 1/4"	110	148
2	541544	1"	82	136
2	541545	1 1/4"	95	138

spare parts



fig.	order no.	description	for steam tap
1	541556	tap head 1"	3/4"
1	541557	tap head 1 1/4"	1"
1	541558	tap head 1 1/2"	1 1/4"
2	541559	handle - ø80(8x8)	3/4"
2	540229	handle - ø80(9x9)	1"/1 1/4"



fig.	order no.	description	for steam tap
1	541550	fiber gasket 1"	3/4"
1	541551	fiber gasket 1 1/4"	1"
1	541552	fiber gasket 1 1/2"	1 1/4"
2	541553	copper gasket 1"	3/4"
2	541554	copper gasket 1 1/4"	1"
2	541555	copper gasket 1 1/2"	1 1/4"
3	541547	teflon gasket	3/4"
3	541548	teflon gasket	1"
3	541549	teflon gasket	1 1/4"
4	541561	shaft gasket	3/4"
4	541562	shaft gasket	1"/1 1/4"
5	541546	screw	

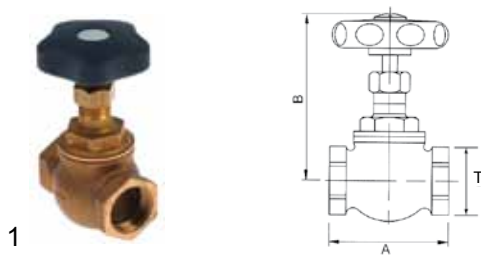

no.	order no.	T	A(mm)	B(mm)
1	541454	1"	80	115
2	541599	1 1/4"	95	135



fig.	order no.	T	A(mm)	B(mm)
1	520000	1 1/4"	52	190
2	541455	1"	40	150



fig.	order no.	description	fig.	order no.	description
1	541565	tap head 1"	3	541563	handle 1" ø72/7x7
1	541566	tap head 1 1/4"	3	541567	handle 1 1/4" ø72/9x9
2	541564	teflon gasket 1"			

anti-vacuum valves



fig.	order no.	T	A(mm)	fig.	order no.	T	A(mm)
1	540013	3/8"	78	2	540015	3/8"	90
1	540014	1/2"	78	2	540016	1/2"	90

O-ring sealing



fig.	order no.	T	A(mm)	B(mm)	fig.	order no.	T	A(mm)	B(mm)
1	540010	3/8"	22	22	2	540012	3/4"	30	25
2	540949	1/2"	22	15					

metallic sealing



fig.	order no.	T	A(mm)	B(mm)	fig.	order no.	T	A(mm)	B(mm)
1	540824	1/4"	19	29	3	540011	1/2"	22	51
1	540826	1/2"	24	42	4	540827	3/4"	--	61
2	540825	3/8"	24	45					

metallic sealing (special edition)



fig.	order no.	T	A(mm)	B(mm)	suitable for
1	541428	3/4"	30	25	MKN
2	541430	1/2"	22	27	MKN

test taps

male connection



fig.	order no.	T	A(mm)	B(mm)	suitable for
1	540818	1/2"	87	40	universal
2	540632	1/2"	50	35	Angelo Po

female connection

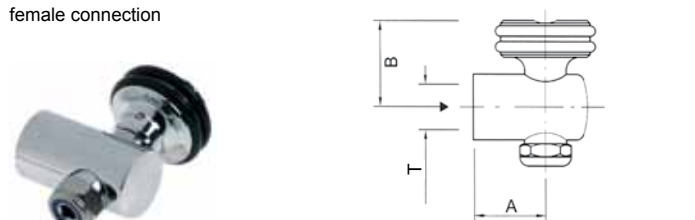

fig.	order no.	T	A(mm)	B(mm)	suitable for
1	540080	3/8"	27.5	33	universal



fig.	order no.	T	A(mm)	B(mm)	suitable for
1	540206	3/8"	75	20	universal
2	514277	3/8"	69	26	universal

with funnel

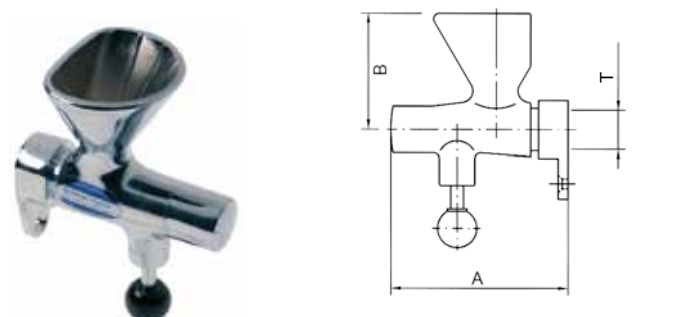

fig.	order no.	T	A(mm)	B(mm)	suitable for
1	540079	1/2"	94	60	universal

safety fittings

Echtermann



fig.	order no.	blow-off pressure(bar)	connection	manometer thread
1	514111	0.4	1"	1/4" / 1/2"
1	514110	0.5	1"	1/4" / 1/2"
2	514327	0.4	1"	1/4" / 1/2"
2	514274	0.5	1"	1/4" / 1/2"



no.	order no.	blow-off pressure(bar)	connection	manometer thread
1	514113	0.4	1"	1/4" / 1/2"
2	514114	0.5	1"	1/4" / 1/2"



fig.	order no.	blow-off pressure(bar)	connection	manometer thread
1	514112	0.4	1"	1/4" / 1/2"
1	540920	0.5	1"	1/4" / 1/2"
2	514328	0.4	1"	1/4" / 1/2"

spare parts



fig.	order no.	description	thread
1	540011	anti-vacuum valves	1/2"
2	540949	anti-vacuum valves	1/2"



fig.	order no.	description	thread
1	540926	filling pot	3/8"
2	540322	ball handle	M6
2	540075	ball handle	M5



fig.	order no.	blow-off pressure(bar)	connection
1	514276	0.45	3/4"
2	514123	0.45	3/4"
3	514124	0.45	3/4"

Rubinerie del Friuli



fig.	order no.	blow-off pressure(bar)	connection
1	514382	0.5	3/4"
2	540744	0.5	1 1/4"



fig.	order no.	blow-off pressure(bar)	connection
1	514381	0.5	1 1/4"



fig.	order no.	blow-off pressure(bar)	connection
1	514275	0.45	3/4"
2	514404	0.45	3/4"

spare parts



fig.	order no.	description	thread
1	540822	fitting holder	3/4"
2	540816	fitting holder	1 1/4"



fig.	order no.	description	thread
1	540820	fitting holder	1 1/4"
2	540821	fitting holder	1 1/4"

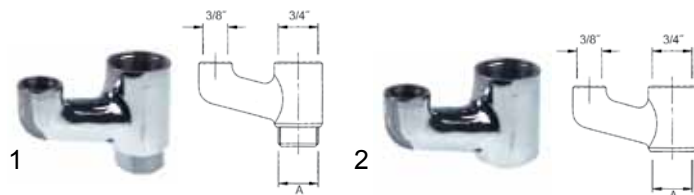

fig.	order no.	description	A	fig.	order no.	description	A
1	540832	Y-piece	3/8"	1	540860	Y-piece	3/4"
1	540817	Y-piece	1/2"	2	540633	Y-piece	1/2"

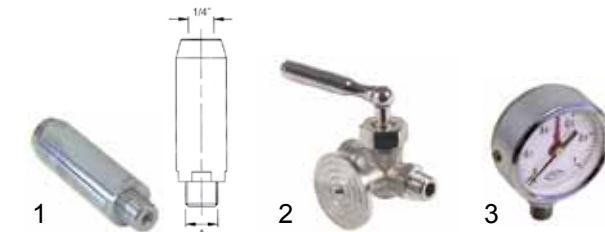

fig.	order no.	description	A
1	540828	manometer syphon	3/8"
1	540829	manometer syphon	1/2"
2	540830	manometer tap	1/4"
3	541062	manometer tap	1/4"



fig.	order no.	description	thread
1	540833	screw cap	3/8"
1	540834	screw cap	1/2"
1	540835	screw cap	3/4"
2	514094	angle	3/8"



fig.	order no.	description	thread
1	540824	anti-vacuum valves	1/4"
1	540826	anti-vacuum valves	1/2"
2	540825	anti-vacuum valves	3/8"
3	540827	anti-vacuum valves	3/4"



no.	order no.	description	thread
1	514122*	safety valve 0.5bar	3/4"
2	540823	safety valve 0.5bar	3/4"
3	514121*	safety valve 0.5bar	1 1/4"
4	540721	safety valve 0.5bar	1 1/4"

*with CE-approval



no.	order no.	description	thread
1	540836	filling pot with ball valve	1/2"
2	541501	reducer	3/4" ET / 1 1/4" inside

built in safety fittings Echtermann



1 with filling connection 1/8"

2 without filling connection

fig.	order no.	blow-off pressure (bar)	thread	fig.	order no.	blow-off pressure (bar)	thread
1	514115	0.4	3/4"	2	514117	0.4	3/4"
1	514116	0.5	3/4"	2	540921	0.5	3/4"

safety fittings with lid Echtermann



fig.	order no.	set pressure (bar)	thread
1	514118	0.4	1 1/2"
2	540882	0.5	1 1/2"



fig.	order no.	set pressure(bar)	thread
1	514119	0.4	1 1/4"

Rubinetterie del Friuli



fig.	order no.	description	suitable for
1	540722	lid safety valve with output	universal
2	510406	gasket	universal
3	514415	lid safety valve without output	Firex
4	541597	lid safety valve with output	Fagor

safety valves

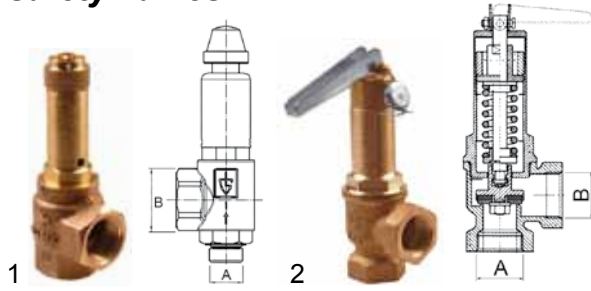

fig.	order no.	set pressure	A(mm)	B(mm)	product
1	514273	0.65bar	½"	½"	Herose
1	514353	0.60bar	¾"	¾"	Herose
1	101977	0.65bar	¾"	¾"	Herose
1	514354	0.50bar	1"	1"	Herose
2	540909	0.50bar	½"	½"	Paracchini

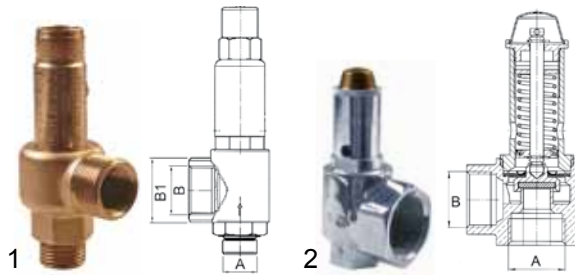
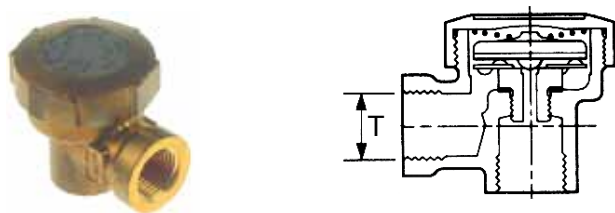

fig.	order no.	set pressure	A(mm)	B(mm)	B1(mm)	product
1	540708	0.50bar	½"	½"	¾"	GI
2	540880	0.50bar	½"	1"		Götze
2	540923	0.50bar	½"	1"		Götze
2	541357	1.25bar	½"	1"		Götze



fig.	order no.	set pressure	A(mm)	B(mm)	product
1	541431	1.0bar	½"	1"	SYR
1	540915	1.1bar	½"	1"	SYR
2	540881	0.65bar	¾"	1"	SYR
2	514071	1.1bar	¾"	1"	SYR
2	541458	1.3bar	¾"	1"	SYR

steam traps



no.	order no.	T	type
1	540784	½"	BPT13A(E)
2	540779*	½"	BPT13AX(E)
3	540994	¾"	BPT13A(E)

*with conical protective strainer

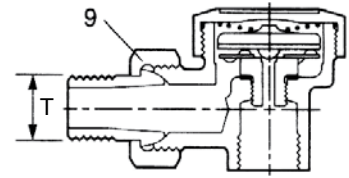

no.	order no.	T	type
1	540243	½"	BPT13UA(E)
2	540244	¾"	BPT13UA(E)

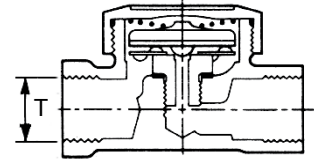

no.	order no.	T	type
1	541461	½"	BPT13S(E)
2	541571	¾"	BPT13S(E)

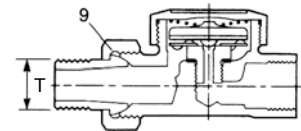

no.	order no.	T	type
1	541572	½"	BPT13US(E)
2	541573	¾"	BPT13US(E)



no.	order no.	T	type
1	540223	½"	TSS21



no.	order no.	T	type
1	541356	½"	ST 1730

spare parts



no.	order no.	size	type
1	540219	1/2"-3/4"	BPT13(E)



no.	order no.	size	type
1	541574*	1/2"-3/4"	BPT13...X(E)

*with conical protective strainer

automatic steam trap

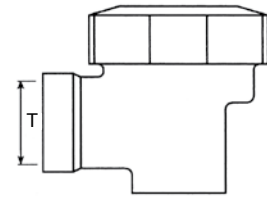

fig.	order no.	T	type
1	514272	1/2"	AV13

lid hinges

Echtermann

key

Echtermann part no. **6910.01/45-3-80**

serial number

serial number subassembly
(fixing)

level of centre of rotation (H)

lifting capacity range
(stamped on every hinge)

read angle

lifting capacity range

series 6910 series 6912 series 6914	1	to approx. 10 Nm	6	approx. 50 Nm - 60 Nm
	2	approx. 10 Nm - 20 Nm	7	approx. 70 Nm - 100 Nm
	3	approx. 20 Nm - 30 Nm	8	approx. 40 Nm - 60 Nm
	5	approx. 30 Nm - 50 Nm		
	series 6911	1	approx. 100 Nm - 140 Nm	3
2		approx. 140 Nm - 200 Nm		

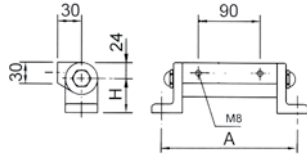

no.	order no.	Echtermann part no.	A (mm)	suitable for	reference no.
1	540876	6910.84/45-2-75	198	Küppersbusch	131627
2	700196	6910.84/45-5-75	198	Küppersbusch	134372
3	700198	6910.84/45-6-75	198	Küppersbusch	134373
4	690848	6910.88/45-7-80	220	Küppersbusch	154400

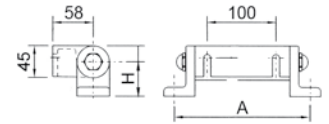

no.	order no.	Echtermann part no.	A (mm)	suitable for	reference no.
1	691203	6910.81/45-6-75	198	Therma Electrolux	716045136 OK5247
2	691204	6910.82/35-7-75	220	Therma Electrolux	716045137 0H9913
3	693214	6910.82/35-7-87	220	Küppersbusch	134357

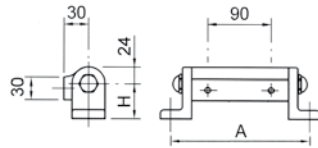

no.	order no.	Echtermann part no.	A (mm)	suitable for	reference no.
1	693505	6912.84/35-2-80	198	MKN	207160
2	693506	6912.84/35-3-80	198	MKN	207180
3	693507	6912.84/35-5-80	198	MKN	207174
4	693508	6912.84/35-6-80	198	MKN	207015
5	693447	6912.84/35-5-80	198	Küppersbusch Thielmann	144138

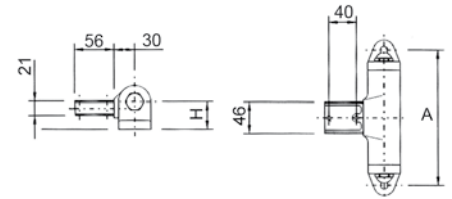

for square pipes
50x25x2mm

no.	order no.	Echtermann part no.	A (mm)	suitable for	reference no.
1	693241	6910.61/35-3-60	198	Juno Electrolux	275792 275793 OK2589
2	693242	6910.61/35-5-60	198	Juno Electrolux	275793 OK2589
3	693246	6910.61/35-6-60	198	Juno Electrolux	275796 OK2591

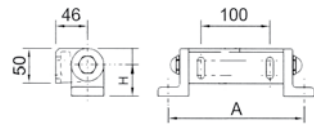

no.	order no.	Echtermann part no.	A (mm)	suitable for	reference no.
1	693448	6910.80/45-6-80	198	Küppersbusch Thielmann	144466



for square pipes
60x30x2mm

no.	order no.	Echtermann part no.	A (mm)	suitable for	reference no.
1	693240	6910.62/45-1-75	198	Juno Electrolux	275787 OK2586
2	693234	6910.62/45-2-75	198	Juno Electrolux	275788 OK2587
3	693235	6910.62/45-3-75	198	Juno Electrolux	275789 0H6887
4	693237	6910.62/45-5-75	198	Juno Electrolux	275791 OK2588
5	693245	6910.62/45-6-75	198	Juno Electrolux	275800 OK2593

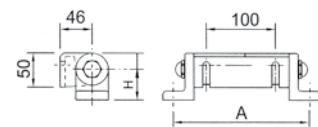

no.	order no.	Echtermann part no.	A (mm)	suitable for	reference no.
1	693236	6910.86/40-3-75	198	Juno Electrolux	275785 OK2585
2	693238	6910.86/65-3-75	198	Juno Electrolux	275801 OK2594
3	693239	6910.86/65-3-75	198	Juno Electrolux	275802 OK2595

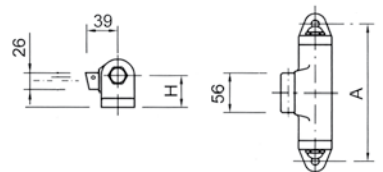

no.	order no.	Echtermann part no.	A (mm)	suitable for	reference no.
1	693449	6912.63/40-3-80	198	Küppersbusch Thielmann	144701
2	693450	6912.63/40-5-80	198	Küppersbusch Thielmann	144122

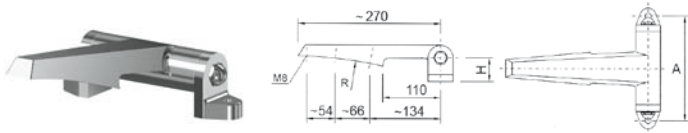

no.	order no.	Echtermann part no.	R (mm)	A (mm)	suitable for	reference no.
1	693502	6910.71/32-2-80	585	198	MKN	207175
2	693503	6910.72/35-2-80	800	198	MKN	207170
3	693504	6910.73/35-3-80	1200	198	MKN	207171

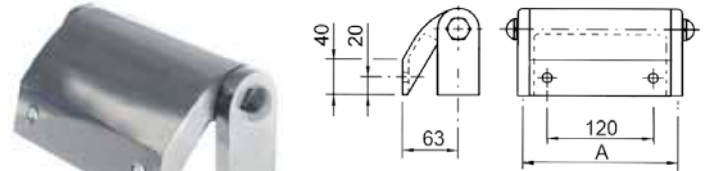

no.	order no.	Echtermann part no.	A (mm)	suitable for	reference no.
1	693212	6910.91/75-3-87	175	Küppersbusch	131624



no.	order no.	Echtermann part no.	A (mm)	suitable for	reference no.
1	690850	6911.81/116-2-90	220	Küppersbusch	154401
2	690851	6911.81/116-3-90	220	Küppersbusch	133701 133761
3	690849	6911.81/116-4-90	220	Küppersbusch	131620



no.	order no.	Echtermann part no.	A (mm)	B (mm)	suitable for	reference no.
1	700199	6910.11/72-6-80	198	490	Küppersbusch	134360



no.	order no.	Echtermann part no.	A (mm)	suitable for	reference no.
1	693216	6911.80/66-2-90	340	Küppersbusch	131930
2	693217	6911.80/66-3-90	340	Küppersbusch	131931

spare parts

for series 6910/6912



no.	order no.	lifting capacity range	no.	order no.	lifting capacity range
1	691610	1	4	691613	5
2	691611	2	5	691614	6
3	691612	3			

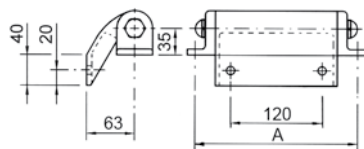

no.	order no.	Echtermann part no.	A (mm)	suitable for	reference no.
1	693213	6910.89/35-3-87	214	Küppersbusch	131608
2	693215	6910.89/35-7-87	214	Küppersbusch	131609

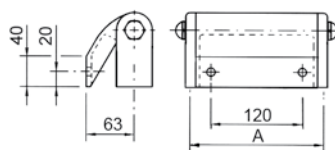

no.	order no.	Echtermann part no.	A (mm)	suitable for	reference no.
1	693211	6910.92/35-7-87		Küppersbusch	131619

fig.	order no.	lifting capacity range
1	691615	7

Rubinerie del Friuli

lid hinges for circular lids

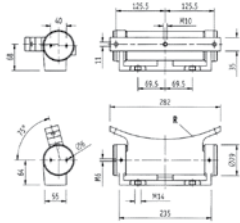

no.	order no.	description	R (mm)
1	540837	lid hinge, spring thickness 4 mm	320
2	540838	lid hinge, spring thickness 4 mm	395
3	540953	lid hinge, spring thickness 6 mm	395
4	540839	lid hinge, spring thickness 5 mm	470
5	540840	lid hinge, spring thickness 6 mm	500
6	540841	lid hinge, spring thickness 6 mm	545

spare parts



fig.	order no.	description	R (mm)
1	514138	hinge body	320
1	514139	hinge body	395
1	514140	hinge body	470
1	514141	hinge body	500
1	514142	hinge body	545
2	514144	holder	

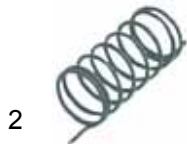
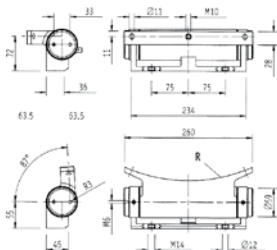

fig.	order no.	description	fig.	order no.	description
1	514145	setting bush	2	540855	spring left 5 mm
2	540852	spring right 4 mm	2	540856	spring right 6 mm
2	540853	spring left 4 mm	2	540857	spring left 6 mm
2	540854	spring right 5 mm			



no.	order no.	description	R (mm)
1	540720	lid hinge, spring thickness 4 mm	320

spare parts



fig.	order no.	description	R (mm)
1	514143	hinge body	320
2	514146	holder	

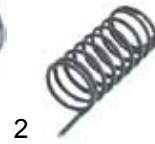
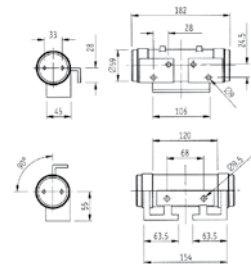

fig.	order no.	description	fig.	order no.	spring thickness
1	514150	setting bush	2	540846	spring left 4mm
2	540847	spring right 4mm			

lid hinges for square and rectangular lids



no.	order no.	mounting position
1	540842	lid hinge, spring thickness 4 mm right
2	540843	lid hinge, spring thickness 4 mm left
3	540844	lid hinge, spring thickness 5 mm right
4	540845	lid hinge, spring thickness 5 mm left

spare parts



fig.	order no.	description	fig.	order no.	spring thickness
1	514148	holder right	3	514150	setting bush long
2	514149	holder left	4	514151	setting bush short



no.	order no.	description	no.	order no.	description
1	540847	spring right 4 mm	3	540849	spring right 5 mm
2	540846	spring left 4 mm	4	540848	spring left 5 mm

Icos



fig.	order no.	description	R (mm)
1	514131	hinge body	320
1	514132	hinge body	395
1	514133	hinge body	500
1	514134	hinge body	545
2	514136	holder	



fig.	order no.	description	fig.	order no.	description
1	514129	setting bush	3	540855	spring left 5mm
2	514137	spring guide	3	514349	spring right 6mm
3	514339	spring right 4mm	3	514350	spring left 6mm
3	514346	spring left 4mm	3	514351	spring right 6.5mm
3	540854	spring right 5mm	3	514352	spring left 6.5mm



fig.	order no.	description
1	514135	bracket handle



fig.	order no.	description
1	514341	hinge support left
1	514340	hinge joint support right
2	514342	support cover
3	514128	spacer bushing
4	514343	setting bush
5	514352	spring left
5	514351	spring right

Firex



no.	order no.	description	R (mm)
1	514412	lid hinge, spring thickness 4mm	320
2	514413	lid hinge, spring thickness 5mm	395
3	514414	lid hinge, spring thickness 6mm	470

spare parts



no.	order no.	description	no.	order no.	description
1	540847	spring right 4 mm	4	540855	spring left 5 mm
2	540846	spring left 4 mm	5	540856	spring right 6 mm
3	540854	spring right 5 mm	6	540857	spring left 6 mm

various



no.	order no.	description	suitable for
1	700395	lid hinge, with handle spring thickness 7 mm	MBM



fig.	order no.	description	R(mm)	suitable for
1	700034	lid hinge, spring thickness 3 mm	220	GICO
2	700035	lid hinge, spring thickness 5 mm	320	GICO

lid locks (Autoclave)



fig.	order no.	description	suitable for	reference no.
1	514164	hinge body	Fagor	X156101
2	514169	swivel joint support	Fagor	X286102



fig.	order no.	description	suitable for	reference no.
1	514162	hinge body	Fagor	S036130
2	514168	swivel joint support	Fagor	S036131



fig.	order no.	description	suitable for	reference no.
1	514165	setting bush	Fagor	S116120
2	691727	bearing	Fagor	S116118
3	691016	spring 5.6 mm	Fagor	S116121
4	514167	bush	Fagor	S116126
5	514166	bearing	Fagor	S116119

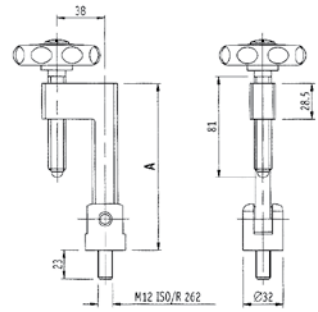

no.	order no.	A (mm)	no.	order no.	A (mm)
1	514125	123	3	540851	143
2	540850	134			

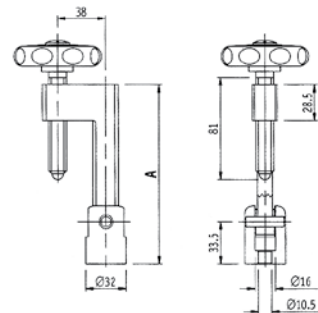

no.	order no.	A (mm)	no.	order no.	A (mm)
1	514126	123	2	514127	143



fig.	order no.	description	suitable for	ref. no.
1	900510	lid gasket 2 m	Icos	
1	900513	lid gasket 2.5 m	Icos	
1	900514	lid gasket 3.2 m	Icos	
1	900515	lid gasket 3.5 m	Icos	
2	900819	lid gasket 1 m	Firex	
2	900821	lid gasket 2 m	Firex	
2	900822	lid gasket 2.4 m	Firex	
2	900823	lid gasket 3m	Firex	

GASTROPARTS.COM

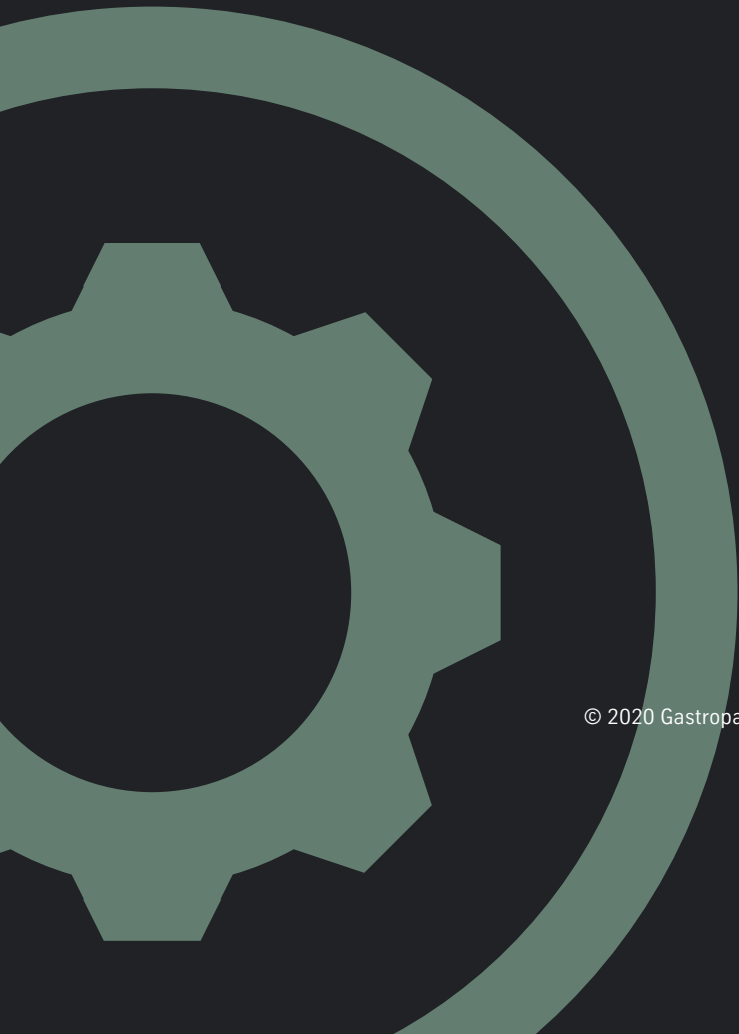

© 2020 Gastroparts Sp. J. All rights reserved.