



GASTROPARTS

Universal Catalogue › Electric Components ›

[EN] Lamps

[DE] Lampen

[ES] Lámparas

[FR] Lampes

[IT] Lampade

[PL] Lampki

[RU] Лампы

✉ gastroparts@gastroparts.com

☎ tel. +48 56 657 00 66

📘 fb.com/gastroparts.global

GASTROPARTS.COM





lamps

8

indicator lights.	374
LED.	383
screw-on/push-on fit.	384
linear lamps.	386
hard-glass infrared lamps.	389
fluorescent lamps.	389
fridge lamps.	391
microwave lamps.	391
oven lamps.	392
residual heat indicators.	401
handlamps.	401



lamps

indicator lights

indicator lights 2-piece (lens and indicator lamp)

indicator light lenses

ø 6mm (type SQ-20)

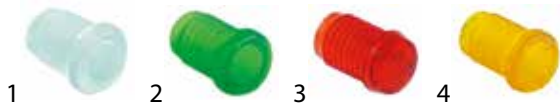

fig.	Part No.	colour	Qty (pcs)	fig.	Part No.	colour	Qty (pcs)
1	359806	clear	1	3	359805	red	1
2	359803	green	1	4	359804	yellow	1

ø 8mm (type RL-2)

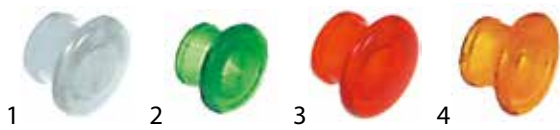

fig.	Part No.	colour	Qty (pcs)	fig.	Part No.	colour	Qty (pcs)
1	359948	clear	1	3	359833	red	1
2	359819	green	1	4	359820	yellow	1

ø 9mm (type SA-4)

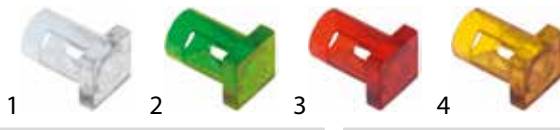

fig.	Part No.	colour	Qty (pcs)	fig.	Part No.	colour	Qty (pcs)
1	359956	clear	1	3	359955	red	1
2	359954	green	1	4	359953	yellow	1

ø 9mm (type SA-7)

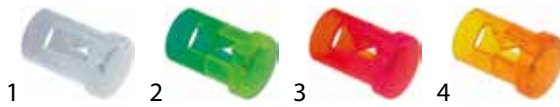

fig.	Part No.	colour	Qty (pcs)	fig.	Part No.	colour	Qty (pcs)
1	359952	clear	1	3	359951	red	1
1	357032	clear	10	3	357031	red	10
2	359950	green	1	4	359949	yellow	1
2	357030	green	10	4	357029	yellow	10

ø10mm (type SC-1)

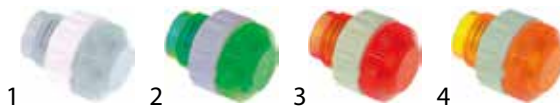

fig.	Part No.	colour	Qty (pcs)	fig.	Part No.	colour	Qty (pcs)
1	359965	clear	1	3	359964	red	1
2	359963	green	1	4	359962	yellow	1

ø10mm (type SC-3)



fig.	Part No.	colour	Qty (pcs)	fig.	Part No.	colour	Qty (pcs)
1	359969	clear	1	3	359968	red	1
1	357040	clear	10	3	357039	red	10
2	359967	green	1	4	359966	yellow	1
2	357038	green	10	4	357037	yellow	10

ø10mm (type SR-3)

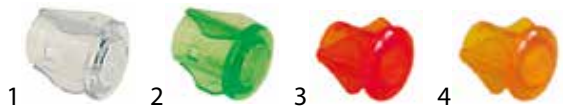

fig.	Part No.	colour	Qty (pcs)	fig.	Part No.	colour	Qty (pcs)
1	359815	clear	1	3	359957	red	1
1	357036	clear	10	4	359414	yellow	1
2	359816	green	1				

ø10mm (type SR-6)

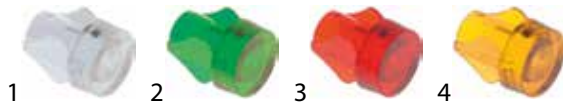

fig.	Part No.	colour	Qty (pcs)	fig.	Part No.	colour	Qty (pcs)
1	359961	clear	1	3	359960	red	1
2	359959	green	1	4	359958	yellow	1

ø10mm (type SRZ-3)

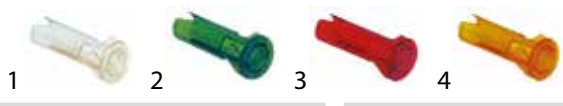

fig.	Part No.	colour	Qty (pcs)	fig.	Part No.	colour	Qty (pcs)
1	359228	clear	1	3	359125	red	1
2	359123	green	1	4	359124	yellow	1

ø10mm (type SRZ-4)



fig.	Part No.	colour	Qty (pcs)	fig.	Part No.	colour	Qty (pcs)
1	359120	green	1	3	359121	yellow	1
2	359122	red	1				

ø12mm (type SD-3)



fig.	Part No.	colour	Qty (pcs)	fig.	Part No.	colour	Qty (pcs)
1	359973	clear	1	2	359971	green	1
1	357044	clear	10	2	357042	green	10

Table continues overleaf





fig.	Part No.	colour	Qty (pcs)	fig.	Part No.	colour	Qty (pcs)
3	359972	red	1	4	359970	yellow	1
3	357043	red	10	4	357041	yellow	10

ø12mm (type SDK-3)



fig.	Part No.	colour	Qty (pcs)	fig.	Part No.	colour	Qty (pcs)
1	359792	blue	1	4	359276	red	1
2	359275	clear	1	5	359278	yellow	1
3	359277	green	1				

ø12mm (type SDK-4)



fig.	Part No.	colour	Qty (pcs)	fig.	Part No.	colour	Qty (pcs)
1	357230	green	1	2	357229	yellow	1

ø12mm (type SDY-3)



fig.	Part No.	colour	Qty (pcs)	fig.	Part No.	colour	Qty (pcs)
1	359280	clear	1	3	359261	red	1
2	359262	green	1	4	359260	yellow	1

ø13mm (type SF-2)

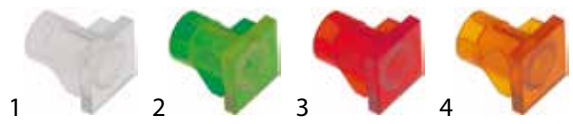

fig.	Part No.	colour	Qty (pcs)	fig.	Part No.	colour	Qty (pcs)
1	359981	clear	1	3	359980	red	1
2	359979	green	1	4	359978	yellow	1

ø13mm (type SF-3)



fig.	Part No.	colour	Qty (pcs)	fig.	Part No.	colour	Qty (pcs)
1	359977	clear	1	3	359976	red	1
1	357048	clear	10	3	357047	red	10
2	359975	green	1	4	359974	yellow	1
2	357046	green	10	4	357045	yellow	10

ø13mm (type SFK-3)



fig.	Part No.	colour	Qty (pcs)	fig.	Part No.	colour	Qty (pcs)
1	359225	clear	1	3	359128	red	1
2	359126	green	1	4	359127	yellow	1

indicator lamps for socket type



fig.	Part No.	volt. (V)	colour	connection
1	347476	5	green	cable 170mm
2	359801	12	white	F6.3
2	359802	24	white	F6.3
2	359109	230	green	F6.3
2	359110	230	white	F6.3
3	359931	230	green	cable 400mm
3	359930	230	white	cable 400mm
4	359747	250	green	grip connection
4	360638	250	white	grip connection

indicator lamps for socket type



fig.	Part No.	volt. (V)	colour	connection
1	357227	230	clear	cable 250mm
1	357228	230	green	cable 250mm
2	359818	230	clear	F6.3
2	359817	230	green	F6.3

indicator lamps for socket type SA / SC / SD / SF / SR



fig.	Part No.	volt. (V)	colour	connection	Qty (pcs)
1	359814	230	clear	cable 400mm	1
1	359987	230	green	cable 400mm	1
1	359521	400	clear	cable 400mm	1
1	359520	400	green	cable 400mm	1
2	359984	230	clear	F4.8	1
2	359985	230	green	F4.8	1
3	359982	230	clear	F6.3	1
3	357049	230	clear	F6.3	10
3	359983	230	green	F6.3	1
3	357050	230	green	F6.3	10
3	359523	400	clear	F6.3	1
3	359522	400	green	F6.3	1



indicator lamps for socket type SRZ / SDK / SDY / SFK



fig.	Part No.	volt. (V)	colour	connection
1	359279	12	clear	F6.3
1	359129	24	clear	F6.3
1	359130	230	clear	F6.3
1	359132	250	green	F6.3
1	359131	400	clear	F6.3
1	359133	400	green	F6.3
2	359350	230	blue	F6.3
3	359430	230	clear	cable 400mm
3	359431	230	green	cable 400mm
3	359435	400	clear	cable 400mm

rings for socket type SC-1



fig.	Part No.	description
1	359242	frame chrome-plated

indicator lights 3-piece (housing, lens and bulb)

ø16.2mm



fig.	Part No.	description
1	359832	lamp socket ø16,2mm socket Ba9s connection male faston 6,3mm
1	359060	lamp socket ø16,2mm E10 connection screw connection
2	359070	indicator light lens yellow
3	359071	indicator light lens green
4	359073	indicator light lens clear
5	359072	indicator light lens red



fig.	Part No.	description
1	359685	lamp socket ø16,2mm E10
2	359687	indicator light lens yellow
3	359688	indicator light lens green
4	359686	indicator light lens clear
5	359689	indicator light lens red

ø18.2mm



fig.	Part No.	description
1	359853	lamp socket ø18,2mm socket Ba9s connection male faston 6.3mm
2	359856	indicator light lens yellow
3	359857	indicator light lens green
4	359899	indicator light lens clear
5	358502	indicator light lens red with gasket

ø19.2mm



fig.	Part No.	description
1	359063	lamp socket ø19,2mm E14 connection screw connection
2	359080	indicator light lens yellow
3	359081	indicator light lens green
4	359083	indicator light lens clear
5	359082	indicator light lens red

ø22.3mm



fig.	Part No.	description
1	359064	lamp socket ø22,3mm E14 connection screw connection 250/380V
2	359085	indicator light lens yellow
3	359086	indicator light lens green
4	359088	indicator light lens clear
5	359087	indicator light lens red

ø30.5mm



fig.	Part No.	description
1	359988	lamp socket ø30,5mm 250 V connection F6.3 temp.-resist. 55 °C E14
2	359990	indicator light lens yellow
3	359991	indicator light lens green
4	359993	indicator light lens clear
5	359992	indicator light lens red



lamps

light bulbs



fig.	Part No.	socket	volt. (V)	P (W)	ø (mm)	L (mm)
1	359597	T10	24	2	10	28
2	359598	Ba15d	230	5-7	16	35
3	359609	Ba15d	220-260	10/15	16	50



fig.	Part No.	socket	volt. (V)	P (W)	ø (mm)	L (mm)
4	359868	Ba9s	12	2	10	28
4	359807	Ba9s	24	2	10	28
4	359869	Ba9s	48	2	10	28
4	359656	Ba9s	130	2	10	28
5	359236	E10	24	3	10	28
6	359608	E14	230	10/15	16	51
6	359587	E14	220-260	6-10	16	51



fig.	Part No.	socket	volt. (V)	P (W)	ø (mm)	L (mm)
7	359055	T1 1/2	12	-	4.9	13
8	357005	T1 3/4	24	-	5	15
9	359592	T5.5K	12	3	5.5	22
9	359590	T5.5K	24	3	5.5	22
9	359591	T5.5K	48	3	5.5	22

neon light bulbs



fig.	Part No.	socket	volt. (V)	colour	ø (mm)	L (mm)
1	359000	Ba9s	24	clear	10	24
2	359606	Ba9s	220	clear	10	28
2	359607	Ba9s	380	clear	10	28
3	359600	E10	220	clear	10	28
3	359585	E10	230	green	10	28
3	359601	E10	380	clear	10	28
4	359604	E14	220	clear	16	54
4	359605	E14	380	clear	16	54



fig.	Part No.	socket	volt. (V)	colour	ø (mm)	L (mm)
5	359602	E14	230	clear	14	30
5	359588	E14	230	green	14	30
5	359603	E14	380	clear	14	30
5	359589	E14	400	green	14	30
6	357006	T1 3/4	230	clear	4	15

indicator lights (complete)

ø 6mm



fig.	Part No.	colour	volt. (V)	CL (mm)	fig.	Part No.	colour	volt. (V)	CL (mm)
1	359037	clear	230	400	4	359285	yellow	24	150
2	359284	green	24	150	4	359569	yellow	230	250
2	359004	green	230	400	4	359005	yellow	230	400
3	359009	red	230	400					



fig.	Part No.	volt. (V)	colour	connection
1	357016	230	green	grip connection
2	357017	230	red	grip connection

ø 9mm



fig.	Part No.	colour	volt. (V)	connection
1	359134	clear	230	F6.3
2	359136	green	230	F6.3
2	345597	green	400	F6.3
3	359135	red	230	F6.3
4	359137	yellow	230	F6.3
4	345598	yellow	400	F6.3

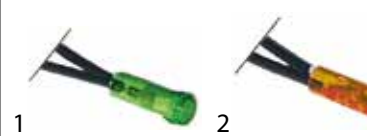

fig.	Part No.	colour	volt. (V)	connection
1	359318	green	24	2-wire
2	359319	yellow	24	2-wire



ø10mm

screw-on fit



fig.	Part No.	colour	volt. (V)	connection
1	359867	clear	230	F4.8
1	359995	clear	230	F6.3
1	359529	clear	400	F6.3
2	359870	green	230	F4.8
2	359378	green	230	F6.3
2	359527	green	400	F6.3
3	359872	red	230	F4.8
3	359380	red	230	F6.3
3	359528	red	400	F6.3
4	359871	yellow	230	F4.8
4	359379	yellow	230	F6.3
4	359526	yellow	400	F6.3

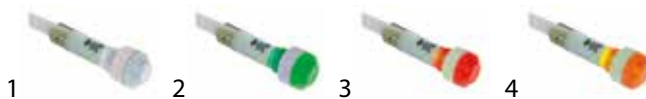

fig.	Part No.	colour	volt. (V)	connection
1	359525	clear	230	F6.3
2	359238	green	230	F6.3
3	359237	red	230	F6.3
4	359524	yellow	230	F6.3



fig.	Part No.	colour	volt. (V)	connection
1	360512	blue	230	F6.3
2	346882	green	230	
3	346881	red	230	F6.3
4	346883	yellow	230	



fig.	Part No.	colour	volt. (V)	connection
1	359475	green	125	F6.3
2	359476	red	110/250	F6.3



fig.	Part No.	colour	volt. (V)	fig.	Part No.	colour	volt. (V)
1	360148	green	24	3	360502	yellow	24
2	360111	red	24				



fig.	Part No.	colour	volt. (V)	connection
1	360578	white	24	cable
2	360579	yellow	24	cable

push-on fit



fig.	Part No.	colour	volt. (V)	connection	Qty (pcs)
1	359227	clear	24	F6.3	1
1	359232	clear	230	F2.8	1
1	359036	clear	230	F6.3	1
1	357058	clear	230	F6.3	5
1	359035	clear	400	F6.3	1
1	357062	clear	400	F6.3	5
2	360479	green	6	F2.8	1
2	359422	green	12	F2.8	1
2	359216	green	24	F6.3	1
2	359230	green	230	F2.8	1
2	359139	green	230	F6.3	1
2	357056	green	230	F6.3	5
2	359019	green	400	F6.3	1
2	357060	green	400	F6.3	5
3	359219	red	24	F6.3	1
3	359040	red	230	F2.8	1
3	359138	red	230	F6.3	1
3	357055	red	230	F6.3	5
3	359020	red	400	F6.3	1
3	357061	red	400	F6.3	5
4	360480	yellow	6	F2.8	1
4	359334	yellow	24	F6.3	1
4	359231	yellow	230	F2.8	1
4	359140	yellow	230	F6.3	1
4	357057	yellow	230	F6.3	5
4	359034	yellow	400	F6.3	1
4	357059	yellow	400	F6.3	5

ø12mm



screw-on fit





fig.	Part No.	colour	volt. (V)	connection
1	359047	clear	24	F6.3
1	359021	clear	230	F6.3
1	359994	clear	400	F6.3
2	359023	green	24	F6.3
2	359027	green	250	F6.3
2	359291	green	400	F6.3





Table continues overleaf









					
3		4			
fig.	Part No.	colour	volt. (V)	connection	
3	359024	red	24	F6.3	
3	359026	red	230	F6.3	
3	359292	red	400	F6.3	
4	359025	yellow	24	F6.3	
4	359048	yellow	230	F6.3	
4	359290	yellow	400	F6.3	

							
1		2		3			
fig.	Part No.	colour	volt. (V)	connection			
1	359890	green	24	cable 200mm			
1	359893	green	400	cable 200mm			
2	359891	red	24	cable 200mm			
2	359894	red	400	cable 200mm			
3	359892	yellow	24	cable 200mm			
3	359895	yellow	400	cable 2000mm			

push-on fit

									
1		2		3		4			
fig.	Part No.	colour	volt. (V)	connection	Qty (pcs)				
1	359044	clear	230	F6.3	1				
1	357064	clear	230	F6.3	5				
2	359041	green	230	F6.3	1				
2	357069	green	230	F6.3	5				
2	359494	green	400	F6.3	1				
3	359043	red	230	F6.3	1				
3	357063	red	230	F6.3	5				
4	359042	yellow	230	F6.3	1				
4	357070	yellow	230	F6.3	5				

									
1		2		3		4			
fig.	Part No.	colour	volt. (V)	connection	symbol				
1	359846	green	230	F6.3	Sinus				
2	359571	green	230	F6.3	steaming				
3	359570	green	230	F6.3	temperature				
4	359572	green	230	F6.3	timer				

					
5		6			
fig.	Part No.	colour	volt. (V)	connection	symbol
5	357110	green	400	F6.3	stand-by/on
6	360509	yellow	230	F6.3	thermometer
6	357111	yellow	400	F6.3	thermometer





ø12.5mm

									
1		2		3		4			
fig.	Part No.	colour	volt. (V)	connection					
1	359999	clear	230	F6.3					
2	359997	green	230	F6.3					
3	359998	red	230	F6.3					
4	359996	yellow	230	F6.3					

				
1				
fig.	Part No.	colour	volt. (V)	connection
1	357009	green	230	F4.8





ø13mm

screw-on fit

									
1		2		3		4			
fig.	Part No.	colour	volt. (V)	connection					
1	357076	green	400	screw					
2	357136	red	24	screw					
2	357135	red	240	screw					
3	357137	red	380	F6.3					
4	357077	yellow	400	screw					

				
1				
fig.	Part No.	colour	volt. (V)	connection
1	357125	red	400	screw clamp

push-on fit

									
1		2		3		4			
fig.	Part No.	colour	volt. (V)	connection	Qty (pcs)				
1	359045	clear	230	F6.3	1				
1	357068	clear	230	F6.3	5				
2	359119	green	24	F6.3	1				
2	359142	green	230	F6.3	1				
2	357066	green	230	F6.3	5				
3	359141	red	230	F6.3	1				
3	357065	red	230	F6.3	5				
4	359143	yellow	230	F6.3	1				
4	357067	yellow	230	F6.3	5				



ø14mm

screw-on fit



fig.	Part No.	colour	volt. (V)	connection
1	360622	green	24	F4.8
2	360621	yellow	24	F4.8

push-on fit



fig.	Part No.	colour	volt. (V)	connection
1	359342	clear	230	F6.3
2	359148	green	230	F6.3
3	359147	red	230	F6.3
4	359149	yellow	230	F6.3



fig.	Part No.	colour	volt. (V)	connection
1	359151	green	400	F6.3
2	359150	red	400	F6.3
3	359152	yellow	400	F6.3

ø16mm

screw-on fit



fig.	Part No.	colour	volt. (V)	connection
1	359835	green	230	F6.3
1	359901	green	400	F6.3
2	359831	red	230	F6.3
2	359903	red	400	F6.3
3	359829	white	230	F6.3
3	359902	white	400	F6.3
4	359834	yellow	230	F6.3
4	359830	yellow	400	F6.3

push-on fit



fig.	Part No.	colour	volt. (V)	CL (mm)	fig.	Part No.	colour	volt. (V)	CL (mm)
1	359909	green	230	200	3	359093	white	400	200
1	359828	green	400	200	4	359908	yellow	230	200
2	359910	red	230	200	4	359094	yellow	400	200
2	359905	red	400	200					



fig.	Part No.	colour	volt. (V)	connection
1	359345	blue	230	F6.3
2	359790	clear	230	F6.3
3	359788	green	230	F6.3
4	359344	red	230	F6.3
5	359789	yellow	230	F6.3



fig.	Part No.	colour	volt. (V)	connection
1	359474	green	230	F6.3
2	359472	red	230	F6.3
3	359473	yellow	230	F6.3

ø20mm



fig.	Part No.	colour	volt. (V)	connection
1	359514	green	230	F6.3



fig.	Part No.	colour	volt. (V)	connection
1	357073	red	250	F4.8

ø22mm



fig.	Part No.	colour	volt. (V)	connection
1	359508	clear	230	screw
1	359512	clear	400	screw
2	359506	green	230	screw
2	359510	green	400	screw
3	359511	red	400	screw
4	359505	yellow	230	screw
4	359509	yellow	400	screw



fig.	Part No.	colour	volt. (V)	connection
1	357020	white	230-440	screw
2	357021	yellow	230-440	screw



ø25mm



fig.	Part No.	colour	volt. (V)	connection
1	359204	green	230	F6.3
2	359202	red	230	F6.3
3	360551	white	230	F6.3
4	359203	yellow	230	F6.3



fig.	Part No.	colour	volt. (V)	connection
1	359079	white	230	F6.3

14x11mm



fig.	Part No.	colour	volt. (V)	connection
1	359270	green	230	F6.3
2	359218	yellow	230	F6.3

19x13mm



fig.	Part No.	colour	volt. (V)	connection
1	359201	green	230	F6.3
2	359200	red	230	F6.3

22x10mm



fig.	Part No.	colour	volt. (V)	connection
1	359215	clear	230	F6.3
2	359214	green	230	F6.3
3	359213	yellow	230	F6.3

25x11mm



fig.	Part No.	colour	volt. (V)	connection
1	359223	green	230	F6.3
2	359224	yellow	230	F6.3

26.5x25.6mm



fig.	Part No.	colour	volt. (V)	connection
1	357172	blue	250	F6.3
2	345853	green	230	F6.3
3	345854	green	230	F6.3
4	345855	green	230	F6.3



fig.	Part No.	colour	volt. (V)	connection
5	358102	green	220-250	F6.3
6	357173	red	230	F6.3
7	345796	white	230	F6.3
8	347446	white	250	F6.3



fig.	Part No.	colour	volt. (V)	connection
9	347869	white	250	F6.3
10	359010	yellow	230	F6.3
11	359011	yellow	230	F6.3
12	359012	yellow	230	F6.3

27.2x22.2mm



fig.	Part No.	colour	volt. (V)	connection
1	359209	red	230	F6.3
2	359631	yellow	230	F6.3
3	359911	yellow	230	F6.3

27x12mm



fig.	Part No.	colour	volt. (V)	connection
1	348056	red	28	F6.3
2	348057	white	28	F6.3



28.5x28.5mm



fig.	Part No.	description
1	345926	light bulb housing 28.5x28.5mm orange connection cycle
2	345927	light bulb housing 28.5x28.5mm red level



fig.	Part No.	description
1	345728	indicator light lens 23x23 orange defrost
2	345610	indicator light lens 23x23 orange operating
3	345616	indicator light lens 23x23 orange Sinus
4	345614	indicator light lens orange heating
5	345617	indicator light lens orange thermometer



fig.	Part No.	description
1	359799	light bulb housing 28.5x28.5mm red
2	359798	light bulb housing 28.5x28.5mm yellow

28.5x52.6mm



fig.	Part No.	colour	volt. (V)	connection
1	345877	green	230	F6.3

28.5x77.5mm

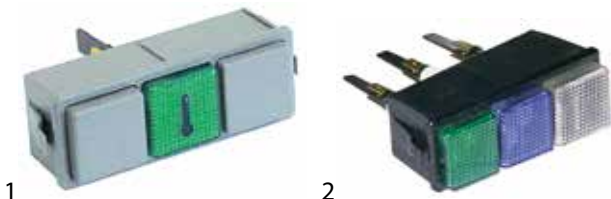

fig.	Part No.	colour	volt. (V)	connection
1	345873	green	230	F6.3
2	359008	white/blue/green	230	F6.3

30x11mm



fig.	Part No.	colour	volt. (V)	connection
1	359160	green	230	F6.3
2	359158	red	230	F6.3
3	359159	yellow	230	F6.3

30x13mm



fig.	Part No.	colour	volt. (V)	connection
1	346548	green	220	F6.3
2	346547	red	230	F6.3

30x22mm



fig.	Part No.	colour	volt. (V)	connection
1	359180	yellow	230	F6.3
2	359178	green	230	F6.3
3	359179	clear	230	F6.3
4	359177	red	230	F6.3



fig.	Part No.	colour	volt. (V)	connection
5	359251	yellow	24	F6.3
5	359156	yellow	230	F6.3
6	359250	green	24	F6.3
6	359157	green	230	F6.3
7	359155	red	230	F6.3
8	359154	white	230	F6.3



fig.	Part No.	colour	volt. (V)	connection
9	359354	blue	230	F6.3



				
fig.	Part No.	colour	volt. (V)	connection
10	357011	white	230	F6.3
11	359409	white	230	F6.3
12	347641	red	230	F6.3

					
fig.	Part No.	colour	volt. (V)	connection	symbol
1	359407	white	230	F6.3	temperature
2	359406	white	230	F6.3	programme
3	359029	green	230	F6.3	flash
4	359030	green	230	F6.3	machine stand-by





					
fig.	Part No.	colour	volt. (V)	connection	symbol
5	357022	yellow	250	F6.3	coffee

				
fig.	Part No.	colour	volt. (V)	connection
1	359164	green/white	230	F6.3
2	301138	red/green	230	F6.3
3	346968	yellow/red	230	F6.3

33x10mm				
				
fig.	Part No.	colour	volt. (V)	connection
1	359452	green	400	F6.3
2	359451	yellow	400	F6.3

34.1x23.1mm				
				
fig.	Part No.	colour	volt. (V)	connection
1	347313	green	230	F6.3
2	347559	green	230	F6.3
3	347314	red	230	F6.3

34x10mm				
				
fig.	Part No.	colour	volt. (V)	connection
1	359211	green	230	F6.3
2	359239	red	230	F6.3
2	359899	red	380	F6.3
3	359210	yellow	230	F6.3

miscellaneous				
				
fig.	Part No.	description	suitable for	
1	359429	indicator light 230 V connection male faston 6.3mm mounting ø 18 mm	Palux	
2	357124	indicator light 230V green/red connection screw connection	Repagas	
3	359273	indicator light 230V yellow	Giorik	
4	359066	indicator light 30x21mm green 230 V	Krefft Rational	
4	359065	indicator light 30x21mm white 230 V	Krefft Rational	

				
fig.	Part No.	description	suitable for	
5	359851	indicator light 32.5x8.5mm white 230 V	Cookmax Sirman	
6	360619	indicator light green 125/250V connection male faston 6.3mm	Pitco	
7	359887	lamp socket ø21mm E10	Krefft Küppersbusch Rational	

LED

indicator lamps

mounting diameter 6mm

				
fig.	Part No.	colour	voltage	connection
1	359404	green	5VDC	cable 200mm
2	358098	yellow	5VDC	cable 200mm



mounting diameter 8mm



fig.	Part No.	colour	voltage	connection
1	359357	green	24VDC	F2.8x0.8
2	360650	red	12VDC	F2.8x0.8
2	359403	red	24VDC	F2.8x0.8
3	360651	yellow	12VDC	F2.8x0.8
3	359402	yellow	24VDC	F2.8x0.8

mounting diameter 14mm



fig.	Part No.	colour	voltage	connection
1	359382	green	230VAC	F2.8x0.8
2	359398	red	230VAC	F2.8x0.8
3	359397	yellow	230VAC	F2.8x0.8

mounting diameter 24mm



fig.	Part No.	colour	voltage	connection
1	360603	green	230VAC	F2.8
2	360602	yellow	230VAC	F2.8

mounting diameter 25mm



fig.	Part No.	colour	voltage	connection
1	360584	blue	3VDC	cable 1000mm
2	360585	green	3VDC	cable 1000mm
3	360583	red	3VDC	cable 1000mm



fig.	Part No.	colour	voltage	connection
1	360605	green	24VDC	F2.8
2	360604	red	24VDC	F2.8

miscellaneous



fig.	Part No.	version	voltage	colour	connection
1	359217	LED	220-240	green	Ba9s

LED bars

Frenox



fig.	Part No.	L (mm)	W (mm)	H (mm)	fig.	Part No.	L (mm)	W (mm)	H (mm)
1	357212	300	20	20	1	357216	1200	20	20
1	357215	500	19	7	1	357211	1230	20	20
1	357214	690	20	20	1	357213	1435	15	7
1	357218	700	20	20	1	357217	1600	20	20

Horeca-Select



fig.	Part No.	L (mm)	W (mm)	H (mm)
1	357138	698	13	13

accessories

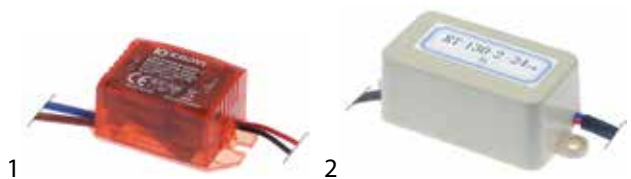

fig.	Part No.	description
1	357178	power supply for LEDs 3W primary 100-240V secondary 0,35A 50/60Hz Qty 1 pcs
2	357152	power supply for LEDs RT-130-2-24cm Qty 1 pcs

screw-on/push-on fit

neon light bulbs



fig.	Part No.	socket	volt. (V)	colour	ø (mm)	L (mm)
1	359000	Ba9s	24	clear	10	24
2	359606	Ba9s	220	clear	10	28
2	359607	Ba9s	380	clear	10	28
3	359600	E10	220	clear	10	28
3	359585	E10	230	green	10	28
3	359601	E10	380	clear	10	28
4	359604	E14	220	clear	16	54
4	359605	E14	380	clear	16	54





fig.	Part No.	socket	volt. (V)	colour	ø (mm)	L (mm)
5	359602	E14	230	clear	14	30
5	359588	E14	230	green	14	30
5	359603	E14	380	clear	14	30
5	359589	E14	400	green	14	30
6	357006	T1 3/4	230	clear	4	15

light bulbs

for lighting



fig.	Part No.	socket	volt. (V)	P (W)	ø (mm)	L (mm)	Qty (pcs)
1	359613	E27	230	25	45	71	1
1	359614	E27	230	40	45	71	1
1	357102	E27	220-260	25	45	72	1
1	357103	E27	220-260	40	45	72	1
2	357177	E27	230	40	45	75	10
3	359849	E27	230	60	48	102	1



fig.	Part No.	socket	volt. (V)	P (W)	ø (mm)	L (mm)	Qty (pcs)
4	357219	E27	250	40	47	88	1

for ovens



fig.	Part No.	t.max. (°C)	P (W)	volt. (V)	ø (mm)	L (mm)	type
1	359740	300	15	230	22	20	IMPORT
1	359610	300	15	230	22	46	Philips
1	357153	300	25	230	25	55	-
1	359612	300	25	230	25	55	Philips
1	357099	500	15	235	22	50	-
1	359448	500	25	230	26	57	-
2	359615	300	25	230	45	76	IMPORT
2	359611	300	40	230	45	75	IMPORT
2	357154	300	40	230	45	75	Philips
2	357100	500	25	220-260	45	75	K4500
2	357101	500	40	220-260	45	75	K4500
3	357118	500	40	230/240	25	70	-

for indicator lights



fig.	Part No.	socket	volt. (V)	P (W)	ø (mm)	L (mm)
1	359597	T10	24	2	10	28
2	359598	Ba15d	230	5-7	16	35
3	359609	Ba15d	220-260	10/15	16	50



fig.	Part No.	socket	volt. (V)	P (W)	ø (mm)	L (mm)
4	359868	Ba9s	12	2	10	28
4	359807	Ba9s	24	2	10	28
4	359869	Ba9s	48	2	10	28
4	359656	Ba9s	130	2	10	28
5	359236	E10	24	3	10	28
6	359608	E14	230	10/15	16	51
6	359587	E14	220-260	6-10	16	51



fig.	Part No.	socket	volt. (V)	P (W)	ø (mm)	L (mm)
7	359055	T1 1/2	12	-	4.9	13
8	357005	T1 3/4	24	-	5	15
9	359592	T5.5K	12	3	5.5	22
9	359590	T5.5K	24	3	5.5	22
9	359591	T5.5K	48	3	5.5	22

halogen lamp

for socket E14 / E27



fig.	Part No.	socket	volt. (V)	P (W)	producer	Qty
1	357197	E14	230	25	OSRAM	1
1	359728	E14	230	40	-	1
2	359683	E27	240	60	-	1



for socket G4 / G6.35 / G9

fig.	Part No.	socket	volt. (V)	P (W)	Temp.Res. (°C)	producer
1	357188	G4	12	5	300	OSRAM
1	359579	G4	12	5	500	-
1	357189	G4	12	5	-	OSRAM
1	357191	G4	12	10	300	OSRAM
1	359596	G4	12	10	500	-
1	357190	G4	12	10	-	OSRAM
1	357193	G4	12	20	300	OSRAM
1	359599	G4	12	20	500	-
1	357192	G4	12	20	-	OSRAM
2	359074	G6.35	12	35	500	-
2	357194	G6.35	12	35	-	OSRAM
3	359945	G9	230	25	300	-
3	357195	G9	230	25	300	OSRAM
3	359946	G9	230	40	300	-
3	357196	G9	230	40	300	OSRAM

for socket GU5.3 / GU10 / GZ5.3

fig.	Part No.	socket	volt. (V)	P (W)	Temp.Res. (°C)
1	359665	GU10	230	50	-
2	357054	GU5.3	12	20	-
2	359496	GU5.3	12	50	-

fig.	Part No.	socket	volt. (V)	P (W)	Temp.Res. (°C)
3	359300	GZ5.3	235	25	400

linear lamps

halogen lamps

fig.	Part No.	socket	L (mm)	volt. (V)	P (W)	producer
1	357198	R7s	74.9	230	48	OSRAM
1	360556	R7s	74.9	230	80	OSRAM
1	357199	R7s	74.9	230	120	OSRAM
1	357090	R7s	117.6	230	120	OSRAM
1	357200	R7s	117.6	230	160	OSRAM
1	357201	R7s	117.6	230	230	OSRAM
1	357202	R7s	117.6	230	400	OSRAM

fig.	Part No.	socket	L (mm)	volt. (V)	P (W)	producer
2	359305	R7s	78.3	230	60	IMPORT
2	359616	R7s	78.3	230	150	IMPORT
2	359313	R7s	117.6	230	150	IMPORT
2	359647	R7s	117.6	230	200	IMPORT
2	359620	R7s	117.6	230	300	IMPORT
2	359621	R7s	117.6	230	500	IMPORT

infrared lamps

with fitting type KSSV

fig.	Part No.	L (mm)	volt. (V)	P (W)	fig.	Part No.	L (mm)	volt. (V)	P (W)
1	359632	260	230	500	1	359638	330	230	1000
1	359629	260	230	650	1	359624 ¹	340	230	1000

¹with reflector

with base type R7s

fig.	Part No.	L (mm)	volt. (V)	P (W)	producer
1	359628	117.6	240	300	IMPORT
1	357075	190	230	200	IMPORT
1	359676	190	230	350	IMPORT
1	357233	190	235	200	OSRAM
1	359331	220	230	300	IMPORT
1	359693	220	230	400	IMPORT
1	359627	220	230	500	IMPORT
1	357019	254	235	500	IMPORT
1	357207	254	235	500	OSRAM

fig.	Part No.	L (mm)	volt. (V)	P (W)	producer
2	357210	214	235	500	OSRAM

fig.	Part No.	L (mm)	volt. (V)	P (W)	producer
3	360507 ¹	255	240	1300	IMPORT

¹with gold-plating

pos.	Part No.	L (mm)	volt. (V)	P (W)	pos.	Part No.	L (mm)	volt. (V)	P (W)
1	359750	117.6	240	300	4	358116	349	240	365
2	359535	218	240	300	5	359537	349	240	1000
3	359536	218	240	500	6	358115	650	240	765



pos.	Part No.	L (mm)	volt. (V)	P (W)	CL (mm)
1	359539	218	240	500	205
2	359678	349	230	365	205
3	359679	640	240	833	1300



pos.	Part No.	L (mm)	volt. (V)	P (W)	CL (mm)
1	359622	428	230	1000	100

sockets for linear lamps

KSSV



1

fig.	Part No.	description	ø (mm)	H (mm)
1	359650	lamp holder	12	25

with base type X lug



pos.	Part No.	L (mm)	volt. (V)	P (W)	producer
1	359618	214	110	500	-
2	359617	340	220	1000	-
3	357208	365	235	1000	OSRAM

R7s



1 2

fig.	Part No.	description	ø (mm)	H (mm)	connection	MD (mm)
1	359726	lamp socket	18	28	cabl 230mm	-
1	357234	lamp socket	18	27	cabl 2000mm	-
2	359445	bracket				36

with base type Z ceramic



1

fig.	Part No.	L (mm)	volt. (V)	P (W)	CL (mm)	producer
1	359694	122	220-240	300	300	IMPORT
1	359581	218	240	300	205	IMPORT
1	359625	226	220-250	500	195	IMPORT
1	357209	349	235	1000	200	OSRAM
1	359626	349	220-250	1000	195	IMPORT



3 4 5

fig.	Part No.	description	ø (mm)	H (mm)	connection	MD (mm)
3	359717	lamp socket	18	31	cabl 320mm	28
4	359734	lamp socket	18	32	cabl 200mm	27
5	359733	lamp socket	18	40	cabl 230mm	27
5	360555	lamp socket	20	36	cabl 400mm	28



2

fig.	Part No.	L (mm)	volt. (V)	P (W)	CL (mm)	producer
2	359582	218	240	500	205	IMPORT



3

fig.	Part No.	L (mm)	volt. (V)	P (W)	CL (mm)	producer
3	357206 ¹	251	240	1300		OSRAM
3	347971 ¹	290	240	1300	600	IMPORT

¹with gold-plating



6 7 8

fig.	Part No.	description	ø (mm)	H (mm)	connection	MD (mm)
6	359648	lamp socket	20	32	cabl 320mm	24/33
7	359727	lamp socket	22	45	cabl 300mm	30
8	359732	lamp socket	22	45	cabl 320mm	30





fig.	Part No.	description	ø (mm)	H (mm)	connection	MD (mm)
9	359649	lamp socket	-	35	cable 350mm	8/35
10	359735	lamp socket	-	40	cable 230mm	-



fig.	Part No.	description	for length of lamp	H (mm)	connection	MD (mm)
6	359583	lamp socket	218	62	cable 200mm	120
6	359584	lamp socket	349	62	cable 200mm	250



fig.	Part No.	description	for length of lamp	H (mm)	connection	MD (mm)
1	359753 ¹	lamp socket	117.6	62	cable 450mm	175

¹only suitable for linear halogen lamps up to max. 150W

X lug



fig.	Part No.	description	L (mm)	W (mm)	H (mm)	MD (mm)
1	359710	lamp socket	70	70	49	50

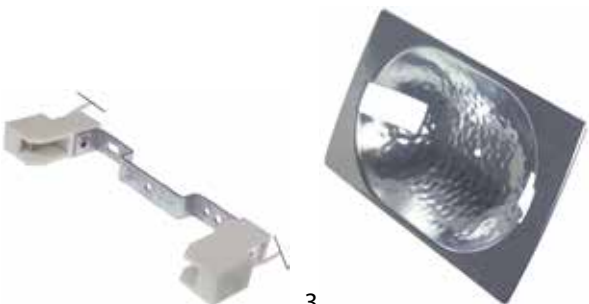

fig.	Part No.	description	for length of lamp	H (mm)	connection	MD (mm)
2	359544	lamp socket	117.6	40	cable 230mm	70
3	359545	reflector				

Z ceramic



fig.	Part No.	description	for length of lamp	L (mm)	W (mm)	H (mm)	MD (mm)
1	359658	lamp socket	218	220	47	62	120
2	359541	lamp socket	349	349	47	62	250



fig.	Part No.	description	for length of lamp	H (mm)	connection	MD (mm)
4	359542	lamp socket	78.3	50	cable 150mm	15
4	359663	lamp socket	117.6	47	cable 150mm	65
5	359547	lamp socket	78.3	43	cable 250mm	
5	359543	lamp socket	117.6	43	cable 150mm	64



fig.	Part No.	description	for length of lamp	L (mm)	W (mm)	H (mm)	MD (mm)
3	359546	lamp socket		45	28	20	20



hard-glass infrared lamps



fig.	Part No.	volt. (V)	P (W)	ø (mm)	L (mm)
1	357205	240	275	125	170
1	360623	240	300	125	180
1	360539	240	375	120	180
1	357095	240	150	125	173
1	358097	240	250	125	173
2	357094	240	150	125	173
2	359463	240	250	125	173

G23



pos.	Part No.	L (mm)	P (W)	volt. (V)	pos.	Part No.	L (mm)	P (W)	volt. (V)
1	357024	108	5	230	2	359933	237	11	230

2G11



pos.	Part No.	L (mm)	P (W)	volt. (V)	pos.	Part No.	L (mm)	P (W)	volt. (V)
1	359640	217	18	230	3	359634	411	36	230
2	359635	310	24	230					

fluorescent lamps

fluorescent lamps

G5



pos.	Part No.	L (mm)	P (W)	volt. (V)	Qty (pcs)	pos.	Part No.	L (mm)	P (W)	volt. (V)	Qty (pcs)
1	357132	212	6	230	1	5	357203	549	14	230	1
2	357156	285	8	230	1	6	359745	560	18	230	1
3	359384	287	8	230	1	7	357204	849	21	230	1
4	357148	547	14	230	1	8	359746	860	21	230	1

G13



pos.	Part No.	L (mm)	P (W)	volt. (V)	Qty (pcs)
1	359385	360	14	230	1
2	357145	438	15	230	1
3	359383	438	15	230	1
4	359737	516	13	230	1
5	359371	590	18	230	1
6	357007	895	30	230	1
7	357146	895	30	230	1
8	357147	895	30	230	1
9	359372	895	30	230	1
10	359738	970	23	230	1
11	357008	1198	36	230	1
12	359386	1198	36	230	1
13	359390	1500	58	230	1

complete with holder



1

fig.	Part No.	L (mm)	W (mm)	P (W)	volt. (V)	suitable for
1	360610	343	23	8	220-240	Fagor

2



fig.	Part No.	L (mm)	W (mm)	P (W)	volt. (V)	suitable for
2	359743	600	42	18	230	Inomak
2	359744	900	42	21	230	Inomak
2	359481	1204		28	230	Öztiryakiler

3



fig.	Part No.	L (mm)	W (mm)	P (W)	volt. (V)	suitable for
3	357115	1224	23	28	220/240	Izmaç Philips

4



fig.	Part No.	L (mm)	W (mm)	P (W)	volt. (V)	suitable for
4	359391	1245	37	36		Emainox GE General Electric
4	359392	1545	37	58		Emainox



accessories

sockets



fig.	Part No.	socket	suitable for	fig.	Part No.	socket	suitable for
1	359730	2G11	Mercury	3	357025	G23	Marco
2	381156	2G11	Eloma				



fig.	Part No.	socket	suitable for	fig.	Part No.	socket	suitable for
4	359684	G5	Scholl	6	381169	G13	Dukers Horeca-Select
5	359395	G13	CB				



fig.	Part No.	socket	suitable for	fig.	Part No.	socket	suitable for
7	358176	G13	Emainox	8	358175	G13	Emainox



fig.	Part No.	socket	suitable for	fig.	Part No.	socket	suitable for
9	359389	G13	—	10	359388	G13	—



fig.	Part No.	socket	suitable for	fig.	Part No.	socket	suitable for
11	359682	G13	Scholl	12	359681	G13	Scholl

starter holders



fig.	Part No.	P (W)	suitable for	fig.	Part No.	P (W)	suitable for
1	359394		CB	3	381170		Dukers Horeca-Select
2	380466		Desmon Scholl				

starter



fig.	Part No.	P (W)	fig.	Part No.	P (W)
1	357150	11	2	380464	4-65

ballasts



fig.	Part No.	P (W)	volt. (V)	Qty (pcs)	suitable for
1	403191	9	220	1	Dukers Horeca-Select
2	402063	15	230	1	Cookmax Mafrol
3	403192	15	220-240	1	Dukers Horeca-Select



fig.	Part No.	P (W)	volt. (V)	Qty (pcs)	suitable for
4	401504	18	230	1	CB Cookmax Fagor IARP Mafrol
5	402064	25	230	1	Cookmax Mafrol



7		8		9	
fig.	Part No.	P (W)	volt. (V)	Qty (pcs)	suitable for
7	401141	30	230	1	Coldmaster Desmon Emainox Scholl
8	402065	30	230	1	Cookmax Mafirol
9	403190	30	220-240	1	Dukers Horeca-Select
9	358134	76	230	1	Dukers Horeca-Select

10		11			
fig.	Part No.	P (W)	volt. (V)	Qty (pcs)	suitable for
10	401505	36	230	1	CB Cookmax Fagor IARP Ilsa Mafirol
11	402066	58	230	1	Cookmax Mafirol

fridge lamps

1							
fig.	Part No.	description	socket	P (W)	volt. (V)	ø (mm)	L (mm)
1	359595	light bulb	E14	15	230-240	25	56

producer-specific fridge lamps

ELECTROLUX

1		
fig.	Part No.	description
1	357106	lamp glass L 103 mm W 65 mm plastic

NINGBO ROTOR

1		2		3	
fig.	Part No.	description	Ref. No.		
1	357127	LED fridge GHR1040 white 220 V PCB voltage AC	—		
2	357143	cover for lamp plastic ø 62mm clear Qty 1 pcs	RW40.38		
3	357144	lamp holder for LEDs ø 84mm Qty 1 pcs	RW40.37		

1			
fig.	Part No.	description	Ref. No.
1	357149	lamp socket T140 250V L 34,5mm H 31mm plastic Qty 1 pcs 500W hole distance 254mm	GGC1078-32

NINGBO ROTOR

1			
fig.	Part No.	description	Ref. No.
1	357149	lamp socket T140 250V L 34,5mm H 31mm plastic Qty 1 pcs 500W hole distance 254mm	GGC1078-32

RWA

1		2		3	
fig.	Part No.	description			
1	357144	lamp holder for LEDs ø 84mm Qty 1 pcs			
2	357127	LED fridge GHR1040 white 220 V PCB voltage AC			
3	357143	cover for lamp plastic ø 62mm clear Qty 1 pcs			

microwave lamps

lamps (complete)

1		2		3				
fig.	Part No.	socket	volt. (V)	P (W)	ø (mm)	L (mm)	Qty (pcs)	suitable for
1	359561	-	220-240	25	25	67	1	—
2	358149	E14	250	75	25	125	1	ACP
3	357221	flange 52x27mm	240	25	25	62	1	ACP



sockets



fig.	Part No.	socket	volt. (V)	P (W)	ø (mm)	L (mm)	Qty (pcs)	suitable for
1	357141	E14	250		26	37	1	Galanz Horeca-Select
2	360597	E14	250	75	27	44	1	ACP

light bulbs



fig.	Part No.	socket	volt. (V)	P (W)	ø (mm)	L (mm)	Qty (pcs)
1	357142	E14	230	20	22	58	1
1	357175	E14	230	20	25	63	1
1	359549	E14	220-240	25	25	60	1
2	357220	E14	240	20	25	40	1
3	357222	E14	240	25	24.8	81.5	1



fig.	Part No.	socket	volt. (V)	P (W)	ø (mm)	L (mm)	Qty (pcs)
4	359551	E14	240	15	26	57	1
5	359559	F4.8	220-240	20	24	80	1

oven lamps

universal oven lamps

mounting diameter 28.5mm



fig.	Part No.	description
1	359317	oven lamp mounting ø 28,5 mm 12 V 5 W socket G4 cable length 300 mm
2	359308	oven lamp glass

mounting diameter 35.5mm



fig.	Part No.	volt. (V)	P (W)	socket	connection	version
1	357162	12	20	G4	cable 450mm	borosilicate glass
2	359720	230	15	E14	F6.3	borosilicate glass
3	359718	230	15	E14	F6.3	hard glas



fig.	Part No.	volt. (V)	P (W)	socket	connection	version
4	359660	230	25	E14	F6.3	hard glas
5	359934	230	25	E14	F6.3	hard glas
5	359457	230	25	G9	F6.3	borosilicate glass
6	360601	230	25	G4	F6.3	hard glas



fig.	Part No.	volt. (V)	P (W)	socket	connection	version
7	357232	230	40	G9	cable 85mm	borosilicate glass
8	359259	230	40	G9	cable 380mm	borosilicate glass



fig.	Part No.	description	socket	connection
1	359701	lamp socket	E14	F6.3
2	359762	lamp socket	G4	cable 350mm
2	357080	lamp socket	G4	cable 2400mm
2	359841	lamp socket	G4	cable 3500mm
3	357160	lamp socket	G9	cable 100mm
3	357161	lamp socket	G9	cable 380mm



fig.	Part No.	description	socket	connection
4	359427	lamp socket	G9	F6.3





fig.	Part No.	description	ø (mm)	version	Temp.Res. (°C)
1	359033	oven lamp glass	41	hard glas	350
2	359942	oven lamp glass	41	hard glas	350
3	359709	oven lamp glass	42	hard glas	350



fig.	Part No.	description	ø (mm)	version	Temp.Res. (°C)
4	359723	oven lamp glass	51	borosilicate glass	550
5	359705	oven lamp glass	52	borosilicate glass	550
6	359661	oven lamp glass	58	hard glas	350



fig.	Part No.	description	material	ID ø (mm)	ED ø (mm)	T (mm)
1	359700	gasket	fibre glass	32.5	55	5
2	358135 ¹	gasket	PTFE	44	53	3
3	358128	gasket	silicone	30	38	2
4	359721	gasket	silicone	48	39.5	5

¹with silicone O-ring

mounting diameter 47.8mm



fig.	Part No.	volt. (V)	P (W)	socket	connection	version
1	357187	230	15	E14	F6.3	hard glas
2	359711	230	25	E14	F6.3	hard glas



fig.	Part No.	volt. (V)	P (W)	socket	connection	version
3	359703	230	15	E14	F6.3	hard glas
4	357165	230	40	G9	F6.3	hard glas



fig.	Part No.	description	socket	connection
1	359499	lamp socket	E14	F6.3
2	360541	lamp socket	G9	F6.3



fig.	Part No.	description	ø (mm)	version	Temp.Res. (°C)
1	357166	oven lamp glass	54	hard glas	350
2	359725	oven lamp glass	54	hard glas	350

mounting diameter 65.5mm



fig.	Part No.	volt. (V)	P (W)	socket	connection	version
1	357078	230	40	E14	F6.3	hard glas
2	359712	230	40	E14	F6.3	hard glas



fig.	Part No.	volt. (V)	P (W)	socket	connection	version
3	357167	230	40	G9	F6.3	borosilicate glass



fig.	Part No.	description	socket	connection
1	359022	lamp socket	E14	F6.3
2	357002	lamp socket	G9	F6.3

1

fig.	Part No.	description	ø (mm)	version	Temp.Res. (°C)
1	359724	oven lamp glass	74	hard glas	350



1 2 3

fig.	Part No.	description	material	ID ø (mm)	ED ø (mm)	T (mm)
1	357083	sealing ring	metal	63	78	3
2	359729	gasket	PTFE	57	67	5
3	359722	gasket	silicone	57.5	68	2

30x70mm



1 2

fig.	Part No.	description
1	359337	oven lamp connection Faston 6,3mm
2	359338	lamp glass

55x70mm



1 2

fig.	Part No.	volt. (V)	P (W)	socket	connection
1	358111	12	20	G4	cabl 135mm
2	359659	230	25	E14	F6.3



3

fig.	Part No.	volt. (V)	P (W)	socket	connection
3	358130	230	25	G9	cabl 300mm



1 2

fig.	Part No.	socket	connection
1	357159	E14	F6.3
2	358148	G4	cabl 135mm



3 4

fig.	Part No.	socket	connection
3	358131	G9	cabl 300mm
4	357105	G9	F6.3



1

fig.	Part No.	description
1	359937	lamp glass L 80 mm W 65 mm 52x67mm



1 2

fig.	Part No.	description
1	357171	oven lamp complete 230 V 25 W socket G9 L 70 mm W 55 mm 55x70mm connection male faston 6.3mm
2	359937	lamp glass L 80 mm W 65 mm 52x67mm



1 2

fig.	Part No.	description
1	360608	lamp L 95mm W 80mm 230-240V 25W E14 complete temp.-resist. 300°C connection F6,3
2	357105	lamp socket socket G9 250 V 55x70mm connection male faston 6.3mm H 32 mm



3 4

fig.	Part No.	description
3	359299	gasket for oven lamp L 91mm W 77mm hole ø 3mm
4	359296	lamp glass L 74 mm W 58 mm thickness 3 mm



5 6

fig.	Part No.	description
5	358147	gasket for oven lamp L 75mm W 65mm thickness 1mm
6	359297	frame L 95mm W 81 mm thickness 6mm mounting distance 68/83mm

55x100mm

1 2

fig.	Part No.	description
1	359696	oven lamp complete 25W 230V L 100mm W 55mm E14 temp.-resist. 300°C
2	359698	lamp socket E14 L 100mm W 55mm connection male faston 6,3mm

3

fig.	Part No.	description
3	359938	borosilicate glass L 115 mm W 69 mm

1 2

fig.	Part No.	description
1	101372	oven lamp complete 25W 230V L 100mm W 55mm E14 rectangular temp.-resist. 300°C
2	359698	lamp socket E14 L 100mm W 55mm connection male faston 6,3mm

3 4

fig.	Part No.	description
3	359715	lamp glass L 110 mm W 65 mm thickness 5 mm
4	359714	gasket for bulb socket

5

fig.	Part No.	description
5	359716	frame for bulb socket

60x100mm

1 2

fig.	Part No.	description
1	359767	oven lamp temp.-resist. 300°C connection male faston 6,3mm
2	359944	borosilicate glass

50x75.5mm

1 2 3

fig.	Part No.	description
1	359309	oven lamp L 75mm W 50mm 230V 40W E14 temp.-resist. 300°C connection male faston 6,3mm
2	360484	lamp socket L 75mm W 50mm 230V 40W socket E14 temp.-resist. 300°C connection male faston 6,3mm
3	359303	oven lamp glass L 88 mm W 54 mm for oven lamp

producer-specific oven lamps

ANGELO PO

1 2 3

fig.	Part No.	description	Ref. No.
1	359701	lamp socket socket E14 220-230V mounting ø 35,5 mm connection male faston 6,3mm 15 W	32W2561
2	359340	glass panel ø 78mm thickness 3mm round	3036650
3	359339	gasket thickness 1mm ID ø 65mm ED ø 80mm	37Q7840

BERTO'S

1 2 3

fig.	Part No.	description	Ref. No.
1	359839	lamp socket G4 for halogen lamp	10867
2	359840	frame for oven lamp	40863
3	359299	gasket for oven lamp L 91 mm W 77mm hole ø 3mm	10304

4 5

fig.	Part No.	description	Ref. No.
4	359296	lamp glass L 74 mm W 58 mm thickness 3 mm	10305
5	359297	frame L 95mm W 81mm thickness 6mm mounting distance 68/83mm	24289500



BOURGEOIS



fig.	Part No.	description	Ref. No.
1	359580	lamp socket for halogen lamp	Lamp012
2	360530	lamp glass L 47,4 mm W 32,8 mm glas thickness 3,2 mm	HUBL009
3	511690	gasket for lamp L 78mm W 42mm silicone thickness 3mm hole distance 66,5mm	JOIN109

CONVOTHERM



fig.	Part No.	description
1	360639	oven lamp complete 230 V 25 W socket G9 55x70mm connection male faston 6.3mm
2	359488	oven lamp complete 55x70mm 230 V 15 W socket E14 rectangular connection male faston 6.3mm L 87 mm



fig.	Part No.	description
3	357105	lamp socket socket G9 250 V 55x70mm connection male faston 6.3mm H 32 mm
4	357159	lamp socket socket E14 55x70mm connection male faston 6.3mm Qty 1 pcs

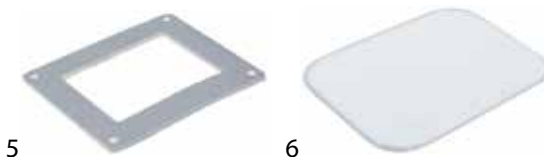

fig.	Part No.	description
5	358180	gasket for oven lamp L 94mm W 78mm thickness 3mm PTFE
6	694335	lamp glass L 87 mm W 72 mm thickness 3 mm

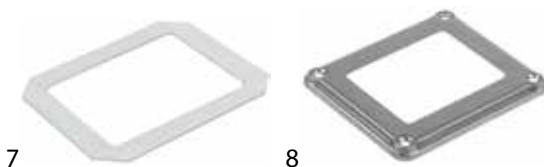

fig.	Part No.	description
7	360641	gasket for oven lamp L 86 mm W 71 mm thickness 0,5 mm PTFE
8	360640	frame L 98 mm W 83 mm thickness 6,5 mm mounting distance mm stainless steel



fig.	Part No.	description	Ref. No.
1	359701	lamp socket socket E14 220-230V mounting ø 35,5 mm connection male faston 6.3mm 15 W	5005016
2	359643	lamp glass ø 69 mm thickness 4 mm	—
3	359642	gasket thickness 5,5mm graphite ID ø 62mm ED ø 70mm	6005013



fig.	Part No.	description	Ref. No.
4	692171	frame for lamp lenses bore ø 6,3mm D1 ø 72mm D2 ø 56mm L 83mm W 83mm thickness 1mm	5005020



fig.	Part No.	description	Ref. No.
1	360629	oven lamp mounting ø 10mm 12V 10W socket G4 CONVOTHERM temp.-resist. 300°C	2628501

ELECTROLUX



fig.	Part No.	description	Ref. No.
1	359841	lamp socket socket G4 mounting ø 35,5 mm connection cable 3500mm	007105
1	359762	lamp socket socket G4 mounting ø 35,5 mm connection cable 350mm	0C1555
2	359764	lamp glass ø 44 mm	002627
3	359763	frame without socket	002626
4	359765	lamp holder ED ø 76mm ID ø 38mm	002628



fig.	Part No.	description	Ref. No.
1	359376	lamp socket E14	054320
2	359377	oven lamp glass H 30 mm ø 47 mm	054318



FAGE

fig.	Part No.	description	Ref. No.
1	359690	lamp socket E27 ø 52mm	PORLAM27
2	693486	glass panel L 81mm W 81mm thickness 4mm square	VETRO85

fig.	Part No.	description	Ref. No.
4	359415	gasket for oven lamp L 78mm W 62mm thickness 1mm graphite	12023532
5	359423	frame for oven lamp L 95mm W 80mm thickness 6mm	12024464

FAGOR

fig.	Part No.	description	Ref. No.
1	359432	lamp socket socket G4 25V H 18mm connection male faston 4,8mm	12019933
2	359433	gasket	12017827

FOINOX

fig.	Part No.	description	Ref. No.
1	359839	lamp socket G4 for halogen lamp	10867
2	359840	frame for oven lamp	—
3	359299	gasket for oven lamp L 91 mm W 77mm hole ø 3mm	10304

fig.	Part No.	description	Ref. No.
1	359432	lamp socket socket G4 25V H 18mm connection male faston 4,8mm	12019933
2	359428	reflector	12012053
3	359426	lamp glass L 38 mm W 38 mm thickness 3 mm	12016678

fig.	Part No.	description	Ref. No.
4	359296	lamp glass L 74 mm W 58 mm thickness 3 mm	10305
5	359297	frame L 95mm W 81mm thickness 6mm mounting distance 68/83mm	10306

fig.	Part No.	description	Ref. No.
4	359425	gasket for oven lamp L 71mm W 71mm thickness 1,5mm rubber	12020892
5	359424	frame L 75mm W 75mm mounting distance 61 mm	12012381

FORNITALIA

fig.	Part No.	description	Ref. No.
1	359369	lamp socket socket G4/G5.3/G6.35 24 V ø 17 mm H 10 mm connection cable 730mm	—
2	359495	frame without socket	65/65Z11
3	359496	halogen lamp GU5,3 12V 50W	K65/65

fig.	Part No.	description	Ref. No.
1	359295	lamp socket for halogen lamp 12V 20W G4 55 x 70mm cable length 135mm	12024545
2	359405	gasket L 95mm W 80mm thickness 2mm graphite hole ø 5mm	12023578
3	359408	glass panel L 74mm W 59mm thickness 3mm	12023668

fig.	Part No.	description	Ref. No.
4	359497	lamp glass ø 52 mm	K65/6509
5	359498	spring for lens	K65/6507



GEMINI FORNI



fig.	Part No.	description	Ref. No.
1	359698	lamp socket E14 L 100mm W 55mm connection male faston 6,3mm	550181
2	358122	gasket for bulb socket L 112mm W 68mm thickness 3mm silicone	233054
3	358123	lamp glass L 112 mm W 68 mm	233186



fig.	Part No.	description	Ref. No.
4	358119	frame for bulb socket L 118mm W 72mm mounting distance 143mm	233185

GIORIK

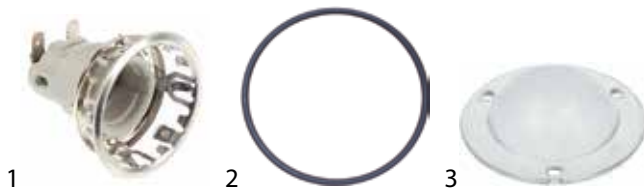

fig.	Part No.	description	Ref. No.
1	359499	lamp socket socket E14 mounting ϕ 47,8 mm connection male faston 6.3mm	—
2	532649	O-ring Viton thickness 2,62mm ID ϕ 63,17mm Qty 1 pcs	—
3	360552	borosilicate glass ϕ 88 mm H 28 mm thickness 4 mm	—



fig.	Part No.	description	Ref. No.
4	525313	O-ring Viton thickness 3,53mm ID ϕ 60,33mm Qty 1 pcs	—

HATCO



fig.	Part No.	description	Ref. No.
1	359500	lamp socket socket E27 250V ϕ 35mm H 38mm connection cable 250mm Qty 1 pcs	X02.30.102.00
2	359847	lamp socket E27 for HATCO heat bridge GR	02.30.044.00
3	359848	lamp socket E27 double for HATCO heat bridge GR	02.30.045.00

HOUNÖ



fig.	Part No.	description	Ref. No.
1	357092	lamp socket G4 ϕ 17mm H 9mm mounting distance 12mm with 2 hole fixing cord length 450mm	066019
2	360618	lamp glass with rubber gasket mounting ϕ 85 mm	20120131



fig.	Part No.	description	Ref. No.
1	357092	lamp socket G4 ϕ 17mm H 9mm mounting distance 12mm with 2 hole fixing cord length 450mm	066019
2	694503	gasket for lamp lenses ϕ 82mm hole ϕ 51mm	014575
3	694502	lamp glass metal glas with frame and gasket ϕ 85 mm	037519

IZMAK



fig.	Part No.	description	Ref. No.
1	357098	lamp socket E14 L 150mm H 45mm mounting distance 124mm	101011
2	694500	glass panel L 85mm W 85mm thickness 5mm	101012

LAINOX



fig.	Part No.	description	Ref. No.
1	359674	lamp socket socket G4 24V H 16mm connection cable 100mm mounting distance 20mm	LAR65270450
2	359670	lamp glass L 105 mm W 40 mm thickness 4 mm	LAR71500150
3	359671	gasket	LAR70044200
4	359672	frame	LAR11401450



fig.	Part No.	description	Ref. No.
1	359669	lamp socket G4 for halogen lamp	LAR50304510
2	357131	lamp socket socket G4 L 90mm W 65mm H 21mm connection cable 100mm mounting distance 20mm	LAR65270400
3	359667	reflector L 141mm	LAR10400150



4			
fig.	Part No.	description	Ref. No.
4	359668	gasket	LAR70040800

MKN

1		2		3	
fig.	Part No.	description	Ref. No.		
1	357184	lamp socket G4 ø 17 mm H 9 mm connection male faston 6,3mm	203678		
2	693050	gasket graphite D1 ø 71mm D2 ø 94mm thickness 1mm Qty 1 pcs suitable for MKN	211128		
3	694294	glass panel ø90mm thickness 8mm	216115		

OEM

1		2		3		4	
fig.	Part No.	description	Ref. No.				
1	359639	lamp socket E14 with grip fixing	EL06900				
2	698562	reflector L 120 mm W 108 mm H 33 mm ø 120 mm	QAT2200				
3	359700	gasket for pizza oven fibre glass ID ø 32,5 mm ED ø 55 mm thickness 5 mm	AL26600				
4	359661	oven lamp glass thread 32,1 ø 58 mm hard glas temp.-resist. 350 °C	AL20100				

1		2		3		4	
fig.	Part No.	description	Ref. No.				
1	359320	lamp socket socket G6,35 24V ø 16mm H 10mm connection male faston 6,3mm	EL05600				
2	698561	bracket for lamp L 178 mm W 98 mm H 40 mm	HAT6400				
3	698562	reflector L 120 mm W 108 mm H 33 mm ø 120 mm	QAT2200				
4	359700	gasket for pizza oven fibre glass ID ø 32,5 mm ED ø 55 mm thickness 5 mm	AL26600				

5			
fig.	Part No.	description	Ref. No.
5	359661	oven lamp glass thread 32,1 ø 58 mm hard glas temp.-resist. 350 °C	AL20100

1		2	
fig.	Part No.	description	Ref. No.
1	359320	lamp socket socket G6,35 24V ø 16mm H 10mm connection male faston 6,3mm	EL05600
2	359322	lamp holder for bulb socket	HAT5910

1		2		3	
fig.	Part No.	description	Ref. No.		
1	359639	lamp socket E14 with grip fixing	EL06900		
2	359323	lamp glass with gasket L 154 mm W 63 mm thickness 8 mm	AL04000		
3	359325	gasket	AL03220		

RATIONAL

1		2		3	
fig.	Part No.	description	Ref. No.		
1	359873	lamp socket G4 for halogen lamp	8514.1018		
2	359879	gasket	5110.1023		
3	359877	lamp glass L 95 mm W 72 mm thickness 4 mm	5201.1000		

4		5	
fig.	Part No.	description	Ref. No.
4	359880	gasket L 95mm W 72mm	5110.1022
5	359876	frame SS for lamp lenses	8514.1017

1		2		3	
fig.	Part No.	description	Ref. No.		
1	359874	lamp socket G4 for halogen lamp	40.00.098		
2	359881	gasket L 85mm W 70mm	40.00.094		
3	359878	lamp glass L 80 mm W 65 mm thickness 4 mm	40.00.095		

4		5	
fig.	Part No.	description	Ref. No.
4	359882	gasket L 81mm W 65mm	40.00.093
5	359875	lamp glass with gasket and frame	40.00.091



RETIGO



fig.	Part No.	description	Ref. No.
1	359922	lamp socket with 2 hole fixing 25 V socket G4 connection cable 140mm ø 17 mm H 10 mm	EA13-0101
2	357182	lamp glass ø 37 mm thickness 3 mm	AX07-0001
3	357183	gasket for bulb socket thickness 1,5mm ø 37mm graphite ID ø 31mm	AX07-0002



fig.	Part No.	description	Ref. No.
1	359922	lamp socket with 2 hole fixing 25 V socket G4 connection cable 140mm ø 17 mm H 10 mm	EA13-0101
2	680001	lamp glass ø 69 mm thickness 2,9 mm	AX07-0004
3	680000	gasket cavity lighting ø 92mm ID ø 58mm rubber thickness 7,6mm suitable for	AX07-0006

SALVA



fig.	Part No.	description	Ref. No.
1	359922	lamp socket with 2 hole fixing 25 V socket G4 connection cable 140mm ø 17 mm H 10 mm	—
2	357107	lamp glass L 126 mm W 37 mm thickness 4 mm	—

ZANOLLI



fig.	Part No.	description	Ref. No.
1	359666	lamp socket socket E27 250V ø 40mm H 46mm connection screw with fastening angle	ELET0227
2	693380	glass panel L 100mm W 100mm thickness 6mm square	CRIS0023



fig.	Part No.	description	Ref. No.
1	359664	lamp socket W 21 mm socket GU10 connection grip connection ø 17 mm H 12 mm	LAMP0021
2	359665	halogen lamp GU10 230V 50W	LAMP0037
3	693379	glass panel L 180mm W 90mm thickness 6mm rectangular	CRIS0006

lamps

light bulbs



fig.	Part No.	socket	volt. (V)	P (W)	t.max. (°C)
1	359610	E14	230	15	300
1	359740	E14	230	15	300
1	357153	E14	230	25	300
1	359612	E14	230	25	300
1	359448	E14	230	25	500
1	357099	E14	235	15	500
2	357118	E14	230/240	40	500
3	359615	E14	230	25	300
3	357154	E14	230	40	300
3	359611	E14	230	40	300
3	357100	E14	220-260	25	500
3	357101	E14	220-260	40	500
4	359613	E27	230	25	300
4	359614	E27	230	40	300
4	357102	E27	220-260	25	500
4	357103	E27	220-260	40	500



fig.	Part No.	socket	volt. (V)	P (W)	t.max. (°C)
5	359849	E27	230	60	-

halogen lamps

for socket E14 / E27



fig.	Part No.	socket	volt. (V)	P (W)	producer	Qty
1	359728	E14	230	40	-	1
2	359683	E27	240	60	-	1

for socket G4 / G6.35 / G9



fig.	Part No.	socket	volt. (V)	P (W)	Temp.Res. (°C)	producer
1	357188	G4	12	5	300	OSRAM
1	359579	G4	12	5	500	-
1	357189	G4	12	5	-	OSRAM
1	357191	G4	12	10	300	OSRAM
1	359596	G4	12	10	500	-
1	357190	G4	12	10	-	OSRAM
1	357193	G4	12	20	300	OSRAM
1	359599	G4	12	20	500	-
1	357192	G4	12	20	-	OSRAM
2	359074	G6.35	12	35	500	-

Table continues overleaf



3

fig.	Part No.	socket	volt. (V)	P (W)	Temp.Res. (°C)	producer
2	357194	G6.35	12	35	-	OSRAM
3	359945	G9	230	25	300	-
3	357195	G9	230	25	300	OSRAM
3	359946	G9	230	40	300	-
3	357196	G9	230	40	300	OSRAM

for socket GU5,3 / GU10



fig.	Part No.	socket	volt. (V)	P (W)	Temp.Res. (°C)
1	359665	GU10	230	50	-
2	357054	GU5.3	12	20	-
2	359496	GU5.3	12	50	-
3	359300	GZ5.3	235	25	400

sockets

G4 / G5,3 / G6,35





fig.	Part No.	socket	ø (mm)	H (mm)	MD (mm)	CL (mm)
1	359304	G4	17	9	12	120
1	357185	G4/G5.3/G6.35	17	9	12	750
2	359369	G4/G5.3/G6.35	17	10	11.5	730
3	359923	G4/G5.3/G6.35	17	10	26	140
3	359646	G4/G5.3/G6.35	17	15	26	130

E14



1

technical data:
diameter 43,5mm
connection screw

fig.	Part No.	H (mm)	MD (mm)
1	357130	46.5	-

E27



1 2 3

technical data:
connection screw

fig.	Part No.	ø (mm)	H (mm)	MD (mm)	fig.	Part No.	ø (mm)	H (mm)	MD (mm)
1	359917	45	56	-	2	359921	52	52	54
1	359918	45	63	-	3	359919	53	38	-

residual heat indicators



1 2

fig.	Part No.	version	volt. (V)	connection	mounting ø (mm)
1	359429		230	F6.3	18
2	357003	single	250	F6.3	14

hand lamps



1

fig.	Part No.	description
1	550441	inspection lamp cable PVC cable length 5m



2

fig.	Part No.	description
2	801398	torch LED 1 W ø 27 mm handle ø 19 mm L 155 mm



3

fig.	Part No.	description
3	801327	torch LED 1 W ø 35 mm handle ø 27 mm L 143 mm

GASTROPARTS.COM

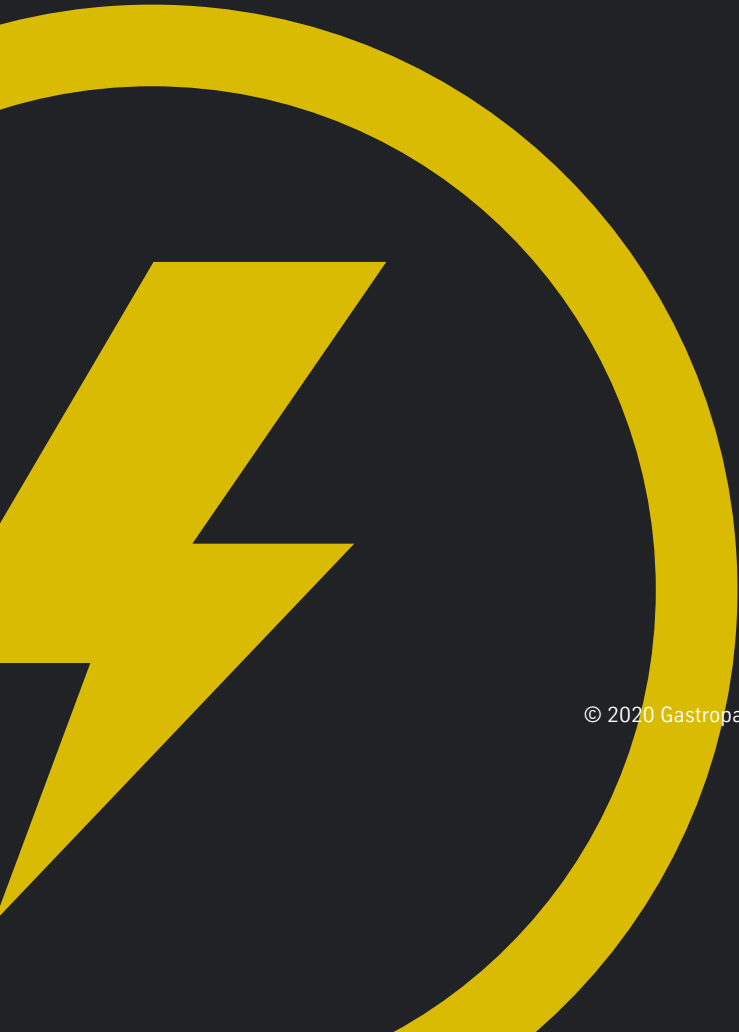

© 2020 Gastroparts Sp. J. All rights reserved.