



**GASTROPARTS**

Universal Catalogue › Electric Components ›

# [EN] Probes

[DE] Fühler

[ES] Sensores

[FR] Sondes

[IT] Sonda

[PL] Czujniki

[RU] Датчики

✉ [gastroparts@gastroparts.com](mailto:gastroparts@gastroparts.com)

☎ tel. +48 56 657 00 66

📘 [fb.com/gastroparts.global](https://fb.com/gastroparts.global)

**GASTROPARTS.COM**



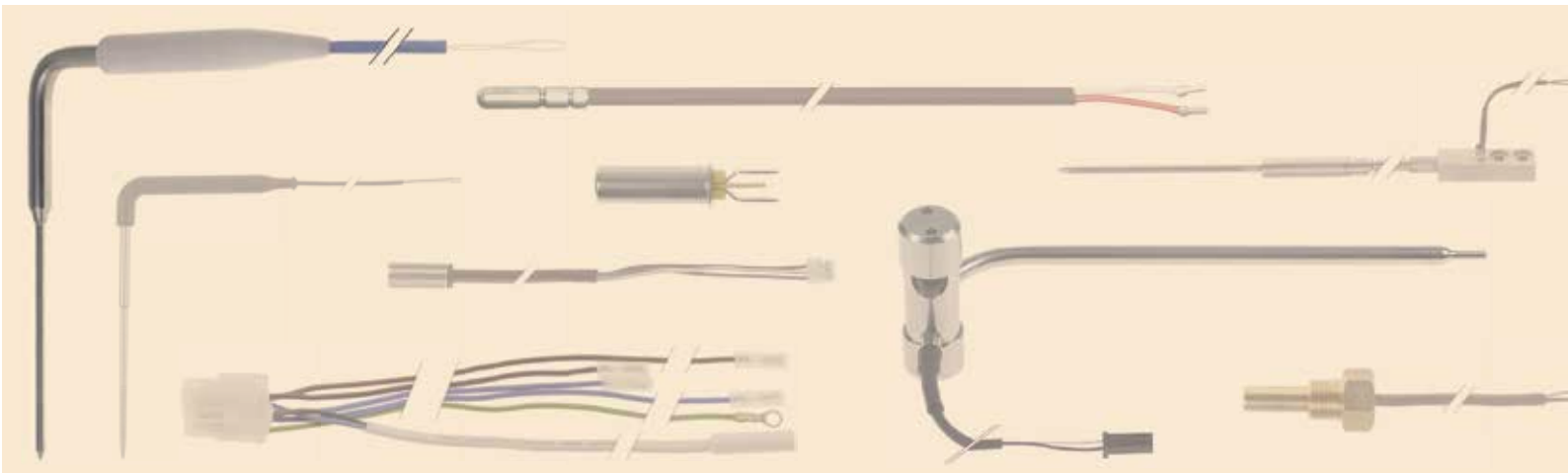

# probes

# 17

universal probes.	532
producer-specific probes.	536
Hall sensors.	576
sensors.	576
accessories.	577



## probes

## universal probes

## temperature probes

## NTC



fig.	Part No.	probe type	cable	probe temperature (°C)	probe	CL (m)
1	378292	NTC	silicone	-40 up to +110	ø6x95mm	3.9



fig.	Part No.	probe type	cable	probe temperature (°C)	probe	CL (m)
2	379342	NTC 10kOhm	PVC	-20 up to +80	ø6x25mm	1.5
2	379057	NTC 10kOhm	PVC	-20 up to +80	ø6x25mm	3
2	378194	NTC 10kOhm	PVC	-20 up to +80	ø7x24.5mm	1.5



fig.	Part No.	probe type	cable	probe temperature (°C)	probe	CL (m)
3	379860	NTC 10kOhm	PVC	-20 up to +80	ø6x40mm	1.5
3	379557	NTC 10kOhm	silicone	-40 up to +110	ø6x35mm	1.5
3	379458	NTC 10kOhm	silicone	-40 up to +110	ø6x40mm	1.5
3	379343	NTC 10kOhm	silicone	-40 up to +110	ø6x40mm	3



fig.	Part No.	probe type	cable	probe temperature (°C)	probe	CL (m)
4	379749	NTC 10kOhm	silicone	-40 up to +110	ø6x30mm	1.5



fig.	Part No.	probe type	cable	probe temperature (°C)	probe	CL (m)
5	379160	NTC 10kOhm	TP	-40 up to +110	ø6x14mm	1.5
5	379169	NTC 10kOhm	TP	-40 up to +110	ø6x14mm	2
5	379630	NTC 10kOhm	TP	-40 up to +110	ø6x14mm	2.5
5	379161	NTC 10kOhm	TP	-40 up to +110	ø6x14mm	3
5	379162	NTC 10kOhm	TP	-40 up to +110	ø6x14mm	6
5	378453	NTC 10kOhm	TP	-40 up to +110	ø6x14mm	7



fig.	Part No.	probe type	cable	probe temperature (°C)	probe	CL (m)
6	378261	NTC 10kOhm	TP	-40 up to +110	ø6x35mm	3
6	379784	NTC 2kOhm	TP	-40 up to +110	ø6x35mm	2



fig.	Part No.	probe type	cable	probe temperature (°C)	probe	CL (m)
7	379805	NTC 10kOhm	TPE	-40 up to +110	ø6x28mm	2
7	378454	NTC 2kOhm	TP	-40 up to +110	ø6x28mm	2.5

## PT100



fig.	Part No.	probe type	cable	probe temperature (°C)	probe	CL (m)
1	378073 <sup>1</sup>	Pt100	PTFE	-100 up to 450	ø6x100mm	2

<sup>1</sup>3-wire

fig.	Part No.	probe type	cable	probe temperature (°C)	probe	CL (m)
2	378072 <sup>1</sup>	Pt100	PTFE	-100 up to 450	ø6x50mm	1.5
2	379283 <sup>1</sup>	Pt100	silicone	-100 up to 450	ø6x60mm	2
2	378071 <sup>1</sup>	Pt100	silicone	-100 up to 450	ø6x60mm	10

<sup>1</sup>3-wire

fig.	Part No.	probe type	cable	probe temperature (°C)	probe	CL (m)
3	379438	Pt100	silicone	-100 up to 450	ø3x100mm	2.5



fig.	Part No.	probe type	cable	probe temperature (°C)	probe	CL (m)
4	379785	Pt100	silicone	-100 up to 450	ø6x100mm	1.5
4	379786	Pt100	silicone	-100 up to 450	ø6x100mm	3



fig.	Part No.	probe type	cable	probe temperature (°C)	probe	CL (m)
5	379058 <sup>1</sup>	Pt100	silicone	-100 up to 450	ø6x100mm	2.8

<sup>1</sup>3-wire

fig.	Part No.	probe type	cable	probe temperature (°C)	probe	CL (m)
6	379439	Pt100	silicone	-50 up to +250	ø6x50mm	2.5



fig.	Part No.	probe type	cable	probe temperature (°C)	probe	CL (m)
7	379222 <sup>1</sup>	Pt100	Vetrotex	-200 up to +600	ø4x110mm	1.4
7	379130 <sup>1</sup>	Pt100	Vetrotex	-200 up to +600	ø6x100mm	1.4
7	379787	Pt100	Vetrotex	-200 up to +600	ø6x100mm	1.4
7	379284 <sup>1</sup>	Pt100	Vetrotex	-200 up to +600	ø6x100mm	2
7	379050 <sup>1</sup>	Pt100	Vetrotex	-200 up to +600	ø6x100mm	2.7
7	379294	Pt100	Vetrotex	-200 up to +600	ø6x100mm	3

<sup>1</sup>3-wire

fig.	Part No.	probe type	cable	probe temperature (°C)	probe	CL (m)
8	379293	Pt100	Vetrotex	-200 up to +600	ø4x50mm	2

**PTC**

1 

fig.	Part No.	probe type	cable	probe temperature (°C)	probe	CL (m)
1	379142	PTC 1kOhm	PVC	-50 up to +150	ø6x30mm	1.5
1	379199	PTC 1kOhm	PVC	-50 up to +150	ø6x30mm	5
1	379637	PTC 1kOhm	PVC	-50 up to +150	ø6x35mm	2
1	379052	PTC 1kOhm	silicone	-50 up to +150	ø6x40mm	1.5
1	379064	PTC 1kOhm	silicone	-50 up to +150	ø6x40mm	3

2 

fig.	Part No.	probe type	cable	probe temperature (°C)	probe	CL (m)
2	379053	PTC 1kOhm	PVC	-50 up to +150	ø6x30mm	3

3 

fig.	Part No.	probe type	cable	probe temperature (°C)	probe	CL (m)
3	379783	PTC 1kOhm	PVC	-50 up to +150	ø6x35mm	2

4 

fig.	Part No.	probe type	cable	probe temperature (°C)	probe	CL (m)
4	379776	PTC 1kOhm	PVC	-50 up to +150	ø6x70mm	5

5 

fig.	Part No.	probe type	cable	probe temperature (°C)	probe	CL (m)
5	381222	PTC 1kOhm	silicone	-50 up to +150	ø6x30mm	3
5	378067	PTC 1kOhm	silicone	-50 up to +150	ø6x40mm	2
5	378068	PTC 1kOhm	silicone	-50 up to +150	ø6x40mm	7
5	378069	PTC 1kOhm	silicone	-50 up to +150	ø6x40mm	15
5	378070	PTC 1kOhm	silicone	-50 up to +150	ø6x40mm	30

6 

fig.	Part No.	probe type	cable	probe temperature (°C)	probe	CL (m)
6	379781	PTC 1kOhm	TP	-50 up to +150	ø6x14mm	1.5
6	379782	PTC 1kOhm	TP	-50 up to +150	ø6x14mm	3
6	381343	PTC 1kOhm	TP	-50 up to +150	ø6x14mm	4.8

**thermocouples J (Fe-CuNi)**

1 

fig.	Part No.	probe type	cable	probe temperature (°C)	probe	CL (m)
1	378074	J (Fe-CuNi)	Vetrotex	-50 up to +750	ø3x100mm	3

2 

fig.	Part No.	probe type	cable	probe temperature (°C)	probe	CL (m)
2	379831	J (Fe-CuNi)	Vetrotex	-50 up to +750	ø4x100mm	1

3 

fig.	Part No.	probe type	cable	probe temperature (°C)	probe	CL (m)
3	379693	J (Fe-CuNi)	Vetrotex	-50 up to +750	ø6x100mm	1.35

4 

fig.	Part No.	probe type	cable	probe temperature (°C)	probe	CL (m)
4	379051	J (Fe-CuNi)	Vetrotex	-50 up to +750	ø6x100mm	3
4	379062	J (Fe-CuNi)	Vetrotex	-50 up to +750	ø6x50mm	3

5 

fig.	Part No.	probe type	cable	probe temperature (°C)	probe	CL (m)
5	379063	J (Fe-CuNi)	Vetrotex	-50 up to +750	ø6x50mm	1.9

6 

fig.	Part No.	probe type	cable	probe temperature (°C)	probe	CL (m)
6	375051	thermocouple J	Vetrotex	-50 up to +750	ø4x150mm	1.5

**thermocouples K (NiCr-Ni)**

1 

fig.	Part No.	probe type	cable	probe temperature (°C)	probe	CL (m)
1	379434	K (NiCr-Ni)	silicone	-50 up to 1150	ø3x100mm	2.5
1	378075	K (NiCr-Ni)	Vetrotex	-50 up to 1150	ø4.5x150mm	3

**humidity probes**



1  2 

fig.	Part No.	humidity range	supply (VDC)	outlet	probe	CL (m)
1	403390	0-99	9-28	4-20mA	ø17.5x120mm	
2	379174	10-95	8-35	4-20mA	ø17.5x120mm	



3  4 

fig.	Part No.	humidity range	supply (VDC)	outlet	probe	CL (m)
3	378383	15-90	8-28	4-20mA	ø24x105mm	1.5
4	378076	5-95	8-24	4-20mA	ø20x180mm	1.5

**pressure probes**

1 

fig.	Part No.	pressure (bar)	supply (VDC)	outlet	TS	CL (m)
1	378381	0.5-8	8 - 32	4-20mA	1/4"	2
1	378382	0-30	8 - 32	4-20mA	1/4"	2



2



fig.	Part No.	pressure (bar)	supply (VDC)	outlet	TS	CL (m)
2	379118	0.5-8	8-28	4-20mA	7/16"	2
2	379119	0-30	8-28	4-20mA	7/16"	2

## core probes

1

2



fig.	Part No.	probe type	cable	probe temperature (°C)	probe	CL (m)
1	379529	J (Fe-CuNi)	PTFE	-50 up to +750	ø4x120mm	1.9
2	378391	NTC 10kOhm	PVC	-40 up to +120	ø4x100mm	5
2	378393	Pt100	PVC	-40 up to +120	ø4x100mm	5
2	378392	Pt1000	PVC	-40 up to +120	ø4x100mm	5
2	378390	PTC 1kOhm	PVC	-50 up to +150	ø4x100mm	5

3

4



fig.	Part No.	probe type	cable	probe temperature (°C)	probe	CL (m)
3	378066	NTC 10kOhm	silicone	-40 up to +110	ø4-6x100mm	1.5
4	379985	Pt100	PTFE	-40 up to +250	ø4x100mm	3

5

6

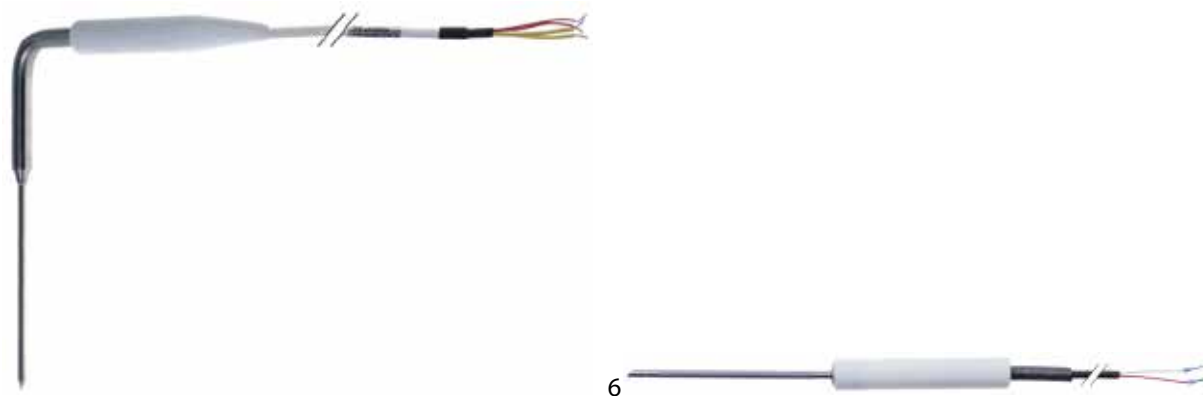

fig.	Part No.	probe type	cable	probe temperature (°C)	probe	CL (m)
5	378396 <sup>1</sup>	Pt100	PVC	-40 up to +120	ø4x100mm	5
5	378395 <sup>1</sup>	Pt1000	PVC	-40 up to +120	ø4x100mm	5
5	378394 <sup>1</sup>	PTC 1kOhm	PVC	-40 up to +120	ø4x100mm	5
6	379344	Pt100	silicone	-40 up to +120	ø4x100mm	5

<sup>1</sup>heated

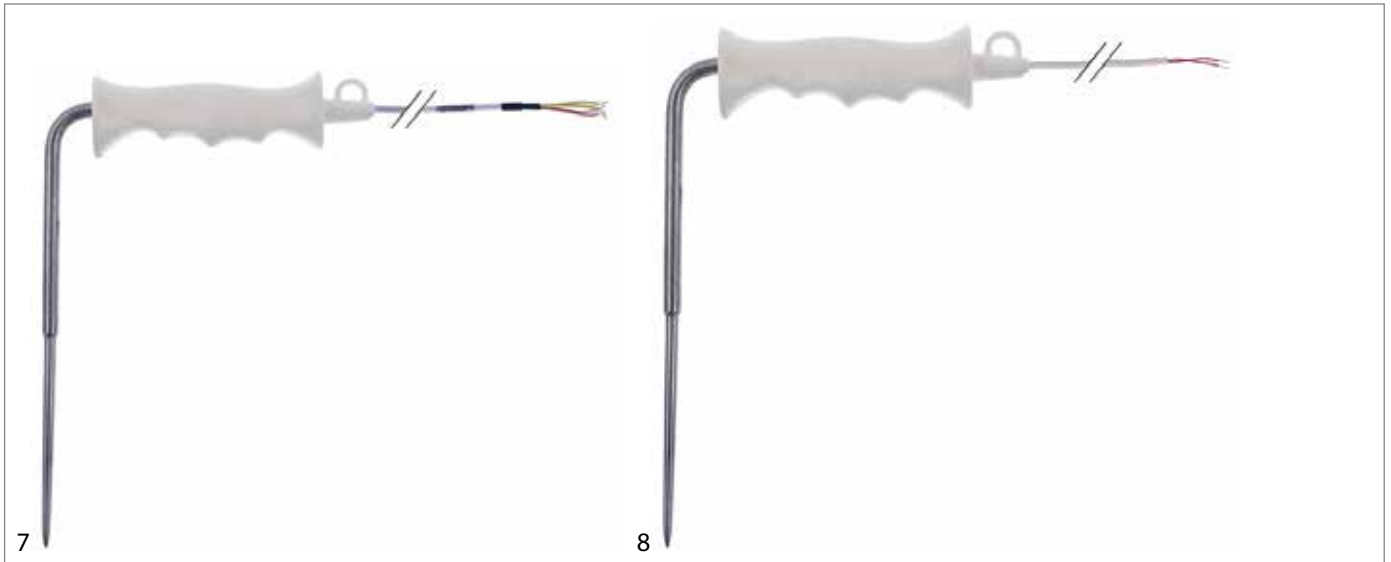

fig.	Part No.	probe type	cable	probe temperature (°C)	probe	CL (m)
7	378398 <sup>1,2</sup>	PTC 1kOhm	fully insulated	-40 up to +120	ø5.5x100mm	5
8	378397 <sup>1</sup>	PTC 1kOhm	PVC	-40 up to +120	ø5.5x100mm	5

<sup>1</sup>with conical tip <sup>2</sup>heated

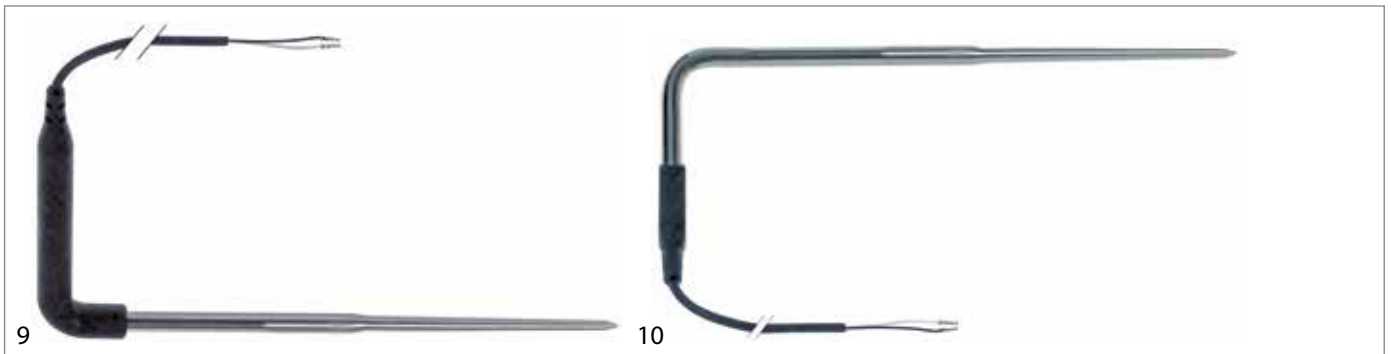

fig.	Part No.	probe type	cable	probe temperature (°C)	probe	CL (m)
9	379549	PTC 1kOhm	PVC	-50 up to +150	ø6x110mm	3.5
10	379687	PTC 1kOhm	silicone	-50 up to +150	ø6x110mm	2.2



fig.	Part No.	probe type	cable	probe temperature (°C)	probe	CL (m)
11	379640	PTC 1kOhm	silicone	-50 up to +150	ø6x110mm	2.4



## producer-specific probes

## probes

## ACP

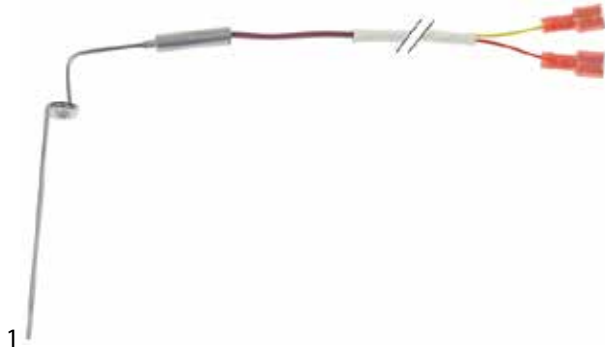

fig.	GEV No.	probe type	cable	probe temperature (°C)	connection	TS	probe	CL (m)	Ref. No.
1	107580	K (NiCr-Ni)	PTFE	-50 up to 1150	F6.3	-	ø1.6x75mm	0.55	59002131
2	378368	Pt100	glass fibre	-100 up to 450	coded plug	-	ø4.8x24mm	0.1	12000202



fig.	Part No.	probe type	cable	probe temperature (°C)	connection	TS	probe	CL (m)	Ref. No.
3	378369	Pt100	PTFE	-100 up to 450	coded plug	-	ø4.8x160mm	0.17	59001709

## Afnox



fig.	Part No.	probe type	cable	probe temperature (°C)	connection	TS	probe	CL (m)	Ref. No.
1	403511	PTC	silicone	-50 up to +150	2-wire	-	ø5.9x29mm	2.95	74700999

## Amana



fig.	Part No.	probe type	cable	probe temperature (°C)	connection	TS	probe	CL (m)	Ref. No.
1	378368	Pt100	glass fibre	-100 up to 450	coded plug	-	ø4.8x24mm	0.1	12000201

## Ambach



fig.	Part No.	probe type	cable	probe temperature (°C)	connection	TS	probe	CL (m)	Ref. No.
1	379099	J (Fe-CuNi)	Vetrotex	-50 up to +750	2-wire	-	ø4.5x50mm	1.4	5024107164
2	379143	Pt100	Vetrotex	-200 up to +600	2-wire	-	ø3-6x90mm	5	R65325000



**Angelo-Po**

fig.	Part No.	probe type	cable	probe temperature (°C)	connection	TS	probe	CL (m)	Ref. No.
1	379910	J (Fe-CuNi)	silicone	-50 up to 1150	F2.8	M10x1	ø4/6x72mm	0.6	32V0030
2	379932	Pt100	silicone	-100 up to 450	3-wire	M10x1	ø3x130mm	1.5	32Z6041
2	379934	Pt100	silicone	-100 up to 450	3-wire	M10x1	ø3x65mm	0.65	32Z6191

fig.	Part No.	probe type	cable	probe temperature (°C)	connection	TS	probe	CL (m)	Ref. No.
3	379931	Pt100	Vetrotex	-200 up to +600	3-wire	M10x1	ø4x85mm	0.8	32Z6780
4	379331	Pt1000	PTFE	-70 up to +500	2-wire	M10x1	ø3x60mm	0.7	32V5750

**Animo**

fig.	Part No.	probe type	cable	probe temperature (°C)	connection	TS	probe	CL (m)	Ref. No.
1	400606	NTC 4.8kOhm	-	-40 up to +110	F2.8	-	ø10x30mm	-	02219

**Anitec**

fig.	Part No.	probe type	cable	probe temperature (°C)	connection	TS	probe	CL (m)	Ref. No.
1	402191	PTC 2kOhm	TPE	-50 up to +150	plug	-	ø5x20mm	1.8	FR.62040411
2	402005	PTC 2kOhm	TPE	-50 up to +150	plug	-	ø6x50mm	1.6	FR.62040410

**Baron**

fig.	Part No.	probe type	cable	probe temperature (°C)	connection	TS	probe	CL (m)	Ref. No.
1	379936	Pt100	Vetrotex	-200 up to +600	2-wire	-	ø4-6x100mm	1	BN3103275
2	379935	Pt100	Vetrotex	-200 up to +600	2-wire	-	ø6x100mm	0.8	BN3103270

**Bartscher**

fig.	Part No.	probe type	cable	probe temperature (°C)	connection	TS	probe	CL (m)	Ref. No.
1	379887	Pt100	glass fibre	-200 up to +600	2-wire	M10x1.5	ø5x42mm	1.9	0SON006





## Bertos

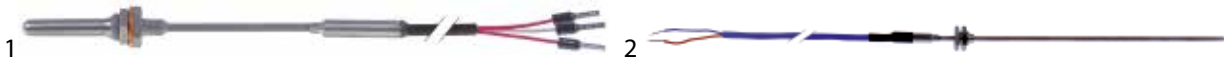

fig.	Part No.	probe type	cable	probe temperature (°C)	connection	TS	probe	CL (m)	Ref. No.
1	402154	Pt100	silicone	-100 up to +450	3-wire	1/8"	ø6x35mm	1.5	—
2	379952	T (Cu-CuNi)	silicone	-150 up to +300	2-wire		ø3x200mm	1	25076800

## Blue Seal



fig.	Part No.	probe type	cable	probe temperature (°C)	connection	TS	probe	CL (m)	Ref. No.
1	348017	Pt1000	Vetrotex	-70 up to +500	plug	-	ø4x40mm	1	234434

## Bonamat



fig.	Part No.	probe type	cable	probe temperature (°C)	connection	TS	probe	CL (m)	Ref. No.
1	379500	NTC 1kOhm	PVC	-40 up to +110	F2.8	-	eye M3	0.3	6.236.188.000
2	379697	PTC	-	-50 up to +150	F2.8	1/4"	ø6.2x7mm	-	6.000.236.017

## Bourgeois



fig.	Part No.	probe type	cable	probe temperature (°C)	connection	TS	probe	CL (m)	Ref. No.
1	400803	J (Fe-CuNi)	glass fibre	-50 up to +750	3-wire	M8	ø5x20mm	2.4	REGU104

## Capic



fig.	Part No.	probe type	cable	probe temperature (°C)	connection	TS	probe	CL (m)	Ref. No.
1	379635	J (Fe-CuNi)	Vetrotex	-50 up to +750	2-wire	-	ø5x100mm	2	E403514

## Carimali



fig.	Part No.	probe type	cable	probe temperature (°C)	connection	TS	probe	CL (m)	Ref. No.
1	526337	NTC 47kOhm	PTFE	-40 up to +125	plug	1/4"	ø6.5x25mm	0.24	87.00087

## Charvet



fig.	Part No.	probe type	cable	probe temperature (°C)	connection	TS	probe	CL (m)	Ref. No.
1	379824	K (NiCr-Ni)	Vetrotex	-50 up to +1150	2-wire	-	ø4x65mm	2.35	07666A



Colged



fig.	Part No.	probe type	cable	probe temperature (°C)	connection	TS	probe	CL (m)	Ref. No.
1	379101	NTC 10kOhm	PVC	-40 up to +110	plug	-	ø4.5x30mm	0.35	DWS100

Comenda



fig.	Part No.	probe type	cable	probe temperature (°C)	connection	TS	probe	CL (m)	Ref. No.
1	379904	NTC 100kOhm	silicone	-40 up to +125	2-wire	-	ø7x25mm	2.1	120952
2	378006	NTC 40kOhm	PVC	-40 up to +110	F6.3	-	ø4x20mm	0.25	120960



fig.	Part No.	probe type	cable	probe temperature (°C)	connection	TS	probe	CL (m)	Ref. No.
3	378341	Pt100	silicone	-50 up to +200	coded plug	-	ø6x50mm	6.85	120929
4	379903	PTC 1kOhm	silicone	-50 up to +150	F6.3	-	ø6x60mm	2.3	120913

Convothem

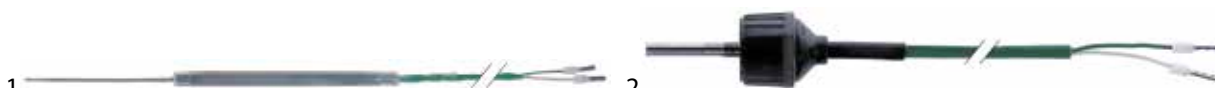

fig.	Part No.	probe type	cable	probe temperature (°C)	connection	TS	probe	CL (m)	Ref. No.
1	379414	K (NiCr-Ni)	PTFE	-50 up to 1150	2-wire	-	ø1.5x60mm	4	2219137
2	379800	K (NiCr-Ni)	silicone	-50 up to 1150	2-wire	M5	ø4x20mm	3	5002100K

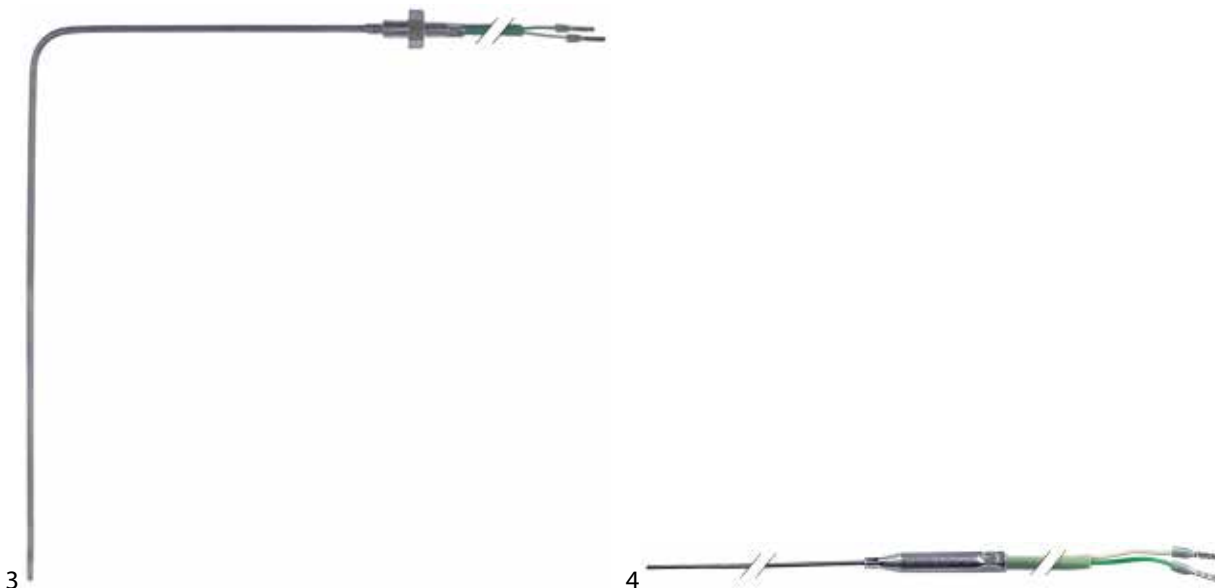
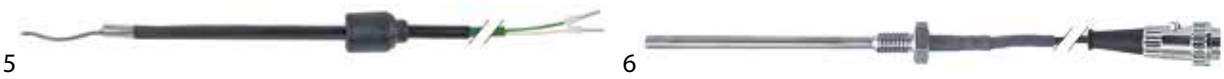



fig.	Part No.	probe type	cable	probe temperature (°C)	connection	TS	probe	CL (m)	Ref. No.
3	402164	K (NiCr-Ni)	silicone	-50 up to 1150	2-wire	M8	ø3x130/230mm	2.1	5002102K
4	379536	K (NiCr-Ni)	silicone	-50 up to 1150	2-wire	-	ø1.5x230mm	2	5016003





									
5	6								
fig.	Part No.	probe type	cable	probe temperature (°C)	connection	TS	probe	CL (m)	Ref. No.
5	379440	K (NiCr-Ni)	silicone	-50 up to 1150	2-wire	-	∅1.5x35mm	1.6	5002103
5	379751	K (NiCr-Ni)	silicone	-50 up to 1150	2-wire	-	∅1.5x35mm	2.8	5002104
6	400024	NTC 100kOhm	PVC	-40 up to +125	plug	M10	∅6x120mm	0.1	5009050

									
7	8								
fig.	Part No.	probe type	cable	probe temperature (°C)	connection	TS	probe	CL (m)	Ref. No.
7	379104	Pt100	silicone	-100 up to 450	2-wire	M10	∅4.5x20mm	3	5009052
8	379105	Pt100	silicone	-100 up to 450	2-wire	M14x1.5	∅3x220mm	2.2	5001023

Cookmax

									
1	2								
fig.	Part No.	probe type	cable	probe temperature (°C)	connection	TS	probe	CL (m)	Ref. No.
1	379753	NTC	PVC	-40 up to +110	2-wire	M15x1.75	∅8x29mm	3.1	9590088
2	402078	NTC 10kOhm	-	-40 up to +110	F6.3	1/4"	∅10x25mm	-	094872

									
3	4								
fig.	Part No.	probe type	cable	probe temperature (°C)	connection	TS	probe	CL (m)	Ref. No.
3	379002	NTC 10kOhm	silicone	-40 up to +110	2-wire	-	∅3x20mm	0.3	—
4	379521	Pt100	glass fibre	-100 up to 450	coded plug	-	∅3.5x10mm	0.2	FH-HZA070WRE0

									
5	6								
fig.	Part No.	probe type	cable	probe temperature (°C)	connection	TS	probe	CL (m)	Ref. No.
5	379143	Pt100	Vetrotex	-200 up to +600	2-wire	-	∅3-6x90mm	5	R65325000
6	402105	PTC 2kOhm	-	-50 up to +150	F2.8	-	∅10x30mm	-	1011296

Cuppone

									
1									
fig.	Part No.	probe type	cable	probe temperature (°C)	connection	TS	probe	CL (m)	Ref. No.
1	379598	K (NiCr-Ni)	Vetrotex	-50 up to 1150	2-wire	-	∅3x200mm	1.5	91310215



Dühr



fig.	Part No.	probe type	cable	probe temperature (°C)	connection	TS	probe	CL (m)	Ref. No.
1	378347	2x NTC 10K	silicone	-40 up to +110	coded plug	M10x1	ø6x15/32mm	3	DW590104
2	378268	NTC	silicone	-40 up to +110	coded plug	-	ø6x15mm	1.1	DW50563
2	378248	NTC 10kOhm	PVC	-40 up to +110	coded plug	-	ø6x14mm	2	DW50562
2	378312	NTC 10kOhm	PVC	-40 up to +110	coded plug	-	ø6x14mm	3.5	DW392047/A

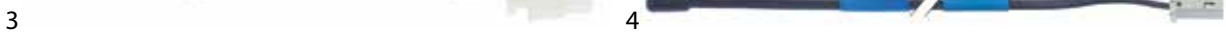

fig.	Part No.	probe type	cable	probe temperature (°C)	connection	TS	probe	CL (m)	Ref. No.
3	378314	NTC 10kOhm	silicone	-40 up to +110	coded plug	-	ø5x30mm	0.35	DW3006165
4	378313	NTC 10kOhm	silicone	-40 up to +110	coded plug	-	ø6x14mm	3	DW392047

Ecomax



fig.	Part No.	probe type	cable	probe temperature (°C)	connection	TS	probe	CL (m)	Ref. No.
1	402905	NTC 10kOhm	PVC	-40 up to +110	coded plug	-	ø5x35mm	0.2	775612-1

Electrolux



fig.	Part No.	probe type	cable	probe temperature (°C)	connection	TS	probe	CL (m)	Ref. No.
1	379146	J (Fe-CuNi)	Vetrotex	-50 up to +750	2-wire	1/2"	ø6x5mm	2	0H6247
2	379717	K (NiCr-Ni)	PTFE	-50 up to 1150	plug	-	ø4x70mm	1.1	0C6539
2	379715	K (NiCr-Ni)	PVC	-50 up to 1150	plug	-	ø4x70mm	0.5	0C6538
2	379716	K (NiCr-Ni)	PVC	-50 up to 1150	plug	-	ø4x70mm	0.85	0C0325
2	379889	K (NiCr-Ni)	PVC	-50 up to 1150	plug	-	ø4x70mm	2	0C3457



fig.	Part No.	probe type	cable	probe temperature (°C)	connection	TS	probe	CL (m)	Ref. No.
3	379092	K (NiCr-Ni)	silicone	-50 up to 1150	2-wire	-	ø4x20mm	2.6	0K5055
4	379513	NTC	PVC	-40 up to +110	2-wire	-	ø6x40mm	1.5	092178

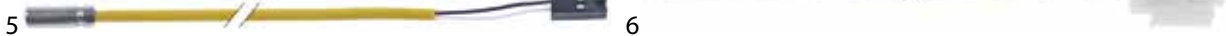

fig.	Part No.	probe type	cable	probe temperature (°C)	connection	TS	probe	CL (m)	Ref. No.
5	378334	NTC	PVC	-40 up to +110	coded plug	-	ø6x19mm	3.2	093442
6	378337	NTC	PVC	-40 up to +110	coded plug	-	ø6x30mm	5	0E5482







fig.	Part No.	probe type	cable	probe temperature (°C)	connection	TS	probe	CL (m)	Ref. No.
7	379733	NTC	silicone	-40 up to +110	2-wire	-	ø6x19mm	4	087130
8	381255	NTC	silicone	-40 up to +110	plug	-	ø5.9x40mm	1.5	092180





fig.	Part No.	probe type	cable	probe temperature (°C)	connection	TS	probe	CL (m)	Ref. No.
9	400714	NTC 100kOhm	PVC	-40 up to +125	male faston	-	ø7x25mm	3	087346
10	402200	NTC 10kOhm	PVC	-40 up to +110	2-wire	-	ø6x200mm	2	092174





fig.	Part No.	probe type	cable	probe temperature (°C)	connection	TS	probe	CL (m)	Ref. No.
11	402155	NTC 10kOhm	PVC	-40 up to +110	plug	-	ø6x20mm	2	092177
12	379734	NTC 10kOhm	silicone	-40 up to +110	plug	-	ø6x19mm	2	092188





fig.	Part No.	probe type	cable	probe temperature (°C)	connection	TS	probe	CL (m)	Ref. No.
13	379902	NTC 4.8kOhm	-	-40 up to +110	F6.3	-	ø10x30mm	-	049643
14	379901	NTC 4.8kOhm	PVC	-40 up to +110	F6.3	-	ø6x50mm	0.1	049884





fig.	Part No.	probe type	cable	probe temperature (°C)	connection	TS	probe	CL (m)	Ref. No.
15	379921	Pt100	PTFE	-100 up to +450	3-wire	M8	ø4x20mm	1.5	058953
16	401398	Pt100	silicone	-50 up to +250	F6.3	M10x1	ø10x10mm	0.07	0H6477





fig.	Part No.	probe type	cable	probe temperature (°C)	connection	TS	probe	CL (m)	Ref. No.
17	378336	Pt1000	silicone	-50 up to +200	bullet receptacle ø2mm	-	ø10x30mm	8	0K7575
18	378335	Pt1000	silicone	-50 up to +200	coded plug	-	ø6x50mm	6	0E5990





fig.	Part No.	probe type	cable	probe temperature (°C)	connection	TS	probe	CL (m)	Ref. No.
19	379100	Pt1000	silicone	-70 up to +500	F4.8	-	ø4x235mm	1.8	0C5342
20	402006	PTC 2kOhm	PVC	-50 up to +150	plug	-	ø5x60mm	1.5	086369





fig.	Part No.	probe type	cable	probe temperature (°C)	connection	TS	probe	CL (m)	Ref. No.
21	402008	PTC 2kOhm	PVC	-50 up to +150	plug	-	ø6x50mm	1.2	086341
22	402191	PTC 2kOhm	TPE	-50 up to +150	plug	-	ø5x20mm	1.8	0KM745



fig.	Part No.	probe type	cable	probe temperature (°C)	connection	TS	probe	CL (m)	Ref. No.
23	402005	PTC 2kOhm	TPE	-50 up to +150	plug	-	ø6x50mm	1.6	086344

Elettrobar



fig.	Part No.	probe type	cable	probe temperature (°C)	connection	TS	probe	CL (m)	Ref. No.
1	379101	NTC 10kOhm	PVC	-40 up to +110	plug	-	ø4.5x30mm	0.35	231006

Elframo



fig.	Part No.	probe type	cable	probe temperature (°C)	connection	TS	probe	CL (m)	Ref. No.
1	378361	GCPTP-51F	PTFE	-	F6.3	-	20mm	24.5	00590021
2	378343	NTC 10kOhm	silicone	-40 up to +110	2-wire	-	ø7x30mm	1	25192400

Eloma



fig.	Part No.	probe type	cable	probe temperature (°C)	connection	TS	probe	CL (m)	Ref. No.
1	379087	K (NiCr-Ni)	silicone	-50 up to 1150	F2.8	-	ø1x30mm	1.6	ELE316004
2	379086	K (NiCr-Ni)	silicone	-50 up to 1150	male faston	-	ø1x30mm	1.2	ELE316003



fig.	Part No.	probe type	cable	probe temperature (°C)	connection	TS	probe	CL (m)	Ref. No.
3	379088	Pt100	silicone	-100 up to 450	2-wire	-	ø3.2x28mm	1.1	E0431

Expobar



fig.	Part No.	probe type	cable	probe temperature (°C)	connection	TS	probe	CL (m)	Ref. No.
1	379452	NTC	glass fibre	-40 up to +125	plug	1/4"	ø3.5x20mm	0.24	60100076

Faema



fig.	Part No.	probe type	cable	probe temperature (°C)	connection	TS	probe	CL (m)	Ref. No.
1	400082	NTC 10kOhm	-	-40 up to +110	F6.3	-	ø10x30mm	-	3761117825



## Fagor



fig.	Part No.	probe type	cable	probe temperature (°C)	connection	TS	probe	CL (m)	Ref. No.
1	400874	J (Fe-CuNi)	PTFE	-50 up to +750	male faston	-	ø3x70mm	1.5	12018718
2	379489	J (Fe-CuNi)	PTFE	-50 up to +750	male faston	-	ø4x120mm	1.85	12024649



fig.	Part No.	probe type	cable	probe temperature (°C)	connection	TS	probe	CL (m)	Ref. No.
3	400873	J (Fe-CuNi)	PTFE	-50 up to 1150	2-wire	-	ø3x70mm	2.5	12018312
4	379525	K (NiCr-Ni)	PTFE	-50 up to 1150	F6.3	-	ø3x70mm	1	12024642
4	379528	K (NiCr-Ni)	PTFE	-50 up to 1150	male faston	-	ø3x70mm	1.6	12023901



fig.	Part No.	probe type	cable	probe temperature (°C)	connection	TS	probe	CL (m)	Ref. No.
5	379078	K (NiCr-Ni)	silicone	-50 up to 1150	2-wire	-	ø1.5x100mm	1.8	12031553
6	379429	K (NiCr-Ni)	silicone	-50 up to 1150	2-wire	-	ø10.5mm	1.7	12030579

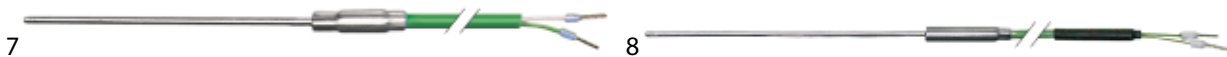

fig.	Part No.	probe type	cable	probe temperature (°C)	connection	TS	probe	CL (m)	Ref. No.
7	379121	K (NiCr-Ni)	silicone	-50 up to 1150	2-wire	-	ø2x100mm	0.25	12031446
8	379076	K (NiCr-Ni)	silicone	-50 up to 1150	2-wire	-	ø2x100mm	2	12029772
8	379124	K (NiCr-Ni)	silicone	-50 up to 1150	2-wire	-	ø2x100mm	2.2	12038044

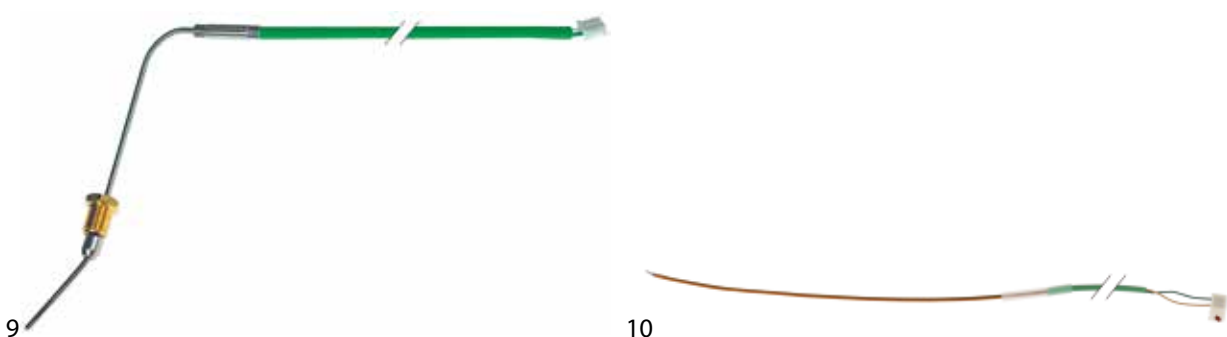

fig.	Part No.	probe type	cable	probe temperature (°C)	connection	TS	probe	CL (m)	Ref. No.
9	379864	K (NiCr-Ni)	silicone	-50 up to 1150	coded plug	M8	ø2x50mm	1.2	12029713
10	379873	K (NiCr-Ni)	silicone	-50 up to 1150	coded plug	-	ø1.5x180mm	1.6	12031261

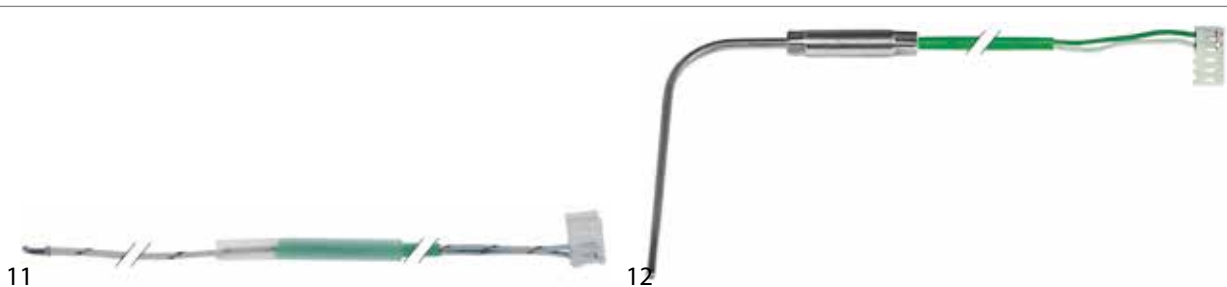

fig.	Part No.	probe type	cable	probe temperature (°C)	connection	TS	probe	CL (m)	Ref. No.
11	379441	K (NiCr-Ni)	silicone	-50 up to 1150	coded plug	-	ø2x125mm	1.5	12031482
11	379442	K (NiCr-Ni)	silicone	-50 up to 1150	coded plug	-	ø2x90mm	1.5	12040500
12	379869	K (NiCr-Ni)	silicone	-50 up to 1150	coded plug	-	ø2x70mm	2.5	12029188







fig.	Part No.	probe type	cable	probe temperature (°C)	connection	TS	probe	CL (m)	Ref. No.
13	379870	K (NiCr-Ni)	silicone	-50 up to +1150	coded plug	-	ø4.2mm	1.7	12033003
14	379550	NTC 10kOhm	silicone	-40 up to +110	male faston	-	ø6x30mm	0.35	12019258



fig.	Part No.	probe type	cable	probe temperature (°C)	connection	TS	probe	CL (m)	Ref. No.
15	378339	NTC 64kOhm	silicone	-40 up to +110	plug	-	ø6x14mm	2.5	12025036
16	379554	PTC	silicone	-50 up to +150	plug-in connection	-	ø4x13mm	0.05	12020413



fig.	Part No.	probe type	cable	probe temperature (°C)	connection	TS	probe	CL (m)	Ref. No.
17	402005	PTC 2kOhm	TPE	-50 up to +150	plug	-	ø6x50mm	1.6	62040410

Falcon



fig.	Part No.	probe type	cable	probe temperature (°C)	connection	TS	probe	CL (m)	Ref. No.
1	379087	K (NiCr-Ni)	silicone	-50 up to +1150	F2.8	-	ø1x30mm	1.6	530570621
2	378319	K (NiCr-Ni)	Vetrotex	-50 up to +1150	2-wire	M10x1	ø5x280mm	0.55	734510020



fig.	Part No.	probe type	cable	probe temperature (°C)	connection	TS	probe	CL (m)	Ref. No.
3	378325	NTC	Vetrotex	-40 up to +110	2-wire	1/8"	ø4.7x90mm	0.5	534510260
4	378324	NTC	Vetrotex	-40 up to +110	2-wire	1/8"	ø5x100mm	0.4	734310370

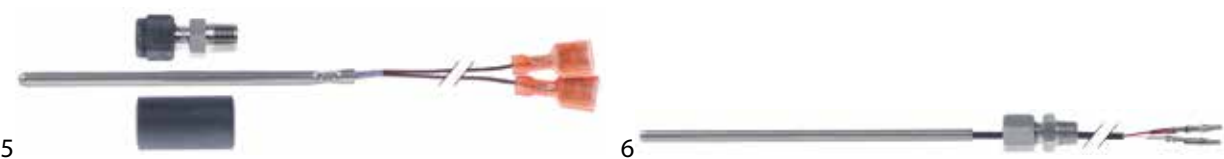

fig.	Part No.	probe type	cable	probe temperature (°C)	connection	TS	probe	CL (m)	Ref. No.
5	378320	NTC 100kOhm	glass fibre	-40 up to +125	F6.3	-	ø5x100mm	0.35	536430024
6	378317	NTC 100kOhm	PTFE	-40 up to +110	2-wire	M10x1.25	ø5x128mm	0.35	536300034



fig.	Part No.	probe type	cable	probe temperature (°C)	connection	TS	probe	CL (m)	Ref. No.
7	378318	NTC 100kOhm	PVC	-40 up to +110	2-wire	-	ø5x300mm	1	731350020





## Fornitalia



fig.	Part No.	probe type	cable	probe temperature (°C)	connection	TS	probe	CL (m)	Ref. No.
1	379930	K (NiCr-Ni)	Vetrotex	-50 up to 1150	2-wire	-	ø3x100mm	3.2	65/65Z25

## Foster



fig.	Part No.	probe type	cable	probe temperature (°C)	connection	TS	probe	CL (m)	Ref. No.
1	378451	PTC 1kOhm	PVC	-50 up to +150	plug	-	ø6x35mm	1.5	00-554473

## Franke



fig.	Part No.	probe type	cable	probe temperature (°C)	connection	TS	probe	CL (m)	Ref. No.
1	379879	NTC 900kOhm	silicone	-40 up to +150	male faston	-	ø6x80/170mm	0.65	BK178611

## Frenox



fig.	Part No.	probe type	cable	probe temperature (°C)	connection	TS	probe	CL (m)	Ref. No.
1	381249	NTC 10kOhm	PVC	-40 up to +110	2-wire	-	ø6x14mm	3	A00DJ109

## FriFri



fig.	Part No.	probe type	cable	probe temperature (°C)	connection	TS	probe	CL (m)	Ref. No.
1	379909	K (NiCr-Ni)	Vetrotex	-50 up to 1150	3-wire	-	ø5x120/300mm	1.5	214176

## Frymaster

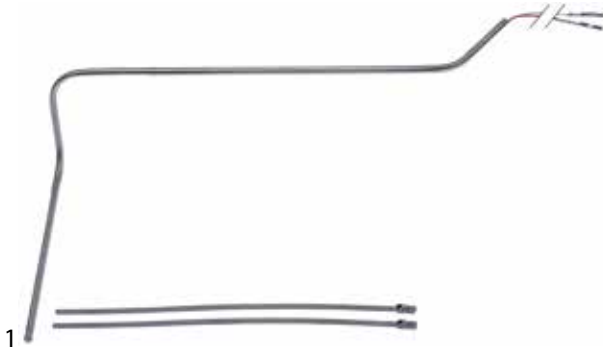

fig.	Part No.	probe type	cable	probe temperature (°C)	connection	TS	probe	CL (m)	Ref. No.
1	379819	PTC 1kOhm	PVC	-50 up to +150	2-wire	-	ø5x280mm	0.6	8261526



**Garbin**



fig.	Part No.	probe type	cable	probe temperature (°C)	connection	TS	probe	CL (m)	Ref. No.
1	379887	Pt100	glass fibre	-200 up to +600	2-wire	M10x1.5	ø5x42mm	1.9	SON006

**Gico**



fig.	Part No.	probe type	cable	probe temperature (°C)	connection	TS	probe	CL (m)	Ref. No.
1	400261	Pt100	Vetrotex	-100 up to 450	3-wire	-	ø6x80mm	1	A00317

**GIGA**





fig.	Part No.	probe type	cable	probe temperature (°C)	connection	TS	probe	CL (m)	Ref. No.
1	378332	NTC 10kOhm	silicone	-40 up to +110	2-wire	-	ø6x50mm	2.5	SD909025
2	402006	PTC 2kOhm	PVC	-50 up to +150	plug	-	ø5x60mm	1.5	I62040406





fig.	Part No.	probe type	cable	probe temperature (°C)	connection	TS	probe	CL (m)	Ref. No.
3	402008	PTC 2kOhm	PVC	-50 up to +150	plug	-	ø6x50mm	1.2	I62040402
4	402191	PTC 2kOhm	TPE	-50 up to +150	plug	-	ø5x20mm	1.8	I62040401

**Hobart**





fig.	Part No.	probe type	cable	probe temperature (°C)	connection	TS	probe	CL (m)	Ref. No.
1	400803	J (Fe-CuNi)	glass fibre	-50 up to +750	3-wire	M8	ø5x20mm	2.4	492997
2	524886	NTC	silicone	-40 up to +110	plug	M10x1.5	ø5x25mm	1.2	737006





fig.	Part No.	probe type	cable	probe temperature (°C)	connection	TS	probe	CL (m)	Ref. No.
3	402906	NTC 10kOhm	-	-40 up to +110	F4.8	-	ø10x30mm	-	775494-1
4	402905	NTC 10kOhm	PVC	-40 up to +110	coded plug	-	ø5x35mm	0.2	775612-1



fig.	Part No.	probe type	cable	probe temperature (°C)	connection	TS	probe	CL (m)	Ref. No.
5	379906	PTC 2kOhm	TPE	-50 up to +150	coded plug	-	ø4.8x30mm	3.5	378584

**Hoonved**



fig.	Part No.	probe type	cable	probe temperature (°C)	connection	TS	probe	CL (m)	Ref. No.
1	378006	NTC 40kOhm	PVC	-40 up to +110	F6.3	-	ø4x20mm	0.25	35567



## Hounö



fig.	Part No.	probe type	cable	probe temperature (°C)	connection	TS	probe	CL (m)	Ref. No.
1	381229	Pt100	Vetrotex	-100 up to 450	2-wire	-	ø3.5x170mm	0.4	20800174

## Icematic



fig.	Part No.	probe type	cable	probe temperature (°C)	connection	TS	probe	CL (m)	Ref. No.
1	381337	NTC 10kOhm	PVC	-40 up to +110	plug	-	ø5x40mm	1.5	CF62051901
2	381339	NTC 10kOhm	PVC	-40 up to +110	plug	-	ø5x50mm	1.2	33580298/0



fig.	Part No.	probe type	cable	probe temperature (°C)	connection	TS	probe	CL (m)	Ref. No.
3	381338	NTC 2.2kOhm	PVC	-40 up to +110	plug	-	ø5x50mm	2	33580135/0
4	402139	NTC 2.2kOhm	PVC	-40 up to +110	plug	-	ø5x60mm	1	33580101/0



fig.	Part No.	probe type	cable	probe temperature (°C)	connection	TS	probe	CL (m)	Ref. No.
5	381336	NTC 2kOhm	PVC	-40 up to +110	plug	-	ø6x60mm	1.5	33580265/0
6	381344	PTC 2kOhm	PVC	-50 up to +150	plug	-	ø5x50mm	1.7	CF62040411



fig.	Part No.	probe type	cable	probe temperature (°C)	connection	TS	probe	CL (m)	Ref. No.
7	402006	PTC 2kOhm	PVC	-50 up to +150	plug	-	ø5x60mm	1.5	33580065/1
8	378231	PTC 2kOhm	PVC	-50 up to +150	plug	-	ø5x60mm	1.9	33580066/1



fig.	Part No.	probe type	cable	probe temperature (°C)	connection	TS	probe	CL (m)	Ref. No.
9	402191	PTC 2kOhm	TPE	-50 up to +150	plug	-	ø5x20mm	1.8	CF62040401
10	402005	PTC 2kOhm	TPE	-50 up to +150	plug	-	ø6x50mm	1.6	29070013/0

## Inomak



fig.	Part No.	probe type	cable	probe temperature (°C)	connection	TS	probe	CL (m)	Ref. No.
1	402558	PTC	PVC	-50 up to +150	male faston	-	ø6x30mm	1.9	PPRB478
2	402560	PTC	silicone	-50 up to +150	2-wire	-	ø6.5x30mm	1.1	34500040100168

## Jemi



fig.	Part No.	probe type	cable	probe temperature (°C)	connection	TS	probe	CL (m)	Ref. No.
1	378338	Pt100	silicone	-100 up to 450	3-wire	M11x1.25	ø6x90mm	2	2028024



Juno



fig.	Part No.	probe type	cable	probe temperature (°C)	connection	TS	probe	CL (m)	Ref. No.
1	379146	J (Fe-CuNi)	Vetrotex	-50 up to +750	2-wire	1/2"	ø6x5mm	2	0H6247
2	401398	Pt100	silicone	-50 up to +250	F6.3	M10x1	ø10x10mm	0.07	0H6477



fig.	Part No.	probe type	cable	probe temperature (°C)	connection	TS	probe	CL (m)	Ref. No.
3	379100	Pt1000	silicone	-70 up to +500	F4.8	-	ø4x235mm	1.8	0C5342

Kastel



fig.	Part No.	probe type	cable	probe temperature (°C)	connection	TS	probe	CL (m)	Ref. No.
1	379851	NTC 10kOhm	silicone	-40 up to +110	plug	-	ø6x50mm	1.5	K04678
2	403223	NTC 10kOhm	silicone	-40 up to +110	plug	-	ø6x50mm	2	K04677

Krefftt



fig.	Part No.	probe type	cable	probe temperature (°C)	connection	TS	probe	CL (m)	Ref. No.
1	379078	K (NiCr-Ni)	silicone	-50 up to 1150	2-wire	-	ø1.5x100mm	1.8	76-30140165
2	379121	K (NiCr-Ni)	silicone	-50 up to 1150	2-wire	-	ø2x100mm	0.25	76-30141000



fig.	Part No.	probe type	cable	probe temperature (°C)	connection	TS	probe	CL (m)	Ref. No.
3	379076	K (NiCr-Ni)	silicone	-50 up to 1150	2-wire	-	ø2x100mm	2	76-30140160
3	379124	K (NiCr-Ni)	silicone	-50 up to 1150	2-wire	-	ø2x100mm	2.2	—
4	379077	K (NiCr-Ni)	silicone	-50 up to 1150	2-wire	-	ø2x40mm	2.6	—



fig.	Part No.	probe type	cable	probe temperature (°C)	connection	TS	probe	CL (m)	Ref. No.
5	379075	Pt100	silicone	-100 up to 450	2-wire	M6	ø4x100mm	1.5	76-30140151
6	379125	Pt100	silicone	-100 up to 450	2-wire	-	ø3.2x100mm	2.6	76-30140156



fig.	Part No.	probe type	cable	probe temperature (°C)	connection	TS	probe	CL (m)	Ref. No.
7	379070	Pt100	silicone	-100 up to 450	2-wire	-	ø4x70mm	1.7	76-30140150



Kromo



fig.	Part No.	probe type	cable	probe temperature (°C)	connection	TS	probe	CL (m)	Ref. No.
1	378347	2x NTC 10K	silicone	-40 up to +110	coded plug	M10x1	ø6x15/32mm	3	DW590104
2	378268	NTC	silicone	-40 up to +110	coded plug	-	ø6x15mm	1.1	DW50563
2	378248	NTC 10kOhm	PVC	-40 up to +110	coded plug	-	ø6x14mm	2	DW50562
2	378312	NTC 10kOhm	PVC	-40 up to +110	coded plug	-	ø6x14mm	3.5	DW392047/A



fig.	Part No.	probe type	cable	probe temperature (°C)	connection	TS	probe	CL (m)	Ref. No.
3	378314	NTC 10kOhm	silicone	-40 up to +110	coded plug	-	ø5x30mm	0.35	DW3006165
4	378313	NTC 10kOhm	silicone	-40 up to +110	coded plug	-	ø6x14mm	3	DW392047

Küppersbusch

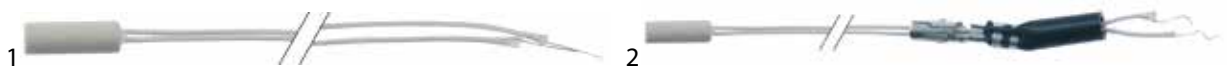

fig.	Part No.	probe type	cable	probe temperature (°C)	connection	TS	probe	CL (m)	Ref. No.
1	379911	Pt100	glass fibre	-100 up to 450	2-wire	-	ø4.6x13mm	0.5	161615
2	379913	Pt100	glass fibre	-100 up to 450	2-wire	-	ø4.6x13mm	0.5	995935002

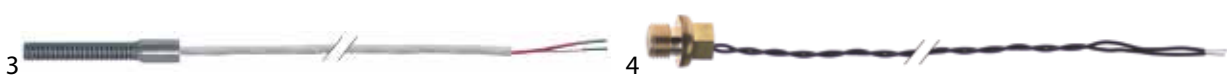

fig.	Part No.	probe type	cable	probe temperature (°C)	connection	TS	probe	CL (m)	Ref. No.
3	379168	Pt100	PTFE	-100 up to 450	2-wire	M5	ø5x30mm	2	161608
4	379399	Pt100	PVC	-50 up to +200	2-wire	M10x1	ø10x10mm	1.55	161601



fig.	Part No.	probe type	cable	probe temperature (°C)	connection	TS	probe	CL (m)	Ref. No.
5	379070	Pt100	silicone	-100 up to 450	2-wire	-	ø4x70mm	1.7	407339
6	379999	Pt1000	PTFE	-70 up to +500	F2.8	M5x1	ø5x30mm	0.1	161633

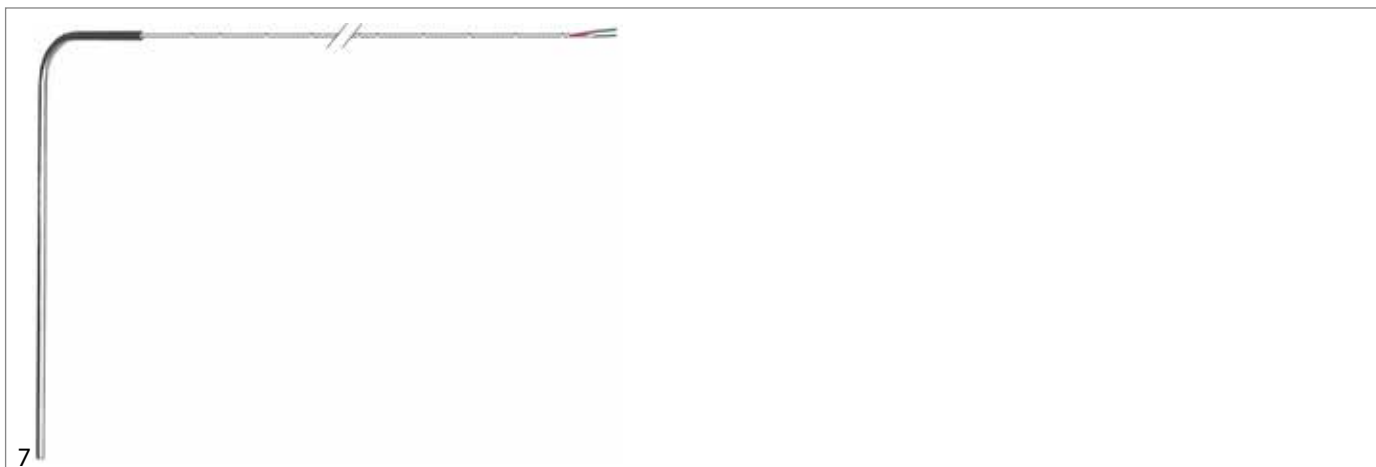

fig.	Part No.	probe type	cable	probe temperature (°C)	connection	TS	probe	CL (m)	Ref. No.
7	379110	thermocouple	Vetrotex	-50 up to +750	2-wire	-	ø4x150/50mm	1.5	174470

Lainox

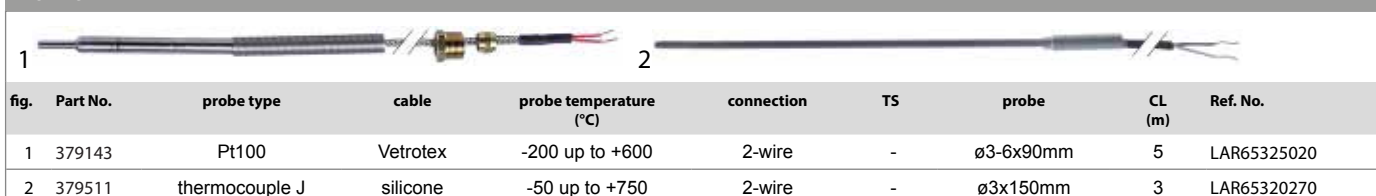

fig.	Part No.	probe type	cable	probe temperature (°C)	connection	TS	probe	CL (m)	Ref. No.
1	379143	Pt100	Vetrotex	-200 up to +600	2-wire	-	ø3-6x90mm	5	LAR65325020
2	379511	thermocouple J	silicone	-50 up to +750	2-wire	-	ø3x150mm	3	LAR65320270

La-Spaziale

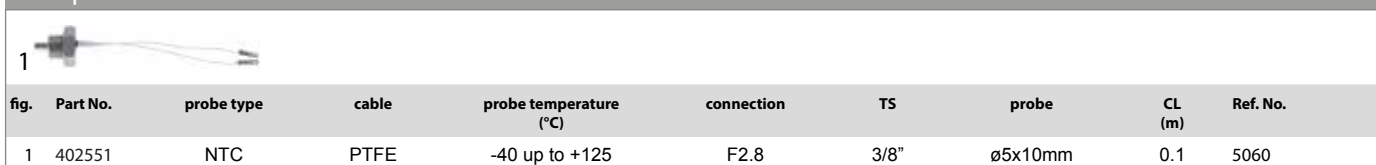

fig.	Part No.	probe type	cable	probe temperature (°C)	connection	TS	probe	CL (m)	Ref. No.
1	402551	NTC	PTFE	-40 up to +125	F2.8	3/8"	ø5x10mm	0.1	5060

Liebherr

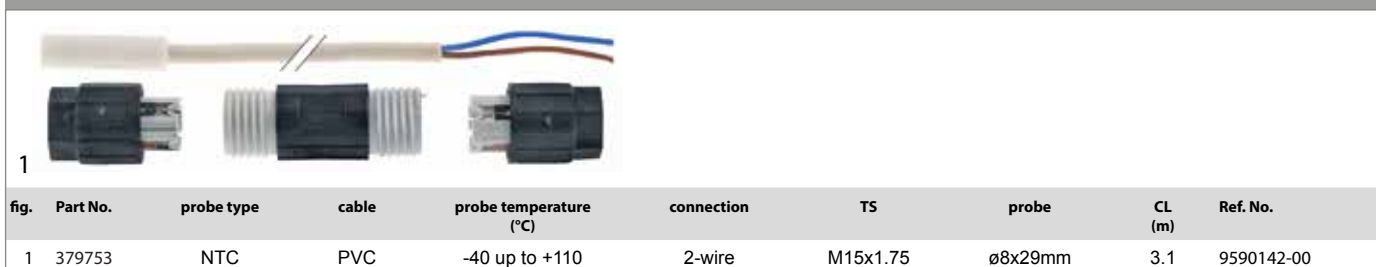

fig.	Part No.	probe type	cable	probe temperature (°C)	connection	TS	probe	CL (m)	Ref. No.
1	379753	NTC	PVC	-40 up to +110	2-wire	M15x1.75	ø8x29mm	3.1	9590142-00

LineaBlanca

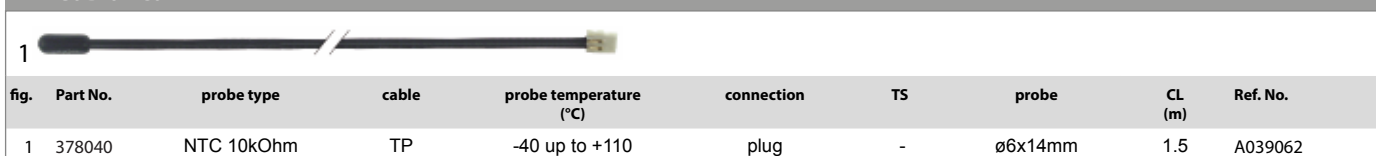

fig.	Part No.	probe type	cable	probe temperature (°C)	connection	TS	probe	CL (m)	Ref. No.
1	378040	NTC 10kOhm	TP	-40 up to +110	plug	-	ø6x14mm	1.5	A039062

Mach

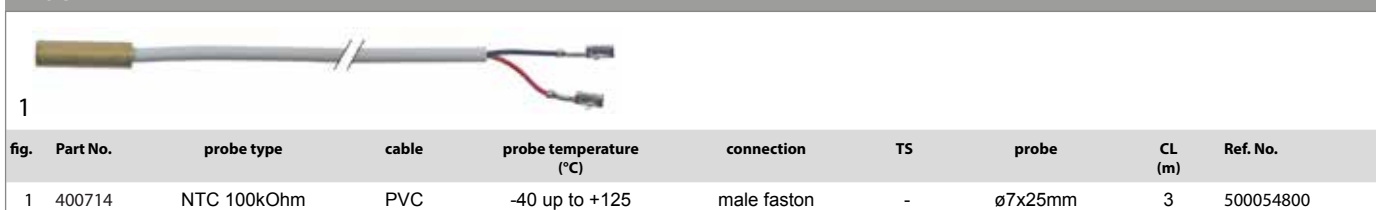

fig.	Part No.	probe type	cable	probe temperature (°C)	connection	TS	probe	CL (m)	Ref. No.
1	400714	NTC 100kOhm	PVC	-40 up to +125	male faston	-	ø7x25mm	3	500054800



## Meiko

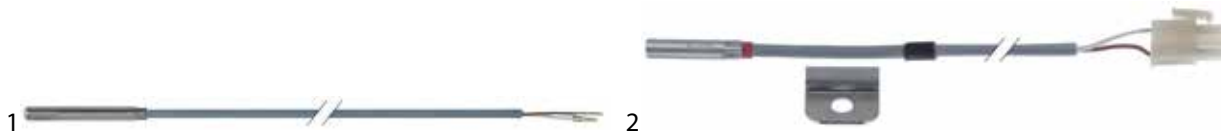

fig.	Part No.	probe type	cable	probe temperature (°C)	connection	TS	probe	CL (m)	Ref. No.
1	379151	NTC 10kOhm	PVC	-40 up to +110	2-wire	-	ø4x30mm	2	0180681
2	379822	Pt1000	PVC	-50 up to +250	coded plug	-	ø7x32mm	0.5	9640338

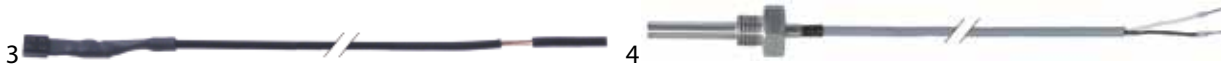

fig.	Part No.	probe type	cable	probe temperature (°C)	connection	TS	probe	CL (m)	Ref. No.
3	379696	Pt1000	silicone	-50 up to +250	1-wire	-	ø4.6x5mm	8.5	0180635
4	379152	PTC 1kOhm	PVC	-50 up to +150	2-wire	1/4"	ø6x35mm	2.2	0180682

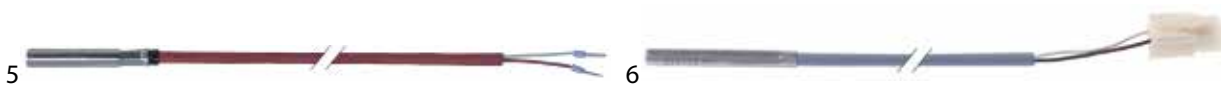

fig.	Part No.	probe type	cable	probe temperature (°C)	connection	TS	probe	CL (m)	Ref. No.
5	379153	PTC 1kOhm	silicone	-50 up to +150	2-wire	-	ø6x35mm	2.2	9500236
6	378353	PTC 1kOhm	silicone	-50 up to +150	coded plug	-	ø6x50mm	1.7	8303881



fig.	Part No.	probe type	cable	probe temperature (°C)	connection	TS	probe	CL (m)	Ref. No.
7	379795	PTC 1kOhm	silicone	-50 up to +150	coded plug	-	ø7x32mm	0.5	9640339

## Melitta



fig.	Part No.	probe type	cable	probe temperature (°C)	connection	TS	probe	CL (m)	Ref. No.
1	402105	PTC 2kOhm	-	-50 up to +150	F2.8	-	ø10x30mm	-	1011296

## Migel



fig.	Part No.	probe type	cable	probe temperature (°C)	connection	TS	probe	CL (m)	Ref. No.
1	377000	PTC 1kOhm	silicone	-50 up to +150	2-wire	-	ø6x50mm	1.2	1LT067

## MIWE



fig.	Part No.	probe type	cable	probe temperature (°C)	connection	TS	probe	CL (m)	Ref. No.
1	378323	Pt1000	glass fibre	-70 up to +500	2-wire	-	ø5x210mm	2.2	504006.55

## MKN



fig.	Part No.	probe type	cable	probe temperature (°C)	connection	TS	probe	CL (m)	Ref. No.
1	378121	K (NiCr-Ni)	PTFE	-50 up to 1150	2-wire	M8x1	ø1.5x18mm	3.2	203689



Moretti



fig.	Part No.	probe type	cable	probe temperature (°C)	connection	TS	probe	CL (m)	Ref. No.
1	379974	thermocouple	ceramic	-50 up to +750	grip connection	-	ø10x150mm	-	66080980
2	378330	thermocouple	ceramic	-50 up to +750	grip connection	-	ø10x190mm	-	66000830

N&W



fig.	Part No.	probe type	cable	probe temperature (°C)	connection	TS	probe	CL (m)	Ref. No.
1	402078	NTC 10kOhm	-	-40 up to +110	F6.3	1/4"	ø10x25mm	-	094872

NuovaSimonelli



fig.	Part No.	probe type	cable	probe temperature (°C)	connection	TS	probe	CL (m)	Ref. No.
1	379659	NTC	silicone	-40 up to +110	plug	1/8"	ø8x50mm	0.4	04900561

OEM



fig.	Part No.	probe type	cable	probe temperature (°C)	connection	TS	probe	CL (m)	Ref. No.
1	379451	K (NiCr-Ni)	silicone	-50 up to 1150	2-wire	-	ø2x250mm	1.5	ED06500
2	379454	K (NiCr-Ni)	silicone	-50 up to 1150	male faston	-	ø2x250mm	2.5	ED06600



fig.	Part No.	probe type	cable	probe temperature (°C)	connection	TS	probe	CL (m)	Ref. No.
3	378457	Pt1000	silicone	-100 up to 450	plug	-	ø3x280mm	1.95	ED08320

Olis



fig.	Part No.	probe type	cable	probe temperature (°C)	connection	TS	probe	CL (m)	Ref. No.
1	379936	Pt100	Vetrotex	-200 up to +600	2-wire	-	ø4-6x100mm	1	BN3103275
2	379935	Pt100	Vetrotex	-200 up to +600	2-wire	-	ø6x100mm	0.8	BN3103270

Palux



fig.	Part No.	probe type	cable	probe temperature (°C)	connection	TS	probe	CL (m)	Ref. No.
1	379399	Pt100	PVC	-50 up to +200	2-wire	M10x1	ø10x10mm	1.55	702285





**Pitco**



fig.	Part No.	probe type	cable	probe temperature (°C)	connection	TS	probe	CL (m)	Ref. No.
1	403491	thermocouple	glass fibre	-50 up to +750	2-wire	1/4" NPT	ø4.7x280mm	0.315	B6700601-C

**Rancilio**



fig.	Part No.	probe type	cable	probe temperature (°C)	connection	TS	probe	CL (m)	Ref. No.
1	400416	PTC 2kOhm	silicone	-50 up to +150	plug	3/8"	ø8x30mm	0.7	34070174

**Rational**





fig.	Part No.	probe type	cable	probe temperature (°C)	connection	TS	probe	CL (m)	Ref. No.
1	379078	K (NiCr-Ni)	silicone	-50 up to 1150	2-wire	-	ø1.5x100mm	1.8	3014.0165
2	379429	K (NiCr-Ni)	silicone	-50 up to 1150	2-wire	-	ø10.5mm	1.7	3014.1020





fig.	Part No.	probe type	cable	probe temperature (°C)	connection	TS	probe	CL (m)	Ref. No.
3	379121	K (NiCr-Ni)	silicone	-50 up to 1150	2-wire	-	ø2x100mm	0.25	3014.1000
4	379076	K (NiCr-Ni)	silicone	-50 up to 1150	2-wire	-	ø2x100mm	2	3014.0160
4	379124	K (NiCr-Ni)	silicone	-50 up to 1150	2-wire	-	ø2x100mm	2.2	3014.1004





fig.	Part No.	probe type	cable	probe temperature (°C)	connection	TS	probe	CL (m)	Ref. No.
5	379077	K (NiCr-Ni)	silicone	-50 up to 1150	2-wire	-	ø2x40mm	2.6	3014.1007
6	378351	K (NiCr-Ni)	silicone	-50 up to 1150	coded plug	M8	ø2x135mm	1.3	40.03.528





fig.	Part No.	probe type	cable	probe temperature (°C)	connection	TS	probe	CL (m)	Ref. No.
7	379864	K (NiCr-Ni)	silicone	-50 up to 1150	coded plug	M8	ø2x50mm	1.2	40.00.594
8	379873	K (NiCr-Ni)	silicone	-50 up to 1150	coded plug	-	ø1.5x180mm	1.6	40.00.292



fig.	Part No.	probe type	cable	probe temperature (°C)	connection	TS	probe	CL (m)	Ref. No.
9	379441	K (NiCr-Ni)	silicone	-50 up to 1150	coded plug	-	ø2x125mm	1.5	40.00.291
9	379442	K (NiCr-Ni)	silicone	-50 up to 1150	coded plug	-	ø2x90mm	1.5	40.01.094
10	379869	K (NiCr-Ni)	silicone	-50 up to 1150	coded plug	-	ø2x70mm	2.5	87.00.058

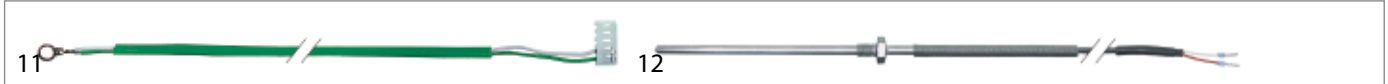

fig.	Part No.	probe type	cable	probe temperature (°C)	connection	TS	probe	CL (m)	Ref. No.
11	379870	K (NiCr-Ni)	silicone	-50 up to 1150	coded plug	-	ø4.2mm	1.7	87.00.470
12	379075	Pt100	silicone	-100 up to 450	2-wire	M6	ø4x100mm	1.5	3014.0151



fig.	Part No.	probe type	cable	probe temperature (°C)	connection	TS	probe	CL (m)	Ref. No.
13	379125	Pt100	silicone	-100 up to 450	2-wire	-	ø3.2x100mm	2.6	3014.0156
14	379070	Pt100	silicone	-100 up to 450	2-wire	-	ø4x70mm	1.7	3014.0150

Reneka



fig.	Part No.	probe type	cable	probe temperature (°C)	connection	TS	probe	CL (m)	Ref. No.
1	401656	NTC 47kOhm	PTFE	-40 up to +125	plug	1/8"	ø7x28mm	0.2	9209004

Retigo



fig.	Part No.	probe type	cable	probe temperature (°C)	connection	TS	probe	CL (m)	Ref. No.
1	381239	K (NiCr-Ni)	PTFE	-50 up to 1150	coded plug	-	ø2x4mm	1.5	EA10-0104
1	381240	K (NiCr-Ni)	PTFE	-50 up to 1150	coded plug	-	ø2x7mm	2	EA10-0105
2	381238	K (NiCr-Ni)	silicone	-50 up to 1150	coded plug	-	ø1.9x140mm	1.4	EA10-0103



fig.	Part No.	probe type	cable	probe temperature (°C)	connection	TS	probe	CL (m)	Ref. No.
3	378348	Pt100	silicone	-100 up to 450	plug	M10x1.5	ø6x30mm	1.5	EA10-0007
4	378350	Pt100	silicone	-100 up to 450	plug	-	ø4.5x25mm	1.5	EA10-0006

Rieber



fig.	Part No.	probe type	cable	probe temperature (°C)	connection	TS	probe	CL (m)	Ref. No.
1	379472	PTC 1kOhm	PVC	-50 up to +150	2-wire	-	ø6x50mm	4	33064504



## Rosinox

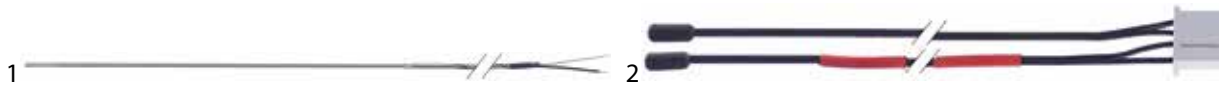

fig.	Part No.	probe type	cable	probe temperature (°C)	connection	TS	probe	CL (m)	Ref. No.
1	378413	J (Fe-CuNi)	Vetrotex	-50 up to +750	2-wire	-	ø3x280mm	3.5	RX94046186
2	378268	NTC	silicone	-40 up to +110	coded plug	-	ø6x15mm	1.1	RX94808763



fig.	Part No.	probe type	cable	probe temperature (°C)	connection	TS	probe	CL (m)	Ref. No.
3	378314	NTC 10kOhm	silicone	-40 up to +110	coded plug	-	ø5x30mm	0.35	RX94814005
4	379075	Pt100	silicone	-100 up to 450	2-wire	M6	ø4x100mm	1.5	RX24849093



fig.	Part No.	probe type	cable	probe temperature (°C)	connection	TS	probe	CL (m)	Ref. No.
5	379070	Pt100	silicone	-100 up to 450	2-wire	-	ø4x70mm	1.7	RX24849036

## Salvis



fig.	Part No.	probe type	cable	probe temperature (°C)	connection	TS	probe	CL (m)	Ref. No.
1	379879	NTC 900kOhm	silicone	-40 up to +150	male faston	-	ø6x80/170mm	0.65	BK178611

## Sammic



fig.	Part No.	probe type	cable	probe temperature (°C)	connection	TS	probe	CL (m)	Ref. No.
1	378352	NTC 10kOhm	silicone	-40 up to +110	2-wire	M10	ø6x45mm	1.1	2310459

## Sanremo



fig.	Part No.	probe type	cable	probe temperature (°C)	connection	TS	probe	CL (m)	Ref. No.
1	379452	NTC	glass fibre	-40 up to +125	plug	1/4"	ø3.5x20mm	0.24	10112178

## Scotsman



fig.	Part No.	probe type	cable	probe temperature (°C)	connection	TS	probe	CL (m)	Ref. No.
1	402133	NTC 10kOhm	PVC	-40 up to +110	plug	-	ø6x60mm	1.5	62047501
2	402139	NTC 2.2kOhm	PVC	-40 up to +110	plug	-	ø5x60mm	1	CM33580101







fig.	Part No.	probe type	cable	probe temperature (°C)	connection	TS	probe	CL (m)	Ref. No.
3	402006	PTC 2kOhm	PVC	-50 up to +150	plug	-	ø5x60mm	1.5	62040406
4	378231	PTC 2kOhm	PVC	-50 up to +150	plug	-	ø5x60mm	1.9	CM33580066





fig.	Part No.	probe type	cable	probe temperature (°C)	connection	TS	probe	CL (m)	Ref. No.
5	402008	PTC 2kOhm	PVC	-50 up to +150	plug	-	ø6x50mm	1.2	62040402
6	402191	PTC 2kOhm	TPE	-50 up to +150	plug	-	ø5x20mm	1.8	62040411



fig.	Part No.	probe type	cable	probe temperature (°C)	connection	TS	probe	CL (m)	Ref. No.
7	402005	PTC 2kOhm	TPE	-50 up to +150	plug	-	ø6x50mm	1.6	62040410

### Sharp



fig.	Part No.	probe type	cable	probe temperature (°C)	connection	TS	probe	CL (m)	Ref. No.
1	379521	Pt100	glass fibre	-100 up to 450	coded plug	-	ø3.5x10mm	0.2	FH-HZA070WRE0

### Silanos





fig.	Part No.	probe type	cable	probe temperature (°C)	connection	TS	probe	CL (m)	Ref. No.
1	378331	NTC	silicone	-40 up to +110	coded plug	-	ø6x50mm	2	909364
2	378332	NTC 10kOhm	silicone	-40 up to +110	2-wire	-	ø6x50mm	2.5	909025

### Simag





fig.	Part No.	probe type	cable	probe temperature (°C)	connection	TS	probe	CL (m)	Ref. No.
1	381337	NTC 10kOhm	PVC	-40 up to +110	plug	-	ø5x40mm	1.5	620519 01
2	402006	PTC 2kOhm	PVC	-50 up to +150	plug	-	ø5x60mm	1.5	—





fig.	Part No.	probe type	cable	probe temperature (°C)	connection	TS	probe	CL (m)	Ref. No.
3	402008	PTC 2kOhm	PVC	-50 up to +150	plug	-	ø6x50mm	1.2	62040402
4	402191	PTC 2kOhm	TPE	-50 up to +150	plug	-	ø5x20mm	1.8	62040411



fig.	Part No.	probe type	cable	probe temperature (°C)	connection	TS	probe	CL (m)	Ref. No.
5	402005	PTC 2kOhm	TPE	-50 up to +150	plug	-	ø6x50mm	1.6	62040410



## Star10



fig.	Part No.	probe type	cable	probe temperature (°C)	connection	TS	probe	CL (m)	Ref. No.
1	402191	PTC 2kOhm	TPE	-50 up to +150	plug	-	ø5x20mm	1.8	FR.62040411
2	402005	PTC 2kOhm	TPE	-50 up to +150	plug	-	ø6x50mm	1.6	FR.62040410

## Stierlen



fig.	Part No.	probe type	cable	probe temperature (°C)	connection	TS	probe	CL (m)	Ref. No.
1	400082	NTC 10kOhm	-	-40 up to +110	F6.3	-	ø10x30mm	-	602#02310214

## Therma



fig.	Part No.	probe type	cable	probe temperature (°C)	connection	TS	probe	CL (m)	Ref. No.
1	379100	Pt1000	silicone	-70 up to +500	F4.8	-	ø4x235mm	1.8	0C5342
2	402005	PTC 2kOhm	TPE	-50 up to +150	plug	-	ø6x50mm	1.6	086344

## Thermoplan



fig.	Part No.	probe type	cable	probe temperature (°C)	connection	TS	probe	CL (m)	Ref. No.
1	379002	NTC 10kOhm	silicone	-40 up to +110	2-wire	-	ø3x20mm	0.3	107,260

## Unox

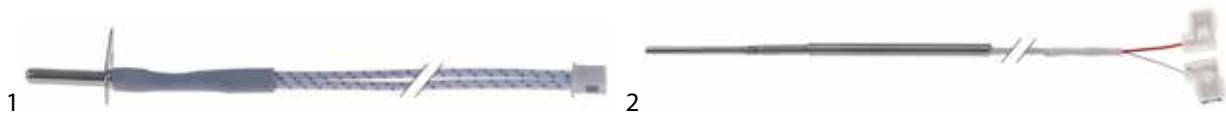

fig.	Part No.	probe type	cable	probe temperature (°C)	connection	TS	probe	CL (m)	Ref. No.
1	379741	NTC	glass fibre	-40 up to +125	coded plug	-	ø4x19mm	1	KTR1095A
2	378371 <sup>1</sup>	Pt100	PTFE	-100 up to 450	plug	-	ø3x70mm	0.15	KTR0110A

<sup>1</sup>incl. silicone gasket

fig.	Part No.	probe type	cable	probe temperature (°C)	connection	TS	probe	CL (m)	Ref. No.
3	378372	PTC	PTFE	-50 up to +150	2-wire	-	ø3x70mm	0.15	TR110A
4	378374 <sup>1</sup>	PTC	silicone	-50 up to +150	coded plug	-	ø4x16mm	1	KTR1105A

<sup>1</sup>incl. silicone gasket

## Vibiemme

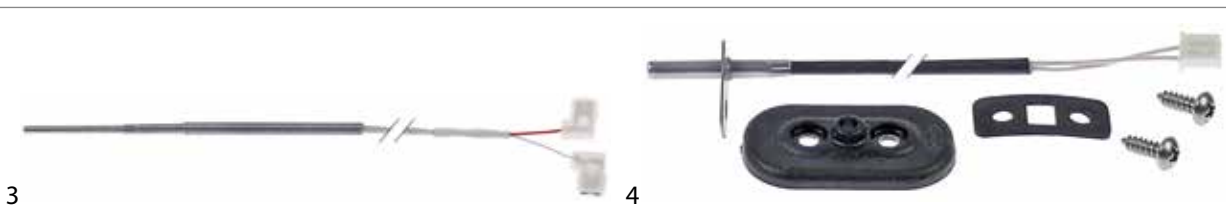

fig.	Part No.	probe type	cable	probe temperature (°C)	connection	TS	probe	CL (m)	Ref. No.
1	379452	NTC	glass fibre	-40 up to +125	plug	1/4"	ø3.5x20mm	0.24	ELETSONTEMPII



Winterhalter



fig.	Part No.	probe type	cable	probe temperature (°C)	connection	TS	probe	CL (m)	Ref. No.
1	403311	NTC 12kOhm	silicone	-40 up to +110	2-wire	M10x1	ø8.5x22mm	4.5	71002590
2	402202	PTC 2kOhm	-	-50 up to +150	F2.8	M10	ø8x140mm	-	70004624

Zanolli



fig.	Part No.	probe type	cable	probe temperature (°C)	connection	TS	probe	CL (m)	Ref. No.
1	379941	J (Fe-CuNi)	Vetrotex	-50 up to +750	2-wire	-	ø6x200mm	1	TERM0084
2	379944	Pt1000	Vetrotex	-70 up to +500	2-wire	-	ø6x180mm	1.7	TERM0049



fig.	Part No.	probe type	cable	probe temperature (°C)	connection	TS	probe	CL (m)	Ref. No.
3	379942	thermocouple J	Vetrotex	-50 up to +750	2-wire	-	ø6x200mm	1.5	TERM0018

Zanussi



fig.	Part No.	probe type	cable	probe temperature (°C)	connection	TS	probe	CL (m)	Ref. No.
1	379717	K (NiCr-Ni)	PTFE	-50 up to 1150	plug	-	ø4x70mm	1.1	0C6539
1	379715	K (NiCr-Ni)	PVC	-50 up to 1150	plug	-	ø4x70mm	0.5	0C6538
1	379716	K (NiCr-Ni)	PVC	-50 up to 1150	plug	-	ø4x70mm	0.85	0C0325
1	379889	K (NiCr-Ni)	PVC	-50 up to 1150	plug	-	ø4x70mm	2	0C3457
2	400714	NTC 100kOhm	PVC	-40 up to +125	male faston	-	ø7x25mm	3	087346

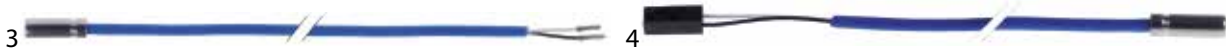

fig.	Part No.	probe type	cable	probe temperature (°C)	connection	TS	probe	CL (m)	Ref. No.
3	402200	NTC 10kOhm	PVC	-40 up to +110	2-wire	-	ø6x200mm	2	092174
4	402155	NTC 10kOhm	PVC	-40 up to +110	plug	-	ø6x20mm	2	092177



fig.	Part No.	probe type	cable	probe temperature (°C)	connection	TS	probe	CL (m)	Ref. No.
5	379902	NTC 4.8kOhm	-	-40 up to +110	F6.3	-	ø10x30mm	-	049643
6	379901	NTC 4.8kOhm	PVC	-40 up to +110	F6.3	-	ø6x50mm	0.1	049884

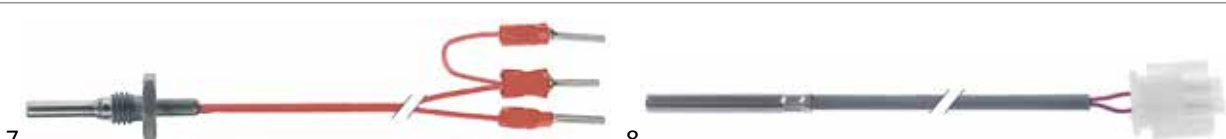

fig.	Part No.	probe type	cable	probe temperature (°C)	connection	TS	probe	CL (m)	Ref. No.
7	379921	Pt100	PTFE	-100 up to 450	3-wire	M8	ø4x20mm	1.5	058953
8	378335	Pt1000	silicone	-50 up to +200	coded plug	-	ø6x50mm	6	710E5990







fig.	Part No.	probe type	cable	probe temperature (°C)	connection	TS	probe	CL (m)	Ref. No.
9	379100	Pt1000	silicone	-70 up to +500	F4.8	-	ø4x235mm	1.8	0C5342
10	402006	PTC 2kOhm	PVC	-50 up to +150	plug	-	ø5x60mm	1.5	086369



fig.	Part No.	probe type	cable	probe temperature (°C)	connection	TS	probe	CL (m)	Ref. No.
11	402005	PTC 2kOhm	TPE	-50 up to +150	plug	-	ø6x50mm	1.6	086344

core probes

Afnox

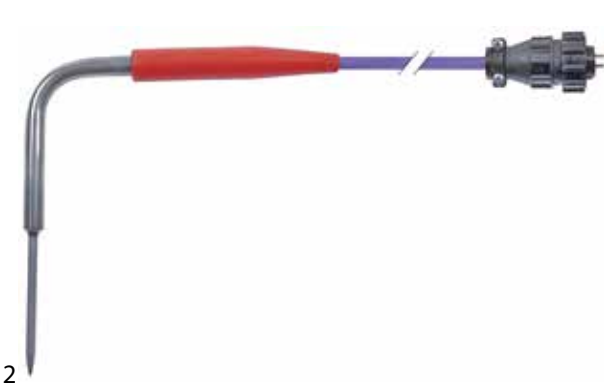



fig.	Part No.	probe type	cable	probe temperature (°C)	probe	connection	TS	CL (m)	handle ø (mm)	handle length (mm)	Ref. No.
1	523049	NTC	silicone	-40 up to +110	ø4.5x80mm	2-wire	-	1	16	120	74700124
2	378364	PTC	silicone	-40 up to +120	ø4.5x170mm	plug	-	1	16	100	74700116

Angelo-Po





fig.	Part No.	probe type	cable	probe temperature (°C)	probe	connection	TS	CL (m)	handle ø (mm)	handle length (mm)	Ref. No.
1	379933	Pt100	PTFE	-40 up to +250	ø2.5x100mm	3-wire	-	2.75	15	90	32Z1983
2	378402 <sup>1</sup>	Pt100	silicone	-40 up to +120	ø5x175mm	5-wire	-	3.5	16	125	32V7960

<sup>1</sup>multipoint probe





fig.	Part No.	probe type	cable	probe temperature (°C)	probe	connection	TS	CL (m)	handle ø (mm)	handle length (mm)	Ref. No.
3	403452	Pt1000	PTFE	-40 up to +250	ø3x100mm	2-wire	-	3.2	13	60	6300643
4	379588	Pt1000	TP	-40 up to +250	ø3x110mm	2-wire	-	3.1	13	70	3139610



Bartscher



fig.	Part No.	probe type	cable	probe temperature (°C)	probe	connection	TS	CL (m)	handle ø (mm)	handle length (mm)	Ref. No.
1	379886	Pt100	PTFE	-40 up to +250	ø4x100mm	2-wire	M10x1.5	3	15	90	0SON000

Bertos



fig.	Part No.	probe type	cable	probe temperature (°C)	probe	connection	TS	CL (m)	handle ø (mm)	handle length (mm)	Ref. No.
1	379350 <sup>1</sup>	PTC 1kOhm	silicone	-40 up to +120	ø4x100mm	plug	-	1.7	8	120/35	70404
2	379662 <sup>1</sup>	PTC 1kOhm	silicone	-40 up to +120	ø4x70mm	plug	-	1.3	16	120	70402A
2	379806 <sup>1</sup>	PTC 1kOhm	silicone	-40 up to +120	ø5x70mm	plug	-	1.2	16	125	70405A

<sup>1</sup> multipoint probe

Coldline



fig.	Part No.	probe type	cable	probe temperature (°C)	probe	connection	TS	CL (m)	handle ø (mm)	handle length (mm)	Ref. No.
1	378407	PTC	silicone	-40 up to +120	ø6/8x195mm	2-wire	-	3.5	13	130	E043673510

Convotherm

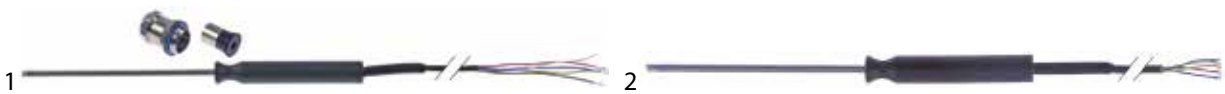

fig.	Part No.	probe type	cable	probe temperature (°C)	probe	connection	TS	CL (m)	handle ø (mm)	handle length (mm)	Ref. No.
1	379828 <sup>1</sup>	3 point probe	PTFE	-40 up to +250	ø4x100mm	5-wire	-	4	12	75	—
2	379428 <sup>1</sup>	K (NiCr-Ni)	PTFE	-50 up to 1150	ø3x100mm	5-wire	-	3	11	75	5013022K

<sup>1</sup> multipoint probe



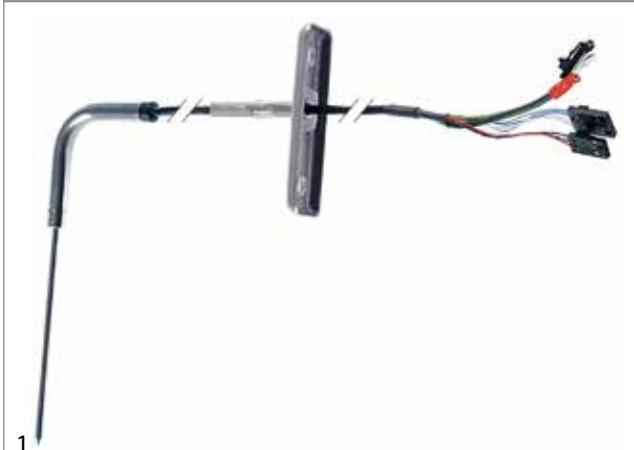



fig.	Part No.	probe type	cable	probe temperature (°C)	probe	connection	TS	CL (m)	handle ø (mm)	handle length (mm)	Ref. No.
3	379103	Pt100	PTFE	-40 up to +250	ø4x100mm	2-wire	-	4	15	85	5002062K

Coven

fig.	Part No.	probe type	cable	probe temperature (°C)	probe	connection	TS	CL (m)	handle ø (mm)	handle length (mm)	Ref. No.
1	379431	Pt100	PTFE	-40 up to +250	ø4x100mm	2-wire	1/4"	3	12	85	EMSONSPEC



Electrolux

											
1	2										
fig.	Part No.	probe type	cable	probe temperature (°C)	probe	connection	TS	CL (m)	handle ø (mm)	handle length (mm)	Ref. No.
1	379718 <sup>1</sup>	K (NiCr-Ni)	PTFE	-40 up to +250	ø3.5x100mm	plug	-	2.2	9	45/50	0C4240
1	379970 <sup>1</sup>	K (NiCr-Ni)	PTFE	-40 up to +250	ø3.5x100mm	plug	-	3.2	9	45/50	0C1404
2	379955	K (NiCr-Ni)	PTFE	-40 up to +250	ø3.5x100mm	plug	-	2.6	9	45/50	007109

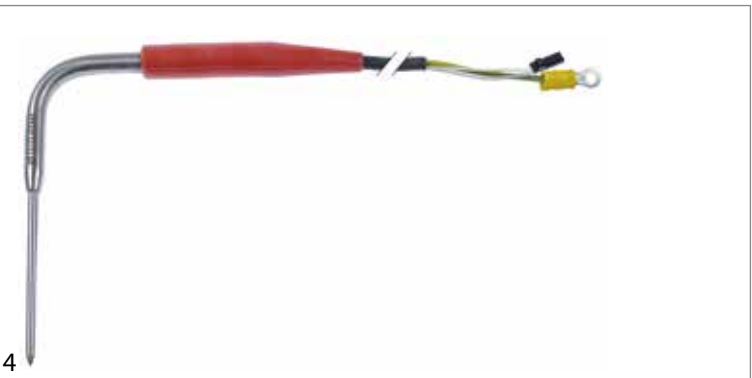
<sup>1</sup> multipoint probe

											
3	4										
fig.	Part No.	probe type	cable	probe temperature (°C)	probe	connection	TS	CL (m)	handle ø (mm)	handle length (mm)	Ref. No.
3	378412 <sup>1</sup>	multipoint probe	SS corrugated hose	-40 up to +250	ø3.5x100mm	plug	-	1.74	10	85	0C3964
4	401944	NTC 10kOhm	silicone	-40 up to +120	ø5x80mm	plug	-	3	10	100	092704

<sup>1</sup> multipoint probe

											
5	6										
fig.	Part No.	probe type	cable	probe temperature (°C)	probe	connection	TS	CL (m)	handle ø (mm)	handle length (mm)	Ref. No.
5	379060	Pt1000	SS corrugated hose	-40 up to +250	ø4x100mm	2-wire	M8	2	10	45	002673
5	379061	Pt1000	SS corrugated hose	-40 up to +250	ø4x100mm	2-wire	M8	2.5	10	45	003853
6	379406	Pt1000	SS corrugated hose	-40 up to +250	ø4x100mm	2-wire	M8	2	10	50	006192

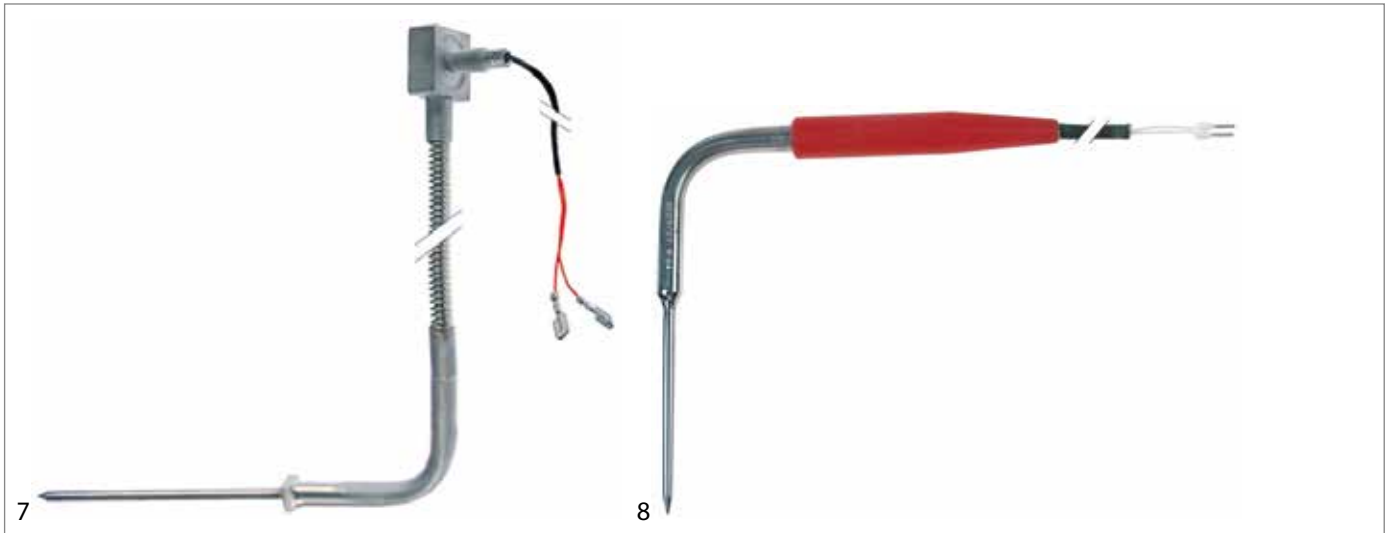

fig.	Part No.	probe type	cable	probe temperature (°C)	probe	connection	TS	CL (m)	handle ø (mm)	handle length (mm)	Ref. No.
7	379976	Pt1000	SS corrugated hose	-40 up to +250	ø4x100mm	F6.3	M8	3.1	9	50/55	002821
8	379620	PTC 1kOhm	silicone	-40 up to +120	ø4.5x80mm	2-wire	-	4	10	120	088044



fig.	Part No.	probe type	cable	probe temperature (°C)	probe	connection	TS	CL (m)	handle ø (mm)	handle length (mm)	Ref. No.
9	378185	PTC 1kOhm	silicone	-50 up to +150	ø5x100mm	2-wire	-	3	13.5	90	083582

### Eliwell



fig.	Part No.	probe type	cable	probe temperature (°C)	probe	connection	TS	CL (m)	handle ø (mm)	handle length (mm)	Ref. No.
1	378185	PTC 1kOhm	silicone	-50 up to +150	ø5x100mm	2-wire	-	3	13.5	90	SN603027

### Eloma





fig.	Part No.	probe type	cable	probe temperature (°C)	probe	connection	TS	CL (m)	handle ø (mm)	handle length (mm)	Ref. No.
1	379592 <sup>1</sup>	3 point probe	PTFE	-40 up to +250	ø4x100mm	5-wire	-	4.5	12	85	EL0752363
2	379116	Pt100	PTFE	-40 up to +250	ø4x82mm	2-wire	1/4"	3	12	90	EL0873241

<sup>1</sup>multipoint probe

### Fagor





fig.	Part No.	probe type	cable	probe temperature (°C)	probe	connection	TS	CL (m)	handle ø (mm)	handle length (mm)	Ref. No.
1	379122	K (NiCr-Ni)	PTFE	-40 up to +250	ø3.2x100mm	2-wire	M12	1.9	10	100	12027356
2	379129 <sup>1</sup>	K (NiCr-Ni)	PTFE	-40 up to +250	ø3.2x100mm	plug	M12	1.9	10	100	12026252

<sup>1</sup>multipoint probe



fig.	Part No.	probe type	cable	probe temperature (°C)	probe	connection	TS	CL (m)	handle ø (mm)	handle length (mm)	Ref. No.
3	379868 <sup>1</sup>	K (NiCr-Ni)	PTFE	-40 up to +250	ø3x100mm	plug	M16	2.2	10	40	12026495
4	379866 <sup>1</sup>	K (NiCr-Ni)	PTFE	-40 up to +250	ø3x100mm	plug	M16	2.3	-	50	12026609

<sup>1</sup>multipoint probe



fig.	Part No.	probe type	cable	probe temperature (°C)	probe	connection	TS	CL (m)	handle ø (mm)	handle length (mm)	Ref. No.
5	379552	K (NiCr-Ni)	Vetrotex	-40 up to +250	ø3x90mm	2-wire	-	1.65	8	50	12039150
6	379167	PTC	silicone	-50 up to +150	ø6x180mm	2-wire	-	3.1	12	120/40	12028770

Falcon



fig.	Part No.	probe type	cable	probe temperature (°C)	probe	connection	TS	CL (m)	handle ø (mm)	handle length (mm)	Ref. No.
1	379827	K (NiCr-Ni)	PTFE	-40 up to +250	ø5x115/285mm	2-wire	-	1.5	-	-	737601043



Foinox



1	379350 <sup>1</sup>	PTC 1kOhm	silicone	-40 up to +120	ø4x100mm	plug	-	1.7	8	120/35	70404
2	379662 <sup>1</sup>	PTC 1kOhm	silicone	-40 up to +120	ø4x70mm	plug	-	1.3	16	120	70402A
2	379806 <sup>1</sup>	PTC 1kOhm	silicone	-40 up to +120	ø5x70mm	plug	-	1.2	16	125	70405A

<sup>1</sup> multipoint probe

Foster



fig.	Part No.	probe type	cable	probe temperature (°C)	probe	connection	TS	CL (m)	handle ø (mm)	handle length (mm)	Ref. No.
1	378452	NTC 2kOhm	PVC	-40 up to +120	ø6x155mm	2-wire	-	1.5	-	50	00-554451

FriFri



fig.	Part No.	probe type	cable	probe temperature (°C)	probe	connection	TS	CL (m)	handle ø (mm)	handle length (mm)	Ref. No.
1	379827	K (NiCr-Ni)	PTFE	-40 up to +250	ø5x115/285mm	2-wire	-	1.5	-	-	601043



## Friulinox

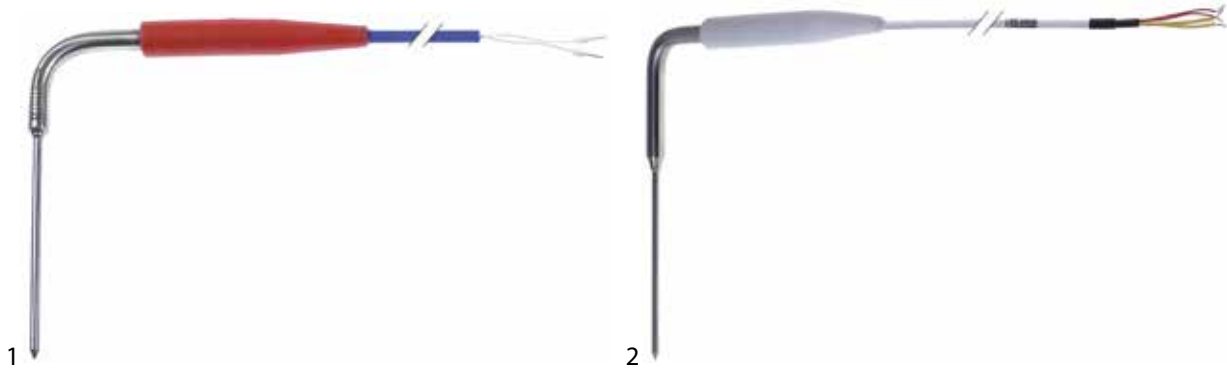

fig.	Part No.	probe type	cable	probe temperature (°C)	probe	connection	TS	CL (m)	handle ø (mm)	handle length (mm)	Ref. No.
1	401756	PTC 1kOhm	silicone	-40 up to +120	ø4.5x100mm	2-wire	-	4.5	10	120	FR996070
2	379587 <sup>1</sup>	PTC 1kOhm	silicone	-40 up to +120	ø4x100mm	4-wire	-	6	16	120	FR996452

<sup>1</sup>multipoint probe

## Garbin



fig.	Part No.	probe type	cable	probe temperature (°C)	probe	connection	TS	CL (m)	handle ø (mm)	handle length (mm)	Ref. No.
1	379886	Pt100	PTFE	-40 up to +250	ø4x100mm	2-wire	M10x1.5	3	15	90	SON000

## Hobart



fig.	Part No.	probe type	cable	probe temperature (°C)	probe	connection	TS	CL (m)	handle ø (mm)	handle length (mm)	Ref. No.
1	378452	NTC 2kOhm	PVC	-40 up to +120	ø6x155mm	2-wire	-	1.5	-	50	F15247515

Hounö



1

fig.	Part No.	probe type	cable	probe temperature (°C)	probe	connection	TS	CL (m)	handle ø (mm)	handle length (mm)	Ref. No.
1	381228 <sup>1</sup>	K (NiCr-Ni)	PTFE	-50 up to 1150	ø4x128mm	plug	-	1.5	-	50	30800054
1	381267 <sup>1</sup>	Pt100	PTFE	-40 up to +250	ø4x100mm	plug	-	1	-	50	30800053

<sup>1</sup> multipoint probe

Ilsa

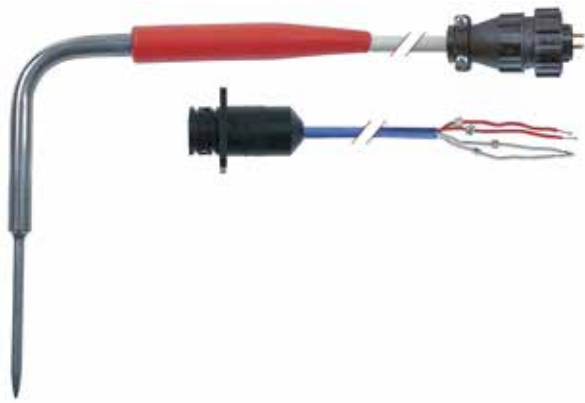

1

fig.	Part No.	probe type	cable	probe temperature (°C)	probe	connection	TS	CL (m)	handle ø (mm)	handle length (mm)	Ref. No.
1	379548	PTC 1kOhm	silicone	-50 up to +150	ø5x70mm	4-wire	-	1.2	10	120	30599

Inoxtrend



1

2

fig.	Part No.	probe type	cable	probe temperature (°C)	probe	connection	TS	CL (m)	handle ø (mm)	handle length (mm)	Ref. No.
1	379597	Pt100	PTFE	-40 up to +250	ø4x100mm	2-wire	-	1.7	10	80	C2209-22
2	379505	Pt1000	PTFE	-40 up to +250	ø4x100mm	2-wire	-	1.7	10	80	C8250-22



## Irinox



fig.	Part No.	probe type	cable	probe temperature (°C)	probe	connection	TS	CL (m)	handle ø (mm)	handle length (mm)	Ref. No.
1	378238	Pt100	silicone	-40 up to +120	ø4.5x70mm	plug	-	1.3	10	120	3805010

## Juno



fig.	Part No.	probe type	cable	probe temperature (°C)	probe	connection	TS	CL (m)	handle ø (mm)	handle length (mm)	Ref. No.
1	379060	Pt1000	SS corrugated hose	-40 up to +250	ø4x100mm	2-wire	M8	2	10	45	002673
1	379061	Pt1000	SS corrugated hose	-40 up to +250	ø4x100mm	2-wire	M8	2.5	10	45	003853
2	379406	Pt1000	SS corrugated hose	-40 up to +250	ø4x100mm	2-wire	M8	2	10	50	006192

## Krefft



fig.	Part No.	probe type	cable	probe temperature (°C)	probe	connection	TS	CL (m)	handle ø (mm)	handle length (mm)	Ref. No.
1	379122	K (NiCr-Ni)	PTFE	-40 up to +250	ø3.2x100mm	2-wire	M12	1.9	10	100	76-30350709
1	379112	Pt100	PTFE	-40 up to +250	ø3.2x100mm	2-wire	M12	2.8	10	80	76-30350703
2	379129 <sup>1</sup>	K (NiCr-Ni)	PTFE	-40 up to +250	ø3.2x100mm	plug	M12	1.9	10	100	—

<sup>1</sup>multipoint probe

## Küppersbusch



fig.	Part No.	probe type	cable	probe temperature (°C)	probe	connection	TS	CL (m)	handle ø (mm)	handle length (mm)	Ref. No.
1	379112	Pt100	PTFE	-40 up to +250	ø3.2x100mm	2-wire	M12	2.8	10	80	407610
2	379109	Pt100	PTFE	-40 up to +250	ø4x100mm	3-wire	M12	2.5	9	60	174464



fig.	Part No.	probe type	cable	probe temperature (°C)	probe	connection	TS	CL (m)	handle ø (mm)	handle length (mm)	Ref. No.
3	379899	Pt1000	TP	-40 up to +250	ø4x100mm	2-wire	M9x1	2	9	65	161634



Lainox

fig.	Part No.	probe type	cable	probe temperature (°C)	probe	connection	TS	CL (m)	handle ø (mm)	handle length (mm)	Ref. No.
1	379510	K (NiCr-Ni)	PTFE	-40 up to +250	ø3.5x90mm		-	1.1	-	90	LAR65321100
1	379773 <sup>1</sup>	K (NiCr-Ni)	PTFE	-40 up to +250	ø3.5x90mm	plug	-	1.1	-	90	LAR65321120
2	379134	Pt100	PTFE	-40 up to +250	ø4x100mm	plug	-	1	15	83	LAR65320900

<sup>1</sup> multipoint probe

fig.	Part No.	probe type	cable	probe temperature (°C)	probe	connection	TS	CL (m)	handle ø (mm)	handle length (mm)	Ref. No.
3	379544	Pt1000	silicone	-40 up to +120	ø4x100mm	2-wire	-	3.6	16	120	SIRRA930013

Lohberger

fig.	Part No.	probe type	cable	probe temperature (°C)	probe	connection	TS	CL (m)	handle ø (mm)	handle length (mm)	Ref. No.
1	401756	PTC 1kOhm	silicone	-40 up to +120	ø4.5x100mm	2-wire	-	4.5	10	120	PO167230

Mareno

fig.	Part No.	probe type	cable	probe temperature (°C)	probe	connection	TS	CL (m)	handle ø (mm)	handle length (mm)	Ref. No.
1	379544	Pt1000	silicone	-40 up to +120	ø4x100mm	2-wire	-	3.6	16	120	RA 930013





## MBM-Italia



fig.	Part No.	probe type	cable	probe temperature (°C)	probe	connection	TS	CL (m)	handle ø (mm)	handle length (mm)	Ref. No.
1	379748	PTC 1kOhm	silicone	-40 up to +120	ø4x75mm	2-wire	-	5	10	120	RIC.S506/3

## MKN



fig.	Part No.	probe type	cable	probe temperature (°C)	probe	connection	TS	CL (m)	handle ø (mm)	handle length (mm)	Ref. No.
1	378124 <sup>1</sup>	K (NiCr-Ni)	PTFE	-40 up to +250	ø4x100mm	4-wire	1/4"	1.5	12	90	203697
1	378125 <sup>1</sup>	K (NiCr-Ni)	PTFE	-40 up to +250	ø4x100mm	4-wire	1/4"	1.9	12	90	203688

<sup>1</sup>multipoint probe

## Palux



fig.	Part No.	probe type	cable	probe temperature (°C)	probe	connection	TS	CL (m)	handle ø (mm)	handle length (mm)	Ref. No.
1	379592 <sup>1</sup>	3 point probe	PTFE	-40 up to +250	ø4x100mm	5-wire	-	4.5	12	85	752363
2	379116	Pt100	PTFE	-40 up to +250	ø4x82mm	2-wire	1/4"	3	12	90	—

<sup>1</sup>multipoint probe

## Pitco

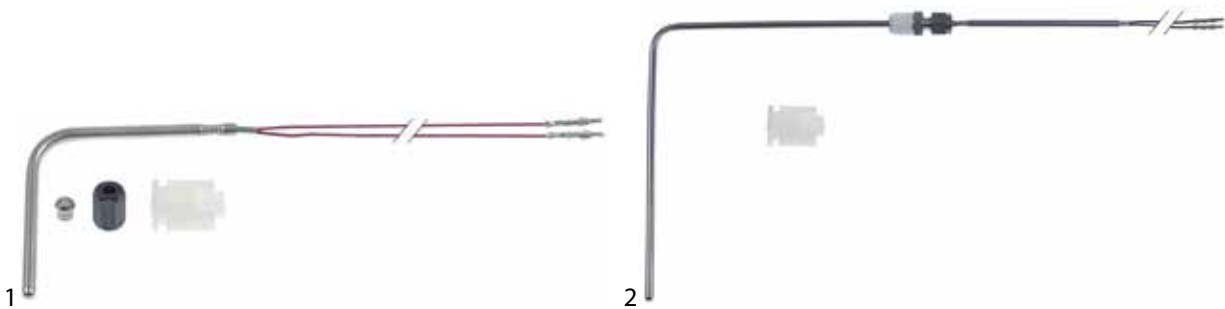

fig.	Part No.	probe type	cable	probe temperature (°C)	probe	connection	TS	CL (m)	handle ø (mm)	handle length (mm)	Ref. No.
1	403489	NTC 100kOhm	PTFE	-40 up to +120	ø4.7x70mm	2-wire	M9	1.12	-	-	60055003-C
2	403493	NTC 10kOhm	PVC	-40 up to +110	ø4.7x270mm	2-wire	M12x1.25	0.4	-	-	60139801







fig.	Part No.	probe type	cable	probe temperature (°C)	probe	connection	TS	CL (m)	handle ø (mm)	handle length (mm)	Ref. No.
3	403492	NTC 10kOhm	PVC	-40 up to +110	ø4.7x270mm	2-wire	M12x1.25	0.8	-	-	P5044882
4	403487	thermocouple	glass fibre	-50 up to +750	ø4.7x140mm	2-wire	M9	0.27	-	-	B3316801-C

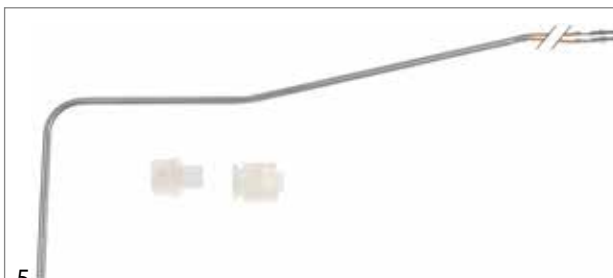



fig.	Part No.	probe type	cable	probe temperature (°C)	probe	connection	TS	CL (m)	handle ø (mm)	handle length (mm)	Ref. No.
5	403490	thermocouple	glass fibre	-50 up to +750	ø4.7x270mm	2-wire	-	0.35	-	-	B6700602-C
6	403488	thermocouple	glass fibre	-50 up to +750	ø4.7x280mm	2-wire	-	0.32	-	-	PP10915

Polaris

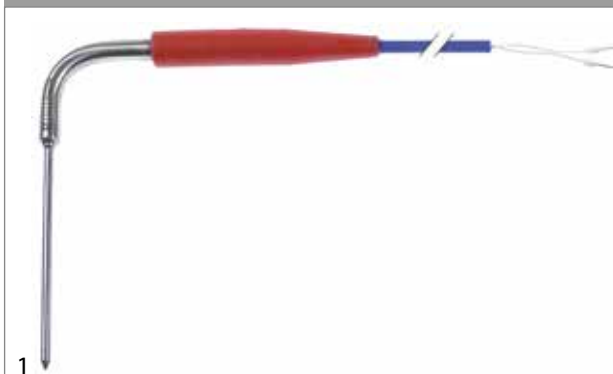

fig.	Part No.	probe type	cable	probe temperature (°C)	probe	connection	TS	CL (m)	handle ø (mm)	handle length (mm)	Ref. No.
1	401756	PTC 1kOhm	silicone	-40 up to +120	ø4.5x100mm	2-wire	-	4.5	10	120	BN167231

Rational





fig.	Part No.	probe type	cable	probe temperature (°C)	probe	connection	TS	CL (m)	handle ø (mm)	handle length (mm)	Ref. No.
1	379122	K (NiCr-Ni)	PTFE	-40 up to +250	ø3.2x100mm	2-wire	M12	1.9	10	100	3035.0709
1	379112	Pt100	PTFE	-40 up to +250	ø3.2x100mm	2-wire	M12	2.8	10	80	3035.0703
2	379792 <sup>1</sup>	K (NiCr-Ni)	PTFE	-40 up to +250	ø3.2x100mm	grip connection	M16x2	1.9	10	40	3035.0717ET

<sup>1</sup> multipoint probe





fig.	Part No.	probe type	cable	probe temperature (°C)	probe	connection	TS	CL (m)	handle ø (mm)	handle length (mm)	Ref. No.
3	379129 <sup>1</sup>	K (NiCr-Ni)	PTFE	-40 up to +250	ø3.2x100mm	plug	M12	1.9	10	100	3035.0717
4	379867	K (NiCr-Ni)	PTFE	-40 up to +250	ø3x100mm	plug	M16	2.2	10	40	87.00.097
4	379868 <sup>1</sup>	K (NiCr-Ni)	PTFE	-40 up to +250	ø3x100mm	plug	M16	2.2	10	40	87.00.096

<sup>1</sup>multipoint probe



fig.	Part No.	probe type	cable	probe temperature (°C)	probe	connection	TS	CL (m)	handle ø (mm)	handle length (mm)	Ref. No.
5	379871	K (NiCr-Ni)	PTFE	-40 up to +250	ø3x100mm	plug	M16	2.2	10	40	40.02.100P
6	379872	K (NiCr-Ni)	PTFE	-40 up to +250	ø3x100mm	plug	M16	2.2	10	40	40.02.102P

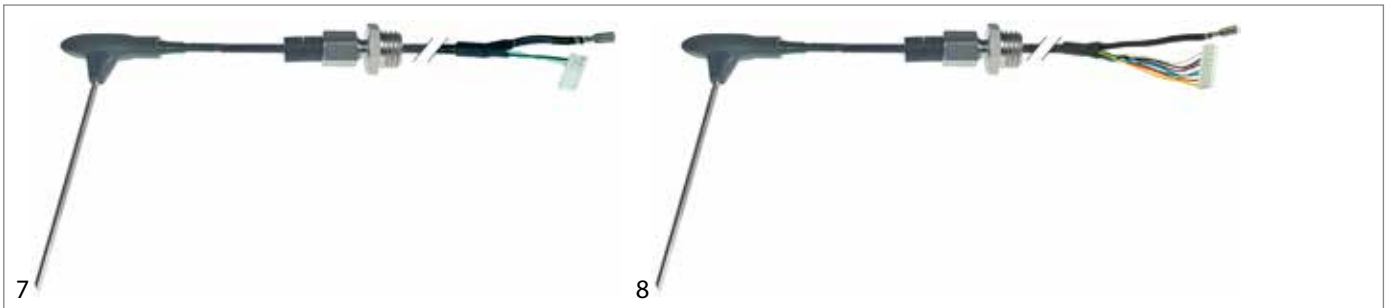

fig.	Part No.	probe type	cable	probe temperature (°C)	probe	connection	TS	CL (m)	handle ø (mm)	handle length (mm)	Ref. No.
7	379865	K (NiCr-Ni)	PTFE	-40 up to +250	ø3x100mm	plug	M16	2.3	-	50	40.00.608P
8	379866 <sup>1</sup>	K (NiCr-Ni)	PTFE	-40 up to +250	ø3x100mm	plug	M16	2.3	-	50	40.00.606P

<sup>1</sup>multipoint probe

Repagas



fig.	Part No.	probe type	cable	probe temperature (°C)	probe	connection	TS	CL (m)	handle ø (mm)	handle length (mm)	Ref. No.
1	379350 <sup>1</sup>	PTC 1kOhm	silicone	-40 up to +120	ø4x100mm	plug	-	1.7	8	120/35	44300003
2	379662 <sup>1</sup>	PTC 1kOhm	silicone	-40 up to +120	ø4x70mm	plug	-	1.3	16	120	—

<sup>1</sup>multipoint probe

Retigo



fig.	Part No.	probe type	cable	probe temperature (°C)	probe	connection	TS	CL (m)	handle ø (mm)	handle length (mm)	Ref. No.
1	381234 <sup>1</sup>	K (NiCr-Ni)	PTFE	-40 up to +250	ø3.9x170mm	coded plug	M16x2	1.4	-	50	EA10-0118
1	381235 <sup>1</sup>	K (NiCr-Ni)	PTFE	-40 up to +250	ø3.9x170mm	coded plug	M16x2	1.8	-	50	EA10-0119
2	381237	K (NiCr-Ni)	PTFE	-40 up to +250	ø3.9x170mm	coded plug	M16x2	1.4	-	50	EA10-0116
2	381236	K (NiCr-Ni)	PTFE	-40 up to +250	ø3.9x170mm	coded plug	M16x2	2.1	-	50	EA10-0117

<sup>1</sup> multipoint probe



fig.	Part No.	probe type	cable	probe temperature (°C)	probe	connection	TS	CL (m)	handle ø (mm)	handle length (mm)	Ref. No.
3	378349 <sup>1</sup>	Pt100	PTFE	-40 up to +250	ø4.5x125mm	coded plug	M12x1.75	1	14	58	EA10-0069
4	378359	Pt100	PTFE	-40 up to +250	ø4x115mm	coded plug	M12x1.75	1.3	14	58	EA10-0055

<sup>1</sup> multipoint probe

Rosinox



fig.	Part No.	probe type	cable	probe temperature (°C)	probe	connection	TS	CL (m)	handle ø (mm)	handle length (mm)	Ref. No.
1	379112	Pt100	PTFE	-40 up to +250	ø3.2x100mm	2-wire	M12	2.8	10	80	RX24849135



## Silko



1	379544	Pt1000	silicone	-40 up to +120	ø4x100mm	2-wire	-	3.6	16	120	SIRRA930013
2	379587 <sup>1</sup>	PTC 1kOhm	silicone	-40 up to +120	ø4x100mm	4-wire	-	6	16	120	FR996452

<sup>1</sup>multipoint probe

## Therma



fig.	Part No.	probe type	cable	probe temperature (°C)	probe	connection	TS	CL (m)	handle ø (mm)	handle length (mm)	Ref. No.
1	379060	Pt1000	SS corrugated hose	-40 up to +250	ø4x100mm	2-wire	M8	2	10	45	002673

## Unox



fig.	Part No.	probe type	cable	probe temperature (°C)	probe	connection	TS	CL (m)	handle ø (mm)	handle length (mm)	Ref. No.
1	378373	Pt100	PTFE	-40 up to +250	ø4x100mm	plug	M10	1.5	12	52	KSN1000A

## Valentine



fig.	Part No.	probe type	cable	probe temperature (°C)	probe	connection	TS	CL (m)	handle ø (mm)	handle length (mm)	Ref. No.
1	379871	K (NiCr-Ni)	PTFE	-40 up to +250	ø3x100mm	plug	M16	2.2	10	40	5175

## Williams



fig.	Part No.	probe type	cable	probe temperature (°C)	probe	connection	TS	CL (m)	handle ø (mm)	handle length (mm)	Ref. No.
1	381317	PTC 20 Ohm	silicone	-40 up to +150	ø5x65mm	2-wire	-	1	25	65	PROBE140



Zanussi



fig.	Part No.	probe type	cable	probe temperature (°C)	probe	connection	TS	CL (m)	handle ø (mm)	handle length (mm)	Ref. No.
1	379718 <sup>1</sup>	K (NiCr-Ni)	PTFE	-40 up to +250	ø3.5x100mm	plug	-	2.2	9	45/50	0C4240
1	379970 <sup>1</sup>	K (NiCr-Ni)	PTFE	-40 up to +250	ø3.5x100mm	plug	-	3.2	9	45/50	0C1404
2	379955	K (NiCr-Ni)	PTFE	-40 up to +250	ø3.5x100mm	plug	-	2.6	9	45/50	007109

<sup>1</sup> multipoint probe

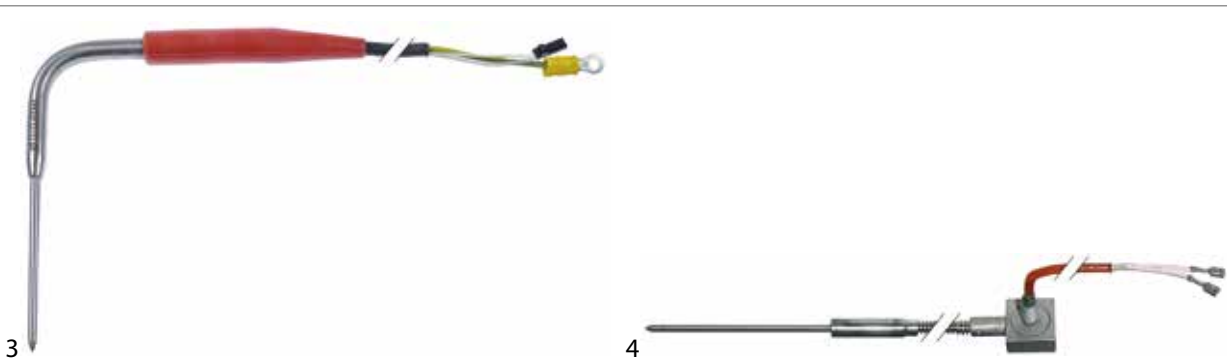

fig.	Part No.	probe type	cable	probe temperature (°C)	probe	connection	TS	CL (m)	handle ø (mm)	handle length (mm)	Ref. No.
3	401944	NTC 10kOhm	silicone	-40 up to +120	ø5x80mm	plug	-	3	10	100	092704
4	379060	Pt1000	SS corrugated hose	-40 up to +250	ø4x100mm	2-wire	M8	2	10	45	002673
4	379061	Pt1000	SS corrugated hose	-40 up to +250	ø4x100mm	2-wire	M8	2.5	10	45	003853

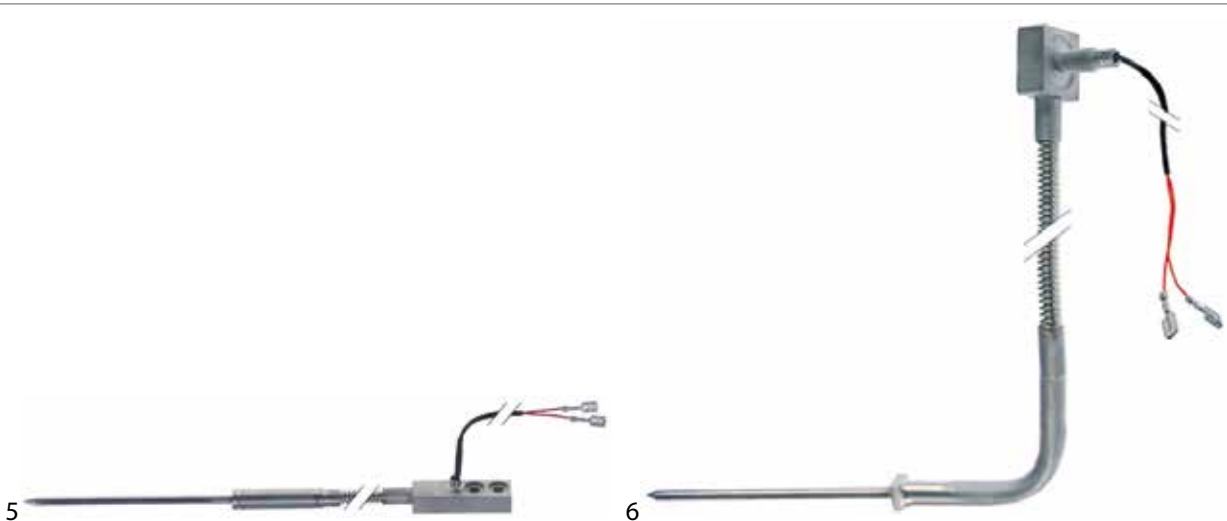

fig.	Part No.	probe type	cable	probe temperature (°C)	probe	connection	TS	CL (m)	handle ø (mm)	handle length (mm)	Ref. No.
5	379406	Pt1000	SS corrugated hose	-40 up to +250	ø4x100mm	2-wire	M8	2	10	50	006192
6	379976	Pt1000	SS corrugated hose	-40 up to +250	ø4x100mm	F6.3	M8	3.1	9	50/55	002821

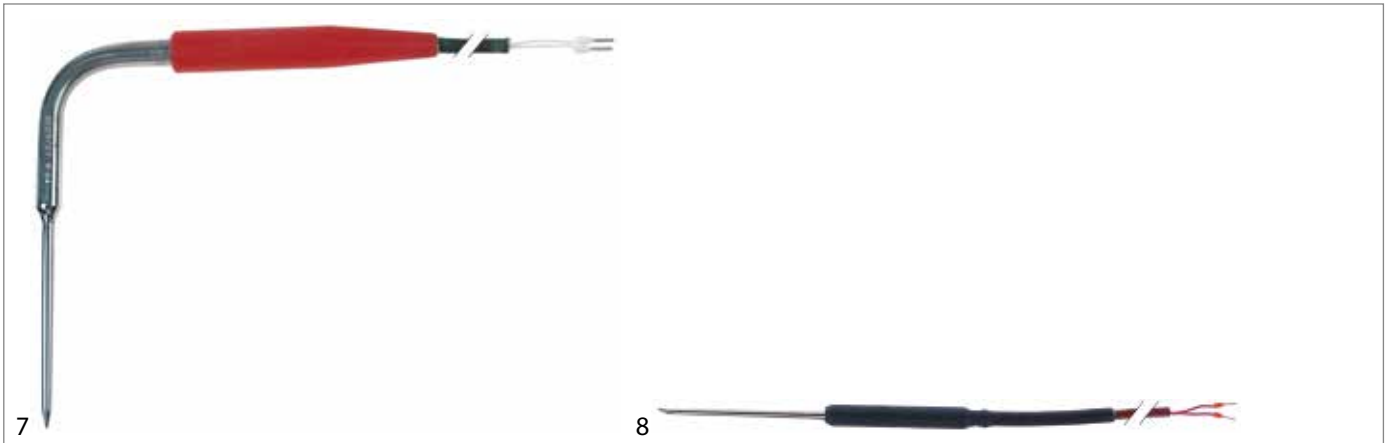

fig.	Part No.	probe type	cable	probe temperature (°C)	probe	connection	TS	CL (m)	handle ø (mm)	handle length (mm)	Ref. No.
7	379620	PTC 1kOhm	silicone	-40 up to +120	ø4.5x80mm	2-wire	-	4	10	120	088044
8	378185	PTC 1kOhm	silicone	-50 up to +150	ø5x100mm	2-wire	-	3	13.5	90	083582

Hall sensors

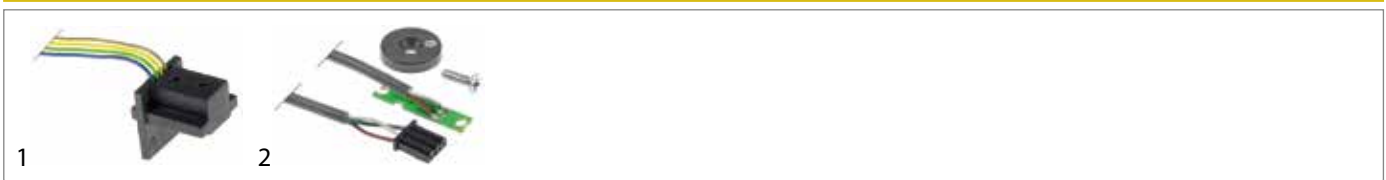

fig.	Part No.	L (mm)	W (mm)	H (mm)	suitable for	Ref. No.	fig.	Part No.	L (mm)	W (mm)	H (mm)	suitable for	Ref. No.
1	402044	29	26	26	Anitec Icematic Scotsman Simag Star10	FR.62040403 29070015/0 62040403 62040403 FR.62040403	2	403435	38	8	4	Unox	KPE1710A

sensors



fig.	Part No.	description	suitable for	Ref. No.
1	379966	lambda sensor probe ø 12mm 5-pole probe length 50mm	Electrolux Junkers Zanussi	0C6465 0258004010 0C6465
2	403155	sensor for induction device ø 25mm H 17mm cable length 130mm	Horeca-Select	GIC3035-B03
2	403158	sensor for induction wok ø 25mm H 17mm cable length 130mm	Horeca-Select	GIC4035-C03
3	403316	sensor for induction device ø M12x1mm L 73mm	Comenda	120355
4	401611	sensor ice thickness ø 18mm L 44mm thread M10x1 cable length 1450mm	Brema Electrolux NTF	R231028 099774 N23676



accessories

fasteners

1		2		3		4	
fig.	Part No.	description	suitable for	Ref. No.			
1	691084	duct for probe	Fagor	12023773			
2	691098	holding plate for probe mounting pos. bottom L 35mm W 12mm H 4mm SS	Fagor	12024243			
3	691097	holding plate for probe mounting pos. upper L 35mm W 12mm H 4mm SS	Fagor	12024241			
4	692373	probe clip for temperature probe L 50mm W 31mm H 6mm SS hole ø 5mm hole distance 30mm Qty 1 pcs	Horeca-Select	S900.31			
4	692251	probe clip for temperature probe L 50mm W 31mm H 6mm SS hole ø 5mm hole distance 30mm Qty 10 pcs	Horeca-Select	S900.31			

probe extension cables

1	
fig.	Part No. description
1	379163 extension cable NTC PVC 3x0,5mm² length supplied by meter shielded

plugs/bushes

1			
fig.	Part No. description	suitable for	Ref. No.
1	378375 female connector for core temperature probe 2-pole	Unox	TR21

2			
fig.	Part No. description	suitable for	Ref. No.
2	378017 lid for plug contact	Ambach Cookmax Lainox	LAR65321020 LAR65321020 LAR65321020

3			
fig.	Part No. description	suitable for	Ref. No.
3	378376 lid for plug contact	Unox	TR22

4			
fig.	Part No. description	suitable for	Ref. No.
4	378016 connector 4-pole	Ambach Cookmax Lainox	LAR65320920 LAR65320920 LAR65320920

screw connections

1		2		3		4	
fig.	Part No. description	suitable for	Ref. No.				
1	379986 screw connection L 34mm	—	—				
2	550366 screw for thermocouple	Fagor Krefft Rational	12037422 76-30140163 3014.0163				
3	691086 union screw	Fagor	12023581				
4	379636 union screw set M8x1 probe ø 5mm	Capic	G701005				

miscellaneous

1			
fig.	Part No. description	suitable for	Ref. No.
1	379856 case for core temperature probe	Ambach Cookmax Lainox	R86020420 R86020420 LAR86020420

2			
fig.	Part No. description	suitable for	Ref. No.
2	402040 cable for level electrode cable length 1800mm	Electrolux Icematic Scotsman Simag	086347 CF62040404 1129159S&P 62040413

3			
fig.	Part No. description	suitable for	Ref. No.
3	379905 extension	Elettrobar	231008

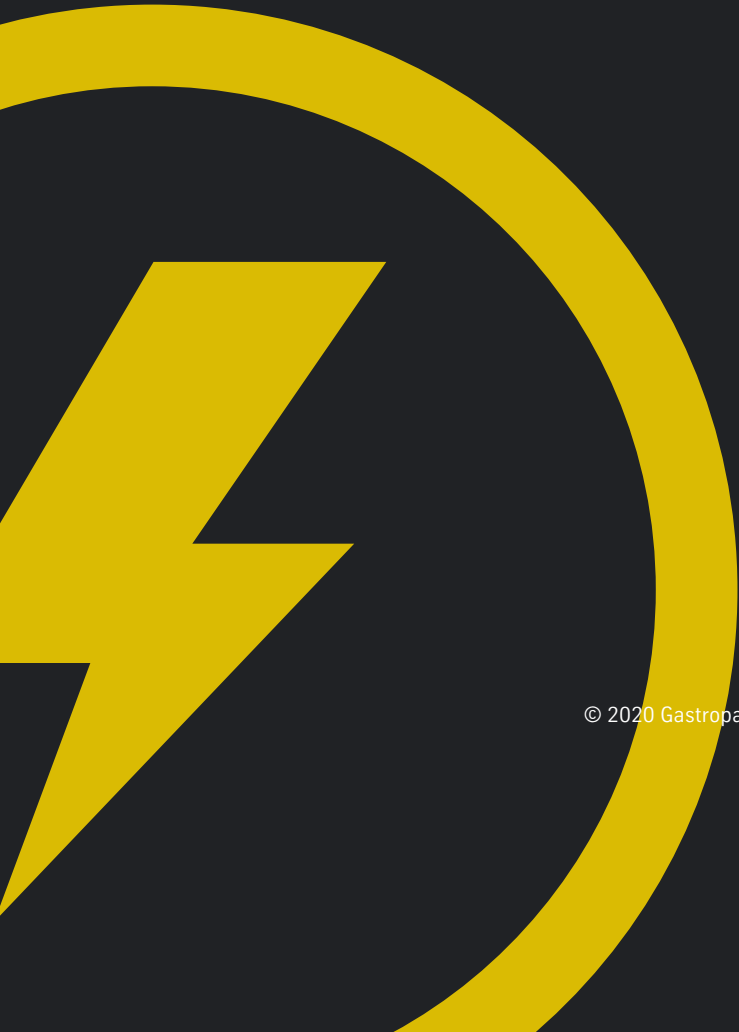



fig.	Part No.	description	suitable for	Ref. No.
4	550924	gasket for probe ID $\varnothing$ 6mm EPDM	Electrolux Therma Zanussi	002075 002075 002075
5	550365	gasket for thermocouple	Fagor Krefft Rational	12037350 76-30140162 3014.0162
6	691085	bush for probe	Fagor	12024247
7	697993	sleeve for temperature probe $\varnothing$ 11mm ID $\varnothing$ 4,3mm H 22,4mm	Electrolux	002701

fig.	Part No.	description	suitable for	Ref. No.
8	379179	sleeve 1/2"	—	—

**GASTROPARTS.COM**



© 2020 Gastroparts Sp. J. All rights reserved.