



**GASTROPARTS**

Universal Catalogue › Electric Components ›

# [EN] Solenoid valves

[DE] Magnetventile

[ES] Válvulas magnéticas

[FR] Électrovannes

[IT] Elettrovalvole

[PL] Elektrozawory

[RU] Электромагнитные клапаны

✉ [gastroparts@gastroparts.com](mailto:gastroparts@gastroparts.com)

☎ tel. +48 56 657 00 66

📘 [fb.com/gastroparts.global](https://fb.com/gastroparts.global)

**GASTROPARTS.COM**





# solenoid valves

# 20

solenoid valves (water).	650
drain valves.	666
solenoid valves (gas).	667
solenoid valves (refrigeration).	668
solenoid valves for vacuum machines	669



## solenoid valves

## solenoid valves (water)

EATON/INVENSY

medium temperature: 90°C 90°C 60°C  
 ambient temperature: 60°C 25°C 60°C  
 duty cycle: 40% 100% 100%



fig.	Part No.	version	volt. (V)	inlet	outlet (mm)	nominal size
1	370723	single	24	3/4"	11.5	DN10
1	370753	single	24	3/4"	6	DN10
1	372017	single	230	3/4"	11.5	DN10
1	372018	single	230	3/4"	14	DN10
1	372046	single	230	3/4"	14	DN10
2	372003	single	230	3/4"	10	DN10
3	370724	double	24	3/4"	11.5	DN10
3	372021	double	230	3/4"	11.5	DN10
3	372022	double	230	3/4"	14	DN10



fig.	Part No.	version	volt. (V)	inlet	outlet (mm)	nominal size
4	372025	triple	230	3/4"	11.5	DN10



fig.	Part No.	version	volt. (V)	inlet	outlet (mm)	nominal size
1	372015	single	230	3/4"	11.5	DN10
1	372016	single	230	3/4"	14	DN10
2	372019	double	230	3/4"	11.5	DN10
2	372020	double	230	3/4"	14	DN10
3	372023	triple	230	3/4"	11.5	DN10



fig.	Part No.	version	volt. (V)	inlet	outlet (mm)	nominal size	CL (mm)
1	370370	single	230	3/4"	11.5	DN10	2000
2	370372	single	230	3/4"	11.5	DN10	2000
3	370371	double	230	3/4"	11.5	DN10	2000

## with coded terminal

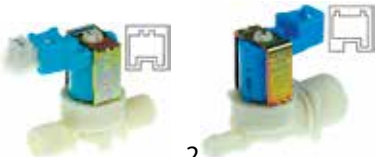

fig.	Part No.	version	inlet	outlet (mm)	nominal size
1	370270	single	3/8"	3/8"	DN10
2	370267	single	3/4"	11.5	DN10

**technical data:**  
voltage 230V

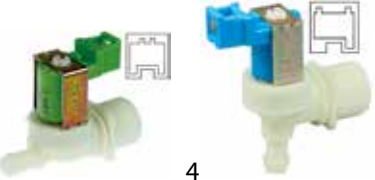

fig.	Part No.	version	inlet	outlet (mm)	nominal size
3	370268	single	3/4"	11.5	DN10
4	370355	single	3/4"	11.5	DN10

**technical data:**  
voltage 230V

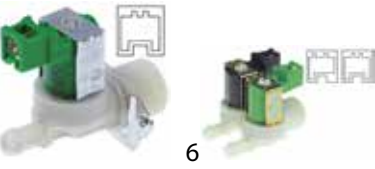

fig.	Part No.	version	inlet	outlet (mm)	nominal size
5	370671	single	3/4"	11.5	DN10
6	370266	double	3/4"	11.5	DN10

**technical data:**  
voltage 230V



fig.	Part No.	version	inlet	outlet (mm)	nominal size
7	370269	double	3/4"	11.5	DN10

**technical data:**  
voltage 230V

## spare parts and accessories

## solenoid coils

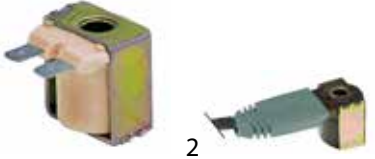

fig.	Part No.	volt. (V)	voltage	fig.	Part No.	volt. (V)	voltage
1	371132	24	AC	2	371081	230	AC
1	371131	230	AC				



solenoid coils with coded terminal



fig.	Part No.	volt. (V)	voltage	fig.	Part No.	volt. (V)	voltage
1	371133	230	AC	3	371174	230	AC
2	371134	230	AC				



fig.	Part No.	volt. (V)	voltage
4	371175	230	AC

reducers

outlet side



**technical data:**  
pressure range 0 up to 10bar  
tolerance ±15/25%

fig.	Part No.	flow rate (l/min)	colour	fig.	Part No.	flow rate (l/min)	colour
1	371250	0.25	white	1	371253	2.5	brown
1	371251	0.5	yellow	1	371254	3.3	violet
1	371252	1.2	blue	1	371255	5	black

inlet side



**technical data:**  
type EATON (INVENSYS)  
tolerance ±15/25%

fig.	Part No.	flow rate (l/min)	pressure range (bar)	colour
1	371241	5.5	1-10	yellow
1	371243	10	1-10	white
1	371244	12	0 up to 10	white

ELBI

medium temperature: 90°C 90°C 60°C  
ambient temperature: 60°C 25°C 60°C  
duty cycle: 40% 100% 100%

straight



fig.	Part No.	version	volt. (V)	inlet	outlet (mm)	nominal size
1	373017	single	230	3/4"	11.5	DN10
1	373018	single	230	3/4"	14	DN10
2	373021	double	230	3/4"	11.5	DN10
2	373022	double	230	3/4"	14	DN10
3	373025	triple	230	3/4"	11.5	DN10

angled



fig.	Part No.	version	volt. (V)	inlet	outlet (mm)	nominal size
1	374072	single	24	3/4"	11.5	
2	370733	single	24	3/4"	11.5	DN10
2	373015	single	230	3/4"	11.5	DN10
2	373016	single	230	3/4"	14	DN10
3	370712	double	24	3/4"	11.5	DN10
3	373019	double	230	3/4"	11.5	DN10



fig.	Part No.	version	volt. (V)	inlet	outlet (mm)	nominal size
4	373023	triple	230	3/4"	11.5	DN10

spare parts and accessories

solenoid coils



fig.	Part No.	volt. (V)	voltage	fig.	Part No.	volt. (V)	voltage
1	371014	24	AC	2	371016	230	AC

ELTEK

medium temperature: 90°C 90°C 60°C  
ambient temperature: 60°C 25°C 60°C  
duty cycle: 40% 100% 100%



fig.	Part No.	version	volt. (V)	inlet	outlet (mm)	nominal size
1	370750	single	230	3/4"	11.5	DN10
1	370779	single	230	3/4"	11.5	DN10
2	370781	double	230	3/4"	11.5	DN10
3	370780	double	230	3/4"	11.5	DN10
3	370778	double	230	3/4"	11.5	DN10



## INTERELEKTRIK

medium temperature: 90°C 90°C 60°C  
 ambient temperature: 60°C 25°C 60°C  
 duty cycle: 40% 100% 100%



fig.	Part No.	volt. (V)	inlet	outlet (mm)
1	370688	220/240	3/4"	13.5

## with reducers

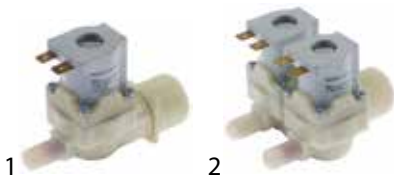

fig.	Part No.	volt. (V)	inlet	outlet (mm)	input (l/min)	output (l/min)
1	370675	230	3/4"	10.5	5	
1	370676	230	3/4"	10.5	15	
1	370746	220/240	3/4"	10.5		3
2	370747	220/240	3/4"	10.5		

## MÜLLER

medium temperature: 90°C  
 duty cycle: 100%



fig.	Part No.	version	volt. (V)	inlet	outlet (mm)	nominal size
1	370751	single	24	3/4"	3/4"	DN10
1	370005	single	230	1/2"	1/2"	DN10
1	370007	single	230	3/4"	3/4"	DN10
1	370173	single	230	3/4"	3/4"	DN17
2	370002	single	230	3/4"	14.5	DN10
2	370117	single	230	3/4"	11.5	DN10
3	370715	single	230	3/4"	3/8"	DN10



fig.	Part No.	version	volt. (V)	inlet	outlet (mm)	nominal size
4	370004	double	230	3/4"	14.5	DN10
4	370158	double	230	3/4"	11.5	DN10
5	370008	triple	230	3/4"	14.5	DN10
5	370172	triple	230	3/4"	11.5	DN10



fig.	Part No.	version	inlet	outlet (mm)	nominal size
1	370001	single	3/4"	14.5	DN10
1	370074	single	3/4"	11.5	DN10
2	370003	double	3/4"	14.5	DN10
2	370094	double	3/4"	11.5	DN10



fig.	Part No.	version	inlet	outlet (mm)	nominal size
3	370000	triple	3/4"	14.5	DN10

## with cable connection



fig.	Part No.	version	inlet	outlet (mm)	nominal size	CL (mm)
1	370006	triple	3/4"	12.5	DN10	2000



fig.	Part No.	version	inlet	outlet (mm)	nominal size	CL (mm)
1	370369	single	3/4"	14.5	DN10	2000

## spare parts and accessories

## valve bodies



fig.	Part No.	version	inlet	outlet (mm)	nominal size
1	370127	single	3/4"	14.5	DN10
1	370133	single	3/4"	11.5	DN10
2	370667	single	3/4"	3/4"	DN10
3	370179	single	3/4"	3/4"	DN17



fig.	Part No.	version	inlet	outlet (mm)	nominal size
4	370129	double	3/4"	14.5	DN10
4	370195	double	3/4"	11.5	DN10
5	370131	triple	3/4"	14.5	DN10
5	370132	triple	3/4"	11.5	DN10

**technical data:**  
voltage 230V

fig.	Part No.	version	inlet	outlet (mm)	nominal size
1	370126	single	3/4"	14.5	DN10
1	370193	single	3/4"	11.5	DN10
2	370128	double	3/4"	14.5	DN10

spare parts sets

fig.	Part No.	description
1	371011	spare parts kit 8 MÜLLER

solenoid coils

fig.	Part No.	volt. (V)	voltage	connection
1	371037	24	AC	F6.3
1	370570	24	DC	F6.3
1	371017	230	AC	F6.3
2	371038	230	AC	appliance plug

reducers

outlet side

**technical data:**  
type MR05  
mounting measurements 9,5mm  
nominal flow at 4bar  
pressure range 1-10bar  
approval KTW

fig.	Part No.	flow rate (l/min)	tolerance (%)	colour
1	371275	3	±20	violet
1	371277	5	±20	red

inlet side

**technical data:**  
type MR04  
mounting measurements 19mm  
nominal flow at 4bar  
approval KTW

fig.	Part No.	flow rate (l/min)	pressure range (bar)	tolerance (%)	colour
1	371200	5	0 up to 10	±15	red
1	371201	8	0 up to 10	±15	black
1	371202	10	0 up to 10	±15	white
1	371203	12	1-10	±15	orange
1	371204	14	1-10	±15	light blue
1	371205	15	1-10	±15	violet

**technical data:**  
type MR06  
mounting measurements 19mm  
nominal flow at 4bar  
approval KTW

fig.	Part No.	flow rate (l/min)	pressure range (bar)	tolerance (%)	colour
1	371210	0.5	1-10	±50	yellow
1	371211	1	1-10	±30	pink
1	371213	1.9	1-10	±25	black
1	371214	2.5	1-10	±20	green
1	371215	3	1-10	±20	violet
1	371216	3.5	0 up to 10	±20	dark blue

filters

fig.	Part No.	description
1	370551	screen for solenoid valve ø 12mm L 24mm
2	371122	solenoid valve filter ø 19mm H 10mm
3	501064	solenoid valve filter SS filter

miscellaneous

fig.	Part No.	description
1	371009	compression spring for solenoid coil
2	371002	solenoid valve holder flange support





## RPE

medium temperature: 90°C 90°C 60°C  
 ambient temperature: 60°C 25°C 60°C  
 duty cycle: 40% 100% 100%



fig.	Part No.	version	volt. (V)	inlet	outlet (mm)	nominal size
1	374067	single	230	3/8"	3/8"	DN10
1	370123	single	230	1/2"	1/2"	DN10
1	374068	single	230	3/4"	3/4"	DN10
2	374063	single	230	3/8" IT	3/8" IT	DN11
3	370009	single	230	3/4"	3/4"	DN10



fig.	Part No.	version	volt. (V)	inlet	outlet (mm)	nominal size
4	374017	single	230	3/4"	10	DN10
4	374006	single	230	3/4"	13	DN10
5	370441	single	-	3/4"		
6	370758	double	24	3/4"	10	DN10
6	374021	double	230	3/4"	10	DN10
6	374022	double	230	3/4"	13	DN10



fig.	Part No.	version	volt. (V)	inlet	outlet (mm)	nominal size
7	370760	double	24	3/4"	10	DN10
8	370379	double	230	3/4"	1/4"	DN10
9	374025	triple	230	3/4"	10	DN10



fig.	Part No.	version	volt. (V)	inlet	outlet (mm)	nominal size
1	374060	single	24	3/4"	13	DN10
1	374016	single	230	3/4"	13	DN10
2	374015	single	230	3/4"	10	DN10
3	374019	double	230	3/4"	10	DN10
3	374020	double	230	3/4"	13	DN10



fig.	Part No.	version	volt. (V)	inlet	outlet (mm)	nominal size
4	371148	triple	230	3/4"	13	DN10
5	374027	4-fold	230	3/4"	10	DN10

## JOHN GUEST



fig.	Part No.	version	volt. (V)	inlet	outlet (mm)
1	370771	single	230	3/4"	JG 8
1	374064	single	230	3/4"	JG 10
2	374070	single	230	JG 10	JG 10
2	374069	single	230	JG 8	JG 8
3	370772	double	230	3/4"	JG 8
3	374065	double	230	3/4"	JG 10



fig.	Part No.	version	volt. (V)	inlet	outlet (mm)
4	370773	triple	230	3/4"	JG 8
4	374066	triple	230	3/4"	JG 10



fig.	Part No.	version	volt. (V)	inlet	outlet (mm)
1	370768 <sup>1</sup>	single	230	3/4"	10
2	370769 <sup>1</sup>	double	230	3/4"	10
3	374077 <sup>1</sup>	double	230	3/4"	10

<sup>1</sup>cylindrical outlet

fig.	Part No.	version	volt. (V)	inlet	outlet (mm)
4	370770 <sup>1</sup>	triple	230	3/4"	10

<sup>1</sup>cylindrical outlet



special outlet



fig.	Part No.	version	volt. (V)	inlet	outlet (mm)
1	371229	single	24	3/4"	6.5
2	371228	double	24	3/4"	6.5
3	371227	triple	24	3/4"	6.5



fig.	Part No.	version	volt. (V)	inlet	outlet (mm)
4	370453	single	230	11.5	11.5

reducers

outlet side



pos.	Part No.	flow rate (l/min)	colour
1	371269	0.15	brown
2	371266	0.2	red
3	371268	0.25	green
4	371265	3	black
5	374084	7-10	orange
6	374088	0.6-0.7	grey
7	371249	0.7-1	light grey
8	371248	1.0-1.25	white
9	374087	1.5-1.85	yellow
10	374086	1.85-2.35	violet
11	374085	4.5-6	blue

inlet side



fig.	Part No.	flow rate (l/min)	colour	fig.	Part No.	flow rate (l/min)	colour
1	371256	10-12	white	1	374081	6-7	red
1	374083	18.5-20	black	1	374082	7-8.5	brown
1	374080	4-4.5	yellow	2	371257	18.5-20	grey

solenoid coils



fig.	Part No.	volt. (V)	voltage	fig.	Part No.	volt. (V)	voltage
1	370774	24	AC	1	371015	230	AC

TP

medium temperature: 90°C 90°C 60°C  
 ambient temperature: 60°C 25°C 60°C  
 duty cycle: 40% 100% 100%



fig.	Part No.	version	volt. (V)	inlet	outlet (mm)	nominal size
1	370029	single	24	3/4"	11.5	DN10
1	370032	single	24	3/4"	14	DN10
1	370017	single	230	3/4"	11.5	DN10
1	370018	single	230	3/4"	14	DN10
2	370111	double	24	3/4"	11.5	DN10
2	370112	double	24	3/4"	14	DN10
2	370022	double	230	3/4"	14	DN10
2	370021	double	230	3/4"	11.5	DN10
3	370115	triple	24	3/4"	11.5	DN10
3	370025	triple	230	3/4"	11.5	DN10
3	370026	triple	230	3/4"	14	DN10



fig.	Part No.	version	volt. (V)	inlet	outlet (mm)	nominal size
1	370030	single	24	3/4"	11.5	DN10
1	370031	single	24	3/4"	14	DN10
1	370015	single	230	3/4"	11.5	DN10
1	370016	single	230	3/4"	14	DN10
2	370109	double	24	3/4"	11.5	DN10
2	370110	double	24	3/4"	14	DN10
2	370019	double	230	3/4"	11.5	DN10
2	370020	double	230	3/4"	14	DN10
3	370113	triple	24	3/4"	11.5	DN10
3	370023	triple	230	3/4"	11.5	DN10
3	370024	triple	230	3/4"	14	DN10





## spare parts and accessories

## solenoid coils



fig.	Part No.	volt. (V)	voltage	fig.	Part No.	volt. (V)	voltage
1	371035	24	AC	1	371013	230	AC
1	371156	24	DC	1	371199	230	AC

## reducers

## outlet side



fig.	Part No.	flow rate (l/min)	tolerance (%)	colour
1	691081	0.25	±25	green
1	691080	3	±25	light green
1	691082	8	±25	violet
2	371230	0.25	±25	red
2	371233	0.8	±25	white
2	371234	1	±25	light blue
2	371235	1.2	±25	brown
2	371236	1.5	±25	light brown
2	371237	2.5	±25	yellow
2	371238	3.4	±25	dark green
2	371239	5	±25	black

## inlet side



fig.	Part No.	flow rate (l/min)	tolerance (%)	colour
1	371220	3	±15	red
1	371221	5.5	±15	yellow
1	371222	6	±15	grey
1	371223	10	±15	white
1	371224	12	±15	blue
1	371226	20	±15	brilliant-red
1	371218	20	±15	orange

## various



fig.	Part No.	description
1	370310	solenoid valve 2-fold, with reducer straight
2	370673	solenoid valve 3-way 230V BÜRKERT
3	370726	solenoid valve double straight 220-240V AC inlet 11 outlet 11mm plastic MILANO output B red



fig.	Part No.	description
4	370641	solenoid valve plastic 220-240V inlet 10mm outlet 10mm
5	370596	solenoid valve plastic 230V AC
6	370636	solenoid valve single 2-ways 230V inlet 10,5mm outlet 10,5mm MILANO 00168401 plastic



fig.	Part No.	description
7	370650	solenoid valve single angled 220/240V outlet 11mm inlet 12,4mm 50/60Hz
8	371141	solenoid valve single angled 240V inlet 15mm outlet 11,5mm
9	370493	solenoid valve single angled 24V inlet 5/8" UNFmm outlet 11,5mm EATON (INVENSYS) plastic



fig.	Part No.	description
10	370156	solenoid valve single straight
11	370487	solenoid valve single straight 24V AC inlet 3/4" outlet 11,5mm DN10 t.max. 25°C duty cycle 100%
12	372216	solenoid valve with pressure switch single, angled 230V inlet 3/4"mm outlet 11mm



metal

ASCO

2-way



fig.	Part No.	supply	connection	DN (mm)	slide-on receptacle	temp. (°C)	coil type	membranes	p max (bar)
1	370509	24 VAC	1/2"	12.5	DIN	-20° up to 85		NBR (water)	7
2	370786	230 VAC	1/2"				238613-059		
3	370121	230 VAC	1/2"	16	DIN	-20° up to 85	400425-217	NBR (water)	9
3	370198	230 VAC	3/4"	19	DIN	-20° up to 85	400425-117	NBR (water)	20
4	370124	230VAC		16	DIN	-20° up to 85	400325-110	NBR (water)	10

3-way



**technical data:**  
 temperature range -20 up to +90°C  
 membranes NBR (water)  
 pressure max 3bar

fig.	Part No.	description	supply	connection	L (mm)	DN (mm)
1	370510	solenoid valve brass 3-ways 24V AC L 43mm 1/4"	24 VAC	1/4"	43	4.4

solenoid valves steam (water)

2-way



**technical data:**  
 slide-on receptacle DIN

fig.	Part No.	supply	connection	DN (mm)	temp. (°C)	coil type	membranes	p max (bar)
1	370728	24 VAC	1/2"	12	-10 up to +85	43005421	NBR	10
2	370134 <sup>1</sup>	230 VAC	1/2"	9.5	-20° up to 135	400425-117	PTFE (water/steam)	2
3	370260	230 VAC	1/2"	16	-20° up to 184	400426-217	PTFE (water/steam)	9
3	370258 <sup>1</sup>	230 VAC	3/4"	19	-20° up to 184	400425-117	PTFE (water/steam)	9

<sup>1</sup>off-current open

spare parts and accessories

solenoid coils



fig.	Part No.	volt. (V)	voltage	coil type
1	371136	230	AC	400425-217

O-rings



fig.	Part No.	ID ø (mm)	Qty (pcs)	fig.	Part No.	ID ø (mm)	Qty (pcs)
1	371095	6.07	1	2	371100	6.07	1



## power sockets



fig.	Part No.	plug type	CL (mm)	features
1	371093	compact	1100	small

## BÜRKERT

## 2-way

## 6213 series



**technical data:**  
slide-on receptacle DIN  
temperature range -30° up to 120°C  
membranes EPDM  
pressure max 10bar

fig.	Part No.	supply	connection	DN (mm)
1	370274	230 VAC	1/2"	10
2	370275	230 VAC	3/4"	13

## solenoid valves steam (water)

## 2-way

## 0406 series



**technical data:**  
slide-on receptacle  
temperature range 180°C  
pressure max bar

fig.	Part No.	supply	connection	DN (mm)	membranes
1	370276	230 VAC	1/2"	12	PTFE

## solenoid valves (various)



fig.	Part No.	description
1	370143	solenoid valve 2-way 196V DC BÜRKERT
2	370741	solenoid valve 2-ways 230 VAC inlet 1/2" IT
3	370464	solenoid valve brass 2-ways 24V AC connection 1/2"



fig.	Part No.	description
4	370544	solenoid valve brass 2-ways 24V inlet 1/2" outlet 1/2"

## CEME

## solenoid valves



fig.	Part No.	description
1	370348	solenoid valve 2-ways 230 VAC connection 1/2" L 60mm
2	370352	solenoid valve 2-ways 230 VAC inlet 1/2" IT
3	370633	solenoid valve brass 3-ways 230V AC



fig.	Part No.	description
4	370238	solenoid valve brass 3-ways coffee machine parts

## accessories



fig.	Part No.	description
1	371189	solenoid coil 240V seat ø 13mm
2	371154	solenoid coil CEME type 1W7 230V AC 50Hz
3	371188	solenoid coil type H 230V 17VA 50Hz seat ø 13mm

## LUCIFER

## 2-way

## 121K series



**technical data:**  
temperature range -20° up to 130°C

fig.	Part No.	supply	connection	DN (mm)	coil type	membranes	p max (bar)
1	370224	24 VAC	1/8"	3	DZ02A2	FKM (water)	10
1	370072	230 VAC	1/8"	3	DZ06S6	FKM (water)	10
1	370088	230 VAC	1/4"	3	DZ06S6	FKM (water)	10
2	370708	230 VAC	1/4"	5		EPDM	7



121Z series



**technical data:**  
length mm  
nominal size 2,5mm  
slide-on receptacle DIN  
temperature range -20° up to 130°C  
pressure max 10bar

fig.	Part No.	supply	connection	coil type	membranes
1	370230	24VDC	1/8"	DZ02C2	FKM (water)
1	370071	230 VAC	1/8"	DZ06S6	FKM (water)

7321(PM133) series



**technical data:**  
length 100mm  
nominal size 20mm  
slide-on receptacle DIN  
temperature range fixed 90°C  
pressure max 20bar

fig.	Part No.	supply	connection	coil type	membranes
1	371184	24 VAC	3/4"	DZ02A2	NBR (water)
1	371183	230 VAC	3/4"	DZ06S6	NBR (water)

2-way

121F series



**technical data:**  
number of ways 2-ways  
supply 230 VAC  
nominal size 3,5mm  
slide-on receptacle DIN  
temperature range -10 up to 140°C  
pressure max 10bar  
flange size 32x32mm

fig.	Part No.	coil type	membranes
1	370211	DZ06S6	ruby

7321(PM143) series



**technical data:**  
slide-on receptacle DIN  
temperature range fixed 140°C  
membranes EPDM (steam/ water)  
pressure max 10bar

fig.	Part No.	supply	connection	DN (mm)	coil type
1	371186	230 VAC	1/2"	12	DZ06S6
1	371187	230 VAC	3/4"	20	DZ06S6



**technical data:**  
slide-on receptacle DIN  
temperature range fixed 90°C  
membranes NBR (water)  
pressure max 20bar

fig.	Part No.	supply	connection	DN (mm)	coil type
1	371182	24 VAC	1/2"	12	DZ02A2
1	371179	230 VAC	3/8"	12	DZ06S6
1	371181	230 VAC	1/2"	12	DZ06S6

3-way

131F series



**technical data:**  
temperature range -10 up to 140°C  
pressure max 10bar  
flange size 32x32mm

fig.	Part No.	supply	DN (mm)	coil type	membranes
1	370054	24 VAC	2.5	DZ06P0	FKM (water/steam)
1	370051	24VDC	2.5	DZ02C2	FKM (water/steam)
2	370593 <sup>1</sup>	24 VAC	1.5/2.5	483510P0 XS03M F	ruby

<sup>1</sup>nickel-plated



**technical data:**  
temperature range -10 up to 140°C  
pressure max 10bar  
flange size 32x32mm

fig.	Part No.	supply	DN (mm)	coil type	membranes
3	370053	230 VAC	2.5	DZ06S6	FKM (water/steam)
4	370776	230 VAC	1.5/2.5	DZ06S6	ruby

spare parts and accessories

solenoid coils



fig.	Part No.	volt. (V)	voltage	power (VA)	coil type
1	371031	230	AC	9	DZ06S6
1	371032	24	AC	9	DZ06P0
1	371043	24	DC	9	DZ02C2
2	371083	24	AC	9	DZ02A2
3	371258	220	AC	14	EZ92A7

valve bodies



fig.	Part No.	description
1	370061	solenoid valve body LUCIFER-PARKER 3-ways



## M&amp;M

## 2-way

## B-240 series



1

**technical data:**  
temperature range -20° up to 130°C  
coil type 2700  
membranes FKM (water)  
pressure max 18bar  
pressure min 0bar

fig.	Part No.	supply	DN (mm)	flange (mm)
1	370068	230 VAC	1.5	32x32

## B-297 series



1

**technical data:**  
temperature range -10 up to 130°C  
coil type 2700  
membranes FKM (water)  
pressure max 5bar  
pressure min 0bar

fig.	Part No.	supply	connection	L (mm)	DN (mm)
1	370096	230 VAC	1/8"	30	2.5

## B204/205/206 series



1

**technical data:**  
temperature range -10 up to +90°C  
coil type 2700  
membranes NBR (water)  
pressure max 16bar  
pressure min 0,3bar

fig.	Part No.	supply	connection	L (mm)	DN (mm)
1	370075	230 VAC	1/2"	67	12
1	370076	230 VAC	3/4"	82	25

## D-249 series



1

**technical data:**  
temperature range -20° up to 130°C  
coil type 8700  
membranes FKM (water)  
pressure max 8bar  
pressure min 0bar

fig.	Part No.	supply	connection	L (mm)	DN (mm)
1	370098	230 VAC	1/4"	38	3

## D-287/288/289/290/292/293 series



1

**technical data:**  
temperature range -10 up to 130°C  
coil type 7700  
membranes FKM (water)  
pressure max 16bar  
pressure min 0bar

fig.	Part No.	supply	connection	L (mm)	DN (mm)
1	370044	230 VAC	3/4"	85	15

## 3-way

## B-397 series



1

**technical data:**  
temperature range -20° up to 130°C  
coil type 2700  
membranes FKM (water)  
pressure max 10bar  
pressure min 0bar

fig.	Part No.	supply	connection	L (mm)	DN (mm)
1	370214	230 VAC	1/8"	30	1.5

## spare parts and accessories

## solenoid coils



1

2

fig.	Part No.	volt. (V)	voltage	power (VA)	coil type
1	371023	24	AC	10	2200
1	371027	24	AC	18	7200/7201
1	371022	230	AC	10	2700
1	371026	230	AC	18	7700
2	371024	230	AC	12	8700

## MÜLLER

## 2-way



1

2

fig.	Part No.	supply	inlet	outlet	L (mm)	version
1	370069 <sup>1</sup>	230 VAC	1/8" IT	1/8" IT	30	water
2	370036	230 VAC	3/4" ET	1/2" IT	57	water

<sup>1</sup>with adjusting screw

## ODE

## 2-way



1

**technical data:**  
supply 230 VAC  
temperature range -10 up to +90°C

fig.	Part No.	connection	L (mm)	DN (mm)
1	370653	1/2"	66	13





solenoid valves steam (water)

212A series



**technical data:**  
length 46mm  
temperature range °C  
pressure max 5bar  
pressure min bar

fig.	Part No.	supply	connection	DN (mm)	coil type	membranes
1	370719	230 VAC	female faston 6.3mm	4.5	BDA	

21A series



**technical data:**  
length 40mm  
temperature range -10 up to 140°C  
membranes FKM (water/steam)

fig.	Part No.	supply	connection	DN (mm)	coil type	p max (bar)
1	370208	230 VAC	1/8"	2.5	BDA	14
1	370145	230 VAC	1/4"	3	BDV	10

21J series



**technical data:**  
length 30mm  
temperature range -10 up to 140°C  
pressure max 18bar

fig.	Part No.	supply	connection	DN (mm)	membranes
1	370232	230 VAC	1/8"	2.3	FKM

31A series



**technical data:**  
length 40mm  
temperature range -10 up to 140°C  
membranes FKM (water/steam)  
pressure max 10bar  
pressure min bar

fig.	Part No.	supply	connection	DN (mm)	coil type
1	370616	230 VAC	1/4"	2	BDA

31A1 series



**technical data:**  
temperature range -10 up to 140°C  
flange size 32x32mm

fig.	Part No.	supply	DN (mm)	coil type	membranes	p max (bar)
1	370583	24 VAC	1.5	BDA	ruby	15
1	370125	24VDC	2.5	BDA	FKM (water/steam)	6
1	370203	230 VAC	2.5	BDV	FKM (water/steam)	6

5005A series



**technical data:**  
membranes FKM (water/steam)  
pressure max 15bar

fig.	Part No.	supply	DN (mm)	temp. (°C)	coil type
1	370541	230VAC	1.5	-10 up to 140	BDA

spare parts and accessories

gaskets



**technical data:**  
length 40mm  
temperature range -10 up to 140°C  
membranes FKM (water/steam)

fig.	Part No.	ø (mm)	application
1	371196	12	for valve body

solenoid coils



fig.	Part No.	volt. (V)	voltage	power (VA)	seat ø (mm)
1	371152	24	DC	8	12
1	371150	230	AC	8	13.5
1	371191	230	AC	10	10

valve inserts



fig.	Part No.	L (mm)	ø (mm)	gasket	fig.	Part No.	L (mm)	ø (mm)	gasket
1	371195	24	9	Viton	2	371193	30	12	Viton

valve bodies



fig.	Part No.	description	ø (mm)
1	371194	solenoid valve body ø 10mm	10
2	371192	solenoid valve body ø 13mm	13



## PARKER

2-way

## 7121 series



1 2

**technical data:**  
pressure max 15bar

fig.	Part No.	supply	connection	DN (mm)	coil type
1	370584	230 VAC	1/8"	1.5	BDA
2	370767	220-240VAC	1/8"	1.5	483510S6 XS03XS6 F

## N74.BV series



1

**technical data:**  
temperature range -10 up to 140°C  
pressure max 15bar

fig.	Part No.	supply	connection	DN (mm)	coil type	membranes
1	374061	230VAC	1/8"	2	WB4.5	FKM (water/steam)

## VE-123 series



1

**technical data:**  
temperature range -10 up to 140°C  
membranes Viton  
pressure max 5bar

fig.	Part No.	supply	connection	L (mm)	DN (mm)	coil type
1	370727	230 VAC	1/2"	72	13	ZB09

## VE-125 series



1

**technical data:**  
slide-on receptacle DIN  
temperature range -20° up to 130°C  
membranes FKM (water)  
pressure max 10bar

fig.	Part No.	supply	connection	DN (mm)	coil type
1	370202	230 VAC	-	2.5	ZB09

## VE-131 series



1

**technical data:**  
slide-on receptacle  
temperature range °C  
membranes  
pressure max bar

fig.	Part No.	supply	connection	DN (mm)	coil type
1	370549	230 VAC	-	-	KT09

## VE-140 series



1 2

**technical data:**  
slide-on receptacle DIN  
temperature range -10 up to 140°C  
coil type ZB09  
membranes ruby

fig.	Part No.	supply	connection	DN (mm)	p max (bar)
1	370140	230 VAC	1/8"	2.5	
2	370220	230 VAC	1/8"	2.5	30



3

**technical data:**  
slide-on receptacle DIN  
temperature range -10 up to 140°C  
coil type ZB09  
membranes ruby

fig.	Part No.	supply	connection	DN (mm)	p max (bar)
3	370141 <sup>1</sup>	230 VAC	1/4"	3	8

<sup>1</sup>SS housing

## E-146 series



1

**technical data:**  
slide-on receptacle DIN  
temperature range -20° up to 130°C  
membranes FKM (water)

fig.	Part No.	supply	connection	DN (mm)	coil type	p max (bar)
1	370066	24 VAC	1/8"	2.5	ZB09	15
1	370034	24 VAC	1/4"	3	ZB09	10
1	370221	24VDC	1/4"	3	ZB12	8
1	370206	230 VAC	1/8"	2.5	ZB09	15
1	370303	230 VAC	1/8"	3	ZB09	10
1	370067	230 VAC	1/4"	3	ZB09	7

## VE-161 series



1

**technical data:**  
slide-on receptacle  
temperature range -10 up to 140°C  
membranes FKM  
pressure max 10bar

fig.	Part No.	supply	connection	DN (mm)	coil type
1	370566	230 VAC	1/4"	2.20	KT09



**VE-175BV series**



**technical data:**  
 temperature range -10 up to 140°C  
 membranes FKM (water/steam)  
 pressure max 15bar  
 pressure min 0bar

fig.	Part No.	supply	connection	DN (mm)	coil type
1	370576	230 VAC	-	2	WB4.5



**technical data:**  
 slide-on receptacle DIN  
 temperature range -20° up to 140°C  
 pressure max 10bar

fig.	Part No.	supply	DN (mm)	coil type	membranes
3	370060	230 VAC	1.2	YB09 with cable	Viton
4	370759	230 VAC	1.2	ZB09	ruby

**3-way**

**121 KS8358 series**



**technical data:**  
 temperature range -10 up to 140°C  
 membranes FKM (water/steam)  
 pressure max 15bar  
 pressure min 0bar

fig.	Part No.	description
1	370709	solenoid valve brass 3-ways 230V AC

**VE-141 series**



**technical data:**  
 slide-on receptacle DIN  
 temperature range -20° up to 130°C  
 membranes FKM (water)

fig.	Part No.	supply	connection	DN (mm)	coil type	p max (bar)
1	370212	230 VAC	1/8"	2	ZB09	10
1	370059	230 VAC	1/4"	2	ZB09	10
1	370550	230 VAC	1/4"	3	ZB09	3
1	374076	230VAC	1/4"	2.5	ZB09	0

**301X series**





fig.	Part No.	supply	connection	DN (mm)	temp. (°C)
1	370785	24 VAC	-	-	-10° up to +140

**VE-148 series**



**technical data:**  
 temperature range -10° up to +140°C

fig.	Part No.	supply	connection	L (mm)	DN (mm)
1	370718	230 VAC	1/8"	30	-

**N79.6QV series**



**technical data:**  
 slide-on receptacle  
 temperature range -10 up to 140°C  
 membranes FKM (water/steam)  
 pressure max 15bar

fig.	Part No.	supply	DN (mm)	coil type
1	374062	230VAC	1	WB4.5

**solenoid valves (various)**



fig.	Part No.	description
1	370497	solenoid valve 2-ways 230 VAC connection 1/8"
1	370749	solenoid valve 2-ways 230 VAC inlet 1/8"
2	526331	solenoid valve 2-ways 230 VAC connection 1/8"
3	370525	solenoid valve brass 3-ways 110V AC

**VE-128 series**



**technical data:**  
 slide-on receptacle DIN  
 temperature range -20° up to 140°C  
 pressure max 10bar

fig.	Part No.	supply	DN (mm)	coil type	membranes
1	370050	24 VAC	1.2	ZB09	ruby
1	370058	24VDC	1.2	ZB12	ruby
1	370057	230 VAC	1.2	ZB09	ruby
2	370587	230 VAC	1.20	ZB09	ruby



## spare parts and accessories

## solenoid coils



fig.	Part No.	description
1	371082	solenoid coil 110V AC 9VA 60Hz coil type ZB09UL
2	371098	solenoid coil 230V 14W cable length 1000mm
3	371036	solenoid coil 24V AC 9VA coil type ZB09
3	371030	solenoid coil 24V DC 12VA coil type ZB12
4	371033	solenoid coil PARKER 230V 9VA



fig.	Part No.	description
5	371029	solenoid coil PARKER 230V 9VA coil type ZB09

## valve bodies



fig.	Part No.	description
1	370063	solenoid valve body PARKER 3-ways inner cone
2	370062	solenoid valve body PARKER 3-ways outer cone

## SIRAI

## 2-way

## L140-B series



**technical data:**  
 temperature range -10 up to +90°C  
 membranes NBR (water)  
 pressure max 12bar  
 pressure min 0,35bar

fig.	Part No.	supply	connection	L (mm)	DN (mm)	coil type
1	370320	24 VAC	1/2"	41	10	Z610A
1	370239	230 VAC	1/2"	41	10	Z610A

## L171-D series



**technical data:**  
 temperature range -10 up to 100°C  
 membranes EPDM (water)  
 pressure max 7bar  
 pressure min 0bar

fig.	Part No.	supply	connection	L (mm)	DN (mm)	coil type
1	370086	24 VAC	1/4"	43	3	Z610A
1	370083	230 VAC	1/4"	43	3	Z610A

## L177-B series



**technical data:**  
 temperature range -10 up to +90°C  
 membranes NBR (water)  
 pressure max 30bar  
 pressure min 0bar

fig.	Part No.	supply	connection	L (mm)	DN (mm)	coil type
1	370082	230 VAC	1/8"	26.5	2.3	Z610A

## L180-B series



**technical data:**  
 temperature range -10 up to +90°C  
 membranes NBR (water)  
 pressure max 12bar  
 pressure min 0,35bar

fig.	Part No.	supply	connection	L (mm)	DN (mm)	coil type
1	370328	24 VAC	3/8"	60	11.5	Z610A
1	370329	24 VAC	1/2"	66	13.5	Z610A
1	370391	24 VAC	3/4"	79	18	Z610A
1	370305	24VDC	1/2"	66	13.5	Z610A
1	370046	230 VAC	3/8"	60	11.5	Z610A
1	370047	230 VAC	1/2"	66	13.5	Z610A
1	370048	230 VAC	3/4"	79	18	Z610A

## L182\_B series



**technical data:**  
 temperature range -10 up to +90°C  
 membranes NBR (water)  
 pressure max 12bar  
 pressure min 0,35bar

fig.	Part No.	supply	connection	L (mm)	DN (mm)	coil type
1	370480	230 VAC	1"	105		ZB10A



3-way

L334-V series



1

**technical data:**  
 temperature range 0 up to +130°C  
 membranes FPM  
 pressure max 10bar  
 pressure min 0bar

fig.	Part No.	supply	DN (mm)	coil type
1	370080	230 VAC	2.3	ZA30A

L377-B series



1

**technical data:**  
 temperature range -10 up to +90°C  
 membranes NBR (water)  
 pressure max bar  
 pressure min bar

fig.	Part No.	supply	connection	L (mm)	DN (mm)	coil type
1	370210	230 VAC	1/8	26.5	1.6	Z610A

solenoid valves steam (water)

2-way

L120-Vo2 series



1

**technical data:**  
 temperature range -10 up to 155°C  
 coil type Z110A  
 membranes FPM  
 pressure max 20bar  
 pressure min bar

fig.	Part No.	supply	connection	L (mm)	DN (mm)
1	370064	24 VAC	1/8"	32	2.3

L121 series



1

**technical data:**  
 temperature range -10 up to 140°C  
 pressure max 8bar  
 pressure min 0,1bar

fig.	Part No.	supply	connection	L (mm)	DN (mm)	coil type	membranes
1	370228	230 VAC	1/4"	42	2.3	ZA30A	Viton
1	370084	230 VAC	1/4"	42	3.2	ZA34A	EPDM

L140-D series



1

**technical data:**  
 temperature range -10 up to 100°C  
 coil type Z610A  
 membranes EPDM

fig.	Part No.	supply	connection	L (mm)	DN (mm)	p max (bar)	p min (bar)
1	370705	24 VAC	3/4"	61	10	10	0.35
1	370729	24 VAC	3/4"	61	10	10	0.35
1	370731	24 VAC	3/4"	61	10	10	0.35
1	370730	230 VAC	3/4"	61	10	10	0.35

L145-R series



1 2

**technical data:**  
 temperature range -60 up to +170°C  
 membranes PTFE (steam)  
 pressure min 0,4bar

fig.	Part No.	supply	connection	L (mm)	DN (mm)	coil type	p max (bar)
1	370324	24 VAC	3/4"	79	16	Z534A	6
1	370077	230 VAC	3/8"	60	10	Z614A	8
1	370322	230 VAC	1/2"	66	10	Z614A	8
1	370323	230 VAC	3/4"	79	16	Z534A	6
2	370085	230 VAC	1"	105	18.5	Z534A	8

L153-D series



1

**technical data:**  
 temperature range -10 up to 140°C  
 coil type Z134A  
 membranes EPDM (steam/water)  
 pressure max 8bar  
 pressure min 0,1bar

fig.	Part No.	supply	connection	L (mm)	DN (mm)
1	370314	24 VAC	1/2"	66	11.5
1	370325	24 VAC	3/4"	79	17
1	370264	230 VAC	1/2"	66	11.5
1	370079	230 VAC	3/4"	79	17

spare parts and accessories

solenoid coils



1

fig.	Part No.	supply	power (VA)	coil type	seat ø (mm)
1	371086	24 VAC	4	ZB10A	10
1	371070	24 VAC	10	Z610A	10
1	371158	24 VAC	10	Z614A	10
1	371075	24 VAC	14	Z530A	12
1	371068	24 VAC	14	Z534A	12

Table continues overleaf





1 

fig.	Part No.	supply	power (VA)	coil type	seat ø (mm)
1	371178	24 VAC	24	Z110A/Z114A/Z134A	14
1	371099	24VDC	5.5	ZB10A	10
1	371069	24VDC	6	Z610A	10
1	371049	24VDC	12	ZA30E	14
1	371078	24VDC	13	Z110A/Z114A/Z134A	14
1	371076	24VDC	14	Z530A	12
1	371085	230 VAC	4	ZB10A	10
1	371071	230 VAC	10	Z610A	10
1	371159	230 VAC	10	Z614A	10
1	371074	230 VAC	14	Z530A	12
1	371067	230 VAC	14	Z534A	12
1	371047	230 VAC	14	ZA30A	14
1	371176	230 VAC	14	ZA34A	14
1	371077	230 VAC	24	Z110A/Z114A/Z134A	14

membranes



1  2 

fig.	Part No.	connection	series	membrane type
1	371171	1/2	L180-B	NBR (water)
1	371172	3/4"	L180-B	NBR (water)
2	371163	1/2"	L140-B	NBR (water)

solenoid valves (various)



1  2  3 

fig.	Part No.	supply	inlet	suitable for	Ref. No.
1	370665	24 VAC	1/8"	Bonnet Roller Grill	1049474 SB10018
2	370523	230 VAC		Cookmax Melitta	11753 11753
3	370748	230 VAC	1/8"	MKN	201141

4  5  6 

fig.	Part No.	supply	inlet	suitable for	Ref. No.
4	370236	230 VAC	1/4"	NuovaSimonelli	04100024
5	370634	230 VAC	1/4"	NuovaSimonelli	04100005
6	370713	230 VAC	3/8"	MIWE	505212.45



7  8 

fig.	Part No.	supply	inlet	suitable for	Ref. No.
7	370378	230 VAC	1/2"	Electrolux Sirai Zanussi	0C2390 L621B03 1L ZA34A 0C2390
8	370738	230 VAC	3/4" ET	Elframo	00065310

drain valves



1  2  3 

fig.	Part No.	volt. (V)	inlet (mm)	outlet (mm)	suitable for
1	401889	12	40	40	Fagor FIBER Rational
2	370790 <sup>1</sup>	24	12.5	15.5	Icematic
3	371107	24	50	50	ATA Bonnet

<sup>1</sup>with accessories





4  5  6  7 

fig.	Part No.	volt. (V)	inlet (mm)	outlet (mm)	suitable for
4	370621	230	17	17	Hobart
5	370720	230	17	19	Hobart
6	370642	230	40	40	Hobart
7	370629	230	46	1 1/2" ET	Winterhalter

8  9  10 

fig.	Part No.	volt. (V)	inlet (mm)	outlet (mm)	suitable for
8	371109	230	50	50	Lamber
9	371146	230	77	80	Grandimpianti
10	370721	240	17	19	Hobart



fig.	Part No.	volt. (V)	inlet (mm)	outlet (mm)	suitable for
11	370789	220-240			Fagor
12	371106	208/230	17.5	16	Icematic Scotsman

**solenoid valves (gas)**

**ASCO**

**technical data:**  
pressure max 15bar  
membranes FPM

fig.	Part No.	connection	L (mm)	coil type
1	370710	1/8"	33	400127-197

**BRAHMA**

**solenoid valves**

**technical data:**  
CE Reg.no. 63AQ0626

fig.	Part No.	DN (mm)	connection	L (mm)	coil type	p max (bar)
1	101486	10	3/8"	56	13747002	0.5
1	101487	10	1/2"	56	13747002	0.5
2	101488 <sup>1</sup>	15	1/2"	72	13922051	0.25
2	101490 <sup>1</sup>	25	3/4"	96	13932000	0.3
2	101493 <sup>1</sup>	40	1 1/2"	138	13950200	0.2

<sup>1</sup>aluminium housing

**technical data:**  
CE Reg.no. 63AQ0626

fig.	Part No.	DN (mm)	connection	L (mm)	coil type	p max (bar)
3	101948 <sup>1</sup>	15	1/2"	72	18811003	0.5
3	106069 <sup>1</sup>	25	3/4"	96	18813004	0.5
3	106071 <sup>1</sup>	30	1"	111	18813014	0.5

<sup>1</sup>aluminium housing

**spare parts and accessories**

**solenoid coils**

fig.	Part No.	supply	power (VA)	seat ø (mm)	coil type
1	101521	230 VAC	20	17	13742002
1	101968	230 VAC	20	17	13902001
1	101522	230 VAC	20	17	13922051
2	101524	230 VAC	35	30	13942000
2	106070	230 VAC	37	30	18813004
2	106072	230 VAC	37	30	18813014

**BÜRKERT**

**technical data:**  
pressure max 0,5bar  
CE Reg.no. CE-0085AS0391  
membranes NBR

fig.	Part No.	DN (mm)	connection	L (mm)
1	370281	12	1/2"	74.5
2	370282	20	3/4"	100

**DUNGS**

**technical data:**  
CE Reg.no. 63AQ0626

fig.	Part No.	volt. (V)	connection	L (mm)	p max (bar)
1	107534	230	1/2"	65	0.36
1	107535	230	1"	75	0.36

**TECNOCONTROL**

**solenoid valves**

**technical data:**  
pressure max 0,55bar  
membranes NBR

fig.	Part No.	type	volt. (V)	connection	reg. no.
1	104648	NC	230	3/4"	0068
1	104539	NC	230	1"	0068

**2**

**technical data:**  
pressure max 0,55bar  
membranes NBR

fig.	Part No.	type	volt. (V)	connection	reg. no.
2	102941	NO	230	1/2"	-
2	102942	NO	230	3/4"	-
2	102943	NO	230	1"	0497



**technical data:**  
type NC  
pressure max 45bar  
temperature range -35 up to 105°C

pos.	Part No.	DN (mm)	connection	pos.	Part No.	DN (mm)	connection
1	370150	2.5	1/4" SAE	4	370153	12.5	1/2" SAE
2	370788	2.5	3/8" SAE	5	370381	16.5	5/8" SAE
3	370152	7	3/8" SAE	6	370154	16.5	3/4" SAE

## accessories



**1**

fig.	Part No.	description
1	107348	solenoid coil TECNOCONTROL 230V AC 9VA
1	107349	solenoid coil TECNOCONTROL 24V AC 17VA



**1**      **2**

fig.	Part No.	supply	power (VA)	freq. (Hz)	connection
1	371042	24VAC	8	50/60	DIN plug big
1	371301	110VAC	8	50/60	DIN plug big
1	371041	230VAC	8	50/60	DIN plug big
2	371084	230VAC	8	50/60	cable 1000mm

## solenoid valves (refrigeration)

### CASTEL

#### valves



**technical data:**  
voltage 230V  
temperature range -35 up to 110°C

pos.	Part No.	type	p max (bar)	connection
1	370765	NC	45	3/8"

#### valve bodies



**technical data:**  
type NC  
pressure max 45bar  
temperature range -35 up to 105°C

pos.	Part No.	DN (mm)	connection
1	370151	2.2	1/4" soldering connection
2	370382	3	10mm soldering connection
3	370383	7	10mm soldering connection
4	370384	7	12mm soldering connection
5	370386	12.5	16mm soldering connection
6	370385	12.5	12mm soldering connection
7	370387	12.5	22mm soldering connection

### DANFOSS

#### valve bodies



**technical data:**  
temperature range -40° up to 105°C

pos.	Part No.	type	p max (bar)	DN (mm)	connection
1	370159	EVR 3	45.2	3.2	7/16" UNF (1/4" SAE)

#### spare parts and accessories



**1**      **2**

fig.	Part No.	description
1	371004	solenoid coil DANFOSS 220/230V AC 10VA 50/60Hz
2	371040	solenoid coil DANFOSS type EVR 230V



**PARKER**

valves

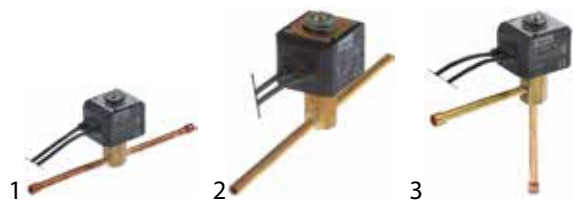

fig.	Part No.	volt. (V)	connection
1	370782	230	16mm soldering connection
2	370415	230	4mm soldering connection
3	370783	230	6mm soldering connection





fig.	Part No.	volt. (V)	connection
4	370784	230	6mm soldering connection

various valves



**technical data:**  
supply 230 VAC

fig.	Part No.	type	p max (bar)	connection
1	370757	MDF-A03-6H001	4.5	solder connection 10mm
2	370666	NEV-202DXF 2251 J		6mm soldering connection

valve bodies



fig.	Part No.	type	connection
1	370478		6mm soldering connection
2	370191	CLS 2.5	6mm soldering connection
2	370190	ILS 1.5	6mm soldering connection
2	370192	RLS 1.9	6mm soldering connection

spare parts and accessories

solenoid coils



fig.	Part No.	volt. (V)	freq. (Hz)
1	371045	230	50/60

accessories

union nuts



fig.	Part No.	type	size	pipe ø	Int. Code
1	750050	7010/22	1/4" SAE	1/4" - 6mm	NS4-4
1	750460	7010/33	3/8" SAE	3/8"	NS4-6
1	750463	7010/44	1/2" SAE	1/2"	NS4-8
1	750065	7010/55	5/8" SAE	5/8" - 16mm	NS4-10
2	750057	7020/32	3/8" SAE	1/4" - 6mm	NRS4-64
2	750462	7020/43	1/2" SAE	3/8"	NRS4-86
2	750461	7020/54	5/8" SAE	1/2"	NRS4-108
3	750051	7030/3M8	3/8" SAE	8mm	-
3	750052	7030/3M10	3/8" SAE	10mm	-
3	750053	7030/4M10	1/2" SAE	10mm	-
3	750054	7030/4M12	1/4" SAE	12mm	-
3	750063	7030/5M12	5/8" SAE	12mm	-
3	750064	7030/5M14	5/8" SAE	14mm	-
3	750055	7030/6M14	3/4" SAE	14mm	-
3	750056	7030/6M18	3/4" SAE	18mm	-

solenoid valves for vacuum machines



fig.	Part No.	description
1	370520	solenoid valve 2-way 24 VACV inlet 1/4"mm outlet ø4
2	370507	solenoid valve 2-ways 24 VAC L 31mm DN 3,3mm 1/8" brass
3	370501	solenoid valve assembly 1/2" hose connector ø 10mm 24V coil type VA12 JP
3	370500	solenoid valve assembly 1/2" hose connector ø 7,5mm 24V coil type VA12 MJ



fig.	Part No.	description
4	370512	solenoid valve assembly 1/2" hose connector ø 21mm 24V coil type VA12 2 coils J35/J42/B35
5	370514	solenoid valve assembly 1/2" hose connector ø 21mm 24V coil type VA12 3 coils H200+SA
6	370504	solenoid valve assembly 1/2" hose connector ø 21mm 24V coil type VA12 B35+SA 3 coils





fig.	Part No.	description
7	370505	solenoid valve assembly 1/2" hose connector ø 21mm 24V coil type VA12 B42(XL)+SA 3 coils
8	370502	solenoid valve assembly 1/2" hose connector ø 21mm 24V coil type VA12 J35
8	370503	solenoid valve assembly 1/2" hose connector ø 21mm 24V coil type VA12 J42
9	692064	solenoid valve assembly 1/2" hose connector ø 6mm 24V H200



fig.	Part No.	description
10	370513	solenoid valve assembly 24 VAC inlet 1/2" outlet 10,5mm 2 coils coil type VA12 1/2" JP
11	370511	solenoid valve assembly 24 VAC inlet 1/2" outlet 7,5mm 2 coils coil type VA12 1/2" MJ
12	370787	solenoid valve assembly 24 VAC inlet 1/2" outlet 7,5mm 2 coils coil type VA12 1/2" MJ

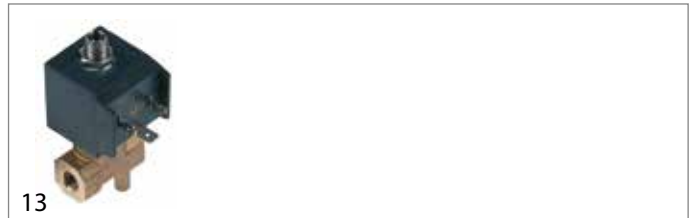
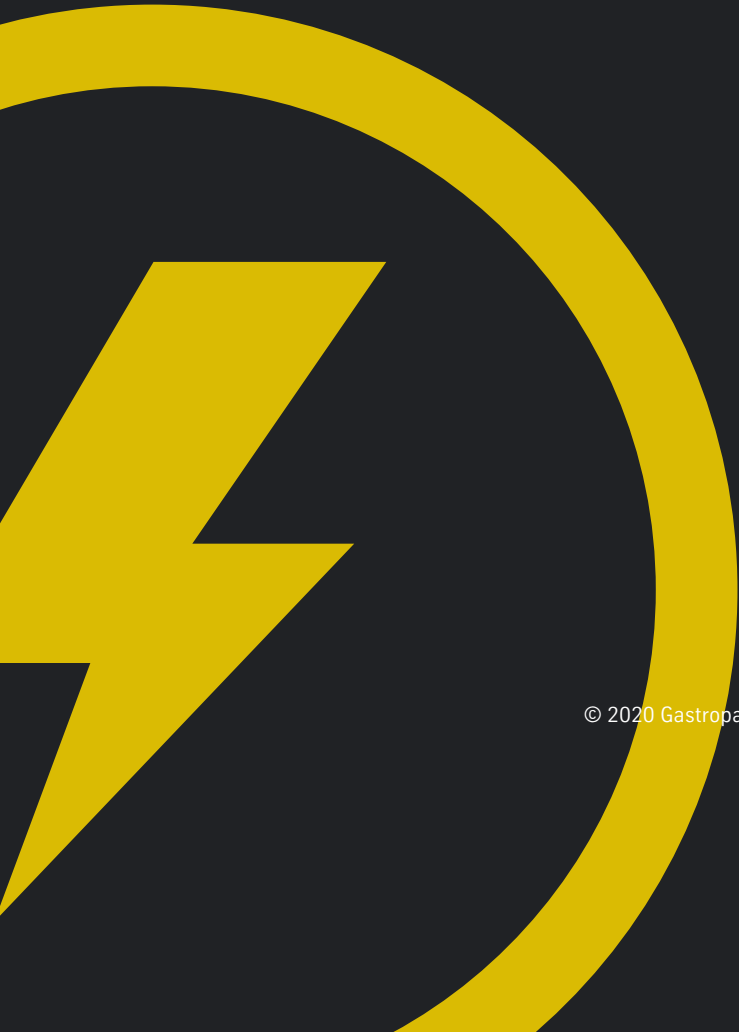

fig.	Part No.	description
13	370506	solenoid valve brass 3-ways 24V L 35mm 1/8" body inner cone DN 2,8mm



**GASTROPARTS.COM**



© 2020 Gastroparts Sp. J. All rights reserved.