



GASTROPARTS

Zanussi

[EN] Cooking

[DE] Kochtechnik

[ES] Cocción

[FR] Cuisson

[IT] Cottura

[PL] Obróbka termiczna

[RU] Термическая обработка

✉ gastroparts@gastroparts.com

☎ tel. +48 56 657 00 66

📘 fb.com/gastroparts.global

GASTROPARTS.COM



TABLE OF CONTENTS

Open tops (gas/electric)



page 4

Ovens (gas/electric)

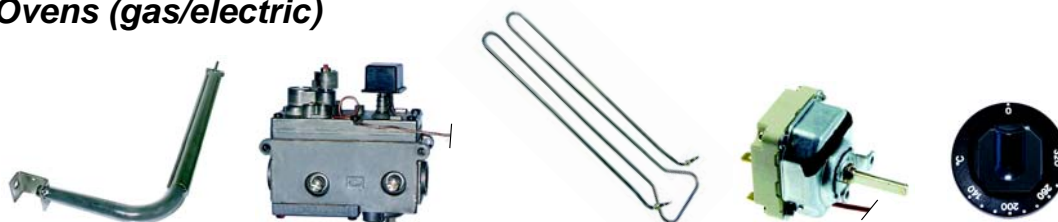

page 12

Hot cupboards (electric)



page 15

Fry tops (gas/electric)



page 15

Lava rock grills (gas), grills (electrical)

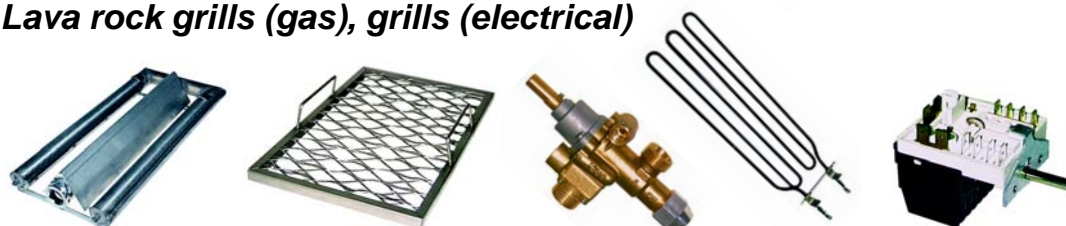

page 21

Multi bratt pans (gas)



page 24

TABLE OF CONTENTS

Pasta cookers (gas/electric)

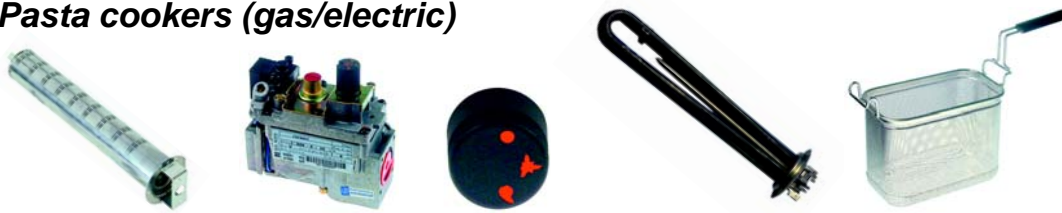

page 24

Ovens (gas/electric)

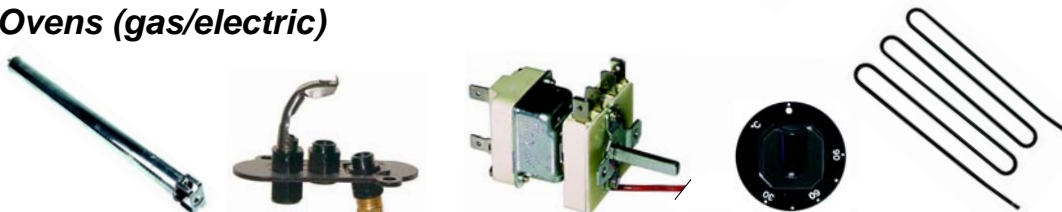

page 30

Chip scuttles (electric), fryers (gas/electric)



page 35

Tilting bratt pans (gas/electric)

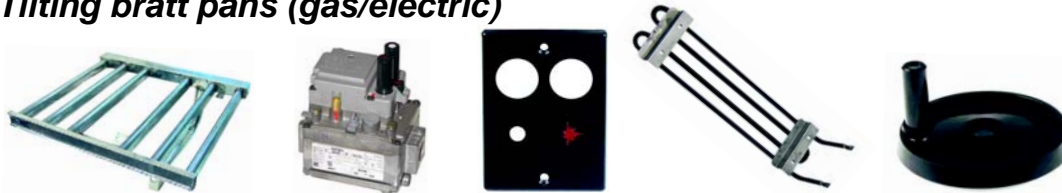

page 47

Boiling pans (gas/electric)



page 57

Hot-air ovens + combination steamers (gas/electric)

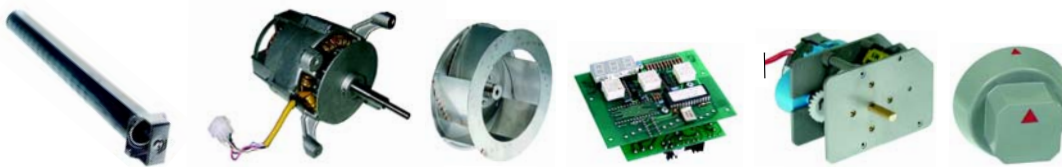

page 65

Small appliances and single devices (gas/electric)



page 87

Open tops (gas)



Item	Order	Description	Model	OEM
1	104286	burner cover, 90mm		04973
2	104285	burner ring, 90mm	SCG350/700 SCG1050	04972
3	104288	burner cover, 120mm	SCGFE700/1050	04975
4	104287	burner ring, 120mm	SCGFE1051	04974
5	104289	burner base		04977

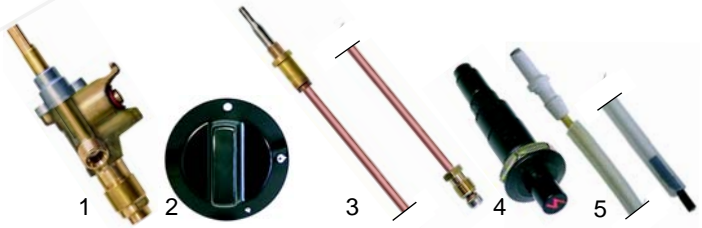

Item	Order	Description	Model	OEM
1	101396	gas tap		04956
2	110710	knob	SCG350/700 SCG1050	04957
3	102121	thermocouple	SCGFE700/1050	04955
4	100009	piezoelectric igniter	SCGFE1051	04944
5	100738	electrode		04970



Item	Order	Description	Model	OEM
1	210155	top grate	SCG__	04976
2	210050	reducing star	SCGFE__	



Item	Order	Description	Model	OEM
1	105232	burner cover 70mm	RC/G__, RCF/G RCF/GE, RCV/G__	02442, 54097 55563, 58559
2	105008	burner ring	RTF/G__, MC/G__, MCF/G__, MCF/GE,	54095, 56747
3	105231	burner base	MTF/G__, PCG__,	54091, 54164
4	105270	gasket	PCFG__, PCFGE__,	54093
5	105056	aeration sleeve	PTFG__	53448

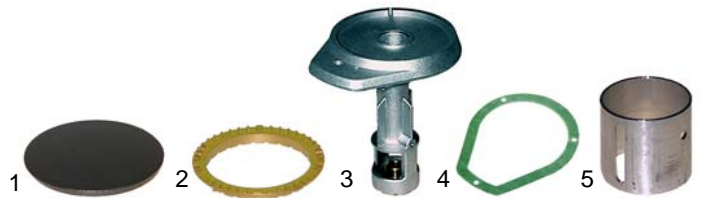

Item	Order	Description	Model	OEM
1	105012	burner cover 100mm	RC/G__, RCF/G RCF/GE, RCV/G__	02443, 54098 55562, 58560
2	105011	burner ring	RTF/G__, MC/G__, MCF/G__, MCF/GE,	54096, 56748
3	105233	burner support	MTF/G__, PCG__,	54092, 54165
4	105271	gasket	PCFG__, PCFGE__, PTFG__	54094
5	105056	aeration sleeve		53448

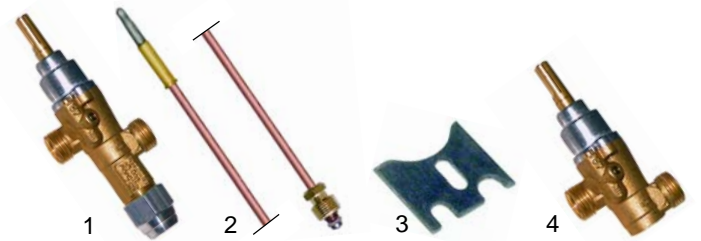

Item	Order	Description	Model	OEM
1	101094	gas tap		54109, 54628 54629
2	102204	thermocouple, 600mm	device with safety pilot	54102, 54103
2	102205	thermocouple, 750mm		54104, 58332
3	101947	holder	device safety pilot	58331
4	101398	gas tap		54166, 54873 54874



Item	Order	Description	Model	OEM
1	550677	gasket	RC/G__, RCF/G, RCF/GE, RCV/G, RTF/G	54108
2	111595	knob		54105
3	110289	knob	MC/G__, MCF/G, MCF/GE, MTF/G, MCV/G	58534
4	111596	knob	PCG__, PCFG__, PCFGE, PTFG	04329

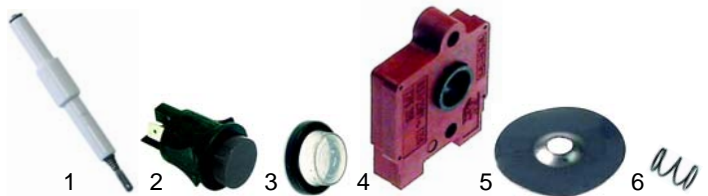

Item	Order	Description	Model	OEM
1	100717	electrode		54099
2	345038	ignition switches	universal	53978
3	345039	protecting cover		55979
4	301207	switch		04241
5	301208	disc	PCG__, PCFG__, PCFGE__, PTFG__	04242
6	301209	spring		04243



Item	Order	Description	Model	OEM
1	101002	ignition unit 2 outputs	03376 04240, 51884 universal A2073, 53647	
2	101003	ignition unit 4 outputs	54134, A2097 03214	
3	101004	ignition unit 6 outputs	03552, 58826	



Item	Order	Description	Model	OEM	
1	105006	burner cover 122	HCS/G_	52121, 58187	
2	105005	Venturi	HCF/G_	HCF/GE_	52118, 58184
3	105055	aeration sleeve	HTF/G_	52116	



Item	Order	Description	Model	OEM
1	210148	top grate		02446, 58575
2	210138	top grate		02436, 55064 55564, 58558



Item	Order	Description	Model	OEM
1	101087	gas tap with safety pilot	HCS/G_	53202, 53203
			HCF/G_	52146, 53192
			HCF/GE_	53196, 53199
			HTF/G_	53449
2	101690	gas tap without safety pilot		52145
3	110045	knob		52138



Item	Order	Description	Model	OEM	
1	105002	burner cover	HCS/G_	521122, 58185	
2	105001	Venturi	HCF/G_	HCF/GE_	52119, 58182
3	105055	aeration sleeve	HTF/G_	52116	



Item	Order	Description	Model	OEM		
1	102008	thermocouple		52163		
2	102067	nut M8x1		55033		
3	100048	pilot burner FG	HCS/G_	HCF/G_	HCF/GE_	52144
3	100113	pilot burner EG	HTF/G_	56751		
4	101342	cover		56580		



Item	Order	Description	Model	OEM	
1	105004	burner cover 102	HCS/G_	52123, 58186	
2	105003	Venturi	HCF/G_	HCF/GE_	52120, 58183
3	105055	aeration sleeve	HTF/G_	52116	

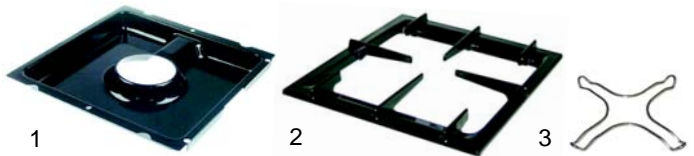

Item	Order	Description	Model	OEM	
1	210205	collecting tray 83		52102, 52111, 55748	
1	210206	collecting tray 102		52103, 52112, 55749	
1	210207	collecting tray 122	HCS/G_	HCF/G_	52104, 52113, 55750
2	210139	top grate	HCF/GE_	58179, 56654, 53552	
3	210001	reducing star CNS	HTF/G_	25056	
3	210050	reducing star iron VC			



Item	Order	Description	Model	OEM
1	105236	burner cover 83	HC/G_ HCF/G_ HCF/GE_ HTF/G_	59241, 59203
2	105235	burner base		59201, 02461
3	105237	Venturi		59199, 02458
4	105055	aeration sleeve		52116



Item	Order	Description	Model	OEM
1	105239	burner cover 102	HC/G_ HCF/G_ HCF/GE_ HTF/G_	59242, 59204
2	105238	burner base		59202, 02462
3	105240	Venturi		59200, 02459
4	105055	aeration sleeve		52116



Item	Order	Description	Model	OEM
1	105242	burner cover 122		59253, 59213
2	105241	burner base	HC/G_ HCF/G_ HCF/GE_ HTF/G_	59212, 02463
3	105243	Venturi		59211, 02460
4	105055	aeration sleeve		52116
5	105244	spacer		02197



Item	Order	Description	Model	OEM
1	101095	gas tap		59460, 59355 59353, 59361 59367, 59369
2	110348	knob	HC/G_ HCF/G_ HCF/GE_ HTF/G_	59206
3	102205	thermocouple, 750mm		58332
4	100094	pilot burner		59214
5	100182	cover		03547



Item	Order	Description	Model	OEM
1	210146	top grate	HC/G_ HCF/G_ HCF/GE_ HTF/G_	59208, 59245 02437
2	210001	reducing star		25056



Item	Order	Description	Model	OEM
1	104554	burner cover, 6 kW		0C0129
2	104555	burner rosette	NCG_ NCFG_ NCFGE_ NTFG_	0C0127
3	104556	Venturi		0C0125
4	104557	burner holder		0C0124
5	532505	O-ring		0C0188



Item	Order	Description	Model	OEM
1	104558	burner cover, 10 kW		0C0128
2	104559	burner rosette	NCG_ NCFG_ NCFGE_ NTFG_	0C0126
3	104560	Venturi		0C0133
4	104557	burner holder		0C0124
5	532505	O-ring		0C0188

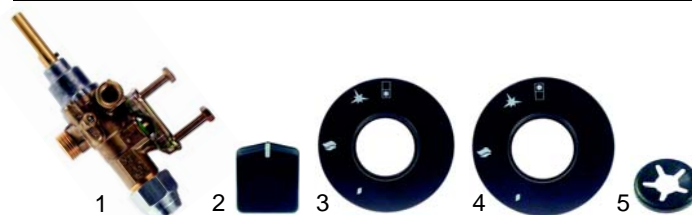

Item	Order	Description	Model	OEM
1	101897	gas tap		0C0205
2	111598	knob	NCG_ NCFG_ NCFGE_ NTFG_	0C0191
3	111632	panel/in the front		0C0192
4	111633	panel/at the back		0C0193
5	104563	fixing		69567

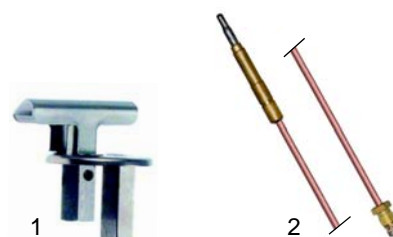

Item	Order	Description	Model	OEM
1	100879	pilot burner	NCG_ NCFG_ NCFGE_ NTFG_	0C0199
2	102035	thermocouple, 850mm		0C0202



Item	Order	Description	Model	OEM
1	210208	top grate	NCG_, NCFG_	0C0132
2	210209	top grate CNS	NCFGGE_, NTFG_	0C0130

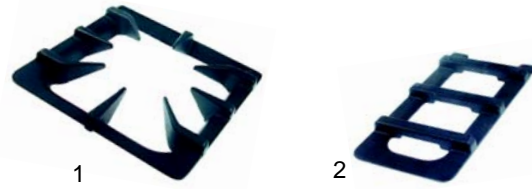

Item	Order	Description	Model	OEM
1	210210	top grate	CCAG_	0G2022
2	210211	centre grid	CCFG_	0G2033

Open tops (solid top)



Item	Order	Description	Model	OEM
1	103087	burner cover 90		0H6320
2	104028	burner lower part	CCAG_	0H6340
3	104043	Venturi	CCFG_	0H7155
4	103007	O-ring		



Item	Order	Description	Model	OEM
1	104564	burner cover	RTV/G	54193
2	104565	Venturi	RTF/G	54246
3	104566	cover	MTV/G (1st generation)	54536
4	105055	aeration sleeve	MT/G70_	52116



Item	Order	Description	Model	OEM
1	103088	burner cover 110		0H6321
2	104029	burner lower part	CCAG_	0H6341
3	104044	Venturi	CCFG_	0G1811
4	103007	O-ring		



Item	Order	Description	Model	OEM
1	104567	burner	MT/G35_	02528
2	104568	burner	MSV/G_, MSF/G_	04287
3	104569	aeration sleeve		02527

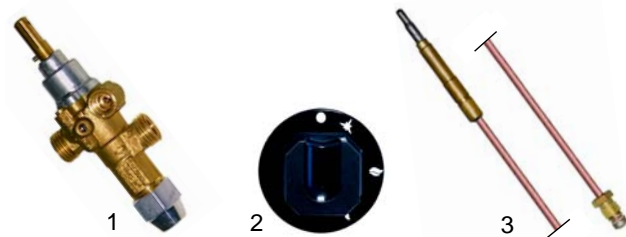

Item	Order	Description	Model	OEM
1	101095	gas tap		59460
2	110348	knob	CCAG_	59206
3	102038	thermocouple, 1500mm	CCFG_	0G2023



Item	Order	Description	Model	OEM
1	104570	burner cover		04280
2	104571	Venturi	MTV/G (2.Gen.)	04279
3	104566	cover	MTF/G (2.Gen.)	54536
4	105055	aeration sleeve	MSF/G3	52116

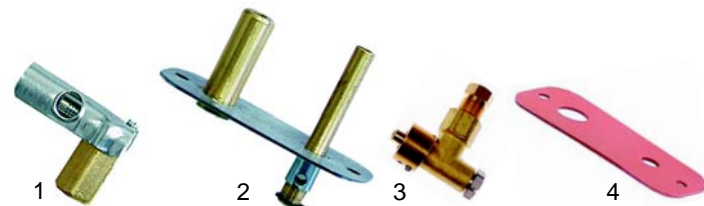

Item	Order	Description	Model	OEM
1	100853	pilot burner upper part		0H6342
2	100847	pilot burner centre part	CCAG_	0H6343
3	101598	pilot burner lower part	CCFG_	0G2024
4	100806	gasket		0H6645



Item	Order	Description	Model	OEM
1	105026	burner cover	HTS/G_	52377, 0G2241
2	105024	burner	HTF/G, HT/G CTAG_, CTFG_	52374, 0G2245
3	105025	cover	NTG_, NTGF_	52376, 0G2244
4	104572	holder		52500

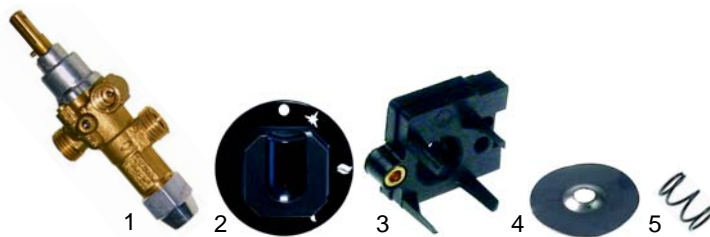

Item	Order	Description	Model	OEM
1	101095	gas tap PEL21		04282
2	110348	knob	MSV/G	59206
3	345777	switch	MSF/G	04288
4	301208	disc		04242
5	301209	spring		04243



Item	Order	Description	Model	OEM
1	101087	gas tap PEL22		52146
2	111599	knob	RTV/G_	52604
3	550677	gasket	RTF/G_	54108
4	100007	piezoelectric igniter		52539



Item	Order	Description	Model	OEM
1	101087	gas tap PEL22		56351 52146, 53662
2	110045	knob	HTS/G HTF/G (1st generation)	52138
3	100007	piezoelectric igniter		52539, 58225

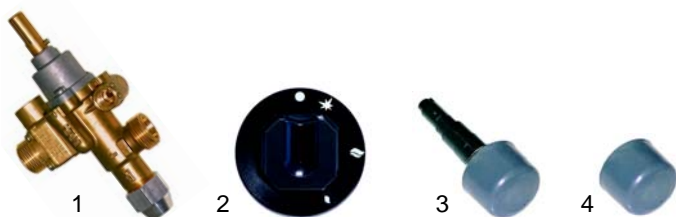

Item	Order	Description	Model	OEM
1	101087	gas tap PEL22		52146
2	110309	knob	MTF/G (1st generation)	58597
3	100012	piezoelectric igniter	MT/G	02605
4	101339	covering hood		02816



Item	Order	Description	Model	OEM
1	101087	gas tap PEL22		52146
2	110448	knob	MT/G HTF/G (2.Gen.)	59378
3	100012	piezoelectric igniter		02605
4	101339	covering hood		02816

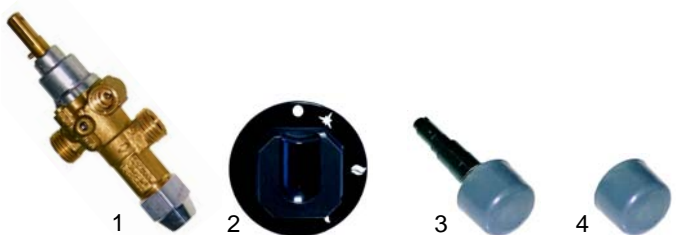

Item	Order	Description	Model	OEM
1	101095	gas tap PEL21		04282
2	110348	knob	MTFG/G MT/G (2.Gen.)	59206
3	100012	piezoelectric igniter		02605
4	101339	covering hood		02816

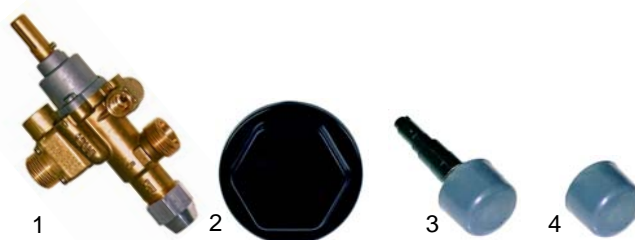

Item	Order	Description	Model	OEM
1	101087	gas tap, PEL22		0G2251, 0K1347
2	111600	knob	CTAG_	0G2258, 59538
3	100012	piezoelectric igniter	CTFG_	02605
4	101339	covering hood		02816

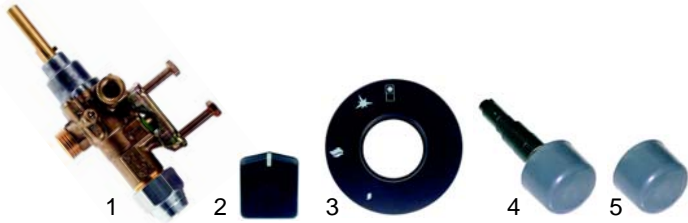

Item	Order	Description	Model	OEM
1	101897	gas tap		0C0205
2	111598	knob	NTG_	0C0191
3	111633	disc	NTGF_	0C0193
4	100012	piezoelectric igniter		02605
5	101339	covering hood		02816S



Item	Order	Description	Model	OEM
1	100050	pilot burner	MTV/G	59379
2	100701	electrode	MTF/G (2.Gen.)	59380
3	102038	thermocouple, 1500mm	MSV/G, MSF/G_	51119



Item	Order	Description	Model	OEM
1	100046	pilot burner		50813
2	100708	electrode	RTV/G	51977
3	102041	thermocouple, 600mm	RTF/G	57781



Item	Order	Description	Model	OEM
1	100106	pilot burner, 0,35		58329
1	100046	pilot burner, 0,20	HTS/G	50813
2	100708	electrode	HTF/G (1st generation)	51977
3	102044	thermocouple, 1200mm		20094



Item	Order	Description	Model	OEM
1	100106	pilot burner		58329
2	100706	electrode	MTF/G (1st generation)	56754
3	102045	thermocouple, 1500mm	MT/G70_	52814



Item	Order	Description	Model	OEM
1	100050	pilot burner		59379, 0G2266
2	100701	electrode	CTAG	59380, 0G2265
3	102044	thermocouple, 1200mm	CTFG_	20094, 0G2065



Item	Order	Description	Model	OEM
1	100050	pilot burner	MT/G3S_	59379
2	100701	electrode	HT/G	59380
3	102045	thermocouple, 1500mm	HTF/G (2.Gen.)	52814



Item	Order	Description	Model	OEM
1	100198	pilot burner		05503
2	100701	electrode	NTG_	59380
3	102035	thermocouple, 850mm	NTGF_	0C0202

Open tops (ceramic/gas)

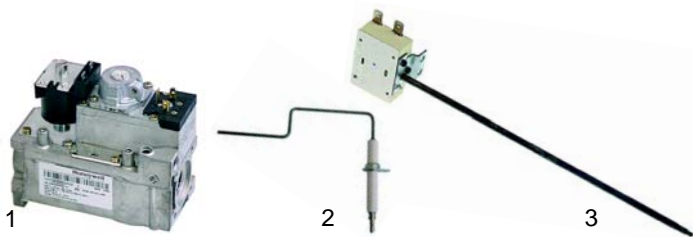

Item	Order	Description	Model	OEM
1	101164	gas regulator		03040
2	100739	electrode	HI/G400	03041
3	375561	thermostat	HI/G800	03047

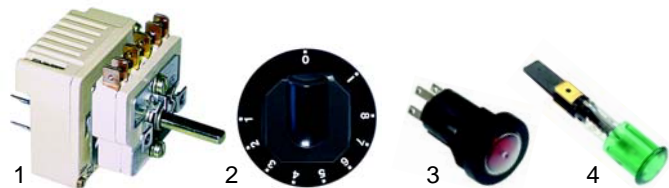

Item	Order	Description	Model	OEM
1	380004	energy regulator		59046
2	110429	knob	HI/G400	59554
3	346287	push button	HI/G800	02418
4	359364	signal lamp		58658

Open tops (electric)



Item	Order	Description	Model	OEM
1	490010	1500W/230V, 145mm	700-series (old)	58104
2	490014	1500W/230V, 180mm	universal	53607, 53406
2	490015	1500W/400V, 180mm	700-series	03930
2	490016	2000W/230V, 180mm	600-series	04914
3	490020	2600W/230V, 220mm	universal	53606, 53407
3	490021	2600W/400V, 220mm	700-series	03931

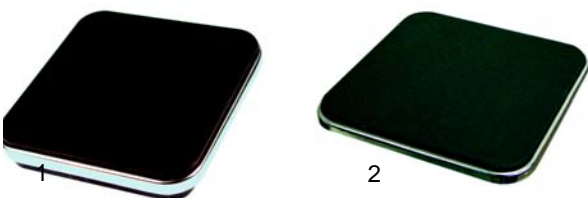

Item	Order	Description	Model	OEM
1	490066	2600W/230V (220x220)	MCV/E2Q MCF/E2Q	06220 0A2198, 0A2199
2	490056	3000W/230V (300x300)		52198, 52196
2	490057	3000W/400V (300x300)	universal	52197
2	490071	4000W/230V (300x300)	900-series	52199, 52201
2	490074	4000W/400V (300x300)		52200



Item	Order	Description	Model	OEM
1	300004	7-position switch		04915
2	110711	knob	SCE350 SCE700	04913
3	359132	signal element	SCFE700	04895
4	359123	insert lamp holder		04896



Item	Order	Description	Model	OEM
1	300004	7-position switch		53408
2	111601	knob	RCV/E 320 RCV/E 720	53403
3	359109	signal element	RCF/E 720	54150
4	359803	lens		54151

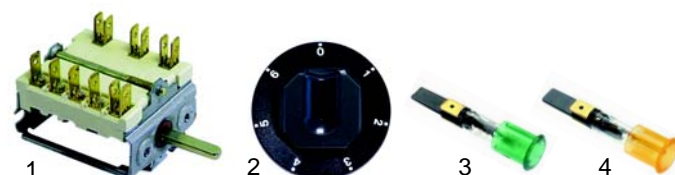

Item	Order	Description	Model	OEM
1	300004	7-position switch	MC/E350 MC/E700	53408 53547
2	110317	knob	MC/E1050	
3	359364	signal lamp/green	MCF/E700	05010, 58658
4	359365	signal lamp/yellow	MCF/E1050	05011, 58659



Item	Order	Description	Model	OEM
1	300177	7-position switch	MC/E1, MC/E2	59238
2	110428	knob	MCV/E2, MCV/E3	59230
3	359364	signal lamp/green	MCF/E2, MC/E2Q	05010
4	359365	signal lamp/yellow	MCF/E2Q	05011

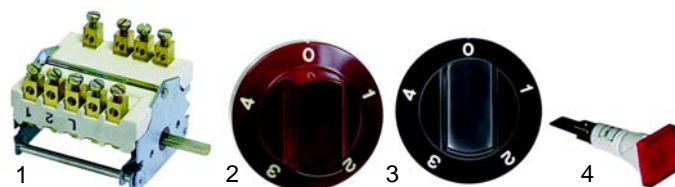

Item	Order	Description	Model	OEM
1	300075	5-position switch		25300
2	110398	knob/brown	HCS/E400	52184
3	110397	knob/black	HCS/E800	52183
4	359150	signal lamp	HCF/E800	53153

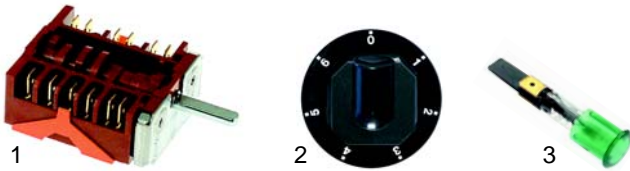

Item	Order	Description	Model	OEM
1	300177	7-position switch	HC/E400	59238
2	110428	knob	HC/E800	59230
3	359364	signal lamp	HCF/E800	58658, 05010

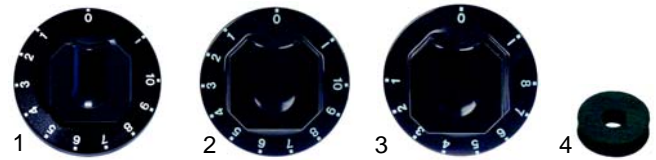

Item	Order	Description	Model	OEM
1	110307	knob	HI/E350, MI/E700, MIF700	59042
2	111603	knob	MI/E1, MIF/E2, MI/E2, MIV/E2	05009
3	111604	knob	HI/E400, HI/E800	59554
4	111607	gasket	universal	53816

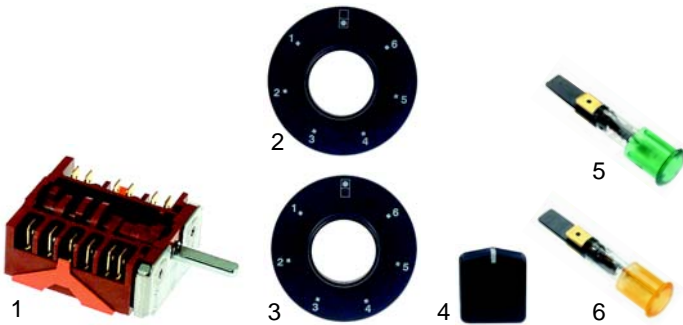

Item	Order	Description	Model	OEM
1	300177	7-position switch		59238
2	111605	panel/in the front	NCE400	0C0304
3	111606	panel/at the back	NCE800	0C0307
4	111602	knob	NCFE800	0C0257
5	359364	signal lamp/green		05010
6	359365	signal lamp/yellow		05011



Item	Order	Description	Model	OEM
1	111608	panel/in the front		0C0317
2	111609	panel/at the back	NIE400	0C0318
3	111602	knob	NIE800	0C0257
4	111607	gasket		53816

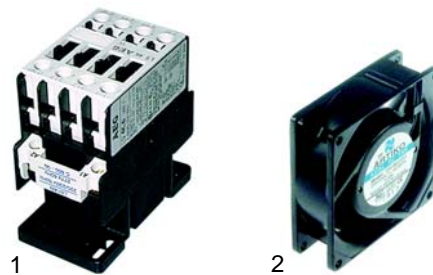

Item	Order	Description	Model	OEM
1	380244	contactor	NIE400	88477
2	601130	fan	NIE800	06125

Open tops (Ceran/electronic)



Item	Order	Description	Model	OEM
1	490134	2200W/230V (2-circuit)	MI/E350	59432
2	490044	2200W/230V (2-circuit)	MI/E700	A5299
3	490133	2100W/230V (2-circuit)	MIF/E700	59043
4	490028	2100W/230V (2-circuit)	MI/E1, MIF/E2	05008
5	490115	3400W/230V (2-circuit)	MI/E2, MIV/E2	
			HI/E400, HI/E800	02557
			NIE400, NIE800	

Open tops (induction)

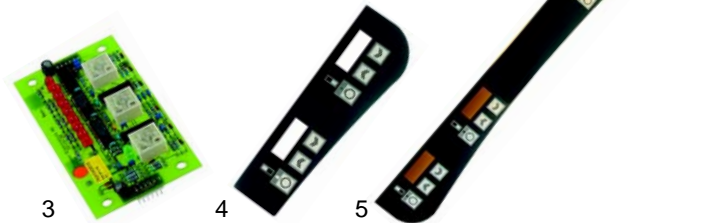
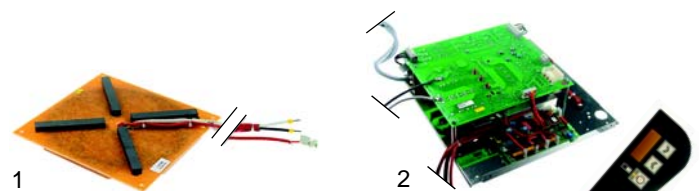

Item	Order	Description	Model	OEM
1	404001	coil, 5 kW/400W		0C0027
2	404002	frequency converter	NINE400	0C0028
3	404003	display p.c.b.	NINE800	0C0025
4	404004	fascia	NINE400	0C0026
5	404005	fascia	NINE800	0C0038



Item	Order	Description	Model	OEM
1	359326	residual temperature display		59047
2	359364	signal lamp/green	universal	05010, 58658
3	359365	signal lamp/yellow		05011, 58659
4	380004	energy regulator, 2-circuit		59046

Oven (gas)



Item	Order	Description	Model	OEM
1	104229	burner	RCF/G_, RTF/G	54117
2	104230	cover	MCF/G_	54119
3	104573	burner	MCF/G_	58979



Item	Order	Description	Model	OEM
1	104574	burner	PCFG_	04258
2	104230	cover	MCF/G990, MCFG/095,	54119
3	104575	burner	PCFG900	02513



Item	Order	Description	Model	OEM
1	105061	burner	HCF/G_(1st generation)	52717
2	104224	cover	HTF/G_(1st generation)	52048
3	104223	burner	HVCF/G (2.Gen.) HTFG (2.Gen.) NCFG_, NTFG_	59221
4	104576	cover	HCF/G_ HTF/G_	59596
5	104577	cover	NCFG_, NTFG_	0C0175



Item	Order	Description	Model	OEM
1	no longer available	gas thermostat	RCF/G	54129
2	111610	knob	RTF/G	54126
3	550677	gasket	MTF/G	54108



Item	Order	Description	Model	OEM
1	no longer available	gas thermostat	MCF/G	54635, 54129
2	110319	knob		58537

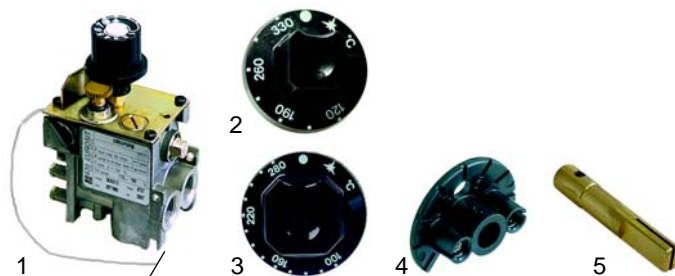

Item	Order	Description	Model	OEM
1	101409	Eurosit controller, 280 C		58772
2	110281	knob	MCF/G1090	59010
3	111611	knob	MCF/G1095	02130
4	101392	adapter	MCF/G995	58773
5	110357	spindle		03654

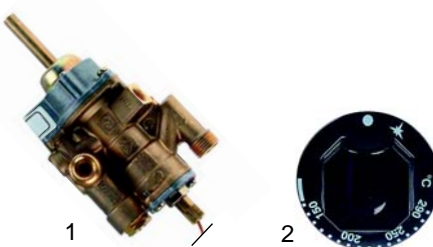

Item	Order	Description	Model	OEM
1	101955	thermostat PEL25	PCFG_	06597, 04257
2	111612	knob	PTFG_	04336

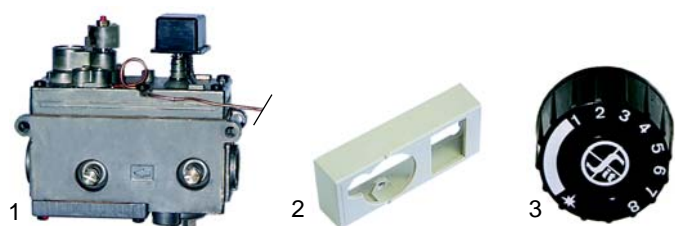

Item	Order	Description	Model	OEM
1	101435	Minisit controller		52068
2	101137	cover	HCF/G (1st generation)	56577
3	110068	knob	HTF/G (1st generation)	54268



Item	Order	Description	Model	OEM
1	101409	Eurosit controller		58772
2	101392	adapter	HCF/G (2.Gen.)	58773
3	110357	spindle	HTF/G (2.Gen.)	02130
4	110349	knob		59220



Item	Order	Description	Model	OEM
1	101960	controller		0C0209
2	111613	panel	NCFG_	0C0194
3	111614	knob	NTFG_	0C0189
4	111615	knob		0C0190

Ovens (electric)



Item	Order	Description	Model	OEM
1	415966	2500W/230V		04934
2	601011	motor		04933
3	359132	signal element/green	SCFE700	04895
3	359130	signal element/yellow		-
4	359123	insert lamp holder/green		04896
5	359124	insert lamp holder/yellow		04928

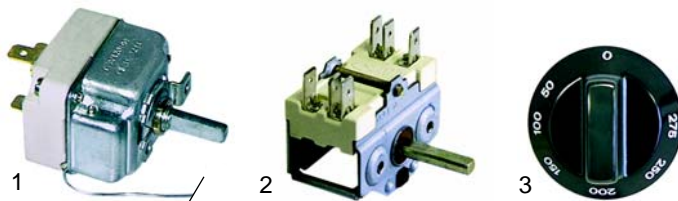

Item	Order	Description	Model	OEM
1	375002	thermostat		05421
2	300001	switch	SCFE700	04908
3	110707	knob		05432

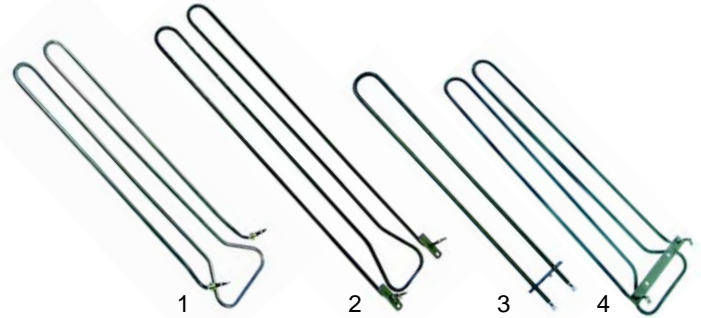

Item	Order	Description	Model	OEM
1	415078	1500W/230V	RCF/E, MCF/GE, MCF/G, MTF/GE, PCFGE, PCFE	54634 54147
2	415071	1500W/230V	HCF/GE, HTF/GE, HCF/G	53405 53608
3	415378	950W/230V	HCF/GE (2.Gen.) HCF/E (2.Gen.)	59237
4	416977	1500W/230V	NCFGE, NCFE	0C0310

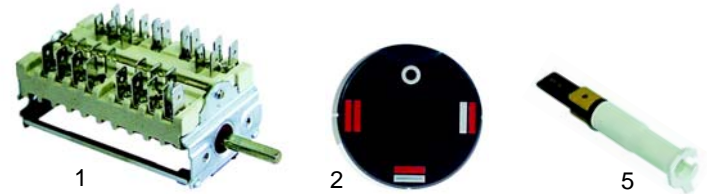

Item	Order	Description	Model	OEM
1	301090	switch		53866
2	111616	knob		53404
3	375424	thermostat		52099
4	111617	knob		53867
5	359109	signal element/green	RCF/E720	54150
5	359110	signal element/yellow		53811
6	359803	lens green		54151
7	359804	lens yellow		53812

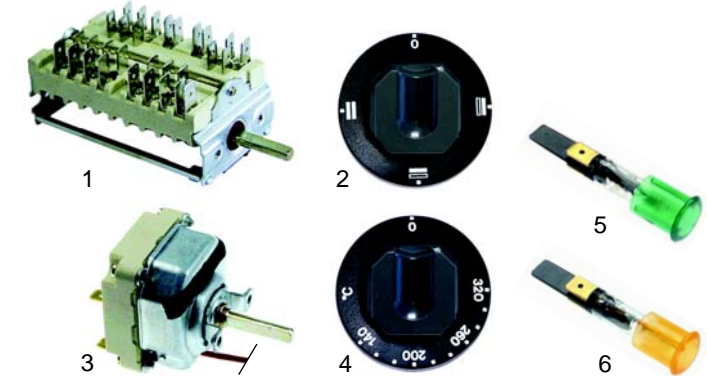

Item	Order	Description	Model	OEM
1	301090	switch		53866
2	110278	knob		58541
3	375424	thermostat	MCF/GE_	52099
4	110279	knob	MCF/E	58542
5	359364	signal element/green	MTF/E	58658
6	359365	signal element/yellow		58659

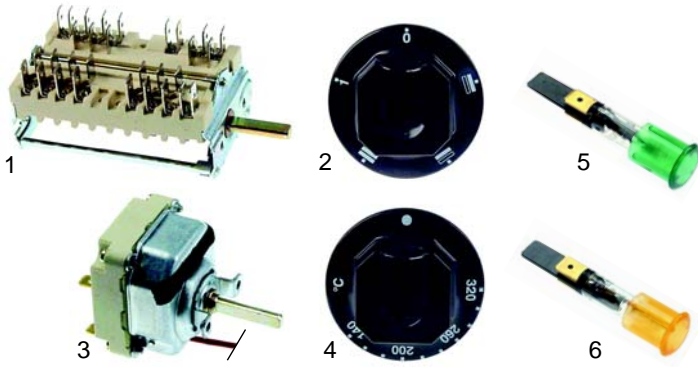

Item	Order	Description	Model	OEM
1	301211	switch		04268
2	111618	knob	PCFGE_	04343
3	375424	thermostat	PCFE_	52099
4	111619	knob	PIFE_	04330
5	359364	signal lamp/green		05010
6	359365	signal lamp/yellow		05011

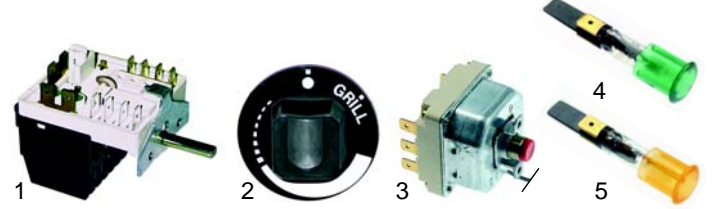

Item	Order	Description	Model	OEM
1	380017	energy regulator		53695
2	110426	knob		59850
3	375571	safety thermostat	HCF/GE (2nd generation),	51454
4	359364	signal lamp/green	HCF/E (2nd generation)	58658
5	359365	signal lamp/yellow		58659

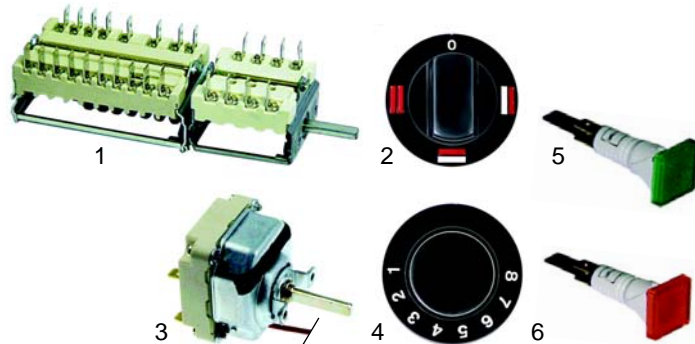

Item	Order	Description	Model	OEM
1	300013	switch combination		52721
2	110399	knob		52087
3	375424	thermostat	HCF/GE, HCF/GE,	52099
4	110046	knob	HCF/E	26915
5	359151	signal lamp/green		53148
6	359152	signal lamp/yellow		53149

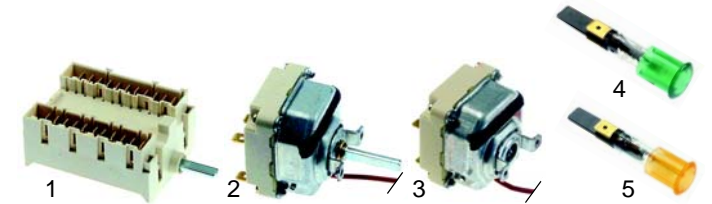

Item	Order	Description	Model	OEM
1	301215	switch		0C0320
2	375587	thermostat		59235
3	375565	safety thermostat	NCFGE, NCFE	0C0270
4	359364	signal lamp/green		05010
5	359365	signal lamp/yellow		05011

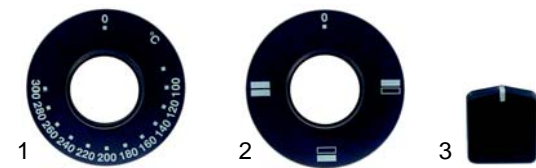

Item	Order	Description	Model	OEM
1	111620	panel		0C0258
2	111621	panel	NCFGE, NCFE	0C0259
3	111602	knob		0C0257

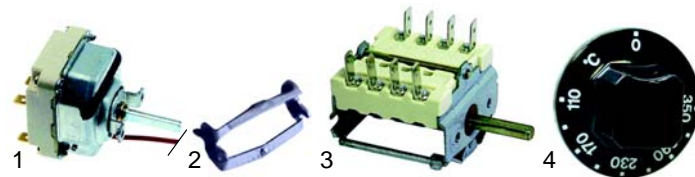

Item	Order	Description	Model	OEM
1	375587	thermostat		59235
2	550060	retainer	HCF/GE (2nd generation), HCF/E (2nd generation)	A2205
3	300002	switch		A2134
4	110427	knob		59236

Ovens (mechanical)

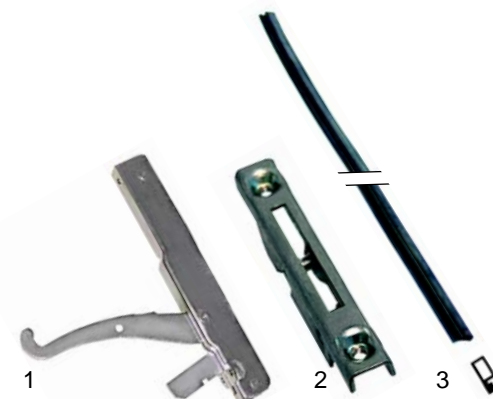

Item	Order	Description	Model	OEM
1	700010	hinge		50766, 59277, 0C0203
2	700001	body section	universal	-
3	900397	door seal/upper		54112, 54111

Hot cupboards (electric)

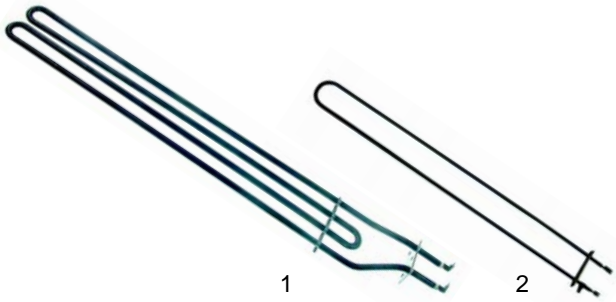

Item	Order	Description	Model	OEM
1	416978	2500W/230 V	700 series	A2201
2	415383	2500W/230 V	HMA/E800	52416, 52429

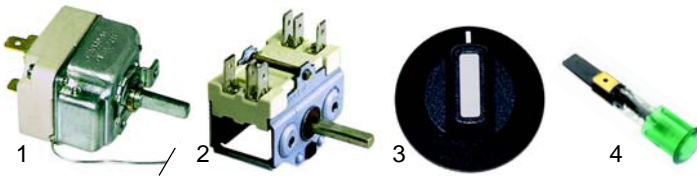

Item	Order	Description	Model	OEM
1	375055	thermostat		52000
2	300001	switch	700 series	A2036
3	110253	knob		A2269
4	359364	signal lamp		05010

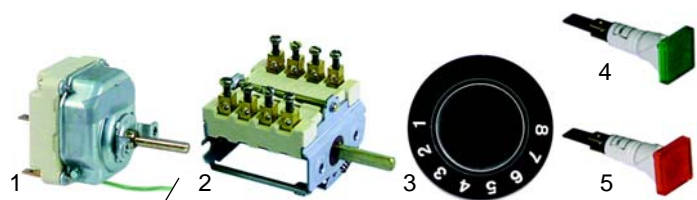

Item	Order	Description	Model	OEM
1	375411	thermostat		52000
2	300080	switch		26945
3	110046	knob	HMA/E800	26915
4	359151	signal lamp/green		53148
5	359152	signal lamp/yellow		53149

Fry tops (gas)



Item	Order	Description	Model	OEM
1	104290	burner	SRG350,	04954
2	101396	gas tap	SRG360,	04956
3	110710	knob	SRG700,	04957
4	100855	holder	SRG710	05618



Item	Order	Description	Model	OEM
1	102121	thermocouple, 600mm		04955
2	100009	piezoelectric igniter	SRG350, SRG360,	04944
3	100018	ignition cable	SRG700, SRG710	04943
4	100706	electrode		56754

Fry tops (gas)

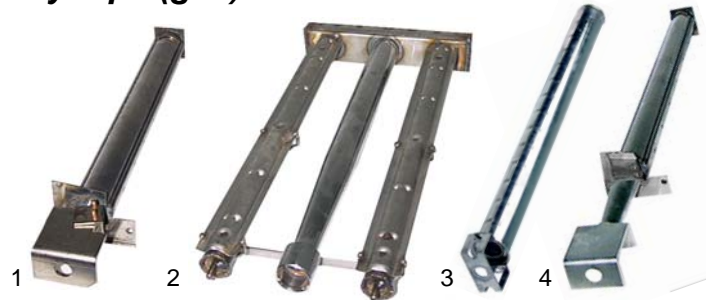

Item	Order	Description	Model	OEM
1	104227	burner	RR/G_, RRV/G, MR/G_	53380, 58696
2	104226	burner	MR/G_ (chromium-plated plate)	58770
3	104578	burner	MR/G1_, MR/G2, MRV/G1_, MRV/G1_, MRV/G2_	04591
4	104129	burner	HRS/G_	52912

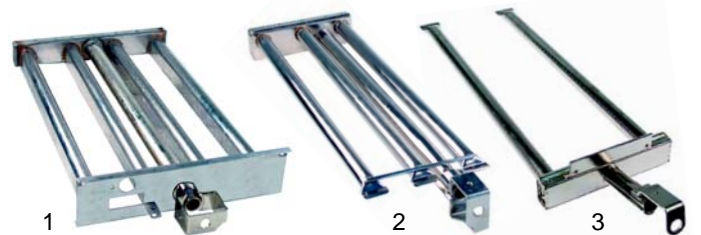

Item	Order	Description	Model	OEM
1	104579	burner	HRS/G_ (chromium-plated plate)	56002
2	104580	burner	HR/G (1st generation), CRAG_	A5124, OG2270
3	104581	burner	HR/G (2nd generation), NRG_	06650



Item	Order	Description	Model	OEM
1	101087	gas tap		52146, 53199
2	111599	knob	RR/G_, RRV/G_	52604
3	100007	piezoelectric igniter		52539

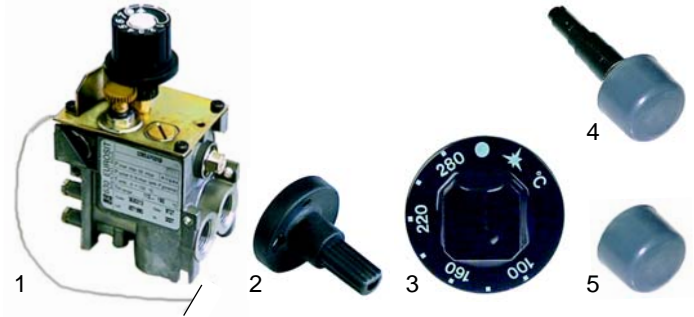

Item	Order	Description	Model	OEM
1	101409	Eurosit controller		58772
2	110358	adapter		03391
3	111623	knob	MR/G1_VC, MR/G2_VC	04658
4	100012	piezoelectric igniter		02605
5	101339	covering hood		02816



Item	Order	Description	Model	OEM
1	101087	gas tap		52146
2	110309	knob	MR/G	58597
3	100012	piezoelectric igniter		02605
4	101339	covering hood		02816



Item	Order	Description	Model	OEM
1	101087	gas tap		52146, 52921
2	110045	knob	HRS/G	52138
3	100007	piezoelectric igniter		52539

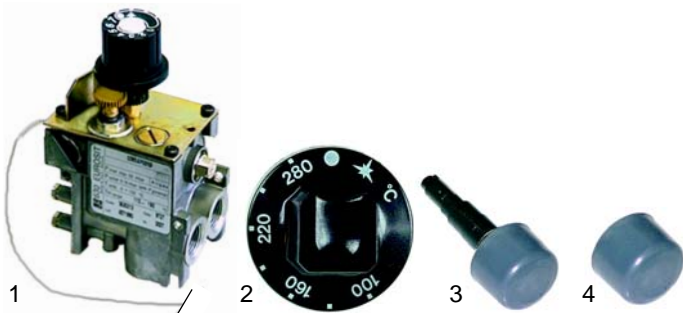

Item	Order	Description	Model	OEM
1	101409	Eurosit controller		58772
2	110308	knob	MR/G_	58776
3	100012	piezoelectric igniter	(chromium-plated plate)	02605
4	101339	covering hood		02816

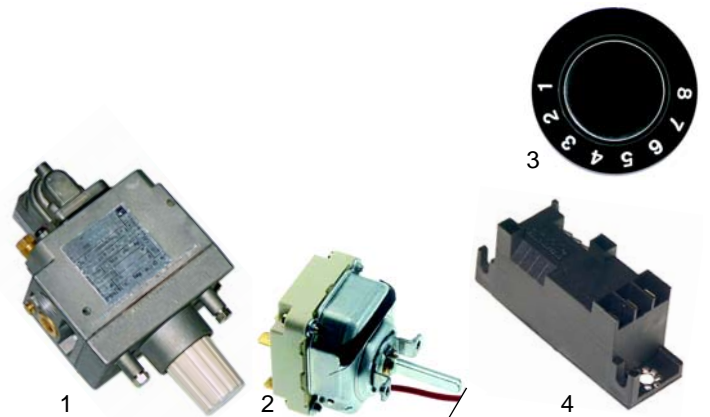

Item	Order	Description	Model	OEM
1	101183	composite valve		53973
2	375574	thermostat	HBS/G_VC	55996
3	110046	knob		26915
4	101002	ignition unit		53643



Item	Order	Description	Model	OEM
1	345038	push button		53978
2	345161	switch	HBS/G_VC	54518
3	345039	covering hood		53979

Z

Suitable for Zanussi

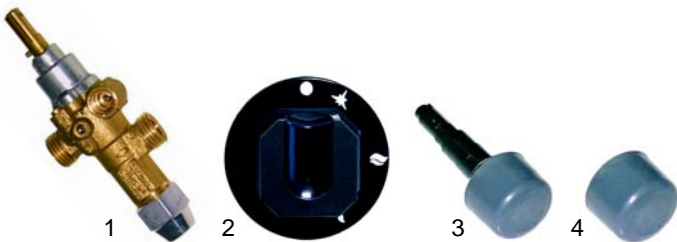

Item	Order	Description	Model	OEM
1	101095	gas tap		04282
2	110348	knob	MR/G1, MR/G2	59206
3	100012	piezoelectric igniter		02605
4	101339	covering hood		02816

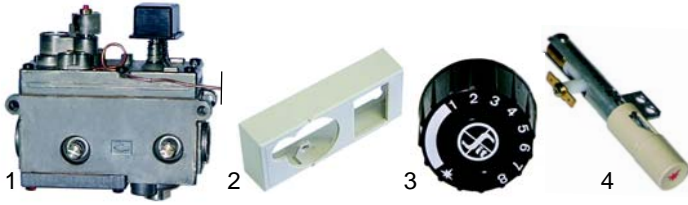

Item	Order	Description	Model	OEM
1	101435	Minisit controller		52068
2	101137	covering hood	HRS/G_VC	56577
3	110068	knob	(2nd generation)	54268
4	100007	piezoelectric igniter		58225

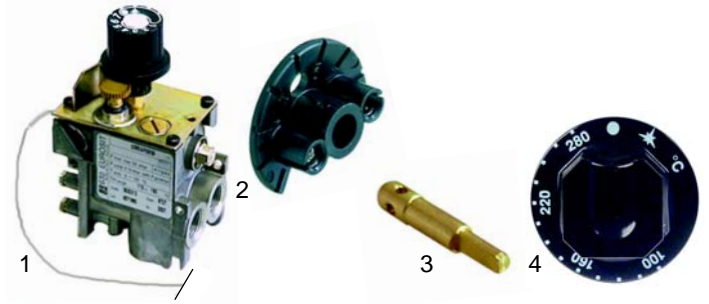

Item	Order	Description	Model	OEM
1	101409	Eurosit controller		58772
2	101392	adapter		58773
3	101390	spindle	HR/G_VC, CRAG_	02130
4	111624	knob		59422
5	100012	piezoelectric igniter		02605
6	101339	covering hood		02816

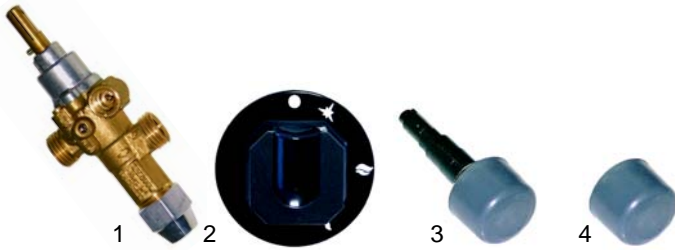

Item	Order	Description	Model	OEM
1	101095	gas tap PEL21		59460
2	110348	knob	HR/G	59206
3	100012	piezoelectric igniter		02605
4	101339	covering hood		02816



Item	Order	Description	Model	OEM
1	101957	gas regulator		06692
2	550679	gasket	HR/G	06465
3	111625	knob		06464

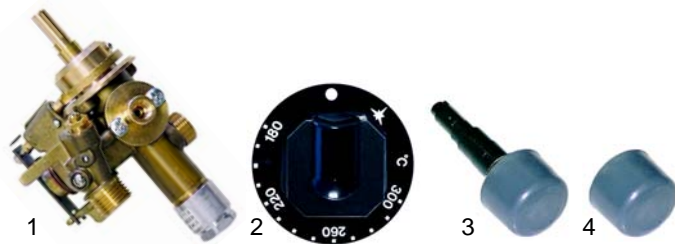

Item	Order	Description	Model	OEM
1	no longer available	gas thermostat		54129
2	110446	knob	HR/ G_thermostat	59413
3	100012	piezoelectric igniter		02605
4	101339	covering hood		02816

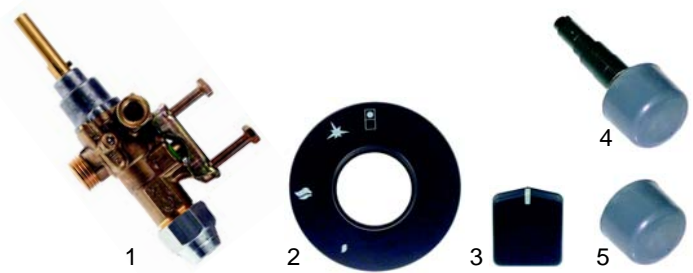

Item	Order	Description	Model	OEM
1	101897	gas tap		0C0205
2	111633	panel		0C0193
3	111598	knob	NRG_	0C0191
4	100012	piezoelectric igniter		02605
5	101339	covering hood		02816



Item	Order	Description	Model	OEM
1	101957	gas regulator		06692
2	111626	panel	NRG_ (thermostat), NRG_VC	0C0597
3	111614	knob		0C0189
4	111615	knob		0C0190

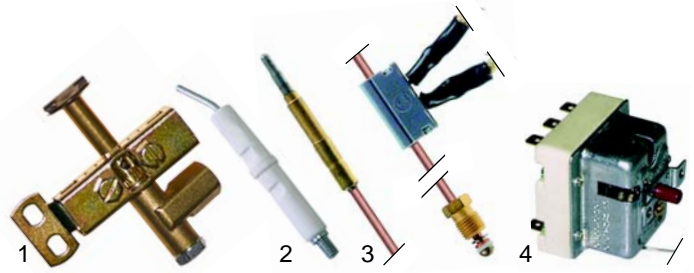

Item	Order	Description	Model	OEM
1	100106	pilot burner EG		58329
2	100706	electrode	MR/G_VC	56754
3	102250	thermocouple, 1000mm		56914
4	375163	safety thermostat		51643



Item	Order	Description	Model	OEM
1	100046	pilot burner FG	RR/G_, RRV/G_	50813
2	100708	electrode	HRS/G,	51977
3	102041	thermocouple, 600mm	HRS/G_VC (1st generation)	57781



Item	Order	Description	Model	OEM
1	100050	pilot burner		59379
2	100701	electrode	MR/G1, MR/G2, HR/G_, NRG_	59380
3	102038	thermocouple, 1500mm		51119

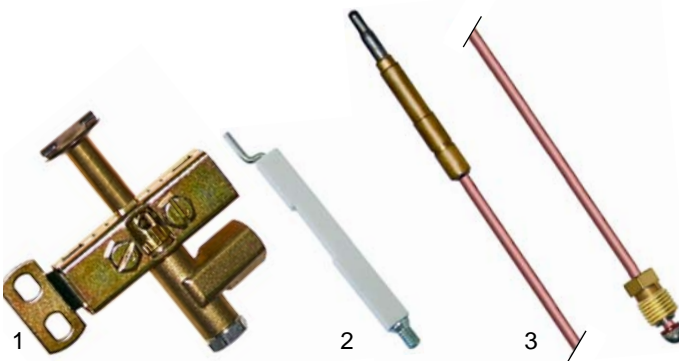

Item	Order	Description	Model	OEM
1	100106	pilot burner EG		58329
2	100706	electrode	MR/G,	56754
3	102045	thermocouple, 1500mm	HRS/G_VC (2nd generation)	52814



Item	Order	Description	Model	OEM
1	100050	pilot burner	MR/G1_VC, MR/G2_VC,	59379
2	100701	electrode	HR/G_VC, HR/G_ (2nd generation),	59380
3	102250	thermocouple, 1000mm	NRG_VC, CRAG_VC	56914

Fry tops (electric)

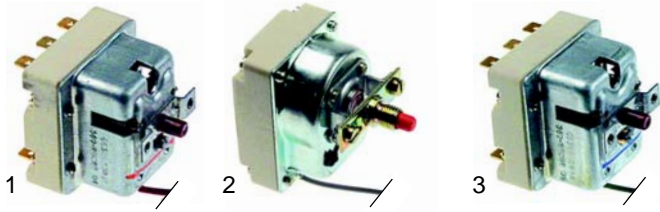

Item	Order	Description	Model	OEM
1	375563	safety thermostat, 3-pole, 360 C	HR/G1_VC, HR/G2_VC	04600
2	375572	safety thermostat, 1-pole, 360 C	HR/G_VC	53980
3	375562	safety thermostat, 3-pole, 360 C	HR/G_(2nd generation), NRG_VC, CRAG_VC	04269

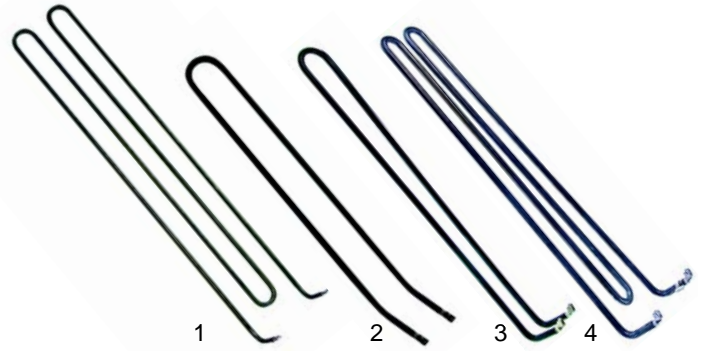

Item	Order	Description	Model	OEM
1	415290	1300W/230V	SRE_	04918
2	415079	1250W/230V	RR/E_, RRV/E_, MR/E_	53393, 53614
3	416985	1250W/230V	PRE_, PREV_	04649
4	416986	1500W/230V	RRE_VC, PREV_VC	04671

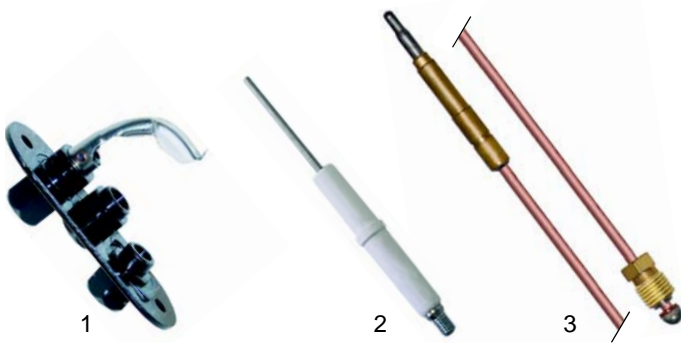

Item	Order	Description	Model	OEM
1	100198	pilot burner	NRG_	05503
2	100701	electrode	(thermostat)	59380
3	102041	thermocouple, 600mm		25031

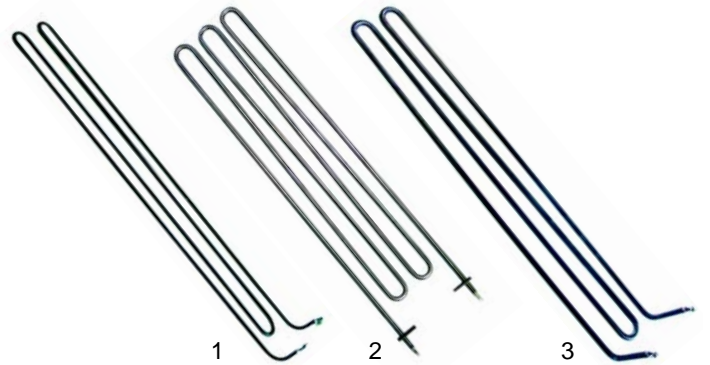

Item	Order	Description	Model	OEM
1	415382	2000W/230V	HRS/E_VC	55998
1	415380	1000W/230V	HRS/E	52919, 52920
2	415184	2200W/230V	HR/E_	59401
3	416987	2500W/230V	HR/E_, NRE_	06681



Item	Order	Description	Model	OEM
1	100050	pilot burner		59375
2	100701	electrode	CRAG_	59380
3	102044	thermocouple, 1200mm		20094

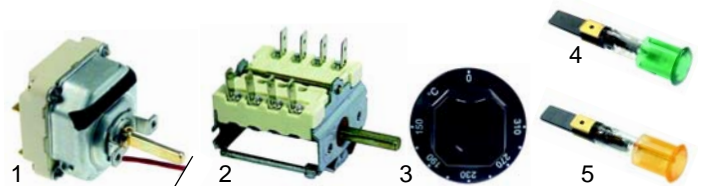

Item	Order	Description	Model	OEM
1	375560	thermostat		04363
2	300002	switch		A2134
3	111627	knob	PRE_, RREV_, MR/E1, MR/E2, MRV/E1, MRV/E2	04710
4	359364	signal lamp/green		05010
5	359365	signal lamp/yellow		05011

Z

Suitable for Zanussi

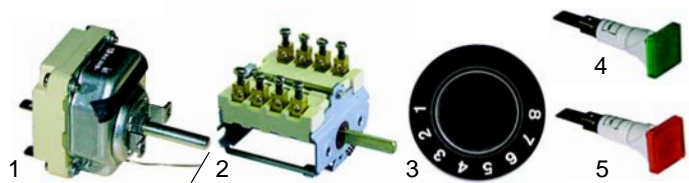

Order	Description	Model	OEM
1 375038	thermostat		52916
2 300080	switch		26945
3 110046	knob	HRS/E	26915
4 359151	signal lamp/green		53148
5 359152	signal lamp/yellow		53149



Item Order	Description	Model	OEM
1 375574	thermostat		55996
2 300080	switch		26945
3 110046	knob	HRS/E_VC	26915
4 359151	signal lamp/green		53148
5 359152	signal lamp/yellow		53149

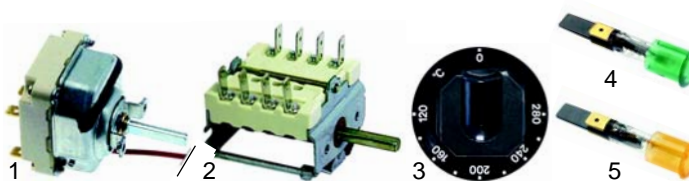

Item Order	Description	Model	OEM
1 375587	thermostat		59235
2 300002	switch		A2134
3 110447	knob	HR/E	59403
4 359364	signal lamp/green		58658
5 359365	signal lamp/yellow		58659

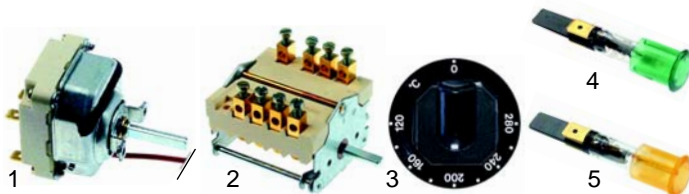

Item Order	Description	Model	OEM
1 375587	thermostat		59235
2 300180	switch		06649
3 110447	knob	HR/E_VC	59403
4 359364	signal lamp/green		05010
5 359365	signal lamp/yellow		05011

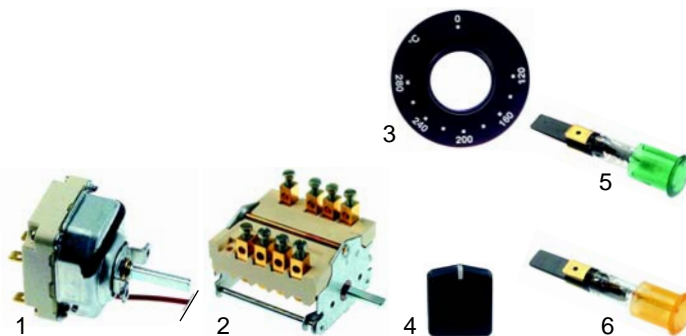

Item Order	Description	Model	OEM
1 375587	thermostat		599235
2 300180	switch		06649
3 111628	panel	NRE_, NRFE_	0C0466
4 111602	knob		0C0257
5 359364	signal lamp/green		05010
6 359365	signal lamp/yellow		05011

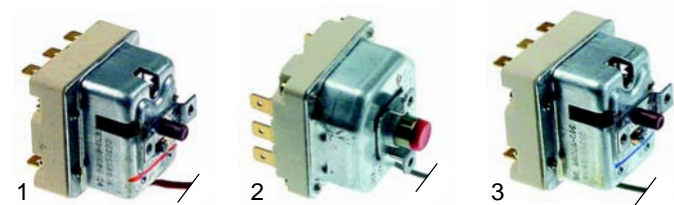

Item Order	Description	Model	OEM
1 375557	safety thermostat, 270 C	MR/E_VC, PRE_VC	06307
2 375571	safety thermostat, 350 C	HR/E	51454
3 375562	safety thermostat, 360 C	HR/E_VC, NRE_, NRFE_	04269

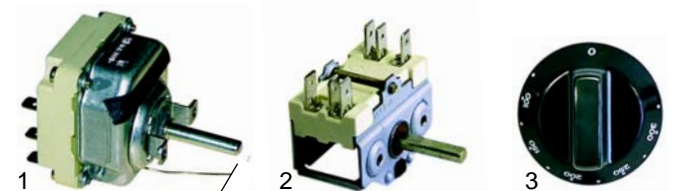

Item Order	Description	Model	OEM
1 375183	thermostat		04917
2 300001	switch	SRE_	04908
3 110713	knob		04916



Item Order	Description	Model	OEM
1 390142	safety thermostat		049919
2 359132	signal element	SRE_	04895
3 359123	insert lamp holder		04896

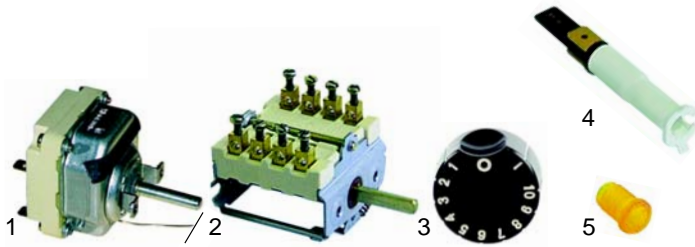

Item	Order	Description	Model	OEM
1	375038	thermostat		52916
2	300080	switch		26945
3	111629	knob	RR/E_, RRV/E_	26801
4	359110	signal element		53811
5	359804	lens		53812



Item	Order	Description	Model	OEM
1	101397	gas tap		04961
2	110716	knob	SCG350, SCG700	04966
3	102041	thermocouple, 600mm		04942

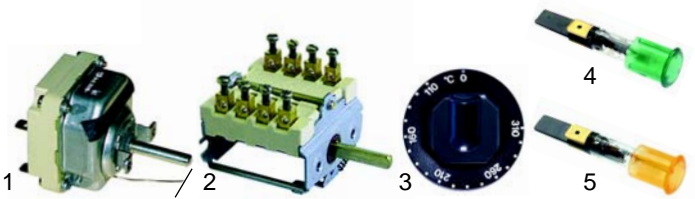

Item	Order	Description	Model	OEM
1	375038	thermostat		52916
2	300080	switch		26945
3	110342	knob	MR/E	58579
4	359364	signal lamp/green		58658
5	359365	signal lamp/yellow		58659



Item	Order	Description	Model	OEM
1	100043	pilot burner		04962
2	100706	electrode	SCG350, SCG700	56754
3	100018	ignition cable, 600mm		-
4	100009	piezoelectric igniter		04944

Lava rock grills (gas)

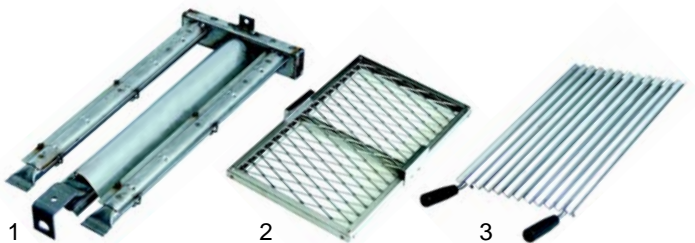

Item	Order	Description	Model	OEM
1	105483	burner		05656
2	211024	lava rock grid	SCG350, SCG700	04964
3	211025	grill grid		04963

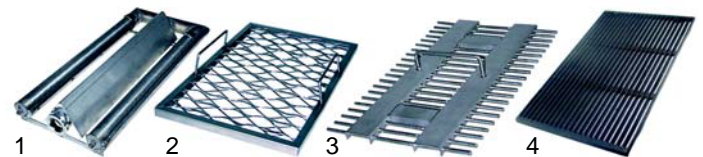

Item	Order	Description	Model	OEM
1	104128	burner		52855, 56555
2	211051	lava rock grid	RG/G_, RGV/G_	56657
3	211006	lava rock grid	MG/G_	54711
4	211034	grill grid		53693

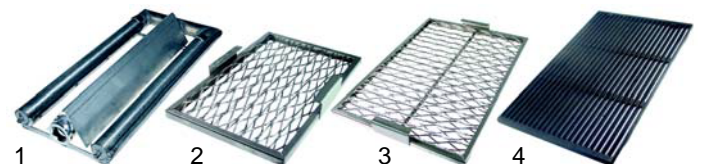

Item	Order	Description	Model	OEM
1	104128	burner		56555
2	211035	lava rock grid (350)	SCG_, MG/G1,	06205
3	211036	lava rock grid (700)	MG/G2	06206
4	211034	grill grid		53693

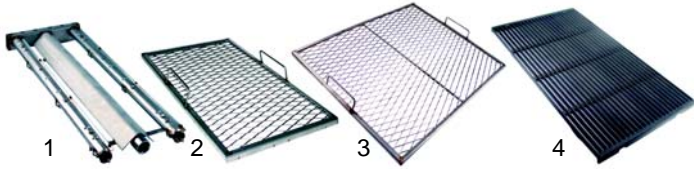

Item	Order	Description	Model	OEM
1	104582	burner		02358
2	211059	lava rock grid (400)	HG/G400,	02385
3	211037	lava rock grid (800)	HG/G800	02395
4	211038	grill grid		02389

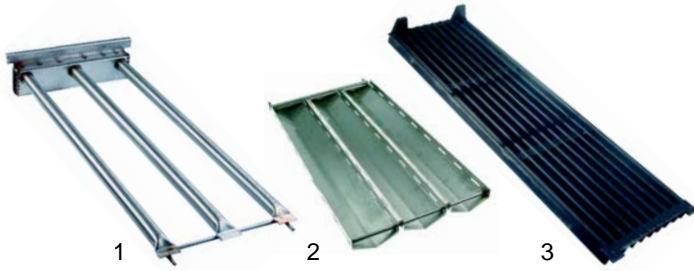

Item	Order	Description	Model	OEM
1	104583	burner		0C0490
2	211039	lava rock grid	NGG400,	0C0479
3	211041	grill grid	NGG800	0C0424

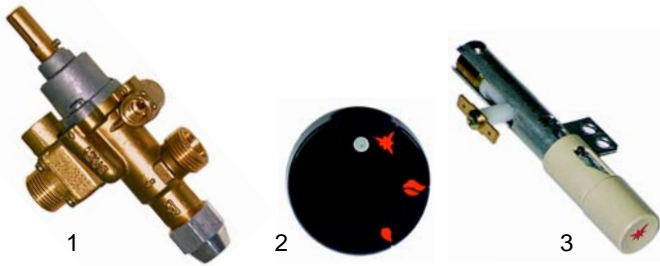

Item	Order	Description	Model	OEM
1	101087	gas tap		52146
2	111599	knob	RG/G_,	52604
3	100007	piezoelectric igniter	RGV/G_	52539



Item	Order	Description	Model	OEM
1	100046	pilot burner		50813
2	100708	electrode	RG/G_,	51977
3	102045	thermocouple, 1500mm	RGV/G_	52814

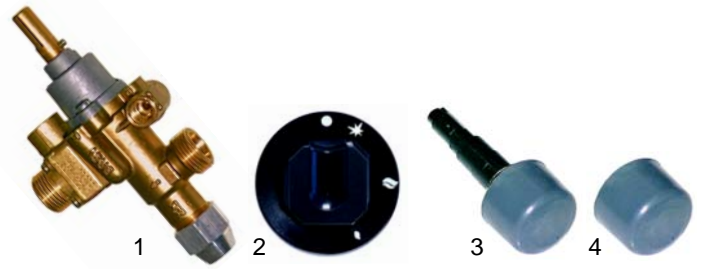

Item	Order	Description	Model	OEM
1	101087	gas tap		52146
2	110309	knob	MG/G_	58597
3	100012	piezoelectric igniter		02605
4	101339	covering hood		02816

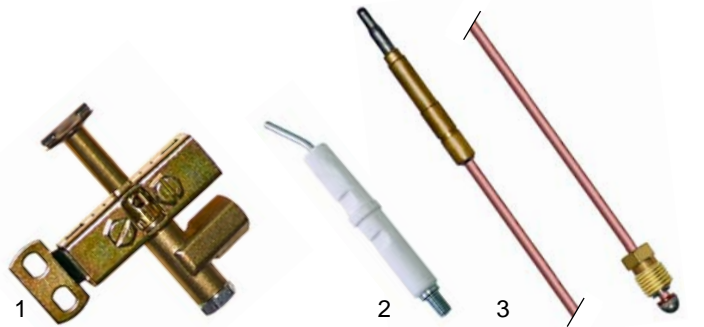

Item	Order	Description	Model	OEM
1	100106	pilot burner		58329
2	100706	electrode	MG/G_	56754
3	102045	thermocouple, 1500mm		52814



Item	Order	Description	Model	OEM
1	101095	gas tap		59460
2	111630	knob	MG/G1, MG/G2,	04821
3	100012	piezoelectric igniter	SCG350,	02605
4	101339	covering hood	SCG700	02816



Item	Order	Description	Model	OEM
1	100109	pilot burner		A2472
2	100701	electrode	MG/G1,	52610
3	102038	thermocouple, 1500mm	MG/G2, SCG_	51119



Item	Order	Description	Model	OEM
1	101087	gas tap		52146
2	110448	knob	HG/G400, HG/G800	59378
3	100012	piezoelectric igniter		02605
4	101339	covering hood		02816



Item	Order	Description	Model	OEM
1	100109	pilot burner		A2472
2	100701	electrode	HG/G400, HG/G800	52610
3	102045	thermocouple, 1500mm		52814

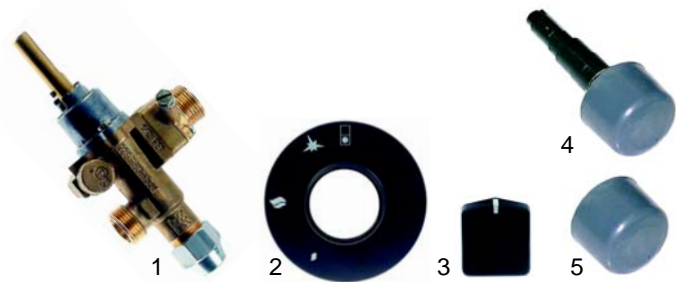

Item	Order	Description	Model	OEM
1	101981	gas tap		0C0489
2	111632	panel	NGG400, NGG800	0C0192
3	111631	knob		0C0465
4	100012	piezoelectric igniter		02605
5	101339	covering hood		02816



Item	Order	Description	Model	OEM
1	100046	pilot burner		0C0494
2	100706	electrode	NGG400, NGG800	0C0488
3	102045	thermocouple, 1500mm		52814

Grills (electrical)

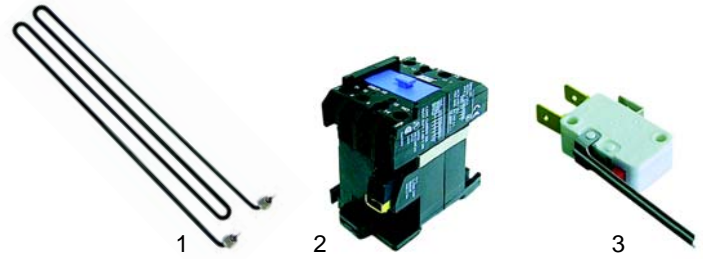

Item	Order	Description	Model	OEM
1	415288	1350W/230V		04907
2	380204	contactor	SGE350, SGE700	03027
3	345254	micro switch		04904



Item	Order	Description	Model	OEM
1	380015	energy regulator		05270
2	110708	knob	SGE350, SGE700	04987
3	359132	signal element		04985
4	359123	insert lamp holder		04986

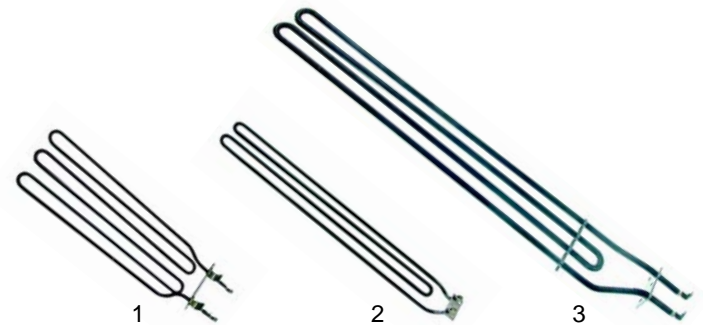

Item	Order	Description	Model	OEM
1	415352	3000W/230V	RG/E300, RG/E700, MG/E350, MG/E700, MG/E1, MG/E2, SGE350, MGV/E1, MGV/E2	53451, 53613
2	415376	1800W/230V	HG/E400, HG/E800	02403
3	416978	2500W/400V	NGE400, NGE800	0C0495

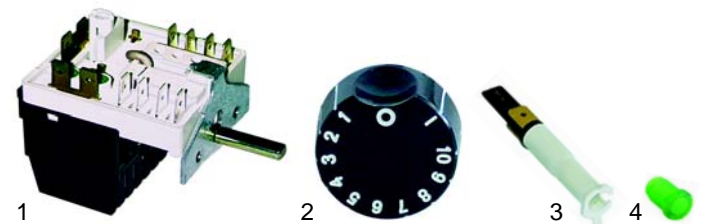

Item	Order	Description	Model	OEM
1	380017	energy regulator		53695, 53697
2	110898	knob	RG/E350, RG/E700	53694
3	359109	signal element		54150
4	359803	lens		54151

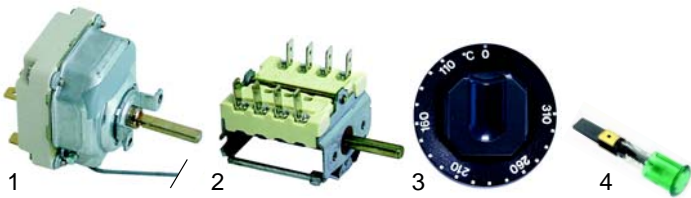

Item	Order	Description	Model	OEM
1	375412	thermostat		A2206
2	300002	switch	MG/350, MG700	A2134
3	110342	knob		58579
4	359364	signal lamp		58658

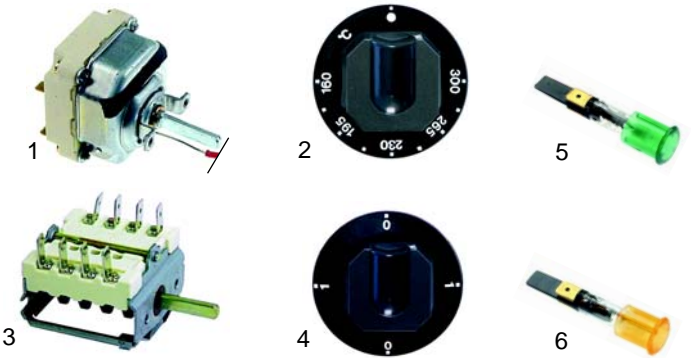

Item	Order	Description	Model	OEM
1	375559	thermostat		02402
2	110466	knob		02401
3	300017	switch	HG/E400, HG/E800	A2241
4	110449	knob		59333
5	359364	signal lamp/green		58658
6	359365	signal lamp/yellow		58659

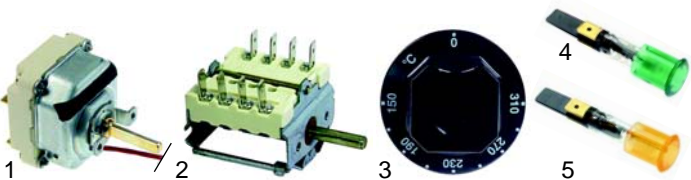

Item	Order	Description	Model	OEM
1	375560	thermostat		04363
2	300002	switch		A2134
3	111627	knob	MR/E1, MR/E2, MRV/E1, MRV/E2, SGE350	04710
4	359364	signal lamp/green		05010
5	359365	signal lamp/yellow		05011

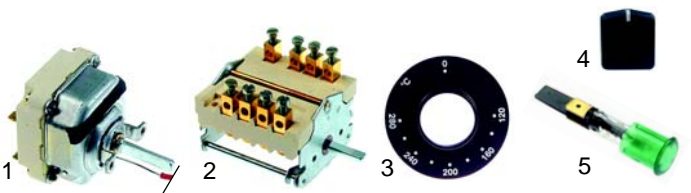

Item	Order	Description	Model	OEM
1	375559	thermostat		02402
2	300180	switch		06649
3	111628	panel	NGE400, NGE800	0C0466
4	111602	knob		0C0257
5	359364	signal lamp/green		05010

Multi bratt pans (gas)



Item	Order	Description	Model	OEM
1	104584	burner	MMV/G1, PBRG360	06462
2	104585	burner	MMV/G2, PBRG710	06471



Item	Order	Description	Model	OEM
1	101959	gas regulator		06460
2	111625	knob	MMV/G1, MMV/G2, PBRG360, PBRG710	06464
3	550679	gasket		06465
4	375562	safety thermostat		04269



Item	Order	Description	Model	OEM
1	100051	pilot burner		54032
2	100701	electrode	MMV/G1, MMV/G2, PBRG360, PBRG710	52610
3	102250	thermocouple, 1000mm		59614

Pasta cookers (gas)



Item	Order	Description	Model	OEM
1	105407	burner	SCPG350	05794
2	105637	burner	MCP/G_, HCP/G_ (from '95), CCPG_	59523
3	105638	burner	MCP/G1, MCP/G2, PCPG350, PCPG700	04726



Item	Order	Description	Model	OEM
1	105639	burner	HCP/G400, HCP/G800	56638
2	105640	burner	HCP/G400, HCP/G800 (from 20.01.'90)	56877
3	105641	burner	NCPG_	04847

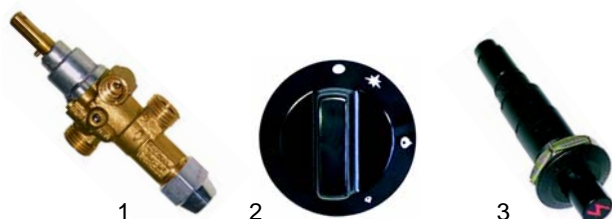

Item	Order	Description	Model	OEM
1	101397	gas tap		04961
2	110716	knob	SCPG350	-
3	100009	piezoelectric igniter		04944



Item	Order	Description	Model	OEM
1	100046	pilot burner		04962
2	100706	electrode	SCPG350	56754
3	102121	thermocouple, 600mm		04955



Item	Order	Description	Model	OEM
1	101087	gas tap		52146
2	110309	knob	MCP/G_	58597
3	100012	piezoelectric igniter		02605
4	101339	covering hood		02816



Item	Order	Description	Model	OEM
1	100054	pilot burner		03204
2	100701	electrode	MCP/G	52610
3	102041	thermocouple, 600mm		25031

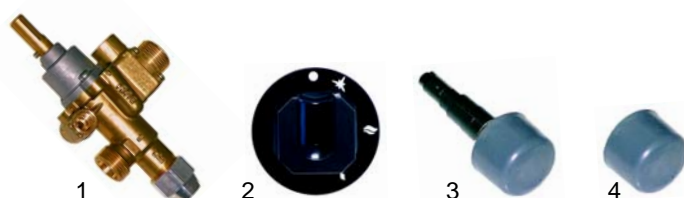

Item	Order	Description	Model	OEM
1	101087	gas tap		52146
2	110448	knob	MCP/G	59378
3	100012	piezoelectric igniter		02605
4	101339	covering hood		02816



Item	Order	Description	Model	OEM
1	100051	pilot burner		54032
2	100701	electrode	MCP/G	52610
3	102041	thermocouple, 600mm		25031



Item	Order	Description	Model	OEM
1	101103	Babysit gas valve	HCP/G	56630
2	100007	piezoelectric igniter	(1st generation)	52539



Item	Order	Description	Model	OEM
1	100056	pilot burner	HCP/G	58146
2	100701	electrode	(1st generation)	56640
3	102045	thermocouple, 1500mm		56631



Item	Order	Description	Model	OEM
1	101087	gas tap	HCP/G (2nd generation)	52146
2	110045	knob		52138
3	345038	push button		53978
4	345039	protective cover		53979
5	101002	ignition unit		53647

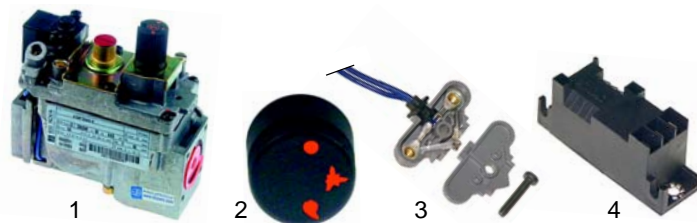

Item	Order	Description	Model	OEM
1	101956	Novasit gas valve	NCPG_	02903
2	111646	knob		03704
3	101312	micro switch		54339
4	101002	ignition unit		04240



Item	Order	Description	Model	OEM
1	100106	pilot burner	HCP/G (2nd generation)	58329
2	100706	electrode		56754
3	102041	thermocouple, 600mm		25031



Item	Order	Description	Model	OEM
1	100051	pilot burner	NCPG	54032
2	100706	electrode		52610
3	102041	thermocouple, 600mm		25031

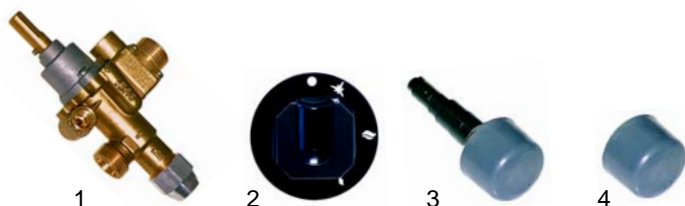

Item	Order	Description	Model	OEM
1	101087	gas tap	HCP/G (3rd generation), CCPG_	52146
2	110448	knob		59378
3	100012	piezoelectric igniter		02605
4	101339	covering hood		02816

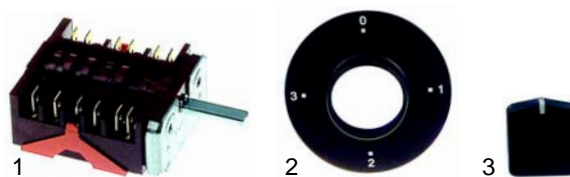

Item	Order	Description	Model	OEM
1	301216	switch	NCPG	59544
2	111635	panel		0C0560
3	111602	knob		0C0257



Item	Order	Description	Model	OEM
1	100109	pilot burner	HCP/G (3rd generation), CCPG_	A2472
2	100701	electrode		52610
3	102041	thermocouple, 600mm		25031

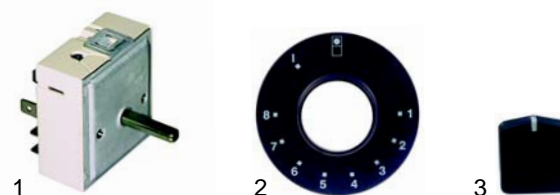

Item	Order	Description	Model	OEM
1	380015	energy regulator	NCPG	55016
2	111609	panel		0C0318
3	111602	knob		0C0257



Item	Order	Description	Model	OEM
1	370336	solenoid valve	NCPG	0C0561
2	541178	pressure switch		49620
3	359364	signal lamp/green		05010

Pasta cookers (gas - fast cooking system)

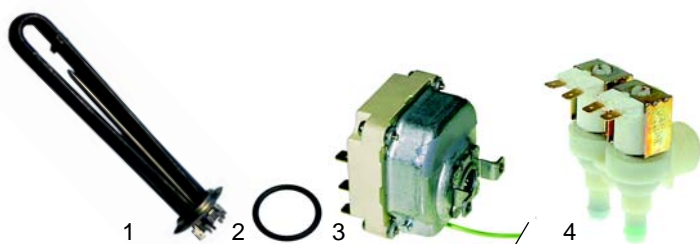

Item	Order	Description	Model	OEM
1	415597	3000W/230V	MCP/G, HCP/G (2nd generation)	47505
2	510408	O-ring		46213
3	390038	thermostat		45169
4	370337	solenoid valve		56872



Item	Order	Description	Model	OEM
1	301216	switch		59544
2	111636	knob	MCP/G	03323
3	359364	signal lamp/green		58658



Item	Order	Description	Model	OEM
1	346298	switch		56879
2	346297	switch	HCP/G	56880
3	345161	switch	(2nd generation)	54518
4	380312	relay		56466

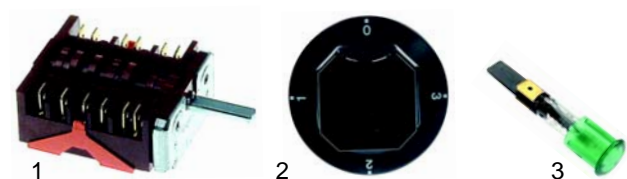

Item	Order	Description	Model	OEM
1	301216	switch	HCP/G	59544
2	111637	knob	(3rd generation)	59546
3	359364	signal lamp/green		05010

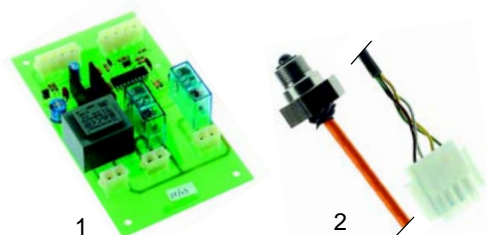

Item	Order	Description	Model	OEM
1	400991	level regulator	universal	59785
2	361642	electrode		59784

Pasta cookers (electric)

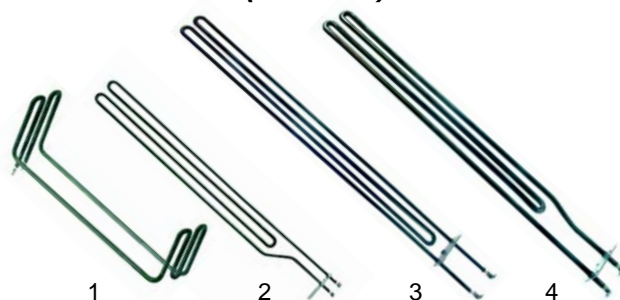

Item	Order	Description	Model	OEM
1	416619	1650W/230V	SCPE350	05816
2	415691	1450W/230V	RCP/E700, MCP/E700, MCP/E25, PCPE710, HCP/E400 (from 01.'90), HCP/E800 (from 01.'90)	56906
3	416979	1700W/230V	HCP/E400 (from 03.'92), HCP/E800 (from 03.'92)	06853
4	416980	1650W/230V	MCP/E25H, PCPE720	06853

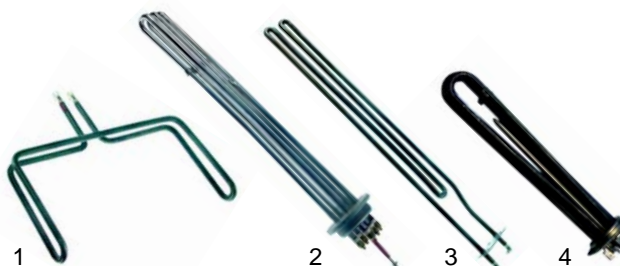

Item	Order	Description	Model	OEM
1	416981	1000W/230V	MCP/E1, MCP/E2P, PCPE350, PCPE700	A5492
2	416982	4000W/400V	HCP/E400 (1st generation), HCP/E800 (1st generation)	56618
3	416980	1650W/230V	NCPE	06853
4	415597	3000W/230V	universal (fast cooking system)	



Item	Order	Description	Model	OEM
1	300102	switch		50857
2	111638	knob		26797
3	301009	switch	RCP/E700	51647
4	111639	knob		51697
5	359109	signal element		54150
6	359803	lens		54151

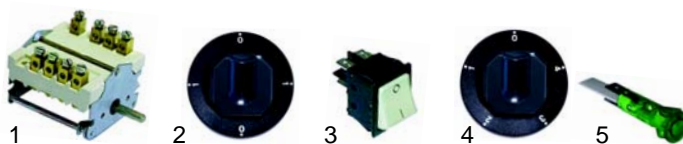

Item	Order	Description	Model	OEM
1	300102	switch		50857
2	110315	knob		58629
3	301009	switch	MCP/E700	51647
4	110347	knob		58681
5	359139	signal lamp		58544

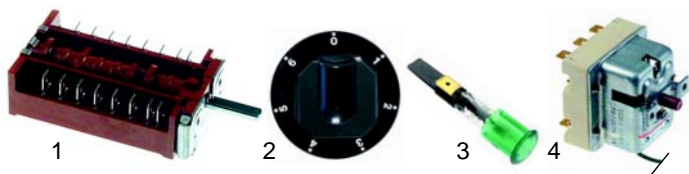

Item	Order	Description	Model	OEM
1	301210	switch		04741
2	110428	knob	MCP/E1S, MCP/E2D,	59230
3	359364	signal lamp	PCPE360, PCPE700	05010
4	375558	safety thermostat		04742

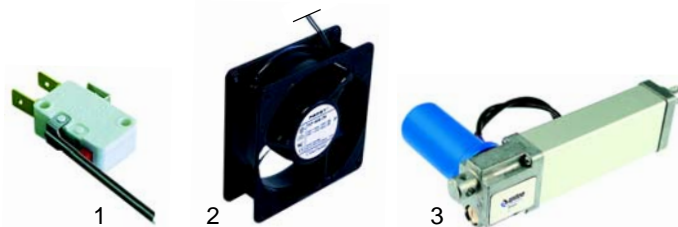

Item	Order	Description	Model	OEM
1	345254	micro switch		53671
2	601030	fan	MCP/E25H, PCPE720	06878
3	500621	spindle motor		06690

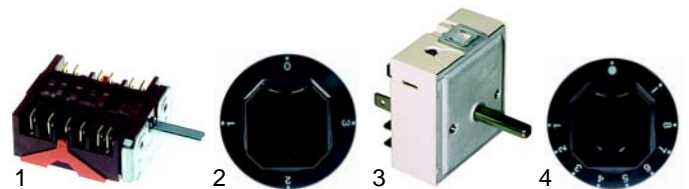

Item	Order	Description	Model	OEM
1	301216	switch		59544
2	111637	knob	MCP/E2S, PCPE710,	59546
3	380015	energy regulator	PCP/E25M, PCPE720	55016
4	111640	knob		59779

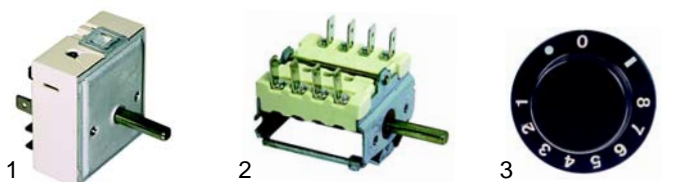

Item	Order	Description	Model	OEM
1	380015	energy regulator		55016
2	300002	switch	HCP/E400 (from 03.'92), HCP/E800 (from 03.'92)	A2134
3	111641	knob		59067



Item	Order	Description	Model	OEM
1	350071	timer	MCP/E2S, PCPE710	54504
2	350070	alarm device		55368
3	345038	push button		58274
4	345039	protective cover	MCP/E2S, MCP/E25M,	53979
5	359364	signal lamp	PCPE710, PCPE720	05010



Item	Order	Description	Model	OEM
1	346298	switch		56879
2	346297	switch	HCP/E400 (from 01.'90), HCP/E800 (from 01.'90)	56880
3	380312	relay		56466

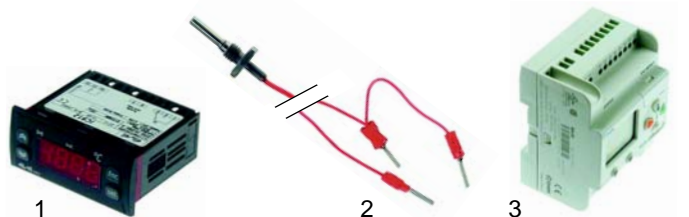

Item	Order	Description	Model	OEM
1	379567	electronic controller		06154
2	379921	sensor	MCP/E25H, PCPE720	58953
3	400992	PCC-Millennium		06880

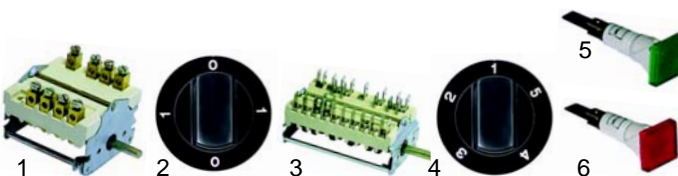

Item	Order	Description	Model	OEM
1	300102	switch		50857
2	110043	knob		50341
3	301009	switch	HCP/E400	51647
4	110042	knob	(until 01.'90), HCP/E800 (until 01.'90)	51552
5	359151	signal lamp/green		53148
6	359150	signal lamp/yellow		53150

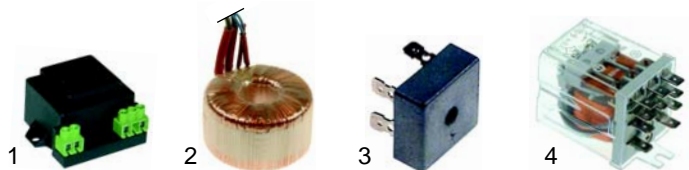

Item	Order	Description	Model	OEM
1	379054	transformer, 230V/12V		A2497
2	379395	transformer, 240V/24V (200VA)		06159
3	379396	rectifier	MCP/E25H, PCPE720	06147
4	380636	relay, 24V		56510



Item	Order	Description	Model	OEM
1	301217	switch	HCP/E400 (from 01.'90), HCP/E800 (from 01.'90)	56907
2	110397	knob		52183

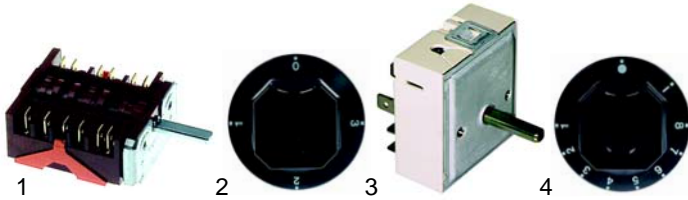

Item	Order	Description	Model	OEM
1	301216	switch		59544
2	111637	knob	HCP/E400 (from '95), HCP/E800 (from '95)	59546
3	380015	energy regulator		55016
4	111640	knob		59779

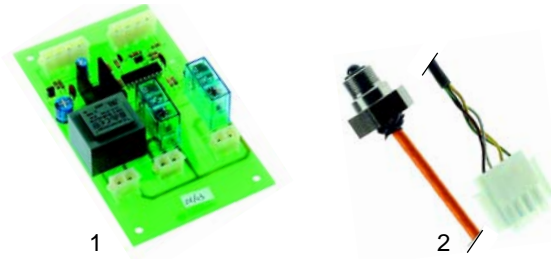

Item	Order	Description	Model	OEM
1	400991	level control p.c.b.	universal	59785
2	361642	electrode		59784

Pasta cookers (mechanical)

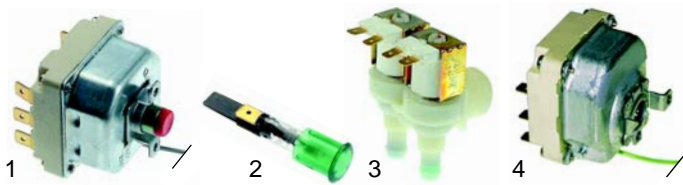

Item	Order	Description	Model	OEM
1	375573	safety thermostat		59552
2	359364	signal lamp		05010
3	370337	solenoid valve	HCP/E400 (from '95), HCP/E800 (from '95)	56872
4	390038	thermostat		45169



Item	Order	Description	Model	OEM
1	540927	drain tap	HCP_, RCPE700,	56885
2	540928	extension	MCP/G_, MCP/ E_, MCP/E2S,	56985
3	540929	handle	MCP/E25H, PCPE710/720	56887

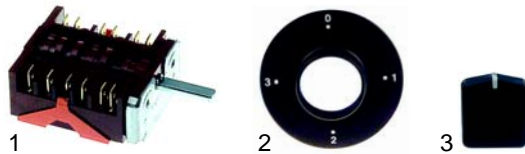

Item	Order	Description	Model	OEM
1	301216	switch		59544
2	111635	panel	NCPE400/410, NCPE800/810	0C0560
3	111602	knob		0C0257

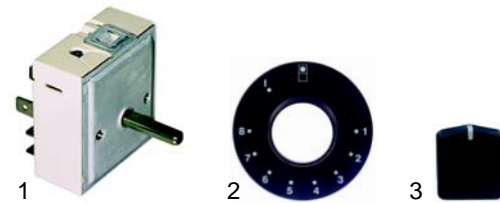

Item	Order	Description	Model	OEM
1	380015	energy regulator		55016
2	111609	panel	NCPE400/410, NCPE800/810	0C0318
3	111602	knob		0C0257



Item	Order	Description	Model	OEM
1	370336	solenoid valve		0C0561
2	541178	pressure switch	NCPE400/410	49620
3	359364	signal lamp/green		05010



Item	Order	Description	Model	OEM
1	540930	inlet tap		03517
2	111642	knob	MCP/G_ (old)	58632



Item	Order	Description	Model	OEM
1	540931	inlet tap		56843
2	540932	adapter	MCP/G1, MCP/ G2, MCP/E1S,	A2563
3	540933	extension	MCP/E2D,	A2135
4	111643	knob	PCPG350/700, PCPE350/700	04483
5	540934	drain tap		04729



Item	Order	Description	Model	OEM
1	540935	inlet tap	HCP/_ (until '90)	56616
2	110287	knob		25260
3	540936	inlet tap		25733
4	110287	knob	HCP/_ (from '90)	25260
5	110288	cap		54367



Item	Order	Description	Model	OEM
1	540930	inlet tap	HCP/_ (from '95)	03517
2	111644	knob		59531
3	540937	drain tap		05919
4	540938	extension		0C0563
5	540939	handle		56887



Item	Order	Description	Model	OEM
1	970385	145 x 145 x 200mm (1/6R)		05806
2	970386	145 x 145 x 200mm (1/6L)	SCP/_	05807
3	970387	145 x 290 x 200mm (1/3)		05808
4	970388	290 x 290 x 200 (2/3)		25809



Item	Order	Description	Model	OEM
1	970392	150 x 275 x 180mm (1/3)		56915, 0C1340
2	970393	150 x 275 x 180mm (1/3)		56919
3	970394	230 x 275 x 180mm (2/3)	universal	56916, 0C01339
4	970395	480 x 275 x 180mm (1/1)		56921, 56920, 0C1341



Item	Order	Description	Model	OEM
1	970396	Ø135 x 180mm	universal	56918
2	970397	Ø170 x 180mm		56917
3	970398	165 x 105 x 125 mm	MCPE25H, PCPE720	06886
4	970399	275 x 160 x 215 mm	CCPG	0G2326

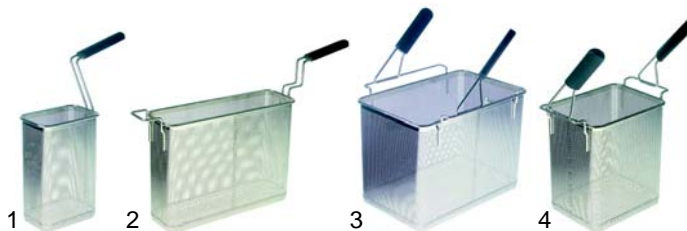

Item	Order	Description	Model	OEM
1	970400	105 x 155 x 265 mm	MCP/_1S,	04872
2	970401	105 x 350 x 265 mm	MCP/_2D,	04873
3	970402	220 x 350 x 265 mm	PCP_350,	04874
4	970403	220 x 170 x 265 mm	PCP_700	04875

Bains-marie (gas)



Item	Order	Description	Model	OEM
1	104291	burner	SMG350, SMG700	04971
2	104587	burner	RM/G700, RMV/G700, MM/G70_	50919
3	104588	burner	MM/G35_ , RM/G300, RMV/G300	58749, 50918

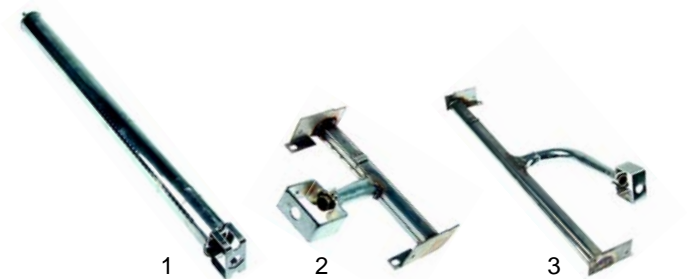

Item	Order	Description	Model	OEM
1	104589	burner	MBV/G2, PMGV700	A5447
2	104590	burner	HMS/G400	51974
3	104591	burner	HM_/G800	51975

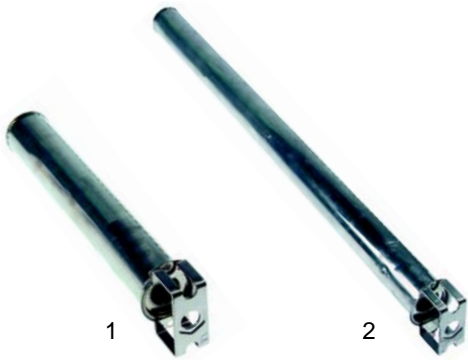

Item	Order	Description	Model	OEM
1	104592	burner	HM/G400, NMG400	59799
2	104593	burner	HM/G800, NMG800	59809



Item	Order	Description	Model	OEM
1	100046	pilot burner FG		50764
1	100106	pilot burner EG	RM/G_	58329
2	100706	electrode	RMV/G_	56754
3	102041	thermocouple, 600mm	MM/G_	25031

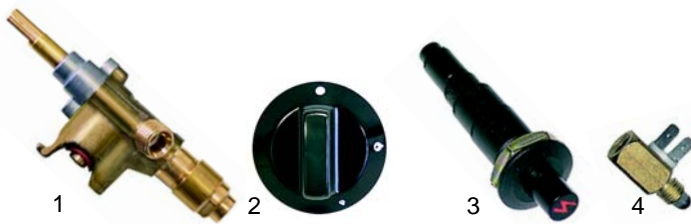

Item	Order	Description	Model	OEM
1	101396	gas tap		04956
2	110710	knob		04957
3	100009	piezoelectric igniter	SMG350,	04944
4	101264	interrupter , M8 x 1	SMG700	04982



Item	Order	Description	Model	OEM
1	n.l.a.	gas thermostat		04536
2	111645	knob	MBV/G2,	04871
3	100012	piezoelectric igniter	PMGV700	02605
4	101339	covering hood		02816



Item	Order	Description	Model	OEM
1	100855	pilot burner holder		05618
2	100706	electrode		56754
3	102121	thermocouple, 600mm	SMG350,	04955
4	375250	safety thermostat	SMG700	04931



Item	Order	Description	Model	OEM
1	n.l.a.	gas thermostat		59802
2	110286	knob	HM/G400,	59801
3	100012	piezoelectric igniter	HM/G800	02605
4	101339	covering hood		02816



Item	Order	Description	Model	OEM
1	101104	Babysit control switch	HM_/G_	53465
2	100007	piezoelectric igniter	RM/G_	52539
3	100012	piezoelectric igniter	RMV/G_	02605
4	101339	covering hood	MM/G_	02816

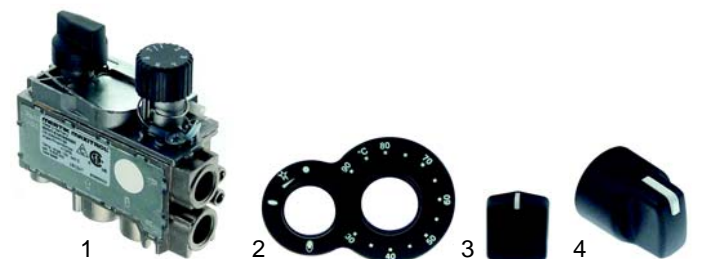

Item	Order	Description	Model	OEM
1	101966	gas regulator		0C0444
2	111650	panel	NMG400,	0C0503
3	111614	knob	NMG800	0C0189
4	111615	knob		0C0190

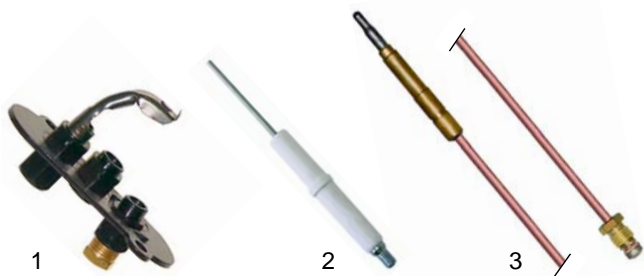

Item	Order	Description	Model	OEM
1	100050	pilot burner	MBV/G2,	59379
2	100701	electrode	PMGV700,	59380
3	102038	thermocouple, 1500mm	HM/G_, NMG_	51119

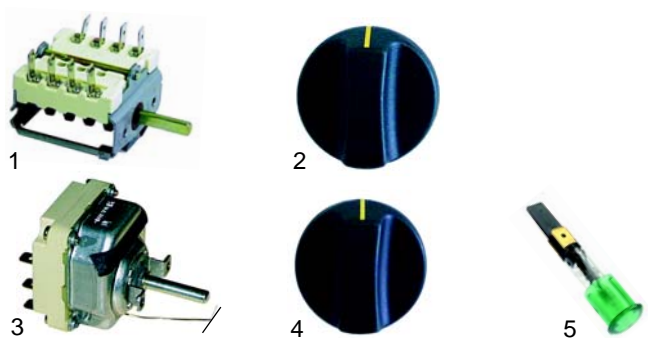

Item	Order	Description	Model	OEM
1	300017	switch, 0 - I		A2241
2	111651	knob	MB/E2,	04566
3	375092	thermostat, 90 C	MBV/E2,	52000
4	111652	knob	PMEV700	04565
5	359364	signal lamp		05010

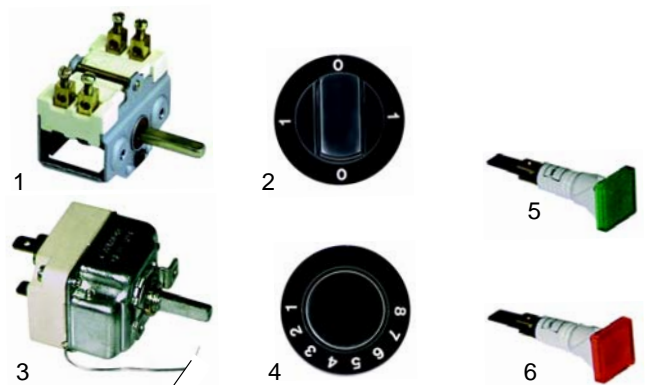

Item	Order	Description	Model	OEM
1	300020	switch, 0 - I		28390
2	110043	knob		50341
3	390040	thermostat, 90 C	HMS/400	51920
4	110046	knob		26915
5	359151	signal lamp/green		53148
6	359152	signal lamp/yellow		53149

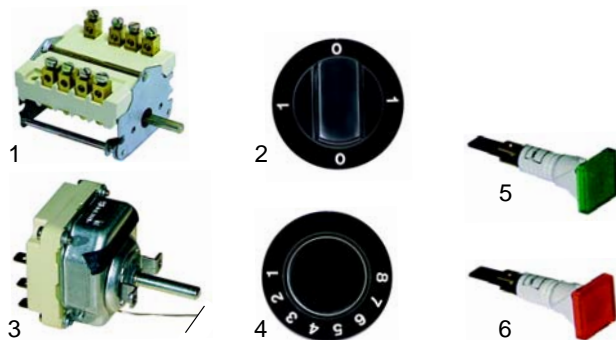

Item	Order	Description	Model	OEM
1	300102	switch, 0 - I		50857
2	110043	knob		50341
3	375092	thermostat, 90 C	HMS/800,	50200
4	110046	knob	HMA/800	26915
5	359151	signal lamp/green		53148
6	359152	signal lamp/yellow		53149

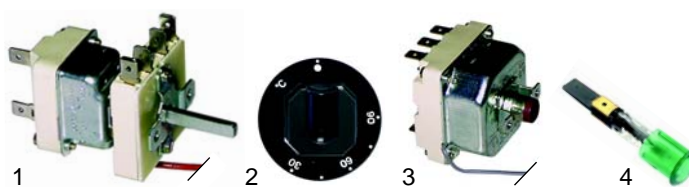

Item	Order	Description	Model	OEM
1	390039	thermostat with switch		51142
2	110467	knob	HM/E400	59491
3	390165	safety thermostat		51644
4	359364	signal lamp		58658

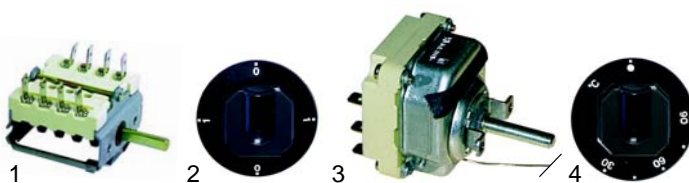

Item	Order	Description	Model	OEM
1	300017	switch, 0 - I		A2241
2	110449	knob	HM/800	59333
3	375092	thermostat, 90 C		52000
4	110467	knob		02386

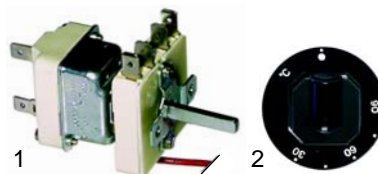

Item	Order	Description	Model	OEM
1	390039	thermostat with switch	CMABE400	51142
2	110467	knob		02386

Z

Suitable for Zanussi

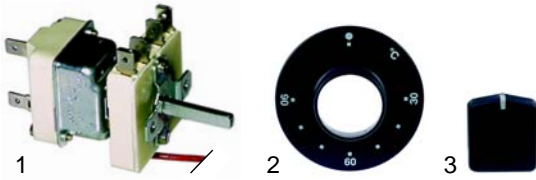

Item	Order	Description	Model	OEM
1	390039	thermostat, 90 C, with switch	NME400	51142
2	111653	panel		0C0515
3	111602	knob		0C0257

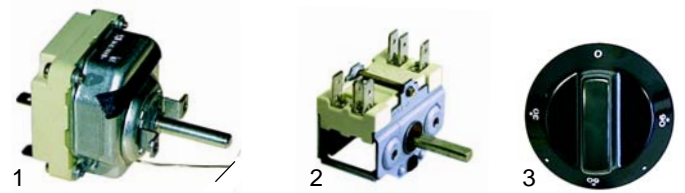

Item	Order	Description	Model	OEM
1	375143	thermostat, 110 C	SME350, SME700	04911
2	300001	switch		04908
3	110712	knob		04909

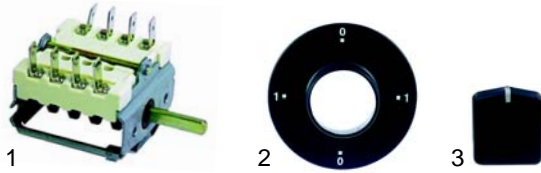

Item	Order	Description	Model	OEM
1	300017	switch, 0 - I	NME800	A2241
2	111654	panel		0C0518
3	111602	knob		0C0257

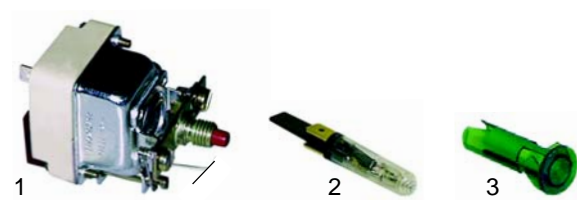

Item	Order	Description	Model	OEM
1	375250	safety thermostat	SME350, SME700	04912
2	359132	signal element		04895
3	359123	insert lamp holder		04896

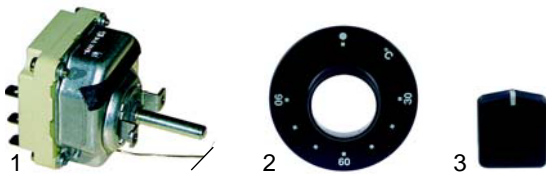

Item	Order	Description	Model	OEM
1	375092	thermostat, 90 C	NME800	52000
2	111653	panel		0C0515
3	111602	knob		0C0257

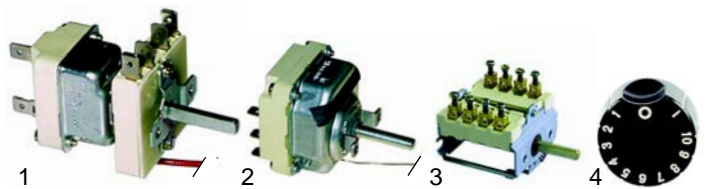

Item	Order	Description	Model	OEM
1	390039	thermostat, 90 C, with switch	RM/E300, RMV/E300	51142
2	375092	thermostat, 90 C	RM/E700, RMV/E700, RMA/E700	52000
3	300080	switch		26945
4	111629	knob		26801

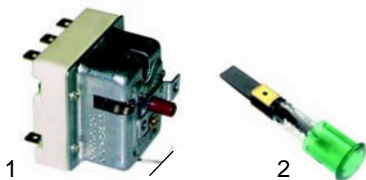

Item	Order	Description	Model	OEM
1	375209	safety thermostat	NME400, NME800	04862
2	359364	signal lamp		05010



Item	Order	Description	Model	OEM
1	359109	signal element/green	RM/E300, RM/E700, RMV/E300, RMA/E700	54150
1	359110	signal element/yellow		53811
2	359803	lens/green		54151
3	359804	lens/yellow		53812

Bains-marie (electric)

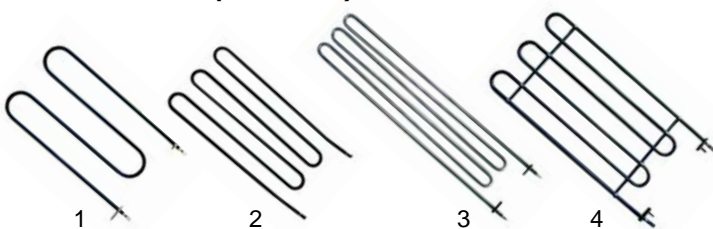

Item	Order	Description	Model	OEM
1	415293	1300W/230V	SME350, SME700	04910
2	415353	1500W/230V	RM/E_, RM_/E, NM/E_, MB/E_, MBV/E_, PMEV700	50933, 50934
3	415074	2300W/230V	HMS/E_, HM/E_, NME/E	51998, 51999
4	415596	1500W/230V	CMAE400	0G2290

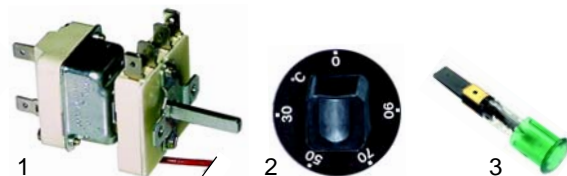

Item	Order	Description	Model	OEM
1	390039	thermostat, 90 C, with switch	MM/E350	51142
2	110344	knob		58651
3	359364	signal lamp		58658

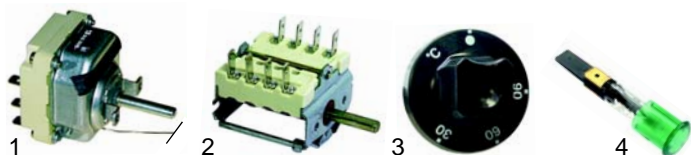

Item	Order	Description	Model	OEM
1	375092	thermostat, 90 C	MM/E700	52000
2	300002	switch		A2134
3	110345	knob		02546
4	359364	signal lamp		58658

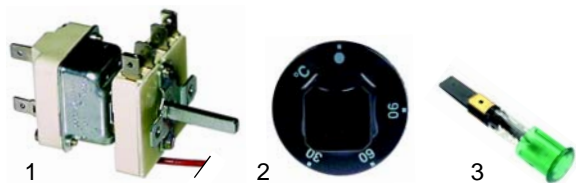

Item	Order	Description	Model	OEM
1	390039	thermostat, 90 C, with switch	MB/E1, PME350	51142
2	111652	knob		04565
3	359364	signal lamp/green		05010

Bains-marie (mechanical)



Item	Order	Description	Model	OEM
1	540259	drain tap	SMG_, SME_	05667
2	514027	lever		04906
3	110704	handle		04903
4	514006	drain pipe		05411

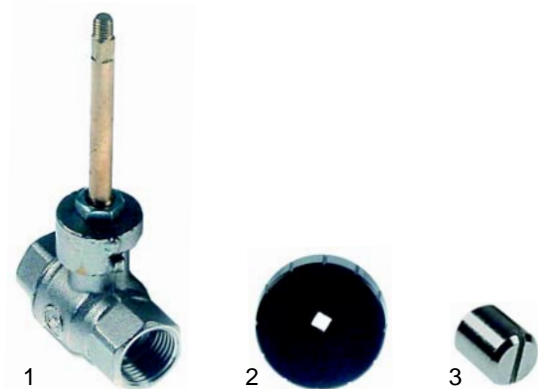

Item	Order	Description	Model	OEM
1	540962	drain tap	RM/_ , RMV/_	53466
2	111655	knob		50908
3	514253	nut		51048



Item	Order	Description	Model	OEM
1	540963	drain elbow	MM/_ , MB/E_ , MBV/G2,	58654
2	540964	drain tap	MBV/E2, PMGV/700,	58647
3	540965	drain pipe	PMEV700	02457



Item	Order	Description	Model	OEM
1	540931	inlet tap	MBV/G2, MBV/E2, PMGV700, PMEV700	56843
2	540932	adapter		A2563
3	540933	extension		A2135
4	111643	knob		04483
5	540966	inlet pipe		04537



Item	Order	Description	Model	OEM
1	540967	drain plug	HMS/E_ , HMS/G_	50301
2	517087	O-ring		50292
3	540968	drain seating		50288
4	514251	gasket		50295
5	514252	nut		50287



Item	Order	Description	Model	OEM
1	540773	inlet tap		25733
2	110287	knob		25260
3	110288	cap		54367

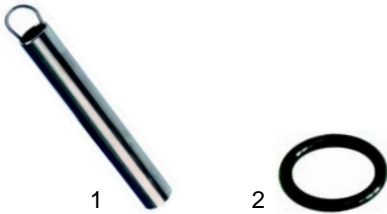

Item	Order	Description	Model	OEM
1	540969	drain plug	HM/G_, HM/E_, NMG_, NME_	A5181
2	508204	gasket		A5182



Item	Order	Description	Model	OEM
1	540970	drain tap		0G2292, 33143
2	540971	inlet tap	CMAE400	03516
3	111644	knob		59531
4	540966	inlet pipe		04537

Chip scuttles (electric)



Item	Order	Description	Model	OEM
1	415103	650W/230V	SCCE350	04898
2	550541	fitting	MCC/350, MW/E1, PCCE350	02843

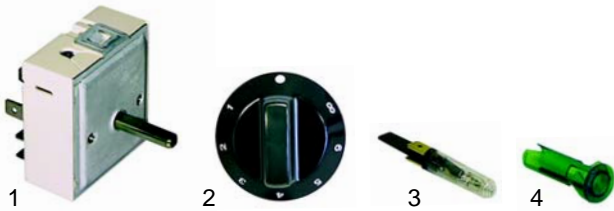

Item	Order	Description	Model	OEM
1	380015	energy regulator		05270
2	110708	knob	SCCE/350	04897
3	359132	signal element		04895
4	359123	insert lamp holder		04896

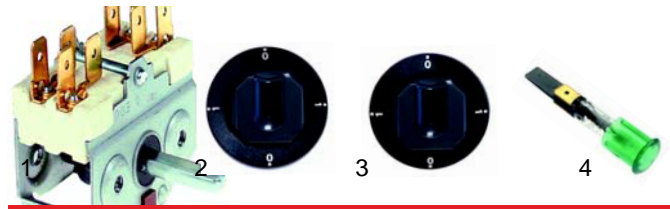

Item	Order	Description	Model	OEM
1	300074	switch	MCC/E350, MW/E1, PCCE350	A2162
2	110315	knob	MCC/E350	58629
3	110449	knob	MW/E1, PCCE350	59333
4	359364	signal lamp/green		58658

Fryers (gas)



Item	Order	Description	Model	OEM
1	104293	burner	SFRG (7 l)	04945
2	105642	burner	RF/G300 (7 L), MFR/G360 (7 L)	26864
3	105643	burner	MFR/G38 (7 L), MF/G_ (7 L), PFRG_ (7 L), MFR/G_ (7 L), CFRG_ (7 L)	03326
4	105644	burner	MFR/G_14 (15 L), PFRG (15 L)	05929

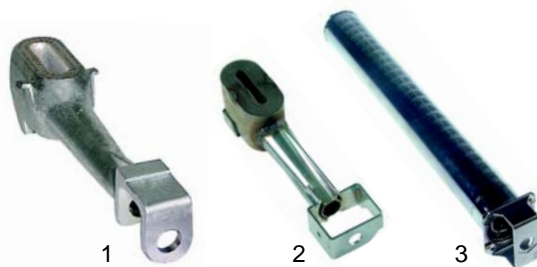

Item	Order	Descr.	Model	OEM
1	104228	burner	MFR/G350, MFR/G700, HFR/G_ (1st generation)	52289
2	105071	burner	MFR/G_ (15 L), MFR/G7_ (15 L/40 L), MFR/G_12 (12 L), MFRG_40 (40 L), PFRG740 (40 L), HFR/G (2.Gen.)	59297
3	105645	burner	HFR/G_ , HFRS/G_ , HFR/G430, HFR/G830	06127



Item	Order	Description	Model	OEM
1	101188	Eurosit controller		04947
2	101711	adapter		04948, 58773
3	110714	knob	SFRG350, SFRG700	05672
4	100009	piezoelectric igniter		04944



Item	Order	Description	Model	OEM
1	100046	pilot burner		04946
2	100706	electrode	SFRG350,	56754
3	102041	thermocouple, 600mm	SFRG700	04942
4	101265	interrupter, M9x1		05687
5	390060	safety thermostat		04951



Item	Order	Description	Model	OEM
1	375586	safety thermostat	RF/G300, MFR/G360	56435
2	101265	interrupter, M9x1	RF/G300	
3	102040	thermocouple, 500mm		25204

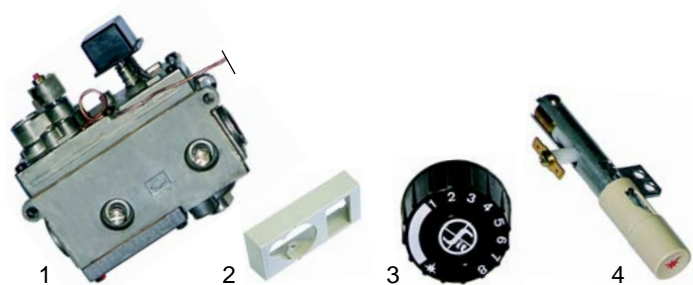

Item	Order	Description	Model	OEM
1	101131	Minisit controller		56434, 56688
2	101137	cover	RF/G300, MFR/G360	56577
3	110068	knob		54268
4	100007	piezoelectric igniter	RF/G300	52539

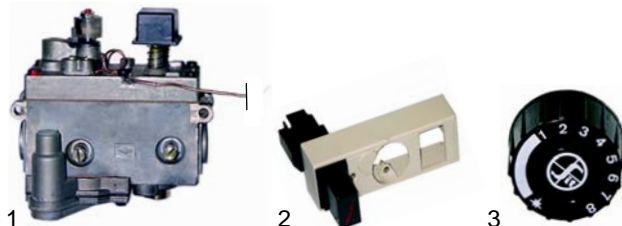

Item	Order	Description	Model	OEM
1	101437	Minisit controller		52952, 52685, 52689
2	101136	piezoelectric igniter and cover	RFR/G300 RFR/G700	54269
3	110068	knob		54268



Item	Order	Description	Model	OEM
1	101183	composite valve	RFR/G301, RFR/G701,	53973
2	101001	ignition unit, 1 output	MFR/G350, MFR/G700,	53647
2	101002	ignition unit, 2 outputs	PFRG350/700	51884



Item	Order	Description	Model	OEM
1	100012	piezoelectric igniter	MFR/G360	02605
2	101339	covering hood		02816
3	100046	pilot burner FG	RF/G300	50813
3	100106	pilot burner EG	MFR/G360	58329
4	102250	thermocouple, 1000mm		56914



Item	Order	Description	Model	OEM
1	345161	switch	RFR/G301, RFR/G701,	54518
2	345038	push button	MFR/G350, MFR/G700,	53978
3	345039	hood	PFRG350/700	53979



Item	Order	Description	Model	OEM
1	390053	thermostat		50412
2	111629	knob	RFR/G301,	26801
3	359110	signal element	RFR/G701	53811
4	359804	lens		53812

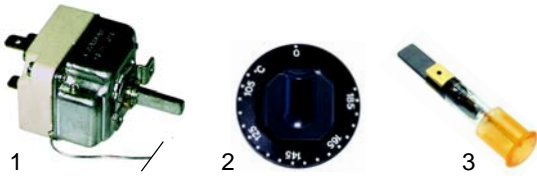

Item	Order	Description	Model	OEM
1	390053	thermostat	MFR/G350,	50412
2	110314	knob	MFR/G700,	58591
3	359365	signal lamp	PFRG350/700	58659



Item	Order	Description	Model	OEM
1	100836	upper part	MFR/G350, MFR/G700, MFR/G351, MFR/G701	52280
2	102662	upper part	MFR/G380, MFR/G381, PFRG381/731, CFRG40M/80M	03328
3	100855	holder	MFR/G380, MFR/G381, MFR/G350, MFR/G351, MFR/G700, MFRG701,	52246+52256
4	100883	lower part		52686
5	100706	electrode	PFRG350/381/700/731, CFRG40M/80M	59380

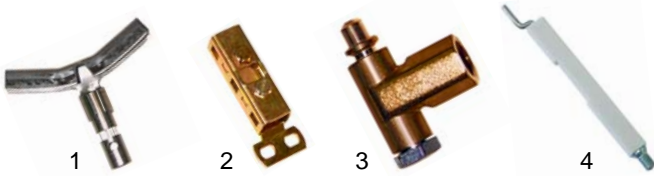

Item	Order	Description	Model	OEM
1	100836	upper part	RFR/G300, RFR/G700, RFR/G301,	52280
2	100855	holder		52246+52256
3	100882	lower part 0,25	RFR/G701,	52281
3	100833	lower part 0,35	MFR/G350, MFR/G700,	52686
4	100708	electrode	PFRG350/700	52610

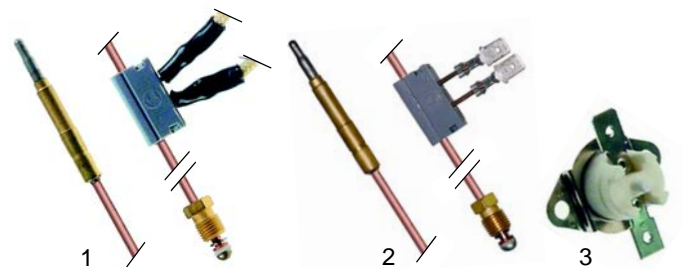

Item	Order	Description	Model	OEM
1	102250	thermocouple with interrupter	MFR/G380, MFR/G381, PFRG381/731	56914
2	102070	thermocouple with interrupter	MFR/G350, MFR/G351, MFR/G700, MFRG701, PFRG350/700, CFRG40M/80M	54055
3	390509	safety thermostat	MFR/G__, PFRG__, CFRG__	03329

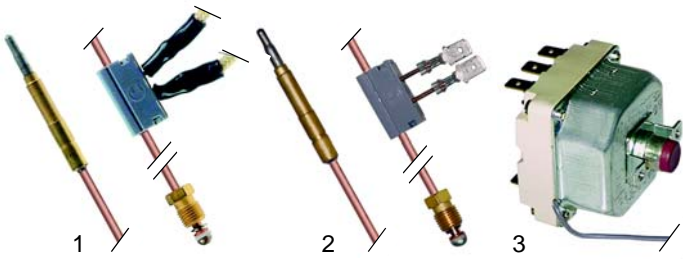

Item	Order	Description	Model	OEM
1	102250	thermocouple with interrupter	RFR/G300, RFR/G700	56914 51932
2	102070	thermocouple with interrupter	RFR/G301, RFR/G701, MFR/G350, MFR/G700, PFRG350/700	54055
3	375108	safety thermostat	RFR/G __, MFR/G350, MFR/G700, PFRG350/700	52331



Item	Order	Description	Model	OEM
1	101187	Novasit gas valve (mV)		02606
2	101800	extension	MFR/G740	02604
3	111656	knob	PFRG740	02603
4	100012	piezoelectric igniter		02605
5	101339	covering hood		02816



Item	Order	Description	Model	OEM
1	101188	Eurosit controller	MFR/G380, MFR/G381, MFR/G350, MFR/G351, MFR/G700, MFRG701, PFRG350/381/700/731, CFRG40M/80M	03334
2	110358	adapter		03391
3	110282	knob		03392
4	100012	piezoelectric igniter		02605
5	101339	covering hood		02816

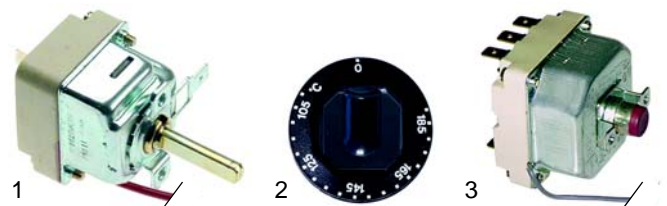

Item	Order	Description	Model	OEM
1	375583	thermostat		02602
2	110314	knob	MFR/G740 PFRG740	58591
3	375108	safety thermostat		52331

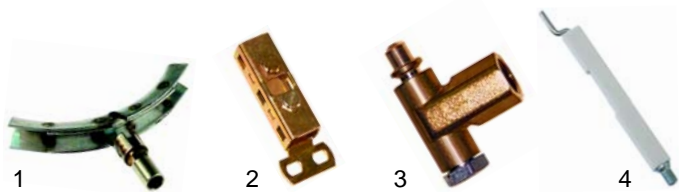

Item	Order	Description	Model	OEM
1	102816	upper part		03394
2	100855	holder	MFR/G740 PFRG740	52246+52256
3	100883	lower part		52686
4	100708	electrode		52610

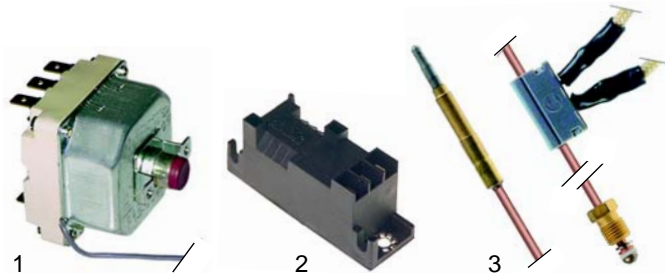

Item	Order	Description	Model	OEM
1	375108	safety thermostat		52331
2	101002	ignition unit	HFR/G420/421/840, HFR/G420D/840D	53647, 51884
3	102250	thermocouple		51632, 56914

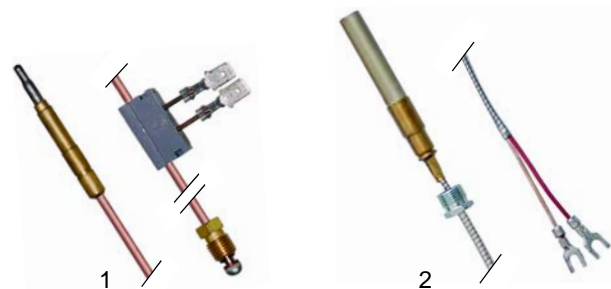

Item	Order	Description	Model	OEM
1	102070	thermocouple	MFR/G740	54055
2	102116	pilot generator	PFRG740	02607

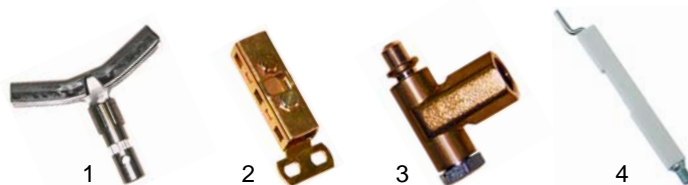

Item	Order	Description	Model	OEM
1	100836	upper part		52280
2	100855	holder	HFR/G420 HFR/G421	52246+52256
3	100882	lower part 0,25	HFR/G840	52281
3	100883	lower part 0,35	HFR/G420D HFR/G840D	52686
4	100708	electrode		52610

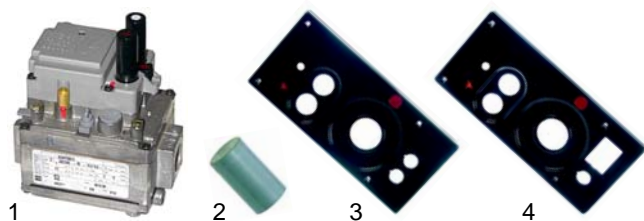

Item	Order	Description	Model	OEM
1	101127	Elettrosit gas valve	HFR/G420/421/840, HFR/G420D/840D	57543
2	101309	extension		51281
3	111657	panel	HFR/G420/421/840	52272
4	111658	panel	HFR/G420D7=/40D	53105

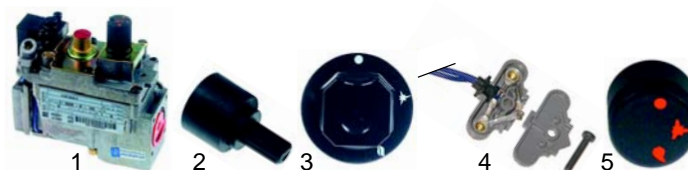

Sit 820031

Item	Order	Description	Model	OEM
1	101956	Novasit gas valve	HFR/G410-412, HFR/G810, HFR/G410D	02903
2	101928	adapter	HFR/G410D	59305
3	111534	knob	HFR/G810D	59304
4	101312	micro switch	HFH/G430, HFH/G435 NFRG430/435/440	54539
5	111646	knob		03704



Item	Order	Description	Model	OEM
1	359151	signal lamp	HFR/G__	53148, 53154
2	359152	signal lamp	HFR/G420/421/840	53149, 53155
3	345983	switch	HFR/G__D	53810

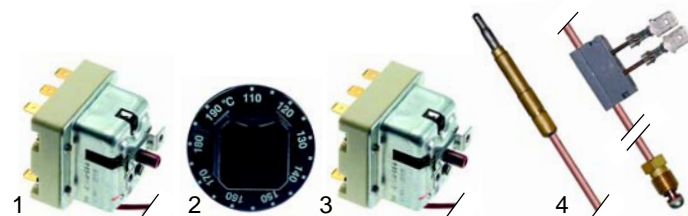

Item	Order	Description	Model	OEM
1	101979	gas regulator		06574
2	111660	knob	HFR/G430 HFR/G830	06570
3	375585	safety thermostat	HFHS/G430	06282
4	102070	thermocouple		54055

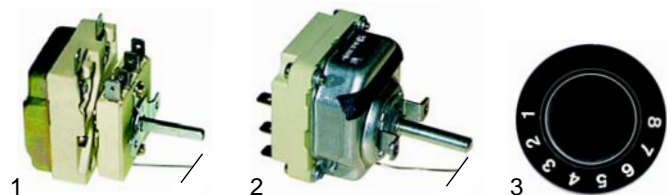

Item	Order	Description	Model	OEM
1	390049	thermostat	HFR/G__	52330
2	390056	thermostat	HFR/G__D	51361
3	110046	knob		26915



Item	Order	Description	Model	OEM
1	101982	gas regulator		0C0624
2	111661	panel	NFRG400/800	0C0623
3	111614	knob	NFRG420/820	0C0189
4	111615	knob		0C0190

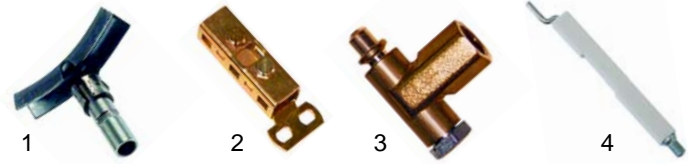

Item	Order	Description	Model	OEM
1	102664	upper part		59301
2	100855	holder	HFR/G410-412	52246+52256
3	100883	lower part 0,35	HFR/G410D	25686
4	100708	electrode	HFR/G810D	52610



Item	Order	Description	Model	OEM
1	375585	safety thermostat	NFRG400/800	06282
2	102070	thermocouple	NFRG420/820	54055



Item	Order	Description	Model	OEM
1	379567	electronic thermostat		06154
2	379924	sensor	HFH/G430	06155
3	380380	time relay		06156

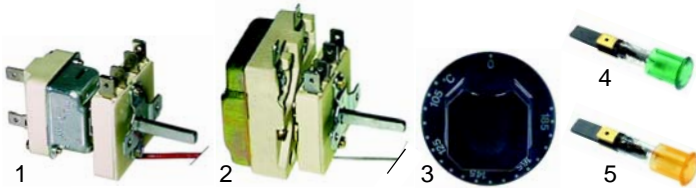

Item	Order	Description	Model	OEM
1	375584	thermostat	HFR/G410-412, HFR/G810	03049
2	390049	thermostat	HFR/G410D, HFR/G810D	52330
3	111659	knob	HFR/G410-412,	59303
4	359364	signal lamp/green	HFR/G810,	05010
5	359365	signal lamp/yellow	HFR/G410D	05011

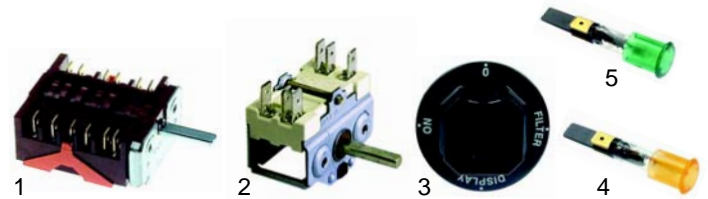

Item	Order	Description	Model	OEM
1	301216	switch		59544
2	300001	switch	HFH/G430	A2036
3	111662	knob		06144
4	359364	signal lamp/green		05010
5	359365	signal lamp/yellow		05011

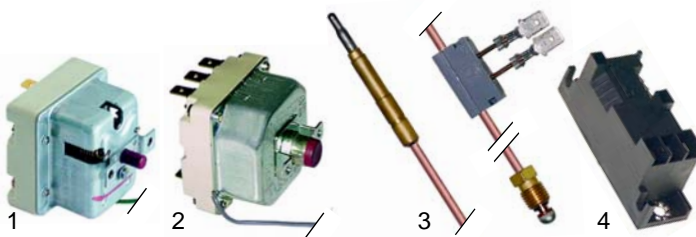

Item	Order	Description	Model	OEM
1	375586	safety thermostat	HFR/G410-412, HFR/G810	A5435
2	375108	safety thermostat	HFR/G410D, HFR/G810D	52331
3	102070	thermocouple	HFR/G410-412, HFR/G810	54055
4	101002	ignition unit	HFR/G410D,	033076
			HFR/G810D	51884

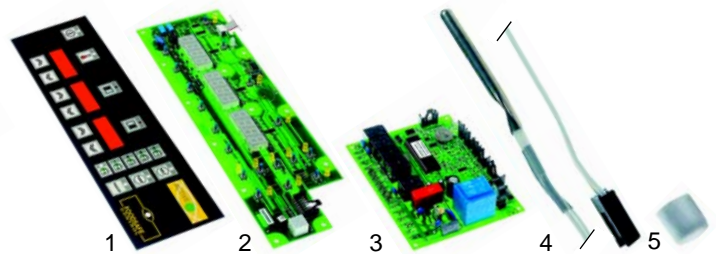

Item	Order	Description	Model	OEM
1	400994	fascia		06608
2	400741	control p.c.b.		06644
3	400996	main p.c.b.	HFH/G435	06624
4	379918	sensor		06609
5	400997	button		02670

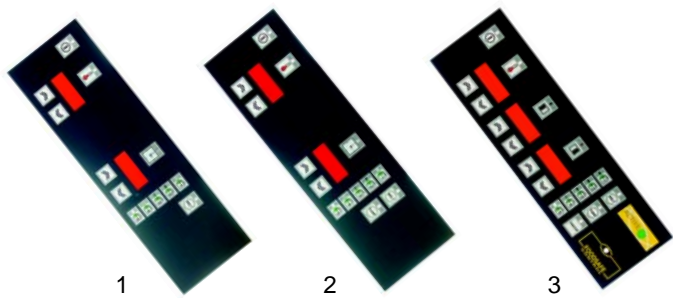

Item	Order	Description	Model	OEM
1	400998	fascia	NFRG430	0C1015
2	400999	fascia	NFRG435	0C1016
3	400994	fascia	NFRG440	06608

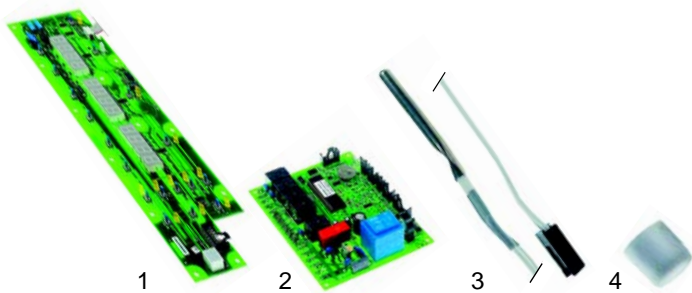

Item	Order	Description	Model	OEM
1	400741	control p.c.b.		06803
2	400996	main p.c.b.	NFRG430	06624
3	379918	sensor	NFRG435	06609
4	400997	button	NFRG440	02670

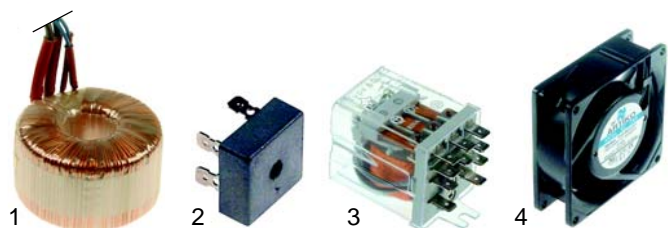

Item	Order	Description	Model	OEM
1	379395	transformer	HFH/G430	06159
2	379396	rectifier	HFH/G435	06147
3	380636	relay	NFRG430	56510
4	601130	fan	NFRG435	06125

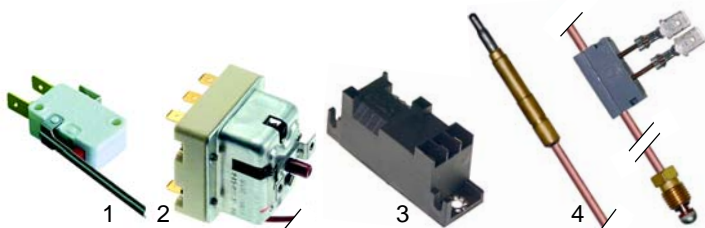

Item	Order	Description	Model	OEM
1	345254	micro switch	HFH/G430	53671
2	375585	safety thermostat	HFH/G435	06282
3	101002	ignition unit	NFRG430	04240
4	102070	thermocouple	NFRG435	54055

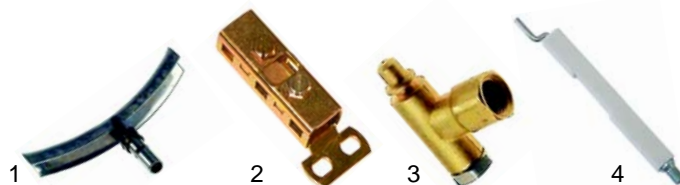

Item	Order	Description	Model	OEM
1	102665	upper part	HFH/G430, HFH/G435	06128
2	100855	holder	HFH/G430, HFR/G830	52246+52556
3	100880	lower part	HFRS/G430	06725
4	100708	electrode	NFRG420/820	59380

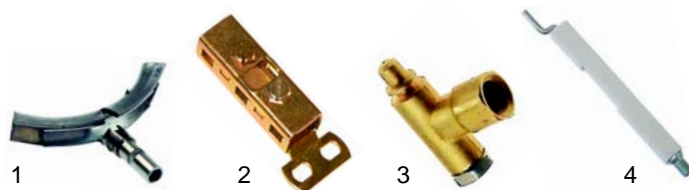

Item	Order	Description	Model	OEM
1	102663	upper part		A5441
2	100855	holder	NFRG400/800	52246+52556
3	100880	lower part		06725
4	100708	electrode		59380

Fryers (electric)



Item	Order	Description	Model	OEM
1	415291	2000 W/230 V	SFRE350/700	04926
2	415354	1500 W/230 V	RFR/E302, RFR/E312, MFR/E370	54951 58612
3	415274	3000 W/230 V	RFR/E305, RFR/E701, RFR/E315, RFR/E711, MFR/E350, MFR/E700	54962 58615

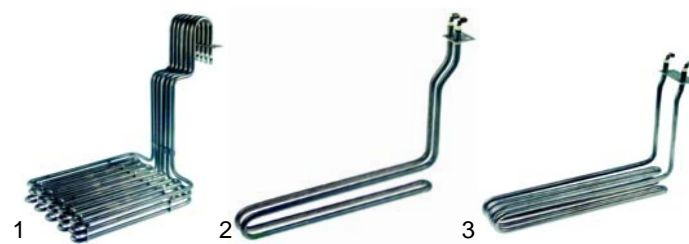

Item	Order	Description	Model	OEM
1	416992	9500 W/230 V	MFR/E305, MFR/E306, MFR/E705, MFR/E706, MFR/E740	54923
2	416993	1500 W/230 V	MF/1D05, PFRE370	04752
3	416994	2900 W/230 V	MF/E1S12, MF/E2D12, PFRE350/700	05964

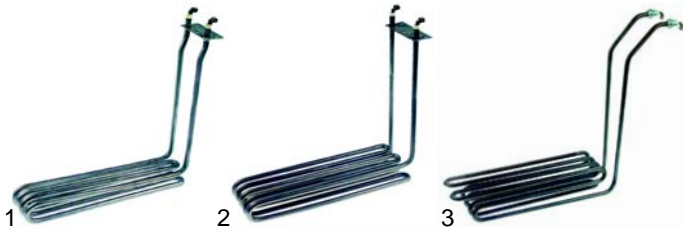

Item	Order	Description	Model	OEM
1	416995	2900W/230V	MFR/E1S12, MFR/E2D12, PRFE360/700	A5565
2	416996	2900W/230V	MFR/E2S40, PRFE740	04767
3	416997	4000W/230V	HFR/E420, HFR/E840	52326, 52327



Item	Order	Description	Model	OEM
1	416998	2700W/230V	MF/E1S08, MF/E2D08, MF/E1S07, MF/E2D07, PFRE381T/731T, MFR/E1S07, MFR/E1S08, MFR/E2D07, MFR/E2D08, PFRE381/731	04755
2	416999	5000W/230V	MFR/E1S14, MFR/E2D14, PFRE355/705, NFRE400/800	05942
3	418000	5000W/400V	HFH/E430, HFH/E435, HFR/E430, HFR/830, NFRE420/820, NFRE430/435/440	06158



Item	Order	Description	Model	OEM
1	418001	5000W/230V	HFR/E421	54650
2	415377	5500W/230V	HFR/E410-412/HFR/E418/810/818	59563
3	418002	5500W/230V	HFR/E431/831, NFRE410/810	06571

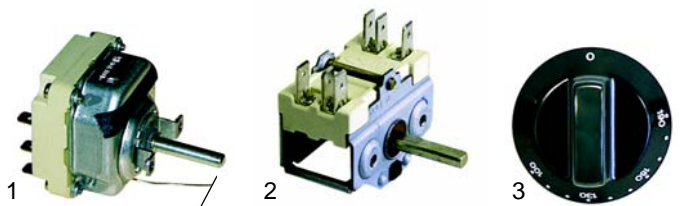

Item	Order	Description	Model	OEM
1	390056	thermostat		04925
2	300001	switch	SFRE350 SFRE700	04908
3	110715	knob		04924

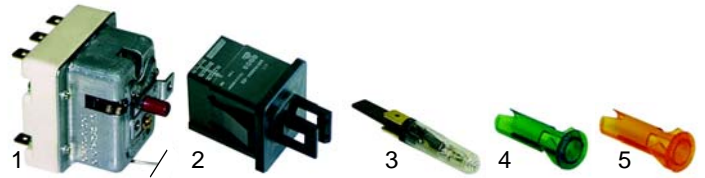

Item	Order	Description	Model	OEM
1	390113	safety thermostat		04921
2	345127	micro switch		04927
3	359132	signal element/green	SFRE350	04895
3	359130	signal element/yellow	SFRE700	-
4	359123	insert lamp holder/green		04896
5	359124	insert lamp holder/yellow		04928

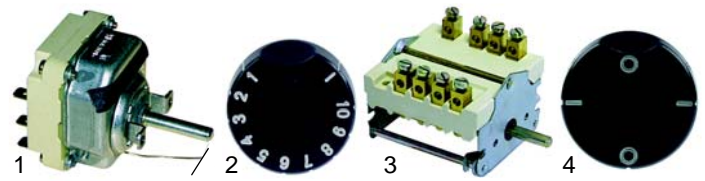

Item	Order	Description	Model	OEM
1	390056	thermostat		51361
2	111617	knob	RFR/E302, RFR/E305, RFR/E701, RFR/E312, RFR/E315, RFR/E711	53867
3	300102	switch		50857
4	111638	knob		26797

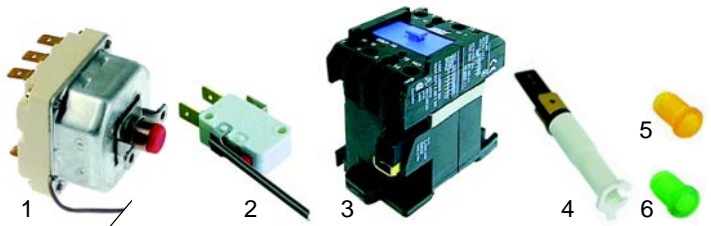

Item	Order	Description	Model	OEM
1	375641	safety thermostat		54932
2	345254	micro switch		53671
3	380204	contactor	RFR/E302, RFR/E305, RFR/E701, RFR/E312, RFR/E315, RFR/E711	75796
4	359110	signal element/yellow		53811
4	359109	signal element/green		54150
5	359804	lens/yellow		53812
6	359803	lens/green		54151

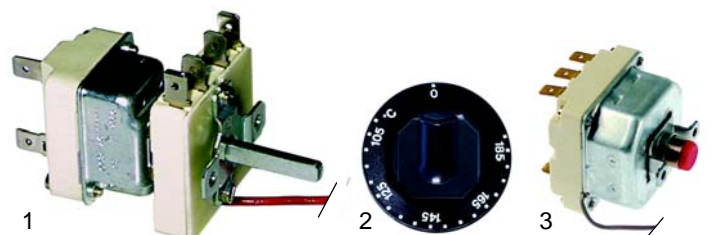

Item	Order	Description	Model	OEM
1	390052	thermostat	MFR/E350, MFR/E370, MFR/E700	52330
2	110314	knob		58591
3	375641	safety thermostat		54932

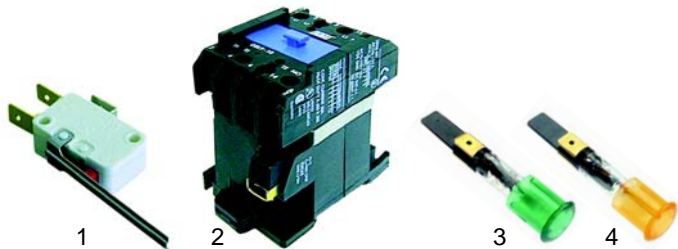

Item	Order	Description	Model	OEM
1	345254	micro switch		53671
2	380204	contactor	MFR/E350, MFR/E370,	75796
3	359364	signal lamp/green	MFR/E700	58658
4	359365	signal lamp/yellow		58659



Item	Order	Description	Model	OEM
1	390052	thermostat		52330
2	111664	knob	MF/E1D05, MF/E1S12, MF/E2D12, MFR/E1S12,	04783
3	111659	knob	MFR/E2D12, MFR/E2S40, PFRE370/350/700/360/710/740	59303
4	375578	safety thermostat		04472

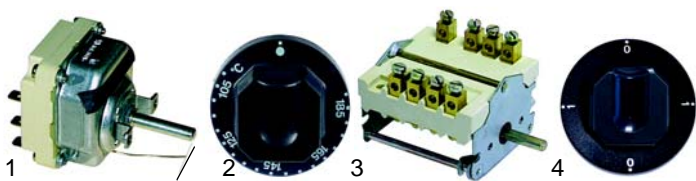

Item	Order	Description	Model	OEM
1	390056	thermostat		51361
2	111663	knob	MFR/E355, MFR/E705	59196
3	300102	switch		50857
4	110315	knob		58629

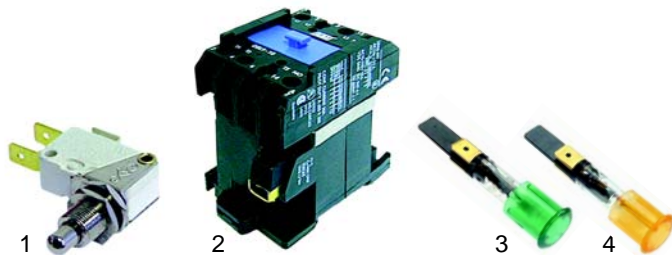

Item	Order	Description	Model	OEM
1	345032	micro switch	MF/E1D05, MF/E1S12, MF/E2D12, MFR/E1S12,	02785
2	380204	contactor	MFR/E2D12, MFR/E2S40,	82986
3	359364	signal lamp/green	PFRE370/350/700/360/710/740	05010
4	359365	signal lamp/yellow		05011

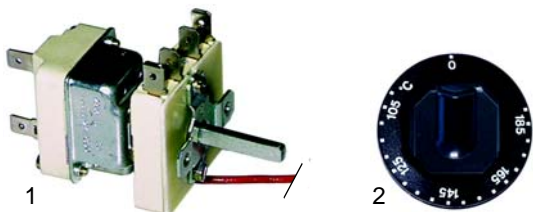

Item	Order	Description	Model	OEM
1	390052	thermostat	MFR/E740	52330
2	110314	knob		58591

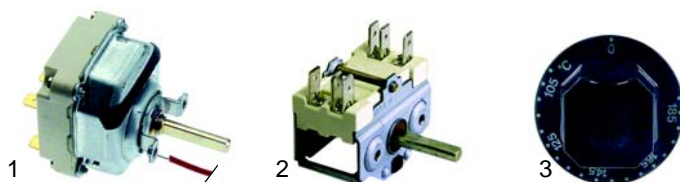

Item	Order	Description	Model	OEM
1	375576	thermostat	MF/E1S07, MF/E2D07, MFR/E1S07, MFR/E2D07	05940
2	300001	switch	MFR/E1S14, MFR/E2D14,	A2036
3	111659	knob	PFRE381T/731T/381/731/355/705	59303

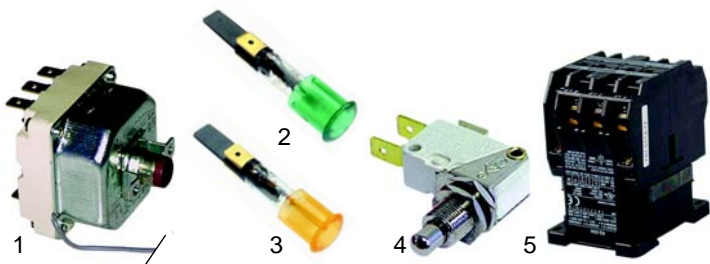

Item	Order	Description	Model	OEM
1	390087	safety thermostat	MFR/E355, MFR/E705, MFR/E740	51369
2	359364	signal lamp/green		58658
3	359365	signal lamp/yellow		58659
4	345032	micro switch		02785
5	380637	contactor		54928



Item	Order	Description	Model	OEM
1	375580	safety thermostat	MF/E1S07, MF/E2D07, MFR/E1S07, MFR/E2D07	05941
2	359364	signal lamp/green	MFR/E1S14, MFR/E2D14,	05010
3	359365	signal lamp/yellow	PFRE381T/731T/381/731/ 355/705	05011

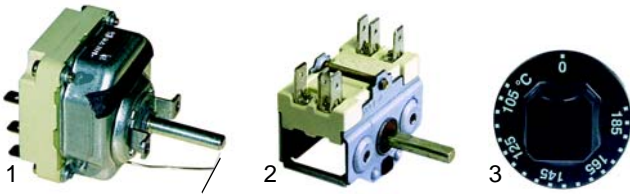

Item	Order	Description	Model	OEM
1	390056	thermostat		51361
2	300001	switch	MF/E1S08, MF/E2D08, MFR/E1S08, MFR/E2D02	A2036
3	111664	knob		04783



Item	Order	Description	Model	OEM
1	350071	timer		54504
2	345038	push button	HFR/G421	53978
3	345039	hood		53979
4	359110	signal element		53811
5	359804	lens		53812

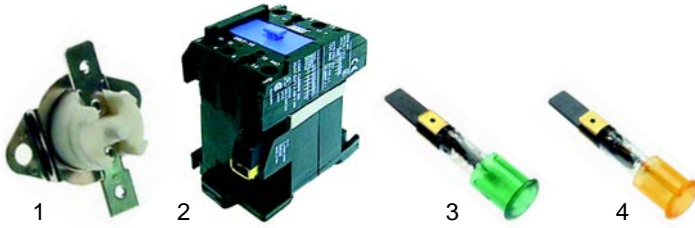

Item	Order	Description	Model	OEM
1	390509	safety thermostat		03329
2	380204	contactor	MF/E1S08, MF/E2D08, MFR/E1S08, MFR/E2D02	82986
3	359364	signal lamp/green		05010
4	359365	signal lamp/yellow		05011

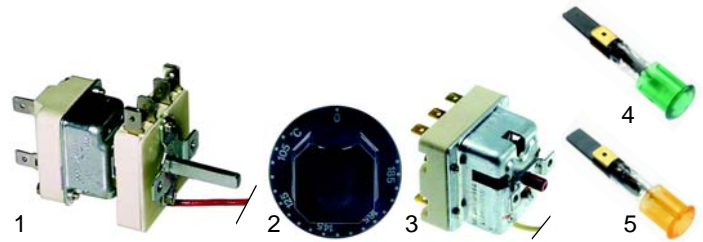

Item	Order	Description	Model	OEM
1	390052	thermostat		52330
2	111659	knob	HFR/E410-412, HFR/E810, HFR/E418, HFR/E818,	59303
3	375578	safety thermostat	HFR/E430, HFR/E830,	04472
4	359364	signal lamp/green	HFRS/E430-431,	05010
5	359365	signal lamp/yellow	HFRS/E831	05011

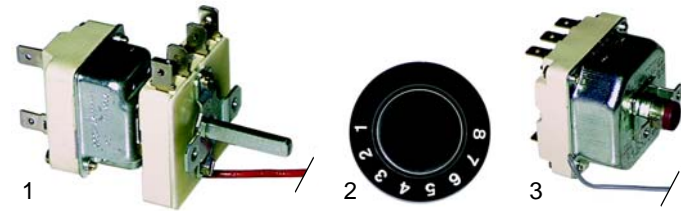

Item	Order	Description	Model	OEM
1	390052	thermostat	HFR/E420,	52330
2	110046	knob	HFR/E421, HFR/E840	26915
3	390087	safety thermostat		51369



Item	Order	Description	Model	OEM
1	345254	micro switch	HFR/E410-412, HFR/E810, HFR/E418, HFR/E818,	53671
2	380244	contactor	HFR/E410-412, HFR/E810	03598
3	380637	contactor	HFR/E418, HFR/E818, HFR/ E430, HFR/E830, HFRS/E430-431, HFRS/E831	54928
4	601130	fan	HFR/E430, HFR/E830, HFRS/E430-431, HFRS/E831	06125



Item	Order	Description	Model	OEM
1	345254	micro switch		53671
2	380637	contactor	HFR/E420, HFR/E421,	54928
3	359151	signal lamp/green	HFR/E840	53148
4	359152	signal lamp/yellow		53149

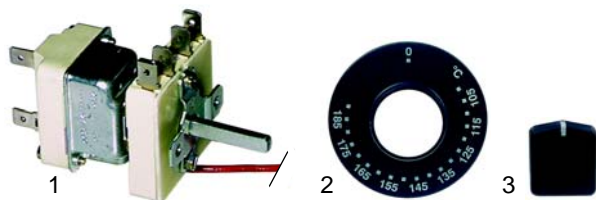

Item	Order	Description	Model	OEM
1	390052	thermostat		52330
2	111665	panel	NFRE400/410/420, NFRE800/810/820	0C0615
3	111602	knob		0C0257



Item	Order	Description	Model	OEM
1	379567	electronic thermostat		06154
2	379924	sensor	HFH/E430	06155



Item	Order	Description	Model	OEM
1	375580	safety thermostat		05941
2	359364	signal lamp/green	NFRE400/420, NFRE800/820	05010
3	359365	signal lamp/yellow		05011

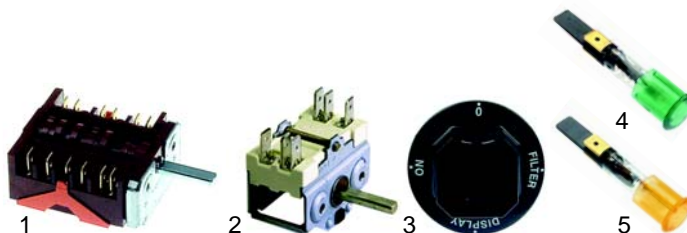

Item	Order	Description	Model	OEM
1	301216	switch		59544
2	300001	switch		A2036
3	111662	knob	HFH/E430	06144
4	359364	signal lamp/green		05010
5	359365	signal lamp/yellow		05011

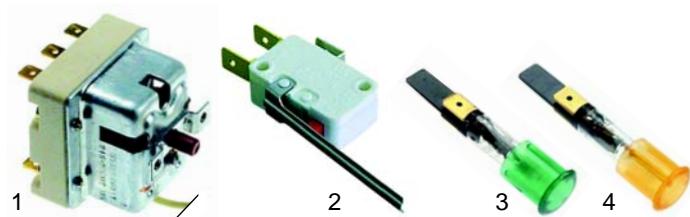

Item	Order	Description	Model	OEM
1	375578	safety thermostat		04472
2	345254	micro switch	NFRE410/810	53671
3	359364	signal lamp/green		05010
4	359365	signal lamp/yellow		05011

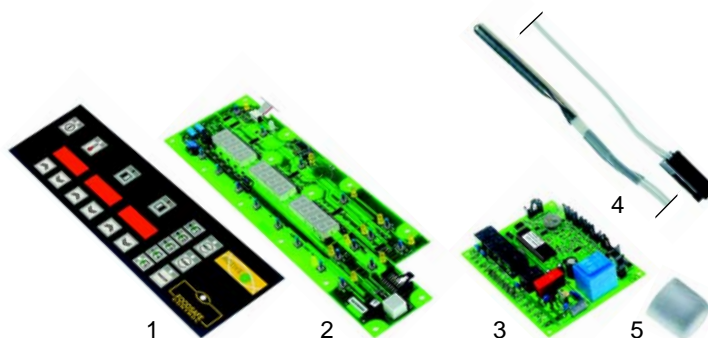

Item	Order	Description	Model	OEM
1	400994	fascia		06608
2	400741	control p.c.b.	HRFH/E435	06644
3	400996	main p.c.b.		06624
4	379918	sensor		06609
5	400997	button		02670



Item	Order	Description	Model	OEM
1	380261	contactor	NFRE400/800	06879
2	380265	contactor	NFRE420/820/410/810	07080
3	601130	fan	NFRE420/820	06125

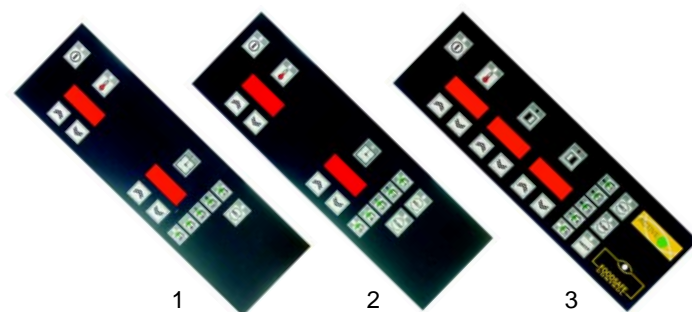

Item	Order	Description	Model	OEM
1	400998	fascia	NFRE430	0C1015
2	400999	fascia	NFRE435	0C1016
3	400994	fascia	NFRE440	06608

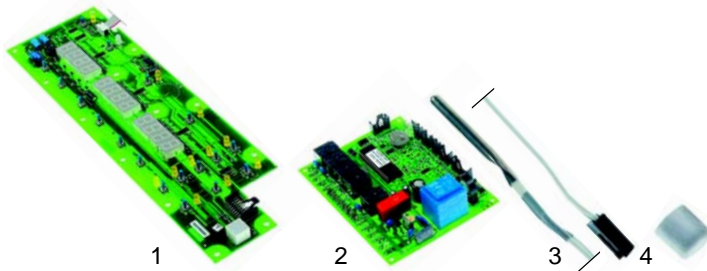

Item	Order	Description	Model	OEM
1	400741	control p.c.b.		06803
2	400996	main p.c.b.	NFRE430 NFRE435	06624
3	379918	sensor	NFRE440	06609
4	400997	push button		02670

Fryers (mechanical)



Item	Order	Description	Model	OEM
1	540259	drain tap		05667
2	514006	drain pipe	SFRG__ SFRE__	05678
3	514027	lever		-
4	110704	handle		04906

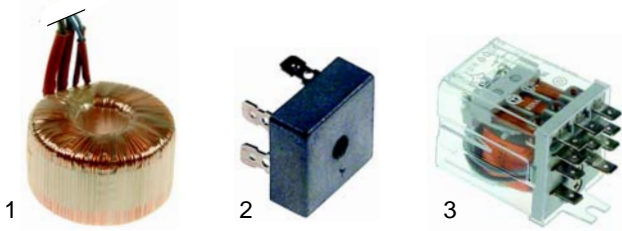

Item	Order	Description	Model	OEM
1	379395	transformer		06159
2	379396	rectifier	HFH/E430, HFH435, NFRE430/435/440	06147
3	380636	relay		56510



Item	Order	Description	Model	OEM
1	540972	drain tap	MFR/G (Stand), RFR/G (Stand), HFR/___	53108
2	n. l. a.	drain tap	RFR/E (table)	55027
3	540974	drain tap	RFR/E (Stand)	54945

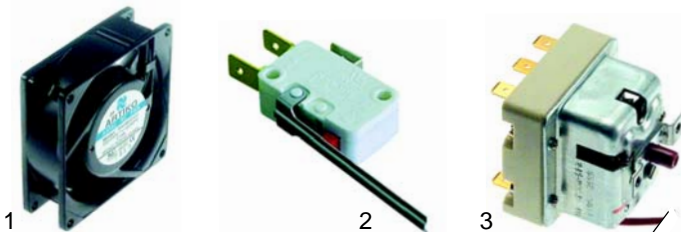

Item	Order	Description	Model	OEM
1	601130	fan		06125
2	345254	micro switch	HFH/E430, HFH435, NFRE430/435/440	53671
3	375585	safety thermostat		06282



Item	Order	Description	Model	OEM
1	540975	drain tap	MFR/__(table)	58610
2	540965	drain tube	MF/__(table) PFR/__(table)	02457
3	540976	extension	MF/__(table) PFR/__(table)	04505

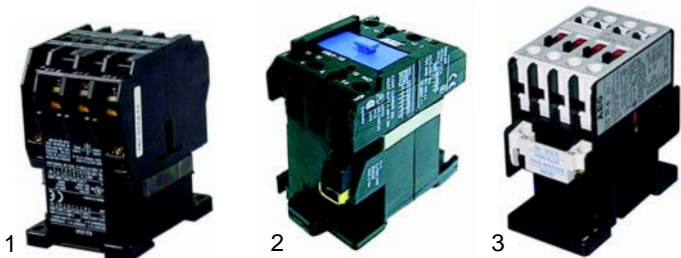

Item	Order	Description	Model	OEM
1	380637	contactor	HFH/E430	06157
2	380204	contactor	HFH/E435	82986
3	380261	contactor	NFRE430/435/440	06879



Item	Order	Description	Model	OEM
1	540977	drain tap	MFR/__(Stand)	56114
2	540978	support plate	PFR/__(Stand) HFR/G	03378
3	540979	handle		03377



Item	Order	Description	Model	OEM
1	540980	drain tap	MF/__(table), PFR/__(table)	05948
2	540981	drain tap	MFR/__(Stand), PFR/__(Stand)	04486
3	540982	drain tap	MFR/__(Stand), PFR/__(Stand)	05927



Item	Order	Description	Model	OEM
1	540983	drain tap	MFR/___S40, PFR/___740, HFRE431/831	A5439
2	540986	drain tap	HFH/___	06688
3	540678	handle		06689



Item	Order	Description	Model	OEM
1	540986	drain tap	HFR/___430, HFR/___830	06123
2	540987	handle	HFRS/___430	06142

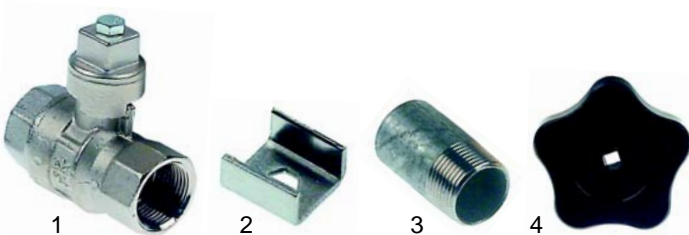

Item	Order	Description	Model	OEM
1	540977	drain tap		56114
2	540978	support plate	HFR/E410-412, HFR/E810	03378
3	540988	extension		59318
4	111666	knob		10142



Item	Order	Description	Model	OEM
1	693396	gasket	universal	57402
2	693397	glass		57400
3	693398	housing		57382



Item	Order	Description	Model	OEM
1	550138	capillary clamp	universal	52262
2	550540	sensor clamp		52946
3	550403	sensor clamp		56330
4	550402	sensor clamp		52248



Item	Order	Description	Model	OEM
1	970139	270 x 210 x 100mm	SFR/___	05704
2	970141	285 x 115 x 100mm	RFR/G (table), MFR/G (table)	26820
3	970404	260 x 270 x 160mm	PRFR/G (Stand), MFR/	52683



Item	Order	Description	Model	OEM
1	970140	320 x 100 x 120mm	RFR (5L), MFR/E (5L), MF/E (5L), PFRE370	54948
2	970143	320 x 225 x 120mm	RFR/E, MER/___ (7L)	54960
3	970404	260 x 270 x 160mm	MFR/___ (15L)	52683

Tilting bratt pans (gas)



Item	Order	Description	Model	OEM
1	970406	305 x 225 x 90mm	MF/___ (7L/8L), PFR___	04492
2	970407	260 x 270 x 120mm	MF/___ (12L), PFR___	04499
3	970408	325 x 225 x 120mm	MF/___ (15L), PFR___, NFR___	05933



Item	Order	Description	Model	OEM
1	970143	320 x 225 x 120mm	MF/E (12L - heating outer), PFRE___	54960
2	970144	340 x 160 x 160mm	MFR/___420/421/820	52290
3	970410	325 x 225 x 90mm	CFRG___	0G2206

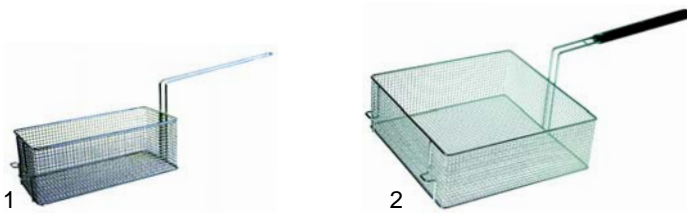

Item	Order	Description	Model	OEM
1	970145	330 x 160 x 120mm	HFR/___410-412,	59327
2	970411	340 x 335 x 120mm	HFR/___810	59307

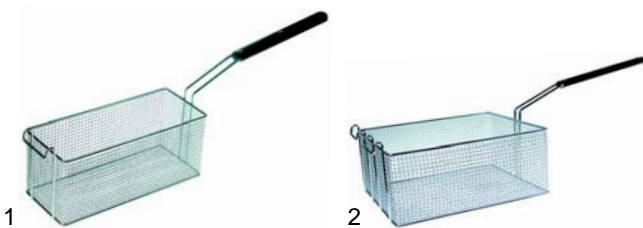

Item	Order	Description	Model	OEM
1	970412	330 x 135 x 140mm	HFH/___, HFR/___430,	06133
2	970413	330 x 285 x 140mm	HFR/___830, HFRS/___, NFR___	06539

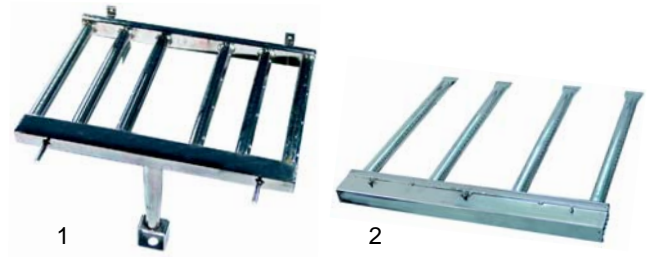

Item	Order	Description	Model	OEM
1	105646	burner	RBR/G, MBR/G	56796
2	105647	burner	MB_/G2, PBRG700/701	04353

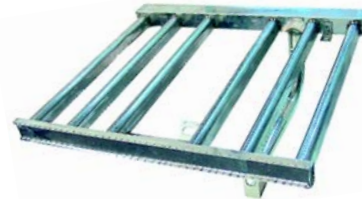

Pos.	Order	Description	Model	OEM
1	105648	burner	HBR/G803-804, HBR/G820/825	51296
2	105649	burner	HBR/G1003/1004/1013	51297



Pos.	Order	Description	Model	OEM
1	105650	burner	HBR/G800-801, HBR/G805-806	A5166
2	105651	burner	HBR/G810-811, HBR/G815-816	51624



Pos.	Order	Description	Model	OEM
1	105652	burner	NBR/G800/810	0C0700
2	105653	burner	NBR/G815/820	0C0701

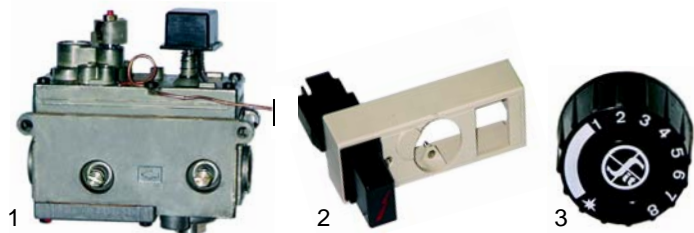

Item	Order	Description	Model	OEM
1	101132	Minisit controller		56833
2	101136	cover with piezoelectric igniter	RBR/G MBR/G	54269
3	110068	knob		54268



Item	Order	Description	Model	OEM
1	375579	safety thermostat		03594
2	100012	piezoelectric igniter	MB/_/G, PBRG700/701	02605
3	101339	hood		02816

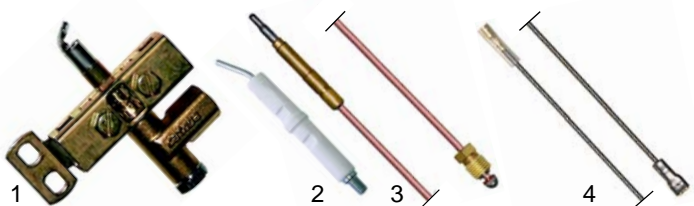

Item	Order	Description	Model	OEM
1	100044	pilot burner		27073
2	100706	electrode		56754
3	102045	thermocouple, 1500mm	RBR/G MBR/G	56840, 52814
4	100026	ignition cable, 1000mm		54273



Item	Order	Description	Model	OEM
1	10207	thermocouple		54055
2	100050	pilot burner	MB/_/G, PBRG700/701	59379
3	100701	electrode		53380

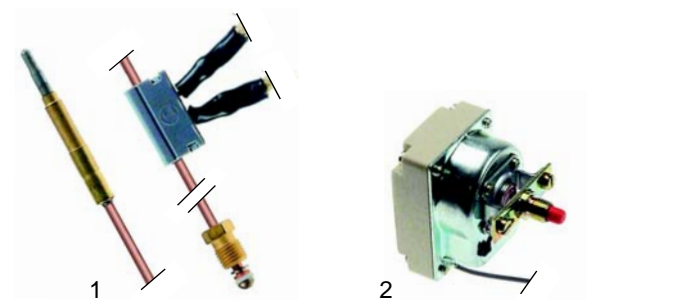

Item	Order	Description	Model	OEM
1	102250	thermocouple with interrupter	MBGR/G	56914
2	375572	safety thermostat	(from Nr.534...)	53980

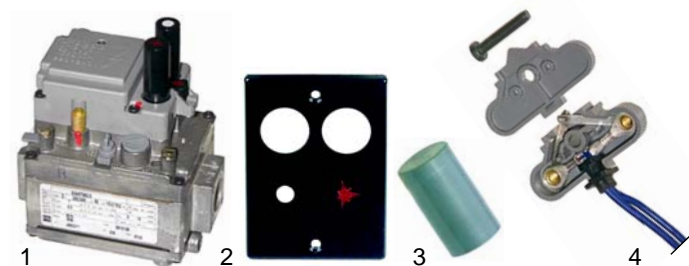

Item	Order	Description	Model	OEM
1	101127	Elettroisit gas valve	HBR/G803-804, HBR/G1003,	57543
2	111668	panel	HBR/G1004,	51280
3	101309	extension	HBR/G1013	51281
4	101312	micro switch		54539

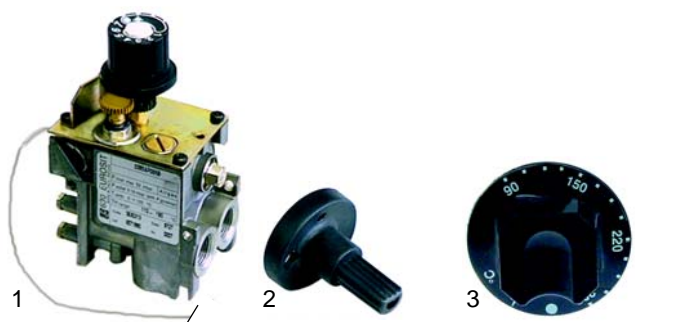

Item	Order	Description	Model	OEM
1	101409	Eurosit controller		58772
2	110358	adapter	MB/_/G, PBRG700/701	03391
3	111667	knob		04482

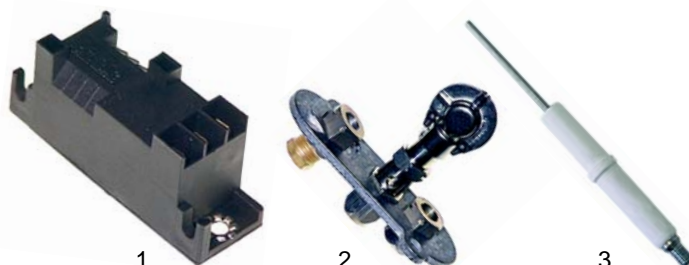

Item	Order	Description	Model	OEM
1	101002	ignition unit	HBR/G803-804, HBR/G1003,	51884
2	100052	pilot burner	HBR/G1004,	57411
3	100701	electrode	HBR/G1013	52610

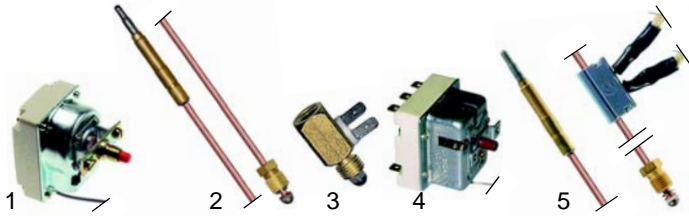

Item	Order	Beschreibung	Model	OEM
1	375572	safety thermostat	HBR/G803-804,	53980
2	102041	thermocouple, 600mm	HBR/G1003, HBR/G1004,	57781
3	101265	interrupter	HBR/G1013	
4	375163	safety thermostat	HBR/G_D	51643
5	102250	thermocouple		51932, 56914



Item	Order	Description	Model	OEM
1	101967	Novasit gas valve	HBR/G800-801,	59473
2	102340	ignition control module	HBR/G805-806, HBR/G810-811,	A5167
3	541335	pressure switch	HBR/G815-816	54540

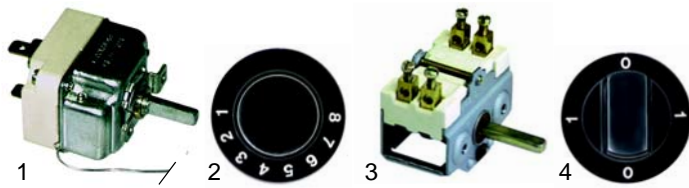

Item	Order	Description	Model	OEM
1	390156	thermostat	HBR/G803-804,	51360
2	110046	knob	HBR/G1003, HBR/G1004,	26915
3	300020	switch	HBR/G1013	28390
4	110043	knob		50341

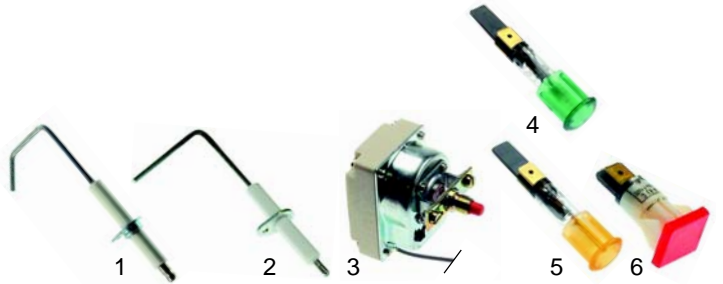

Item	Order	Description	Model	OEM
1	102169	electrode		A5168
2	102170	electrode		A5169
3	375572	safety thermostat	HBR/G800-801, HBR/G805-806,	53980
4	359364	signal lamp/green	HBR/G810-811, HBR/G815-816	58658
5	359365	signal lamp/yellow		58659
6	359366	signal lamp/red		58712

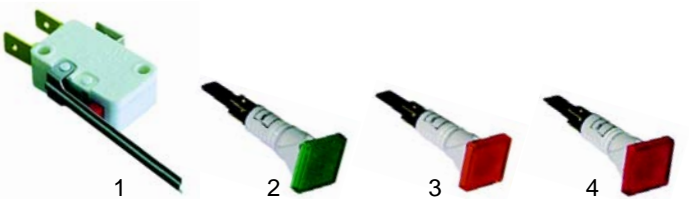

Item	Order	Description	Model	OEM
1	345254	micro switch	HBR/G803-804,	53671
2	359151	signal lamp/green	HBR/G1003, HBR/G1004,	53148
3	359152	signal lamp/yellow	HBR/G1013	53149
4	359150	signal lamp red		53150

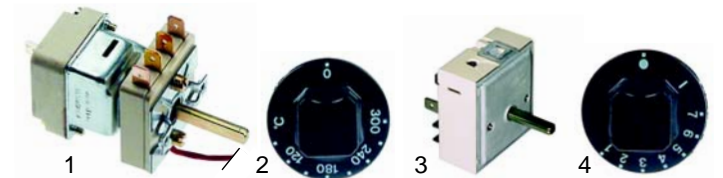

Item	Order	Description	Model	OEM
1	375581	thermostat	HBR/G800-801,	02109
2	111669	knob	HBR/G805-806,	59468
3	380015	energy regulator	HBR/G810-811, HBR/G815-816	55016
4	111670	knob		59469



Item	Order	Description	Model	OEM
1	345038	switch	HBR/G	58274
2	345039	hood	(from 2/91)	53979
3	373017	solenoid valve		55132



Item	Order	Description	Model	OEM
1	101956	Novasit gas valve	NBRG800/800H	02903
2	101799	adapter	NBRG810/810H NBRG815/815H	04667
3	111631	knob	NBRG820/820H	0C0465

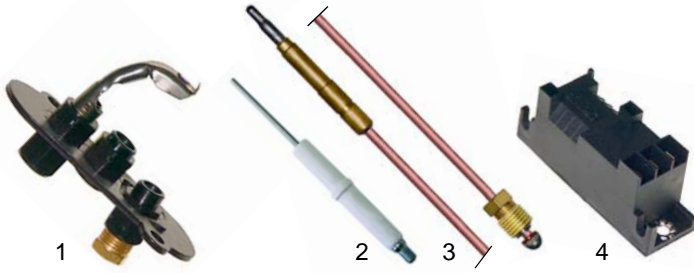

Item	Order	Description	Model	OEM
1	100050	pilot burner	NBRG800/800H	59379
2	100701	electrode	NBRG810/810H	59380
3	102041	thermocouple, 600mm	NBRG815/815H	025031
4	101002	ignition unit	NBRG820/820H	03376



Item	Order	Description	Model	OEM
1	345038	switch		58274
2	345039	hood	NBRG800/800H NBRG810/810H	53979
3	359145	signal element green	NBRG815/815H	05010
4	359146	signal element yellow	NBRG820/820H	05011
5	359144	signal element red		0C0687

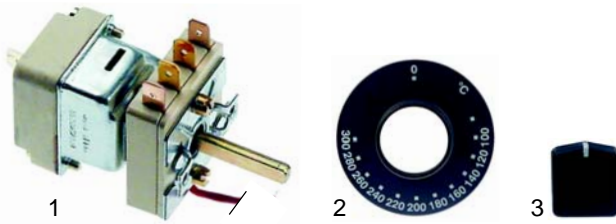

Item	Order	Description	Model	OEM
1	375581	thermostat	NBRG800/800H	02109
2	111620	panel	NBRG810/810H NBRG815/815H	0C0258
3	111602	knob	NBRG820/820H	0C0257

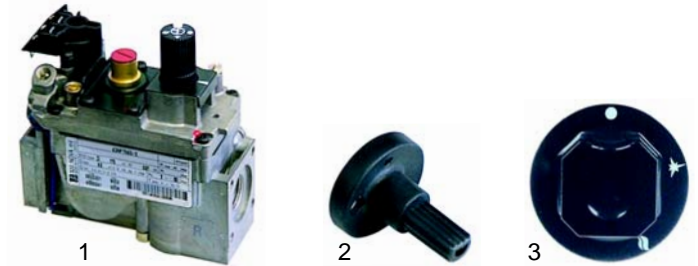

Item	Order	Description	Model	OEM
1	101187	Novasit gas valve mV.	HBR/G800-801,	02606
2	110358	adapter	HBR/G805-806, HBR/G810-811,	59305
3	111534	knob	HBR/G815-816	59304

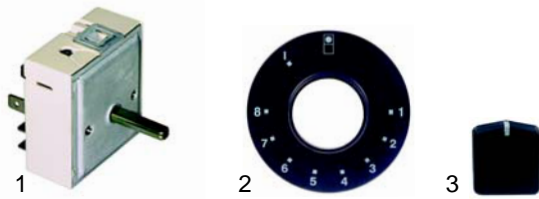

Item	Order	Description	Model	OEM
1	380015	energy regulator	NBRG800/800H	55016
2	111609	panel	NBRG810/810H NBRG815/815H	0C0318
3	111602	knob	NBRG820/820H	0C0257



Item	Order	Description	Model	OEM
1	100110	pilot burner	HBR/G800-801,	02783
2	102116	pilot generator	HBR/G805-806, HBR/G810-811,	02607
3	100701	electrode	HBR/G815-816	59380

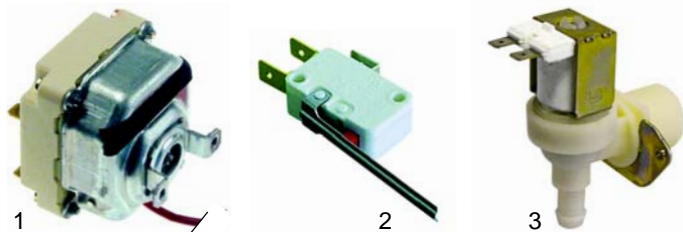

Item	Order	Description	Model	OEM
1	375565	safety thermostat	NBRG800/800H	0C0270
2	345254	micro switch	NBRG810/810H NBRG815/815H	53671
3	370015	solenoid valve	NBRG820/820H	0C0688

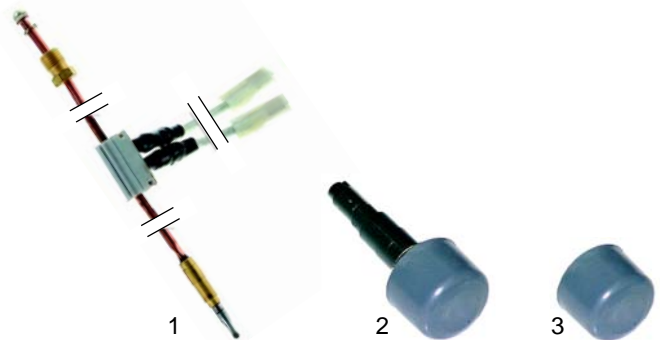

Item	Order	Description	Model	OEM
1	102252	thermocouple	HBR/G800-801,	02784
2	100012	piezoelectric igniter	HBR/G805-806, HBR/G810-811,	02605
3	101339	covering hood	HBR/G815-816	02816

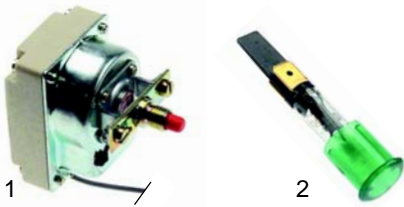

Item	Order	Description	Model	OEM
1	375572	safety thermostat	HBR/G800-801, HBR/G805-806, HBR/G810-811, HBR/G815-816	53980
2	359364	signal lamp		05010

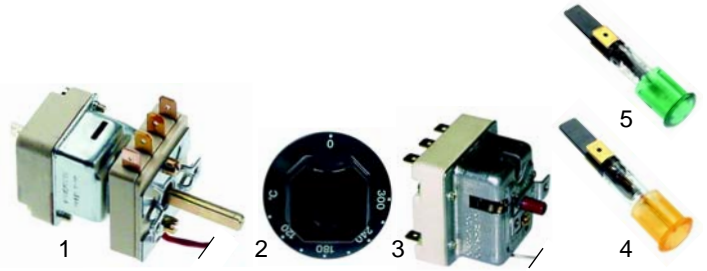

Item	Order	Description	Model	OEM
1	375581	thermostat		02109
2	111671	knob	HBR/G820,	02104
3	375163	safety thermostat	HBR/G825	51643
4	359364	signal lamp/green		58658
5	359365	signal lamp/yellow		58659

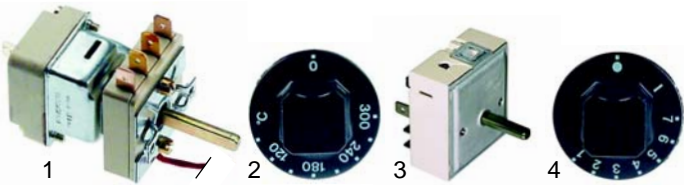

Item	Order	Description	Model	OEM
1	375581	thermostat	HBR/G800-801, HBR/G805-806, HBR/G810-811, HBR/G815-816	02109
2	111669	knob		59468
3	380015	energy regulator		55016
4	111670	knob		59469

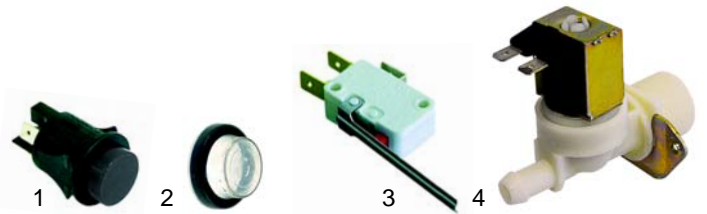

Item	Order	Description	Model	OEM
1	345038	switch		58274
2	345039	hood	HBR/G820,	53979
3	345254	micro switch	HBR/G825	53671
4	373017	solenoid valve		55132



Order	Description	Model	OEM
1	101956	Novasit gas valve	02903
2	101928	adapter	HBR/G820, HBR/G825
3	111534	knob	59304
4	101312	micro switch	54539

Tilting bratt pans (electric)

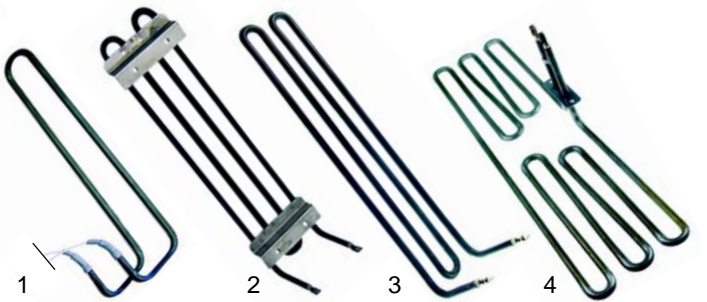

Item	Order	Description	Model	OEM
1	415098	1500W/230V	RBR/E700	A2068
2	415273	1500W/230V	MBR/E7	58345 58349
3	418016	1500W/230V	MBK/E7 (2nd generation)	02559
4	418003	3000W/230V	MBR/E2_ MBK/E2_ PBRE70_	04469

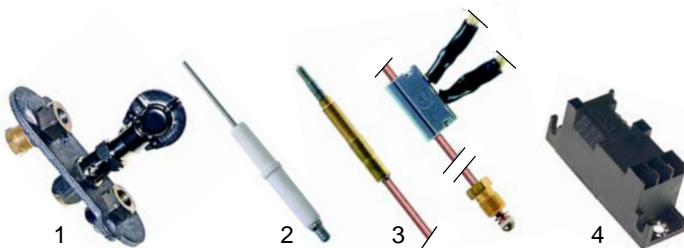

Item	Order	Description	Model	OEM
1	100052	pilot burner		57411
2	100701	electrode		52610
3	102250	thermocouple with interrupter	HBR/G820, HBR/G825	56914
4	101002	ignition unit		03376

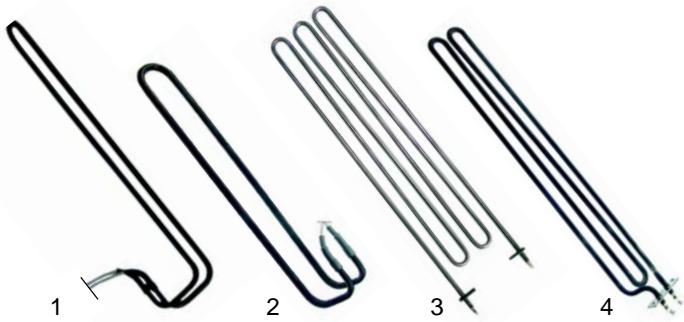

Item	Order	Description	Model	OEM
1	415381	1300W/230V	HBR/E803, HBR/E804, HBR/E820, HBR/E825, HBR/E1003, HBR/E1013	51355
2	418004	1500W/230V	HBR/E801	51356
3	415184	2200W/230V	HBR/E800, HBR/E805, HBR/E810-811, HBR/E815-816	59401
4	418005	2500W/230V	NBRE800, NBRE810, NBRE815, NBRE820	0C0685

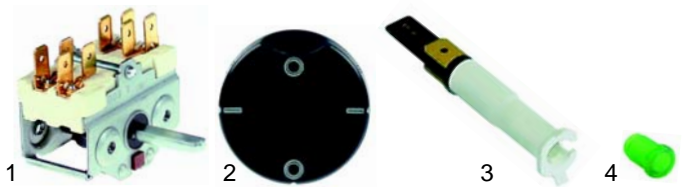

Item	Order	Description	Model	OEM
1	300074	switch		A2162
2	111638	knob	RBR/E	26797
3	359109	signal element		54150
4	359803	lens		54151



Item	Order	Description	Model	OEM
1	375642	thermostat		A2012
2	111617	knob	RBR/E	53867
3	346362	micro switch		A2145, A2194, 58344

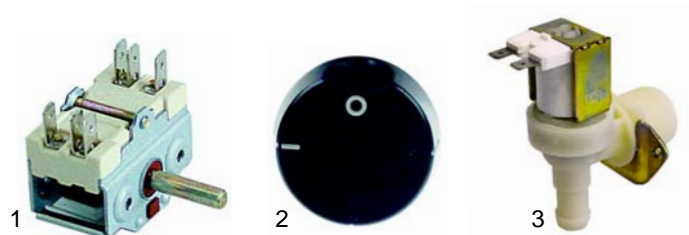

Item	Order	Description	Model	OEM
1	300129	switch		A2227
2	111672	knob	RBR/E	56871
3	370016	solenoid valve		47529

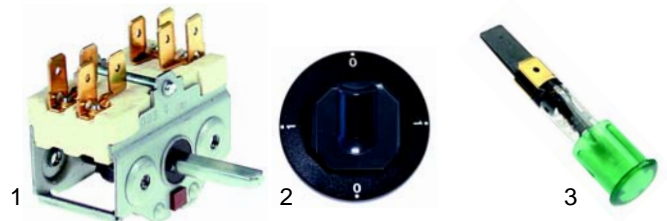

Item	Order	Description	Model	OEM
1	300074	switch		A2162
2	110315	knob	MBR/E700-.701, MBR/E706, MBR/E710-711, MBR/E716	58629
3	359364	signal lamp		58658

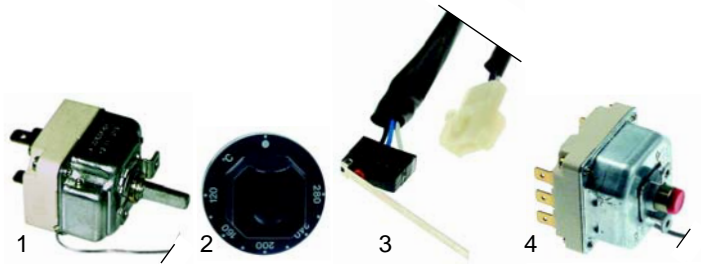

Item	Order	Description	Model	OEM
1	390156	thermostat		51360
2	111673	knob	MBR/E700-.701, MBR/E706, MBR/E710-711, MBR/E716	02374
3	346362	micro switch		58344
4	375571	safety thermostat		51454

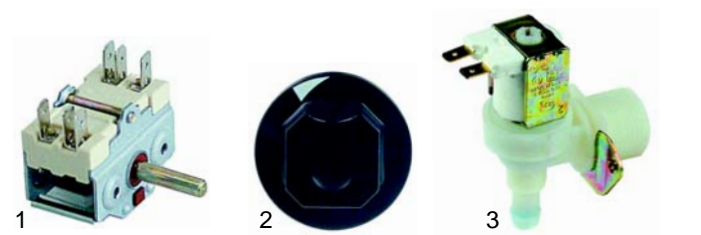

Item	Order	Description	Model	OEM
1	300129	switch		A2227
2	111674	knob	MBR/E700-.701, MBR/E706, MBR/E710-711, MBR/E716	58630
3	370339	solenoid valve		55350

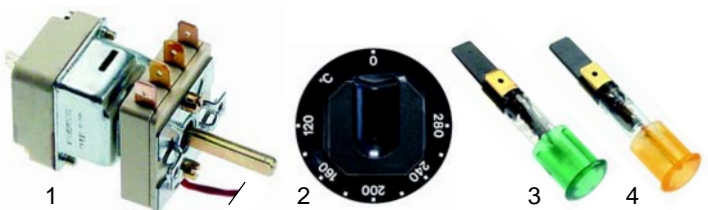

Item	Order	Description	Model	OEM
1	375581	thermostat		02109
2	110447	knob		59403
3	359364	signal lamp/green	MBR/E2_, MBK/E2_, PBRE70_	05010
4	359365	signal lamp/yellow		05011

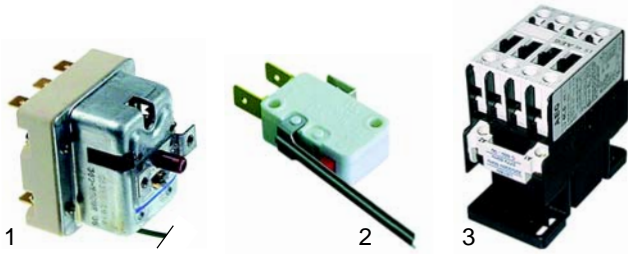

Item	Order	Description	Model	OEM
1	375562	safety thermostat	MBR/E2_	04269
2	345254	micro switch	MBK/E2_	53671
3	380244	contactor	PBRE70_	03598

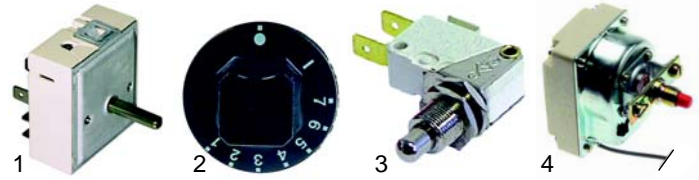

Item	Order	Description	Model	OEM
1	380015	energy regulator	HBR/E800-801,	55016
2	111670	knob	HBR/E805-806,	59469
3	345032	micro switch	HBR/E810-811,	46063
4	375572	safety thermostat	HBR/E815-816	53980

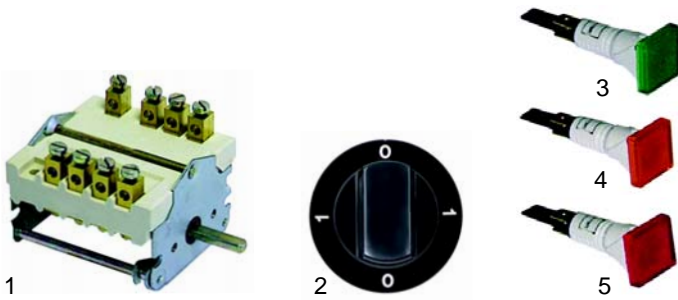

Item	Order	Description	Model	OEM
1	300102	switch		50857
2	110043	knob	MBR/E801,	50341
3	359151	signal lamp/green	MBR/E803,	53148, 53154
4	359152	signal lamp/yellow	MBR/E1003,	53149, 53155
5	359150	signal lamp/red	MBR/E1013	53150, 53153

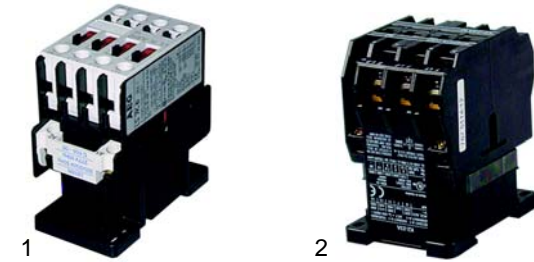

Item	Order	Description	Model	OEM
1	380261	contactor	HBR/E800-801,	58805
2	380637	contactor	HBR/E805-806	54928

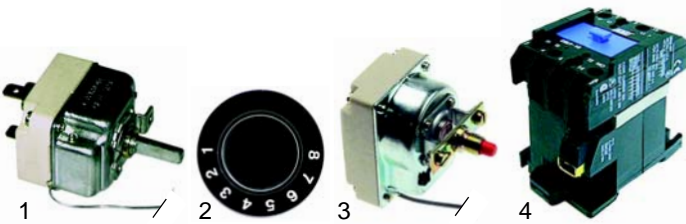

Item	Order	Description	Model	OEM
1	390156	thermostat		51360
2	110046	knob	MBR/E801,	26915
3	375572	safety thermostat	MBR/E803,	53980
4	380204	contactor	MBR/E1003,	75796
			MBR/E1013	

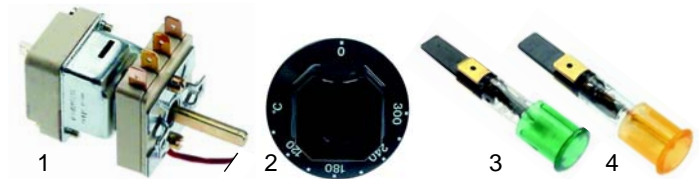

Item	Order	Description	Model	OEM
1	375581	thermostat		02109
2	111671	knob		02104
3	359364	signal lamp/green	HBR/E820,	58658
4	359365	signal lamp/yellow	HBR/E825	58659

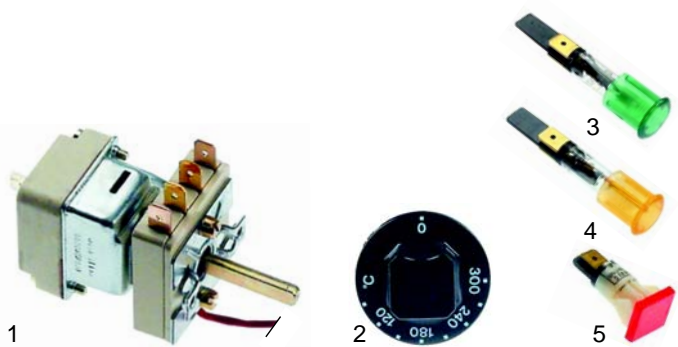

Item	Order	Description	Model	OEM
1	375581	thermostat		02109
2	111669	knob	HBR/E800-801,	59468
3	359364	signal lamp/green	HBR/E805-806,	58658
4	359365	signal lamp/yellow	HBR/E810-811,	58659
5	359366	signal lamp/red	HBR/E815-816	58712

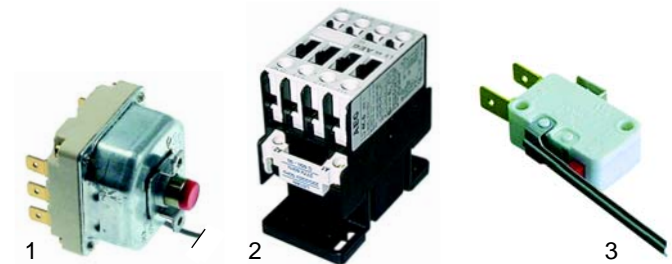

Item	Order	Description	Model	OEM
1	375571	safety thermostat		51454
2	380244	contactor	HBR/E820,	03598
3	345254	micro switch	HBR/E825	53671

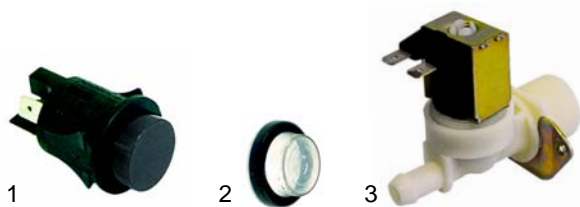

Item	Order	Description	Model	OEM
1	345038	switch	HBR/E820,	58274
2	345039	hood	HBR/E825	53979
3	373017	solenoid valve		55132

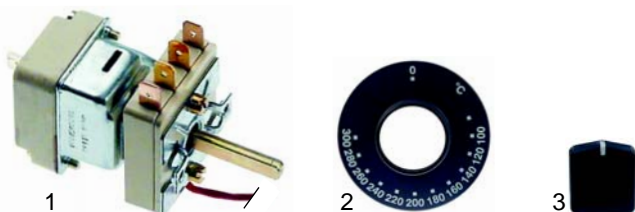

Item	Order	Description	Model	OEM
1	375581	thermostat	NBRE800,	02109
2	111620	panel	NBRE810,	0C0258
3	111602	knob	NBRE820	0C0257

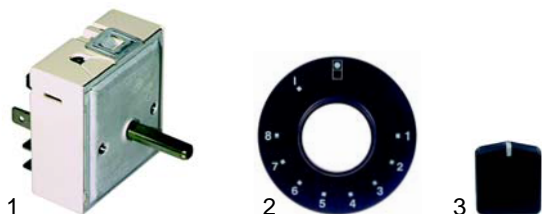

Item	Order	Description	Model	OEM
1	380015	energy regulator	NBRE800,	55016
2	111609	panel	NBRE810,	0C0318
3	111602	knob	NBRE820	0C0257

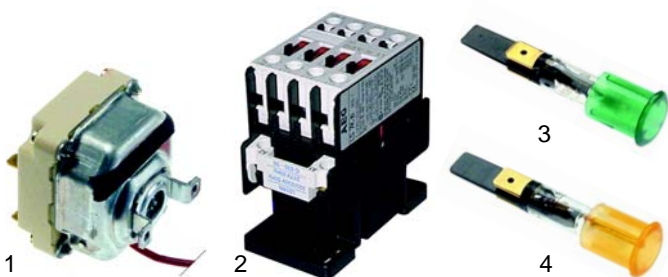

Item	Order	Description	Model	OEM
1	375565	safety thermostat	NBRE800,	0C0270
2	380261	contactor	NBRE810,	06879
3	359364	signal lamp/green	NBRE815,	05010
4	359365	signal lamp/yellow	NBRE820	05011



Item	Order	Description	Model	OEM
1	345038	switch		58274
2	345039	protecting cover	NBRE800,	53979
3	370015	solenoid valve	NBRE810,	0C0688
4	345254	micro switch	NBRE820	53671

Tilting bratt pans (motor driven)

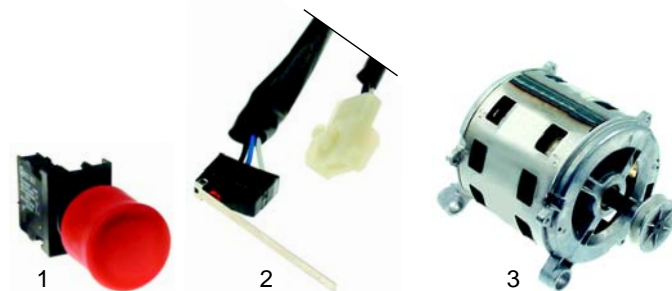

Item	Order	Description	Model	OEM
1	346340	switch/complete	RBR/E_	A2196
2	346362	micro switch	RBR/G_	A2195, 58344
3	500626	motor	MBR/G_	56980



Item	Order	Description	Model	OEM
1	693261	v-belt pulley	RBR/E_	56976
2	693262	v-belt	RBR/G_	52804
3	700420	spring/motor tension	MBR/G_	56975
4	700421	spring/foot switch	MBR/E_	56977



Item	Order	Description	Model	OEM
1	345254	micro switch		53671
2	500823	motor		52802
3	n. l. a.	belt pulley	HBR/G1013	52784
4	693264	belt pulley		52783
5	693262	v-belt		52804

no longer available



Item	Order	Description	Model	OEM
1	n. l. a.	ball bearing	HBR/G1013	52799
2	693266	nut		52800
3	693267	shaft		52803
4	523519	ball bearing		51298

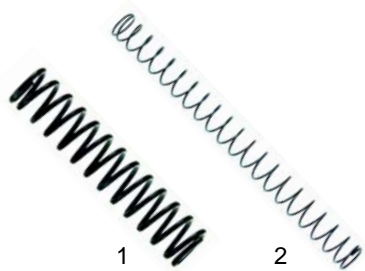

Item	Order	Description	Model	OEM
1	700422	spring/motor tension	HBR/G1013	52789
2	700423	spring/foot switch		52787

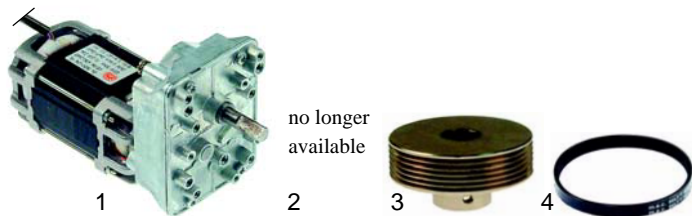

Item	Order	Description	Model	OEM
1	500627	motor/complete	HBR/_801, HBR/_806, HBR/_811, HBR/_816	02144
2	n. l. a.	v-belt pulley		02146
3	693268	v-belt pulley		02147
4	693269	v-belt		02148

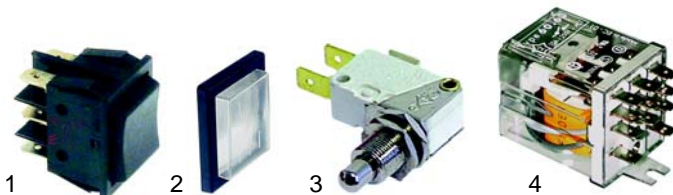

Item	Order	Description	Model	OEM
1	346309	switch	HBR/_801, HBR/_806, HBR/_811, HBR/_816	02149
2	301036	protective cover		02150
3	345032	micro switch		46063, 58926
4	380312	relay		58857, 56466



Item	Order	Description	Model	OEM
1	500628	motor	HBR/_811, HBR/_816	02794
2	693270	gearbox		02795



Item	Order	Description	Model	OEM
1	345038	switch	HBR/_811, HBR/_816	58274
2	345039	hood		
3	345032	micro switch		02785, 58926

Tilting bratt pans (mechanical)



Item	Order	Description	Model	OEM
1	523510	ball bearing	RBR/_ , MBR/_ , MBH/_	56820
2	523520	ball bearing		56821
3	693271	shaft		56823
4	693272	bush		56818
5	n. l. a.	holder		56824
6	693274	bush		56825

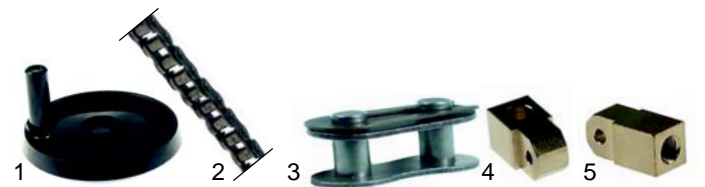

Item	Order	Description	Model	OEM
1	693624	hand wheel	RBR/_ , MBR/_ , MBH/_	56826
2	693275	chain		56862
3	693276	chain closing link		56863
4	693277	chain end		56827
5	693278	chain end		56830

Z

Suitable for Zanussi

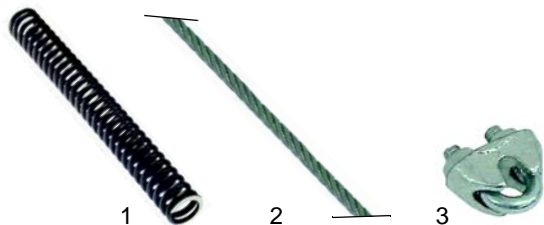

Item	Order	Description	Model	OEM
1	700424	lid spring		56846
2	693279	cablе/complete	RBR/_ , MBR/_ , MBH/_	56852
3	516193	clamp		56853



Item	Order	Description	Model	OEM
1	693291	nut		0C0675
2	693292	shaft		0C0674
3	523510	bearing	NBRG/_ , NBRE/_	0C0673
4	693399	hand wheel		A5164
5	514250	hand crank		02276



Item	Order	Description	Model	OEM
1	693318	nut		51264
2	693282	ring		51277
3	693283	shaft	HBR/_801 ,	51336
4	693284	holder	HBR/_803 ,	51265
5	523519	ball bearing	HBR/_804 ,	51298
6	690858	hand wheel	HBR/_1003	52392
7	690859	handle		52393



Item	Order	Description	Model	OEM
1	693294	spring inclination	NBRG/_ , NBRE/_	0C0671
2	693295	spring cap		0C0666



Item	Order	Description	Model	OEM
1	693285	adjust ring	HBR/_801 ,	51266
2	693286	spring	HBR/_803 ,	51268
3	693287	spring compressor	HBR/_804 ,	51267
4	693288	hinge	HBR/_1003 , HBR/_820 , HBR/_825	51260



Item	Order	Description	Model	OEM
1	540799	tap	HBR/_G , HBR/_E	02322
2	540989	inlet pipe	NBRG/_ , NBRE/_	0C0689



Item	Order	Description	Model	OEM
1	693399	hand wheel		A5164
2	514250	hand crank		02276
3	693289	spring	HBR/_800-801 ,	A5150
4	693290	spring compressor	HBR/_805-806 , HBR/_810-811 , HBR/_815-816	A2551

Z

Suitable for Zanussi

Boiling pans (gas)

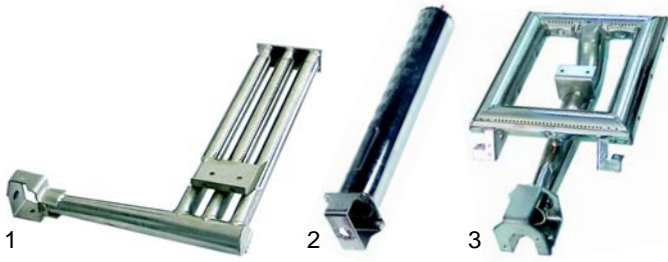

Item	Order	Description	Model	OEM
1	104157	burner	RPN/G_, RPN/G1_, MPN/G, MPN/G1_	51716
2	105641	burner	MPD/G2_, MPI/G2, PPNGD_, PPNG1_	04847
3	105654	burner	HQN/G917, HQN/G1 917	51563
3	105655	burner	HQN/G1225, HQN/G1 1225	51564

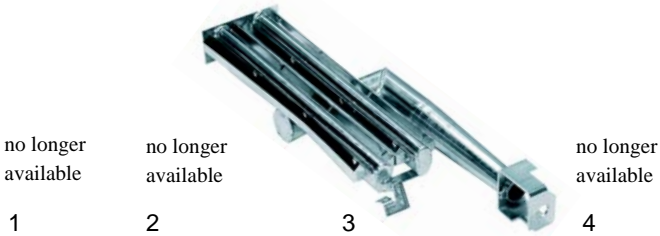

Item	Order	Description	Model	OEM
1	n. l. a.	burner/right	HPN/G810, HPN/G1 810, HPA/G810, HPA/G1 810	51799
2	n. l. a.	burner/left		51800
3	105658	burner/right	HPN/G815, HPN/G1 815, HPA/G815, HPA/G1 815	51797
4	n. l. a.	burner/left		51798

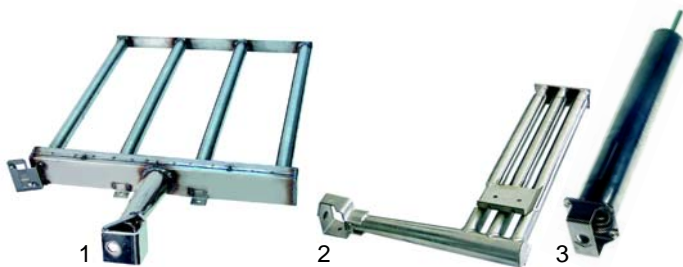

Item	Order	Description	Model	OEM
1	105660	burner	HPN/G0 810-811, HPN/G1 810-811, HPN/G0 815-816, HPN/G1 815-816	59506
2	104157	burner	HPN/G1 805-806	51716
3	105661	burner	NPGD_, NPG1_	0C0743



Item	Order	Description	Model	OEM
1	101091	gas tap		54811
2	111599	knob	RPN/G760, RPN/G1 760	52604
3	100007	piezoelectric igniter		52539



Item	Order	Description	Model	OEM
1	101091	gas tap		54811
2	110309	knob	MPN/GD 760-761, MPN/G1 760	58597
3	100012	piezoelectric igniter		02605
4	101339	hood		02816



Item	Order	Description	Model	OEM
1	100106	pilot burner	RPN/G760, RPN/G1 760, MPN/GD760, MPN/GD761, MPN/G1 760	57737 58329 58715
2	100706	electrode		56754 51565
3	102044	thermocouple, 1200mm		20094

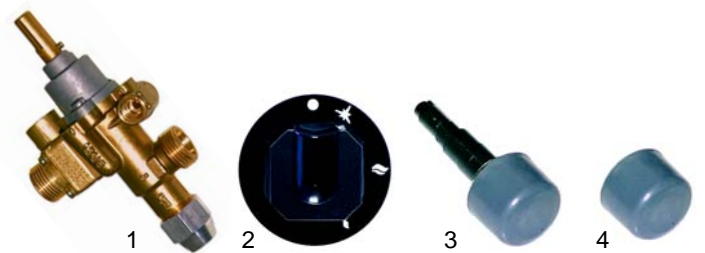

Item	Order	Description	Model	OEM
1	101087	gas tap		52146
2	110448	knob	MPD/G2_, MPI/G2_	59378
3	100012	piezoelectric igniter	PPNGD_, PPNGI_	02603
4	101339	hood		02816



Item	Order	Description	Model	OEM
1	100109	pilot burner	MPD/G2_	A2472
2	100701	electrode	MPI/G2_	59988
3	102044	thermocouple, 1200mm	PPNGD_	20094
			PPNGI_	

no longer available



Item	Order	Description	Model	OEM
1	n. l. a.	VR8-valve	HPN/G810D,	37578
2	110070	knob	HPN/G815D,	51638
3	100001	piezoelectric igniter	HPN/GI810D,	51567
			HPN/GI815D,	
			HQNIG/_D,	
			HQNI/GI_D	

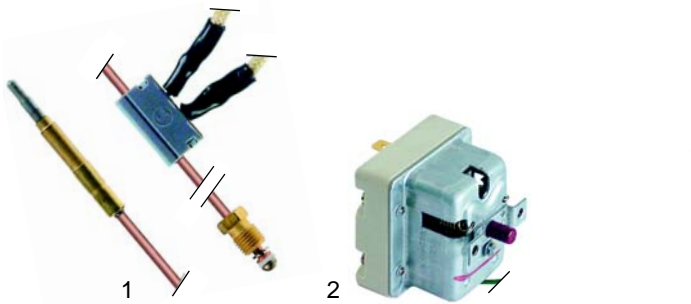

Item	Order	Description	Model	OEM
1	102250	thermocouple	MPD/G2_	56914
2	375586	safety thermostat	MPI/G2_	A5435
			PPNGD_	
			PPNGI_	

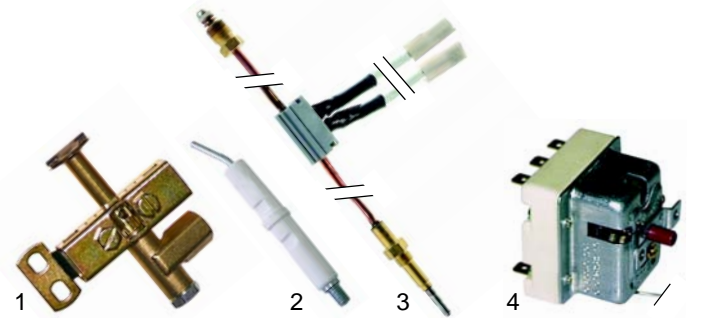

Item	Order	Description	Model	OEM
1	100106	pilot burner	HPN/G_	57737, 51624,
			HPN/GI_	58329
2	100706	electrode	HPA/GI_	51565, 56754
3	102253	thermocouple	HQN/G_	51635
4	390045	safety thermostat	HQN/GI_	51637



Item	Order	Description	Model	OEM
1	101091	gas tap	HPN/G810,	54811
			HPN/G815,	
			HPN/GI 810,	
2	110045	knob	HPN/GI 815,	52138
			HPA/GI 815,	
			HQN/G 917,	
			HQN/GI 917,	
3	100007	piezoelectric igniter	HQN/G 1225,	52539
			HQN/GI 1225	

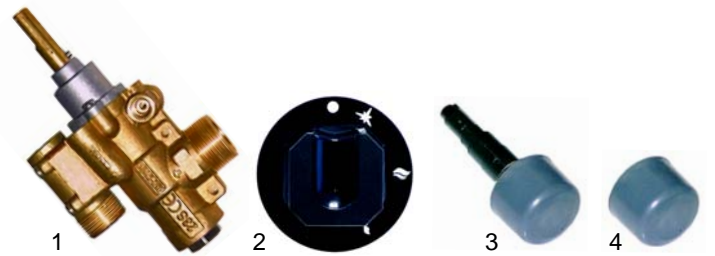

Item	Order	Description	Model	OEM
1	101091	gas tap	HPN/GD_	59505, 54811
2	110448	knob	HPN/GI_	59378
3	100012	piezoelectric igniter	HPA/GD,	02605
4	101339	hood	HPA/G5	02605, 02816



Item	Order	Description	Model	OEM
1	100050	pilot burner	HPN/GD_	59379
2	100701	electrode	HPN/GI_	59380
3	102250	thermocouple	HPA/GD,	56914

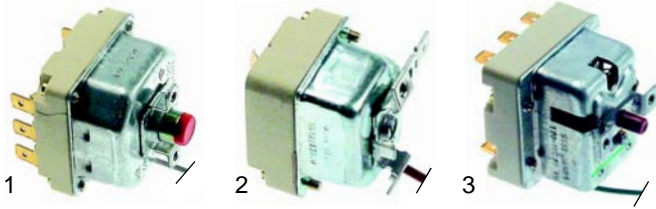

Item	Order	Description	Model	OEM
1	375588	safety thermostat 285 C/until No. 210_	HPN/GD, HPA/GI	53183
2	375589	thermostat from No. 211_		06709
3	375577	safety thermostat 170 C	HPN/GI, HPA/GI	05295

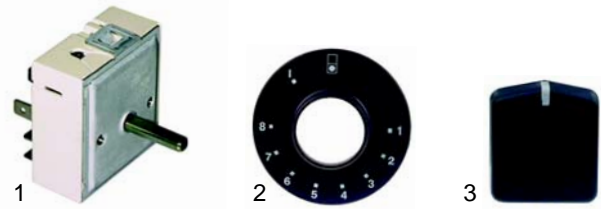

Item	Order	Description	Model	OEM
1	380015	energy regulator	NPG_	55016
2	111608	panel		0C0317
3	111602	knob		0C0257



Item	Order	Description	Model	OEM
1	300074	switch		A2162
2	110449	knob	HPN/GI 810, HPN/GI 815-816,	59333
3	101948	solenoid valve	HPN/GI 805, HPN/GI 806	59509
4	541350	pressure switch		A2480
5	359364	signal lamp		58658

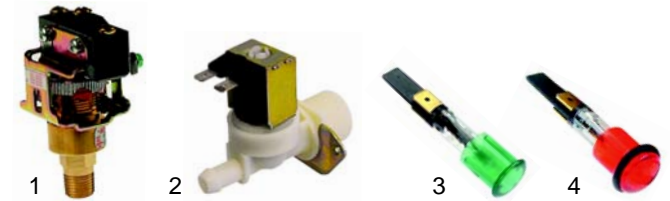

Item	Order	Description	Model	OEM
1	541350	pressure switch	NPG_	A2480
2	373017	solenoid valve		55132
3	359364	signal lamp/green		05010
4	359367	signal lamp/red		0C0687

Boiling pans (electric)

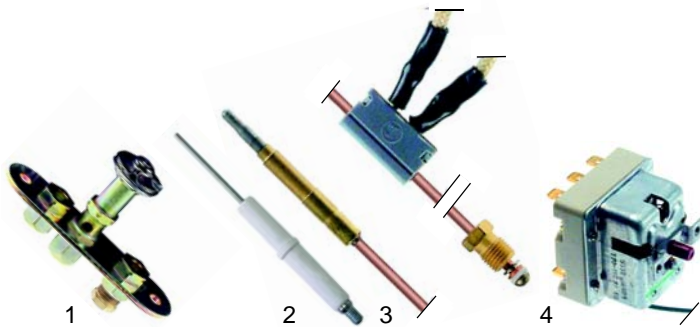

Item	Order	Description	Model	OEM
1	101898	pilot burner		0C0744
2	100701	electrode	HPN/GI 810, HPN/GI 815-816,	59380
3	102250	thermocouple	HPN/GI 805, HPN/GI 806	56914
4	375577	safety thermostat	NPGI	05295
4	375675	safety thermostat	NPGD	0C1000

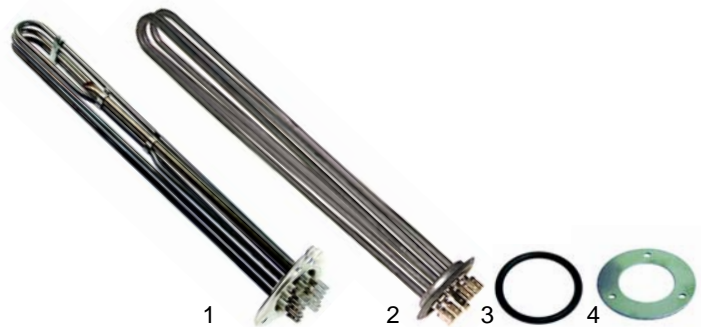

Item	Order	Description	Model	OEM
1	418189	4700W/230 V with thermostat pocket	RPN/EI 660, MPN/EI 760,	49307, 02524, 26453, 57698
2	415069	4500W/230 V thermostat pocket	MPI/E 240, MPI/E260, MPI/E260P,	5557, 02523, 45518
3	510408	gasket	PPNEI 740, PPNEI 760,	46213
4	520236	flange	PPNEI 761, HPN/EI 805, HPN/EI 806	65558

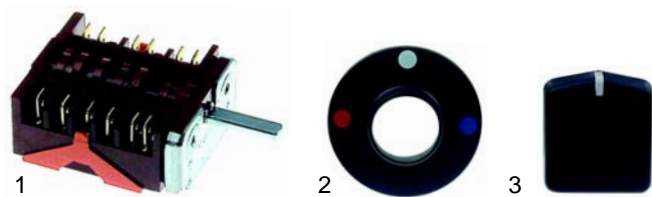

Item	Order	Description	Model	OEM
1	301216	switch	NPG_	59544
2	111675	panel		0C0711
3	111602	knob		0C0257

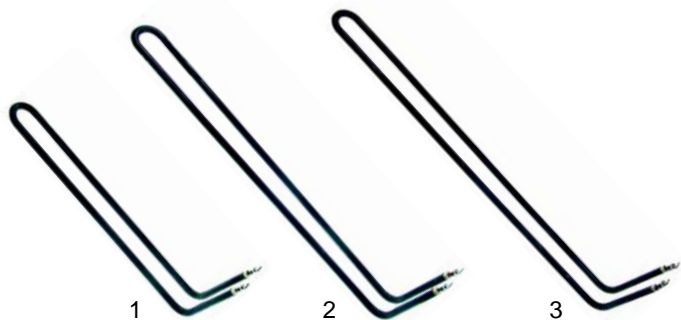

Item	Order	Description	Model	OEM
1	418006	750 V/230V	HPN/E810, HPN/E815,	59681, 51854, 51857
2	418007	1050W/230V	HPN/ED810, HPN/ED811,	59680, 51855, 51858
3	418008	1250W/230V	HPN/ED816, HPA/ED825	59679, 51856, 51859



Item	Order	Description	Model	OEM
1	418190	6000W/230V		03409, 03410
2	550680	flange	HPN/EI 855, HPN/EI 1255	03534



Item	Order	Description	Model	OEM
1	415069	4500W/230V	HPN/EI 815	65557, 45518
2	415379	6000W/230V with thermostat pocket	HPE/EI 815, HPN/EI 917, HPN/EI 1225, HQN/EI_	51632, 51633
3	415405	6000W/230V without thermostat pocket	HPN/EI 917, HPN/EI 1225, HQN/EI_	66110, 45559, 58011, 76035
4	510408	gasket		46213
5	520236	flange		65558

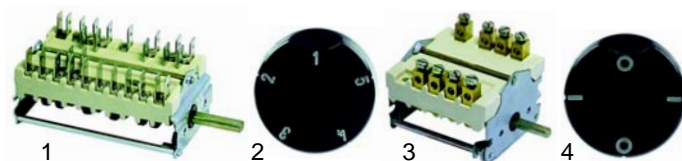

Item	Order	Description	Model	OEM
1	300009	switch		51647
2	111639	knob	RPN/EI 760	51697
3	300102	switch		50857
4	111638	knob		26797

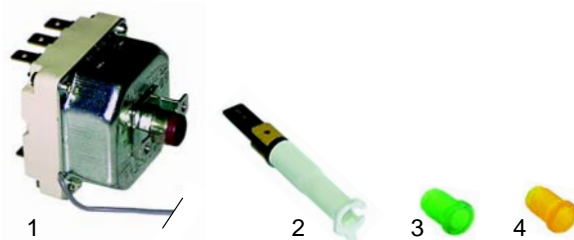

Item	Order	Description	Model	OEM
1	390165	safety thermostat		51644
2	359109	signal element/green	RPN/EI 760	54150
2	359110	signal element/yellow		53811
3	359803	lens/green		54151
4	359804	lens/yellow		75589



Item	Order	Description	Model	OEM
1	418189	4700W/230V	NPEI 806	02524
2	418126	7500W/230V	NPN/EI_ (2nd generation), HPNS/EI_ (2nd generation), HPA/EI_ (2nd generation),	59665
3	418017	10750W/230V	NPEI 810, NPEI 815	0C0715
4	510408	gasket		46213

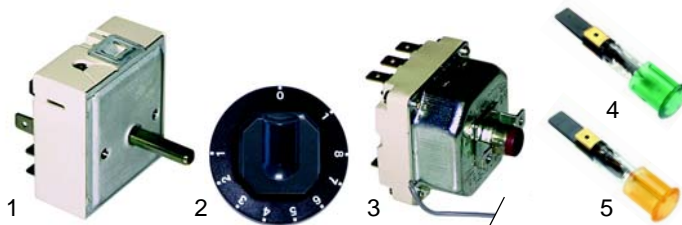

Item	Order	Description	Model	OEM
1	380015	energy regulator		55016
2	110346	knob	MPN/EI 760	02522
3	390165	safety thermostat		51644
4	359364	signal lamp/green		58658, 05010
5	359365	signal lamp/yellow		05012

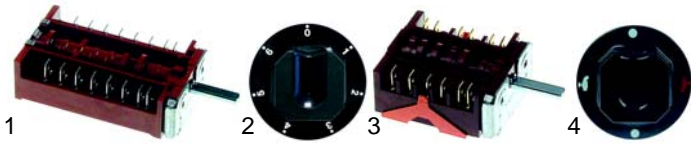

Item	Order	Description	Model	OEM
1	301210	switch	MPI/E 240,	04741
2	110428	knob	MPI/E 260, MPI/E 260P,	59230
3	301216	switch	PPNEI 740, PPNEI 760, PPNEI 761	59544
4	111676	knob		04885

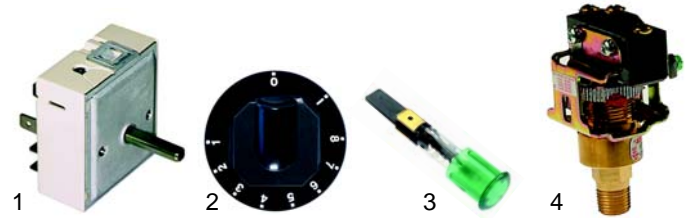

Item	Order	Description	Model	OEM
1	380015	energy regulator	HPN/EI (2.Gen.),	55016
2	110429	knob	HPN/ED_, MPA/ED_,	59554
3	359364	signal lamp green	MPA/EI_	58658
4	541350	pressure switch	HPN/EI806	A2480



Item	Order	Description	Model	OEM
1	375209	safety thermostat	MPI/E 240,	04862
2	373017	solenoid valve	MPI/E 260, MPI/E 260P	55132
3	359364	signal lamp/green		05010
4	541350	pressure switch	MPI/E 260P, PPNEI761	A2480

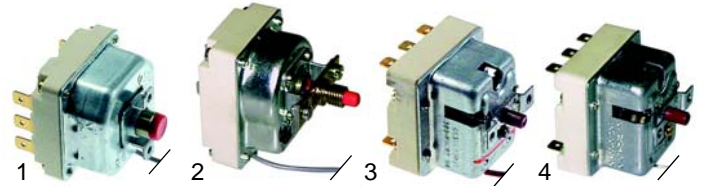

Item	Order	Description	Model	OEM
1	375571	safety thermostat	HPN/E810, HPN/E815	51454
2	390044	safety thermostat	HPN/EI_, HQN/EI_	51636
3	375563	safety thermostat	HPN/ED	04600
4	375209	safety thermostat	HPN/EI (2. Gen.)	04862

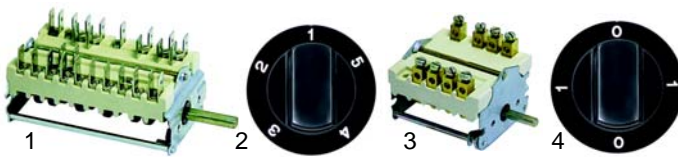

Item	Order	Description	Model	OEM
1	300009	switch		51647
2	110042	knob	HPN/E,	51552
3	300102	switch	HPN/EI	50857
4	110043	knob		50341



Pos.	Order	Description	Model	OEM
1	541349	pressure switch		55052



Item	Order	Description	Model	OEM
1	300008	switch		51634
2	110042	knob	HQN/EI917,	51552
3	300020	switch	HQN/EI1225	28390
4	110043	knob		50341

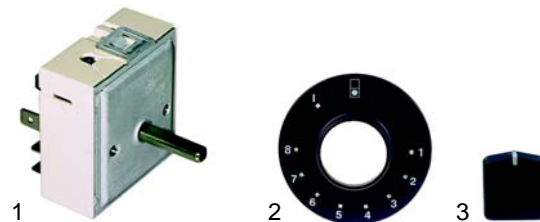

Item	Order	Description	Model	OEM
1	380015	energy regulator	NPEI806,	55016
2	111608	panel	NPEI810,	0C0317
3	111602	knob	NPEI815	0C0257

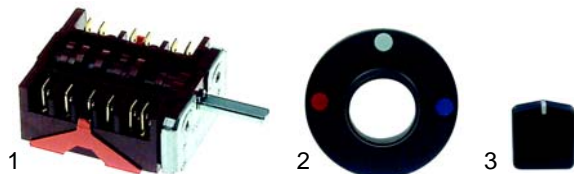

Item	Order	Description	Model	OEM
1	301216	switch	NPEI806,	59544
2	111675	panel	NPEI810,	0C0711
3	111602	knob	NPEI815	0C0257

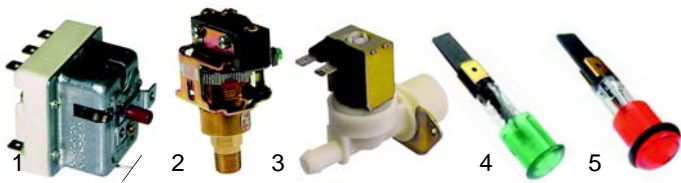

Item	Order	Description	Model	OEM
1	375209	safety thermostat		04862
2	541350	pressure switch		A2480
3	373017	solenoid valve	NPEI806, NPEI810, NPEI815	55132
4	359364	signal lamp/green		05010
5	359367	signal lamp/red		0C0687

Boiling pans (mechanical)



Item	Order	Description	Model	OEM
1	540971	inlet tap/right		25733, 03516
2	540930	inlet tap/left		26537, 03517
3	111642	knob	RPN/_	51694
4	111678	knob		51695
5	550843	screw		51675
6	540990	inlet pipe		51672

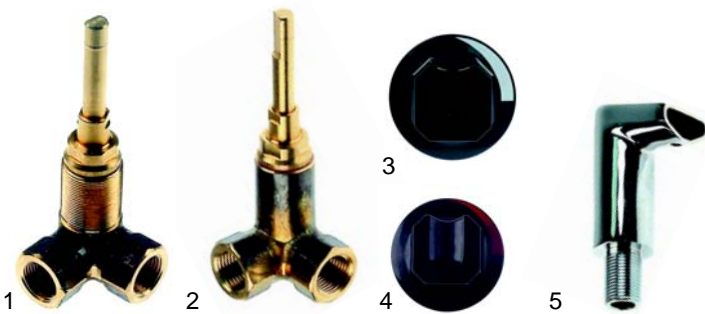

Item	Order	Description	Model	OEM
1	540971	inlet tap/right		03516
2	540930	inlet tap/left		03517
3	111642	knob	MPN/_	58632
4	111678	knob		58708
5	540990	inlet pipe		51672



Item	Order	Description	Model	OEM
1	540991	inlet tap		A5258
2	540933	extension	MPD/ MPI,	A2135
3	111643	knob	PPNG_ PPNE_	04483
4	111667	knob		04482
5	540966	inlet pipe		04537



Item	Order	Description	Model	OEM
1	540971	inlet tap/right		25733
2	540930	inlet tap/left		26537
3	110287	knob/black	HPN/_ (1st generation), HQN/_ (1st generation),	25260, 54254
4	110288	cap	HPA/_ (1st generation)	54367
5	540992	inlet pipe		54521



Item	Order	Description	Model	OEM
1	540971	inlet tap/right		03516
2	540930	inlet tap/left		03517
3	111644	knob	HPN/_ (2nd generation), HPA/_ (2nd generation),	59531
4	111680	knob	HPNS/_ (2nd generation)	59516
5	540992	inlet pipe		51521



no longer available

Item	Order	Description	Model	OEM
1	540822	fitting holder		54808
2	540823	safety valve	RPN/_, MPN/_	04863, 54806
3	540825	pressure relief valve	MPI/_	51566
4	540834	cap	PPN_I_	27297
5	n. l. a.	testing tap		51568



Item	Order	Description	Model	OEM
1	540999	drain cock, M68x3	RPN/_	52907, 050137
2	548001	drain cock, M68x3	MPN/_ , MPD/_ , MPI/_ , PPN_	02520



no longer available

Item	Order	Description	Model	OEM
1	540721	safety valve		57493, 56691
2	540993	pressure gauge holder	HPN/ , HQN/ , NPGI , NPEI	51642
3	540825	pressure relief valve		51566
4	540834	cap		27297
5	n. l. a.	testing tap		51568



Item	Order	Description	Model	OEM
1	540157	drain cock, M78x3mm	HPN/_ , HPA/_	53159, 050138
2	540275	drain cock, 2"	HPN/_ , HPA/_	08027, 050135



Item	Order	Description	Model	OEM
1	541062	manometer	HPN, HQN	17055
2	541334	manometer	HPN (2nd generation)	59515
3	541339	manometer	NPGI_ , NPEI_	0C0712



Item	Order	Description	Model	OEM
1	693296	adapter	MPN/__D	56923
2	693297	adapter	HPN/__D	55403
3	540134	drain cock, 2"	MPN/__D, HPN/__D	52882



Item	Order	Description	Model	OEM
1	540722	safety valve	autoclaves	52623
2	514304	safety valve	MPN/__D	59663
3	540826	pressure relief valve		59664



Item	Order	Description	Model	OEM
1	693298	holder/left		52892
2	693299	spring		52894
3	693300	bush	RPN/ , MPN/	52897
4	693301	holder/right		52891

Z

Suitable for Zanussi



Item	Order	Description	Model	OEM
1	693302	holder	MPI/_ , MPD/_ , PPN_	04849
2	693304	spring		04850
3	693305	tension adjustor		A2612



Item	Order	Description	Model	OEM
1	693307	holder		02944
2	693308	bush		59864
3	693309	bush		59863
4	693310	bush	HPN/_ (2nd generation)	59865
5	693311	screw		59860
6	693312	screw		59859

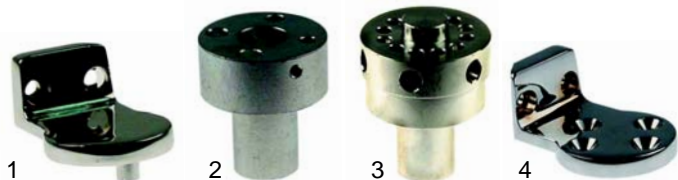

Item	Order	Description	Model	OEM
1	693306	holder/right		02106, 51288
2	693285	bush/right	HPN/, HPA/, HQN/	51266
3	693287	bush/left		51267
4	693288	holder/left		51260, 02107



Item	Order	Description	Model	OEM
1	693313	spring	HPN/_ (H900)	51527
2	693286	spring	HQN/_ (H900)	51268
3	693314	spring	HPN/_ (H0920), HPA/_ (H0920)	59528
4	693315	spring	HPN/_825, HPA/_825	02981
5	693316	spring	NPG_, NPI_	59518

Hot-air devices

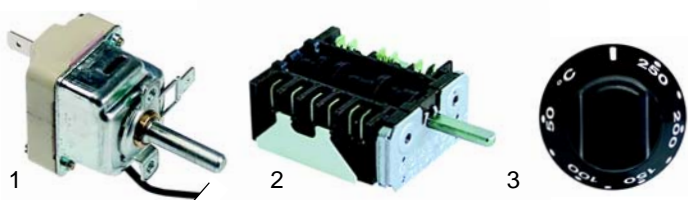

Item	Order	Description	Model	OEM
1	375664	thermostat	FCF/E4	54323
2	301095	switch		54324
3	111684	knob		54278, 66204

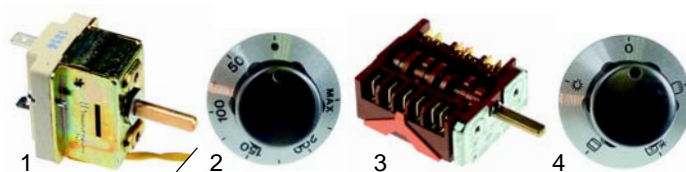

Item	Order	Description	Model	OEM
1	375665	thermostat	FCF/E4 (240271/2)	05207
2	111686	knob		05208
3	301229	switch		05213
4	111687	knob		05209

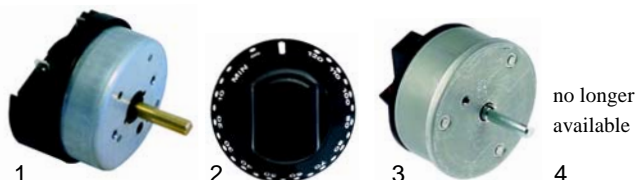

Item	Order	Description	Model	OEM
1	350008	timer	FCF/E4	53817
2	110048	knob		53814
3	350162	timer	FCF/E4 (new)	03431
4	n. l. a.	knob		55434

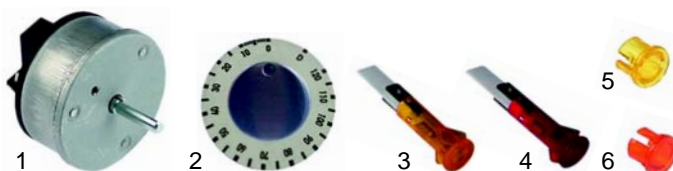

Item	Order	Description	Model	OEM
1	350163	timer	FCF/E4 (240271/2)	05216
2	111688	knob		05210
3	359140	signal element/yellow		05215
4	359138	signal element/red		05214
5	359845	lens/yellow		05211
6	359844	lens/red		05212

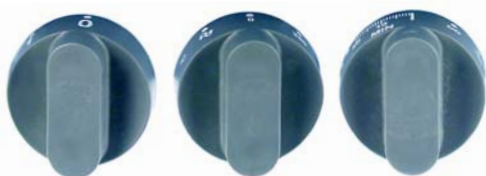

Pos.	Order	Description	Model	OEM
1	111770	knob set (3-piece)	FCF/E4 (new)	06948

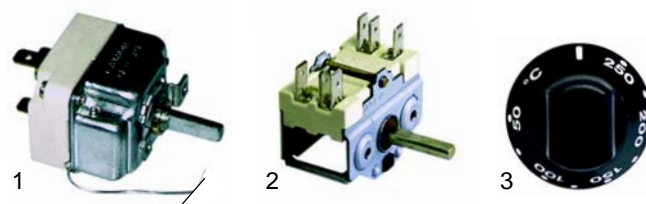

Item	Order	Description	Model	OEM
1	390068	thermostat	FCF/_6, FCF/E2	57937
2	300001	switch		54375
3	110472	knob		54594, 53813

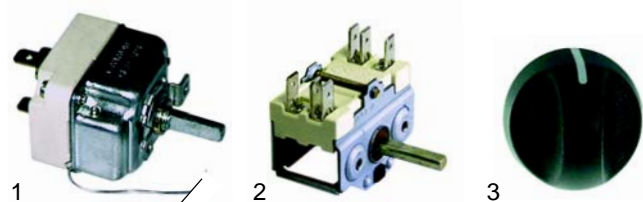

Item	Order	Description	Model	OEM
1	390068	thermostat	FCF/E3 (240270)	57937
2	300001	switch		54375
3	111685	knob		03981

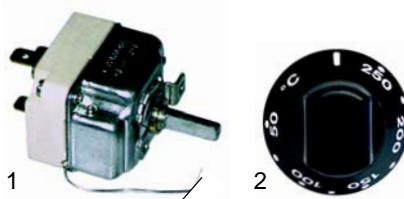

Item	Order	Description	Model	OEM
1	390068	thermostat	FCF/_10,	57937
2	110472	knob	FCF/_20	53813

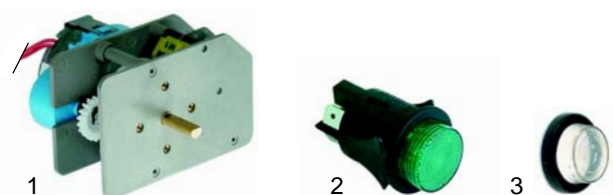

Item	Order	Description	Model	OEM
1	360341	timer	FCF/E3 (240270)	03833
2	345161	switch		54518
3	345039	protecting cover		53979



Item	Order	Description	Model	OEM
1	350008	timer		53817, 03432
2	110048	knob	FCF/E2 (until 91), FCF/_6 (until 91), FCF/_10	53814, 03850
3	380017	energy regulator		53695
4	110473	knob		54595, 53815



Item	Order	Description	Model	OEM
1	350004	timer		55366
2	110475	knob		55434, 55364
3	380015	energy regulator	FCF/E2 (from 91), FCF/_6 (from 91)	55016
4	110473	knob		54595, 53815

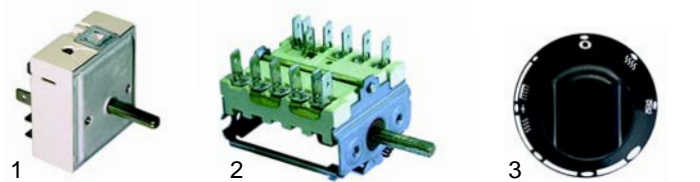

Item	Order	Description	Model	OEM
1	380015	energy regulator		55016
2	301094	switch	FCF/_10 (from 91)	55017
3	110474	knob		55026



Item	Order	Description	Model	OEM
1	345983	switch 0-I		53810
2	346384	switch I-II	FCF/_10 (until91), FCF/_20 (until91)	53837
3	346385	changer switch		54552



Item	Order	Description	Model	OEM
1	346386	switch	FCF/_10 (from 91), FCF/_20 (from 91)	58808
2	345390	switch	FCF/G20, FCF/G40	54547, 55014



Item	Order	Description	Model	OEM
1	359110	signal element/yellow		53811
2	359109	signal element/green	universal	54150
3	359804	lens/yellow		53812
4	359803	lens/green		54151



Item	Order	Description	Model	OEM
1	379060	sensor	FCF/_6, FCFV/_61, FCF/_10	02673
2	379976	sensor	FCF/_102	02821



Item	Order	Description	Model	OEM
1	379061	sensor	FCF/_20 (until039), FCF/_201 (until039), FCF/_202 (until039)	03853
2	379977	sensor	FCF/_20 (from 040), FCF/_201 (from 040), FCF/_202 (from 040)	06174

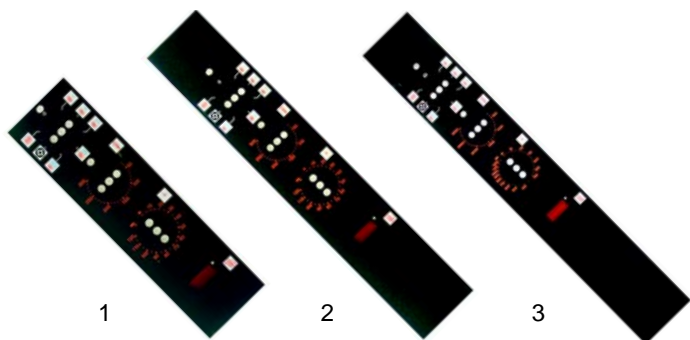

Item	Order	Description	Model	OEM
1	401130	fascia	FCF/_6	03689
2	401131	fascia	FCF/_101, FCF/_102	03714
3	401132	fascia	FCF/_201, FCF/_202	03838

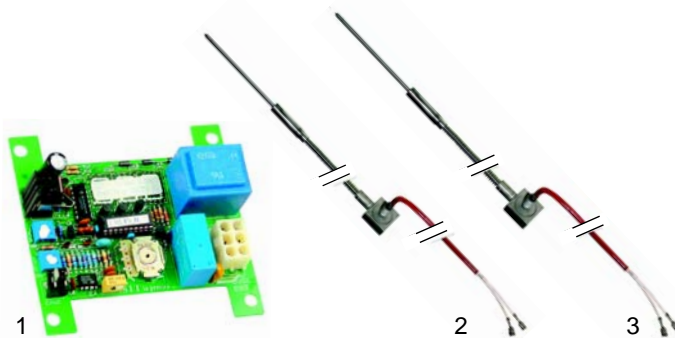

Item	Order	Description	Model	OEM
1	400744	p.c.b.	FCF/_	03763
2	379060	sensor/core temperature	FCF/_101	02673
2	379061	sensor/core temperature	FCF/_201, FCF/_202	03853



Item	Order	Description	Model	OEM
1	111710	knob		02672
2	359139	signal lamp/green	universal	58544
3	359140	signal lamp/yellow		58522

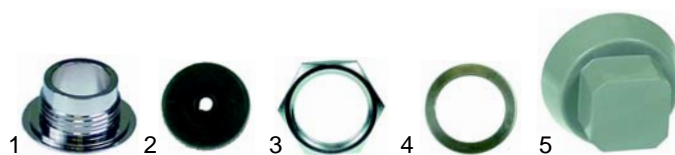

Item	Order	Description	Model	OEM
1	693429	bush		02662
2	693432	gasket		02663
3	693430	nut	FCF/_ (core temperature-electronic controller)	51263
4	693431	disc		02727
5	111773	knob		02671



Item	Order	Description	Model	OEM
1	345651	switch		03766
2	346310	element holder	core temperature Zus- chutz FCF/_	03767
3	346311	button		03768
4	345039	protecting cover		53979

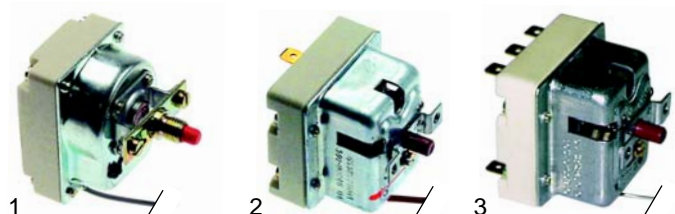

Item	Order	Description	Model	OEM
1	375572	safety thermostat	FCF/G_ (until '97)	53980
2	375579	safety thermostat	FCF/G_ (from '97), FCF/E2 (from '91), FCF/E3	03594
3	375162	safety thermostat	FCF/E2, FCF/E40	58198

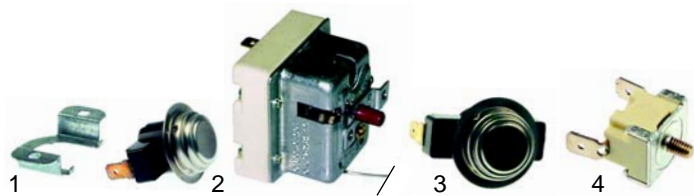

Item	Order	Description	Model	OEM
1	375625	contact thermostat	FCF/E4 (until '97)	54321
2	375170	safety thermostat	FCF/E4 (from '97)	02711
3	375624	safety contact thermostat	FCF/E4 (from '00)	05206
4	375666	contact thermostat		05203



Item	Order	Description	Model	OEM
1	601199	motor		05202
2	601200	fan wheel	FCF/E4 (from '00)	05221
3	418083	3000W/230V		55503

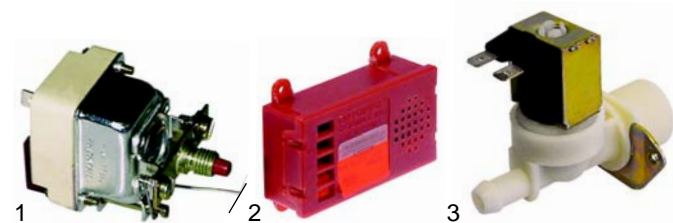

Item	Order	Description	Model	OEM
1	375167	safety thermostat	FCF/E__	02730
2	350070	alarm device		55368
3	373017	solenoid valve	universal	53827, 47533, 55132

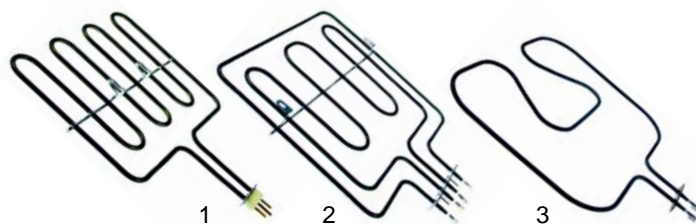

Item	Order	Description	Model	OEM
1	418081	200W/230V	FCF/E4 (until '00)	54326
2	418082	2550W/230V	FCF/E4 (from '00)	05205
3	418078	1000W/230V		05218

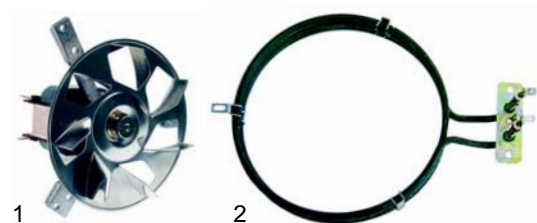

Item	Order	Description	Model	OEM
1	601198	motor/complete	FCF/E2, FCF/E3,	54842
2	415117	2500W/230V	FCF/E2	54317, 54843

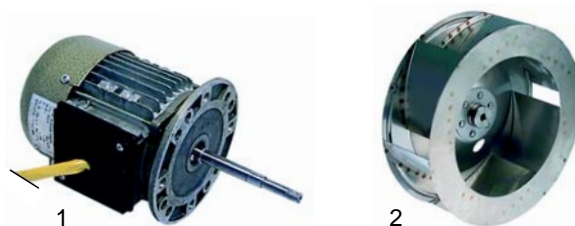

Item	Order	Description	Model	OEM
1	601040	motor		54829, 58587
2	601235	fan wheel	FCF/_6	54585



Item	Order	Description	Model	OEM
1	601201	motor/complete	FCF/E4 (until '00)	54314
2	418083	3000W/230V		55503
3	601004	fan with transverse flow	FCF/E4 (from '00)	05204

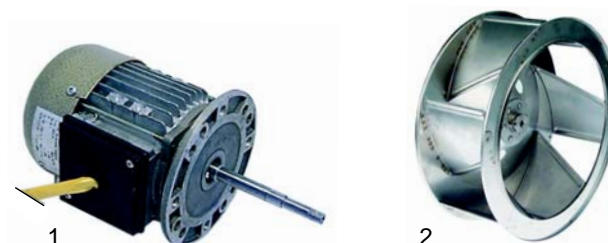

Item	Order	Description	Model	OEM
1	601041	motor		54836, 58667
2	601197	fan wheel	FCF/_10	53782

Z

Suitable for Zanussi

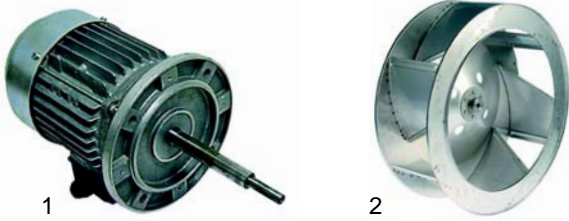

Item	Order	Description	Model	OEM
1	601042	motor	FCF/_20, FCF/_40	54837, 58607
2	601218	fan wheel		54014



Item	Order	Description	Model	OEM
1	500141	motor	FCF/_6 (from '97), FCF/_101, FCF/_201	02616, 0F0007
2	601220	fan wheel	FCF/_6 (from '97)	03560
3	601197	fan wheel	FCF/_101	53782, 54890

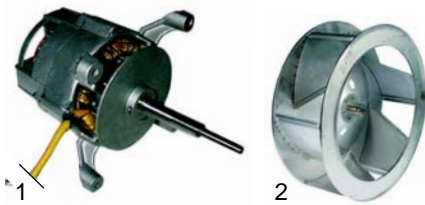

Item	Order	Description	Model	OEM
1	500143	motor	FCF/_102, FCF/202	02739
2	601232	fan wheel		03715

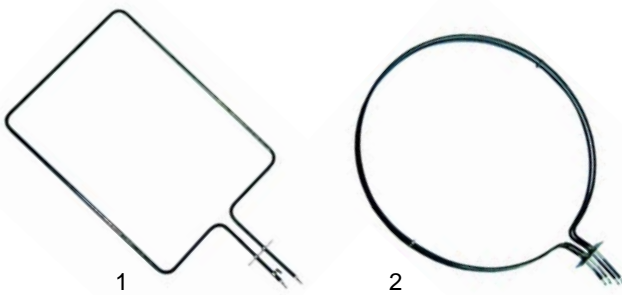

Item	Order	Description	Model	OEM
1	415351	2500W/230V	FCF/E6	54610, 54614, 56945, 58145
2	415389	5566W/230V	FCF/E10	58196, 58197, 53839



Item	Order	Description	Model	OEM
1	415391	8000W/230V	FCF/E20, FCF/E40	54051, 54289, 56929, 56934
2	415654	5660W/230V	FCF/E101, FCF/E201	02688

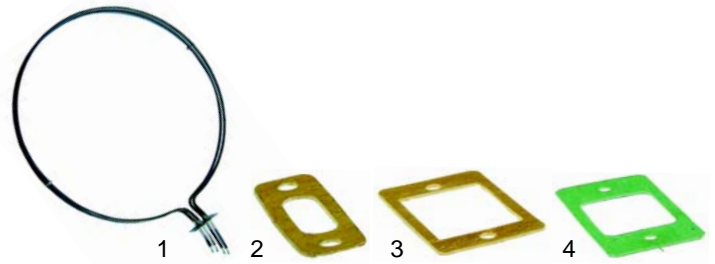

Item	Order	Description	Model	OEM
1	415656	8000W/400V	FCF/E102, FCF/E202	A5330
2	550545	gasket	FCF/E6	57534
3	550546	gasket	FCF/E10, FCF/E20, FCF/E40	53840
4	550547	gasket	FCF/E101	03726



Item	Order	Description	Model	OEM
1	359376	bulb holder		54320
2	359610	bulb, 15W	FCF/E4	54319
3	359377	lens		54318



Item	Order	Description	Model	OEM
1	359375	bulb holder	FCF/E3	03956
2	359612	bulb, 25W		54840

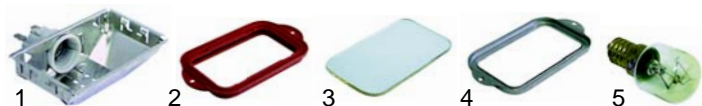

Item	Order	Description	Model	OEM
1	359713	bulb holder		54991
2	359714	gasket		55022
3	359715	glass	FCF/_40	
4	359716	housing		
5	359612	bulb		54840



Item	Order	Description	Model	OEM
1	359765	flange		02628
2	359764	glass	FCF/_6 (from '93), FCF/_101 (from '93),	02627
3	359763	gasket	FCF/_102 (from '93),	02626
4	359612	bulb	FCF/_201 (from '93),	54840
5	359701	bulb holder	FCF/_202 (from '93)	02625

Gas components



Item	Order	Description	Model	OEM
1	105764	burner	FCF/G6	54573
2	105765	burner	FCF/G10	53786



Item	Order	Description	Model	OEM
1	105766	burner	FCF/G20	54028
2	105767	burner	FCF/G40	55007
3	105768	burner	FCF/G6 (from '97)	03677
4	105769	burner	FCF/G101, FCF/G102, FCF/G201	03709
5	105770	burner	FCF/G202	04831



Item	Order	Description	Model	OEM
1	101002	ignition unit		03376, 51884
2	100052	pilot burner	FCF/G6 FCF/G10	57411
3	100051	pilot burner	FCF/G20 FCF/G40 FCF/G6 (from '97) FCF/G101, 102, 202	54032

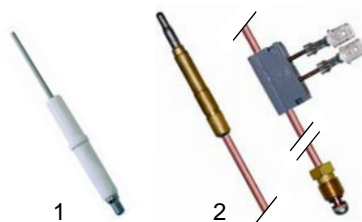

Item	Order	Description	Model	OEM
1	100701	electrode	universal	52610
2	102070	thermocouple		54055

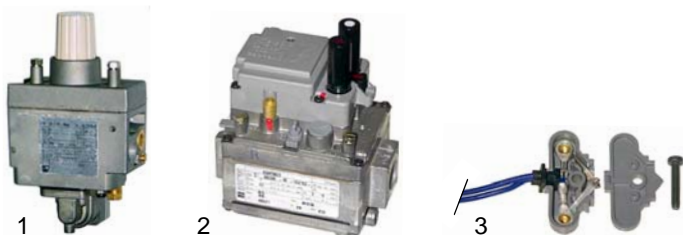

Item	Order	Description	Model	OEM
1	101183	composite valve	FCF/G6 (from '97)	53973
2	101127	Elettrosit gas valve	FCF/G10	57543
3	101312	micro switch	FCF/G20 FCF/G40	54539



Item	Order	Description	Model	OEM
1	101761	Novasit gas valve	FCF/G6 (from '97), FCF/G101, 201, 202	03719
2	101760	Novasit gas valve	FCF/G101	06182
3	111646	knob		03704

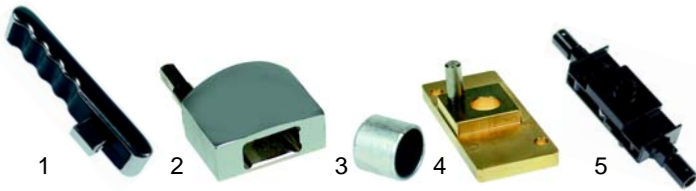

Item	Order	Description	Model	OEM
1	690874	handle		02717
2	700470	holder		03826
3	700471	bearing	FCF/_201 FCF/_202	03994
4	700472	flange		04098
5	700488	gearbox		03824

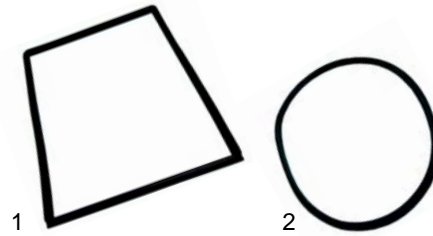

Item	Order	Description	Model	OEM
1	900187	door seal, 585 x 395 mm	FCF/_6 (until '97)	55414
2	900190	window seal		55412

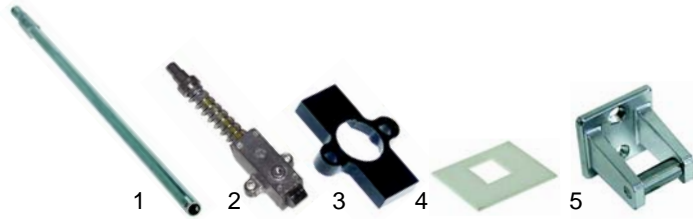

Item	Order	Description	Model	OEM
1	690869	rod		03825
2	690041	ratchet		03822
3	690875	housing	FCF/_201 FCF/_202	04104
4	700491	gasket		03990
5	690040	door catch		04232

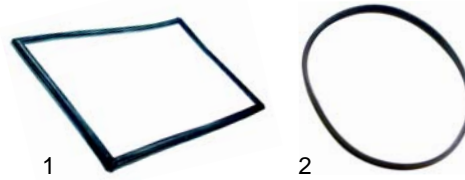

Item	Order	Description	Model	OEM
1	900433	door seal, 635 x 430 mm	FCF/_6 (from '97)	04226, 05713
2	900272	window seal		03680



Item	Order	Description	Model	OEM
1	541090	thermometer	FCF/_ (from '97)	56383
2	541353	thermometer	FCF/_	53808
3	507317	gasket	universal	53809

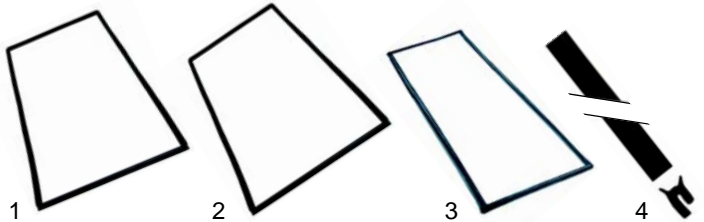

Item	Order	Description	Model	OEM
1	900188	door seal, 640 x 720 mm	FCF/_10 FCF/_20 (from '86)	55315
2	900189	door seal, 645 x 715 mm	FCF/_20 (until '86)	53751
3	900275	door seal, 645 x 1380 mm	FCF/_40	54986
4	900270	window seal	universal	53754, 57866

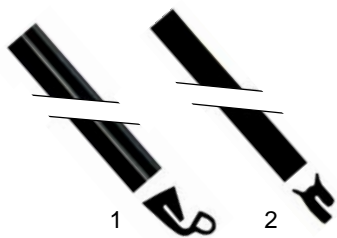

Item	Order	Description	Model	OEM
1	900273	door seal	FCF/E2	54850
2	900270	window seal	FCF/E2/E3/E4	57866

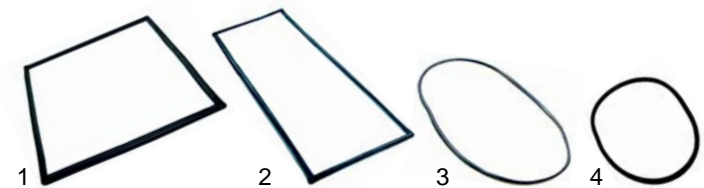

Item	Order	Description	Model	OEM
1	900160	door seal, 660 x 730 mm	FCF/_101 FCF/_102	04227, 05712
2	900434	door seal, 660 x 1395 mm	FCF/_201 FCF/_202	03955, 05711
3	900269	window seal/inner	FCF/_101	03739
4	900186	window seal/outer	FCF/_102 FCF/_201 FCF/_202	02878

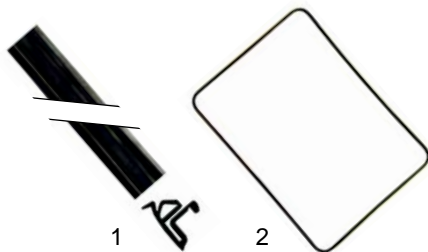

Item	Order	Description	Model	OEM
1	900277	door seal		56341, 05885
2	900279	window seal	FCF/E4 (from '00)	05194

Combination steamers Front screen

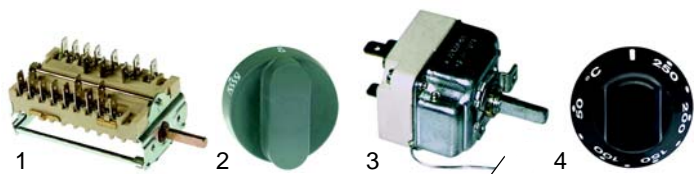

Item	Order	Description	Model	OEM
1	300014	program switch	FCV/_6	55365
2	111761	knob	FCV/_10	55363, 56127
3	390068	thermostat	FCV/_20	57937
4	110472	knob	FCV/_202V	53813



Item	Order	Description	Model	OEM
1	350004	timer	FCV/_6	55366
2	111715	knob	FCV/_10	55434
3	380015	energy regulator	FCV/_20	55016

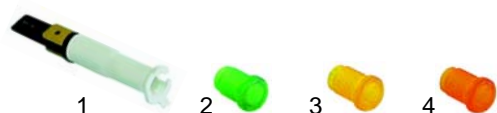

Item	Order	Description	Model	OEM
1	359110	signal element/clear		55811
1	359109	signal element/green	FCV/_6 (until '91)	54150
2	359803	lens green	FCV/_10 (until '91)	54151
3	359804	lens yellow	FCV/_20 (until '91)	53812
4	359805	lens red	FCV/_202V (until '91)	75589



Item	Order	Description	Model	OEM
1	359139	signal lamp/green	FCV/_6 (from '91)	58544
2	359140	signal lamp/yellow	FCV/_10 (from '91)	58522
3	359138	signal lamp/red	FCV/_20 (from '91)	58605



Item	Order	Description	Model	OEM
1	301093	program switch		56674
2	300020	core temperature switch	FCV/E_CE	28390
3	111762	gasket		56500
4	111763	knob		56503

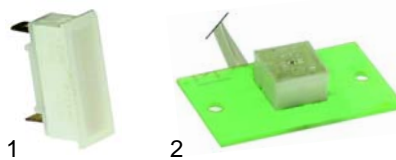

Item	Order	Description	Model	OEM
1	359842	signal lamp	FCV/E_CE	56501
2	359843	push button		56504



Item	Order	Description	Model	OEM
1	400026	display p.c.b.		58673
2	400025	core temperature p.c.b.	FCV/E_CE	58674
3	379107	sensor		58669

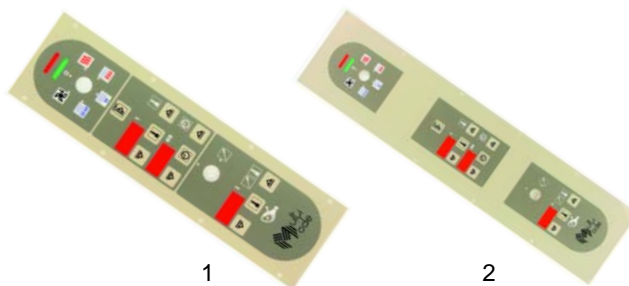

Item	Order	Description	Model	OEM
1	401210	fascia	FCV/E6-3CE	56673
2	401215	fascia	FCV/E10-3CE FCV/E20-3CE	56680

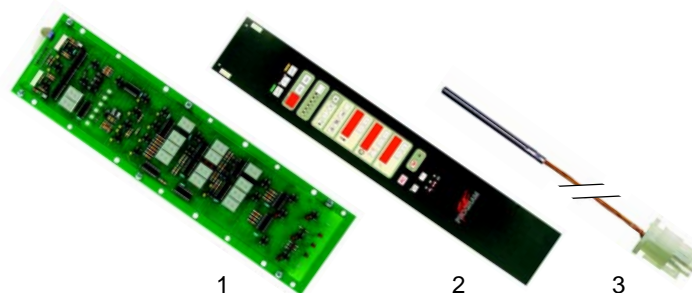

Item	Order	Description	Model	OEM
1	401253	p.c.b.		59000
2	401217	fascia	FCV/_10-P FCV/E20-P	59288
3	379107	sensor		58669

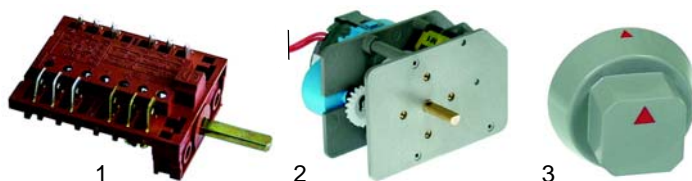

Item	Order	Description	Model	OEM
1	300068	program switch		02661
2	360341	timer	FCV/_-L2/L3	03833
3	111710	knob		02672

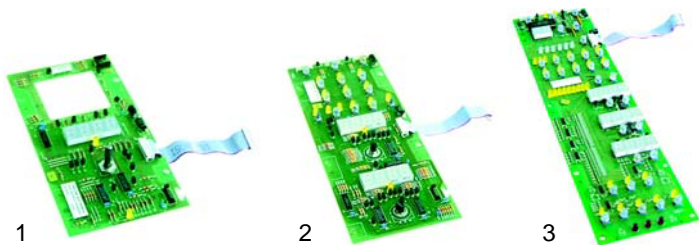

Item	Order	Description	Model	OEM
1	400179	p.c.b. L3	FCV/___L2/L3	02665
2	400188	p.c.b. L4	FCV/___L4	02725
3	400184	p.c.b. L6	FCV/___L6	02720

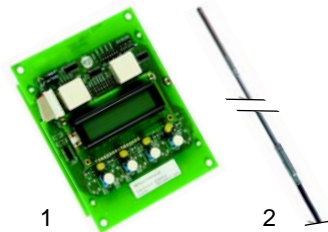

Item	Order	Description	Model	OEM
1	401268	p.c.b.	Active Line	06518
2	379100	sensor	universal	02615

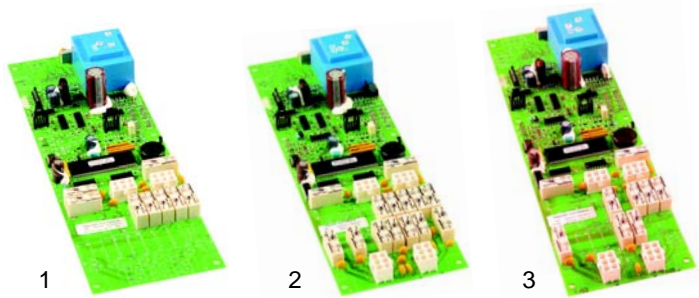

Item	Order	Description	Model	OEM
1	400745	p.c.b.	L2/L3	02684, 06715
2	400746	p.c.b.	L4/L6/L4 boiler/ L6 boiler	04079, 06517, 03546
3	400748	p.c.b.	L3 boiler	04105, 06716

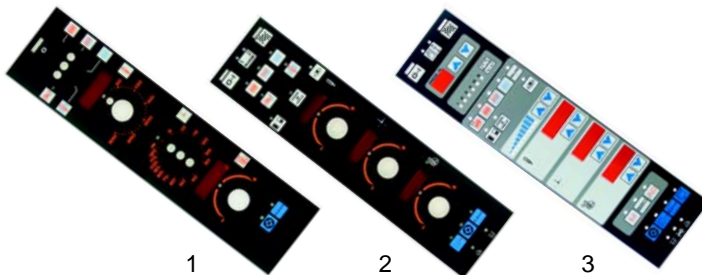

Item	Order	Description	Model	OEM
1	401212	fascia	FCV/___6-L3	03834
2	401213	fascia	FCV/___6-L4	03664
3	401249	fascia	FCV/___6-L6	05623



Item	Order	Description	Model	OEM
1	401292	p.c.b. core temperature	FCV/___L2	02683
1	400187	p.c.b. core temperature		02666
2	693430	nut		51263
3	693431	disc	FCV/___L3	02727
4	693429	bush	FCV/___L4	02662
5	693432	gasket		02663
6	111773	knob		02671

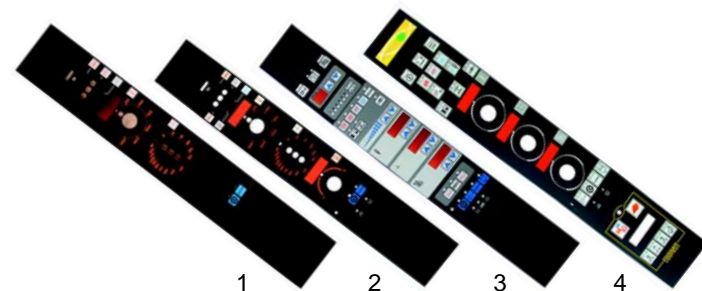

Item	Order	Description	Model	OEM
1	401216	fascia	FCV/___10-L2	03835
2	401250	fascia	FCV/___10-L3/L4/ L6	03832
3	401247	fascia		02719
4	401251	fascia	FCV/___10-(Active)	06529



Item	Order	Description	Model	OEM
1	400997	push button		02670
2	346287	switch		02418
3	345751	switch with push button	universal	05138
4	345753	push button		05137
5	345754	protecting cover		05109

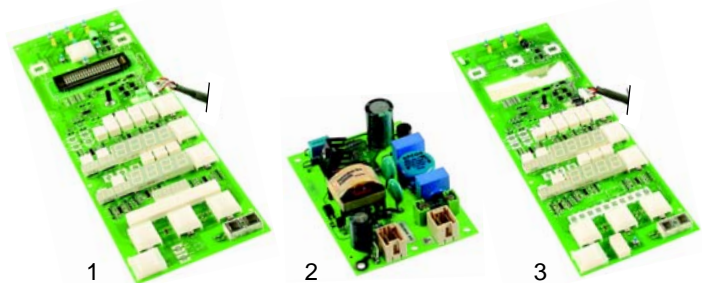

Item	Order	Description	Model	OEM
1	400747	p.c.b. display Level A	AOS/___/_A	0C0043
2	400751	p.c.b. Level A		07047
3	400749	p.c.b. Level B	AOS/___/_B	0C0041

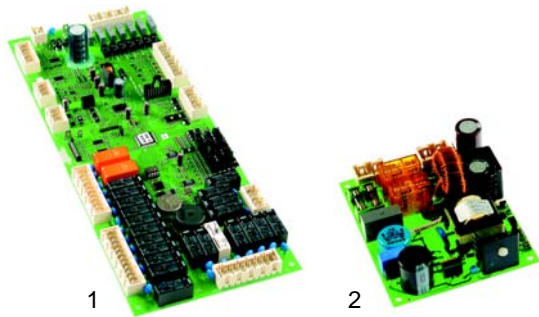

Item	Order	Description	Model	OEM
1	400750	p.c.b.	AOS___/_A AOS___/_B	0C0042
2	400752	p.c.b.	AOS___/_G_	0C1071

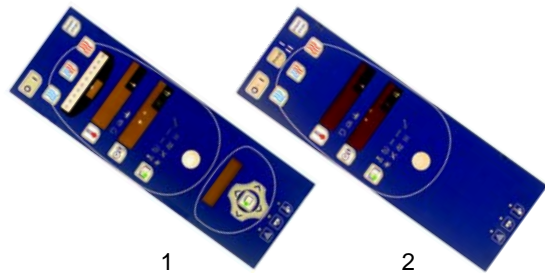

Item	Order	Description	Model	OEM
1	401211	fascia	AOS___/_A	07057
2	401214	fascia	AOS___/_B	07058



Item	Order	Description	Model	OEM
1	693431	disc	AOS___/_	02727
2	693429	bush		02662
3	693430	nut		51263
4	111764	knob		07044

Core temperature



Item	Order	Description	Model	OEM
1	301142	switch core temperature	FCV/___6	55473
2	111765	knob	FCV/___10 FCV/___20	55474
3	400190	electronics	FCV/___202V	55471

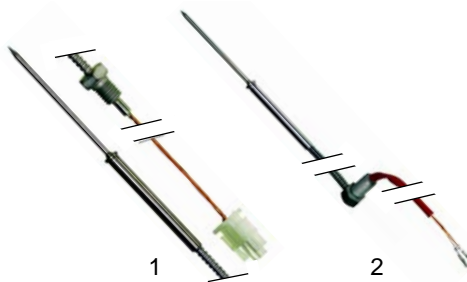

Item	Order	Description	Model	OEM
1	379095	sensor	FCV/___6 FCV/___10 (until '91) FCV/___20 FCV/___20-P	55472
2	379037	sensor	FCV/___10 (until '91) FCV/___20-P	59002
3	379961	sensor	FCV/___202V FCV/___202-P	58199 02330

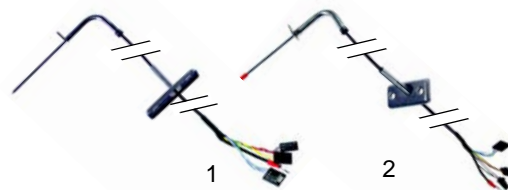

Item	Order	Description	Model	OEM
1	379969	sensor (multipoint)	AOS061GA (from No. 340)	0C1164
2	379960	sensor (multipoint)	AOS101GA (from Nr.340)	0C0956

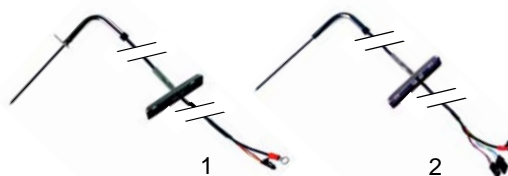

Item	Order	Description	Model	OEM
1	379968	sensor (single point)	AOS201GA	0C1146
2	379970	sensor (multipoint)	AOS202GA AOS202EA	0C1404

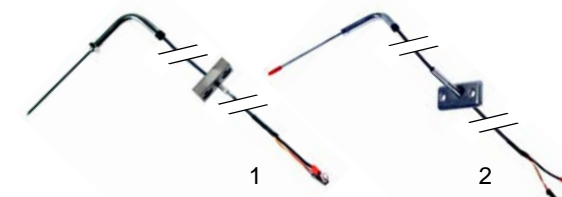

Item	Order	Description	Model	OEM
1	379967	sensor (single point)	AOS201GB	0C0225
2	379959	sensor (single point)	AOS202GB AOS202EB	0C1383

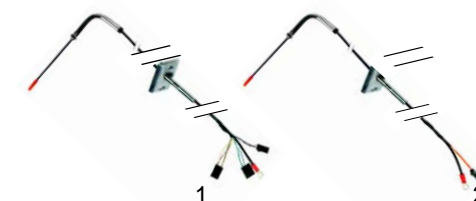

Item	Order	Description	Model	OEM
1	379956	sensor (multipoint)	AOS061GA (until No. 339) AOS061EA AOS101GA (until No. 339)	006982
2	379958	sensor (single point)	AOS061EB	006983

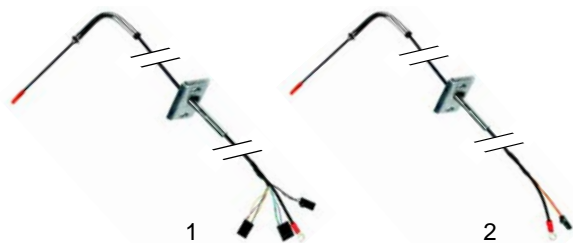

Item	Order	Description	Model	OEM
1	379955	sensor (multipoint)	AOS101EA AOS201EA	007109
2	379957	sensor (single point)	AOS101EB AOS201EB	007063

Door switch



Item	Order	Description	Model	OEM
1	346376	magnetic switch	FCV/_6 (until 10/89)	26468
2	345254	micro switch	FCV/_10 (until 10/90) FCV/_20 (until 10/90)	54550 53671

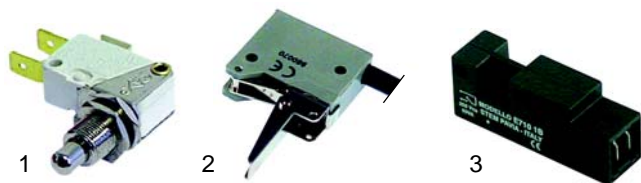

Item	Order	Description	Model	OEM
1	345032	micro switch	FCV/_6 (from 10/89) FCV/_10 (from 10/90) FCV/_61, FCV/_101, FCV/_201, FCV/_202	46063
2	346387	micro switch	FCV/_20 (until 4/90)	56944
3	345821	magnetic switch	AOS___/___	49621

Level control



Item	Order	Description	Model	OEM
1	400018	level regulator	universal	56496, 55458
2	400120	electrode 94,5mm	FCV/G6	56449
3	400121	electrode 114,5mm	FCV/G6, FCV/E6 (until 10/91), FCV/_10 (until 10/90) FCV/_20 (until 10/90)	55346



Item	Order	Description	Model	OEM
1	401258	electrode 109mm	FCV/_10 (from 10/90) FCV/_20 (from 10/90)	12838
2	401259	electrode 143mm	FCV/G10 (from 10/90) FCV/G20 FCV/EG (from 10/91) FCV/EG202V	53909

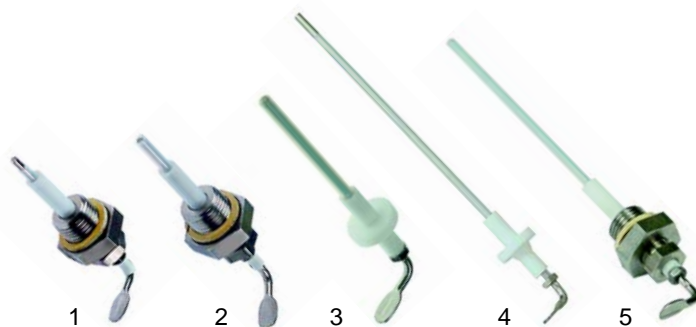

Item	Order	Description	Model	OEM
1	401255	electrode 50mm	FCV/G61	05765
2	401254	electrode 60mm		05766
3	401260	electrode 50mm	FCV/G101/G102 FCV/G201-G202	02632
4	400124	electrode old	FCV/E61	02694
5	401261	electrode new 100mm	FCV/E101-G102 FCV/E201-E202	03878



Item	Order	Description	Model	OEM
1	401355	electrode, 50mm	AOS61G__	0C1086
2	401262	electrode, 147mm	AOS101G__ AOS102G__	0C1055
3	401263	electrode, 210mm	AOS6201G__ AOS202G__	0C1105

Z

Suitable for Zanussi



Item	Order	Description	Model	OEM
1	401264	electrode	AOS61E_ AOS101E_	07033
2	401345	electrode	AOS201E_	0C1201
3	401265	electrode	AOS6202E_	05879

Electrical components

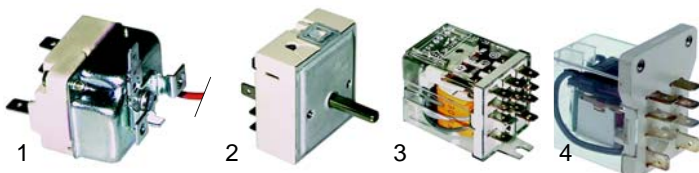

Item	Order	Description	Model	OEM
1	375113	thermostat 55 C	FCV/_	55367
2	380015	energy regulator		55016
3	380312	relay	FCV/_	56466
4	380315	relay	FCV/_10 (until 10/90)	46001



Item	Order	Description	Model	OEM
1	375278	safety thermostat 140 C		56745
2	375113	thermostat	FCV/_	56671
3	350070	alarm device		55368

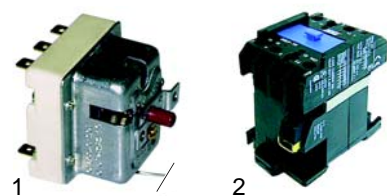

Item	Order	Description	Model	OEM
1	375162	safety thermostat 340 C	FCV/_D	58222
2	380204	contactor	universal	75796

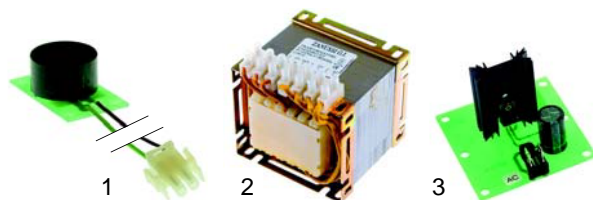

Item	Order	Description	Model	OEM
1	350085	alarm device		59001
2	401266	transformer	FCV/_10-P	56512
3	401343	p.c.b.		59033

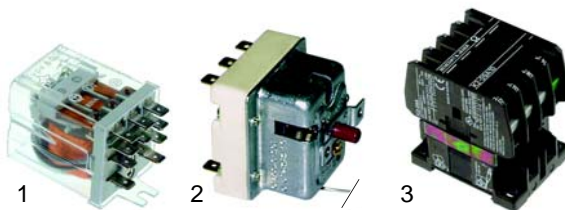

Item	Order	Description	Model	OEM
1	380636	relay 24V		56510
2	375209	safety thermostat 140 C	FCV/_10-P	59079
3	380665	contactor		58670

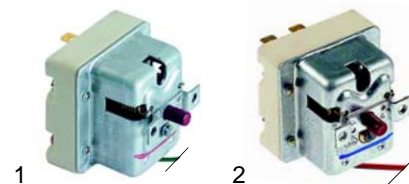

Item	Order	Description	Model	OEM
1	375659	safety thermostat 338 C	AOS_	07042
2	375657	safety thermostat 150 C	AOS_G-	0C1147

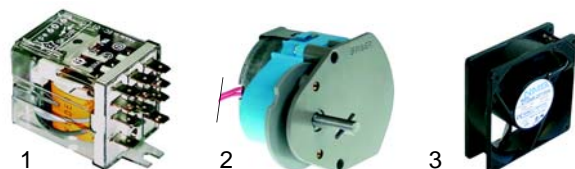

Item	Order	Description	Model	OEM
1	380312	relay	AOS_	058857
2	360342	motor + gearbox	AOS_	0C0883
3	601080	fan	AOS_	002656

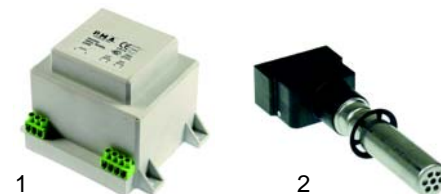

Item	Order	Description	Model	OEM
1	401267	transformer	AOS_	007045
2	379966	sensor	AOS_	006995



Item	Order	Description	Model	OEM
1	359713	bulb housing	FCV/	54991
2	359714	gasket		55022
3	359612	bulb		54840



Item	Order	Description	Model	OEM
1	359765	flange	FCV/_, AOS/_	02628
2	359764	glass		02627
3	359763	gasket		02626
4	359599	lamp		02956, 07056

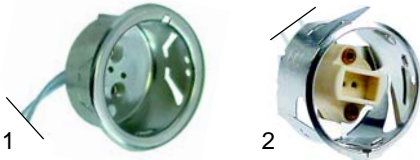

Item	Order	Description	Model	OEM
1	359762	lamp holder	FCV	02709, 06106
2	359841	lamp holder	AOS	07105

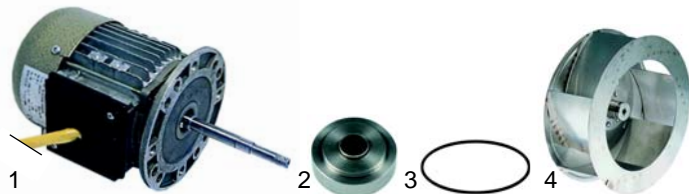

Item	Order	Description	Model	OEM
1	601040	motor	FCV/_6	54829, 58587
2	693410	sealing ring		55339
3	693404	gasket		55371
4	601220	fan wheel 280mm		55422

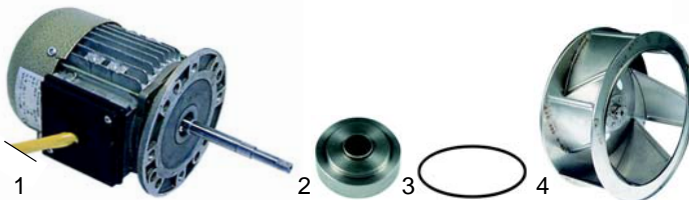

Item	Order	Description	Model	OEM
1	601041	motor	FCV/_202V, FCV/_10	54836, 58667
1	500815	motor	FCV/_10-P, FCV/_202V-P	58994
2	693410	sealing ring	FCV/_10, FCV/_10-P	55339
3	693404	gasket		55371
4	601197	fan wheel 350mm		54890

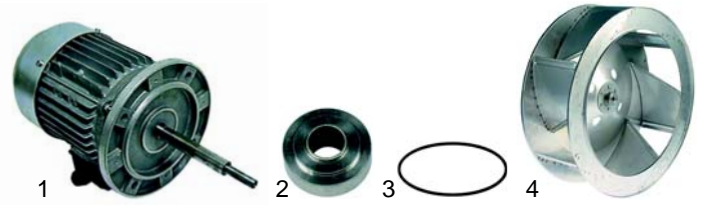

Item	Order	Description	Model	OEM
1	601042	motor	FCV/_20	54837, 58607
2	693411	sealing ring		55377
3	693404	gasket		55371
3	601218	fan wheel 440mm		55378



Item	Order	Description	Model	OEM
1	500141	motor/ 1 turns No.	FCV/_6L3, FCV/_10L2-3, FCV/_201-L3, FCV/_20L3	02616, 0F0007
1	500142	motor/ 2 turns No.	FCV/_6L4, FCV/_10L6, FCV/_101 Activ	02698
1	500814	motor/1 turns No.	FCV/_61L3-4	05750
1	500653	motor/2 turns No.	FCV/_61L6	05748
1	500654	motor/2 turns No.	FCV/_20L6, FCV/_201 Active	05028
2	511301	bearing	universal	02699
3	511300	ring		02873
4	601220	fan wheel 280mm	FCV/_6, FCV/_61	02754
5	601197	fan wheel 350mm	FCV/_10, FCV/_101, FCV/_201, FCV/_20	02617



Item	Order	Description	Model	OEM
1	500143	motor/1 turns No.	FCV/_102 L3, FCV/_202 L3	02739
1	500144	motor/2 turns No.	FCV/_102 L6, FCV/_102 Active, FCV/_202 L6, FCV/_202 Active	02748, 05237
2	511301	bearing	FCV/_102, FCV/_202	02699
3	511300	ring		02873
4	601218	fan wheel		02740



Item	Order	Description	Model	OEM
1	601222	motor	AOS061/_	006998
2	511301	bearing	AOS101/_	002699
3	511300	ring	AOS201/_	002873
4	601236	fan wheel 280mm	AOS061/_	007000
5	601233	fan wheel 350mm	AOS101/_	OC1129



Item	Order	Description	Model	OEM
1	500816	motor		OC1171
2	511301	bearing	AOS202/_	02699
3	511300	ring		02873
4	601234	fan wheel 380mm		OC1172

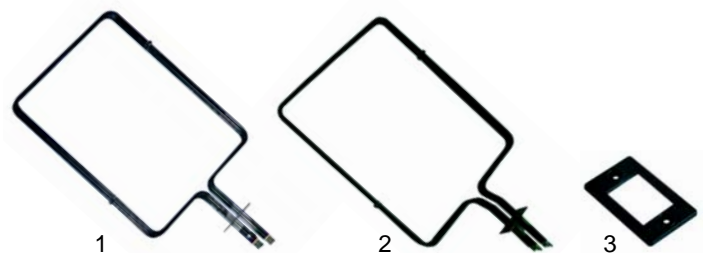

Item	Order	Description	Model	OEM
1	415368	3750W/3 phases 230V	FCV/E6	55439, 55462, 55930, 55949
2	415657	4500W/3 phases 230V	FCV/E6 (from '99)	02757
3	550256	gasket	FCV/E6	55327

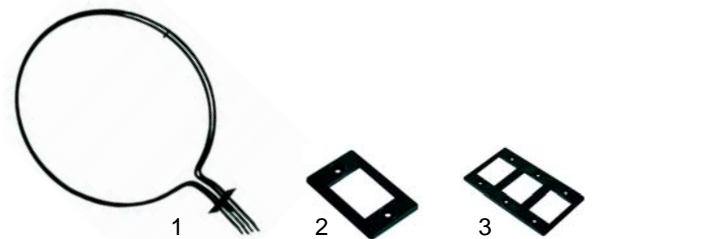

Item	Order	Description	Model	OEM
1	415389	5566W/2 phases 230V	FCV/E10	58196, 58197, 53839, 54620
1	415654	5666W/2 phases 230V	FCV/E10 (from '99), FCV/E20 (from '99)	02688
2	550256	gasket	FCV/E10	55327
3	550257	gasket	FCV/E10 (from '99), FCV/E20 (from '99)	02689

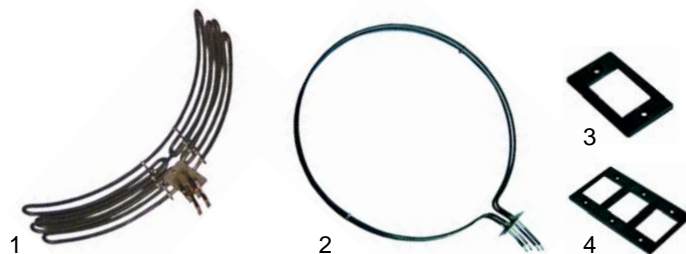

Item	Order	Description	Model	OEM
1	415391	8000W/2 phases 230V	FCV/E20 (until '88)	56929, 54050, 54051
1	415393	8000W/2 phases 400V	FCV/E20 (from '88)	55481, 56970
2	415656	8000W/2 phases 400V	FCV/E102, FCV/E202	A5330
3	550256	gasket	FCV/E20	55327
4	550257	gasket	FCV/E201, FCV/E202	A2689

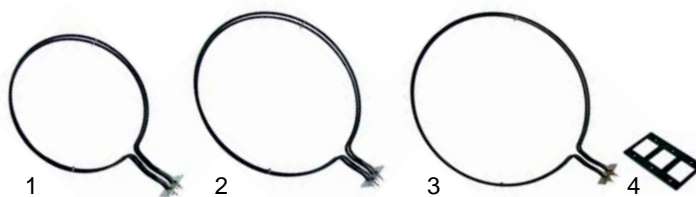

Item	Order	Description	Model	OEM
1	418150	3200W/400V	AOS061E	006984
2	418151	5670W/400V	AOS101E, AOS201E	007064
3	418152	8000W/400V	AOS202E	OC1173
4	550257	gasket	AOS_E	002689

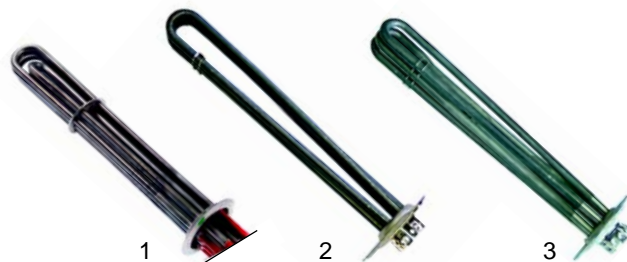

Item	Order	Bschrbg.	Model	OEM
1	418188	7500W/230V	FCV/E-6 (until '91)	56011, 55463
2	415394	7900W/230V	FCV/E-6 (von '91 bis '99)	58666, 58604
3	415690	9000W/230V	FCV/E-6 (from '99), FCV/E10 (von '91 bis '99)	02835, 58672

Equipment with pilot burner



Item	Order	Description	Model	OEM
1	418156	17000W/240V	FCV/E10 (until '91)	56012, 55464
2	415063	17000W/240V	FCV/E10 (from '99), FCV/E101	58995
3	415809	24000W/400V	FCV/E20 (until '00)	56013, 55466
4	415652	24000W/400V	FCV/E102, FCV/E20 (from '00), FCV/E201, FCV/E202	02751
5	510408	gasket		46213



Item	Order	Description	Model	OEM
1	418153	9000W/400V	AOS61E	007030
2	418154	17000W/400V	AOS101E	007076
3	418155	24000W/400V	AOS201E, AOS202E	007101
4	510409	gasket		007029

Components (gas)

no longer available

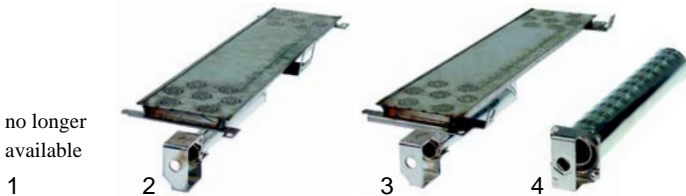

Item	Order	Description	Model	OEM
1	n. l. a.	burner (hot air)	FCV/G6 (until '91)	56450
2	105814	burner (hot air)	FCV/G6 (von '91 bis '99)	02126
3	105813	burner (hot air)	FCV/G6 (from '99)	02857
4	105784	burner (steam)	FCV/G6	56451



Item	Order	Description	Model	OEM
1	105767	burner (hot air + steam)	FCV/G10	55007
2	105786	burner (hot air)	FCV/G20	55487
3	105785	burner (steam)	FCV/G20	55486

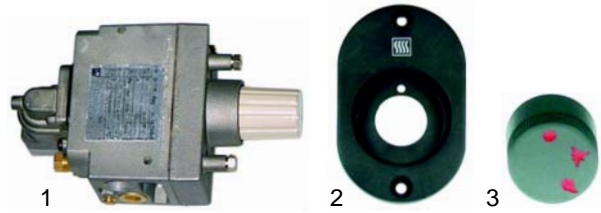

Item	Order	Description	Model	OEM
1	101183	composite valve	FCV/G6	53973
2	111766	panel		55454
3	111767	knob		56452



Item	Order	Description	Model	OEM
1	345038	ignition switches	FCV/G6 (until '99)	53978
2	345039	protecting cover		53979
3	100009	piezoelectric igniter	FCV/G6 (from '99)	59251
4	100012	piezoelectric igniter		02605



Item	Order	Description	Model	OEM
1	101162	Novasit gas valve		55446
2	111766	panel	FCV/G10, FCV/G20	55454
3	111768	knob		55447
4	101312	micro switch		54539

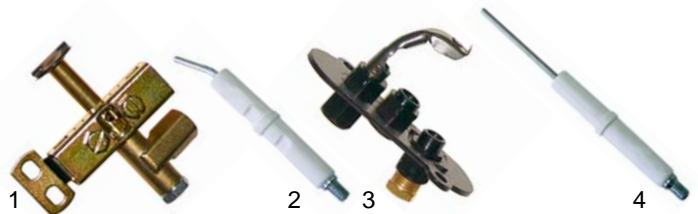

Item	Order	Description	Model	OEM
1	100046	pilot burner	FCV/G6, FCV/G10, FCV/G20	50813
2	100706	electrode		56754
3	100050	pilot burner	FCV/G6 (from '94) - only hot air	59379
4	100701	electrode		59380

Z

Suitable for Zanussi

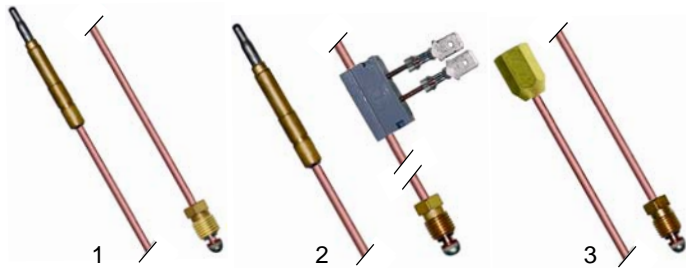

Item	Order	Description	Model	OEM
1	102044	thermocouple, 1200mm	FCV/G6,	20094
2	102070	thermocouple, 1000mm, with break	FCV/G10, FCV/G20	54055
3	102265	thermocouple extension, 500mm	FCV/G10, FCV/G20	55032



Item	Order	Description	Model	OEM
1	102359	electrode	FCV/G6	02343
2	102360	electrode		02344
3	102361	electrode	FCV/G6, FCV/10, FCV/G102	02637
4	102175	electrode	FCV/G10, FCV/G101, FCV/G102	02638
5	102362	electrode	FCV/G201, FCV/G20, FCV/G202	0H6803

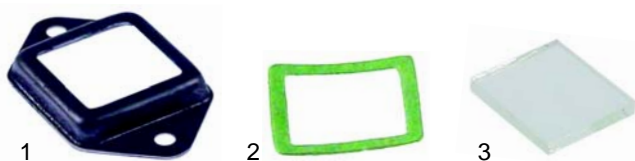

Item	Order	Description	Model	OEM
1	693398	housing	FCV/G6, FCV/G10, FCV/G20	57382
2	693396	gasket		57402
3	693397	glass		57400

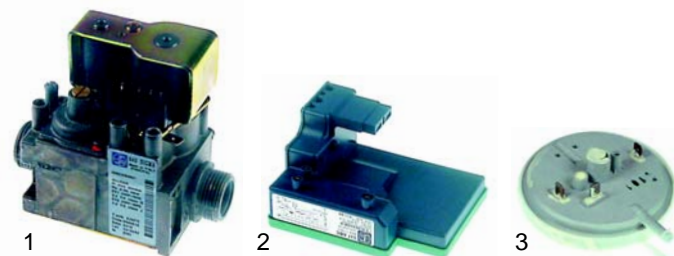

Item	Order	Description	Model	OEM
1	101989	valve		05757
2	101990	ignition control module	FCV/G61 (until No. 021)	05908
3	541352	pressure switch		05746

Equipment with ignition control module



Item	Order	Description	Model	OEM
1	101189	tandem valve 830	FCV/G6, FCV/G10, FCV/G101, FCV/G102, FCV/201, FCV/G20, FCV/G202	02340
2	101984	tandem valve 836		02714
3	101379	solenoid coil		02452
4	401257	plug + rectifier		02715

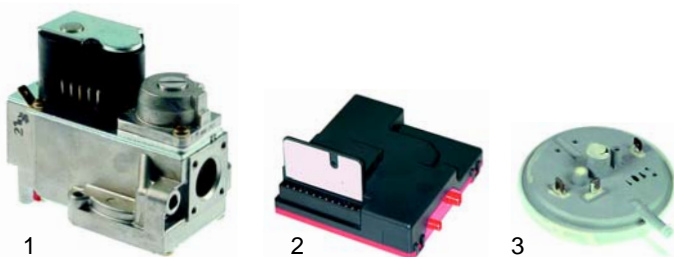

Item	Order	Description	Model	OEM
1	106007	valve	FCV/G61 (from Nr. 022), FCV/G201 (level 3), FCV/G202 (level 3)	05925
2	101184	ignition control module		05924
3	541352	pressure switch		05746



Item	Order	Description	Model	OEM
1	101165	ignition control module	FCV/G6	02351
2	102347	ignition control module	FCV/G10, FCV/G101, FCV/G102, FCV/201, FCV/G20, FCV/G202	02641
3	541075	pressure switch		03772

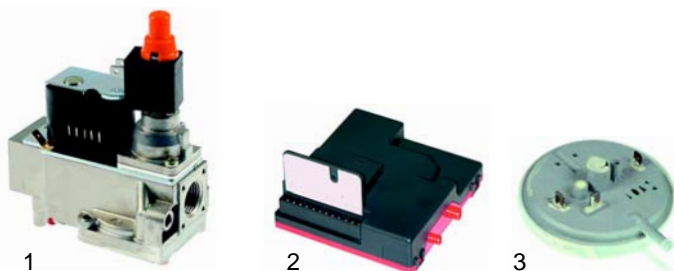

Item	Order	Description	Model	OEM
1	106008	valve	FCV/G201 (Level 4), FCV/G202	06596
2	101184	ignition control module		05924
3	541352	pressure switch		05746

Z

Suitable for Zanussi

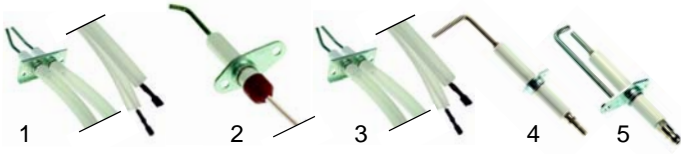

Item	Order	Description	Model	OEM
1	102348	electrode		05910
2	102349	electrode	FCV/G61	05920
3	102350	electrode		05911
4	102175	electrode	FCV/G201, FCV/G202	02638
5	102362	electrode		0H6803

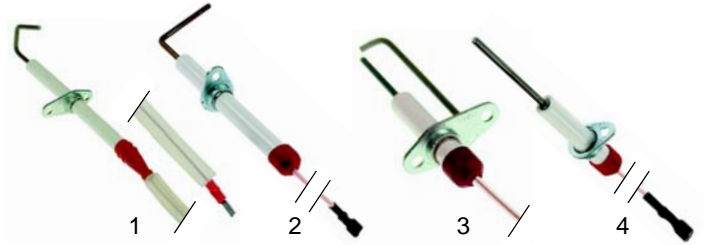

Item	Order	Description	Model	OEM
1	102351	electrode (boiler)		0C1137
2	102344	electrode (boiler)	AOS_G	0C1068
3	102352	electrode (hot air)		0C1134
4	102345	electrode (hot air)		0C1049



Item	Order	Description	Model	OEM
1	541078	pressure switch	universal	02635
2	601237	fan motor	FCV/G61	05745
3	601238	fan motor	all FCV-types (except G61)	02639

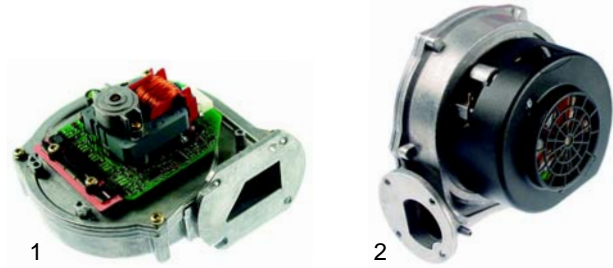

Item	Order	Description	Model	OEM
1	500818	fan motor	AOS061G, AOS101G	0C1051
2	500817	fan motor	AOS201G (hot air)	0C1112

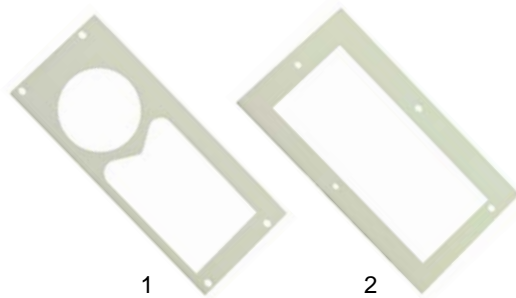

Item	Order	Description	Model	OEM
1	693402	insulator-boiler	all FCV-devices (except FCV/G61)	02706
2	693403	Insulator-hot air fan		03874

Components (water)

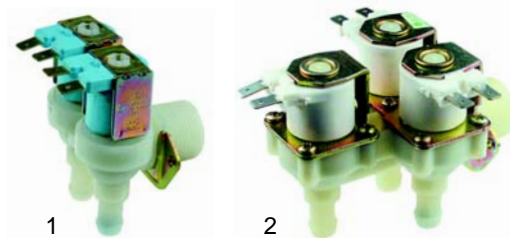

Item	Order	Description	Model	OEM
1	370343	solenoid valve (double) with reducer	FCV/G6, FCV/G10, FCV/G20	55444
2	370346	solenoid valve (triple) with reducer	FCV/G10--D, FCV/G20--D	58208

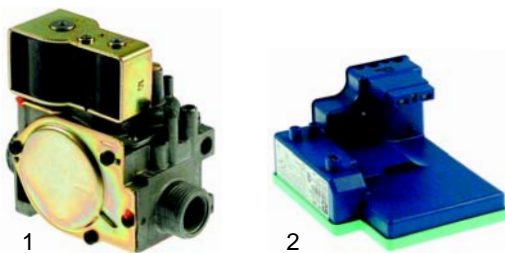

Item	Order	Description	Model	OEM
1	106009	valve	AOS_G	0C1057
2	102346	ignition control module		0C1059

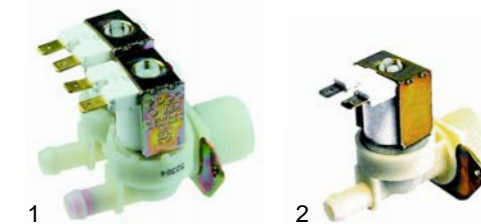

Item	Order	Description	Model	OEM
1	370342	solenoid valve (double) with reducer	FCV/G10ISG	47579
2	370017	solenoid valve (single) extinction		55132



Item	Order	Description	Model	OEM
1	370347	solenoid valve, 24 V (triple) with reducer	FCV/G10-P, FCV/E10-P, FCV/E20-P, FCV/E202-P	A2415 58996
2	370029	solenoid valve, 24 V (single)		

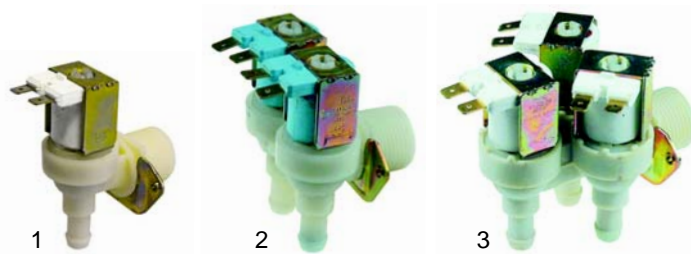

Item	Order	Description	Model	OEM
1	370015	solenoid valve (single)	FCV/_61L3-6	02613
2	370343	solenoid valve (double) with reducer	FCV/_61L3	55444
3	370344	solenoid valve (triple) with reducer	FCV/61L4-6	02712



Item	Order	Description	Model	OEM
1	370339	solenoid valve (single) with reducer	FCV/E6, FCV/E10 (until '91), FCV/E20 (until '91)	55350
2	370343	solenoid valve (double) with reducer	FCV/E10 (from '91), FCV/E20 (from '91), FCV/E202V	55444
3	370017	solenoid valve (single)	FCV/E202V	55132

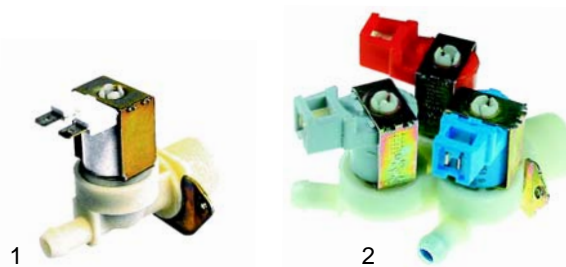

Item	Order	Description	Model	OEM
1	370017	solenoid valve (single)	AOS61_, AOS101_, AOS201_, AOS202_	55132 02859
2	370345	solenoid valve (triple) with reducer		

Cleaning

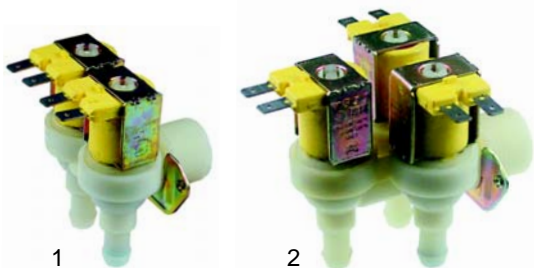

Item	Order	Description	Model	OEM
1	370340	solenoid valve, 24 V (double) with reducer	FCV/E6-3CE	56513
2	370347	solenoid valve, 24 V (triple) with reducer	FCV/E10-3CE, FCV/E20-3CE	A2415



Item	Order	Description	Model	OEM
1	370348	solenoid valve, 1/2"	AOS61_, AOS101_	07015
2	370356	solenoid valve, 3/4"	AOS201_, AOS202_	0C1121
3	500566	magnetic-drive pump	universal	07018, 0C2341



Item	Order	Description	Model	OEM
1	370341	solenoid valve (single) with reducer	FCV/G6L3, FCV/E6L4	02753
2	370342	solenoid valve (double) with reducer	FCV/G6L3/4, FCV/G61L3/L4, FCV/G10L2, FCV/E10L2	47579
3	370345	solenoid valve (triple) with reducer	FCV/G6L4	02859, 0C1934

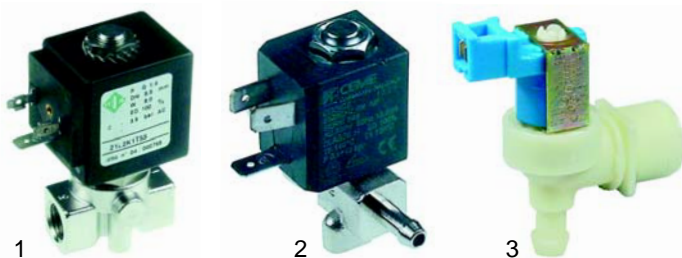

Item	Order	Description	Model	OEM
1	370349	solenoid valve	AOS61_, AOS101_	07016 07017
2	370350	solenoid valve		
3	370355	solenoid valve	AOS201_, AOS202_	0C1133, 0C1933

Z

Suitable for Zanussi

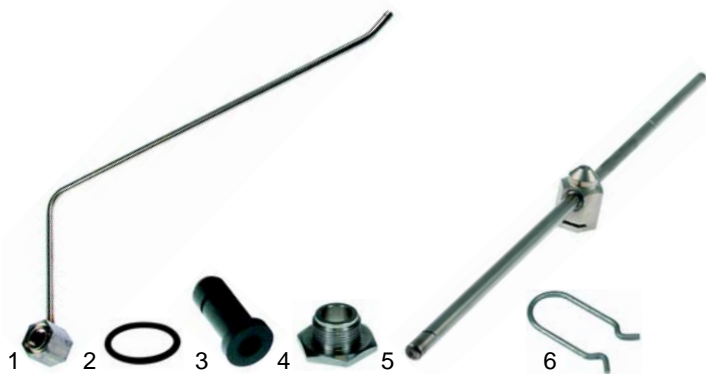

Item	Order	Description	Model	OEM
1	693405	holder		07009
2	532506	gasket		07074
3	693406	water pin	AOS61_	07025
4	693407	bush	AOS101_	07024
5	693408	wash arm	AOS201_	07010
6	693409	spring	AOS202	07026



Item	Order	Description	Model	OEM
1	400112	exhaust valve (electrical), 3/4"	FCV/_10-P, FCV/Level6	59004, 02713
2	401140	exhaust valve (electrical), 1"	box devices, FCV/_	05026
3	401139	exhaust valve (electrical) 3/4"	AOS_	0C882

Components (mechanical)



Item	Order	Description	Model	OEM	
1	540977	drain tap	FCV/_	56114	
2	514066	extension	FCV/G_	FCV/E (until '91)	56116
3	514067	extension	FCV/E (from '91)	56567	

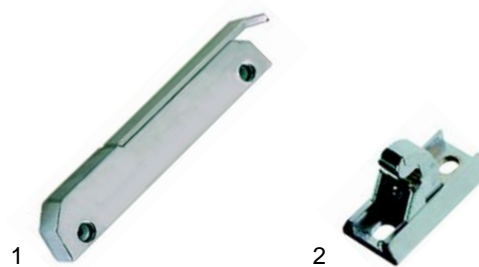

Item	Order	Description	Model	OEM
1	700081	door handle	FCV/6	56459
2	700082	door catch		56464

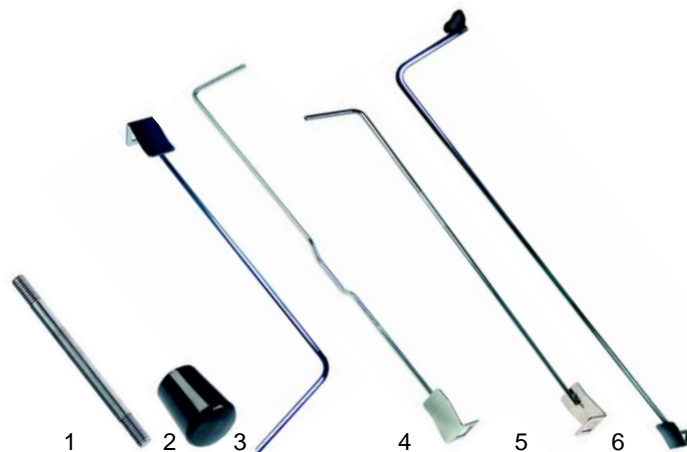

Item	Order	Description	Model	OEM
1	514324	lever	FCV/_	55352
2	514322	handle		29898
3	514069	lever	FCV/G6 (from 99)	02881
4	514072	lever	FCV/E6 (from 99)	02880
5	514070	lever	FCV/_061	05770
6	514068	lever	FCV/_10, FCV/_201	02883

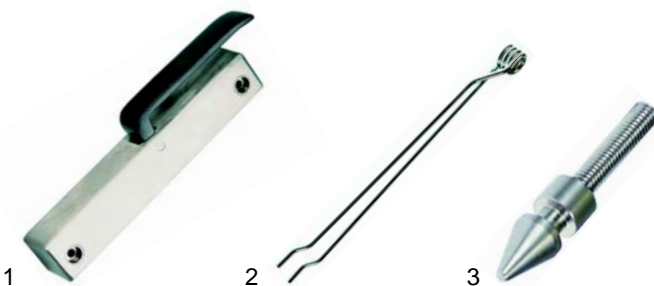

Item	Order	Description	Model	OEM
1	700458	door handle		02085
2	700439	spring	FCV/6	02088
3	700461	door catch		02086

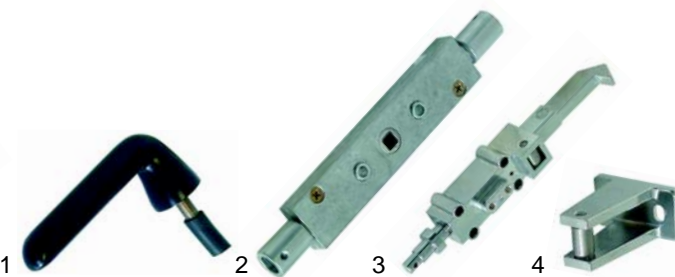

Item	Order	Description	Model	OEM
1	690840	door handle		56415
2	690836	gearbox	FCV/10, FCV/20	56550
3	690837	ratchet		56551
4	690838	door catch		56571

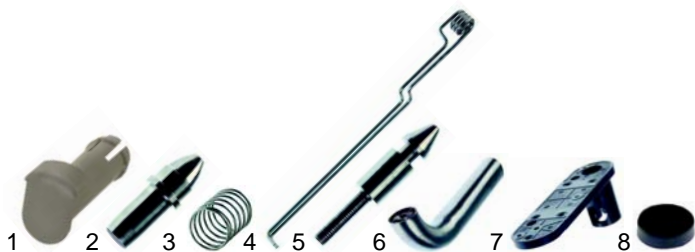

Item	Order	Description	Model	OEM
1	700446	push button		53761
2	700444	pressure pin		53756
3	700445	spring		53757
4	700450	spring	FCV/10, FCV/20	54282
5	700447	door catch		53766
6	700453	handle		55057
7	700454	protection		55059
8	700460	cap		55043

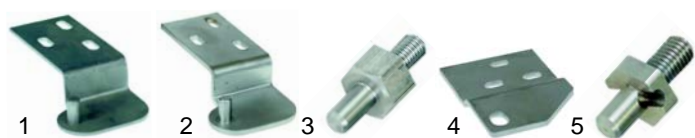

Item	Order	Description	Model	OEM
1	700462	hinge/upper	FCV/_6	55415
2	700463	hinge/upper	FCV/_10, FCV/_20	55316
3	700464	pin	FCV/_6, FCV/_10, FCV/_20	55318
4	700465	hinge/lower		55317
5	700466	pin	FCV/_ (from '92)	59083

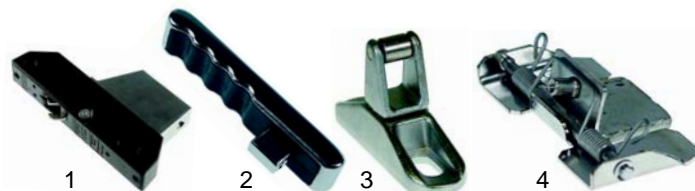

Item	Order	Description	Model	OEM
1	700467	catch	FCV/_6,	02647
2	690874	door handle	FCV/_10,	02717
3	700468	door catch	FCV/_61,	02650
4	700469	spring	FCV/_102	03773

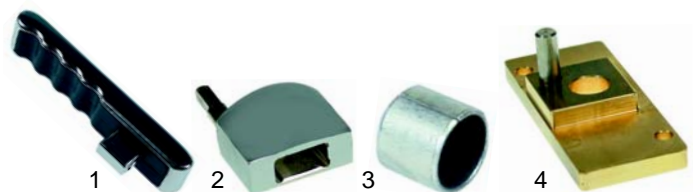

Item	Order	Description	Model	OEM
1	690874	door handle		02717
2	700470	joint support	FCV/201,	03826
3	700471	bearing	FCV/202	03994
4	700472	flange		04098

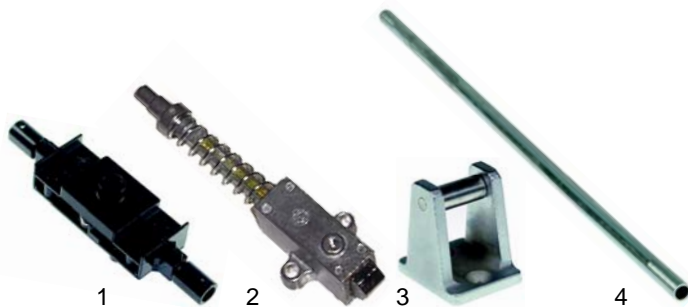

Item	Order	Description	Model	OEM
1	700488	gearbox		03824
2	690041	ratchet	FCV/201,	03822
3	700490	door catch	FCV/202	0H6728
4	700489	rod		05037

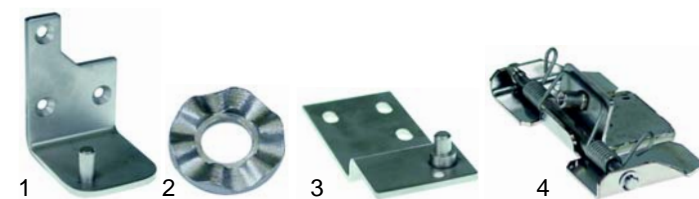

Item	Order	Description	Model	OEM
1	700473	hinge/upper	FCV/_6,	02651
2	700474	shaft disc	FCV/_10,	02653
3	700475	hinge/lower	FCV/_61,	02352
4	700469	spring	FCV/_101	03773

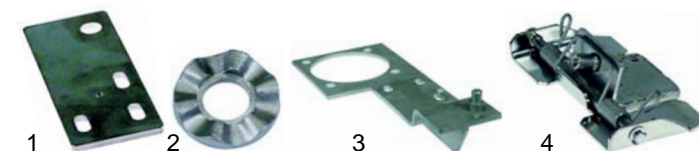

Item	Order	Description	Model	OEM
1	690871	hinge/upper		05041
2	700474	shaft disc	FCV/_201,	02653
3	700476	hinge/lower	FCV/_202	05694
4	700469	spring		03773

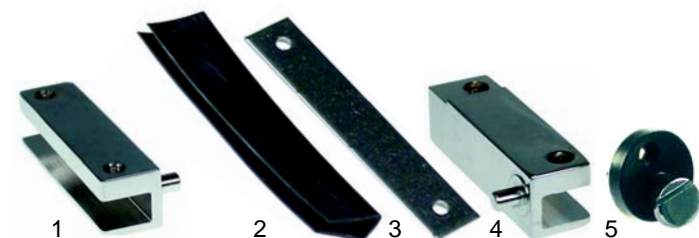

Item	Order	Description	Model	OEM
1	700477	hinge/glass side upper	FCV/_6,	02876
2	700478	gasket	FCV/_10,	02645
3	700479	plate	FCV/_61,	02877
4	700480	hinge/glass side lower	FCV/_101,	02875
5	690870	catch	FCV/_201,	04838
			FCV/_202	

Z
Suitable for Zanussi



Item	Order	Description	Model	OEM
1	700481	door handle		06978
2	700482	catch	AOS61_	06977
3	700483	door catch	AOS101_	06981
4	690873	spring		06979

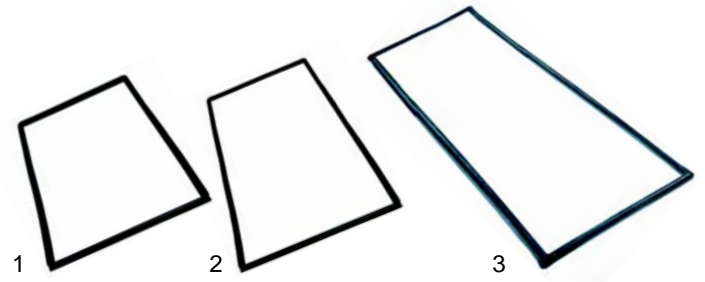

Item	Order	Description	Model	OEM
1	900187	door seal, 585x395mm	FCV/_6	55414
2	900188	door seal, 640x720mm	FCV/_10, FCV/_20	55315
3	900275	door seal, 645x1380mm	FCV/_202	54986

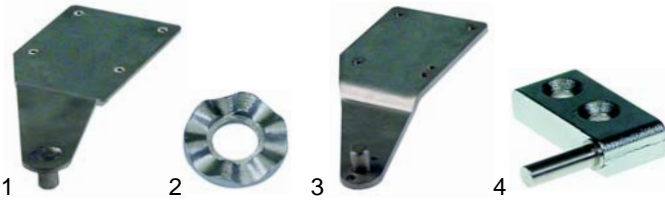

Item	Order	Description	Model	OEM
1	690866	hinge/upper		06972
2	700474	shaft disc	AOS61_	02653
3	690867	hinge/lower	AOS101_	06980
4	700484	glass plate/hinge		07007

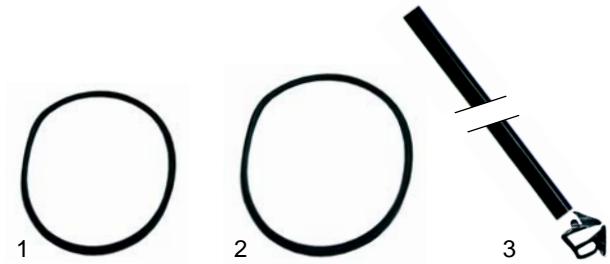

Item	Order	Description	Model	OEM
1	900190	window seal, 190mm	FCV/_6	55412
2	900191	window seal, 230mm	FCV/_10, FCV/_202	55314
3	900192	window seal, per meter	FCV/_20	54224



Item	Order	Description	Model	OEM
1	700481	door handle		06978
2	700485	catch	AOS201_	07089
3	700486	door catch	AOS202_	07092



Pos.	Order	Description	Model	OEM
1	900433	door seal, 635x430mm	FCV/_6	05713, 02828
2	900162	door seal, 610x435mm	FCV/_61	05707
3	900160	door seal, 660x730mm	FCV/_10, FCV/_101, FCV/_102	02654, 05712
4	900161	door seal, 635x1400mm	FCV/_20 1/1, FCV/_20 2/1	03088, 05705
5	900434	door seal, 660x1395mm	FCV/_20, FCV/_201, FCV/_202	03995, 05711



Item	Order	Description	Model	OEM
1	690868	hinge/upper		07086
2	700474	shaft disc	AOS201_	02653
3	700511	hinge/lower	AOS202_	07091
4	700484	glass plate/hinge		07007

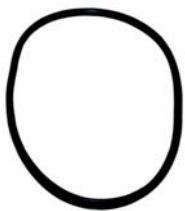

Pos.	Order	Description	Model	OEM
1	900185	window seal, 150mm	FCV/_6, FCV/_61	02837
2	900186	window seal, 200mm	FCV/_10, FCV/_101, FCV/_102, FCV/_20, FCV/_201, FCV/_202	02878



Pos.	Order	Description	Model	OEM
1	900278	door seal, 485x510mm	AOS061_	06992
2	900268	door seal, 485x755mm	AOS101_	07069
3	900276	door seal, 485x1480mm	AOS201_	0C0881
4	900267	door seal, 660x1480mm	AOS202_	0C1195

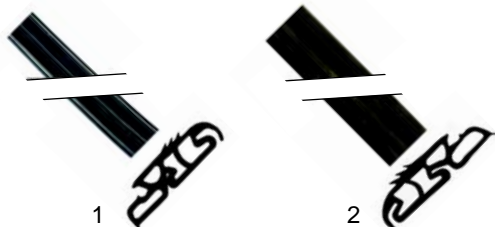

Item	Order	Description	Model	OEM
1	900295	hot meals trolley sealing	AOS201_	0C0899
2	900274	hot meals trolley sealing	AOS202_	0C1196

Stockpot stoves (gas)



Item	Order	Description	Model	OEM
1	105028	burner cover	FP/G1,	26643
2	105027	burner	FP/61D	26641
3	101100	safety valve 1/2"		50106

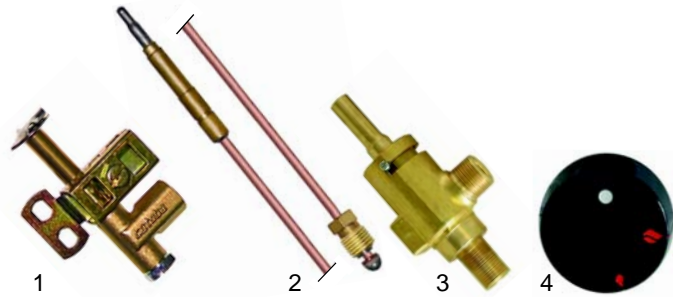

Item	Order	Description	Model	OEM
1	100043	pilot burner		51624
2	102041	thermocouple 600mm		25031
3	101083	gas tap	FP/G1,	25021
4	110047	knob	FP/61D	56016 26798

Table top cookers



Item	Order	Description	Model	OEM
1	105307	burner cover, 80mm		20985
2	105308	Venturi	FT/G2,	20984
3	105023	burner cover, 145mm	FT/G2V	20986
4	105022	Venturi		20954

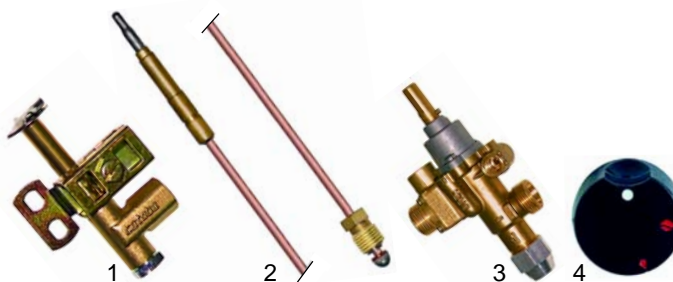

Item	Order	Description	Model	OEM
1	100043	pilot burner		20152
2	102045	thermocouple 1500mm	FT/G2V	52814
3	101087	gas tap	(509474)	52146
4	110897	knob		54105



Item	Order	Description	Model	OEM
1	101083	gas tap	FT/G2	25021
2	110047	knob	(253103) (2VV02B)	56016 26798



Item	Order	Description	Model	OEM
1	105236	burner cover 83mm	FT/G2	03733
2	105235	burner	(253110)	02461
3	105237	Venturi	FOTG02T (774100)	02458



Item	Order	Description	Model	OEM
1	105242	burner cover 123	FT/G2	02441
2	105241	burner	(253110)	02463
3	105243	Venturi	FOTG02T (774100)	02460

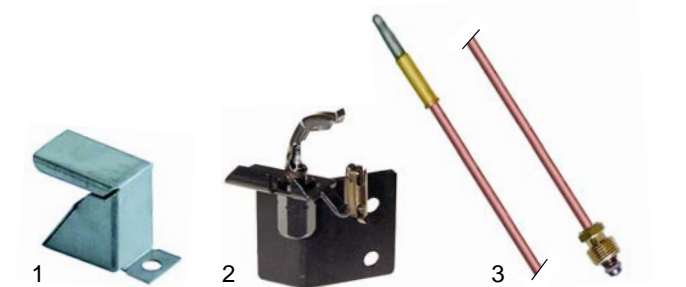

Item	Order	Description	Model	OEM
1	105309	cover	FT/G2	03547
2	100094	pilot burner	(253110)	59214
3	102205	thermocouple 750mm	FOTG02T (774100)	58332



Item	Order	Description	Model	OEM
1	101095	gas tap	FT/G2	59460
2	110348	knob	(253110) FOTG02T (774100)	59206

Salamander (gas)



Item	Order	Description	Model	OEM
1	416578	radiating elements		57730
2	100106	pilot burner		58329
3	100706	electrode	SL/G802	56754
4	100025	ignition cable		

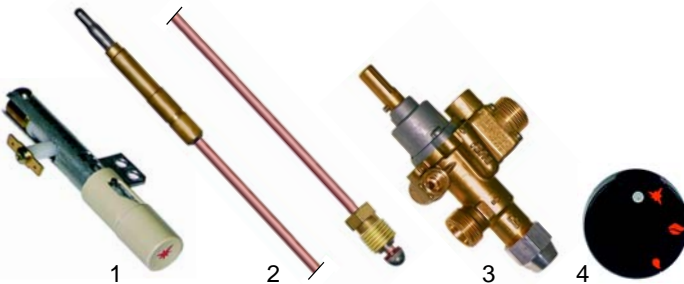

Item	Order	Description	Model	OEM
1	100007	piezoelectric igniter		52539
2	102045	thermocouple, 1500mm		52814
3	101087	gas tap	SL/G802	52146
4	111599	knob		52604

Salamander (electric)

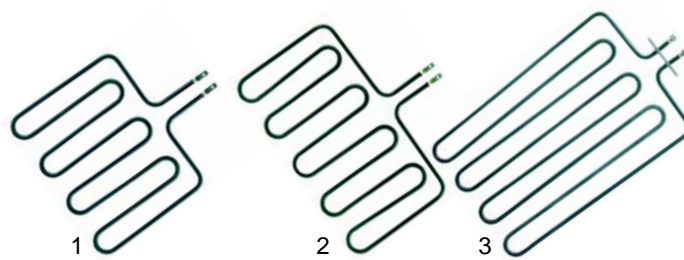

Item	Order	Description	Model	OEM
1	416579	1900W/230V	SL/E901, SA2-E2, E901	56783
2	416580	2000W/230V	SL/E851, SAL-E1, E854	56782
3	416581	3000W/230V	SL/E802	SL/E802

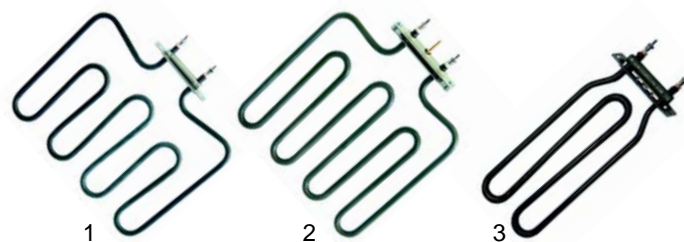

Item	Order	Description	Model	OEM
1	416653	2200W/230V	SE40	03016
2	416654	2200W/230V	SE60	03012
3	415625	1000W/230V	SE80	03014



Item	Order	Description	Model	OEM
1	380015	energy regulator	universal	53695
2	110898	knob	SL/_	53694
3	110701	knob		03029
4	359031	signal lamp	SE40/60/80	03302
5	380204	contactor	SE80	-



GASTROPARTS.COM



© 2020 Gastroparts Sp. J. All rights reserved.