



GASTROPARTS

Unox

[EN] Cooking

[DE] Kochtechnik

[ES] Cocción

[FR] Cuisson

[IT] Cottura

[PL] Obróbka termiczna

[RU] Термическая обработка

✉ gastroparts@gastroparts.com

☎ tel. +48 56 657 00 66

📘 fb.com/gastroparts.global

GASTROPARTS.COM





heating elements

heating elements for ovens



Part No.	417565	Ref. No.	KRS1261A
description	heating element 122W 105V heating circuits 1 L 85mm W 31mm flange length 70mm flange width 22mm hole distance 56mm hole \varnothing 5mm tube \varnothing 6.25mm connection male faston 6.3mm connection length 87mm rectangular flange dry heating element with gasket and silicone		



Part No.	417548	Ref. No.	KRS1215A
description	heating element 147W 105V heating circuits 1 L 88mm W 30.5mm flange length 78mm flange width 28mm hole distance 55mm tube \varnothing 6.3mm connection Faston 6.3mm connection length 85mm with gasket and silicone		

quartz heating elements

Part No.	417740	Ref. No.	KRS0105A RS105
description	quartz heating element 500W 112.5V L 370mm \varnothing 12mm connection male faston 4.8mm		

heating elements for convection

Part No.	417608	Ref. No.	KRS0090A KRS011
description	heating element 1260W 230V heating circuits 1 ID \varnothing 178mm ED \varnothing 190mm L 244mm H 31mm L1 47mm W1 31mm H1 6mm H2 25mm flange length 70mm flange width 22mm hole distance 56mm connection male faston 6.3mm tube \varnothing 6.3mm convection heating element hole \varnothing 5mm flange connection with gasket and silicone		

Part No.	418746	Ref. No.	KRS020 KRS1130A RS1130A0
description	heating element 2900W 230V heating circuits 1 ID \varnothing 220mm ED \varnothing 235mm L 268mm H 40mm L1 35mm W1 30mm H1 11mm H2 32mm flange length 99mm flange width 21mm hole distance 86mm connection male faston 6.3mm connection length 60mm tube \varnothing 6.3mm convection heating element hole \varnothing 5mm rectangular flange		
For models:	XF023, XF100, XF103, XF110, XF113, XF115, XF119, XF130, XF133, XF135		

Part No.	418745	Ref. No.	KRS016 KRS1090A RS1090A0 RS1090A1
description	heating element 2900W 230V heating circuits 1 ID \varnothing 220mm ED \varnothing 235mm L 268mm H 75mm L1 35mm W1 30mm H1 11mm H2 32mm flange length 99mm flange width 21mm hole distance 86mm connection male faston 6.3mm connection length 60mm tube \varnothing 6.3mm convection heating element hole \varnothing 5mm rectangular flange		
For models:	XF183, XF185, XF190, XF193, XF195, XVC054, XVC104		
accessories for	418745		
Part No.	550986	Ref. No.	GN1280 GN1327A0 GN224
description	gasket L 100mm W 22mm 7 holes graphite thickness 1mm for heating element		

1

Part No.	419142	Ref. No.	KRS003 KRS1026 KRS1026 + GN 1280 KRS1026A RS026A
description	heating element 3100W 230V heating circuits 1 ID ø 220mm ED ø 235mm L 45mm H 15mm W1 25mm H1 8mm H2 30mm flange length 99mm flange width 21mm hole distance 86mm connection male faston 6.3mm connection length 60mm tube ø 6.3mm convection heating element hole ø 5mm rectangular flange with gasket and silicone		
For models:	XF090P		
accessories for	419142		
	Part No.	550986	Ref. No.
			GN1280 GN1327A0 GN224
	gasket L 100mm W 22mm 7 holes graphite thickness 1mm for heating element		



1

Part No.	417550	Ref. No.	KRS1225A
description	heating element 4700W 230V heating circuits 3 ID ø 224mm ED ø 235mm L 270mm H 97mm L1 15mm W1 103mm H1 15mm H2 85mm flange length 148mm flange width 31mm hole distance 17mm connection Faston 6.3mm connection length 85mm tube ø 6.3mm convection heating element hole ø 4.5mm rectangular flange with gasket and silicone		



1

Part No.	418906	Ref. No.	KRS012 KRS1040A
description	heating element 4250W 230V heating circuits 2 ID ø 220mm ED ø 235mm L 265mm H 50mm L1 25mm W1 53mm H1 5mm H2 45mm flange length 100mm flange width 22mm hole distance 87mm connection male faston 6.3mm tube ø 6.3mm with gasket and silicone		



1

Part No.	417556	Ref. No.	KRS032 KRS1150A
description	heating element 4900W 230V heating circuits 2 ID ø 224mm ED ø 235mm L 270mm H 70mm L1 30mm W1 60mm H1 12mm H2 60mm flange length 100mm flange width 22mm hole distance 86mm connection Faston 6.3mm connection length 85mm tube ø 6.3mm convection heating element hole ø 5mm rectangular flange with gasket and silicone		



1

Part No.	420399	Ref. No.	KRS0085A KRS010
description	heating element 4400W 225V heating circuits 2 ID ø 224mm ED ø 235mm L 270mm H 65mm L1 25mm W1 60mm H1 12mm H2 55mm flange length 100mm flange width 22mm hole distance 86mm connection Faston 6.3mm connection length 60mm tube ø 6.3mm convection heating element hole ø 5mm rectangular flange with gasket and silicone		



1

Part No.	419017	Ref. No.	KRS013 KRS1050A
description	heating element 5000W 230V heating circuits 2 ID ø 223mm ED ø 236mm L 265mm H 65mm L1 25mm W1 55/25mm H1 6mm H2 59mm flange length 100mm flange width 22mm hole distance 86mm connection male faston 6.3mm tube ø 6.5mm hole ø 5mm with gasket and silicone		
spare parts for	419017		
	Part No.	550986	Ref. No.
			GN1280 GN1327A0 GN224
	gasket L 100mm W 22mm 7 holes graphite thickness 1mm for heating element		



			
1			
Part No.	417560	Ref. No.	KRS1180A
description	heating element 9000W 230V heating circuits 3 ID ø 220mm ED ø 238mm L 282mm H 100mm L1 30mm W1 104mm H1 10mm H2 85mm flange length 147mm flange width 31mm hole distance 62mm connection Faston 6.3mm connection length 85mm tube ø 8.5mm convection heating element hole ø 4.5mm rectangular flange with gasket and silicone		

			
1			
Part No.	417555	Ref. No.	KRS1020A RS1020A0
description	heating element 9000W 230V heating circuits 3 ID ø 240mm ED ø 257mm L 300mm H 100mm L1 38mm W1 104mm H1 8.5mm H2 85mm flange length 142mm flange width 25mm hole distance 126mm connection Faston 6.3mm connection length 85mm tube ø 8.5mm convection heating element hole ø 6.2mm rectangular flange INCOLOY-800		
For models:	XV1003G		

energy regulators

EGO

1-circuit

			
1			
Part No.	380019	Ref. No.	KVE009 VE023
description	energy regulator 240V 13A single-circuit turn direction right shaft ø 6x4.6mm shaft L 23mm mounting thread M4 power release 6-100% no. 50.57071.010		

			
1			
Part No.	381243	Ref. No.	EX-VE023 KVE1556A
description	energy regulator 240V 13A single-circuit turn direction right shaft ø 6x4.6mm shaft L 23mm power release 6-100% with knob set		
For models:	XB1083, XB613G, XB693, XB813G, XB893, XF030, XF040, XF050, XF065, XV1093, XV201, XV202, XV301, XV393, XV401, XV501, XV513G, XV593, XV813G, XV893		

thermostats

control and safety thermostats

EGO

control thermostats

55.10/19_series

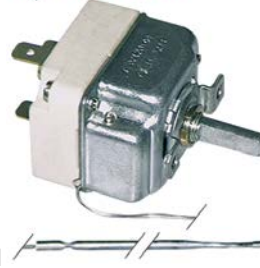



1			
Part No.	390943	Ref. No.	KTR1100A TR1100A0
description	thermostat t.max. 269°C 1-pole 1NO 16A probe ø 3mm probe L 225mm capillary pipe 900mm capillary pipe isolated 800mm gland nut shaft ø 6x4.6mm shaft L 23mm shaft position upper rotation 270°		
For models:	XB693, XB893, XV593		







1			
Part No.	375894	Ref. No.	KTR001 KTR009 KTR012 KTR1130A TR006
description	thermostat t.max. 293°C temperature range 55-293°C 1-pole 1NO 16A probe ø 3.1mm probe L 226mm capillary pipe 870mm capillary pipe isolated 350mm gland nut shaft ø 4.0-6.0mm shaft L 23mm rotation 270°		
For models:	XF003, XF006, XF011, XF016, XF023, XF030, XF030-TG, XF043, XF065, XF090P, XF113, XF133, XF183, XF193, XV202, XV301, XV401, XV501		





			
			
			
Part No.	376024	Ref. No.	KTR006 KTR1131A TR016 TR017
description	thermostat t.max. 355°C temperature range 60-355°C 1-pole 1NO 16A probe ø 4mm probe L 228mm capillary pipe 900mm capillary pipe isolated 600mm gland nut shaft ø 6x4.6mm shaft L 23mm shaft position upper rotation*		
For models:	XP010P, XP010PR, XP010PT, XP010R, XP020, XP020P, XP020PR, XP020PT, XP020R, XP020T, XP250		

CAMPINI			
safety thermostats			
			
			
Part No.	376080	Ref. No.	KTR1136A
description	safety thermostat kit switch-off temp. 318°C 1-pole 16A probe ø 3mm probe L 137mm capillary pipe 1260mm capillary pipe isolated 710mm gland nut probe SS type Ty 95-H		

safety thermostats			
55.32_ series			
			
			
			
Part No.	390999	Ref. No.	KTR1140A
description	safety thermostat switch-off temp. 350°C temperature range°C 2-pole NC 20A probe ø 3mm probe L 187mm capillary pipe 690mm capillary pipe isolated 680mm gland nut shaft ømm probe SS		

switches and momentary switches			
push/momentary push switches			
20.6x16.4mm			
			
			
Part No.	348186	Ref. No.	KVE0108A
description	push switch 2NO		

CAEM			
safety thermostats			
			
			
Part No.	375456	Ref. No.	KTR1134A KTR254 TR240
description	safety thermostat switch-off temp. 335°C 2-pole 20A probe ø 3mm probe L 200mm capillary pipe 1050mm capillary pipe isolated 650mm gland nut probe SS at 250V 20A at 400V 10A		
For models:	XCH030, XF003, XF006, XF010, XF016, XF020, XF020R, XF023, XF030, XF030-TG, XF040, XF043, XF050, XF065, XF090P, XF100, XF103, XF110, XF113, XF115, XF119, XF130, XF133, XF135, XF183, XP010P, XP010PR, XP010PT, XP010R, XP020, XP020P, XP020PR, XP020PT, XP020R, XP020T, XV201, XVC054, XVC104		

microswitches			
pin-plunger actuated			
M10			
			
			
Part No.	347945 ¹	Ref. No.	KVE1295A MF09 VE086 VE086B
description	microswitch with plunger thread M10x0.75 thread L 13mm 250V 5A 1CO connection male faston 6.3mm stroke 6mm mounting distance 25mm L 49mm L1 13mm ambient temperature max. 85°C IP65 type MKH12D09 actuating force: 340g		
For models:	XF043, XF090P, XF100, XF110, XF115, XF130, XF135, XF183, XF185, XF188, XF190, XF193, XF195, XV201, XV202, XV202E, XV301, XV301E, XV401, XV401E, XV501, XV501E, XVC054, XVC104		

¹protection class IP65



system switches (ROLD)



1

Part No.	345537	Ref. No.	VE161
description	element holder mounting measurements 20.6x16.4mm grey arched for push buttons 13x17mm		
For models:	XC110, XF006, XF011, XF016, XF030, XF030-TG, XF065, XF090P, XG413, XG413G, XG613, XG613G, XG813, XG813G, XL041, XL051, XL091, XL503, XP010P, XP010PR, XP010PT, XP010R, XP020, XP020P, XP020PR, XP020PT, XP020R, XP020T, XT010, XT020, XV202, XV301, XV401, XV501		
accessories for	345537		
	Part No.	345720	Ref. No. VE168
	switch 2NO 250V 16A connection male faston 6.3mm		



1

Part No.	345601	Ref. No.	KVM1762A VE162 VM1762A0
description	indicator lamp holder V ø 11mm		
For models:	XB1083, XB613G, XB693, XB813G, XB893, XFT113, XFT133, XFT183, XFT193, XL413, XP010E, XP010ER, XP010ET, XP010P, XP010PR, XP010PT, XP020, XP020E, XP020ER, XP020ET, XP020P, XP020PR, XP020PT, XP020R, XP020T, XV1093, XV393, XV513G, XV593, XV813G, XV893		



1

Part No.	357012	Ref. No.	KVE007
description	indicator lamps set mounting measurements 20.6x16.4mm green 230V connection male faston 6.3mm ø 20.6x16.4mm socket male faston 6.3mm		



1

Part No.	360598	Ref. No.	KVE1535A VE1535A0 VE177
description	indicator light LED white connection male faston 6.3mm 250V ø 11mm voltage AC		
For models:	XB693, XB893, XC110, XF003, XF006, XF011, XF016, XF030, XF030-TG, XF065, XF090P, XF103, XF113, XF133, XF183, XF193, XG413, XG413G, XG613, XG613G, XG813, XG813G, XL041, XL051, XL091, XL503, XP010P, XP010PR, XP010PT, XP010R, XP020, XP020P, XP020PR, XP020PT, XP020R, XP020T, XV202, XV301, XV401, XV501, XV593		
accessories for	360598		
	Part No.	345601	Ref. No. KVM1762A VE162 VM1762A VM1762A0
	indicator lamp holder V ø 11mm		



1

Part No.	347193	Ref. No.	VE169
description	momentary switch unit 1NO 250V 16A connection male faston 6.3mm		



1

Part No.	347751	Ref. No.	VE176
description	push button size 17x13mm silver 0-I gold		
For models:	XC110, XL041, XL051, XL091, XL503, XP010P, XP010PR, XP010PT, XP010R, XP020, XP020P, XP020PR, XP020PT, XP020R, XP020T, XT010, XT020		



1

Part No.	347750	Ref. No.	VE175
description	push button size 17x13mm silver steam gold		
For models:	XF090P, XF113, XF133, XL041, XL091, XL503		



1

Part No.	345720	Ref. No.	VE168
description	switch 2NO 250V 16A connection male faston 6.3mm		
For models:	XC110, XL041, XL051, XL091, XL503, XP010P, XP010PR, XP010PT, XP010R, XP020, XP020P, XP020PR, XP020PT, XP020R, XP020T, XT010, XT020		
accessories for	345720		
	Part No.	345537	Ref. No. VE161
	element holder mounting measurements 20.6x16.4mm grey arched for push buttons 13x17mm		



cam switches

operation switches



Part No.	300251	Ref. No.	KVE0024A VE024
description	cam switch 6 operating positions 2NO/1CO 16A sequence 0-1-2-3-4-5 shaft ø 6x4.6mm shaft L 24mm connection male faston 6.3mm plastic 3-pole		
For models:	XF030, XF040, XF050, XF065		

magnetic switches

M10x0.75



Part No.	348006	Ref. No.	KVE1020A KVE1020B VE1020A0 VE1020A1
description	Read switch kit thread M10x0.75 1NO 250V 0.04A connection male faston 6.3mm cable length 1200mm type D10P 1V DA F 120 with magnet		
For models:	XB403, XB403G, XB603, XB603G, XB803, XB803G, XBC1005, XBC404, XBC604, XBC605, XBC804, XBC805, XBC815G, XBT146, XBT160, XG413, XG413G, XG613, XG613G, XG813, XG813G, XK304, XV1003G, XV203G, XV303G, XV703G, XVC1004P, XVC1005P, XVC1015G, XVC1204P, XVC2015G, XVC204, XVC205, XVC304, XVC305, XVC315G, XVC504, XVC505, XVC514G, XVC515G, XVC704, XVC705, XVC715G, XVC905P, XVT203G		
spare parts for	348006		
	Part No.	348005	Ref. No. —
	magnetic switch thread M10x0.75 1NO 250V 0.04A P max. 10W connection male faston 6.3mm cable length 1200mm type D10P 1V DA F 120		

lamps

indicator lights

indicator lights (complete)

miscellaneous



Part No.	357012	Ref. No.	KVE007
description	indicator lamps set mounting measurements 20.6x16.4mm green 230V connection male faston 6.3mm ø 20.6x16.4mm socket male faston 6.3mm		

screw-on/push-on fit

halogen lamp

for socket G4 / G6.35 / G9





Part No.	359946	Ref. No.	VE1005A1
description	halogen lamp socket G9 230V 40W temp.-resist. 300°C		
For models:	XB403, XB403G, XB603, XB603G, XB803, XB803G, XBC404, XBC604, XBC804, XBT146, XBT160, XF100, XF110, XF113, XF119, XF130, XF135, XF183, XF185, XF188, XF190, XF193, XF195, XG413G, XG613G, XG813, XV1003G, XV203G, XV303G, XV703G, XVC054, XVC104, XVC204, XVC304, XVC504, XVC704		

oven lamps

universal oven lamps

mounting diameter 35.5mm



Part No.	359718	Ref. No.	KLP0030A
description	oven lamp mounting ø 35.5mm 230V 15W socket E14 temp.-resist. 300°C connection male faston 6.3mm hard glas		
spare parts for	359718		
	Part No.	359701	Ref. No. VE1015
	lamp socket socket E14 220-230V mounting ø 35.5mm connection male faston 6.3mm 15W		
	Part No.	359718	Ref. No. KLP0030A
	oven lamp mounting ø 35.5mm 230V 15W socket E14 temp.-resist. 300°C connection male faston 6.3mm hard glas		
	Part No.	359740	Ref. No. —
	light bulb t.max. 300°C socket E14 15W 230V ø 22mm L 48mm lens L 20mm for oven lamp IMPORT		









Part No.	359701	Ref. No.	VE1015
description	lamp socket socket E14 220-230V mounting ø 35.5mm connection male faston 6.3mm 15W		
accessories for	359701		
	Part No.	359705	Ref. No. VE1010A1
	oven lamp glass thr.ø 33.5mm ø 52mm hard glas temp.-resist. 350°C		
	Part No.	359709	Ref. No. VE036
	oven lamp glass thr.ø 33.5mm ø 42mm hard glas temp.-resist. 350°C		
	Part No.	359721	Ref. No. —
	gasket silicone ED ø 48mm ID ø 39.5mm thickness 5mm Qty 1 pcs		

Table continues overleaf



accessories for	359701		
	Part No.	359942	Ref. No. —
	oven lamp glass thr.ø 33.5mm ø 41mm hard glas temp.-resist. 350°C		

	1		
Part No.	357160	Ref. No.	KVE1015A VE1015A0 VE1015A1
description	lamp socket socket G9 220-230V mounting ø 35.5mm connection cable 100mm		
For models:	XB403, XB403G, XB603, XB603G, XB803, XB803G, XBT146, XBT160, XF100, XF110, XF115, XF130, XF135, XF183, XF185, XF188, XF190, XF193, XF195, XG413, XG413G, XG613, XG613G, XG813, XG813G, XV1003G, XV203G, XV303G, XV703G, XVT203G		

	1		
Part No.	358191	Ref. No.	KVE1005A
description	repair kit ID ø 44mm ED ø 53mm thickness 3mm for oven lamp		
spare parts for	358191		
	Part No.	357195	Ref. No. —
	halogen lamp socket G9 230V 25W temp.-resist. 300°C OSRAM HALOPIN OVEN		
	Part No.	358135	Ref. No.
	gasket for oven lamp PTFE ID ø 44mm ED ø 53mm thickness 3mm with silicone O-ring		



	1		
Part No.	358136	Ref. No.	GN1005 KVE005 KVT1195A VE1010A0
description	repair kit ø 35.5mm for oven lamp		
For models:	XB403, XB403G, XB603, XB603G, XB803, XB803G, XBT146, XBT160, XF100, XF110, XF115, XF119, XF130, XF135, XF185, XF188, XF190, XF195, XG413, XG413G, XG613, XG613G, XG813, XG813G, XV1003G, XV203G, XV303G, XV703G, XVC054, XVC1004P, XVC104, XVC204, XVC304, XVC504, XVC704, XVT203G		

lamps

halogen lamps

for socket G4 / G6.35 / G9

	1		
Part No.	359946	Ref. No.	VE1005A1
description	halogen lamp socket G9 230V 40W temp.-resist. 300°C		
For models:	XB403, XB403G, XB603, XB603G, XB803, XB803G, XBC404, XBC604, XBC804, XBT146, XBT160, XF100, XF110, XF113, XF119, XF130, XF135, XF183, XF185, XF188, XF190, XF193, XF195, XG413G, XG613G, XG813, XV1003G, XV203G, XV303G, XV703G, XVC054, XVC104, XVC204, XVC304, XVC504, XVC704		

	1		
Part No.	358191	Ref. No.	KVE1005A
description	repair kit ID ø 44mm ED ø 53mm thickness 3mm for oven lamp		
spare parts for	358191		
	Part No.	357195	Ref. No. —
	halogen lamp socket G9 230V 25W temp.-resist. 300°C OSRAM HALOPIN OVEN		
	Part No.	358135	Ref. No.
	gasket for oven lamp PTFE ID ø 44mm ED ø 53mm thickness 3mm with silicone O-ring		

timers

mechanical timers

	1		
Part No.	350134 ¹	Ref. No.	KTM001 KTM0023A
description	time switch kit M2 2-pole operation time 120min impulse mechanical 2CO at 250V 16A permanent position yes shaft ø 6x4.6mm shaft 6x4.6mm shaft L 22mm mounting distance 28mm ambient temperature max. 125°C with knob		

¹incl. knob and symbol

	1		
Part No.	350187	Ref. No.	KTM004 KTM005 KTM1005A TM1005A0
description	timer M2 2-pole operation time 60min impulse mechanical 2CO at 250V 16A permanent position yes shaft ø 6x4.6mm shaft 6x4.6mm shaft L 23mm mounting distance 28mm		
For models:	XB1083, XB613G, XB693, XB813G, XB893, XF003, XF023, XF030, XF030-TG, XF043, XF090P, XF113, XF133, XFT113, XFT133, XFT183, XFT193, XV1093, XV393, XV513G, XV593, XV813G, XV893		



alarm devices

buzzer boards

 <p>1</p>			
Part No.	401062	Ref. No.	KTM0012B
description	buzzer board 230VAC L 48mm W 45mm connection Faston 6.3mm		

 <p>1</p>			
Part No.	403761	Ref. No.	VE1070A VE1070A0
description	buzzer board 230VAC L 54mm W 31mm connection Faston 6.3mm suitable for UNOX		
For models:	XG413, XG413G, XG613, XG613G, XG813, XG813G		

 <p>1</p>			
Part No.	350210	Ref. No.	KTM1001C TM1001C0
description	buzzer board L 54mm W 48mm connection male faston 6.3mm		

contactors

GENERAL ELECTRIC (AEG)

power contactors

 <p>1</p>			
Part No.	381242	Ref. No.	KVE1115A VE1115A0
description	power contactor resistive load 20A 230VAC (AC3/400V) 8.4A/4kW main contacts 4NO connection screw connection type AEG LS05 400A type GE MC1A 400A with mounting clips		
For models:	XB693, XB893, XBC1005, XBC605, XBC805, XF043, XF100, XF103, XF110, XF115, XF119, XF130, XF135, XV593, XVC054, XVC1005P, XVC1015G, XVC104, XVC105, XVC2015G, XVC205, XVC305, XVC505, XVC705, XVC905P		

 <p>1</p>			
Part No.	381095	Ref. No.	KVE019 KVE1095A VE1095A0
description	power contactor resistive load 25A 230VAC (AC3/400V) 12A/5.5kW main contacts 3NO auxiliary contacts 1NO connection screw connection type AEG type GE CL01A400T6		
For models:	XB403, XB403G, XB603, XB603G, XB693, XB695, XB803, XB803G, XB893, XB895, XBC404, XBC604, XBC804, XBT146, XBT160, XF183, XF185, XF188, XF190, XF193, XF195, XV1003G, XV203G, XV303G, XV593, XV703G, XVC1004P, XVC1204P, XVC204, XVC304, XVC504, XVC704, XVT203G		

transformers

encapsulated transformers

<p>PMA</p>  <p>1</p>			
Part No.	379054	Ref. No.	TR102
description	transformer primary 230VAC secondary 12VAC 3VA secondary 0.25A H 40mm L 45mm W 50mm connection screw 50/60Hz type 153/M		

electronic controllers

SHANGFANG

accessories

 <p>1</p>			
Part No.	379054	Ref. No.	TR102
description	transformer primary 230VAC secondary 12VAC 3VA secondary 0.25A H 40mm L 45mm W 50mm connection screw 50/60Hz type 153/M		



probes

producer-specific probes

probes



1			
Part No.	379741	Ref. No.	KTR007 KTR1095A TR1015A0
description	temperature probe kit NTC cable glass fibre probe -40 up to +125°C cable -50 up to +350°C connection coded plug thread probe ø4x-19mm cable length 1m		
For models:	XC314, XC595, XCH030, XF100, XF110, XF115, XF119, XF130, XF135, XF185, XF188, XF190, XF195, XL135, XL195, XL314, XL404		
spare parts for	379741		
	Part No.	890034	Ref. No. —
	silicone adhesive TOMABOND TB77 cartridge 80ml anthracite		

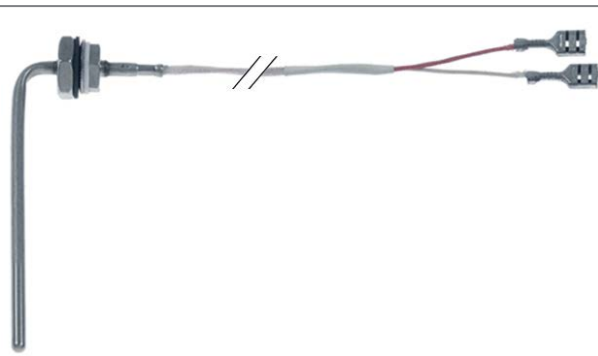

1			
Part No.	378543	Ref. No.	KTR004 KTR1005A TR1005/KTR004
description	temperature probe Pt100 cable glass fibre probe -40 up to +350°C cable -40 up to +260°C connection male faston 6.3mm thread M10x1 probe ø4x14-100mm cable length 0.65m		

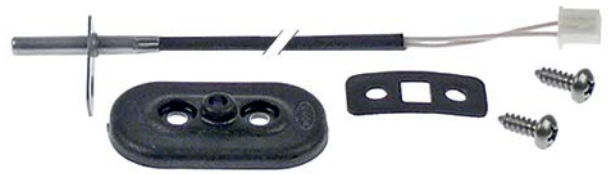

1			
Part No.	378374 ¹	Ref. No.	KTR1105A TR1105A0
description	temperature probe PTC cable silicone probe -50 up to +150°C cable -50 up to +180°C connection coded plug thread probe ø4x16mm cable length 1m		
For models:	XBC605, XBC805, XBC815G, XL405, XVC105, XVC205, XVC305, XVC315G, XVC505, XVC515G, XVC705, XVC715G		

¹incl. silicone gasket



1			
Part No.	378660	Ref. No.	KTR1106A
description	temperature probe kit for cavity probe ø4x25mm cable length 2m flange 20x12mm with mounting kit silicone adhesive C67		
spare parts for	378660		
	Part No.	890034	Ref. No. —
	silicone adhesive TOMABOND TB77 cartridge 80ml anthracite		



1			
Part No.	378371 ¹	Ref. No.	KTR0110A
description	temperature probe kit Pt100 cable PTFE probe -100 up to 450°C cable -40 up to +250°C connection plug thread probe ø3x70mm cable length 1.4m		

¹incl. silicone gasket



core probes

1



Part No.	378417	Ref. No.	KSN1002A SN1002A0
description	core temperature probe Pt100 cable PTFE probe -40 up to +250°C cable -40 up to +250°C connection 5-wire probe ø4x100mm thread M10 cable length 2m handle ø 12mm handle length 52mm		
For models:	XVC1015G, XVC2015G		

2



Part No.	379709	Ref. No.	KTR003 KTR1000A TR1000A3 TR123
description	core temperature probe Pt100 cable PTFE probe -40 up to +250°C cable -40 up to +250°C connection male faston 6.3mm probe ø4x100mm thread M10 cable length 1.4m handle ø 12mm handle length 85mm		
For models:	XB403G, XB603G, XB803G, XCH030, XG413G, XG613G, XG813G, XV203G, XV303G, XV703G, XVT203G		

1



Part No.	379705	Ref. No.	KTR1040A TR1040A0 TR1040A1
description	core temperature probe Pt100 cable PVC probe -40 up to +120°C cable -10 up to +100°C connection plug probe ø4x100mm thread M10x1.5 cable length 1.28m		
For models:	XBC404, XVC054, XVC104, XVC105, XVC204, XVC205, XVC304, XVC305		

1



Part No.	378365	Ref. No.	KTR1041A
description	core temperature probe Pt100 cable PVC probe -40 up to +120°C cable -40 up to +120°C connection plug probe ø4x100mm thread M10x1.5 cable length 2m handle length 44mm		

Hall sensors

1



Part No.	403435	Ref. No.	KPE1710A KPE1710B PE1710A1
description	Hall sensor L 38mm W 8mm H 4mm mounting distance 34mm cable length 1000mm		
For models:	XVC1015G, XVC315G		

electronics

PCBs

1



Part No.	403434	Ref. No.	KPE1730B PE1730B0
description	control PCB combi-steamer XVC1015G L 107mm W 60mm suitable for UNOX H 40mm		
For models:	XBC815G, XVC1015G, XVC2015G, XVC315G, XVC515G, XVC715G		

1



Part No.	403758	Ref. No.	KPE1105A
description	control PCB convection oven suitable for UNOX with control panel		

1



Part No.	403760	Ref. No.	KPE1195C PE1195B0 PE1195C1
description	control PCB L 290mm W 27mm suitable for UNOX		
For models:	XF115, XF135, XF185, XF188, XF195		

1



Part No.	403757	Ref. No.	KPE1740A KPE1740C PE1740A0
description	display PCB convection oven XBC/XVC suitable for UNOX		
For models:	XBC1005, XBC1005E, XBC1005EL, XBC1015EG, XBC1015EGL, XBC405E, XBC605, XBC605E, XBC615EG, XBC805, XBC805E, XBC815EG, XBC815G, XBC905E, XBC905EL, XBC915EG, XBC915EGL, XVC055E, XVC1005EP, XVC1005EPL, XVC1005P, XVC1015EG, XVC1015EGL, XVC1015G, XVC105, XVC105E, XVC105EP, XVC1205EP, XVC1215EG, XVC2005EP, XVC2015EG, XVC2015G, XVC205, XVC205E, XVC305, XVC305E, XVC305EP, XVC315EG, XVC315G, XVC4005EP, XVC4005EPL, XVC4015EG, XVC4015EGL, XVC505, XVC505E, XVC505EP, XVC515EG, XVC705, XVC705E, XVC705EP..(Other models you can see in the webshop)		

1



Part No.	401699	Ref. No.	KPE006 KPE009 KPE1355D PE1355D0
description	keypad PCB suitable for UNOX		
For models:	XVC054, XVC104, XVC204, XVC304, XVC504, XVC704		



1			
Part No.	401700	Ref. No.	KPE005 KPE1365C PE1365C0 PE1365C0+KPE005 PE1365C2
description	main PCB for combi-steamer L 220mm W 145mm suitable for UNOX with mounting accessories		
For models:	XVC054, XVC104, XVC1204P, XVC204, XVC304, XVC504, XVC514G, XVC704		

1			
Part No.	403848	Ref. No.	KPE1010A PE1010A2
description	PCB for combi-steamer Cheflux-Bakerlux L 250mm W 86mm suitable for UNOX with mounting accessories		
For models:	XB403, XB403G, XB603, XB603G, XB803, XB803G, XG413, XG613, XG813G, XV203G, XV303G, XV703G		

1			
Part No.	403850	Ref. No.	KPE1170B PE1170B0
description	PCB for combi-steamer LINE MISS CLASSIC L 155mm W 77mm suitable for UNOX with mounting accessories		
For models:	XF100, XF110, XF130, XF190		

1			
Part No.	403849	Ref. No.	KPE004 KPE1175B PE1175B0
description	PCB for combi-steamer LINE MISS DYNAMIC L 200mm W 95mm suitable for UNOX with mounting accessories		
For models:	XF115, XF119, XF135, XF185, XF188, XF195		

1			
Part No.	403847	Ref. No.	KPE1010B PE1010B1
description	PCB for combi-steamer XB-XV-XG L 304mm W 95mm suitable for UNOX with mounting accessories		
For models:	XB403, XB403G, XB603, XB603G, XB803, XB803G, XBT146, XBT160, XG413G, XG613, XG613G, XG813, XV1003G, XV203G, XV303G, XV703G		

keypads

front foils

1			
Part No.	403756	Ref. No.	KPE1210A
description	keypad foil grey suitable for UNOX L 485mm W 97mm		

1			
Part No.	403879	Ref. No.	KPE1255A PE1255A0
description	keypad foil suitable for UNOX for LINE MISS DYNAMIC L 655mm W 35mm		



1 			
Part No.	403759	Ref. No.	KPE1330A PE1330A0
description	keypad foil suitable for UNOX for model XF180/190 L 655mm W 35mm		
For models:	XF190		

1 			
Part No.	403755	Ref. No.	KMS1005A
description	keypad foil suitable for UNOX L 655mm W 35mm		

1 			
Part No.	403880	Ref. No.	PE1215A PE1215A0
description	keypad foil yellow suitable for UNOX for XB-series until April 2004 L 485mm W 97mm		

control panel

1 			
Part No.	508425	Ref. No.	KPE1315A PE1315A0
description	control panel convection oven L 800mm mounting pos. lower grey plastic suitable for LINE MISS UNOX		

solenoid valves

solenoid valves (water)

RPE

JOHN GUEST

1 			
Part No.	374091	Ref. No.	EL1310A KEL1310A
description	solenoid valve 230VAC inlet 1/2" (tube ø 8mm) outlet 1/2" (tube ø 8mm) plastic		

solenoid valves with reducers

single

1 			
Part No.	374058	Ref. No.	EL1411A0 KEL1411A
description	solenoid valve 230VAC inlet JG 8 outlet JG 8 t.max. 60°C RPE flow regulating valve outlet white output A 1-1.25l/min		

1 			
Part No.	374009	Ref. No.	EL029 EL1011 EL1041A0 EL1085A0 KEL1085A
description	solenoid valve single straight 220-240VAC inlet 3/4" outlet JG 8 input 10-12l/min output 0.07-0.14l/min t.max. 60°C duty cycle 100% RPE plastic flow regulating valve outlet brown flow regulating valve inlet white 1-ways medium temp max. 25°C		
For models:	XBT146, XF090P, XF185, XF188, XF195, XG413, XG413G, XG613, XL041, XV202, XV202E, XV203G, XV301, XV301E, XV303G, XVT203G		

1 			
Part No.	374040	Ref. No.	EL125A0 KEL1252A
description	solenoid valve single straight 230VAC inlet JG 8 outlet JG 10 output 0.45l/min t.max. 60°C duty cycle 100% flow regulating valve outlet green 2-ways with quick release connection		

1 			
Part No.	370481	Ref. No.	EL1250A0 EL1251A0 KEL1250A KEL1251A
description	solenoid valve single straight 230VAC inlet JG 8 outlet JG 10 t.max. 60°C duty cycle 100% flow regulating valve outlet light brown output A 0.12l/min		
For models:	XBC404, XBC604, XBC804, XVC054, XVC1004P, XVC104, XVC204, XVC304, XVC504, XVC514G, XVC704		



2-fold



1

Part No.	374037	Ref. No.	EL025 EL1160A0 KEL1160A
description	solenoid valve double straight 220-240VAC inlet 3/4" outlet JG 8 input 10-12l/min t.max. 60°C duty cycle 100% RPE plastic flow regulating valve inlet white output A 0.2-0.33l/min output B 0.2-0.33l/min flow regulating valve outlet A red flow regulating valve outlet B red output A John Guest 8mm output B John Guest 8mm		
For models:	XB403, XB403G, XB603, XB603G, XBT160, XG613G, XL503, XV201, XV401, XV401E, XV703G		



1

Part No.	374038	Ref. No.	EL1360A0 EL1360A1 KEL1360A KEL1361A
description	solenoid valve special 220-240VAC inlet JG 8 outlet JG 10 t.max. 60°C RPE UNOX plastic		
For models:	XBC1005, XVC1005P, XVC2015G, XVC205, XVC515G, XVC715G, XVC905P		

3-fold



1

Part No.	374036 ¹	Ref. No.	EL1150A0 EL1165A0 KEL1165A
description	solenoid valve triple straight 220-240VAC inlet 3/4" outlet 8mm input 10-12l/min t.max. 60°C duty cycle 100% RPE plastic flow regulating valve inlet white output A 0.2-0.33l/min output B 0.2-0.33l/min output C 0.2-0.33l/min flow regulating valve outlet A red flow regulating valve outlet B red flow regulating valve outlet C red		
For models:	XB803, XB803G, XG813, XV1003G		

¹cylindrical outlet

various



1

Part No.	374101	Ref. No.	KVE1135A
description	solenoid valve UNOX 230VAC inlet 28mm outlet 16mm RPE plastic		

fans

axial fans



1

Part No.	601937	Ref. No.	KVN1120B VN1120B1
description	axial fan L 119mm W 119mm H 32mm 12VDC connection plug cable length 2000mm plastic fan wheel ø 110mm		
For models:	XB695, XB895, XV593		

hot air motors



1

Part No.	601965	Ref. No.	KVN1036A VN1036A0
description	fan motor 230V 1 phase 50/60Hz L1 110mm L2 50mm L3 12mm D1 ø 8mm D2 ø 6mm mounting thread M6		



1

Part No.	601493	Ref. No.	KVN003 KVN1000B VN1000A0 VN1000B0 VN1000B1
description	fan motor 230V 3 phase 50HzkW speeds 1 L1 85mm L2 32mm L3 28mm L4 29mm D1 ø 8mm D2 ø 12mm		
For models:	XB403, XB403G, XB603, XB603G, XB803, XB803G, XBC404, XBC604, XBC804, XBT146, XBT160, XF043, XF183, XF185, XF188, XF190, XF193, XF195, XG413, XG413G, XG613, XG613G, XG813, XG813G, XV1003G, XV203G, XV303G, XV703G, XVC054, XVC1004P, XVC104, XVC1204P, XVC204, XVC304, XVC504, XVC514G, XVC704, XVT203G		



1

Part No.	601492	Ref. No.	KVN017 KVN1035B VN1035B0
description	fan motor L1 130mm L2 18mm L3 23mm D1 ø 8mm D2 ø 7mm mounting thread M6R ET		
For models:	XF003, XF023, XF113, XF133		

1

Part No.	601945	Ref. No.	KVN009 KVN1030A VN1030A0 VN1030A2 VN1030A3 VN1030A4
description	fan wheel D1 ø 196mm H1 81mm blades 39 D2 ø 10mm D3 ø 10mm H2 18mm		
For models:	XB693, XB695, XB893, XB895, XBC1005, XBC404, XBC604, XBC605, XBC804, XBC805, XBC815G, XG413G, XG813, XV1003G, XV593, XVC1004P, XVC1005P, XVC1015G, XVC105, XVC1204P, XVC2015G, XVC205, XVC305, XVC315G, XVC505, XVC514G, XVC515G, XVC705, XVC715G, XVC905P		

1

Part No.	601487	Ref. No.	KVN008 KVN1025A VN1005A0 VN1025A0 VN1025A2
description	fan wheel D1 ø 196mm H1 61mm blades 39 D2 ø 10/8mm D3 ø 10mm H2 32mm		
For models:	XB403, XB403G, XB603, XB603G, XB803, XB803G, XBT146, XBT160, XF043, XF183, XF185, XF188, XF190, XF193, XF195, XG413, XG413G, XG613, XG613G, XG813, XG813G, XV203G, XV303G, XV703G, XVC054, XVC104, XVC204, XVC304, XVC504, XVC704, XVT203G		

1

Part No.	601489	Ref. No.	KVN011 KVN1050A VN1050A0
description	fan wheel D1 ø 197mm H1 32mm blades 39 D2 ø 8mm D3 ø 8mm H2 12mm		
For models:	XF100, XF103, XF110, XF113, XF115, XF130, XF133, XF135		

1

Part No.	602124	Ref. No.	VN043
description	fan wheel D1 ø 196mm H1 61mm blades 39 D2 ø 8mm D3 ø 8x6.5mm H2 27mm		
For models:	XV501, XV501E		

1

Part No.	551100	Ref. No.	GN1140 GN1140A0 GN1140A1 KGN1140A
description	gasket for fan motor ID ø 10mm ED ø 40mm thickness 0.8mm		
For models:	XB403, XB403G, XB603, XB603G, XB693, XB695, XB803, XB803G, XB893, XB895, XBC1005, XBC404, XBC604, XBC605, XBC804, XBC805, XBC815G, XBT146, XBT160, XG413G, XG613G, XG813, XV1003G, XV203G, XV303G, XV593, XV703G, XVC054, XVC1004P, XVC1005P, XVC104, XVC105, XVC1204P, XVC2015G, XVC204, XVC205, XVC304, XVC305, XVC504, XVC505, XVC514G, XVC515G, XVC704, XVC705, XVC715G, XVC905P		





hot air fans

miscellaneous

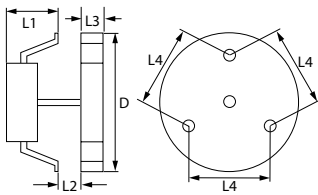

1



Part No.	601125	Ref. No.	VN050
description	hot air fan 220-240V 45W 50/60Hz L1 70mm L2 11mm L3 25mm L4 87mm fan wheel ø 150mm FIME type C30R0479CLF		
For models:	XF006, XF010, XF011, XF020, XF020R, XF030, XF030-TG, XF040, XF050, XF065		
accessories for	601125		
	Part No.	550879	Ref. No. —
	insulation ø 130mm thickness 3mm hole ø 20mm for hot air fan		

accessories

miscellaneous



1

Part No.	551279	Ref. No.	OH4305A1 KOH4305A KOH4305A OH4305A1
description	cover ø 71mm thickness 1.2mm hole ø 18mm shaft sealing		
For models:	XB693, XB695, XB893, XB895, XBC1005, XBC605, XBC805, XV593, XVC1005P, XVC1015G, XVC105, XVC205, XVC305, XVC315G, XVC505, XVC515G, XVC705, XVC715G, XVC905P		

motors

motors

for combi-steamers



1

Part No.	601948	Ref. No.	KVN0027A VN026
description	motor 120W 230V 50-60Hz 1 phase shaft ø 8mm shaft length 67mm flange ø 165mm ø 165mm H 150mm mounting distance 140mm SISME 0.12kW		
For models:	XV202, XV202E, XV301, XV301E, XV401, XV401E, XV501, XV501E		



1

Part No.	403419	Ref. No.	KVN1130A VN1130AO
description	motor UNOX XBC/XVC SISME		
For models:	XB693, XB695, XB893, XB895, XBC1005, XBC605, XBC805, XV593, XVC1005P, XVC1015G, XVC105, XVC2015G, XVC205, XVC305, XVC315G, XVC505, XVC515G, XVC705, XVC715G, XVC905P		

pumps

vibration pumps



1

Part No.	499350	Ref. No.	KVL0009A KVL1038A
description	vibration pump type MPP1.01.066.2/ST/S 230V 28W 50Hz inlet ø 6 outlet ø 8 kit L 111mm		



1

Part No.	499169	Ref. No.	EL070
description	vibration pump type NME Typ1C 230-240V 16W 50Hz inlet ø 5 outlet ø 8 ULKA L 90mm with holder		
For models:	XF113, XF133, XF135		



condensators & interference suppression filters

operating capacitors

metal



Part No.	365219	Ref. No.	CN1003A KCN1003A
description	operating capacitor capacity 6.3µF 400V tolerance 5% 50-60Hz ambient temperature max. -25 up to +70°C ø 35mm L 59.5mm M8 aluminium connection male faston 6.3mm		
For models:	XBC1005E, XBC1005EL, XBC1015EG, XBC1015EGL, XBC405E, XBC605E, XBC615EG, XBC805E, XBC905E, XBC905EL, XBC915EG, XBC915EGL, XV393, XVC055E, XVC1005EP, XVC1005EPL, XVC1015EG, XVC1015EGL, XVC105E, XVC105EP, XVC1205EP, XVC2005EP, XVC205E, XVC305E, XVC305EP, XVC315EG, XVC4005EP, XVC4005EPL, XVC4015EG, XVC4015EGL, XVC505E, XVC505EP, XVC515EG, XVC705E, XVC705EP, XVC715EG, XVC905EP, XVC905EPL, XVC915EG, XVC915EGL		

electric accessories

cables

power supply cables



Part No.	551263	Ref. No.	CE116 KMR1000A MR1000A0
description	power lead CEE7/7 type E+F 3-pole contacts P+N+E max. 16A max 250V 1.5m H07 RN-F with power terminal block countries D/F/B/I black		
For models:	XC110, XC111, XC224, XC314, XC400, XC503, XC595, XCH030, XF003, XF006, XF010, XF011, XF016, XF020, XF020R, XF023, XF030, XF030-TG, XF040, XF050, XF065, XF100, XF103, XF110, XF113, XF115, XF119, XF130, XF133, XF135, XG413, XG413G, XG613, XG613G, XG813, XG813G, XK304, XL041, XL051, XL091, XL135, XL146, XL195, XL314, XL404, XL405, XL503, XL504, XL505, XP010P..(Other models you can see in the webshop)		

ribbon cables

group 1

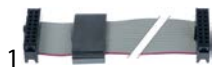

Part No.	403857	Ref. No.	CE1100A0 CE1100A1 KCE1100A
description	ribbon cable 16-pole L 1005mm plug type FC-16P raster size 2.54mm		

Part No.	403846	Ref. No.	CE1110A1 CE118
description	ribbon cable 20-pole L 1210mm plug type FC-20P raster size 2.54mm		
For models:	XV202E, XV401E		

terminals

connection terminals with screw/faston connections



Part No.	551260	Ref. No.	CE212 KMR1004A MR1004A0
description	power terminal block 7-pole max. 40A max 450V connection M5/ male faston 6.3mm temp.-resist. 150°C		
For models:	XB403, XB403G, XB603, XB603G, XB693, XB803, XB803G, XB893, XB895, XBC404, XBC604, XBC605, XBC804, XBC805, XBT146, XBT160, XV1003G, XV203G, XV303G, XV501, XV501E, XV593, XV703G, XVC2015G, XVC204, XVC205, XVC304, XVC305, XVC504, XVC505, XVC704, XVC705, XVT203G		

various



Part No.	550987	Ref. No.	CE1130A0
description	power terminal block 5-pole with cable cable length 1400mm		
For models:	XF190, XF193, XF195		

gas valves and ignition boxes

gas control valves

HONEYWELL





Part No.	107579	Ref. No.	EL1080A0
description	gas valve type VK4105A 1100 4 220/240V 50/60Hz gas inlet 3/4" gas outlet 3/4" pressure range 15-60mbar max 60mbar HONEYWELL		
For models:	XG413G, XG613, XG613G, XG813, XG813G		



SIT





SIGMA



1				
Part No.	101989	Ref. No.	EL014	
description	gas valve 230V 50Hz gas inlet 3/4" gas outlet 3/4" SIT pressure range 2-50mbar equiv. no. 0.840.016			
spare parts for	101989			
	Part No.	106214	Ref. No.	—
	solenoid coil 230V 50Hz Sigma			
accessories for	101989			
	Part No.	107222	Ref. No.	—
	plug for solenoid valve 3-pole cable length 1070mm			

TANDEM



1				
Part No.	101684	Ref. No.	EL015	
description	gas valve 230V 50Hz gas inlet 1/2" gas outlet 1/2" pilot connection level slow ignition standard ignition time 3-7s pressure range 3-50mbar power supply for modulator type SIT equiv. no. 0.830.034			
spare parts for	101684			
	Part No.	101379	Ref. No.	—
	solenoid coil 230V 50Hz suitable for Tandem			
accessories for	101684			
	Part No.	101274	Ref. No.	—
	olive for pipe ø 16mm Qty 1 pcs			
	Part No.	101275	Ref. No.	—
	union screw thread 1/2" for pipe ø 16mm Qty 1 pcs			
	Part No.	102845	Ref. No.	—
	gas connection angled 1/2" flange 32x32mm hole distance 24x24mm Tandem			
	Part No.	102846	Ref. No.	—
	gas connection straight 1/2" flange 32x32mm hole distance 24x24mm suitable for Tandem			

accessories for	101684			
	Part No.	102847	Ref. No.	—
	O-ring			

ignition boxes

HONEYWELL



1				
Part No.	103197	Ref. No.	KVE1055A VE1055A0 VE1055A1	
description	ignition box HONEYWELL type S4565C 3116B electrodes 2 waiting times safety time 5s 220-240V 4VA 50/60Hz			
For models:	XB613G, XB813G, XBC1015EG, XBC1015EGL, XBC615EG, XBC815EG, XBC815G, XBC915EG, XBC915EGL, XV513G, XV813G, XVC1015EG, XVC1015EGL, XVC1015G, XVC1215EG, XVC2015EG, XVC2015G, XVC315EG, XVC4015EG, XVC4015EGL, XVC515EG, XVC515G, XVC715EG, XVC715G, XVC915EG, XVC915EGL			

SIT



1				
Part No.	102306	Ref. No.	KVE001 VE045A	
description	ignition box SIT type 503EFD electrodes 1 waiting time 1.5s safety time 5s 220/240V 10VA 50-60Hz protection IP40			



ignition parts

electrodes



1

Part No.	107578	Ref. No.	BR1010A0 BR1010A1 BR1010B1
description	ignition electrode flange length 38mm flange width 17mm D1 ø 9.3mm L1 24mm L2 24mm BL1 70mm BL2 25mm connection 6		
For models:	XG413G, XG613, XG613G, XG813, XG813G		



1

Part No.	107824	Ref. No.	BR1310A0 KBR1310A
description	ignition electrode flange length 64mm flange width 23mm D1 ø 9.4mm L1 20mm L2 15mm BL1 22mm BL2 26mm connection ø 6mm		
For models:	XBC815G, XVC1015G, XVC2015G, XVC515G, XVC715G		



1

Part No.	106924	Ref. No.	BR1015A0 KBR1015A
description	monitoring electrode flange length 38mm D1 ø 9.5mm flange width 17mm L1 25mm L2 21mm BL1 70mm BL2 24mm connection 6 mounting distance 28mm with flange		
For models:	XG413G, XG613, XG613G, XG813, XG813G		

ignition units



1

Part No.	102485	Ref. No.	VE1065A0
description	ignition unit outputs 2 220-240VAC 0.6VA 50-60Hz		
For models:	XG413G, XG613, XG613G, XG813, XG813G, XVC1015G, XVC2015G, XVC515G, XVC715G		



1

Part No.	101002	Ref. No.	KVE1065A
description	ignition unit outputs 2 230VAC dimensions 88x23x34mm mounting distance 73mm inlet F6.3x0.8 outlet F2.8x0.8 0.6VA 50/60Hz		



1

Part No.	103348	Ref. No.	KVE0009B
description	ignition unit outputs 2 dimensions 85x62x38mm mounting distance 58/77mm set 4-piece 50/60Hz primary 230/240V secondary 28KV		

equipment-specific units

for proving cabinets

doors

magnets



1

Part No.	692817	Ref. No.	KVE1607A
description	door magnet 2 pieces ø 22mm thread M6 thread L 14.5mm rubber with plain washer		



for convection ovens/combi-steamers

flow controllers



Part No.	103347	Ref. No.	EL033
description	flow controller for hot air oven RFL-U connection 1/8" thread M12x1 hose ø 10mm		

spare parts and accessories



Part No.	694497	Ref. No.	KVM1235A VM1235A0
description	clip for door		
For models:	XBC404, XBC604, XBC605, XBC804, XBC805, XBC815G, XVC1204P, XVC2015G, XVC204, XVC205, XVC304, XVC305, XVC315G, XVC504, XVC505, XVC514G, XVC515G, XVC704, XVC705, XVC715G, XVC905P		



Part No.	694983	Ref. No.	CR1086A KCR1086A
description	hinge inner door with mounting kit mounting pos. lower		



Part No.	694982	Ref. No.	CR1085A CR1085A + GN1181A KCR1085A
description	hinge inner door with mounting kit mounting pos. upper		



Part No.	692804	Ref. No.	CR005 CR1080A CR1081A KCR1080A
description	hinge kit for inner door mounting pos. upper/lower		



Part No.	694984	Ref. No.	GN1180A0 KGN1180A
description	protector hinge L 95mm W 65mm Qty 4 pcs		

front panels



Part No.	508425	Ref. No.	KPE1315A PE1315A0
description	control panel convection oven L 800mm mounting pos. lower grey plastic suitable for LINE MISS UNOX		

housing and bezels



Part No.	691525	Ref. No.	VM1115A0
description	cover right		
For models:	XF103, XF113, XF133, XF183, XF193		

cleaning system

cleaning system assembly



Part No.	520999	Ref. No.	KVL0005A
description	cleaning system assembly group suitable for UNOX combi-steamer		



Part No.	521181	Ref. No.	KVL1044B
description	cleaning system suitable for UNOX combi-steamer		



cleaning arms



1

Part No.	542410	Ref. No.	KVL1037A VM1955A VM1955A0
description	cleaning arm suitable for UNOX combi-steamer		

drip water trays



1

Part No.	699456	Ref. No.	KVM1216B
description	drip tray L 747mm W 132mm H 24mm for combi-steamer UNOX		



1

Part No.	699457	Ref. No.	KVM1220A KVM1220A0
description	mounting set for drip pan combi-steamer UNOX 4-fold		

door mechanics

miscellaneous



1

Part No.	694987	Ref. No.	KVM1490A
description	cover for screws door handle for combi-steamer 2 pieces with screws		

vibration pumps



1

Part No.	499350	Ref. No.	KVL0009A KVL1038A
description	vibration pump type MPP1.01.066.2/ST/S 230V 28W 50Hz inlet ø 6 outlet ø 8 kit L 111mm		

knobs

producer-specific knobs

UNOX



1

Part No.	111495	Ref. No.	KMN1065A MN042 MN1065A0
description	dial plate thermostat 80-300°C ø 58/42.5mm black t.max. 300°C		
For models:	XF006, XF016, XF030, XF030-TG, XF090P, XV202, XV301, XV401, XV501		



1

Part No.	112846	Ref. No.	KMN1091A
description	knob temperature t.max. 300°C 80-300°C ø 40.5mm shaft ø 6x4.6mm shaft flat lower silver		



1

Part No.	112668	Ref. No.	KMN1091B
description	knob thermostat t.max. 260°C ø 41mm shaft ø 6x4.6mm shaft flat lower silver		



1

Part No.	112543	Ref. No.	MN1101A0 MN1101B0
description	knob thermostat t.max. 260°C ø 45mm shaft ø 6x4.6mm shaft flat lower silver temperature range 80-260°C rotation 270°		
For models:	XF003, XF023		



handles and hand wheels

handle bars

handle bars



1	Part No.	692803	Ref. No.	2H060
	description	handle rod tube ø 15mm thickness 1mm L 755mm SS Qty 1 pcs		

consoles



1	Part No.	692217	Ref. No.	KMG1015B MG1015B0
	description	console for handle rod H 43mm kit mounting pos. left/right		
	For models:	XF003, XF043, XF113, XF133, XL405, XVC105		



1	Part No.	690769	Ref. No.	KMG0119A MG0119A0 MG119
	description	console for handle rod tube ø 13mm H 41mm plastic Qty 2 pcs		
	For models:	XF006, XF011, XF016, XF030, XF030-TG, XF065, XF090P		

door handles

door handles



1	Part No.	692710	Ref. No.	KMG1035A MG1035A1
	description	door handle suitable for UNOX L 200mm W 24mm model XL SS		
	For models:	XL404		



1	Part No.	112542	Ref. No.	KMN1100A MN1100A0
	description	knob time 60min t.max.°C° ø 45mm shaft ø 6x4.6mm shaft flat lower gold		
	For models:	XF003, XF023, XF043		



1	Part No.	112794	Ref. No.	KMN1090B
	description	knob time range 0-60min shaft ø 6x4.6mm shaft flat lower		
	For models:	XFT113, XFT133, XFT183, XFT193		



1	Part No.	112853	Ref. No.	KMN1105A
	description	knob kit thermostat t.max. 400°C 120-400°C ø 55mm shaft ø 6x4.6mm shaft flat lower gold		

accessories

rosettes



1	Part No.	112541	Ref. No.	KMN1095A MN1095A0
	description	rosette for knob up to ø 41mm		
	For models:	XF103, XF113, XF133, XF183, XF193		



locks

handle latches

producer-specific



UNOX

locks



Part No.	694985	Ref. No.	KMG003 KMG1030B
description	door handle H 45mm L 180mm W 45mm UNOX mounting measurements 34x34mm		



Part No.	694350	Ref. No.	KMG001 KMG1000A MG1000A0
description	door handle heated units with door catch L 165mm W 40mm H 62mm mounting distance 60mm bolt ø 16mm bolt 85mm flange 79x40mm UNOX		
For models:	XB403, XB403G, XB603, XB603G, XB803, XB803G, XBT146, XBT160, XG413, XG413G, XG613, XG613G, XG813, XG813G, XV1003G, XV203G, XV303G, XV703G, XVT203G		
spare parts for	694350		
	Part No.	694734	Ref. No. —
	door handle L 165mm W 40mm H 25mm black		
	Part No.	694735	Ref. No. —
	cap ø 32mm black		

accessories



Part No.	694710	Ref. No.	VM1455A0
description	cover UNOX plastic grey L 100mm W 44mm mounting distance 65mm		
For models:	XBC1005, XVC1004P, XVC1005P, XVC1015G, XVC905P		



Part No.	694694	Ref. No.	KVM1191A VM1191A1
description	door catch H 30mm left L 75mm W 46mm mounting distance 63mm suitable for UNOX		
For models:	XBC605, XBC804, XBC805, XBC815G, XVC1204P, XVC205, XVC304, XVC305, XVC315G, XVC504, XVC505, XVC514G, XVC515G, XVC704, XVC705, XVC715G		



Part No.	694693	Ref. No.	KVM1190A VM1190A1 VM1190A2 VM1192A1
description	door catch H 30mm right L 75mm W 46mm mounting distance 63mm suitable for UNOX		
For models:	XB693, XB695, XB893, XB895, XBC1005, XBC605, XBC804, XBC805, XBC815G, XV593, XVC1004P, XVC1005P, XVC1015G, XVC1204P, XVC2015G, XVC205, XVC304, XVC305, XVC504, XVC505, XVC514G, XVC515G, XVC704, XVC705, XVC715G, XVC905P		

espagnolette locks

universal



Part No.	690040	Ref. No.	MG309
description	door catch with roller H 42mm L 40mm W 40mm zinc die cast mounting distance 26mm type 0751 series		

hinges

oven hinges

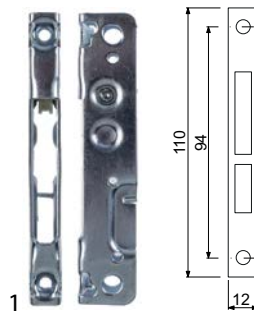

Part No.	693045	Ref. No.	CR100
description	opposite support L 110mm W 12mm mounting distance 94mm		
For models:	XF006, XF011, XF016, XF030, XF030-TG, XF065, XF090P		



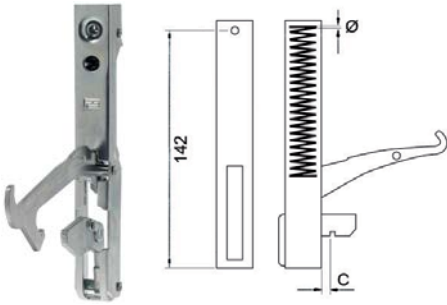

Part No.	701559	Ref. No.	CR1000A CR1000A0 KCR1000A
description	opposite support mounting distance 81mm L 134mm W 10mm		
For models:	XFT110, XFT113, XFT115, XFT130, XFT133, XFT135, XFT180, XFT183, XFT185, XFT188, XFT190, XFT193, XFT195		

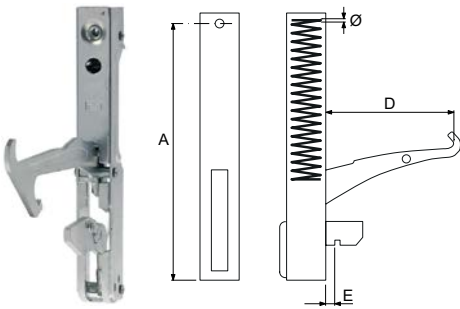

Part No.	700459	Ref. No.	CR070
description	oven hinge mounting distance 142mm mounting distance 2mm lug mountingmm lever length 117mm groove distance 7mm spring thickness 3.5mm mounting ear position spring length 58mm L 156mm W 22mm		
For models:	XF030, XF030-TG, XF065		
accessories for	700459		
	Part No.	693045	Ref. No. CR100
	opposite support L 110mm W 12mm mounting distance 94mm		



Part No.	700000	Ref. No.	CR065
description	oven hinge mounting distance 142mm mounting distance 2mm lug mountingmm lever length 127mm groove distance 10mm spring thickness 3.7mm mounting ear position L 155mm mounting pos. left/right		
For models:	XF090P		
accessories for	700000		
	Part No.	693045	Ref. No. CR100
	opposite support L 110mm W 12mm mounting distance 94mm		
	Part No.	700707	Ref. No. —
	opposite support mounting distance 94mm L 140mm mounting pos. left W 13mm with welded metal sheet H 110mm for hinge		



Part No.	701544	Ref. No.	KCR012 KCR1025A
description	oven hinge mounting distance 82mm spring thickness 3mm spring length 57mm L 155mm code A1 left/right Qty 2 pcs		

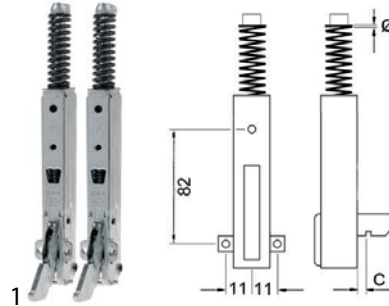

Part No.	700759	Ref. No.	CR1015A KCR013 KCR1015A
description	oven hinge mounting distance 82mm spring thickness 3mm spring length 57mm L 155mm code A3 left/right Qty 2 pcs		
accessories for	700759		
	Part No.	701559	Ref. No. CR1000A CR1000A0 KCR1000A
	opposite support mounting distance 81mm L 134mm W 10mm		





Part No.	700760	Ref. No.	CR1065A0 KCR020 KCR1065A
description	oven hinge mounting distance 87mm spring thickness 3mm L 150mm left/right Qty 2 pcs		
For models:	XF023		
accessories for	700760		
	Part No.	701552	Ref. No. CR1070A KCR1070A
	opposite support mounting distance 94mm L 112mm W 10mm		



			
1			
Part No.	440012	Ref. No.	CR025 KCR0025A
description	oven hinge set		
For models:	XF006, XF010, XF011, XF020, XF020R		

			
1			
Part No.	694558	Ref. No.	2xCR065+2xCR100 KCR0065A
description	oven hinge set lever length 125mm L 156mm suitable for UNOX		



			
1			
Part No.	700994	Ref. No.	KCR0070A KCR008
description	oven hinge set lever length 125mm L 156mm suitable for UNOX ARIANNA, ELENA		

			
1			
Part No.	701410	Ref. No.	CR1050A KCR016 KCR1050A
description	oven hinge set mounting distance 82mm spring thickness 3.4mm L 155mm left/right windings 13 Qty 2 pcs		
accessories for	701410		
	Part No.	701559	Ref. No. CR1000A CR1000A0 KCR1000A
opposite support mounting distance 81mm L 134mm W 10mm			

door bearing

			
1			
Part No.	701626	Ref. No.	KVM1165B VM1165A0 VM1165B0
description	hinge mounting pos. upper door		

			
1			
Part No.	701411	Ref. No.	KVM1236A VM1236A0
description	hinge block L 28mm W 31mm mounting pos. lower UNOX		
For models:	XBC404, XBC604, XBC605, XBC804, XBC805, XBC815G, XVC1204P, XVC2015G, XVC204, XVC205, XVC304, XVC305, XVC315G, XVC504, XVC505, XVC514G, XVC515G, XVC704, XVC705, XVC715G		

			
1			
Part No.	701409	Ref. No.	EVM0012A KVM0012A KVM1230A KVM1231A VM1231A0
description	mounting set for inner door UNOX		
For models:	XB693, XB893, XBC404, XBC604, XBC605, XBC804, XBC805, XBC815G, XV593, XVC1204P, XVC2015G, XVC204, XVC205, XVC304, XVC305, XVC315G, XVC504, XVC505, XVC514G, XVC515G, XVC704, XVC705, XVC715G, XVC905P		
spare parts for	701409		
	Part No.	694984	Ref. No. GN1180A0 KGN1180A
protector hinge L 95mm W 65mm Qty 4 pcs			

equipment feet and end caps

bolting feet

			
1			
Part No.	691521	Ref. No.	KPD1001A PD1000A0 PD1001A0
description	equipment foot ømm L 35mm W 35mm H 37mm bore ø 8mm mounting distance mm Qty 4 pcs		
For models:	XBC404, XBC604, XBC605, XBC804, XBC805, XBC815G, XC224, XC314, XF003, XF023, XF043, XF100, XF103, XF110, XF113, XF115, XF119, XF130, XF133, XF135, XF183, XF185, XF188, XF190, XF193, XF195, XP010P, XP010PR, XP010PT, XP020, XP020P, XP020PR, XP020PT, XP020R, XP020T, XVC054, XVC104, XVC105, XVC204, XVC205, XVC304, XVC305, XVC315G, XVC504, XVC505, XVC514G, XVC515G, XVC704, XVC705, XVC715G		



shelves and shelf rails

grid attachments

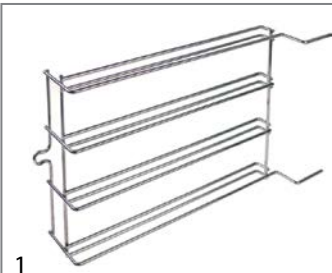

Part No.	691519	Ref. No.	GRL1025A0
description	rack support L 570mm H 230mm mounting pos. left/right		
For models:	XF190, XF193, XF195		

gaskets

gaskets for heated units

window seals

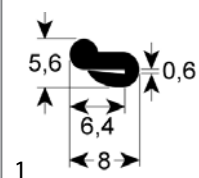

Part No.	901305	Ref. No.	GN100
description	window gasket profile 1876 Qty supplied by meter		
For models:	XB403, XB403G, XB603, XB603G, XB803, XB803G, XBT146, XBT160, XG413, XG413G, XG613, XG613G, XG813, XG813G, XV1003G, XV203G, XV303G, XV703G, XVT203G		

door seals

Part No.	902020	Ref. No.	KG1342C
description	door seal profile 2716		

Part No.	901843	Ref. No.	GN1250A0 KGN0015A KGN1388C
description	door seal profile 2716 Qty 2.7m		
For models:	XVC1004P		

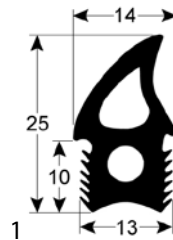

Part No.	902478	Ref. No.	GN1389C KGN1389C
description	door seal profile 2766 L 1855mm Qty 1		

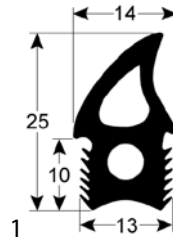

Part No.	902479	Ref. No.	GN1390C KGN1390C
description	door seal profile 2766 L 2250mm Qty 1		

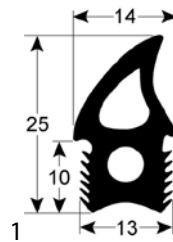

Part No.	902482	Ref. No.	GN1391C KGN1391C
description	door seal profile 2766 L 2520mm Qty 1		

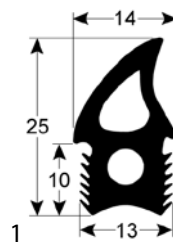

Part No.	902477	Ref. No.	GN1343C KGN1343C
description	door seal profile 2766 L 3070mm Qty 1		

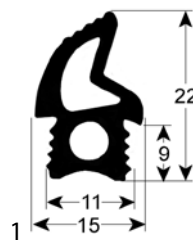

Part No.	902476	Ref. No.	GN1356B KGN1356B
description	door seal profile 2769 L 1370mm Qty 1		

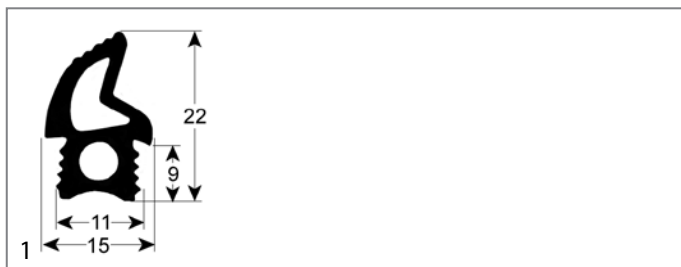

Part No.	902327	Ref. No.	KG1352A
description	door seal profile 2769 L 1600mm Qty 1		

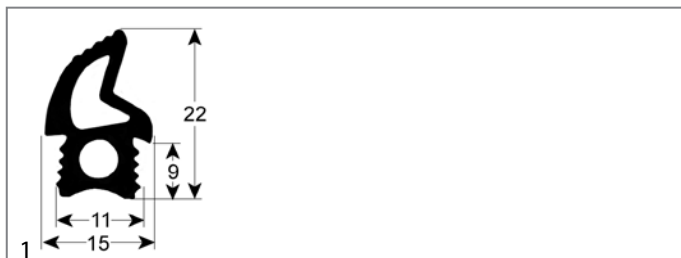

Part No.	902475	Ref. No.	GN1036B KGN1036B
description	door seal profile 2769 L 1720mm Qty 1		



Part No.	902328	Ref. No.	KG1353A
description	door seal profile 2769 L 1900mm Qty 1		



Part No.	902217	Ref. No.	GN1354A KGN1354A
description	door seal profile 2769 L 2030mm Qty 1		
For models:	XFT190, XFT193, XFT195, XFT199, XFT200		



Part No.	900802	Ref. No.	GN1110A2
description	door seal profile 2769 L 2200mm Qty 1		
For models:	XF113, XF119, XF133, XF135, XF183, XF193, XL405, XVC054, XVC104, XVC105		



Part No.	900804	Ref. No.	GN1110A0
description	door seal profile 2769 L 2500mm		
For models:	XCH030, XF100, XF103, XF110, XF115, XF130, XF135, XF185, XF188, XF190, XF195		

door seals with fixing hook

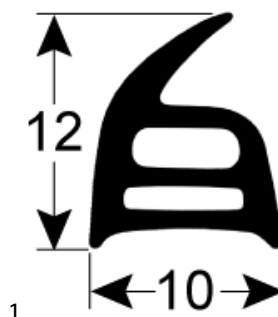

Part No.	902474	Ref. No.	GN1225A KGN1225A
description	door seal L 330mm W 230mm with 4 mounting clips		



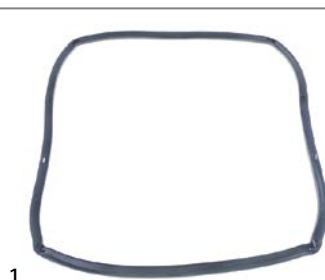

Part No.	901846	Ref. No.	KGN007A KGN007B
description	door seal L 420mm W 790mm 3-sided with mounting clip		





Part No.	901319	Ref. No.	GN021 GN021A GN021D KGN021D
description	door seal L 450mm W 350mm with 8 mounting clips		
For models:	XF030, XF030-TG, XF040, XF050, XF065, XV201, XV202, XV202E		





			
1			
Part No.	902396	Ref. No.	GN1230A GN1230A0 KGN1230A
description	door seal L 460mm W 250mm with 6 mounting clips mounting distance 450x230mmmm suitable for UNOX		

			
1			
Part No.	900803	Ref. No.	GN1235A GN1235A0 KGN1235A
description	door seal L 480mm W 320mm to be hooked in external size		
For models:	XF023		

			
1			
Part No.	902397	Ref. No.	GN025A KGN025A
description	door seal L 550mm W 350mm with 6 mounting clips mounting distance 520x310mmmm suitable for UNOX		

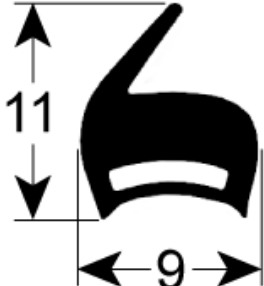
			
1			
Part No.	901321	Ref. No.	GN036 GN036C GN036D KGN036D
description	door seal L 650mm W 350mm with 8 mounting clips		
For models:	XF090P		

			
1			
Part No.	901848	Ref. No.	KGN070
description	door seal W 460mm 4-sided with mounting clip H 210mm		

			
1			
Part No.	901844	Ref. No.	GN008B GN008C KGN0008C KGN0008D
description	door seal W 640mm 3-sided with mounting clip H 610mm		

			
1			
Part No.	901847	Ref. No.	GN060 GN060D KGN060D
description	door seal W 660mm 4-sided with mounting clip H 230mm		

			
1			
Part No.	901634	Ref. No.	GN046 GN046D KGN046D
description	door seal W 660mm with 12 mounting clips H 420mm		
For models:	XV401, XV401E		

			
1			
Part No.	901845	Ref. No.	KGN1245A
description	door seal W 670mm 3-sided with mounting clip H 520mm		



springs

torsion springs

Part No.	692524	Ref. No.	KML1000A0 RC039A VI093
description	torsion spring set ø 24mm wire gauge ø 3.1mm L1 44mm Qty 1 pcs		
For models:	XP010P, XP010PR, XP010PT, XP020, XP020P, XP020PR, XP020PT, XP020R, XP020T		

fittings, hose and pipe connectors

push-in fittings

JOHN GUEST

Part No.	440671	Ref. No.	EL1195A EL1195A0 KEL1195A KEL1195A0
description	push-in fitting John Guest angled pipe connection ø8mm grommet ø 8mm		
For models:	XB693, XB695, XB893, XB895, XFT183, XFT185, XFT188, XFT193, XFT195, XFT199, XV593, XV893		
accessories for	440671		
	Part No.	520972	Ref. No. —
	hose John Guest thickness 1mm LLDPE blue ID ø 6mm ED ø 8mm		

Part No.	440592	Ref. No.	EL1185A EL1185A0 KEL1185B
description	push-in fitting John Guest angled pipe connection ø8mm - ø8mm		
For models:	XB693, XB695, XB893, XB895, XBC405E, XBC605E, XFT113, XFT115, XFT119, XFT133, XFT135, XV593, XV893		
accessories for	440592		
	Part No.	520972	Ref. No. —
	hose John Guest thickness 1mm LLDPE blue ID ø 6mm ED ø 8mm		

Part No.	440551	Ref. No.	EL1210A0 KEL1210A
description	push-in fitting John Guest straight thread 1/4" BSPT pipe connection ø8mm		
For models:	XBC1005, XBC605, XBC805, XBC815G, XC404, XC595, XVC1005P, XVC1015G, XVC105, XVC205, XVC305, XVC315G, XVC505, XVC514G, XVC515G, XVC705, XVC715G, XVC905P		

Part No.	440028	Ref. No.	KRC1365A RC1210A1
description	push-in fitting UNOX straight Qty 1 pcs thread 3/4" pipe connection ø8 sealing flat seal		
For models:	XB1083, XB613G, XB693, XB695, XB813G, XB893, XB895, XBC1005, XBC1005E, XBC1005EL, XBC1015EG, XBC1015EGL, XBC605, XBC615EG, XBC805, XBC805E, XBC815EG, XBC815G, XBC905E, XBC905EL, XBC915EG, XBC915EGL, XFT140, XFT183, XFT185, XFT188, XFT193, XFT195, XFT199, XFT200, XV1093, XV393, XV513G, XV593, XV813G, XV893, XVC055E, XVC1005EP, XVC1005EPL, XVC1005P, XVC1015EG, XVC1015EGL, XVC1015G, XVC105, XVC105E, XVC105EP, XVC1204P, XVC1205EP, XVC1215EG, XVC2005EP...(Other models you can see in the webshop)		

<h4>DMfit</h4>			
Part No.	440857	Ref. No.	D0064 ELO22 EL1055A0 KEL1055A
description	push-in fitting DMfit straight pipe connection ø8mm - ø10mm		
For models:	XB403, XB403G, XB603, XB603G, XB803, XB803G, XBC404, XBC604, XBC605, XBC804, XBC805, XBC815G, XBT146, XBT160, XC110, XC111, XF090P, XF113, XF115, XF119, XF133, XF135, XF185, XF188, XF195, XG413, XG413G, XG613, XG613G, XG813, XG813G, XL041, XL091, XL503, XV1003G, XV202, XV202E, XV203G, XV301, XV301E, XV303G, XV401, XV401E, XV501, XV501E, XV703G, XVC054, XVC104, XVC105, XVC1204P...(Other models you can see in the webshop)		

water filters

miscellaneous

Part No.	530438	Ref. No.	KVL1034A VL1034A0
description	water filter operation p max 11bar water temperature 65°C for external tube ø (A) 8mm (B) 8mm		



beverage technology

valves

non-return valves



1

Part No.	440729	Ref. No.	KEL1180A
description	non-return valve John Guest pipe connection 5/16" - 5/16" operating pressure at 20°C 10bar opening pressure 0.02bar POM		

water cycle components

pressure reduction valves

pressure reduction valves

producer-specific



1

Part No.	520998	Ref. No.	KVL1014A
description	pressure reduction valve connection John Guest 8mm 90° p max 2.30bar T-piece plastic connection 1: 8 plug-in connectionmm connection 2: 10 plug-in connectionmm black		



1

Part No.	520997	Ref. No.	KVL0010A
description	pressure reduction valve connection John Guest 8mm p max 2.30bar plastic black		

tools

cleaning tools

scrapers



1

Part No.	890049	Ref. No.	KVM1000A
description	scraper for ceramic hobs		
spare parts for	890049		
	Part No.	890052	Ref. No. —
	spare blades for scraper Qty 10 pcs		

consumables

sealants and adhesives

high temperature silicone



1

Part No.	890050	Ref. No.	KSL1170A
description	high temperature silicone NOVASIL S76 acetoxy-curing -40 up to +265°C t.max. 280°C anthracite cartridge 310ml		
description	Novasil S56 - cartridge 310ml - anthracite - Developed for applications in the home appliance industry: - Gluing of oven door seals - Gluing of mounting brackets for cooker fascias, oven door seals and handles - Attachment of elastic seals, e.g. to oven doors Temperature resistance: -40°C to +265°C		

GASTROPARTS.COM



© 2020 Gastroparts Sp. J. All rights reserved.