



GASTROPARTS

Rosinox

[EN] Cooking

[DE] Kochtechnik

[ES] Cocción

[FR] Cuisson

[IT] Cottura

[PL] Obróbka termiczna

[RU] Термическая обработка

✉ gastroparts@gastroparts.com

☎ tel. +48 56 657 00 66

📘 fb.com/gastroparts.global

GASTROPARTS.COM









heating elements

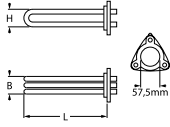

immersion heating elements

3 hole flange ø57.5mm



 			
Part No.	415021	Ref. No.	RX94810958 RX94813728
description	heating element 6000W 230V mounting ø 57.5mm heating circuits 3 L 343mm W 37mm H 50mm number of thermostat sleeves 1 thermostat sleeves ø 7mm length thermostat sleeves 294mm thermostat sleeve not clinging tube ø 8.5mm hole distance 72mm hole ø 8mm connection M5 3 hole flange		
spare parts for	415021		
		Part No.	510409 Ref. No. RX94807294
	O-ring EPDM thickness 5.34mm ID ø 56.52mm Qty 1 pcs		
accessories for	415021		
		Part No.	550002 Ref. No. —
	tension strap H 10mm L 21mm W 10mm hole ø 6.5mm for heating element		

with expansion flange 70 x 18mm

			
Part No.	415465	Ref. No.	27318591 RX27318591
description	heating element 3000W 230V heating circuits 2 flange 70x18mm L 365mm W 65mm connection male faston 6.3mm tube ø 8.5mm immersion heater expansion flange		
accessories for	415465		
		Part No.	379078 Ref. No. —
	temperature probe thermocouple K (NiCr-Ni) cable silicone probe -50 up to 1150°C cable -50 up to +180°C connection 2-wire thread probe ø1.5x100mm cable length 1.8m		

			
Part No.	415466	Ref. No.	27318583 RX27318583
description	heating element 6000W 230V heating circuits 2 flange 70x18mm L 365mm W 65mm connection male faston 6.3mm tube ø 8.5mm immersion heater expansion flange connection length 32mm		
accessories for	415466		
		Part No.	379078 Ref. No. —
	temperature probe thermocouple K (NiCr-Ni) cable silicone probe -50 up to 1150°C cable -50 up to +180°C connection 2-wire thread probe ø1.5x100mm cable length 1.8m		

heating elements for convection

			
Part No.	415251	Ref. No.	94806387 RX94806387
description	heating element 2500W 230V heating circuits 1 ID ø 178mm ED ø 190mm L 242mm H 35mm L1 46mm W1 31mm H1 10mm H2 25mm flange length 70mm flange width 22mm hole distance 56mm connection male faston 6.3mm horizontal tube ø 6.3mm convection heating element hole ø 5mm rectangular flange		
spare parts for	415251		
		Part No.	510368 Ref. No. —
	gasket L 70mm W 23.5mm hole ø 5mm hole distance 56mm FIBER thickness 2mm for heating element		

			
Part No.	418131	Ref. No.	RX94814229
description	heating element 6000W 230V heating circuits 3 ID ø 217mm ED ø 231mm L 271mm H 90mm L1 41mm W1 103mm H1 24mm H2 66mm flange length 140mm flange width 22mm hole distance 63mm tube ø 6.3mm convection heating element hole ø 5mm rectangular flange		







			
Part No.	415911	Ref. No.	27307982 RX27307982
description	heating element 9000W 230V heating circuits 4 ID ø 310mm ED ø 333mm L 410mm H 115mm L1 77mm W1 75mm H1 15mm H2 100mm thread M14x1.5 8 hole fixing connection male faston 6.3mm tube ø 8.5mm convection heating element		
accessories for	415911		
		Part No.	510417 Ref. No. —
	flat gasket fibre ED ø 20mm ID ø 14mm thickness 2mm Qty 1 pcs		
		Part No.	520228 Ref. No. —
	tooth lock washer ID ø 15.3mm ED ø 24mm steel Qty 1 pcs for thread M14		
		Part No.	520230 Ref. No. —
	nut thread M14x1.5 H 5mm WS 19 zinc-coated steel Qty 1 pcs		
		Part No.	521101 Ref. No. —
	nut thread M14x1.5 H 5mm WS 19 SS Qty 1 pcs		

Table continues overleaf





accessories for	415911		
	Part No.	550262	Ref. No. —
	flat gasket copper ED ø 20mm ID ø 14mm thickness 2mm		

			
Part No.	415469	Ref. No.	27307974 RX27307974
description	heating element 2000W 220V heating circuits 1 L 95mm W 520mm connection length 24mm connection male faston 6.3mm tube ø 6.3mm thread M14x1.5 2 hole fixing convection heating element mounting distance 514mm		
accessories for	415469		
	Part No.	510417	Ref. No. —
	flat gasket fibre ED ø 20mm ID ø 14mm thickness 2mm Qty 1 pcs		
	Part No.	520228	Ref. No. —
	tooth lock washer ID ø 15.3mm ED ø 24mm steel Qty 1 pcs for thread M14		
	Part No.	520230	Ref. No. —
	nut thread M14x1.5 H 5mm WS 19 zinc-coated steel Qty 1 pcs		
	Part No.	521101	Ref. No. —
	nut thread M14x1.5 H 5mm WS 19 SS Qty 1 pcs		
	Part No.	550262	Ref. No. —
	flat gasket copper ED ø 20mm ID ø 14mm thickness 2mm		



			
Part No.	415554	Ref. No.	27307966 RX27307966
description	heating element 2500W 230V heating circuits 1 L 148mm W 534mm connection male faston 6.3mm tube ø 6.3mm thread M14x1.5 2 hole fixing convection heating element mounting distance 528mm		
spare parts for	415554		
	Part No.	510420	Ref. No. —
	gasket copper ED ø 19.9mm ID ø 14.3mm thickness 2mm Qty 1 pcs		
accessories for	415554		
	Part No.	510417	Ref. No. —
	flat gasket fibre ED ø 20mm ID ø 14mm thickness 2mm Qty 1 pcs		
	Part No.	520228	Ref. No. —
	tooth lock washer ID ø 15.3mm ED ø 24mm steel Qty 1 pcs for thread M14		
	Part No.	520230	Ref. No. —
	nut thread M14x1.5 H 5mm WS 19 zinc-coated steel Qty 1 pcs		
	Part No.	521101	Ref. No. —
	nut thread M14x1.5 H 5mm WS 19 SS Qty 1 pcs		
	Part No.	550262	Ref. No. —
	flat gasket copper ED ø 20mm ID ø 14mm thickness 2mm		

accessories

washers			
			
Part No.	560112	Ref. No.	94813766 RX94813766
description	plain washer ID ø 5.3mm ED ø 10mm thickness 1mm SS Qty 20 pcs DIN 125A for thread M5		

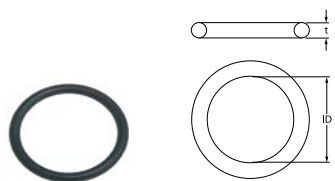
			
Part No.	560333	Ref. No.	RX94801651
description	plain washer ID ø 6.4mm ED ø 12mm thickness 1.6mm SS Qty 1 pcs DIN 125A for thread M6		

sealing washers			
O-rings			
			
Part No.	510408	Ref. No.	RX94807781
description	O-ring EPDM thickness 5.34mm ID ø 47mm Qty 1 pcs		

flange gaskets			
			
Part No.	551240	Ref. No.	RX94820023
description	gasket L 129mm W 87mm D1 ø 12mm D2 ø 7mm 12 holes graphite thickness 1mm		
accessories for	551240		
	Part No.	519647	Ref. No. —
	counterflange ø 8mm perforation ø 13mm L 130mm W 88mm suitable for convection heating element 12 holes		



energy regulators

EGO

1-circuit



Part No.	380015	Ref. No.	94812641 RX94812641
description	energy regulator 230V 13A single-circuit turn direction right shaft \varnothing 6x4.6mm shaft L 23mm mounting thread M4 power release 6-100% no. 50.57021.010		

thermostats

control and safety thermostats

EGO

control thermostats

55.10/19_series



Part No.	375231	Ref. No.	94805249 RX94805249
description	thermostat t.max. 90°C temperature range 30-90°C 1-pole 1NO 16A probe \varnothing 6mm probe L 130mm capillary pipe 900mm capillary pipe isolated 600mm gland nut M9x1 shaft L 18mm shaft position upper rotation 270°		

55.13_series



Part No.	375401	Ref. No.	24848269 RX24848269
description	thermostat t.max. 185°C temperature range 97-185°C 1-pole 1NO 16A probe \varnothing 6mm probe L 87mm capillary pipe 1430mm capillary pipe isolated 1100mm gland nut M9x1 shaft \varnothing 6x4.6mm shaft L 23mm shaft position upper rotation 270°		

E-G-O



Part No.	375085	Ref. No.	24848145 RX24848145
description	thermostat t.max. 90°C temperature range 0-90°C 1-pole 1CO 16A probe \varnothing 3.1mm probe L 247mm capillary pipe 1430mm capillary pipe isolated 1400mm gland nut shaft \varnothing 6x4.6mm shaft L 18mm shaft position upper probe material SS		

55.34_series

E-G-O

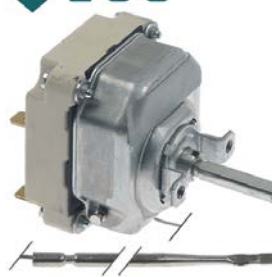

Part No.	375192	Ref. No.	94805645 RX94805645
description	thermostat t.max. 300°C temperature range 50-300°C 3-pole 3NO 16A probe \varnothing 3mm probe L 219mm capillary pipe 900mm capillary pipe isolated 600mm gland nut shaft \varnothing 6x4.6mm shaft L 23mm shaft position upper rotation 270°		

E-G-O



Part No.	375038	Ref. No.	94032588 RX94032588
description	thermostat t.max. 300°C temperature range 50-300°C 3-pole 3NO 16A probe \varnothing 6mm probe L 79mm capillary pipe 1740mm capillary pipe isolated 800mm gland nut shaft \varnothing 6x4.6mm shaft L 23mm shaft position upper rotation 270°		
accessories for	375038		
	Part No.	110123	Ref. No. —
	knob thermostat t.max. 300°C \varnothing 50mm shaft \varnothing 6x4.6mm shaft flat upper black temperature range 50-300°C rotation 270°		



safety thermostats

51._ series



Part No.	375090	Ref. No.	24848111 RX24848111
description	safety thermostat switch-off temp. 365°C 2-pole 16A probe ø 4mm probe L 120mm capillary pipe 1170mm capillary pipe isolated 1100mm gland nut probe SS		

55.13_ series



Part No.	375830	Ref. No.	RX94050481
description	safety thermostat switch-off temp. 365°C 1-pole 1NC 16A probe ø 3mm probe L 160mm capillary pipe 1730mm capillary pipe isolated 1710mm gland nut probe		

55.32_ series



Part No.	375277	Ref. No.	94805413 RX94805413
description	safety thermostat switch-off temp. 150°C 3-pole 3NC 20A probe ø 6mm probe L 79mm capillary pipe 900mm capillary pipe isolated 700mm gland nut probe		

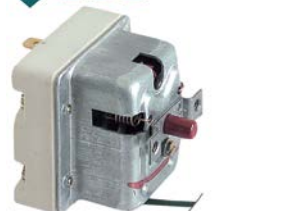

Part No.	375344	Ref. No.	94800158 RX94800158
description	safety thermostat switch-off temp. 360°C 1-pole 0.5A probe ø 4mm probe L 120mm capillary pipe 1500mm capillary pipe isolated 1500mm gland nut probe		



Part No.	375684	Ref. No.	94814230 RX94814230
description	safety thermostat switch-off temp. 360°C 1-pole 20A probe ø 11mm probe L 16mm capillary pipe 900mm capillary pipe isolated 900mm gland nut probe screw-in probe probe thread M14x1		

56._ series





Part No.	390797	Ref. No.	RX24848343
description	safety thermostat switch-off temp. 157°C 1-pole 16A probe ø 6mm probe L 62mm capillary pipe 1520mm capillary pipe isolated 1380mm gland nut probe		



Part No.	375889	Ref. No.	RX94820005
description	safety thermostat switch-off temp. 360°C 1-pole 16A probe ø 15mm probe L 6.5mm capillary pipe 1140mm capillary pipe isolated 1100mm gland nut probe		
accessories for	375889		
	Part No.	518669	Ref. No. RX94820006
	gasket PTFE ED ø 21mm ID ø 15mm thickness 3.5mm		

accessories



Part No.	518669	Ref. No.	RX94820006
description	gasket PTFE ED ø 21mm ID ø 15mm thickness 3.5mm		
accessories for	518669		
	Part No.	375889	Ref. No. RX94820005
	safety thermostat switch-off temp. 360°C 1-pole 16A probe ø 15mm probe L 6.5mm capillary pipe 1140mm capillary pipe isolated 1100mm gland nut probe		

control thermostats with operation switch

55.34_ series



Part No.	375246	Ref. No.	RX94090032
description	thermostat t.max. 645°C temperature range 100-615/645°C 2-pole 2NO 16A probe ø 4mm probe L 230mm capillary pipe 1100mm capillary pipe isolated 600mm gland nut shaft ø 6x4.6mm shaft L 25mm shaft position lower rotation 270° outer switch 2NO probe material copper		

accessories

connecting bows





Part No.	550060	Ref. No.	RX94002813
description	connecting bow long for thermostat Qty 1 pcs		

switches and momentary switches

rocker/momentary rocker switches

30x22mm



Part No.	301003	Ref. No.	94805496 RX94805496
description	rocker switch mounting measurements 30x22mm green 2NO 250V 16A illuminated 0-l connection male faston 6.3mm ambient temperature max. 125/55°C protection IP65		
accessories for	301003		
	Part No.	301036	Ref. No. —
	protective cover internal size 30x22mm for rocker switch mounting measurementsmm		

push/momentary push switches

ø18.2mm



Part No.	346508	Ref. No.	26645481 RX26645481
description	momentary push switch mounting ø 18.2mm black 1NC/1NO 250V 2A connection screw ambient temperature max. 85°C protection IP40		

ø25mm



Part No.	345038	Ref. No.	94805173 RX94805173
description	momentary push switch mounting ø 25mm black 2NO 250V 16A connection male faston 6.3mm ambient temperature max. 85°C protection IP40		



microswitches

lever actuated



1

Part No.	345254	Ref. No.	94812476 RX94812476
description	microswitch with lever 250V 16A 1CO connection male faston 6.3mm ambient temperature max. 120°C mounting distance 22mm actuating force: 60g lever length 58mm		



1

Part No.	345257	Ref. No.	RX94810935
description	microswitch with lever 250V 16A 1CO connection male faston 6.3mm L 29mm L1 33mm ambient temperature max. 120°C mounting distance 22mm actuating force: 130g lever length 31.5mm		

pin-plunger actuated

M12



1

Part No.	345350	Ref. No.	RX94806130
description	microswitch with plunger mounting distance 22mm thread M12x0.75 thread L 16mm 250V 16A 1CO connection male faston 6.3mm stroke 4mm ambient temperature max. 125°C type EF83161.3 actuating force: 66g		
accessories for	345350		
	Part No.	345351	Ref. No.
			—
	nut thread M12x0.75 H 1.6mm WS 14 chrome-plated brass Qty 1 pcs		

M16



1

Part No.	345047	Ref. No.	RX94050119
description	microswitch with plunger thread M16x1 thread L 27mm 250V 5A 1NO connection cable stroke 5mm ambient temperature max. 85°C with cable type 837333 actuating force: 400g		
accessories for	345047		
	Part No.	698490	Ref. No.
			RX94029824
	cover ED ø 17mm suitable for 345047		

system switches (ROLD)



1

Part No.	346201	Ref. No.	94804119 RX94804119
description	element holder mounting measurements 28.5x77.5mm grey threefold element holder		



1

Part No.	345601	Ref. No.	94813812 RX94813812
description	indicator lamp holder V ø 11mm		



1

Part No.	347193	Ref. No.	94810898 RX94810898
description	momentary switch unit 1NO 250V 16A connection male faston 6.3mm		



1

Part No.	345606	Ref. No.	RX94813834
description	momentary switch unit 2CO 250V 16A connection male faston 6.3mm		



1

Part No.	345605	Ref. No.	94804143 94810976 RX94804143 RX94810976
description	switch 2CO 250V 16A connection male faston 6.3mm		



cam switches

on/off

E-G-O





1

Part No.	300088	Ref. No.	94805363 RX94805363
description	cam switch 2 operating positions 4NO sequence 0-1 16A shaft \varnothing 6x4.6mm shaft L 23mm connection male faston 6.3mm ceramic		



1

Part No.	300020	Ref. No.	94805256 RX94805256
description	cam switch 4 operating positions 2NO sequence 0-1-0-1 16A shaft \varnothing 6x4.6mm shaft L 23mm connection screw ceramic		
accessories for	300020		
	Part No.	110135	Ref. No. —
	rosette knob up to \varnothing 52mm		
	Part No.	110231	Ref. No. —
	knob switch 0-1-0-1 t.max.°C \varnothing 50mm shaft \varnothing 6x4.6mm shaft flat upper black		

4-position

E-G-O



1

Part No.	300103	Ref. No.	RX273349196
description	cam switch 4 operating positions 1NO/2CO sequence 0-1-2-3 32A shaft \varnothing 6x4.6mm shaft L 23mm connection screw ceramic		

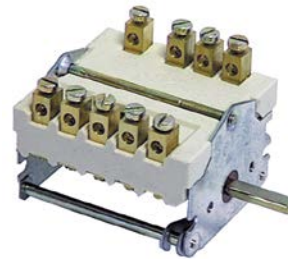

1

Part No.	300104	Ref. No.	RX27334937
description	cam switch 4 operating positions 3NO/1CO sequence 0-1-2-3 32A shaft \varnothing 6x4.6mm shaft L 23mm connection screw ceramic		

7-position

E-G-O



1

Part No.	300106	Ref. No.	RX94015021
description	cam switch 7 operating positions 1NO/2CO sequence 0-1-2-3-4-5-6 32A shaft \varnothing 6x4.6mm shaft L 23mm connection screw 7-position shaft flat upper		

4 operating positions



1

Part No.	300049	Ref. No.	27338144 RX27338144
description	cam switch 4 operating positions 8NO sequence 0-1-2-3 16A shaft \varnothing 6x4.6mm shaft L 17mm connection male faston 6.3mm		

6 operating positions

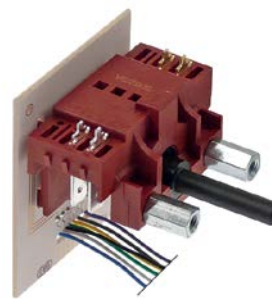

1

Part No.	300051	Ref. No.	27338136 RX27338136
description	cam switch 6 operating positions 2NO sequence 1-0-2-3-4-5 6A shaft \varnothing 6x4.6mm shaft L 33mm connection male faston 6.3mm plastic		



operation switches



1

Part No.	300002	Ref. No.	RX94806098
description	cam switch 2 operating positions 4NO 16A sequence 0-1 shaft \varnothing 6x4.6mm shaft L 23mm connection male faston 6.3mm ceramic		



1

Part No.	300080	Ref. No.	94805892 RX94805892
description	cam switch 2 operating positions 4NO 16A sequence 0-1 shaft \varnothing 6x4.6mm shaft L 23mm connection screw operation switch ceramic ambient temperature max. 150°C		

accessories for 300080

	Part No.	551456	Ref. No.	—
	gasket for switch ED \varnothing 14mm ID \varnothing 2.5mm thickness 3.5mm white			



1

Part No.	300200	Ref. No.	RX94015070
description	operation switch 2 operating positions 2NO 16A sequence 0-1 shaft \varnothing 6x4.6mm shaft L 23mm connection male faston 6.3mm operation switch ceramic		

rotary switches

TELEMECANIQUE (Schneider Electric)



1

Part No.	300047	Ref. No.	27338060 RX27338060
description	rotary switch 4 operating positions 9-pole		

magnetic switches

40x13mm



1

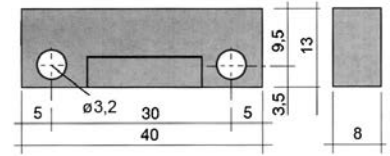



Part No.	345990	Ref. No.	94808292 RX94808292
description	magnetic switch L 40mm W 13mm 1NO 250V 0.04A P max. 10W connection male faston 6.3mm cable length 2000mm		

65x20mm

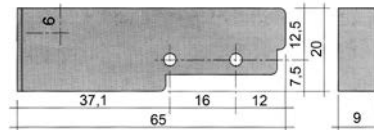

1



Part No.	345116	Ref. No.	RX94807161	
description	magnetic switch L 65mm W 20mm 1NO 250V 0.4A P max. 100W connection cable cable length 3000mm			
accessories for	345116			
	Part No.	345399	Ref. No.	—
	magnet \varnothing 3.3mm L 40mm H 8mm W 13mm hole distance 30mm M3			



ø 5.22mm



1

Part No.	347011	Ref. No.	RX94820059
description	magnetic switch 250V 0.04A P max. 10W probe L 26mm 1NO cable length 1000mm		

accessories

magnets

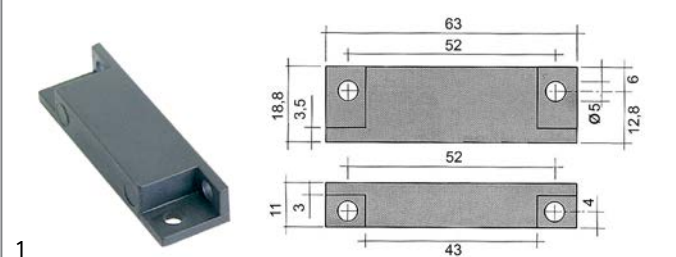

1

Part No.	345336	Ref. No.	94809266 RX94809266
description	magnet ø 4.8mm L 63mm H 11mm W 18.8mm hole distance 51mm M4		

control equipment

JKN (Square D)

rotary switches



1

Part No.	110260	Ref. No.	27338078 RX27338078
description	rotary selector mounting measurements ø22mm		

accessories for	110260		
	Part No.	110261	Ref. No. —
	rotary selector		

TELEMECANIQUE (EFA)

XB2 series

rotary switches



1

Part No.	345223	Ref. No.	94800885 RX94800885
description	rotary selector mounting measurements ø22mm black latching sequence 1-0-2		

encoders and potentiometers



1

Part No.	401338	Ref. No.	RX94814233
description	encoder		



1

Part No.	300247	Ref. No.	94050333 RX94050333
description	potentiometer 2.2kOhm rotation 270° shaft ø 6mm shaft L 16mm thread M10x0.75 plug type coded cable length 150mm		

lamps

indicator lights

indicator lights 2-piece (lens and indicator lamp)

indicator light lenses

ø10mm (type SRZ-3)





1

Part No.	359123	Ref. No.	RX94810956
description	indicator light housings mounting measurements ø10mm green round Qty 1 pcs		

accessories for	359123		
	Part No.	359132	Ref. No. 94813811 RX94813811
	indicator lamp green 250V connection male faston 6.3mm protection IP54 ambient temperature max. 85°C		





indicator lamps for socket type SRZ / SDK / SDY / SFK			
1 			
Part No.	359130	Ref. No.	94801073 94809845 RX94801073 RX94809845
description	indicator lamp 230V clear connection male faston 6.3mm ø 8mm		

1 			
Part No.	359132	Ref. No.	94813811 RX94813811
description	indicator lamp green 250V connection male faston 6.3mm protection IP54 ambient temperature max. 85°C		

indicator lights 3-piece (housing, lens and bulb) lamps			
light bulbs			
1 			
Part No.	359598	Ref. No.	27610302 RX27610302
description	light bulb socket Ba15d 230V 5-7W ø 16mm L 35mm		

1 			
Part No.	359608	Ref. No.	27610153 RX27610153
description	light bulb socket E14 10/15W 230V ø 16mm L 51mm lens L 31mm Qty 1 pcs		

1 			
Part No.	359597	Ref. No.	27610286 RX27610286
description	light bulb socket T10 24V 2W ø 10mm L 28mm		

neon light bulbs			
1 			
Part No.	359585	Ref. No.	RX27610179
description	neon light bulb socket E10 230V green ø 10mm L 28mm		
accessories for	359585		
	Part No.	359060	Ref. No. —
lamp socket mounting measurements ø16.2mm socket E10 connection screw			

accessories for	359585		
	Part No.	359685	Ref. No. —
lamp socket mounting measurements ø16.2mm socket E10			

indicator lights (complete) ø10mm			
with plug-in socket			
1 			
Part No.	359140	Ref. No.	94812468 RX94812468
description	indicator light ø 10mm yellow 230V connection male faston 6.3mm Qty 1 pcs		

ø12mm			
with screw socket			
1 			
Part No.	359048	Ref. No.	RX94806353
description	indicator light ø 12mm 230V yellow connection male faston 6.3mm		

1 			
Part No.	359291	Ref. No.	RX94806346
description	indicator light ø 12mm 400V green connection male faston 6.3mm		

ø13mm			
with plug-in socket			
1 			
Part No.	359045	Ref. No.	94801529 RX94801529
description	indicator light ø 13mm clear 230V connection male faston 6.3mm temp.-resist. 120°C Qty 1 pcs		

1 			
Part No.	359141	Ref. No.	94801511 RX94801511
description	indicator light ø 13mm red 230V connection male faston 6.3mm temp.-resist. 120°C Qty 1 pcs		

1 			
Part No.	359143	Ref. No.	94801537 RX94801537
description	indicator light ø 13mm yellow 230V connection male faston 6.3mm temp.-resist. 120°C Qty 1 pcs		



screw-on/push-on fit

neon light bulbs



1

Part No.	359585	Ref. No.	RX27610179
-----------------	--------	-----------------	------------

description	neon light bulb socket E10 230V green ø 10mm L 28mm		
--------------------	---	--	--

accessories for	359585		
------------------------	--------	--	--



Part No.	359060	Ref. No.	—
-----------------	--------	-----------------	---

description	lamp socket mounting measurements ø16.2mm socket E10 connection screw		
--------------------	---	--	--



Part No.	359685	Ref. No.	—
-----------------	--------	-----------------	---

description	lamp socket mounting measurements ø16.2mm socket E10		
--------------------	--	--	--

light bulbs

for ovens



1

Part No.	359610	Ref. No.	RX27610120
-----------------	--------	-----------------	------------

description	light bulb t.max. 300°C socket E14 15W 230V ø 22mm L 47mm lens L 20mm for oven lamp type Philips		
--------------------	--	--	--

for indicator lights



1

Part No.	359598	Ref. No.	27610302 RX27610302
-----------------	--------	-----------------	------------------------

description	light bulb socket Ba15d 230V 5-7W ø 16mm L 35mm		
--------------------	---	--	--



1

Part No.	359608	Ref. No.	27610153 RX27610153
-----------------	--------	-----------------	------------------------

description	light bulb socket E14 10/15W 230V ø 16mm L 51mm lens L 31mm Qty 1 pcs		
--------------------	---	--	--



1

Part No.	359597	Ref. No.	27610286 RX27610286
-----------------	--------	-----------------	------------------------

description	light bulb socket T10 24V 2W ø 10mm L 28mm		
--------------------	--	--	--

halogen lamp

for socket G4 / G6.35 / G9

1 **500°C**

Part No.	359599	Ref. No.	RX94820004
-----------------	--------	-----------------	------------

description	halogen lamp socket G4 12V 20W temp.-resist. 500°C		
--------------------	--	--	--

oven lamps

universal oven lamps

mounting diameter 35.5mm



1

Part No.	359701	Ref. No.	27610104 RX27610104
-----------------	--------	-----------------	------------------------

description	lamp socket socket E14 220-230V mounting ø 35.5mm connection male faston 6.3mm 15W		
--------------------	--	--	--

accessories for	359701		
------------------------	--------	--	--



Part No.	359705	Ref. No.	—
-----------------	--------	-----------------	---

description	oven lamp glass thr.ø 33.5mm ø 52mm hard glas temp.-resist. 350°C		
--------------------	---	--	--



Part No.	359709	Ref. No.	RX27610112
-----------------	--------	-----------------	------------

description	oven lamp glass thr.ø 33.5mm ø 42mm hard glas temp.-resist. 350°C		
--------------------	---	--	--



Part No.	359721	Ref. No.	RX24390700
-----------------	--------	-----------------	------------

description	gasket silicone ED ø 48mm ID ø 39.5mm thickness 5mm Qty 1 pcs		
--------------------	---	--	--



Part No.	359942	Ref. No.	—
-----------------	--------	-----------------	---

description	oven lamp glass thr.ø 33.5mm ø 41mm hard glas temp.-resist. 350°C		
--------------------	---	--	--



1

Part No.	359709	Ref. No.	RX27610112
-----------------	--------	-----------------	------------

description	oven lamp glass thr.ø 33.5mm ø 42mm hard glas temp.-resist. 350°C		
--------------------	---	--	--





1

Part No.	359721	Ref. No.	RX24390700
-----------------	--------	-----------------	------------

description	gasket silicone ED ø 48mm ID ø 39.5mm thickness 5mm Qty 1 pcs		
--------------------	---	--	--



55x70mm			
			
1			
Part No.	359375	Ref. No.	94814234 RX94814234
description	lamp socket complete version socket E14 mounting measurements 55x70mm		

lamps			
light bulbs			
			
1			
Part No.	359610	Ref. No.	RX27610120
description	light bulb t.max. 300°C socket E14 15W 230V ø 22mm L 47mm lens L 20mm for oven lamp type Philips		

halogen lamps			
for socket G4 / G6.35 / G9			
			
1 500°C			
Part No.	359599	Ref. No.	RX94820004
description	halogen lamp socket G4 12V 20W temp.-resist. 500°C		

timers

electric timers





			
1			
Part No.	350001	Ref. No.	27298066 RX27298066
description	timer 2CO at 250V 16A permanent position yes impulse electric shaft ø 6x4.6mm shaft L 22mm mounting distance 28mm connection rear 2-pole operation time 120min		

with time spread			
			
1			
Part No.	350074	Ref. No.	RX27298215
description	timer MS65 operation time 120min time spread 30min 1CO/2NO/1NC at 250V 16A permanent position yes impulse electric shaft ø 6x4.6mm shaft L 22mm mounting distance 28mm connection lateral Invensys 4-pole shaft position lower°		

alarm devices

buzzers			
			
1			
Part No.	350050	Ref. No.	94027794 RX94027794
description	buzzer 230VAC connection male faston 6.3mm screw mounting thread M4 60dB		

contactors

GENERAL ELECTRIC (AEG)				
power contactors				
				
1				
Part No.	380267	Ref. No.	27400308 RX27400308	
description	power contactor resistive load 110A 230VAC (AC3/400V) 65A/30kW main contacts 3NO auxiliary contacts connection screw connection type AEG LS30K 00A type GE CL07A 300			
accessories for	380267			
	Part No.	380268	Ref. No.	—
		auxiliary contact contacts 1NO for contactors CL+LS_K connection screw AC-12 10A type AEG HS07K 10 type GE BCLF 10		
	Part No.	380269	Ref. No.	—
		auxiliary contact contacts 1NC AC15 6A for contactors CL+LS_K connection screw AC-12 10A type AEG HS07K 01 type GE BCLF 01		
	Part No.	380270	Ref. No.	—
		auxiliary contact contacts 1NO/1NC for contactors CL+LS_K connection screw AC-12 10A type AEG HS08K 11 type GE BCLL 11		
	Part No.	380271	Ref. No.	—
		auxiliary contact contacts 2NO for contactors CL+LS_K connection screw AC-12 10A type AEG HS08K 20 type GE BCLL 20		







			
1			
Part No.	380239	Ref. No.	94804408 94813830 RX94804408 RX94813830
description	power contactor resistive load 20A 230VAC (AC3/400V) 8.4A/4kW main contacts 3NO auxiliary contacts 1NC connection screw connection type LS05 01A type AEG LS05 01A type GE MC1A 301A		

			
1			
Part No.	380238	Ref. No.	94814048 RX94814048
description	power contactor resistive load 20A 230VAC (AC3/400V) 8.4A/4kW main contacts 3NO auxiliary contacts 1NO connection screw connection type LS0510A type AEG LS0510A type GE MC1A 310A		

			
1			
Part No.	380244	Ref. No.	27400324 RX27400324
description	power contactor resistive load 25A 230VAC (AC3/400V) 9A/4kW main contacts 3NO auxiliary contacts 1NO connection screw connection type AEG LS4K 10A type GE CL00A 310		

			
1			
Part No.	380265	Ref. No.	27400282 RX27400282
description	power contactor resistive load 60A 230VAC (AC3/400V) 32A/16kW main contacts 3NO auxiliary contacts 1NO connection screw connection type AEG LS15K 00A type GE CL04A 310 H 98mm L 87mm W 55mm		

			
1			
Part No.	380695	Ref. No.	RX27400290
description	power contactor resistive load 90A 230VAC (AC3/400V) 50A/22kW main contacts 3NO auxiliary contacts connection screw connection type AEG LS22K 00A type GE CL06A 300		
accessories for	380695		
	Part No.	380268	Ref. No. —
	auxiliary contact contacts 1NO for contactors CL+LS_K connection screw AC-12 10A type AEG HS07K 10 type GE BCLF 10		
	Part No.	380269	Ref. No. —
	auxiliary contact contacts 1NC AC15 6A for contactors CL+LS_K connection screw AC-12 10A type AEG HS07K 01 type GE BCLF 01		
	Part No.	380270	Ref. No. —
	auxiliary contact contacts 1NO/1NC for contactors CL+LS_K connection screw AC-12 10A type AEG HS08K 11 type GE BCLL 11		
	Part No.	380271	Ref. No. —
	auxiliary contact contacts 2NO for contactors CL+LS_K connection screw AC-12 10A type AEG HS08K 20 type GE BCLL 20		

motor protection circuit breakers

			
1			
Part No.	380940	Ref. No.	94810902 RX94810902
description	motor protection circuit breaker type GPS1BSAH setting range 2.5-4A DIN rail contacts screw clamp		



TELEMECANIQUE (Schneider Electric)

power contactors



1

Part No.	380979	Ref. No.	RX94019155
description	power contactor resistive load 40A 230VAC (AC3/400V) 25A/11kW main contacts 3NO auxiliary contacts 1NO/1NC connection screw connection type LC1D25P7		

ABL SURSUM

motor protection circuit breakers



1

Part No.	380301	Ref. No.	RX94810904
description	motor protection circuit breaker type Mbs25-025 setting range 1.6-2.5A (AC3/400V) 1.1kW		

relays

power relays

with bracket mounting



1

Part No.	380312	Ref. No.	94804291 RX94804291
description	power relays FINDER 230VAC 10A 3CO connection male faston 4.8mm bracket mounting dimensions 52x32.2x36.5mm manuf. no. 60.63.8.230.0000		

1			
Part No.	380139	Ref. No.	94807054 94813866 RX94807054 RX94813866
description	power relays FINDER 230VAC 16A 2CO connection F6.3 bracket mounting dimensions 68x38.2x35.8mm manuf. no. 62.82.8.230.0000		

1			
Part No.	380808	Ref. No.	RX94813837
description	power relays FINDER 230VAC 16A 3CO connection male faston 6.3mm bracket mounting manuf. no. 62.83.8.230.0000		

relay sockets



1

Part No.	380137	Ref. No.	94800943 RX94800943
description	relay socket 8-pole connection plug-in connection round 8-pole dimensions 65x28x40mm 380V voltage AC 10A Italiana Relè manuf. no. ZVE8		
accessories for	380137		
	Part No.	380805	Ref. No.
	 support bracket		



1 electric components

level relays

GICAR



1	Part No.	400018	Ref. No.	RX94812666
	description	level relay 230V voltage AC connection F6.3 type RL30/3ES/F/G		

time relays

time relays



1	Part No.	381008	Ref. No.	RX27470236
	description	time relay CROUZET MAS5-88826014 time range 0.1s-100h 24-240VAC 0.7A		

electronic controllers

miscellaneous

universal controllers



1	Part No.	379020	Ref. No.	24848236 RX24848236
	description	electronic controller Pt100 steam control		

probes

universal probes

temperature probes



1	Part No.	379130 ¹	Ref. No.	94814231 RX94814231
	description	temperature probe Pt100 cable Vetrotex probe -200 up to +600°C cable -50 up to +350°C probe ø6x100mm cable length 1.4m without screw connection 3-wire resistance at 0°C 1000hm		

¹3-wire

1	Part No.	379831	Ref. No.	94050341 RX94050341
	description	temperature probe thermocouple J (Fe-CuNi) cable Vetrotex probe -50 up to +750°C cable -50 up to +350°C probe ø4x100mm cable length 1m cable colours black/white 2-wire		

producer-specific probes

probes

1	Part No.	379075	Ref. No.	24849093 RX24849093
	description	temperature probe Pt100 cable silicone probe -100 up to 450°C cable -50 up to +180°C connection 2-wire thread M6 probe ø4x100mm cable length 1.5m		

1	Part No.	379070	Ref. No.	24849036 RX24849036
	description	temperature probe Pt100 cable silicone probe -50 up to +250°C cable -50 up to +180°C connection 2-wire thread probe ø4x75mm cable length 1.7m		

1	Part No.	379087	Ref. No.	RX94820007
	description	temperature probe thermocouple K (NiCr-Ni) cable silicone probe -50 up to 1150°C cable -50 up to +180°C connection male faston 2.8mm thread probe ø1x30mm cable length 1.6m		

core probes



1	Part No.	378358	Ref. No.	RX94820008
	description	core temperature probe		

1	Part No.	381425	Ref. No.	24849135 24849168 RX24849135 RX24849168
	description	core temperature probe Pt100 cable PTFE probe -40 up to +250°C cable -40 up to +250°C connection 2-wire probe ø3.2x100mm thread M12 cable length 2.8m handle ø 10mm handle length 80mm		



electronics

PCBs



1

Part No.	400107	Ref. No.	27450238 RX27450238
description	control PCB combi-steamer CM101 edition CM v. 4.91-97		



1

Part No.	402619	Ref. No.	RX94820035
description	keypad PCB combi-steamer 1121/2021 L 350mm W 121mm with display		



1

Part No.	401661	Ref. No.	94814232 94814236 RX94814232 RX94814236
description	keypad PCB combi-steamer MVE04 kit		



1

Part No.	400110	Ref. No.	27450220 RX27450220
description	PCB combi-steamer level control		

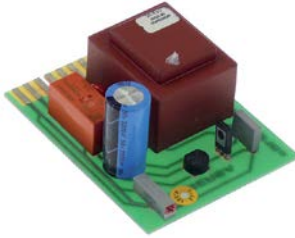

1

Part No.	403130	Ref. No.	9402358 94023587 RX94023587
description	PCB combi-steamer TVTS L 90mm W 70mm level control		

solenoid valves

solenoid valves (water)

ELBI

straight



1

Part No.	373009	Ref. No.	RX94804671
description	solenoid valve double straight 24V inlet 3/4" outlet 13.5mm DN10 t.max. 90°C duty cycle 100% ELBI		



1

Part No.	373020	Ref. No.	94809795 RX94809795
description	solenoid valve double angled 230VAC inlet 3/4" outlet 14mm input 10l/min DN10 t.max. 90°C duty cycle 100% ELBI flow regulating valve inlet white		

MÜLLER

medium temperature: 90°C
duty cycle: 100%



1











Part No.	370117	Ref. No.	RX94820016	
description	solenoid valve single straight 230VAC inlet 3/4" outlet 11.5mm DN10 t.max. 90°C duty cycle 100% MÜLLER			
spare parts for	370117			
	Part No.	370133	Ref. No.	—
	solenoid valve body single straight inlet 3/4" outlet 11.5mm DN10 t.max. 90°C duty cycle 100% MÜLLER 230V			







Table continues overleaf





spare parts for		370117	
	Part No.	371002	Ref. No. —
solenoid valve holder MÜLLER flange support			
	Part No.	371009	Ref. No. —
compression spring for solenoid coil			
	Part No.	371011	Ref. No. —
spare parts kit membrane with long star star height 8mm MÜLLER			
	Part No.	371017	Ref. No. —
solenoid coil MÜLLER 230VAC connection male faston 6.3mm			
	Part No.	371122	Ref. No. —
solenoid valve filter ø 19mm H 10mm suitable for MÜLLER			
	Part No.	501161	Ref. No. —
tap head for solenoid valve holder for solenoid coils			
accessories for		370117	
	Part No.	371010	Ref. No. —
solenoid coil 230VAC connection with cable cable length 2000mm			
	Part No.	371037	Ref. No. —
solenoid coil 24VAC 50/60Hz connection male faston 6.3mm			
	Part No.	371038	Ref. No. —
solenoid coil 230VAC connection appliance plug			

with cable connection



Part No.	370006	Ref. No.	RX24720054
description	solenoid valve triple straight 230VAC inlet 3/4" outlet 12.5mm DN10 t.max. 90°C duty cycle 100% MÜLLER cable length 2000mm		
spare parts for		370006	
	Part No.	370132	Ref. No. —
solenoid valve body triple straight inlet 3/4" outlet 11.5mm DN10 t.max. 90°C duty cycle 100% MÜLLER 230V			
	Part No.	371002	Ref. No. —
solenoid valve holder MÜLLER flange support			
	Part No.	371009	Ref. No. —
compression spring for solenoid coil			
	Part No.	371010	Ref. No. —
solenoid coil 230VAC connection with cable cable length 2000mm			
	Part No.	371011	Ref. No. —
spare parts kit membrane with long star star height 8mm MÜLLER			
	Part No.	371122	Ref. No. —
solenoid valve filter ø 19mm H 10mm suitable for MÜLLER			
	Part No.	501161	Ref. No. —
tap head for solenoid valve holder for solenoid coils			

accessories for		370006	
	Part No.	371017	Ref. No. —
solenoid coil MÜLLER 230VAC connection male faston 6.3mm			
	Part No.	371037	Ref. No. —
solenoid coil 24VAC 50/60Hz connection male faston 6.3mm			
	Part No.	371038	Ref. No. —
solenoid coil 230VAC connection appliance plug			

RPE

solenoid valves with reducers

single



Part No.	374105	Ref. No.	RX94814226
description	solenoid valve single straight 230VAC inlet 3/4" outlet 13 input 10-12l/min t.max. 25°C duty cycle 100% RPE type B plastic flow regulating valve outlet green flow regulating valve inlet white		



TP







Part No.	370021	Ref. No.	RX94807480
description	solenoid valve double straight 230VAC inlet 3/4" outlet 11.5mm DN10 TP flow regulating valve inlet white		
spare parts for		370021	
	Part No.	371013	Ref. No. —
solenoid coil TP 230VAC 50/60Hz			
accessories for		370021	
	Part No.	371220	Ref. No. —
reducer TP flow rate 3l/min red tolerance ±15%			
	Part No.	371221	Ref. No. —
reducer TP flow rate 5.5l/min yellow tolerance ±15%			
	Part No.	371222	Ref. No. —
reducer TP flow rate 6l/min grey tolerance ±15%			
	Part No.	371223	Ref. No. —
reducer TP flow rate 10l/min white tolerance ±15%			
	Part No.	371224	Ref. No. —
reducer TP flow rate 12l/min bronze tolerance ±15%			
	Part No.	371225	Ref. No. —
reducer TP flow rate 16l/min light brown tolerance ±15%			

Table continues overleaf





accessories for		370021		
Part No.	Ref. No.	Ref. No.	Ref. No.	—
	371226	Ref. No.	—	reducer TP flow rate 20l/min red tolerance ±15%
	371230	Ref. No.	—	reducer TP flow rate 0.25l/min red tolerance ±25%
	371231	Ref. No.	—	reducer TP flow rate 0.35l/min violet tolerance ±25%
	371232	Ref. No.	—	reducer TP flow rate 0.5l/min orange tolerance ±25%
	371233	Ref. No.	—	reducer TP flow rate 0.8l/min white tolerance ±25%
	371234	Ref. No.	—	reducer TP flow rate 1l/min light blue tolerance ±25%
	371235	Ref. No.	—	reducer TP flow rate 1.2l/min brown tolerance ±25%
	371236	Ref. No.	—	reducer TP flow rate 1.5l/min light brown tolerance ±25%
	371237	Ref. No.	—	reducer TP flow rate 2.5l/min yellow tolerance ±25%
	371238	Ref. No.	94810058 RX94810058	reducer TP flow rate 3.4l/min dark green tolerance ±25%
	371239	Ref. No.	—	reducer TP flow rate 5l/min black tolerance ±25%
	371240	Ref. No.	—	reducer TP flow rate 8l/min blue tolerance ±20%

  1				
Part No.	Ref. No.	Ref. No.	Ref. No.	—
370018	94809282 RX94809282	Ref. No.	Ref. No.	—
description	solenoid valve single straight 230VAC inlet 3/4" outlet 14mm DN10 TP			
spare parts for	370018			
	Part No.	371013	Ref. No.	—
solenoid coil TP 230VAC 50/60Hz				
accessories for	370018			
	Part No.	371220	Ref. No.	—
reducer TP flow rate 3l/min red tolerance ±15%				
	Part No.	371221	Ref. No.	—
reducer TP flow rate 5.5l/min yellow tolerance ±15%				

accessories for		370018		
Part No.	Ref. No.	Ref. No.	Ref. No.	—
	371222	Ref. No.	—	reducer TP flow rate 6l/min grey tolerance ±15%
	371223	Ref. No.	—	reducer TP flow rate 10l/min white tolerance ±15%
	371224	Ref. No.	—	reducer TP flow rate 12l/min bronze tolerance ±15%
	371225	Ref. No.	—	reducer TP flow rate 16l/min light brown tolerance ±15%
	371226	Ref. No.	—	reducer TP flow rate 20l/min red tolerance ±15%
	371230	Ref. No.	—	reducer TP flow rate 0.25l/min red tolerance ±25%
	371231	Ref. No.	—	reducer TP flow rate 0.35l/min violet tolerance ±25%
	371232	Ref. No.	—	reducer TP flow rate 0.5l/min orange tolerance ±25%
	371233	Ref. No.	—	reducer TP flow rate 0.8l/min white tolerance ±25%
	371234	Ref. No.	—	reducer TP flow rate 1l/min light blue tolerance ±25%
	371235	Ref. No.	—	reducer TP flow rate 1.2l/min brown tolerance ±25%
	371236	Ref. No.	—	reducer TP flow rate 1.5l/min light brown tolerance ±25%
	371237	Ref. No.	—	reducer TP flow rate 2.5l/min yellow tolerance ±25%
	371238	Ref. No.	94810058 RX94810058	reducer TP flow rate 3.4l/min dark green tolerance ±25%
	371239	Ref. No.	—	reducer TP flow rate 5l/min black tolerance ±25%
	371240	Ref. No.	—	reducer TP flow rate 8l/min blue tolerance ±20%



			
Part No.	370015	Ref. No.	94805520 RX94805520 RX94813749
description	solenoid valve single angled 230VAC inlet 3/4" outlet 11.5mm DN10 TP		
accessories for	370015		
	Part No.	371220	Ref. No. —
	reducer TP flow rate 3l/min red tolerance ±15%		
	Part No.	371221	Ref. No. —
	reducer TP flow rate 5.5l/min yellow tolerance ±15%		
	Part No.	371222	Ref. No. —
	reducer TP flow rate 6l/min grey tolerance ±15%		
	Part No.	371223	Ref. No. —
	reducer TP flow rate 10l/min white tolerance ±15%		
	Part No.	371224	Ref. No. —
	reducer TP flow rate 12l/min bronze tolerance ±15%		
	Part No.	371225	Ref. No. —
	reducer TP flow rate 16l/min light brown tolerance ±15%		
	Part No.	371226	Ref. No. —
	reducer TP flow rate 20l/min red tolerance ±15%		
	Part No.	371230	Ref. No. —
	reducer TP flow rate 0.25l/min red tolerance ±25%		
	Part No.	371231	Ref. No. —
	reducer TP flow rate 0.35l/min violet tolerance ±25%		
	Part No.	371232	Ref. No. —
	reducer TP flow rate 0.5l/min orange tolerance ±25%		
	Part No.	371233	Ref. No. —
	reducer TP flow rate 0.8l/min white tolerance ±25%		
	Part No.	371234	Ref. No. —
	reducer TP flow rate 1l/min light blue tolerance ±25%		
	Part No.	371235	Ref. No. —
	reducer TP flow rate 1.2l/min brown tolerance ±25%		
	Part No.	371236	Ref. No. —
	reducer TP flow rate 1.5l/min light brown tolerance ±25%		
	Part No.	371237	Ref. No. —
	reducer TP flow rate 2.5l/min yellow tolerance ±25%		
	Part No.	371238	Ref. No. 94810058 RX94810058
	reducer TP flow rate 3.4l/min dark green tolerance ±25%		

accessories for	370015		
	Part No.	371239	Ref. No. —
	reducer TP flow rate 5l/min black tolerance ±25%		
	Part No.	371240	Ref. No. —
	reducer TP flow rate 8l/min blue tolerance ±20%		

solenoid valves with reducers



1

Part No.	370628	Ref. No.	94050168 RX94050168
description	solenoid valve double straight 230VAC inlet 3/4" input 16l/min DN10 TP plastic outlet 11.5mm		

metal

MÜLLER

2-way



1

Part No.	370069 ¹	Ref. No.	RX94820014 RX94820015
description	solenoid valve 2-ways 230VAC inlet 1/8" IT outlet 1/8" IT L 30mm water MÜLLER DN10		

¹with adjusting screw

PARKER

3-way

121 KS8358 series



1

Part No.	370709	Ref. No.	94052347 RX94052347
description	solenoid valve brass 3-ways 230V voltage AC connection 1/4" IT L 77mm coil type 4818653D		





pressure switches

for steam control



 <p>1</p>			
Part No.	541074	Ref. No.	94814247 RX94814247
description	pressure control ø 45mm triggering pressure 0.5bar reset pressure 0.35bar pressure connection vertical steam control pressure range 0.35/0.51bar connection 1/8" pressure connection 1/8"		

electrodes

 <p>1</p>			
Part No.	403131	Ref. No.	9402351 94023512 RX94023512
description	level electrode 1/4" total length 330mm probe L 270mm insulated probe length 24mm connection M4 ø 4mm		



 <p>1</p>			
Part No.	400171	Ref. No.	RX94812665
description	level electrode 1/4" total length 350mm probe L 325mm insulated probe length 26mm connection male faston 6.3mm stainless steel ø 2.5mm		

 <p>1</p>			
Part No.	400021	Ref. No.	24849150 RX24849150
description	level electrode PG9 total length 110mm probe L 70/47/24mm insulated probe length 62/38/16mm with 3 probes connection grip connection		

 <p>1</p>			
Part No.	400022	Ref. No.	24849143 RX24849143
description	level electrode PG9 total length 135mm probe L 89/59/28mm insulated probe length 80mm with 3 probes connection grip connection		
accessories for	400022		
	Part No.	379729	Ref. No. —
connection cable L 1230mm 4-pole for level electrode plug type coded			
	Part No.	550574	Ref. No. —
nut thread PG9 H 3mm WS 28 nickel-plated brass Qty 1 pcs mounting ømm cable ømm			

fans

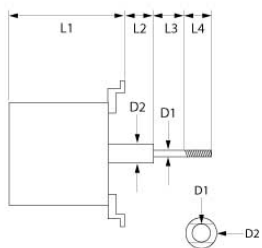
hot air motors

  <p>1</p>			
Part No.	601856	Ref. No.	RX94814228
description	fan motor 220-240V 1 phase 50/60Hz 0.075kW 2800/3200rpm speeds 1 L1 85mm L2 30mm L3 23mm L4 12mm D1 ø 8x6mm D2 ø 8mm 0.6A suitable capacitor 5µF/400V		
accessories for	601856		
	Part No.	365017	Ref. No. 94807807 RX94801305 RX94807807
operating capacitor capacity 5µF 450V tolerance 5% 50/60Hz ambient temperature max. -25 to +85°C ø 28mm L 54mm M8 plastic connection male faston 6.3mm 16.10.08 protection			
	Part No.	560129	Ref. No. —
hexagonal nut thread M5 H 4mm WS 8 SS DIN/ISO DIN 934 / ISO 4032/8673 Qty 1 pcs			

 <p>1</p>			
Part No.	601049	Ref. No.	27490051 RX27490051
description	fan wheel D1 ø 280mm H1 125mm blades 12 D2 ø 11mm D3 ø 16mm H2 37mm		

 <p>1</p>			
Part No.	601503	Ref. No.	RX94050051
description	fan wheel D1 ø 350mm H1 125mm blades 12 D2 ø 13mm D3 ø 16mm		
accessories for	601503		
	Part No.	500505	Ref. No. —
fan motor 220-240/380-415V 3 phase 50/60Hz 0.16-0.26kW 1440/1700rpm speeds 2 L1 140mm L2 27mm L3 35mm M10R IT 1.2/0.7A Cos(φ) 0.63 type L7zAw4D-014 D1 ø 17mm D2 ø 13mm			



motors

accessories

fan wheels



1

Part No.	601749	Ref. No.	RX94810520
description	fan wheel ø 174mm shaft intake ø 11mm H 54.5mm		

pumps

drain pumps

HANNING

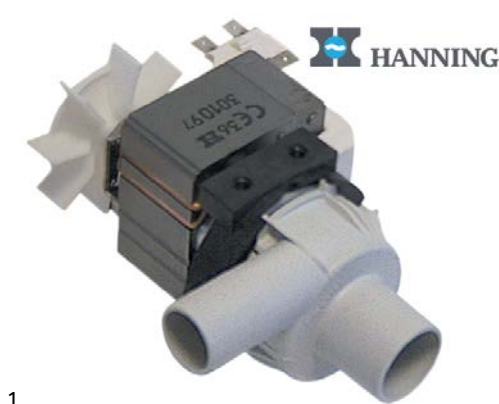

1

Part No.	500044	Ref. No.	RX27500297
description	drain pump 100W 230V inlet ø 30mm outlet ø 24mm 50Hz type BE28B4-017 HANNING		
spare parts for	500044		
	Part No.	510168	Ref. No. —
	fan wheel shaft intake ø 5mm ø 62mm H 14mm		

booster pumps II

accessories



1

Part No.	365017	Ref. No.	94807807 RX94801305 RX94807807
description	operating capacitor capacity 5µF 450V tolerance 5% 50/60Hz ambient temperature max. -25 to +85°C ø 28mm L 54mm M8 plastic connection male faston 6.3mm 16.10.08 protection		

condensators & interference suppression filters

operating capacitors

plastic



1

Part No.	365014	Ref. No.	94814010 RX94814010
description	operating capacitor capacity 12.5µF 450V tolerance 5%Hz ambient temperature max. -25 to +85°C ø 35mm L 70mm M8 plastic connection male faston 6.3mm 45S.C3DS.12.5 protection		



1

Part No.	365224	Ref. No.	RX94051638
description	operating capacitor capacity 25µF 420V tolerance 5% 50/60Hz ø 45mm L 75mm M8 plastic connection male faston 6.3mm		



1

Part No.	365017	Ref. No.	94807807 RX94801305 RX94807807
description	operating capacitor capacity 5µF 450V tolerance 5% 50/60Hz ambient temperature max. -25 to +85°C ø 28mm L 54mm M8 plastic connection male faston 6.3mm 16.10.08 protection		

filters

interference suppression filters



1

Part No.	365047	Ref. No.	94808409 RX94808409
description	interference suppression filter capacity 0.33µF(X2)+2x0.015µF		



fuses

fine fuses



1

Part No.	358677	Ref. No.	RX27630268
description	fine fuse size ϕ 5x20mm 4A fast-acting rated 250V Qty 10 pcs		



1

Part No.	358607	Ref. No.	27630086 RX27630086
description	fine fuse size ϕ 5x20mm 6.3A slow-acting rated 250V Qty 10 pcs		

fine fuse holders



1

Part No.	550105	Ref. No.	27630110 RX27630110
description	rail-mounted terminal WIELAND type WK10/SIU 5X20 /V0 suitable fuse ϕ 5x20mm 1.0-16mm ² 10A rated 250V		

screw locks

D0-system (NEOZED)



1

Part No.	358045	Ref. No.	RX27630227
description	fuse size D02 35A rated 250/400V E18 ϕ 15mm L 36mm Qty 10 pcs		

fuse holders



1

Part No.	358059	Ref. No.	27635200 RX27635200
description	fuse holder suitable fuse D01 ϕ 24mm mounting ϕ 14mm 1-pole-pole 16A rated 400V L 30mm		

electric accessories

terminals

porcelain clamps



1

Part No.	550116	Ref. No.	RX94018090
description	porcelain terminal block 3-pole 10mm ² hole distance 16mm max. 30A max 450V L 52mm W 30mm H 23mm mounting distance 16mm Qty 1 pcs		

connection terminals with screw/faston connections



1

Part No.	550411	Ref. No.	94810223 RX94810223
description	power terminal block 6-pole max. 40A max 450V connection ϕ 6mm ² / F6.3 temp.-resist. 150°C cross section 6mm ²		

rail-mounted terminals

WIELAND

rail-mounted terminals type 9700A



1

Part No.	550376	Ref. No.	27045137 RX27045137
description	rail-mounted terminal WIELAND type 9700A/16 S35 2.5-35mm ² top-hat rail 35mm grey W 16mm L 59mm		

fuse terminal blocks



1

Part No.	550105	Ref. No.	27630110 RX27630110
description	rail-mounted terminal WIELAND type WK10/SIU 5X20 /V0 suitable fuse ϕ 5x20mm 1.0-16mm ² 10A rated 250V		



gas taps

PEL

21S series



1

Part No.	109125	Ref. No.	9402051 94020518 RX94020518
description	gas tap PEL type 21S gas inlet M16x1.5 (tube ø 10mm) bypass nozzle ø 0mm gas outlet M16x1.5 (tube ø 10/8mm) thermocouple connection M9x1 pilot connection M10x1 shaft ø 6x4.6mm shaft L 40/16mm shaft flat lower		
spare parts for	109125		
	Part No.	100909	Ref. No. —
	union screw thread M10x1 for pipe ø 6mm Qty 1 pcs		
	Part No.	101060	Ref. No. —
	magnet unit standard L 39mm D1 ø 15.4mm D2 ø 11mm suitable for PEL20-21/JUNKERS/EGA		
	Part No.	101231	Ref. No. —
	thermocouple nut T1: M9x1 T2: M18x1		
	Part No.	101278	Ref. No. —
	olive for pipe ø 10mm Qty 1 pcs		
	Part No.	101286	Ref. No. —
	olive ID ø 6mm Qty 1 pcs		
	Part No.	101300	Ref. No. —
	union nut thread M16x1.5 tube ø 10mm		
	Part No.	106202	Ref. No. —
	bypass nozzle type PEL20/21 bore ø 0mm thread M5x0.5		
accessories for	109125		
	Part No.	100909	Ref. No. —
	union screw thread M10x1 for pipe ø 6mm Qty 1 pcs		
	Part No.	101231	Ref. No. —
	thermocouple nut T1: M9x1 T2: M18x1		
	Part No.	101278	Ref. No. —
	olive for pipe ø 10mm Qty 1 pcs		
	Part No.	101286	Ref. No. —
	olive ID ø 6mm Qty 1 pcs		
	Part No.	101300	Ref. No. —
	union nut thread M16x1.5 tube ø 10mm		

gas valves and ignition boxes



gas control valves

SIT

ELETTROSIT



1

Part No.	101127	Ref. No.	RX94024965
description	gas valve SIT type ELETTROSIT 230V gas inlet 3/4" gas outlet 3/4" thermocouple connection M9x1 pilot connection M10x1 lateral equiv. no. 0.810.175		
spare parts for	101127		
	Part No.	101312	Ref. No. 94034683 RX94034683
	microswitch		
	Part No.	101352	Ref. No. —
	solenoid coil 230V 50Hz suitable for ELETTROSIT		
accessories for	101127		
	Part No.	100006	Ref. No. —
	piezoelectric igniter suitable for ELETTROSIT body plastic blowing connection ø2.4mm ø 14mm		
	Part No.	100904	Ref. No. —
	locking screw M10x1 for pipe ø 4mm Qty 1 pcs		
	Part No.	100905	Ref. No. —
	locking screw M10x1 for pipe ø 6mm Qty 1 pcs		
	Part No.	101301	Ref. No. —
	gas connection thread 1/2" straight ELETTROSIT screw with O-ring		
	Part No.	101303	Ref. No. —
	gas connection straight thread 3/4" ELETTROSIT		
	Part No.	101309	Ref. No. —
	extension		



NOVASIT

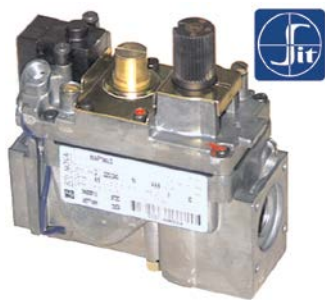

1

Part No.	101162	Ref. No.	9402374 RX94023744
description	gas valve SIT series Novasit 820 230V 50Hz gas inlet 1/2" gas outlet 1/2" thermocouple connection M9x1 pilot connection M10x1 ignition pressure 3-5mbar pressure range 3-30mbar pressure regulator connection blind equiv. no. 0.820.010		
spare parts for	101162		
	Part No.	101065	Ref. No. —
	magnet unit with cable L 44mm D1 ø 30mm D2 ø 20mm suitable for NOVASIT		
	Part No.	101313	Ref. No. RX27440130
	solenoid coil 230V 50Hz		
accessories for	101162		
	Part No.	100006	Ref. No. —
	piezoelectric igniter suitable for ELETTROSIT body plastic blowing connection ø2.4mm ø 14mm		
	Part No.	101305	Ref. No. —
	gas connection straight 1/2" flange 45x45mm ELETTROSIT/V4400/4600/4605 suitable for SIT/HONEYWELL hole distance 36x36mm		
	Part No.	101306	Ref. No. —
	gas connection angled flange 45x45mm hole distance 36x36mm 1/2" ELETTROSIT/V4400/4600/4605 screw with O-ring suitable for SIT/HONEYWELL		
	Part No.	101307	Ref. No. —
	gas connection straight flange 45x45mm hole distance 36x36mm 3/4" ELETTROSIT/V4400/4600/4605 screw with O-ring suitable for SIT/HONEYWELL		
	Part No.	101308	Ref. No. RX94051554
	gas connection angled flange 45x45mm hole distance 36x36mm 3/4" ELETTROSIT/V4400/4600/4605 screw with O-ring suitable for SIT/HONEYWELL		
	Part No.	101312	Ref. No. 94034683 RX94034683
	microswitch		
	Part No.	101314	Ref. No. —
	solenoid coil 24V 50Hz		
	Part No.	101317	Ref. No. —
	plug with cable L 1000mm suitable for NOVASIT		
	Part No.	101318	Ref. No. —
	cover cap for solenoid coil suitable for NOVASIT		

accessories



1

Part No.	101308	Ref. No.	RX94051554
description	gas connection angled flange 45x45mm hole distance 36x36mm 3/4" ELETTROSIT/V4400/4600/4605 screw with O-ring suitable for SIT/HONEYWELL		



1

Part No.	101312	Ref. No.	94034683 RX94034683
description	microswitch		



1

Part No.	101313	Ref. No.	RX27440130
description	solenoid coil 230V 50Hz		
accessories for	101313		
	Part No.	550896	Ref. No. —
	gasket with screw gas valves NOVASIT		

ignition boxes

HONEYWELL



1

Part No.	104598	Ref. No.	RX94045529
description	ignition box HONEYWELL type S4565XXXXX electrodes 3 waiting times safety time 10s 220-240V 4VA 50/60Hz		



ignition parts















pilot burners



SIT

100 series



1

Part No.	106906	Ref. No.	94034659 RX94027471 RX94034659
description	pilot burner SIT type 100 series 3 flames nozzle \varnothing 0.2mm gas connection 6mm		
spare parts for	106906		
	Part No.	100245	Ref. No. —
pilot burner nozzle LPG code 20 bore \varnothing 0.2mm Qty 1 pcs thread M8x0.75			
	Part No.	100855	Ref. No. RX94028602 RX94028604
pilot burner bracket triple			
	Part No.	100885	Ref. No. —
air mixing sleeve for pilot burner Qty 1 pcs			
	Part No.	100916	Ref. No. —
compression spring for pilot burner Qty 1 pcs			
	Part No.	100917	Ref. No. —
gasket for pilot burner Qty 1 pcs aluminium ID \varnothing 8.5mm ED \varnothing 11mm thickness 1.2mm			
	Part No.	100918	Ref. No. —
screw for pilot burner			
	Part No.	107162	Ref. No. —
pilot burner cap SIT 3 flames Hmm Lmm Qty 1 pcs			
	Part No.	107701	Ref. No. —
pilot burner bottom part SIT 100 series nozzle \varnothing 0.2mm			
accessories for	106906		
	Part No.	100245	Ref. No. —
pilot burner nozzle LPG code 20 bore \varnothing 0.2mm Qty 1 pcs thread M8x0.75			
	Part No.	100246	Ref. No. —
pilot burner nozzle natural gas bore \varnothing 0.35mm Qty 1 pcs thread M8x0.75			
	Part No.	100904	Ref. No. —
locking screw M10x1 for pipe \varnothing 4mm Qty 1 pcs			
	Part No.	100905	Ref. No. —
locking screw M10x1 for pipe \varnothing 6mm Qty 1 pcs			
	Part No.	102110	Ref. No. —
pilot tube copper pipe \varnothing 4mm thickness 1mm L 3000mm			
	Part No.	102111	Ref. No. —
pilot tube copper pipe \varnothing 6mm thickness 1mm L 3000mm			

accessories for	106906		
	Part No.	107171	Ref. No. 94812644 RX94812644
pilot burner nozzle SIT natural/liquid gas bore \varnothing 0.25mm Qty 1 pcs			
	Part No.	107700	Ref. No. —
pilot burner bottom part SIT 100 series nozzle \varnothing 0.25mm			
	Part No.	107702	Ref. No. —
pilot burner bottom part SIT 100 series nozzle \varnothing 0.35mm			



accessories

pilot burner brackets

universal



1

Part No.	100855	Ref. No.	RX94028602 RX94028604
description	pilot burner bracket triple		
accessories for	100855		
	Part No.	100855	Ref. No. RX94028602 RX94028604
pilot burner bracket triple			
	Part No.	100886	Ref. No. —
pilot burner bracket suitable for 100 series 3-piece			
	Part No.	100888	Ref. No. —
screw bolt for pilot burner			

ignition electrodes

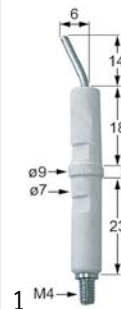

1

Part No.	100706	Ref. No.	RX94034642 RX94805207
description	ignition electrode connection M4 Qty 1 pcs		



Part No.	100707	Ref. No.	94027729 RX94027729
description	ignition electrode D1 ø 7mm D2 ø 9mm connection ø2.4mm L1 14mm L2 6mm BL1 18mm BL2 3mm BL3 23mm to clip Qty 1 pcs		

140 - 145 -150 series

Part No.	107114 ¹	Ref. No.	94805041 RX94805041
description	pilot burner SIT type 140 series 2 flames nozzle ømm gas connectionmm		
spare parts for	107114		
	Part No.	100907	Ref. No. 94805090 RX94805090
	screw connection thread M10x1 Qty 1 pcs type SEF 1 ømm for thermocouple		
accessories for	107114		
	Part No.	100204	Ref. No. —
	pilot burner nozzle SIT LPG code 14 bore ø 0.18/0.20mm Qty 1 pcs suitable for 140 series		
	Part No.	100205	Ref. No. RX822140380
	pilot burner nozzle SIT LPG code 19 bore ø 0.23/0.26mm Qty 1 pcs suitable for SIT 150 series		
	Part No.	100206	Ref. No. —
	pilot burner nozzle SIT natural gas code 36 bore ø 0.60/0.55mm Qty 1 pcs suitable for SIT 150 series		
	Part No.	100207	Ref. No. RX822140120 RX94806072
	pilot burner nozzle SIT natural gas code 27 bore ø 0.40/0.38mm suitable for SIT 140 series		
	Part No.	100216	Ref. No. —
	pilot burner nozzle SIT natural gas code 38 bore ø 0.45mm Qty 1 pcs suitable for SIT 150 series		
	Part No.	100701	Ref. No. RX94805066 RX94805306 RX94805686
	ignition electrode connection M4 Qty 1 pcs		
	Part No.	100801	Ref. No. —
	gasket for pilot burner Qty 1 pcs		
	Part No.	100897	Ref. No. —
	olive for pipe ø 4mm Qty 1 pcs for pilot burner		
	Part No.	100898	Ref. No. —
	olive for pipe ø 6mm Qty 1 pcs for pilot burner		

¹incl. thermocouple fitting

accessories for	107114		
	Part No.	100906	Ref. No. 94805082 RX94805082
	screw connection thread M10x1 for ignition electrode brass Qty 1 pcs WS 10		
	Part No.	100908	Ref. No. 94812587 RX94812587
	union screw thread M10x1 for pipe ø 4mm Qty 1 pcs		
	Part No.	100909	Ref. No. —
	union screw thread M10x1 for pipe ø 6mm Qty 1 pcs		
	Part No.	102110	Ref. No. —
	pilot tube copper pipe ø 4mm thickness 1mm L 3000mm		
	Part No.	102111	Ref. No. —
	pilot tube copper pipe ø 6mm thickness 1mm L 3000mm		

AEM

pilot burners

Part No.	107528	Ref. No.	RX94044477
description	pilot burner 1 flame natural gas nozzle ø 0.4mm gas connection 6mm		

producer-specific pilot burners

ROSINOX

Part No.	107528	Ref. No.	RX94044477
description	pilot burner 1 flame natural gas nozzle ø 0.4mm gas connection 6mm		



electrodes

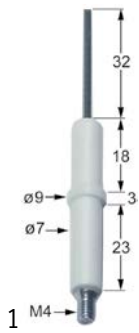

Part No.	100701	Ref. No.	RX94805066 RX94805306 RX94805686
description	ignition electrode connection M4 Qty 1 pcs		
accessories for	100701		
	Part No.	Ref. No.	94805082 RX94805082
	screw connection thread M10x1 for ignition electrode brass Qty 1 pcs WS 10		



Part No.	100706	Ref. No.	RX94034642 RX94805207
description	ignition electrode connection M4 Qty 1 pcs		

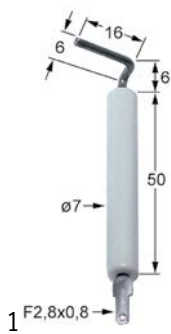

Part No.	102907	Ref. No.	9404421 RX94044214
description	ignition electrode D1 ø 7mm connection F 2.8x0.8mm L1 6mm L2 6mm L3 16mm BL1 50mm to clip		



Part No.	100707	Ref. No.	94027729 RX94027729
description	ignition electrode D1 ø 7mm D2 ø 9mm connection ø2.4mm L1 14mm L2 6mm BL1 18mm BL2 3mm BL3 23mm to clip Qty 1 pcs		

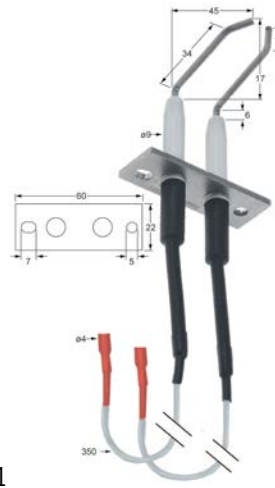

Part No.	106996	Ref. No.	RX94820030
description	ignition electrode flange length 60mm flange width 22mm D1 ø 9mm L1 17mm L2 45mm L3 6mm L4 34/10mm BL1 37mm BL2 32mm cable length 350mm connection ø ø4mm		
accessories for	106996		
	Part No.	Ref. No.	699472 —
	gasket ignition electrode ID ø 13mm hole ø 6mm L 60mm W 22mm suitable for ELOMA graphite		

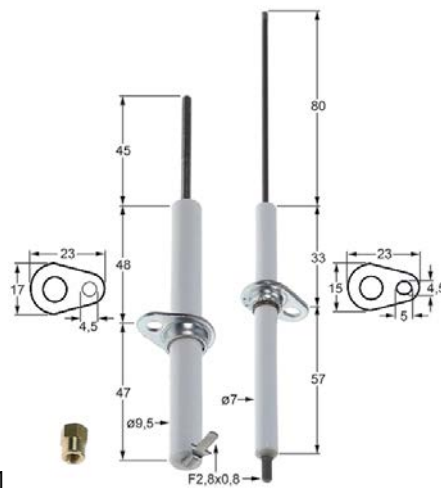

Part No.	106525	Ref. No.	94814239 RX94814239
description	ignition electrode set Qty 2 flange length 23mm flange width 15/17mm D1 ø 7/9.5mm L1 80/45mm BL1 33/48mm BL2 57/47mm connection F2.8x0.8 fixing dimensions ø4.5mm		

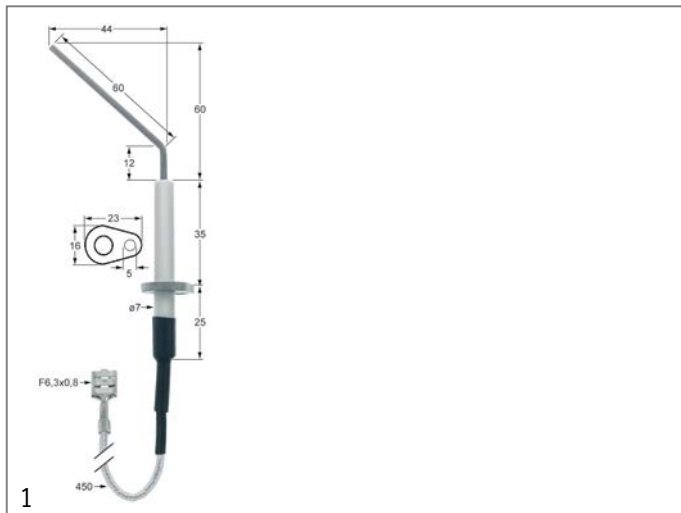

Part No.	106997	Ref. No.	RX94820029
description	monitoring electrode connection \varnothing F6.3mm flange length 23mm flange width 16mm D1 \varnothing 7mm L1 60mm L2 44mm L4 12mm L3 60mm BL1 35mm BL2 25mm connection F6.3x0.8 cable length 450mm fixing dimensions \varnothing 5mm		

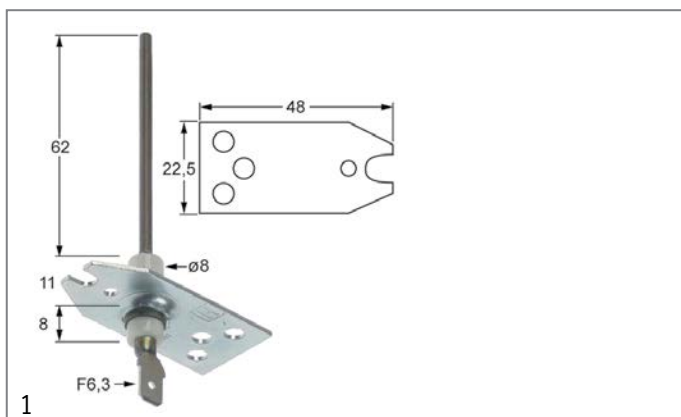

Part No.	109120	Ref. No.	94051521 RX94051521
description	monitoring electrode flange length 48mm D1 \varnothing 8mm flange width 22.5mm L1 62mm BL1 11mm BL2 8mm connection male faston 6.3mm		



Part No.	100906	Ref. No.	94805082 RX94805082
description	screw connection thread M10x1 for ignition electrode brass Qty 1 pcs WS 10		

ignition cables

pre-assembled cables



Part No.	100176	Ref. No.	94805322 RX94805074 RX94805322
description	ignition cable cable length 1000mm connection \varnothing 2.4mm / \varnothing 4mm permanent temperature 200°C		



Part No.	100019	Ref. No.	94805694 RX94805694
description	ignition cable cable length 900mm connection \varnothing 2.4mm / \varnothing 4mm		

ignition units



Part No.	101002	Ref. No.	RX94027802
description	ignition unit outputs 2 230VAC dimensions 88x23x34mm mounting distance 73mm inlet F6.3x0.8 outlet F2.8x0.8 0.6VA 50/60Hz		



Part No.	102388	Ref. No.	94039229 94805116 RX94039229 RX94805116
description	ignition unit outputs 4 230VAC dimensions 111x23x34mm mounting distance 100mm inlet F6.3x0.8 outlet F2.8x0.8 type WAC-T4 0.6VA 50/60Hz		

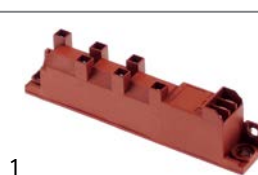

Part No.	102389	Ref. No.	94805124 RX94805124
description	ignition unit outputs 6 230VAC dimensions 135x23x34mm mounting distance 123mm inlet F6.3x0.8 outlet F2.8x0.8 0.6VA 50/60Hz		

ignition switches



Part No.	345038	Ref. No.	94805173 RX94805173
description	momentary push switch mounting \varnothing 25mm black 2NO 250V 16A connection male faston 6.3mm ambient temperature max. 85°C protection IP40		



thermocouples

plug-in thermocouples

plug-in thermocouples standard

with barrel socket $\varnothing 6(6.5)$ mm

thermocouples SIT

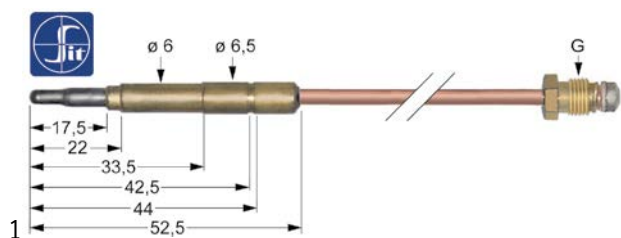

Part No.	107612	Ref. No.	RX94024973
description	thermocouple SIT M9x1 L 1000mm plug connection $\varnothing 6.0(6.5)$ mm		

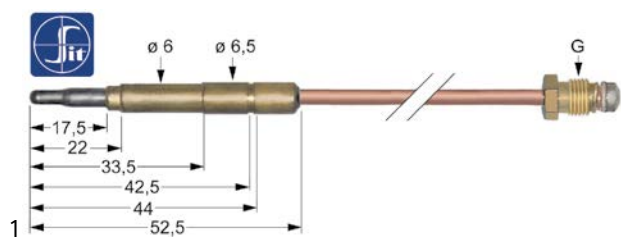

Part No.	107614	Ref. No.	RX94015112
description	thermocouple SIT M9x1 L 1500mm plug connection $\varnothing 6.0(6.5)$ mm		

threaded thermocouples

threaded thermocouples standard

with socket with thread M8x1

SIT

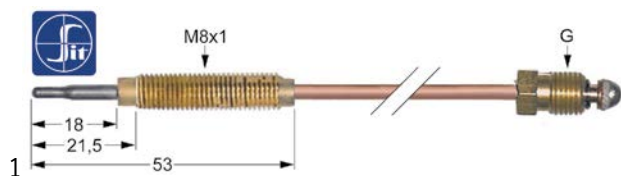

Part No.	107632	Ref. No.	RX94028529
description	thermocouple SIT M8x1 L 1000mm M8x1		

accessories for 107632



Part No.	102067	Ref. No.	—
nut thread M8x1 H 3mm brass Qty 1 pcs type SEF 1			

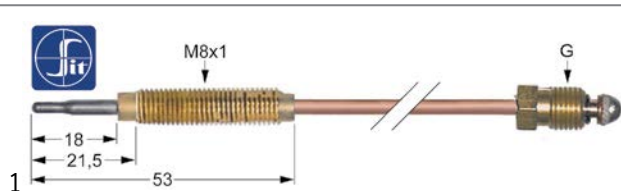

Part No.	107636	Ref. No.	94805025 RX94805025
description	thermocouple SIT M9x1 L 600mm M8x1		

accessories for 107636



Part No.	102067	Ref. No.	—
nut thread M8x1 H 3mm brass Qty 1 pcs type SEF 1			

gas nozzles

pilot burner nozzles

pilot burner nozzles POLIDORO



Part No.	106703	Ref. No.	RX94034519
description	pilot burner nozzle POLIDORO natural gas code 27.2 bore \varnothing 2x0.27mm Qty 1 pcs		

pilot burner nozzles SIT

100 series



Part No.	107171	Ref. No.	94812644 RX94812644
description	pilot burner nozzle SIT natural/liquid gas bore \varnothing 0.25mm Qty 1 pcs		

140/150 series



Part No.	100205	Ref. No.	RX822140380
description	pilot burner nozzle SIT LPG code 19 bore \varnothing 0.23/0.26mm Qty 1 pcs suitable for SIT 150 series		



Part No.	100207	Ref. No.	RX822140120 RX94806072
description	pilot burner nozzle SIT natural gas code 27 bore \varnothing 0.40/0.38mm suitable for SIT 140 series		

screw connections

olives





Part No.	101248	Ref. No.	94810978 RX94810978
description	olive for pipe \varnothing 12mm L 9.5mm brass Qty 1 pcs suitable for PEL		

accessories for 101248





Part No.	101251	Ref. No.	—
union nut thread M20x1.5 for pipe \varnothing 12mm			



 <p>1</p>			
Part No.	101246	Ref. No.	94812588 RX94812588
description	olive for pipe ø 4mm Qty 1 pcs		
accessories for	101246		
			
Part No.	100908	Ref. No.	94812587 RX94812587
description	union screw thread M10x1 for pipe ø 4mm Qty 1 pcs		

union screws

 <p>1</p>			
Part No.	100906	Ref. No.	94805082 RX94805082
description	screw connection thread M10x1 for ignition electrode brass Qty 1 pcs WS 10		

 <p>1</p>			
Part No.	100907	Ref. No.	94805090 RX94805090
description	screw connection thread M10x1 Qty 1 pcs type SEF 1 ømm for thermocouple		

 <p>1</p>			
Part No.	100908	Ref. No.	94812587 RX94812587
description	union screw thread M10x1 for pipe ø 4mm Qty 1 pcs		
accessories for	100908		
			
Part No.	100897	Ref. No.	—
description	olive for pipe ø 4mm Qty 1 pcs for pilot burner		
			
Part No.	101246	Ref. No.	94812588 RX94812588
description	olive for pipe ø 4mm Qty 1 pcs		
			
Part No.	101280	Ref. No.	—
description	olive for pipe ø 4mm Qty 1 pcs		
			
Part No.	101282	Ref. No.	—
description	olive for pipe ø 4mm L 7.4mm Qty 1 pcs		

equipmentspecific units

for convection ovens/combi-steamers

spare parts and accessories

 <p>1</p>			
Part No.	698483	Ref. No.	RX94003753
description	bearing bolt L 17mm ø 12.2mm WS 15 ext. ø M8		

 <p>1</p>			
Part No.	512418	Ref. No.	RX94050556
description	cotter pin D1 ø 8.6mm hole ø 5.5mm Qty 1 pcs total length 40.4mm		

 <p>1</p>			
Part No.	512417	Ref. No.	RX94020211
description	hexagonal nut WS 16 thread M10 black suitable for ROSINOX Qty 1m		

miscellaneous

 <p>1</p>			
Part No.	510558	Ref. No.	24556078 RX24556078
description	connection for pump		

 <p>1</p>			
Part No.	694527	Ref. No.	24390627 RX24390627
description	gasket rubber ED ø 57mm ID ø 39mm thickness 4mm for combi-steamer Qty 1 pcs suitable for RATIONAL		



knobs

producer-specific knobs

ROSINOX



Part No.	111479	Ref. No.	9403093 94030939 RX94030939
description	knob ø 38mm shaft ø 16x16mm chrome		
accessories for	111479		
	Part No.	111481	Ref. No. 9400687 94006871 RX94006871
knob adapter shaft ø 8x8mm for water tap			

accessories

covers



Part No.	111510	Ref. No.	RX94820043
description	lid t.max.°C ø 37mm shaft ømm shaft flat silver for knob ELOMA		
accessories for	111510		
	Part No.	111498	Ref. No. —
knob t.max.°C ø 48mm shaft ø 6.5mm shaft flat blue			

knob adaptors



Part No.	111482	Ref. No.	9400683 94006830 RX94006830
description	knob adapter shaft ø 6x4.6mm for gas tap		



locks

turning lever locks

universal

RAHRBACH





Part No.	700098	Ref. No.	26728212 RX26728212
description	door catch mounting pos. right off-set 38mm L 110mm H 74mm W 33mm mounting distance 68/68mm series 1750		
spare parts for	700098		
	Part No.	690136	Ref. No. RX22705073
accessories for	700098		
	Part No.	514281	Ref. No. —
base plate L 110mm W 35mm for door catch thickness 10mm			



Part No.	690136	Ref. No.	RX22705073
description	sliding plate mounting pos. right L 28mm H 3mm W 21mm H2 12.5mm		

STUV



Part No.	700098	Ref. No.	26728212 RX26728212
description	door catch mounting pos. right off-set 38mm L 110mm H 74mm W 33mm mounting distance 68/68mm series 1750		
spare parts for	700098		
	Part No.	690136	Ref. No. RX22705073
accessories for	700098		
	Part No.	514281	Ref. No. —
base plate L 110mm W 35mm for door catch thickness 10mm			





edgemoount latches

handle latches

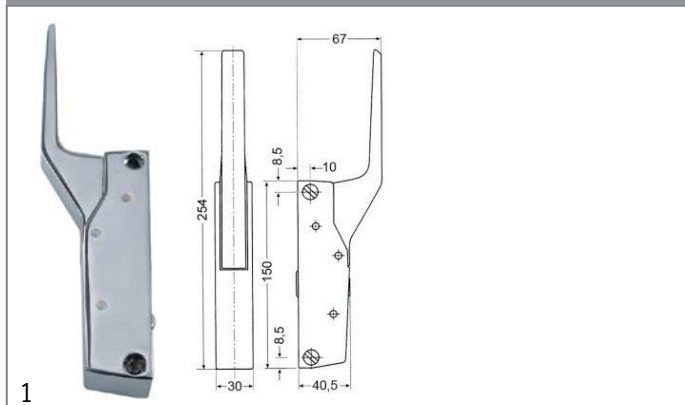
CAFF/FERMOD



Part No.	700060	Ref. No.	RX94026168
description	handle latch L 150mm mounting distance 133mm non lockable heated units G 791		
accessories for	700060		
	Part No.	700061	Ref. No. —
	door catch L 58mm W 20mm H 35mm mounting distance 42mm chrome-plated brass for headed units		
	Part No.	700062	Ref. No. —
	handle protection heated units		

STUV

3.30.016x.x series

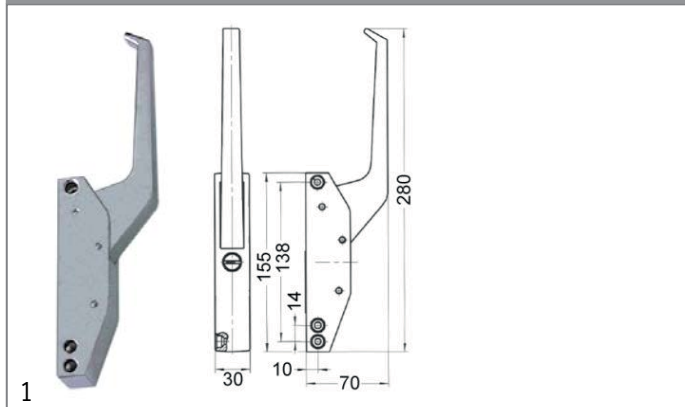

Part No.	700063	Ref. No.	RX26728030
description	handle latch L 155mm mounting distance 124/138mm non lockable refrigeration units 3.30.0164		
accessories for	700063		
	Part No.	700064	Ref. No. RX26728022
	door catch H 40mm L 28mm W 22mm		

door catches

	Part No.	700064	Ref. No.	RX26728022
description	door catch H 40mm L 28mm W 22mm			

walk-in fridge catches

STUV

3.31.015x.x series

	Part No.	700072	Ref. No.	26728261 RX26728261
description	door catch H 17mm L 84mm W 53mm mounting distance 68mm zinc die cast with wedge heated units			

snap locks

producer-specific

ROSINOX

	Part No.	700072	Ref. No.	26728261 RX26728261
description	door catch H 17mm L 84mm W 53mm mounting distance 68mm zinc die cast with wedge heated units			

	Part No.	690101	Ref. No.	26728253 RX26728253
description	snap lock L 85mm W 40mm mounting distance 68mm heated units H 63mm type 1750 series			

mechanical components, equipment accessories



equipment feet and end caps

equipment feet

with screw mounting



1

Part No.	513287	Ref. No.	RX94809563
-----------------	--------	-----------------	------------

description	equipment foot tube ø 60mm thread M12 thread L 33mm H 155-235mm SS size 2" Qty 1 pcs		
--------------------	--	--	--

gaskets

gaskets for heated units

window seals

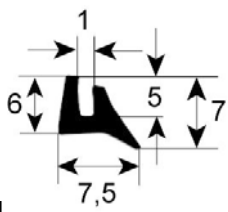

1

Part No.	900056	Ref. No.	RX24390502
-----------------	--------	-----------------	------------

description	window gasket profile 1570 Qty supplied by meter		
--------------------	--	--	--

door seals

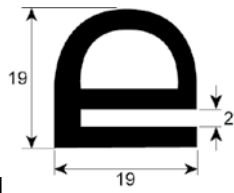

1

Part No.	900174	Ref. No.	RX24390288
-----------------	--------	-----------------	------------

description	door seal profile 2210 L 4200mm Qty 1		
--------------------	---------------------------------------	--	--

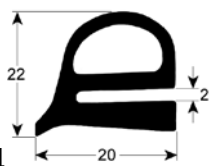

1

Part No.	901561	Ref. No.	9405030 94050309 RX94050309
-----------------	--------	-----------------	-----------------------------------

description	door seal profile 2228 Qty supplied by meter		
--------------------	--	--	--

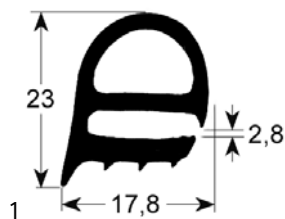

1

Part No.	902240	Ref. No.	24390379 RX24390379
-----------------	--------	-----------------	------------------------

description	door seal profile 2230 W 470mm L 485mm external size Qty 1		
--------------------	--	--	--

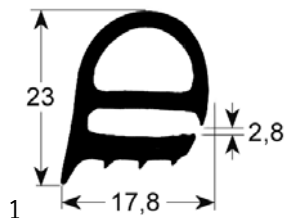

1

Part No.	902241	Ref. No.	24390338 RX24390338
-----------------	--------	-----------------	------------------------

description	door seal profile 2230 W 480mm L 725mm external size Qty 1		
--------------------	--	--	--

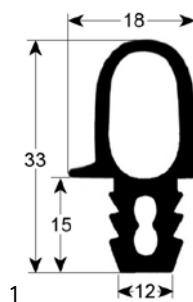

1

Part No.	900865	Ref. No.	RX94820000
-----------------	--------	-----------------	------------

description	door seal profile 2449 W 490mm L 520mm Qty 1		
--------------------	--	--	--

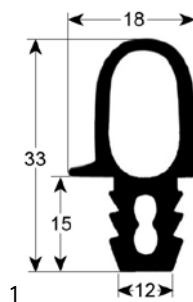

1

Part No.	901483	Ref. No.	RX94820002
-----------------	--------	-----------------	------------

description	door seal profile 2449 W 520mm L 1505mm Qty 1		
--------------------	---	--	--

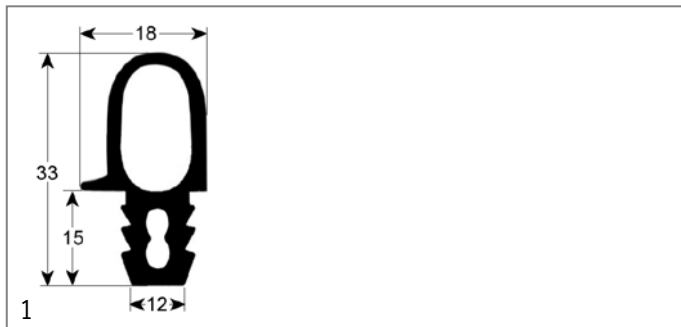

Part No.	900497	Ref. No.	RX94820001
description	door seal profile 2449 W 520mm L 775mm Qty 1		

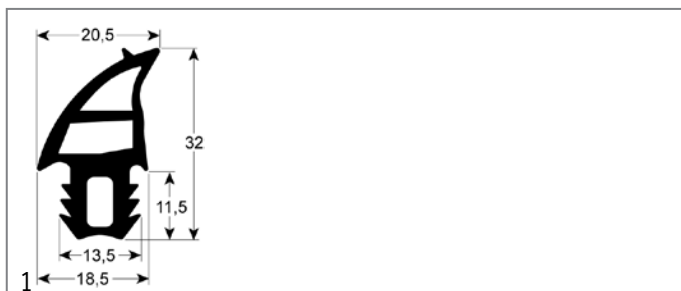

Part No.	902492	Ref. No.	RX94820003
description	door seal profile 2736 W 695mm L 1000mm outer plug size Qty 1 suitable for ELOMA 12-21 silicone		



Part No.	900489	Ref. No.	94814225 RX94814225
description	door seal profile 2770/2771 H 440mm W 600mm outer plug size Qty 1		

gaskets for tray rack trolleys

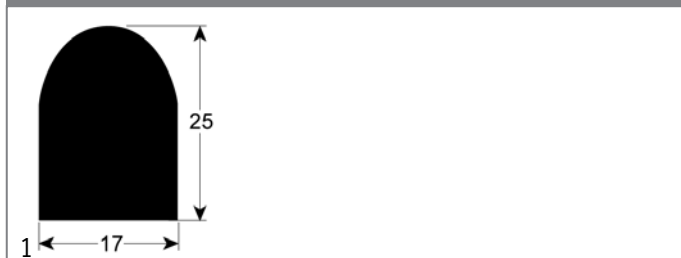

Part No.	900055	Ref. No.	24390510 RX24390510
description	tray rack trolley gasket profile 4020 Qty supplied by meter silicone foam		

O-rings

EPDM

ø1.78mm

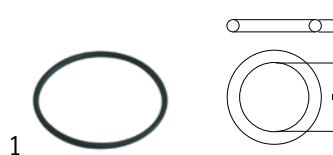

Part No.	510824	Ref. No.	94807450 RX94807450
description	O-ring EPDM thickness 1.78mm ID ø 20.35mm Qty 1 pcs		



Part No.	510303	Ref. No.	94800778 RX94800778
description	O-ring EPDM thickness 1.78mm ID ø 6.75mm Qty 1 pcs		

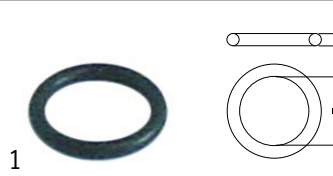

Part No.	504574	Ref. No.	RX94813741 RX94813762
description	O-ring EPDM thickness 1.78mm ID ø 9.25mm Qty 1 pcs		

ø5.34mm



Part No.	510408	Ref. No.	RX94807781
description	O-ring EPDM thickness 5.34mm ID ø 47mm Qty 1 pcs		

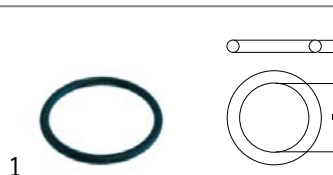

Part No.	510409	Ref. No.	RX94807294
description	O-ring EPDM thickness 5.34mm ID ø 56.52mm Qty 1 pcs		



sealing washers

rubber gaskets



1

Part No.	694527	Ref. No.	24390627 RX24390627
description	gasket rubber ED ø 57mm ID ø 39mm thickness 4mm for combi-steamer Qty 1 pcs suitable for RATIONAL		

PTFE gaskets



1

Part No.	518669	Ref. No.	RX94820006
description	gasket PTFE ED ø 21mm ID ø 15mm thickness 3.5mm		
accessories for	518669		
	Part No.	375889	Ref. No. RX94820005
	safety thermostat switch-off temp. 360°C 1-pole 16A probe ø 15mm probe L 6.5mm capillary pipe 1140mm capillary pipe isolated 1100mm gland nut probe		

silicone gaskets



1

Part No.	359721	Ref. No.	RX24390700
description	gasket silicone ED ø 48mm ID ø 39.5mm thickness 5mm Qty 1 pcs		

sealing cords

round



1

Part No.	510572	Ref. No.	RX24390296
description	sealing cord ø 10mm greased L 0.2m Qty 1		

special gaskets

miscellaneous



1

Part No.	510566	Ref. No.	24390320 RX24390320
description	gasket suitable for RATIONAL equiv. no. 50120537 L 70mm W 70mm electrode thickness 4mm		



1

Part No.	510671	Ref. No.	RX24390544
description	gasket suitable for RATIONAL for drain Qty 1m ED ø 124mm ID ø 51mm rubber thickness 4mm hole distance 87mm		

thermostat gaskets



1

Part No.	518669	Ref. No.	RX94820006
description	gasket PTFE ED ø 21mm ID ø 15mm thickness 3.5mm		
accessories for	518669		
	Part No.	375889	Ref. No. RX94820005
	safety thermostat switch-off temp. 360°C 1-pole 16A probe ø 15mm probe L 6.5mm capillary pipe 1140mm capillary pipe isolated 1100mm gland nut probe		

transmission technology and ball bearings

ball bearings

deep-groove ball bearings 2RS



1

Part No.	523522	Ref. No.	RX94008067
description	deep-groove ball bearing type 6004-2RS shaft ø 20mm ED ø 42mm W 12mm with sealing discs deep-groove ball bearing DIN 625-1		

springs

torsion springs



1

Part No.	690095	Ref. No.	94814244 RX94814244
description	torsion spring ø 6mm L2 15mm wire gauge ø 0.9mm L1 2x6mm L3 15mm Qty 1 pcs for closing hub		



manometers

1			
Part No.	541876	Ref. No.	RX94809357
description	manometer ø 49mm pressure range 0-4bar connection lower marking adjustable thread 1/4"		

hose reels and spray guns

spray guns

1			
Part No.	520729	Ref. No.	25177072 RX25177072
description	shower hose connections 1/2" L 2800mm SS operating p. 10bar burst p. 90bar t.max. 90°C approval DVGW with flexible fabric		

dosing pumps

accessories

container filters with non-return valve

1			
Part No.	361058	Ref. No.	94045172 RX94045172
description	container filter with non-return valve SS hose ø 4x6mm ø 20mm L 56mm		

hoses

supply hoses

stainless steel flexi hoses

universal hoses

1			
Part No.	520633	Ref. No.	RX94050507 RX94814124
description	flex hose SS braid straight-straight DN10 connections 1/2" L 2000mm approval DVGW operating p. 10bar test pressure 32bar burst p. 95bar		

pre-rinse hoses

stainless steel flexi hoses

1			
Part No.	520729	Ref. No.	25177072 RX25177072
description	shower hose connections 1/2" L 2800mm SS operating p. 10bar burst p. 90bar t.max. 90°C approval DVGW with flexible fabric		

formed hoses

straight

1			
Part No.	530603	Ref. No.	RX24556094
description	steam hose ID ø 60mm ED ø 68mm L 120mm Qty 1 for combi-steamer		

fittings, hose and pipe connectors

hose connectors

without screw connection

1			
Part No.	501210	Ref. No.	94809241 RX94809241
description	Y-piece plastic hose ø 10-10-10mm		



fittings

reducers



1

Part No.	520177	Ref. No.	94814405 RX94814405
description	reducer thread 1/4" ET - 1/8" IT nickel-plated brass total length 13mm WS 17		

hose connectors

nickel-plated brass



1

Part No.	520201	Ref. No.	94813991 RX94813991
description	hose connector nickel-plated brass straight thread 1/4" hose ø 12mm Qty 1 pcs		

valves and tank inlets

ball valves

universal

ball valves with butterfly handle



1

Part No.	540658	Ref. No.	RX94032687
description	ball valve connection 3/4" IT - 3/4" IT DN20 total length 69mm		

water cycle components



pressure reduction valves

pressure reduction valves

producer-specific



1

Part No.	520502	Ref. No.	RX94820013
description	pressure reduction valve Norgren series R91 connection 1/8" default settingbar setting range 0.1-3bar p max 10bar t.max. 50°C brass		
accessories for	520502		
	Part No.	541979	Ref. No. —
	manometer ø 40mm pressure range 0-4bar connection at the rear in the centre thread 1/8"		
	Part No.	542449	Ref. No. —
	manometer ø 40mm pressure range 0-6bar connection at the rear in the centre thread 1/8"		

supply filters



1

Part No.	520262	Ref. No.	94024528 RX94024528
description	supply filter thread 3/4" IT - 3/4" IT total length 70mm red brass DN20 mesh opening 0.4mm		

ancillary products

clamps

hose clamps

DIN 3017 - W2



1

Part No.	520118	Ref. No.	94814009 RX94814009
description	hose clamp ø 50-70mm width 9mm Qty 5 pcs DIN 3017		



fastening material

screws

cylinder head bolts

DIN 912/ISO 4762



1

Part No.	560402	Ref. No.	RX94803210
description	cylinder head bolt thread M5 thread L 10mm L 15.5mm WS 4 SS Qty 1 pcs intake hexagonal DIN 912/ISO 4762		

grub screws

miscellaneous



1

Part No.	560458	Ref. No.	94027281 RX94027281
description	grub screw thread M4 L 5mm intake slotted Qty 1 pcs		

washers

spring washers



1

Part No.	696429	Ref. No.	26160135 RX26160135
description	spring washer ID \varnothing 20.5mm ED \varnothing 40mm steel Qty 1 pcs		

washers

DIN 125A



1

Part No.	560112	Ref. No.	94813766 RX94813766
description	plain washer ID \varnothing 5.3mm ED \varnothing 10mm thickness 1mm SS Qty 20 pcs DIN 125A for thread M5		



1

Part No.	560333	Ref. No.	RX94801651
description	plain washer ID \varnothing 6.4mm ED \varnothing 12mm thickness 1.6mm SS Qty 1 pcs DIN 125A for thread M6		

fasteners

clamps

hose clamps

DIN 3017 - W2



1

Part No.	520118	Ref. No.	94814009 RX94814009
description	hose clamp \varnothing 50-70mm width 9mm Qty 5 pcs DIN 3017		

retaining rings

DIN 6799



1

Part No.	507015	Ref. No.	94803012 RX94803012
description	retaining ring E D1 \varnothing 7mm D2 \varnothing 14mm SS DIN 6799 thickness 0.9mm for shaft \varnothing 8-11mm		

consumables

sealants and adhesives

high temperature silicone



1

Part No.	890050	Ref. No.	RX94032679
description	high temperature silicone NOVASIL S76 acetoxy-curing -40 up to +265°C t.max. 280°C anthracite cartridge 310ml		
description	<p>Novasil S56 - cartridge 310ml - anthracite</p> <ul style="list-style-type: none"> - Developed for applications in the home appliance industry: <ul style="list-style-type: none"> - Gluing of oven door seals - Gluing of mounting brackets for cooker fascias, oven door seals and handles - Attachment of elastic seals, e.g. to oven doors Temperature resistance: -40°C to +265°C 		



fuses

fine fuses



1

Part No.	358677	Ref. No.	RX27630268
description	fine fuse size ø5x20mm 4A fast-acting rated 250V Qty 10 pcs		



1

Part No.	358607	Ref. No.	27630086 RX27630086
description	fine fuse size ø5x20mm 6.3A slow-acting rated 250V Qty 10 pcs		

screw locks

D0-system (NEOZED)



1

Part No.	358045	Ref. No.	RX27630227
description	fuse size D02 35A rated 250/400V E18 ø 15mm L 36mm Qty 10 pcs		

GASTROPARTS.COM



© 2020 Gastroparts Sp. J. All rights reserved.