



GASTROPARTS

Primax

[EN] Cooking

[DE] Kochtechnik

[ES] Cocción

[FR] Cuisson

[IT] Cottura

[PL] Obróbka termiczna

[RU] Термическая обработка

✉ gastroparts@gastroparts.com

☎ tel. +48 56 657 00 66

📘 fb.com/gastroparts.global

GASTROPARTS.COM





heating elements

heating elements for convection



1

Part No.	417555	Ref. No.	4663091
description	heating element 9000W 230V heating circuits 3 ID \varnothing 240mm ED \varnothing 257mm L 300mm H 100mm L1 38mm W1 104mm H1 8.5mm H2 85mm flange length 142mm flange width 25mm hole distance 126mm connection Faston 6.3mm connection length 85mm tube \varnothing 8.5mm convection heating element hole \varnothing 6.2mm rectangular flange INCOLOY-800		

energy regulators

ROBERTSHAW

MSA series



1

Part No.	380858	Ref. No.	4620700
description	energy regulator ROBERTSHAW 240V 15A turn direction right shaft \varnothing 6x4.6mm shaft L 23mm mounting thread 8"-32UNC		

thermostats

control and safety thermostats

EGO

control thermostats

55.10/19_ series



1

Part No.	390068	Ref. No.	4620600
description	thermostat t.max. 269°C temperature range 55-269°C 1-pole 1CO 16A probe \varnothing 3.1mm probe L 219mm capillary pipe 1280mm capillary pipe isolated 1270mm gland nut shaft \varnothing 6x4.6mm shaft L 23mm shaft position upper ^o rotation 318°		

safety thermostats

55.32_ series



1

Part No.	375228	Ref. No.	4620530
description	safety thermostat switch-off temp. 350°C 3-pole 20A probe \varnothing 3mm probe L 188mm capillary pipe 900mm capillary pipe isolated 900mm gland nut probe SS		

CAEM

safety thermostats



1

Part No.	376072	Ref. No.	4620510
description	safety thermostat switch-off temp. 320°C 1-pole 16A probe \varnothing 3mm probe L 160mm capillary pipe 900mm capillary pipe isolated 900mm gland nut 250V		

switches and momentary switches

microswitches

pin-plunger actuated



M10



1

Part No.	347288	Ref. No.	4611020	
description	microswitch with plunger thread M10x0.75 thread L 10mm 250V 16A 1NO connection male faston 6.3mm stroke 6mm mounting distance 22mm ambient temperature max. 125°C type VRSRB1AA1 actuating force: 160g			
accessories for	347288			
	Part No.	100779	Ref. No.	—
	nut thread M10x0.75 H 3mm WS 14 SS Qty 2 pcs			



			
1			
Part No.	346369	Ref. No.	4611050
description	microswitch with plunger thread M10x0.75 thread L 27mm 250V 16A 1CO connection male faston 6.3mm stroke 14mm mounting distance 22mm L 43mm L1 15mm L2 42mm ambient temperature max. 125°C type VRSRE1DA1 actuating force: 150g		
accessories for	346369		
	Part No.	Ref. No.	—
	 nut thread M10x0.75 H 3mm WS 14 SS Qty 2 pcs		

			
1			
Part No.	359705	Ref. No.	4640020 7750040 7750041
description	oven lamp glass thr.ø 33.5mm ø 52mm hard glas temp.-resist. 350°C		
accessories for	359705		
	Part No.	Ref. No.	—
	 PHILIPS light bulb t.max. 300°C socket E14 15W 230V ø 22mm L 47mm lens L 20mm for oven lamp type Philips		
	Part No.	Ref. No.	—
	 gasket for pizza oven fibre glass ID ø 32.5mm ED ø 55mm thickness 5mm		
	Part No.	Ref. No.	—
	 gasket silicone ED ø 48mm ID ø 39.5mm thickness 5mm Qty 1 pcs		
	Part No.	Ref. No.	—
	 gasket ID ø 33mm ED ø 46mm thickness 1mm graphite		
	Part No.	Ref. No.	—
	 gasket ID ø 33mm ED ø 45mm		

magnetic switches

M10x0.75

			
1			
Part No.	348190	Ref. No.	4611010
description	magnetic switch thread M10x0.75 1NO 100 DC/150 ACV 0.5A P max. 10W connection 2-wire cable length 1200mm		

lamps

screw-on/push-on fit

halogen lamp

for socket G4 / G6.35 / G9





			
1			
Part No.	357196	Ref. No.	4640030
description	halogen lamp socket G9 230V 40W temp.-resist. 300°C OSRAM HALOPIN OVEN		

oven lamps



universal oven lamps

mounting diameter 35.5mm

			
1			
Part No.	357160	Ref. No.	4640010
description	lamp socket socket G9 220-230V mounting ø 35.5mm connection cable 100mm		





<p>55x70mm</p> 			
1			
Part No.	357105	Ref. No.	4640070
description	lamp socket socket G9 250V mounting measurements 55x70mm connection male faston 6.3mm H 32mm		
accessories for	357105		
	Part No.	Ref. No.	4640080
	 frame L 95mm W 81mm mounting distance 68/83mm thickness 6mm		
	Part No.	Ref. No.	3531320
	 gasket L 91mm W 77mm hole ø 3mm for oven lamp		
	Part No.	Ref. No.	—
	 lamp glass L 80mm W 65mm mounting measurements 52x67mm		
	Part No.	Ref. No.	—
	 halogen lamp socket G9 230V 25W temp.-resist. 300°C 200 2000		

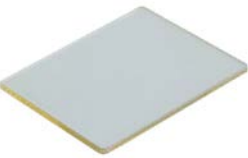

			
1			
Part No.	359297	Ref. No.	4640080
description	frame L 95mm W 81mm mounting distance 68/83mm thickness 6mm		
accessories for	359297		
	Part No.	359299	Ref. No. 3531320
	gasket L 91mm W 77mm hole ø 3mm for oven lamp		

			
1			
Part No.	359299	Ref. No.	3531320
description	gasket L 91mm W 77mm hole ø 3mm for oven lamp		

			
1			
Part No.	359296	Ref. No.	4640090
description	lamp glass L 74mm W 58mm thickness 3mm		

			
1			
Part No.	357105	Ref. No.	4640070
description	lamp socket socket G9 250V mounting measurements 55x70mm connection male faston 6.3mm H 32mm		
accessories for	357105		
	Part No.	359297	Ref. No. 4640080
	frame L 95mm W 81mm mounting distance 68/83mm thickness 6mm		
	Part No.	359299	Ref. No. 3531320
	gasket L 91mm W 77mm hole ø 3mm for oven lamp		
	Part No.	359937	Ref. No. —
	lamp glass L 80mm W 65mm mounting measurements 52x67mm		
	Part No.	359945	Ref. No. —
	halogen lamp socket G9 230V 25W temp.-resist. 300°C 200 2000		

lamps			
halogen lamps			
for socket G4 / G6.35 / G9			
			
1			
Part No.	357196	Ref. No.	4640030
description	halogen lamp socket G9 230V 40W temp.-resist. 300°C OSRAM HALOPIN OVEN		

timers

electric timers			
with time spread			
			
1			
Part No.	350154	Ref. No.	4620650
description	timer MS65 with bell operation time 120min time spread 30min 2CO/1NO at 250V 16A permanent position yes impulse electric shaft ø 6x4.6mm shaft L 20mm connection lateral Invensys 230V 3-pole		

contactors

LOVATO			
power contactors			
			
1			
Part No.	380720	Ref. No.	4581110
description	power contactor resistive load 32A 230VAC (AC3/400V) 25A/12.5kW main contacts 3NO auxiliary contacts 1NO connection screw connection type BF2510A230		



ALLEN BRADLEY

power contactors



1

Part No.	381121	Ref. No.	4581070
description	power contactor resistive load 32A 230VAC (AC3/400V) 16A/7.5kW main contacts 3NO auxiliary contacts 1NO connection screw connection type 100-C16KF10		

relays

power relays

with bracket mounting



1

Part No.	380812	Ref. No.	4582040
description	power relays FINDER 230VAC 30A 2CO connection F6.3 bracket mounting manif. no. 66.82.8.230.0000		



1

Part No.	380687	Ref. No.	4582030 4582110
description	power relays FINDER 230VAC 30A 2NO connection F6.3 bracket mounting manif. no. 66.82.8.230.0300		

solenoid valves



solenoid valves (water)

RPE

JOHN GUEST



1

Part No.	370772	Ref. No.	7711520	
description	solenoid valve double straight 230VAC inlet 3/4" outlet JG 8 DN10 t.max. 60°C duty cycle 100% RPE			
accessories for	370772			
	Part No.	371265	Ref. No.	—
	reducer flow rate 3l/min black			
	Part No.	371269	Ref. No.	—
	reducer flow rate 0.07-0.14l/min brown			



1

Part No.	374069	Ref. No.	7711120
description	solenoid valve single straight 230VAC inlet JG 8 outlet JG 8 input/ min output/min DN8 t.max. 25/60/90°C duty cycle 100% RPE 160001230V plastic		

solenoid valves with reducers

single



1

Part No.	374078	Ref. No.	7711110
description	solenoid valve 230VAC inlet JG 8 outlet JG 8 t.max. 60°C RPE flow regulating valve outlet brown output A 0.07-0.14l/min		



1

Part No.	374009	Ref. No.	7711510
description	solenoid valve single straight 220-240VAC inlet 3/4" outlet JG 8 input 10-12l/min t.max. 60°C duty cycle 100% RPE plastic flow regulating valve inlet white 1-ways medium temp max. 25°C		





fans

axial fans

import



1

Part No.	601080 ¹	Ref. No.	4650010
description	axial fan L 119mm W 119mm H 38mm 230VAC 50/60Hz 23/20W bearing ball bearing connection male faston 2.8mm metal ADDA fan wheel ø 110mm temp.-resist. 70°C		
accessories for	601080		
	Part No.	550898	Ref. No. —
	connecting cable cable length 2000mm connection F 2.8 connection distance 7.9mm for axial flow fan		
	Part No.	692519	Ref. No. —
	guard L 120mm W 120mm plastic		



¹with ball bearings

hot air motors

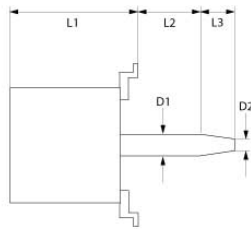

1



Part No.	601362	Ref. No.	4651030
description			
accessories for	601362		
	Part No.	365017	Ref. No. —
	operating capacitor capacity 5µF 450V tolerance 5% 50/60Hz ambient temperature max. -25 to +85°C ø 28mm L 54mm M8 plastic connection male faston 6.3mm 16.10.08 protection		
	Part No.	694600	Ref. No. —
	bush for hot air motors ø 25mm H 10mm seat ø 8.5mm		
	Part No.	694601	Ref. No. —
	spring for hot air motors ø 22mm H 18mm ID ø 19mm		



1

Part No.	601778	Ref. No.	4651540
description	fan wheel D1 ø 197mm H1 43mm blades 45 D2 ø 8mm D3 ø 8x6.8mm H2 14mm H3 1.5mm		

ignition parts

pilot burners

SIT

100 series

accessories

pilot burner bottom parts



1

Part No.	107770	Ref. No.	36430130 C36430130
description	pilot burner bottom part SIT 100 series nozzle ø 0.3mm gas connection 4mm Qty 1 pcs		

producer-specific pilot burners

PRIMAX



1

Part No.	107771	Ref. No.	31140080 C31140080
description	cover for pilot burner		



1

Part No.	107770	Ref. No.	36430130 C36430130
description	pilot burner bottom part SIT 100 series nozzle ø 0.3mm gas connection 4mm Qty 1 pcs		



thermocouples

plug-in thermocouples

plug-in thermocouples standard

with barrel socket $\varnothing 6(6.5)$ mm

thermocouples SIT

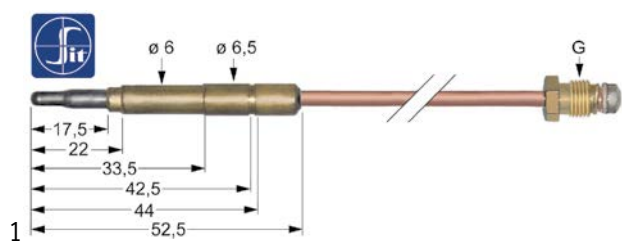

Part No.	107769 ¹	Ref. No.	36430050 C36430050
description	thermocouple SIT aluminized tip M9x1 L 400mm plug connection $\varnothing 6.0(6.5)$ mm		

¹aluminized tip

locks



handle latches



universal

inside fixing

locks



Part No.	694234	Ref. No.	3310040
description	door handle for headed units L 145mm W 40mm H 62mm spring length 40mm inner black		
spare parts for	694234		
	Part No.	514450	Ref. No.
	spring for door handle $\varnothing 6$ mm L 61mm W 27.5mm		
	Part No.	694734	Ref. No.
	door handle L 165mm W 40mm H 25mm black		
	Part No.	694735	Ref. No.
	cap $\varnothing 32$ mm black		

	Part No.	694882	Ref. No.	3310010 3310011 3310020
description	door handle L 165mm W 40mm H 62mm inner black			
accessories for	694882			
	Part No.	694881	Ref. No.	3310030
description	door catch total length 40mm M8 thread L 23mm W 26mm			

gaskets

gaskets for heated units

door seals

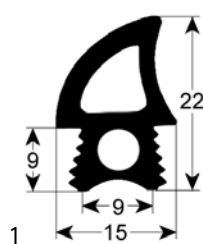

Part No.	901997	Ref. No.	3530100
description	door seal profile 2767 L 2200mm		

hoses

industrial hoses

PE hoses

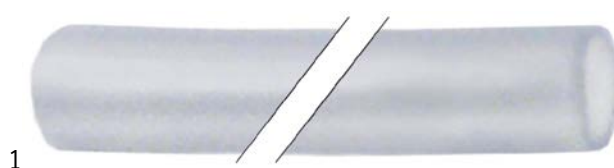

Part No.	520549 ¹	Ref. No.	2811080
description	hose Lm operating p. 6bar burst p. 10bar t.max. 65°C LLDPE transparent ID $\varnothing 6$ mm ED $\varnothing 8$ mm John Guest supplied by meter		

¹by the meter

GASTROPARTS.COM



© 2020 Gastroparts Sp. J. All rights reserved.