



GASTROPARTS

Parry

[EN] Cooking

[DE] Kochtechnik

[ES] Cocción

[FR] Cuisson

[IT] Cottura

[PL] Obróbka termiczna

[RU] Термическая обработка

✉ gastroparts@gastroparts.com

☎ tel. +48 56 657 00 66

📘 fb.com/gastroparts.global

GASTROPARTS.COM



energy regulators

EGO

1-circuit



1

Part No.	380019	Ref. No.	SATT37071
description	energy regulator 240V 13A single-circuit turn direction right shaft \varnothing 6x4.6mm shaft L 23mm mounting thread M4 power release 6-100% no. 50.57071.010		

thermostats

control and safety thermostats

EGO

control thermostats

55.13_ series



1

Part No.	375505	Ref. No.	TMST13062
description	thermostat t.max. 320°C temperature range 50-320°C 1-pole 1NO 16A probe \varnothing 3mm probe L 160mm capillary pipe 870mm capillary pipe isolatedmm gland nut shaft \varnothing 6x4.6mm shaft L 23mm shaft position upper rotation 270°		

safety thermostats

55.10/19_ series

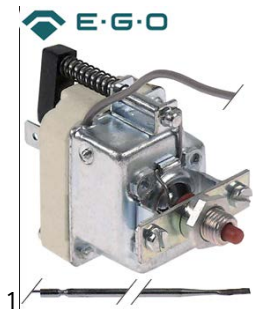

1

Part No.	375857	Ref. No.	EMTSS350
description	safety thermostat switch-off temp. 350°C 1-pole 16A probe \varnothing 3.1mm probe L 201mm capillary pipe 870mm capillary pipe isolated 870mm gland nut probe SS		

switches and momentary switches

rocker/momentary rocker switches

30x11mm



1

Part No.	301010	Ref. No.	SWRE06165	
description	rocker switch mounting measurements 30x11mm red 1NO/indicator light 250V 16A 0-I connection male faston 6.3mm ambient temperature max. 85/125°C protection IP40			
accessories for	301010			
	Part No.	301035	Ref. No.	—
	protective cover mounting measurements 30x11mm			

cam switches

on/off



1

Part No.	300129	Ref. No.	EMIG1600
description	cam switch 2 operating positions 2NO sequence 0-1 16A shaft \varnothing 6x4.6mm shaft L 23mm connection male faston 6.3mm ceramic		

lamps

indicator lights

indicator lights (complete)

\varnothing 10mm

with plug-in socket



1

Part No.	359139	Ref. No.	LNGN2211P
description	indicator light \varnothing 10mm green 230V connection male faston 6.3mm Qty 1 pcs		



1

Part No.	359138	Ref. No.	LNRE2211P
description	indicator light \varnothing 10mm red 230V connection male faston 6.3mm Qty 1 pcs		



ø12mm			
with screw socket			
			
1			
Part No.	359027	Ref. No.	EMLSAHRO
description	indicator light ø 12mm 250V green connection male faston 6.3mm		

screw-on/push-on fit

light bulbs			
for ovens			
			
1			
Part No.	359610	Ref. No.	EMPLLAHO
description	light bulb t.max. 300°C socket E14 15W 230V ø 22mm L 47mm lens L 20mm for oven lamp type Philips		

oven lamps

universal oven lamps			
mounting diameter 35.5mm			
			
1			
Part No.	359709	Ref. No.	EMPLG042
description	oven lamp glass thr.ø 33.5mm ø 42mm hard glas temp.-resist. 350°C		

				
1				
Part No.	359705	Ref. No.	EMPLG800	
description	oven lamp glass thr.ø 33.5mm ø 52mm hard glas temp.-resist. 350°C			
accessories for	359705			
	Part No.	359610	Ref. No.	EMPLLAHO
	light bulb t.max. 300°C socket E14 15W 230V ø 22mm L 47mm lens L 20mm for oven lamp type Philips			
	Part No.	359700	Ref. No.	—
gasket for pizza oven fibre glass ID ø 32.5mm ED ø 55mm thickness 5mm				
	Part No.	359721	Ref. No.	—
gasket silicone ED ø 48mm ID ø 39.5mm thickness 5mm Qty 1 pcs				
	Part No.	359837	Ref. No.	—
gasket ID ø 33mm ED ø 46mm thickness 1mm graphite				

accessories for	359705			
	Part No.	359838	Ref. No.	—
gasket ID ø 33mm ED ø 45mm				

lamps

light bulbs

			
1			
Part No.	359610	Ref. No.	EMPLLAHO
description	light bulb t.max. 300°C socket E14 15W 230V ø 22mm L 47mm lens L 20mm for oven lamp type Philips		

timers

mechanical timers

				
1				
Part No.	350030	Ref. No.	EMFTC120	
description	timer M2 2-pole operation time 120min impulse mechanical 2NO at 250V 16A permanent position no shaft ø 6x4.6mm shaft 6x4.6mm shaft L 23mm mounting distance 28mm connection lateral			
accessories for	350030			
	Part No.	110366	Ref. No.	—
knob switch zero mark t.max.°C ø 44mm shaft ø 6x4.6mm shaft flat upper black				
	Part No.	111199	Ref. No.	—
dial plate graduation 120min permanent position no rotation 0-330° ø 60mm timers knob ø 45mm				

contactors

SIEMENS

power contactors

			
1			
Part No.	380652	Ref. No.	EMCNAHAU
description	power contactor resistive load 22A 230VAC (AC3/400V) 9A/4kW main contacts 3NO auxiliary contacts 1NC connection screw connection type 3RT10-16-1AP02		



auxiliary contacts



1

Part No.	380947	Ref. No.	EMCNAHAU
description	auxiliary contact contacts 1NO/1NC AC15 3A for contactors 3RT102 3 RT103 connection screw connection type 3RH1921-1FA11		

solenoid valves







solenoid valves (water)

TP



1

Part No.	370015	Ref. No.	EMUASRPE
description	solenoid valve single angled 230VAC inlet 3/4" outlet 11.5mm DN10 TP		
accessories for	370015		
	Part No.	371220	Ref. No. —
	reducer TP flow rate 3l/min red tolerance ±15%		
	Part No.	371221	Ref. No. —
	reducer TP flow rate 5.5l/min yellow tolerance ±15%		
	Part No.	371222	Ref. No. —
	reducer TP flow rate 6l/min grey tolerance ±15%		
	Part No.	371223	Ref. No. —
	reducer TP flow rate 10l/min white tolerance ±15%		
	Part No.	371224	Ref. No. —
	reducer TP flow rate 12l/min bronze tolerance ±15%		
	Part No.	371225	Ref. No. —
	reducer TP flow rate 16l/min light brown tolerance ±15%		
	Part No.	371226	Ref. No. —
	reducer TP flow rate 20l/min red tolerance ±15%		
	Part No.	371230	Ref. No. —
	reducer TP flow rate 0.25l/min red tolerance ±25%		
	Part No.	371231	Ref. No. —
	reducer TP flow rate 0.35l/min violet tolerance ±25%		
	Part No.	371232	Ref. No. —
	reducer TP flow rate 0.5l/min orange tolerance ±25%		
	Part No.	371233	Ref. No. —
	reducer TP flow rate 0.8l/min white tolerance ±25%		

accessories for	370015		
	Part No.	371234	Ref. No. —
	reducer TP flow rate 1l/min light blue tolerance ±25%		
	Part No.	371235	Ref. No. —
	reducer TP flow rate 1.2l/min brown tolerance ±25%		
	Part No.	371236	Ref. No. —
	reducer TP flow rate 1.5l/min light brown tolerance ±25%		
	Part No.	371237	Ref. No. —
	reducer TP flow rate 2.5l/min yellow tolerance ±25%		
	Part No.	371238	Ref. No. —
	reducer TP flow rate 3.4l/min dark green tolerance ±25%		
	Part No.	371239	Ref. No. —
	reducer TP flow rate 5l/min black tolerance ±25%		
	Part No.	371240	Ref. No. —
	reducer TP flow rate 8l/min blue tolerance ±20%		

solenoid valves with reducers



1

Part No.	370437	Ref. No.	EMUA2RPE
description	solenoid valve double angled 230VAC inlet 3/4" input 10l/min output 1.2/1.2l/min DN10 t.max. 90°C TP plastic flow regulating valve inlet white outlet 11.5mm output A 1.2l/min output B 1.2l/min flow regulating valve outlet A dark brown flow regulating valve outlet B dark brown		

fans

axial fans

import



1

Part No.	601081 ¹	Ref. No.	EMMOAS6
description	axial fan L 80mm W 80mm H 38mm 230VAC 50/60Hz 14/13.5W bearing ball bearing connection male faston 2.8mm metal ADDA fan wheel ø 75mm temp.-resist. 70°C		
accessories for	601081		
	Part No.	691102	Ref. No. —
	guard ø 75mm mounting distance 71mm for axial fan 80mm		

¹with ball bearings



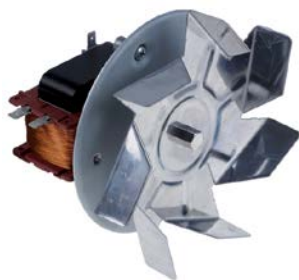

hot air fans

miscellaneous

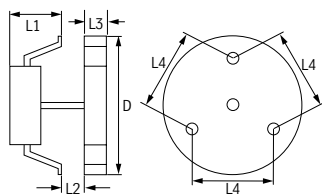

1



Part No.	601011	Ref. No.	EMMVR150
description	hot air fan 220-240V 40W 50/60Hz L1 65mm L2 15mm L3 25mm L4 87mm fan wheel ø 150mm FIME type C25R8023CLH		
accessories for	601011		
	Part No.	550879	Ref. No. —
	insulation ø 130mm thickness 3mm hole ø 18mm for hot air fan		
	Part No.	601260	Ref. No. —
	nut thread M6L IT for hot air fan		

electric accessories

terminals

connection terminals with screw/faston connections



1

Part No.	550278	Ref. No.	EMMR1102
description	power terminal block 3-pole max. 40A max 400V connection ø6mm ² / F6.3 temp.-resist. 150°C cross section 6mm ²		



1

Part No.	550411	Ref. No.	EMMR1224
description	power terminal block 6-pole max. 40A max 450V connection ø6mm ² / F6.3 temp.-resist. 150°C cross section 6mm ²		



1

Part No.	550977 ¹	Ref. No.	TB6POLETB
description	power terminal block 6-pole max. 40A max 450V connection ø6mm ² / F6.3 temp.-resist. 150°C cross section 6mm ² with ground lug		

¹with ground lug

ignition parts

pilot burners

SIT

100 series









1

Part No.	106906	Ref. No.	EMSITBPO
description	pilot burner SIT type 100 series 3 flames nozzle ø 0.2mm gas connection 6mm		
spare parts for	106906		
	Part No.	100245	Ref. No. —
	pilot burner nozzle LPG code 20 bore ø 0.2mm Qty 1 pcs thread M8x0.75		
	Part No.	100855	Ref. No. —
	pilot burner bracket triple		
	Part No.	100885	Ref. No. —
	air mixing sleeve for pilot burner Qty 1 pcs		
	Part No.	100916	Ref. No. —
	compression spring for pilot burner Qty 1 pcs		
	Part No.	100917	Ref. No. —
	gasket for pilot burner Qty 1 pcs aluminium ID ø 8.5mm ED ø 11mm thickness 1.2mm		
	Part No.	100918	Ref. No. —
	screw for pilot burner		
	Part No.	107162	Ref. No. —
	pilot burner cap SIT 3 flames Hmm Lmm Qty 1 pcs		
	Part No.	107701	Ref. No. —
	pilot burner bottom part SIT 100 series nozzle ø 0.2mm		

Table continues overleaf



accessories for		106906	
	Part No.	100245	Ref. No. —
	pilot burner nozzle LPG code 20 bore \varnothing 0.2mm Qty 1 pcs thread M8x0.75		
	Part No.	100246	Ref. No. —
	pilot burner nozzle natural gas bore \varnothing 0.35mm Qty 1 pcs thread M8x0.75		
	Part No.	100904	Ref. No. —
	locking screw M10x1 for pipe \varnothing 4mm Qty 1 pcs		
	Part No.	100905	Ref. No. —
	locking screw M10x1 for pipe \varnothing 6mm Qty 1 pcs		
	Part No.	102110	Ref. No. —
	pilot tube copper pipe \varnothing 4mm thickness 1mm L 3000mm		
	Part No.	102111	Ref. No. —
	pilot tube copper pipe \varnothing 6mm thickness 1mm L 3000mm		
	Part No.	107171	Ref. No. —
	pilot burner nozzle SIT natural/liquid gas bore \varnothing 0.25mm Qty 1 pcs		
	Part No.	107700	Ref. No. —
	pilot burner bottom part SIT 100 series nozzle \varnothing 0.25mm		
	Part No.	107702	Ref. No. —
	pilot burner bottom part SIT 100 series nozzle \varnothing 0.35mm		

accessories

ignition electrodes

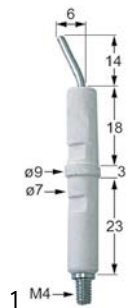

Part No.	100706	Ref. No.	EMSITCA0
description	ignition electrode connection M4 Qty 1 pcs		

ROBERTSHAW

pilot burners

universal series with electrodes



Part No.	106097	Ref. No.	PILOT3WAY
description	pilot burner ROBERTSHAW type 6SH24-6 3 flames natural gas code 26 for pipe \varnothing 1/4" CCT		

electrodes

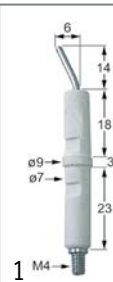

Part No.	100706	Ref. No.	EMSITCA0
description	ignition electrode connection M4 Qty 1 pcs		

ignition units



Part No.	102485	Ref. No.	EMACA000
description	ignition unit outputs 2 220-240VAC 0.6VA 50-60Hz		

thermocouples

thermocouple sets universal

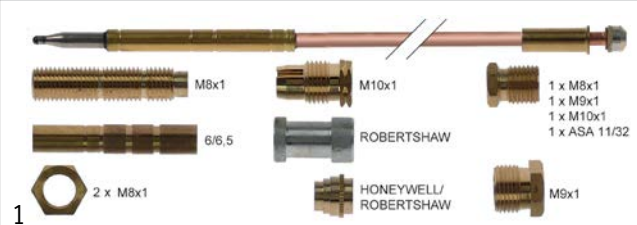

Part No.	102001	Ref. No.	THCP900MM
description	thermocouple set 17-piece L 900mm \varnothing 5mm point length 15mm BL 40mm		



plug-in thermocouples

plug-in thermocouples standard

with barrel socket $\varnothing 6(6.5)$ mm

thermocouples SIT

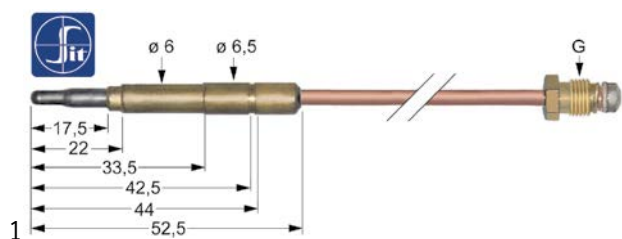

Part No.	107614	Ref. No.	EMSITT20
description	thermocouple SIT M9x1 L 1500mm plug connection $\varnothing 6.0(6.5)$ mm		

locks

handle latches

universal

outside fixing

locks



Part No.	694065	Ref. No.	MCCHSAMX	
description	door handle for headed units L 145mm W 40mm H 62mm spring length 33mm outer black			
spare parts for	694065			
	Part No.	514390	Ref. No.	—
	spring for door handle $\varnothing 6$ mm L 54mm W 27.5mm			
	Part No.	694734	Ref. No.	—
	door handle L 165mm W 40mm H 25mm black			
	Part No.	694735	Ref. No.	—
	cap $\varnothing 32$ mm black			
accessories for	694065			
	Part No.	694066	Ref. No.	—
	door catch with spigot 2-stage L 28mm W 14mm H 15mm H1 16mm total length 51mm thread M8 thread L 23mm stainless steel			
	Part No.	694067	Ref. No.	MCCHAGMX
	door catch with spigot 1-stage L 26mm total length 51mm thread M8			

edgmount latches

handle latches

CAFF/FERMOD

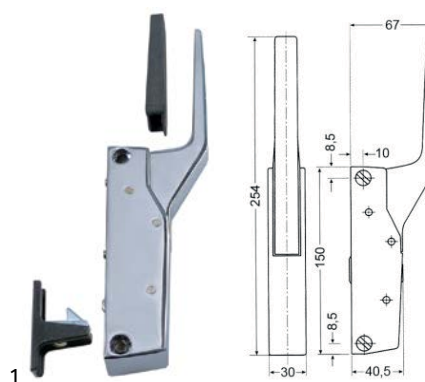

Part No.	701024	Ref. No.	MCCHIN04	
description	handle latch L 150mm mounting distance 133mm heated units type 790			
spare parts for	701024			
	Part No.	700061	Ref. No.	MCCHNA04
	door catch L 58mm W 20mm H 35mm mounting distance 42mm chrome-plated brass for headed units			
	Part No.	700062	Ref. No.	—
	handle protection heated units			

door catches



Part No.	700061	Ref. No.	MCCHNA04	
description	door catch L 58mm W 20mm H 35mm mounting distance 42mm chrome-plated brass for headed units			
accessories for	700061			
	Part No.	690414	Ref. No.	—
	handle latch L 150mm mounting distance 133mm non lockable refrigeration units G 791			

espagnolette locks

universal



Part No.	690041	Ref. No.	MCCHME10
description	cam L 148mm mounting distance 32mm		



gaskets

gaskets for heated units

window seals

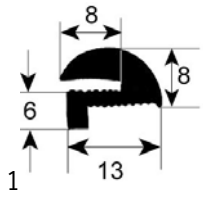

Part No.	900782	Ref. No.	MCGV0002
description	window gasket profile 1889 Qty supplied by meter		

door seals

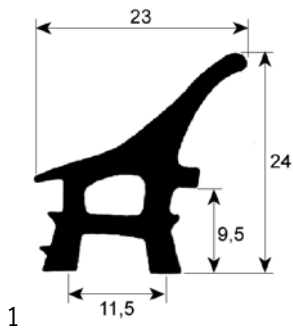

Part No.	900781	Ref. No.	MCGPN004
description	door seal profile 2403 Qty supplied by meter		

hoses

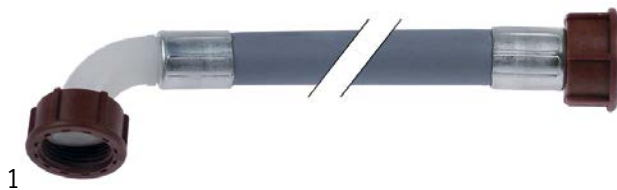

supply hoses

PVC supply hoses



Part No.	520010	Ref. No.	HOSE01500
description	supply hose PVC straight-curved DN13 connections 3/4" L 1500mm operating p. 10bar burst p. 32bar t.max. 90°C blue approval VDE flat seal		

accessories for 520010

	Part No.	520053	Ref. No.	—
	screen connection 3/4" D1 ø 26mm D2 ø 15mm Qty 10 pcs rubber thickness 8mm			
	Part No.	520054	Ref. No.	—
	flat gasket rubber ED ø 23.5mm ID ø 14mm thickness 2.3mm Qty 10 pcs			

consumables

sealants and adhesives

high temperature silicone



Part No.	890266	Ref. No.	CSR60902
description	high temperature silicone COLLEX RED SILICONE t.max. -40 up to +250°C red tube 80ml		
description	COLLEX RED SILICONE - tube 80ml - red In-situ flat gaskets for transmissions, compressors, pumps, manifolds, etc. Sealing joints for lighting devices and caulking for electric passages. Good resistance to motor oils, water and coolants. Temperature range -40°C to +250°C.		

GASTROPARTS.COM



© 2020 Gastroparts Sp. J. All rights reserved.