



**GASTROPARTS**

# Palux

**[EN]** Cooking

**[DE]** Kochtechnik

**[ES]** Cocción

**[FR]** Cuisson

**[IT]** Cottura

**[PL]** Obróbka termiczna

**[RU]** Термическая обработка

✉ [gastroparts@gastroparts.com](mailto:gastroparts@gastroparts.com)

☎ tel. +48 56 657 00 66

📘 [fb.com/gastroparts.global](https://fb.com/gastroparts.global)





**GASTROPARTS.COM**









## heating elements







## pilot heating elements

			
1			
<b>Part No.</b>	415607	<b>Ref. No.</b>	702188
<b>description</b>	heating element 500W 230V heating circuits 1 thread 3/4" L 295mm W 20mm H 19mm length thermostat sleeves 235mm thermostat sleeves ø 6mm number of thermostat sleeves 1 thermostat sleeve clinging tube ø 6.5mm immersion heater flange with thread connection length 50mm pilot heating element		
<b>For models:</b>	00443x, 00457x, 136581, 690570		
<b>spare parts for</b>	415607		
	<b>Part No.</b>	510403	<b>Ref. No.</b> —
	flat gasket fibre ED ø 36.5mm ID ø 27mm thickness 2mm Qty 1 pcs		
<b>accessories for</b>	415607		
	<b>Part No.</b>	510421	<b>Ref. No.</b> —
	gasket copper ED ø 31.8mm ID ø 26.4mm thickness 2.2mm for thread 3/4"		
	<b>Part No.</b>	520234	<b>Ref. No.</b> —
	nut thread 3/4" H 5mm brass WS 30 Qty 1 pcs		

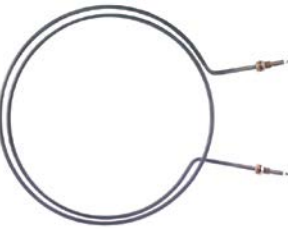
## heating elements for convection

			
1			
<b>Part No.</b>	418739	<b>Ref. No.</b>	722414 742414
<b>description</b>	heating element 10500W 230V heating circuits 3 ID ø 411mm ED ø 428mm L 480mm H 110mm L1 52mm W1 99mm H1 18mm H2 92mm flange length 130mm flange width 54mm hole distance 55mm connection M5 connection length 96mm tube ø 8.5mm convection heating element mounting thread M6 rectangular flange with thread bolt		
<b>For models:</b>	754595, 754609, 754676, 754681, 754692, 754706, 754749, 757365, 757373, 757381, 757403, 758736, 759201, 759678, 759686, 759694		
<b>accessories for</b>	418739		
	<b>Part No.</b>	551240	<b>Ref. No.</b> 749451
	gasket L 129mm W 87mm D1 ø 12mm D2 ø 7mm 12 holes graphite thickness 1mm		

			
1			
<b>Part No.</b>	418959	<b>Ref. No.</b>	742422
<b>description</b>	heating element 21600W 230V heating circuits 6 ID ø 414mm ED ø 466mm L 522mm H 121.5mm L1 88mm W1 97mm H1 30.5mm H2 91mm flange length 130mm flange width 88mm connection M5 connection length 70mm tube ø 6.5mm mounting thread M6 flange with bolt M6		
<b>accessories for</b>	418959		
	<b>Part No.</b>	519647	<b>Ref. No.</b> —
	counterflange ø 8mm perforation ø 13mm L 130mm W 88mm suitable for convection heating element 12 holes		
	<b>Part No.</b>	551240	<b>Ref. No.</b> 749451
	gasket L 129mm W 87mm D1 ø 12mm D2 ø 7mm 12 holes graphite thickness 1mm		

			
1			
<b>Part No.</b>	418766	<b>Ref. No.</b>	101125
<b>description</b>	heating element 4500W 230V heating circuits 1 ID ø 380mm ED ø 405mm L 530mm L1 100mm H 17mm thread M14x1.5 connection M4 tube ø 8.5mm		
<b>For models:</b>	674524, 674532, 674559, 674605, 674680, 674699, 674710, Heissluftdaempfer-10x1-1, Heissluftdaempfer-5x1-1, Heissluftdaempfer-6x1-1, Heissluftdaempfer-Varioplus-20x1-1, Heissluftgeraet-10x1-1, Heissluftgeraet-5x1-1		
<b>spare parts for</b>	418766		
	<b>Part No.</b>	510417	<b>Ref. No.</b> —
	flat gasket fibre ED ø 20mm ID ø 14mm thickness 2mm Qty 1 pcs		
<b>accessories for</b>	418766		
	<b>Part No.</b>	520228	<b>Ref. No.</b> —
	tooth lock washer ID ø 15.3mm ED ø 24mm steel Qty 1 pcs for thread M14		
	<b>Part No.</b>	520230	<b>Ref. No.</b> —
	nut thread M14x1.5 H 5mm WS 19 zinc-coated steel Qty 1 pcs		
	<b>Part No.</b>	521101	<b>Ref. No.</b> —
	nut thread M14x1.5 H 5mm WS 19 SS Qty 1 pcs		
	<b>Part No.</b>	550262	<b>Ref. No.</b> —
	flat gasket copper ED ø 20mm ID ø 14mm thickness 2mm		







1

<b>Part No.</b>	415805	<b>Ref. No.</b>	693383
<b>description</b>	heating element 5700W 230V heating circuits 3 ID ø 206mm ED ø 245mm L 290mm H 42mm L1 45mm W1 97mm H1 2mm H2 40mm flange length 110mm flange width 20mm hole distance 35mm connection male faston 6.3mm connection length 58mm tube ø 6.3mm convection heating element hole ø 6.5mm rectangular flange		
<b>For models:</b>	671568, 671576, 671584, 671592, 671606, 671614, 671622, 671630, 758752, 758760, 758981, 759007, 759015, 759023, 759031, 759058, 759066, 759074, 759171, 759198		







1

<b>Part No.</b>	415133	<b>Ref. No.</b>	399329
<b>description</b>	heating element 1430W 230V heating circuits 1 L 85mm W 395mm connection male faston 6.3mm tube ø 6.5mm thread M10x1 2 hole fixing dry heating element mounting distance 389mm		
<b>For models:</b>	390003, 397776, 397784, 397792, 397806, 397814, 397822, 397830, 397849, 397857, 397865, 397873, 399019, 399027, 399035, 399043, 399051, 399078, 399086, 399094, 399108, 399116, 609544, 609552, 609560, 645893, 645907, 645915, 645923, 645931, 645958, 645966, 645974, 645982, 645990, 646024, 646032, 674710, 674788, 674818, HLD-2011		
<b>accessories for</b>	415133		
	<b>Part No.</b>	520231	<b>Ref. No.</b> —
	nut thread M10x1 H 6mm WS 14 zinc-coated steel Qty 1 pcs		
	<b>Part No.</b>	521129	<b>Ref. No.</b> —
	nut thread M10 H 6mm SS WS 17 Qty 1 pcs DIN/ISO DIN 439		
	<b>Part No.</b>	528433	<b>Ref. No.</b> 097071 217840
	flat gasket copper ED ø 14mm ID ø 10mm thickness 1mm		



1

<b>Part No.</b>	415221	<b>Ref. No.</b>	332429
<b>description</b>	heating element 1430W 230V heating circuits 1 L 90mm W 390mm connection male faston 6.3mm tube ø 6.3mm thread M10x1 2 hole fixing dry heating element mounting distance 376mm		
<b>For models:</b>	674664, 674672, Heissluftdaempfer-10x1-1, Heissluftdaempfer-6x1-1		
<b>spare parts for</b>	415221		
	<b>Part No.</b>	510416	<b>Ref. No.</b> —
	flat gasket fibre ED ø 19mm ID ø 10.5mm thickness 1.5mm for thread M10 Qty 1 pcs		
<b>accessories for</b>	415221		
	<b>Part No.</b>	510893	<b>Ref. No.</b> —
	O-ring EPDM thickness 2.62mm ID ø 9.92mm Qty 1 pcs		
	<b>Part No.</b>	520231	<b>Ref. No.</b> —
	nut thread M10x1 H 6mm WS 14 zinc-coated steel Qty 1 pcs		

<b>accessories for</b>	415221		
	<b>Part No.</b>	521129	<b>Ref. No.</b> —
	nut thread M10 H 6mm SS WS 17 Qty 1 pcs DIN/ISO DIN 439		
	<b>Part No.</b>	528433	<b>Ref. No.</b> 097071 217840
	flat gasket copper ED ø 14mm ID ø 10mm thickness 1mm		







1

<b>Part No.</b>	418970	<b>Ref. No.</b>	585726
<b>description</b>	heating element 1450W 230V heating circuits 1 L 90mm W 315mm		
<b>For models:</b>	390003, 397229, 397237, 397245, 397253, 397261, 397288, 397296, 397318, 397326, 397334, 397342, 397350, 397776, 397784, 397792, 397806, 397814, 397822, 397830, 397849, 397857, 397865, 397873, 606316, 606324, 606332, 606340, 606359, 606367, 645893, 645907, 645915, 645923, 645931, 645958, 645966, 645974, 645982, 645990, 646024, 646032, 646040, 646059, 646067, 646768, 646776, 646784, 646792, 646806...(Other models you can see in the webshop)		



1

<b>Part No.</b>	415222	<b>Ref. No.</b>	576581
<b>description</b>	heating element 2300W 230V heating circuits 1 L 90mm W 395mm connection M4 tube ø 8.5mm thread M14x1.5 2 hole fixing dry heating element		
<b>accessories for</b>	415222		
	<b>Part No.</b>	521103	<b>Ref. No.</b> —
	nut thread M4 H 3mm WS 7 brass Qty 20 pcs		
	<b>Part No.</b>	521104	<b>Ref. No.</b> —
	washer ID ø 4.3mm ED ø 8mm thickness 0.5mm brass Qty 20 pcs for thread M4		
	<b>Part No.</b>	560111	<b>Ref. No.</b> —
	plain washer ID ø 4.3mm ED ø 9mm thickness 0.8mm SS Qty 20 pcs DIN 125A for thread M4		
	<b>Part No.</b>	560131	<b>Ref. No.</b> —
	hexagonal nut thread M4 H 3.2mm WS 7 SS DIN/ISO DIN 934 / ISO 4032/8673 Qty 20 pcs		



1





<b>Part No.</b>	415542	<b>Ref. No.</b>	370150
<b>description</b>	heating element 2500W 230V heating circuits 1 L 131mm W 485mm connection length 20mm connection M4 tube ø 8.5mm thread M14x1.5 2 hole fixing convection heating element mounting distance 480mm		
<b>accessories for</b>	415542		
	<b>Part No.</b>	510417	<b>Ref. No.</b> —
	flat gasket fibre ED ø 20mm ID ø 14mm thickness 2mm Qty 1 pcs		
	<b>Part No.</b>	520228	<b>Ref. No.</b> —
	tooth lock washer ID ø 15.3mm ED ø 24mm steel Qty 1 pcs for thread M14		

Table continues overleaf



accessories for		415542	
	Part No.	520230	Ref. No. —
	nut thread M14x1.5 H 5mm WS 19 zinc-coated steel Qty 1 pcs		
	Part No.	521101	Ref. No. —
	nut thread M14x1.5 H 5mm WS 19 SS Qty 1 pcs		
	Part No.	550262	Ref. No. —
	flat gasket copper ED ø 20mm ID ø 14mm thickness 2mm		



## accessories

## sealing washers

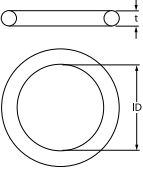
## O-rings

			
1			
<b>Part No.</b>	510408	<b>Ref. No.</b>	349232
<b>description</b>	O-ring EPDM thickness 5.34mm ID ø 47mm Qty 1 pcs		
<b>For models:</b>	665843, 665851, Glaeserspuelautomat-325, Glaeserspuelautomat-328		

## flange gaskets

			
1			
<b>Part No.</b>	551240	<b>Ref. No.</b>	749451
<b>description</b>	gasket L 129mm W 87mm D1 ø 12mm D2 ø 7mm 12 holes graphite thickness 1mm		
<b>accessories for</b>	551240		
	Part No.	519647	Ref. No. —
	counterflange ø 8mm perforation ø 13mm L 130mm W 88mm suitable for convection heating element 12 holes		

## energy regulators

## EGO

## 1-circuit

			
1			
<b>Part No.</b>	380015	<b>Ref. No.</b>	314544
<b>description</b>	energy regulator 230V 13A single-circuit turn direction right shaft ø 6x4.6mm shaft L 23mm mounting thread M4 power release 6-100% no. 50.57021.010		
<b>For models:</b>	503010, 503150, 517887, 574961, 610038, 61030x, 610402, 610429, 620203, 620300, 620408, 620424, 637564, 657735, 659002, 685003, 686018, 686026, 686034, 686298, 688428, 700673, 702560, 706000, FOEM-Kippbratpfanne-Elektro, ODWB-1040-Waermebruecken, ODWB-1240-Waermebruecken, ODWB-1440-Waermebruecken, ODWB-1640-Waermebruecken, ODWB-1840-Waermebruecken, ODWB-2040-Waermebruecken, OEWB-1040-Wand-Waermeborde, OEWB-1240-Wand-Waermeborde, OEWB-1440-Wand-Waermeborde, OEWB-1640-Wand-Waermeborde, OEWB-1840-Wand-Waermeborde, OEWB-2040-Wand-Waermeborde, steakgrill-61030, steakgrill-62030		

## accessories

## knobs

			
1			
<b>Part No.</b>	110235	<b>Ref. No.</b>	341894
<b>description</b>	knob energy regulator 1-3 t.max.°C ø 50mm shaft ø 6x4.6mm shaft flat upper black		
<b>For models:</b>	610038, 610429, 620203, 620424		



## thermostats

### control and safety thermostats

EGO

control thermostats

55.10/19\_ series

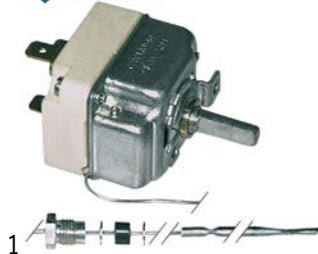

<b>Part No.</b>	375070	<b>Ref. No.</b>	091634
<b>description</b>	thermostat t.max. 250°C temperature range 55-250°C 1-pole 1C0 16A probe ø 3.1mm probe L 226mm capillary pipe 1170mm capillary pipe isolated 1100mm gland nut M9x1 shaft L 23mm shaft position upper rotation 270°		
<b>For models:</b>	140902, 367788, 382191, 385018, 385026, 385034, 385042, 385050, 385514, 389595, 389609, 390003, 397210, 397229, 397237, 397245, 397253, 397261, 397288, 397296, 397318, 397326, 397334, 397342, 397350, 397431, 397776, 397784, 397792, 397806, 397814, 397822, 397830, 397849, 397857, 397865, 397873, 398047, 398055, 398063, 398071, 398098, 398101, 398128, 398136, 398144, 398152, 398950, 398969, 398977...(Other models you can see in the webshop)		

55.13\_ series



<b>Part No.</b>	375505	<b>Ref. No.</b>	202029
<b>description</b>	thermostat t.max. 320°C temperature range 50-320°C 1-pole 1N0 16A probe ø 3mm probe L 160mm capillary pipe 870mm capillary pipe isolatedmm gland nut shaft ø 6x4.6mm shaft L 23mm shaft position upper rotation 270°		
<b>For models:</b>	750204, 750212, 750220, 750239, 750336, 750352, 750360		

55.34\_ series



<b>Part No.</b>	375143	<b>Ref. No.</b>	290319
<b>description</b>	thermostat t.max. 110°C temperature range 32-110°C 3-pole 3N0 16A probe ø 6mm probe L 138mm capillary pipe 1480mm capillary pipe isolated 1100mm gland nut M9x1 shaft ø 6x4.6mm shaft L 23mm shaft position upper rotation 270°		
<b>For models:</b>	140902, 667412, 684848, 688436, 689335, 689343, 689351, 689378, 718793, Maxima-Elektro-Bain-Marie-700-850, Maxima-Elektro-Bain-Marie-850		



<b>Part No.</b>	375101	<b>Ref. No.</b>	126543
<b>description</b>	thermostat t.max. 360°C temperature range 140-360°C 3-pole 3N0 16A probe ø 4mm probe L 292mm capillary pipe 990mm capillary pipe isolated 500mm gland nut shaft L 23mm shaft position upper rotation 318°		
<b>For models:</b>	Pizza-Ofen-ELP		

safety thermostats

55.11\_ series



<b>Part No.</b>	375093	<b>Ref. No.</b>	242746
<b>description</b>	safety thermostat switch-off temp. 318°C 1-pole 12A probe ø 4mm probe L 111mm capillary pipe 530mm capillary pipe isolated 450mm gland nut M9x1 probe SS		



## 55.32\_ series

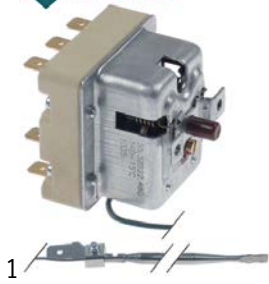

<b>Part No.</b>	390921	<b>Ref. No.</b>	572705
<b>description</b>	safety thermostat switch-off temp. 305°C 3-pole 3NC 20A probe ø 4mm probe L 128mm capillary pipe 890mm capillary pipe isolated 800mm gland nut probe		

## 55.33\_ series



<b>Part No.</b>	375075	<b>Ref. No.</b>	384429
<b>description</b>	safety thermostat switch-off temp. 305°C 3-pole probe		



<b>Part No.</b>	375118	<b>Ref. No.</b>	580457
<b>description</b>	safety thermostat switch-off temp. 360°C 3-pole 20A probe ø 15mm probe L 8mm capillary pipe 1150mm capillary pipe isolated 1100mm gland nut probe with knob probe		
<b>For models:</b>	671568, 671576, 671584, 671592, 671606, 671614, 671622, 671630, 671649, 671657, 671665, 671673, 671681, 671711, 671746, 671754, 671762, 671770, 671789, 671797, 671800, 671819, 671827, 671835, 671843, 671851, 671878, 671886, 671894, 671908, 671916, 671975, 671983, 671991, 680583, 680591		

## 56.\_ series

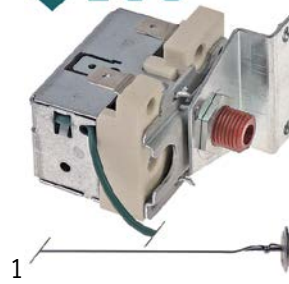

<b>Part No.</b>	375889	<b>Ref. No.</b>	504602
<b>description</b>	safety thermostat switch-off temp. 360°C 1-pole 16A probe ø 15mm probe L 6.5mm capillary pipe 1140mm capillary pipe isolated 1100mm gland nut probe		

<b>For models:</b>	671568, 671576, 671584, 671592, 671606, 671614, 671622, 671630, 754595, 754609, 754617, 754668, 754676, 754681, 754692, 754706, 754714, 754722, 754730, 754749, 754757, 754773, 754781, 757292, 757314, 757365, 757373, 757381, 757403, 757411, 757438, 757446, 757454, 757462, 757470, 758736, 758752, 758760, 758833, 758981, 759007, 759015, 759023, 759031, 759058, 759066, 759074, 759171, 759198, 759201...(Other models you can see in the webshop)		
--------------------	--	--	--

<b>accessories for</b>	375889			
	<b>Part No.</b>	518669	<b>Ref. No.</b>	373079
	gasket PTFE ED ø 21mm ID ø 15mm thickness 3.5mm			

## accessories



<b>Part No.</b>	518669	<b>Ref. No.</b>	373079	
<b>description</b>	gasket PTFE ED ø 21mm ID ø 15mm thickness 3.5mm			
<b>accessories for</b>	518669			
	<b>Part No.</b>	375889	<b>Ref. No.</b>	504602
	safety thermostat switch-off temp. 360°C 1-pole 16A probe ø 15mm probe L 6.5mm capillary pipe 1140mm capillary pipe isolated 1100mm gland nut probe			

## control thermostats with operation switch

## 55.34\_ series



<b>Part No.</b>	375140	<b>Ref. No.</b>	661635
<b>description</b>	thermostat t.max. 650°C temperature range 50°C/50-600°C/70-650°C 3-pole 3NO 16A probe ø 4mm probe L 228mm capillary pipe 1200mm capillary pipe isolated 1200mm gland nut shaft ø 6x4.6mm shaft L 23mm shaft position left rotation 318° outer switch 2NO		
<b>For models:</b>	663263, 663395, 670618, 670626, 688096, 688118, 703117, 703125, 709832, 709840, 733105, 733113, 736422, 736430		





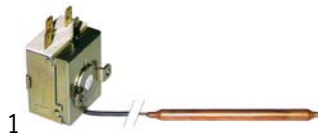

IMIT / TEMPOMATIC / ARTERMO

control thermostats

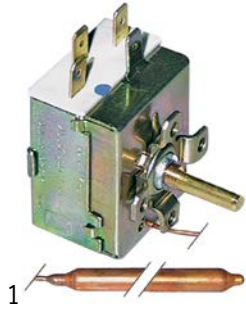

<b>Part No.</b>	390186	<b>Ref. No.</b>	208442
<b>description</b>	thermostat t.max. 52°C temperature range fixed 52°C 1-pole 1CO 16A probe ø 6.5mm probe L 95mm capillary pipe 1000mm capillary pipe isolated 1000mm gland nut shaft Lmm contacts 1CO		
<b>For models:</b>	Glaeserspuelautomat-310, Glaeserspuelautomat-311, Glaeserspuelautomat-320, Glaeserspuelautomat-321		



<b>Part No.</b>	390006	<b>Ref. No.</b>	208418
<b>description</b>	thermostat t.max. 86°C temperature range 0-86°C 1-pole 1CO 16A probe ø 6.5mm probe L 95mm capillary pipe 1500mm capillary pipe isolatedmm gland nut shaft ø 6x4.6mm shaft L 19mm rotation 270°		
<b>For models:</b>	Glaeserspuelautomat-310, Glaeserspuelautomat-311, Glaeserspuelautomat-320, Glaeserspuelautomat-321		
<b>accessories for</b>	390006		
	<b>Part No.</b>	110100	<b>Ref. No.</b> —
	knob thermostat t.max. 90°C 0-90°C ø 42mm shaft ø 6x4.6mm shaft flat -135° black		
	<b>Part No.</b>	110105	<b>Ref. No.</b> —
	rosette knob ø 42mm ø 56mm zero mark		

control thermostats with actual value



<b>Part No.</b>	379034	<b>Ref. No.</b>	368814
<b>description</b>	thermostat t.max. 450°C temperature range 50-450°C 1-pole 1CO 5A probe ø 6mm probe L 30mm capillary pipe 1150mm capillary pipe isolatedmm gland nut mounting ø 80mm mounting measurements 96x96mm		
<b>For models:</b>	Pizza-Ofen-P501, Pizza-Ofen-P502		

accessories

connecting bows



<b>Part No.</b>	550059	<b>Ref. No.</b>	086223
<b>description</b>	connecting bow short for switch Qty 1 pcs		

switches and momentary switches

rocker/momentary rocker switches

30x22mm



<b>Part No.</b>	301003	<b>Ref. No.</b>	053295
<b>description</b>	rocker switch mounting measurements 30x22mm green 2NO 250V 16A illuminated 0-I connection male faston 6.3mm ambient temperature max. 125/55°C protection IP65		
<b>For models:</b>	271500, 643807, 707007, 805556, 825263, Geschirrspuelautomat-330, GsP-350, GsP-500, schokomat-C		
<b>accessories for</b>	301003		
	<b>Part No.</b>	301036	<b>Ref. No.</b> —
	protective cover internal size 30x22mm for rocker switch mounting measurementsmm		

push/momentary push switches

30x22mm



<b>Part No.</b>	345863	<b>Ref. No.</b>	336912
<b>description</b>	momentary push switch mounting measurements 30x22mm clear 1NO/1NC 250V 16A illuminated connection male faston 4.8mm/6.3mm ambient temperature max. 85°C protection IP40		
<b>For models:</b>	361763, 367788, 378933, 382191, 385018, 385026, 385034, 385042, 385050, 385514, 397210, 397431, 440078, 440086, 440094, 440140, 440655, 450111, 606294		





			
1			
<b>Part No.</b>	301040 <sup>1</sup>	<b>Ref. No.</b>	266108 336904
<b>description</b>	push switch mounting measurements 30x22mm green 2NO 250V 16A illuminated connection male faston 6.3mm ambient temperature max. 85°C protection IP40		
<b>For models:</b>	340022, 340030, 340049, 340057, 340073, 353167, 354392, 354457, 361763, 378933, 440078, 440086, 440094, 440140, 440655, 450111, 643807, 668001, 669008, 707007, 825263, Glaeserspielauto mat-325, Glaeserspielautomat-328, ODWB-1040-Waermebruecken, ODWB-1240-Waermebruecken, ODWB-1440-Waermebruecken, ODWB-1640-Waermebruecken, ODWB-1840-Waermebruecken, ODWB-2040-Waermebruecken, OEWB-1040-Wand-Waermeborde, OEWB-1240-Wand-Waermeborde, OEWB-1440-Wand-Waermeborde, OEWB-1640-Wand-Waermeborde, OEWB-1840-Wand-Waermeborde, OEWB-2040-Wand-Waermeborde, OEWs1245-einseitig-400x1200mm, OEWs1246-einseitig-mit-Rueckwandverkleidung, UDWE1225L, UDWE1225L-doppelseitig-Eck-640x1200mm, UDWE1225R, UDWE1225R-doppelseitig-Eck-640x1200mm, UDWF0825, UDWF0825D-doppelseitig-640x800mm, UDWs1225, UDWs1225-doppelseitig-640x1200mm, UEFW0825, UEFW0825D-einseitig-640x800mm, UEWs06-schubladenblock-640x600mm, UEWs1225, UEWs1225-doppelseitig-640x1200mm...(Other models you can see in the webshop)		

<sup>1</sup>illuminated

## microswitches



## universal

			
			
1			
<b>Part No.</b>	345042	<b>Ref. No.</b>	570540
<b>description</b>	microswitch with plunger 250V 16A 1CO connection male faston 6.3mm L 28mm ambient temperature max. 125°C mounting distance 22mm type EF83161.3 actuating force: 75g blue/black		
<b>accessories for</b>	345042		
	<b>Part No.</b>	345043	<b>Ref. No.</b> —
	lever set 5-piece		

## lever actuated

			
1			
<b>Part No.</b>	345773	<b>Ref. No.</b>	144894 680907
<b>description</b>	microswitch with lever 250V 16A 1CO connection male faston 6.3mm L 60mm ambient temperature max. 125°C mounting distance 22mm actuating force: 65g lever length 51mm		
<b>For models:</b>	144819, 502200, 502308, 503010, 503150, 515892, 515906, 516678, 517887, 601004, 601209, 601403, 602000, 602205, 602280, 603007, 603023, 603201, 637564, 639087, 649554, 649562, 650943, 650951, 657735, 686298, 686336, 688339, 688347, 688355, 688428, 689696, 699047, 699055, 699063, 700673, 702560, 721468, 722588, 750255, Fritteuse-365, Fritteuse-600, Fritteuse-601, Fritteuse-602, Fritteuse-603, schokomat-C, Topline-Friteuse, Vario-Braeter-plus, Vario-Griller		

## pin-plunger actuated

			
			
1			
<b>Part No.</b>	345042	<b>Ref. No.</b>	570540
<b>description</b>	microswitch with plunger 250V 16A 1CO connection male faston 6.3mm L 28mm ambient temperature max. 125°C mounting distance 22mm type EF83161.3 actuating force: 75g blue/black		
<b>accessories for</b>	345042		
	<b>Part No.</b>	345043	<b>Ref. No.</b> —
	lever set 5-piece		

## M10

			
1			
<b>Part No.</b>	345032	<b>Ref. No.</b>	208477
<b>description</b>	microswitch with plunger thread M10x1 thread L 12mm 250V 16A 1CO connection male faston 6.3mm stroke 7mm mounting distance 22mm L 28mm ambient temperature max. 125°C type SP9603 actuating force: 180g		
<b>For models:</b>	Glaeserspielautomat-310, Glaeserspielautomat-311, Glaeserspielautomat-320, Glaeserspielautomat-321		

## M16

			
1			
<b>Part No.</b>	345046	<b>Ref. No.</b>	092444
<b>description</b>	microswitch with plunger thread M16x1 thread L 25mm 250V 5A 1NC/1NO connection male faston 6.3mm stroke 6mm ambient temperature max. 85°C actuating force: 400g		
<b>For models:</b>	389595, 389609, 398950, 398969, 398977, 609188, 609196, 637599, 674524, 674532, 674605, 674648, 674656, 674664, 674672, 674680, 674699, 674885, Heissluftdaempfer-10x1-1, Heissluftdaempfer-5x1-1, Heissluftdaempfer-5x2-3, Heissluftdaempfer-6x1-1, Heissluftgeraet-5x1-1, Heissluftgeraet-5x2-3		

## accessories

			
1			
<b>Part No.</b>	347013	<b>Ref. No.</b>	587141
<b>description</b>	lever for microswitch		
<b>For models:</b>	671568, 671576, 671584, 671592, 671606, 671614, 671622, 671630, 758752, 758760, 758981, 759007, 759015, 759023, 759031, 759058, 759066, 759074, 759171, 759198		







cam switches

on/off



1

<b>Part No.</b>	300020	<b>Ref. No.</b>	291757
<b>description</b>	cam switch 4 operating positions 2NO sequence 0-1-0-1 16A shaft ø 6x4.6mm shaft L 23mm connection screw ceramic		
<b>For models:</b>	Maxima-Elektro-Kippbratpfanne-700-850, Maxima-Gas-Kippbratpfanne-neue-Ausfuehrung-700-850		
<b>accessories for</b>	300020		
	<b>Part No.</b>	110135	<b>Ref. No.</b> —
	rosette knob up to ø 52mm		
	<b>Part No.</b>	110231	<b>Ref. No.</b> —
	knob switch 0-1-0-1 t.max.°C ø 50mm shaft ø 6x4.6mm shaft flat upper black		

4-position

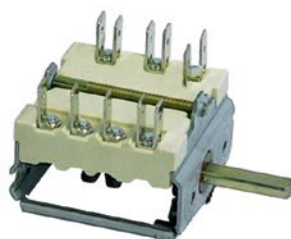

1

<b>Part No.</b>	300016	<b>Ref. No.</b>	104248
<b>description</b>	cam switch 4 operating positions 1NO/2CO sequence 0-1-2-3 16A shaft ø 6x4.6mm shaft L 23mm connection male faston 6.3mm ceramic		
<b>For models:</b>	685003, Grill-681		



1

<b>Part No.</b>	300103	<b>Ref. No.</b>	226491
<b>description</b>	cam switch 4 operating positions 1NO/2CO sequence 0-1-2-3 32A shaft ø 6x4.6mm shaft L 23mm connection screw ceramic		
<b>For models:</b>	541869, 638625, 730416, FOEM-Elektro-Kochplatten		



1

<b>Part No.</b>	300104	<b>Ref. No.</b>	126608
<b>description</b>	cam switch 4 operating positions 3NO/1CO sequence 0-1-2-3 32A shaft ø 6x4.6mm shaft L 23mm connection screw ceramic		
<b>For models:</b>	Grill-682, Grill-683		

4 operating positions

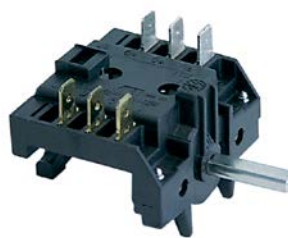

1

<b>Part No.</b>	300033	<b>Ref. No.</b>	103680 370983
<b>description</b>	cam switch 4 operating positions 4NO sequence 0-1-2-3 16A shaft ø 6x4.6mm shaft L 23mm connection male faston 6.3mm plastic		
<b>For models:</b>	Heisse-Theke-HT-50-85-und-120-3		

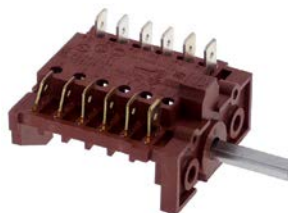

1

<b>Part No.</b>	300057	<b>Ref. No.</b>	292664
<b>description</b>	cam switch 4 operating positions 6NO sequence 0-1-2-3 16A shaft ø 6x4.6mm shaft L 23mm connection male faston 6.3mm 6CH/141 plastic		
<b>For models:</b>	Heissluftdaempfer-10x1-1, Heissluftdaempfer-5x1-1, Heissluftdaempfer-5x2-3		

5 operating positions



1

<b>Part No.</b>	345199	<b>Ref. No.</b>	720534
<b>description</b>	cam switch 5 operating positions 2NO/1CO sequence 0-1-2-3-4 16A shaft ø 6x4.6mm shaft L 23mm connection male faston 6.3mm		
<b>For models:</b>	354716, 354724		



## magnetic switches

M12x1

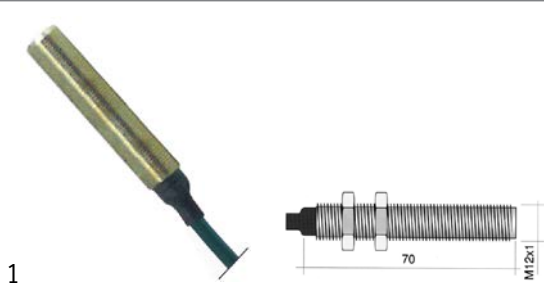

<b>Part No.</b>	345135	<b>Ref. No.</b>	372986
<b>description</b>	magnetic switch thread M12x1 1NO 250V 3A P max. 100W connection cable cable length 2000mm L 72mm type 122		

## switch blocks



<b>Part No.</b>	359756	<b>Ref. No.</b>	580384
<b>description</b>	contact block latching 1NO/1NC connection male faston 2.8mm illuminable socket T5.5K type BFL5		
<b>For models:</b>	671568, 671576, 671584, 671592, 671606, 671614, 671622, 671630, 671649, 671657, 671665, 671673, 671681, 671711, 671746, 671754, 671789, 671797, 671800, 671819, 671827, 671835, 671843, 671851		
<b>accessories for</b>	359756		
	<b>Part No.</b>	359593	<b>Ref. No.</b> 323519
	light bulb socket T5.5K 60V 0.02A		

## control equipment

## SCHLEGEL

## push buttons



<b>Part No.</b>	359183	<b>Ref. No.</b>	323527 332712
<b>description</b>	momentary switch unit mounting measurements $\varnothing 16/24 \times 24$ mm type momentary anthracite/transparent square		
<b>For models:</b>	Heissluftdaempfer-10x1-1, Heissluftdaempfer-20x1-1, Heissluftdaempfer-5x1-1, Heissluftdaempfer-5x2-3, Heissluftgeraet-672, Heissluftgeraet-673		



<b>Part No.</b>	346188	<b>Ref. No.</b>	580341
<b>description</b>	momentary switch unit mounting measurements $\varnothing 16/24 \times 24$ mm type momentary black/white square		
<b>For models:</b>	671568, 671576, 671584, 671592, 671606, 671614, 671622, 671630, 671649, 671657, 671665, 671673, 671681, 671711, 671746, 671754, 671789, 671797, 671800, 671819, 671827, 671835, 671843, 671851		

## symbol plates



<b>Part No.</b>	359757	<b>Ref. No.</b>	580368
<b>description</b>	symbol plate octagonal white ON-OFF		



<b>Part No.</b>	359184	<b>Ref. No.</b>	323535
<b>description</b>	contact block momentary 1NC/1NO connection male faston 2.8mm socket type AT		
<b>For models:</b>	389595, 389609, 398950, 398969, 398977, 609188, 609196, 637599, 674648, 674656, 674664, 674680, 674885, Heissluftdaempfer-10x1-1, Heissluftdaempfer-20x1-1, Heissluftdaempfer-5x1-1, Heissluftdaempfer-5x2-3, Heissluftdaempfer-6x1-1, Heissluftdaempfer- Varioplus-20x1-1, Heissluftdaempfer-Varioplus-20x2-1, Heissluftgeraet-672, Heissluftgeraet-673		



## accessories



<b>Part No.</b>	359768	<b>Ref. No.</b>	580376
<b>description</b>	cap for momentary switch transparent/colourless octagonal L 19.4mm W 19.4mm		

## lamps



<b>Part No.</b>	359606	<b>Ref. No.</b>	1G887026
<b>description</b>	neon light bulb socket Ba9s 230V 2W clear $\varnothing 10$ mm L 28mm		
<b>accessories for</b>	359606		
	<b>Part No.</b>	359832	<b>Ref. No.</b> —
	lamp socket mounting measurements $\varnothing 16.2$ mm socket Ba9s connection male faston 6.3mm		
	<b>Part No.</b>	359853	<b>Ref. No.</b> —
	lamp socket mounting measurements $\varnothing 18.2$ mm socket Ba9s connection male faston 6.3mm		





# lamps

## indicator lights

### indicator lights 3-piece (housing, lens and bulb)

#### lamps

#### neon light bulbs

			
1			
<b>Part No.</b>	359606	<b>Ref. No.</b>	1G887026
<b>description</b>	neon light bulb socket Ba9s 230V 2W clear ø 10mm L 28mm		
<b>accessories for</b>	359606		
	<b>Part No.</b>	359832	<b>Ref. No.</b> —
	lamp socket mounting measurements ø16.2mm socket Ba9s connection male faston 6.3mm		
	<b>Part No.</b>	359853	<b>Ref. No.</b> —
	lamp socket mounting measurements ø18.2mm socket Ba9s connection male faston 6.3mm		

			
1			
<b>Part No.</b>	359600	<b>Ref. No.</b>	035378
<b>description</b>	neon light bulb socket E10 220V 0.35W clear ø 10mm L 28mm		
<b>For models:</b>	685003, 686018, Grill-680, Grill-681, Grill-682, Grill-683, Heissluftgeraet-10x1-1, Heissluftgeraet-5x1-1, Heissluftgeraet-5x2-3, Heissluftgeraet-672, Heissluftgeraet-673, Heissluftgeraet-67310, Wandkaffeemaschine-001		
<b>accessories for</b>	359600		
	<b>Part No.</b>	359060	<b>Ref. No.</b> 101818
	lamp socket mounting measurements ø16.2mm socket E10 connection screw		
	<b>Part No.</b>	359063	<b>Ref. No.</b> —
	lamp socket mounting measurements ø19.2mm socket E14 connection screw		
	<b>Part No.</b>	359064	<b>Ref. No.</b> —
	lamp socket mounting measurements ø22.3mm socket E14 connection screw 250/380V ambient temperature at 1W 100°C ambient temperature at 2W 85°C		
	<b>Part No.</b>	359685	<b>Ref. No.</b> —
	lamp socket mounting measurements ø16.2mm socket E10		
	<b>Part No.</b>	359832	<b>Ref. No.</b> —
	lamp socket mounting measurements ø16.2mm socket Ba9s connection male faston 6.3mm		
	<b>Part No.</b>	359853	<b>Ref. No.</b> —
	lamp socket mounting measurements ø18.2mm socket Ba9s connection male faston 6.3mm		
	<b>Part No.</b>	359988	<b>Ref. No.</b> —
	lamp socket mounting measurements ø30.5mm 250V connection F6.3 temp.-resist. 55°C E14		

			
1			
<b>Part No.</b>	359602	<b>Ref. No.</b>	006718
<b>description</b>	neon light bulb socket E14 230V clear ø 14mm L 30mm		
<b>For models:</b>	721468, 721476, 721484, 722588, 722596, 722618, Maxima-Elektro-Backofen-700-850, Maxima-Elektro-Backofen-850, Maxima-Elektro-Bain-Marie-700-850, Maxima-Elektro-Bain-Marie-850, Maxima-Elektro-Herd-700-850, Maxima-Elektro-Herd-850, Maxima-Elektro-Kippbratpfanne-700-850		

### indicator lights (complete)

<b>ø 6mm</b>			
			
1			
<b>Part No.</b>	359004	<b>Ref. No.</b>	332771
<b>description</b>	indicator light ø 6mm 230V green cable length 400mm temp.-resist. 106°C		

			
1			
<b>Part No.</b>	359005	<b>Ref. No.</b>	332798
<b>description</b>	indicator light ø 6mm 230V yellow cable length 400mm		

### ø10mm with plug-in socket

			
1			
<b>Part No.</b>	359230	<b>Ref. No.</b>	370991
<b>description</b>	indicator light ø 10mm green 230V connection male faston 2.8mm Qty 1 pcs		
<b>For models:</b>	Heisse-Theke-HT-50-85-und-120-3		

			
1			
<b>Part No.</b>	359140	<b>Ref. No.</b>	091462 091642
<b>description</b>	indicator light ø 10mm yellow 230V connection male faston 6.3mm Qty 1 pcs		

### 30x22mm

			
1			
<b>Part No.</b>	359156	<b>Ref. No.</b>	053317
<b>description</b>	indicator light mounting measurements 30x22mm 230V yellow connection male faston 6.3mm temp.-resist. 125/55°C type RL2		
<b>For models:</b>	271500, 805556, Geschirrspuelautomat-330, GsP-350, GsP-500		



## miscellaneous



1

<b>Part No.</b>	359429	<b>Ref. No.</b>	395056
<b>description</b>	indicator light 230V connection male faston 6.3mm mounting ø 18mm		
<b>For models:</b>	140902, 354643, 354651, 354678, 354686, 354694, 354708, 502200, 502308, 502650, 502707, 503010, 503150, 505900, 505935, 515892, 515906, 517887, 541869, 627984, 628018, 628026, 637564, 638625, 649554, 649562, 650129, 650137, 650145, 650153, 650943, 650951, 657735, 659002, 663263, 663395, 667412, 670618, 670626, 684848, 686247, 686298, 686328, 686336, 686409, 687200, 687960, 688096, 688118, 688290...(Other models you can see in the webshop)		

## screw-on/push-on fit

## neon light bulbs



1

<b>Part No.</b>	359606	<b>Ref. No.</b>	1G887026	
<b>description</b>	neon light bulb socket Ba9s 230V 2W clear ø 10mm L 28mm			
<b>accessories for</b>	359606			
	<b>Part No.</b>	359832	<b>Ref. No.</b>	—
	lamp socket mounting measurements ø16.2mm socket Ba9s connection male faston 6.3mm			
	<b>Part No.</b>	359853	<b>Ref. No.</b>	—
	lamp socket mounting measurements ø18.2mm socket Ba9s connection male faston 6.3mm			



1

<b>Part No.</b>	359600	<b>Ref. No.</b>	035378	
<b>description</b>	neon light bulb socket E10 220V 0.35W clear ø 10mm L 28mm			
<b>For models:</b>	685003, 686018, Grill-680, Grill-681, Grill-682, Grill-683, Heissluftgeraet-10x1-1, Heissluftgeraet-5x1-1, Heissluftgeraet-5x2-3, Heissluftgeraet-672, Heissluftgeraet-673, Heissluftgeraet-67310, Wandkaffeemaschine-001			
<b>accessories for</b>	359600			
	<b>Part No.</b>	359060	<b>Ref. No.</b>	101818
	lamp socket mounting measurements ø16.2mm socket E10 connection screw			
	<b>Part No.</b>	359063	<b>Ref. No.</b>	—
	lamp socket mounting measurements ø19.2mm socket E14 connection screw			
	<b>Part No.</b>	359064	<b>Ref. No.</b>	—
	lamp socket mounting measurements ø22.3mm socket E14 connection screw 250/380V ambient temperature at 1W 100°C ambient temperature at 2W 85°C			
	<b>Part No.</b>	359685	<b>Ref. No.</b>	—
	lamp socket mounting measurements ø16.2mm socket E10			
	<b>Part No.</b>	359832	<b>Ref. No.</b>	—
	lamp socket mounting measurements ø16.2mm socket Ba9s connection male faston 6.3mm			
	<b>Part No.</b>	359853	<b>Ref. No.</b>	—
	lamp socket mounting measurements ø18.2mm socket Ba9s connection male faston 6.3mm			

<b>accessories for</b>	359600			
	<b>Part No.</b>	359988	<b>Ref. No.</b>	—
	lamp socket mounting measurements ø30.5mm 250V connection F6.3 temp.-resist. 55°C E14			

	<b>Part No.</b>	359602	<b>Ref. No.</b>	006718
<b>description</b>	neon light bulb socket E14 230V clear ø 14mm L 30mm			
<b>For models:</b>	721468, 721476, 721484, 722588, 722596, 722618, Maxima-Elektro-Backofen-700-850, Maxima-Elektro-Backofen-850, Maxima-Elektro-Bain-Marie-700-850, Maxima-Elektro-Bain-Marie-850, Maxima-Elektro-Herd-700-850, Maxima-Elektro-Herd-850, Maxima-Elektro-Kippbratpfanne-700-850			

## light bulbs

## for ovens

	<b>Part No.</b>	359610	<b>Ref. No.</b>	047635
<b>description</b>	light bulb t.max. 300°C socket E14 15W 230V ø 22mm L 47mm lens L 20mm for oven lamp type Philips			
<b>For models:</b>	685003, 805xxx, 890502, 890510, 890529, 890553, 890561, 890588, 890596, 890618, 890626, Aromacarina, Aromacarina-Dampf, Aromacarina-Esa, Aromacarina-ETA, Aromacarina-ETA-Esa, Heissluftdaempfer-10x1-1, Heissluftdaempfer-20x1-1, Heissluftdaempfer-5x1-1, Heissluftdaempfer-5x2-3, Heissluftgeraet-10x1-1, Heissluftgeraet-5x1-1, Heissluftgeraet-5x2-3, Heissluftgeraet-672, Heissluftgeraet-673, Heissluftgeraet-67310			

	<b>Part No.</b>	359612	<b>Ref. No.</b>	354252
<b>description</b>	light bulb t.max. 300°C socket E14 25W 230V ø 25mm L 56mm lens L 30mm for oven lamp type Philips			
<b>For models:</b>	367788, 382191, 385018, 385026, 385034, 385042, 385050, 385514, 389595, 389609, 390003, 397210, 397229, 397237, 397245, 397253, 397261, 397288, 397296, 397318, 397326, 397334, 397342, 397350, 397431, 397776, 397784, 397792, 397806, 397814, 397822, 397830, 397849, 397857, 397865, 397873, 398047, 398055, 398063, 398071, 398098, 398101, 398128, 398136, 398144, 398152, 398950, 398969, 398977, 399019...(Other models you can see in the webshop)			

## halogen lamp

## for socket G4 / G6.35 / G9

	<b>Part No.</b>	359599	<b>Ref. No.</b>	570478
<b>description</b>	halogen lamp socket G4 12V 20W temp.-resist. 500°C			



linear lamps

infrared lamps

with base type R7s



<b>Part No.</b>	359628	<b>Ref. No.</b>	164941
<b>description</b>	infrared lamp socket R7s L 117.6mm 240V 300W IMPORT unjacketed		
<b>For models:</b>	Heisse-Theke-HT-50-85-und-120-3		

with base type X lug



<b>Part No.</b>	359617	<b>Ref. No.</b>	104566 531332
<b>description</b>	infrared lamp 1000W 220V L 365mm lens L 340mm total length 480mm with mounting strap		
<b>For models:</b>	Grill-681, Grill-682, Grill-683		

sockets for linear lamps

X lug



<b>Part No.</b>	359710	<b>Ref. No.</b>	104574
<b>description</b>	lamp socket L 70mm W 70mm H 49mm mounting distance 50mm bracket mounting		
<b>For models:</b>	Grill-681, Grill-682, Grill-683		



oven lamps







universal oven lamps

mounting diameter 35.5mm



<b>Part No.</b>	359701	<b>Ref. No.</b>	100838
<b>description</b>	lamp socket socket E14 220-230V mounting ø 35.5mm connection male faston 6.3mm 15W		
<b>For models:</b>	398047, 398055, 398063, 398071, 398098, 398101, 398128, 398136, 398144, 398152, 609501, 609528, 609536, 674559, 674648, 674656, 674664, 674672, 674680, 674699, 674834, 674893, 685003, Heissluftdaempfer-10x1-1, Heissluftdaempfer-20x1-1, Heissluftdaempfer-5x1-1, Heissluftdaempfer-5x2-3, Heissluftdaempfer-6x1-1, Heissluftgeraet-10x1-1, Heissluftgeraet-5x1-1, Heissluftgeraet-5x2-3, Heissluftgeraet-672, Heissluftgeraet-673, Heissluftgeraet-67310		
<b>accessories for</b>	359701		
	<b>Part No.</b>	359705	<b>Ref. No.</b> 092339
	oven lamp glass thr.ø 33.5mm ø 52mm hard glas temp.-resist. 350°C		

<b>accessories for</b>	359701		
	<b>Part No.</b>	359709	<b>Ref. No.</b> —
	oven lamp glass thr.ø 33.5mm ø 42mm hard glas temp.-resist. 350°C		
	<b>Part No.</b>	359721	<b>Ref. No.</b> 316296 693421
	gasket silicone ED ø 48mm ID ø 39.5mm thickness 5mm Qty 1 pcs		
	<b>Part No.</b>	359942	<b>Ref. No.</b> —
	oven lamp glass thr.ø 33.5mm ø 41mm hard glas temp.-resist. 350°C		

	<b>Part No.</b>	359705	<b>Ref. No.</b> 092339
<b>description</b>	oven lamp glass thr.ø 33.5mm ø 52mm hard glas temp.-resist. 350°C		
<b>For models:</b>	671568, 671576, 671584, 671592, 671606, 671614, 671622, 671630, 758752, 758760, 758981, 759007, 759015, 759023, 759031, 759058, 759066, 759074, 759171, 759198, Heissluftdaempfer-10x1-1, Heissluftdaempfer-20x1-1, Heissluftdaempfer-5x1-1, Heissluftdaempfer-5x2-3		
<b>accessories for</b>	359705		
	<b>Part No.</b>	359610	<b>Ref. No.</b> 047635
	light bulb t.max. 300°C socket E14 15W 230V ø 22mm L 47mm lens L 20mm for oven lamp type Philips		
	<b>Part No.</b>	359700	<b>Ref. No.</b> —
	gasket for pizza oven fibre glass ID ø 32.5mm ED ø 55mm thickness 5mm		
	<b>Part No.</b>	359721	<b>Ref. No.</b> 316296 693421
	gasket silicone ED ø 48mm ID ø 39.5mm thickness 5mm Qty 1 pcs		
	<b>Part No.</b>	359837	<b>Ref. No.</b> —
	gasket ID ø 33mm ED ø 46mm thickness 1mm graphite		
	<b>Part No.</b>	359838	<b>Ref. No.</b> —
	gasket ID ø 33mm ED ø 45mm		

	<b>Part No.</b>	359721	<b>Ref. No.</b> 316296 693421
<b>description</b>	gasket silicone ED ø 48mm ID ø 39.5mm thickness 5mm Qty 1 pcs		
<b>For models:</b>	Heissluftdaempfer-10x1-1, Heissluftdaempfer-5x1-1, Heissluftdaempfer-5x2-3		

1 electric components





## producer-specific oven lamps

## PALUX



1

<b>Part No.</b>	359068	<b>Ref. No.</b>	314019
<b>description</b>	lamp socket with 2 hole fixing socket E14 ø 25mm		

## lamps

## light bulbs



1

<b>Part No.</b>	359610	<b>Ref. No.</b>	047635
<b>description</b>	light bulb t.max. 300°C socket E14 15W 230V ø 22mm L 47mm lens L 20mm for oven lamp type Philips		
<b>For models:</b>	685003, 805xxx, 890502, 890510, 890529, 890553, 890561, 890588, 890596, 890618, 890626, Aromacarina, Aromacarina-Dampf, Aromacarina-EsA, Aromacarina-ETA, Aromacarina-ETA-EsA, Heissluftdaempfer-10x1-1, Heissluftdaempfer-20x1-1, Heissluftdaempfer-5x1-1, Heissluftdaempfer-5x2-3, Heissluftgeraet-10x1-1, Heissluftgeraet-5x1-1, Heissluftgeraet-5x2-3, Heissluftgeraet-672, Heissluftgeraet-673, Heissluftgeraet-67310		



1

<b>Part No.</b>	359612	<b>Ref. No.</b>	354252
<b>description</b>	light bulb t.max. 300°C socket E14 25W 230V ø 25mm L 56mm lens L 30mm for oven lamp type Philips		
<b>For models:</b>	367788, 382191, 385018, 385026, 385034, 385042, 385050, 385514, 389595, 389609, 390003, 397210, 397229, 397237, 397245, 397253, 397261, 397288, 397296, 397318, 397326, 397334, 397342, 397350, 397431, 397776, 397784, 397792, 397806, 397814, 397822, 397830, 397849, 397857, 397865, 397873, 398047, 398055, 398063, 398071, 398098, 398101, 398128, 398136, 398144, 398152, 398950, 398969, 398977, 399019...(Other models you can see in the webshop)		

## halogen lamps

## for socket G4 / G6.35 / G9



1

<b>Part No.</b>	359599	<b>Ref. No.</b>	570478
<b>description</b>	halogen lamp socket G4 12V 20W temp.-resist. 500°C		

## sockets

## G4 / G5,3 / G6,35



1

<b>Part No.</b>	359646	<b>Ref. No.</b>	577294
<b>description</b>	lamp socket socket G4/G5.3/G6.35 24V ø 17mm H 15mm connection cable 130mm mounting distance 26mm for halogen lamp holder length 31mm cable length 130mm		
<b>For models:</b>	671568, 671576, 671584, 671592, 671606, 671614, 671622, 671630, 671649, 671657, 671665, 671673, 671681, 671711, 671746, 671754, 671762, 671770, 671789, 671797, 671800, 671819, 671827, 671835, 671843, 671851, 671878, 671886, 671894, 671908, 671916, 671975, 671983, 671991, 680583, 680591, 758752, 758760, 758981, 759007, 759015, 759023, 759031, 759058, 759066, 759074, 759171, 759198		

## residual heat indicators



1

<b>Part No.</b>	359429	<b>Ref. No.</b>	395056
<b>description</b>	indicator light 230V connection male faston 6.3mm mounting ø 18mm		
<b>For models:</b>	140902, 354643, 354651, 354678, 354686, 354694, 354708, 502200, 502308, 502650, 502707, 503010, 503150, 505900, 505935, 515892, 515906, 517887, 541869, 627984, 628018, 628026, 637564, 638625, 649554, 649562, 650129, 650137, 650145, 650153, 650943, 650951, 657735, 659002, 663263, 663395, 667412, 670618, 670626, 684848, 686247, 686298, 686328, 686336, 686409, 687200, 687960, 688096, 688118, 688290...(Other models you can see in the webshop)		

## timers

## electric timers





1

<b>Part No.</b>	350001	<b>Ref. No.</b>	157988
<b>description</b>	timer 2CO at 250V 16A permanent position yes impulse electric shaft ø 6x4.6mm shaft L 22mm mounting distance 28mm connection rear 2-pole operation time 120min		
<b>For models:</b>	389595, 389609, 398950, 398969, 398977, 609188, 609196, 637599, 674524, 674532, 674605, 674648, 674656, 674664, 674680, 674885, Heissluftdaempfer-10x1-1, Heissluftdaempfer-20x1-1, Heissluftdaempfer-5x1-1, Heissluftdaempfer-5x2-3, Heissluftdaempfer-6x1-1, Heissluftdaempfer-Varioplus-20x1-1, Heissluftdaempfer-Varioplus-20x2-1, Heissluftgeraet-10x1-1, Heissluftgeraet-5x1-1, Heissluftgeraet-5x2-3		





 <p>1</p>			
<b>Part No.</b>	350059	<b>Ref. No.</b>	871400
<b>description</b>	timer MS65 operation time 120min time spreadmin 2CO/1NO at 250V 16A permanent position yes impulse electric shaft ø 6x4.6mm shaft L 20mm mounting distance 28mm mounting thread M4 connection lateral 3-pole		
<b>accessories for</b>	350059		
	<b>Part No.</b>	110366	<b>Ref. No.</b> —
	knob switch zero mark t.max. °C ø 44mm shaft ø 6x4.6mm shaft flat upper black		
	<b>Part No.</b>	110381	<b>Ref. No.</b> —
	dial plate graduation 120min permanent position yes rotation 0-300° ø 60mm timers knob ø 45mm with permanent position		

audible timers

 <p>1</p>			
<b>Part No.</b>	350014	<b>Ref. No.</b>	018511 720585 836117
<b>description</b>	audible timer operation time 15min ø 56mm shaft ø 6x4.6mm shaft L 24mm mounting distance 28mm		
<b>For models:</b>	354716, 354724, 502200, 502308, 600008, 600067, 601004, 601209, 601403, 602000, 602205, 602280, 603007, 603023, 603201, 649554, 649562, 650943, 650951, 686336, 688339, 688347, 688355, Fritteuse-365, Fritteuse-600, Fritteuse-601, Fritteuse-602, Fritteuse-603, Topline-Fritteuse		

alarm devices

buzzers

 <p>1</p>			
<b>Part No.</b>	350051	<b>Ref. No.</b>	091472
<b>description</b>	buzzer 230VAC connection male faston 6.3mm screw thread M4 buzzer 62dB		
<b>For models:</b>	367788, 382191, 385018, 385026, 385034, 385042, 385050, 385514, 389595, 389609, 397210, 397431, 398950, 398969, 398977, 505900, 505935, 606294, 606308, 609188, 609196, 637599, 663263, 663395, 670618, 670626, 674648, 674656, 674664, 674680, 674885, 680583, 680591, 686409, 687200, 688096, 688118, 688363, 690570, 690600, 703095, 703109, 703117, 703125, 709816, 709824, 709832, 709840, 733105, 733113...(Other models you can see in the webshop)		

loudspeakers

 <p>1</p>			
<b>Part No.</b>	350226	<b>Ref. No.</b>	749877
<b>description</b>	loudspeaker ø 64mm built-in depth 20mm 500hm 0.3W connection male faston 2.8mm		

contactors

ABB

power contactors

 <p>1</p>			
<b>Part No.</b>	381011	<b>Ref. No.</b>	EL0502757
<b>description</b>	power contactor resistive load 16A 230VAC (AC3/400V) 9A/4kW main contacts 2NO/2NC auxiliary contacts connection screw connection type B6-22-00		

 <p>1</p>			
<b>Part No.</b>	380104	<b>Ref. No.</b>	324001 523909
<b>description</b>	power contactor resistive load 25A 230VAC (AC3/400V) 9A/4kW main contacts 3NO auxiliary contacts 1NO connection screw connection type A9-30-10		
<b>For models:</b>	754730, 754749, 757292, 758752, 758760, 758981, 759007, 759015, 759023, 759031, 759058, 759066, 759074, 759171, 759198, 759678, 759686, 759694, 759708, 759716		



## GENERAL ELECTRIC (AEG)

## power contactors

	
1	
<b>Part No.</b>	380239
<b>Ref. No.</b>	307491
<b>description</b>	power contactor resistive load 20A 230VAC (AC3/400V) 8.4A/4kW main contacts 3NO auxiliary contacts 1NC connection screw connection type LS05 01A type AEG LS05 01A type GE MC1A 301A
<b>For models:</b>	271500, 337xxx, 340022, 340030, 340049, 340057, 340073, 340xxx, 353167, 354392, 354457, 361763, 378933, 440078, 440086, 440094, 440140, 440655, 450111, 610038, 610429, 620203, 620424, 668001, 669008, 805556, 810002, 813303, 890502, 890510, 890529, 890553, 890561, 890588, 890596, 890618, 890626, FOEM-Kippbratpfanne-Elektro, Geschirrspuelautomat-330, Geschirrspuelautomat-335, Geschirrspuelautomat-336, Geschirrspuelautomat-700, GsP-350, GsP-500, GsP-600, Heissluftdaempfer-10x1-1, Heissluftdaempfer-5x1-1, Heissluftdaempfer-5x2-3

## ISKRA (FANAL)

## power contactors

	
1	
<b>Part No.</b>	380214
<b>Ref. No.</b>	332682
<b>description</b>	power contactor resistive load 20A 230VAC (AC3/400V) 8.5A/5.5kW main contacts 3NO auxiliary contacts 1NO connection screw connection type Fanal DSL7 00 type ISKRA K07M 00

## auxiliary contacts

	
1	
<b>Part No.</b>	380225
<b>Ref. No.</b>	332690
<b>description</b>	auxiliary contact contacts 3NO/1NC AC15 6A for contactors K03C/K07C connection screw connection type Fanal SC4 31 type ISKRA ND4C 31

## TELEMECANIQUE (Schneider Electric)

## power contactors



	
1	
<b>Part No.</b>	381010
<b>Ref. No.</b>	381010
<b>description</b>	power contactor resistive load 20A 230VAC (AC3/400V) 6A/2.2kW main contacts 2x3NO auxiliary contacts 2x1NO connection screw connection type LC2K0610P7

## auxiliary contacts

	
1	
<b>Part No.</b>	380987
<b>Ref. No.</b>	751790
<b>description</b>	auxiliary contact contacts 3NO/1NC AC15 10A for contactors LC1K connection screw type LA1KN31

## solid state relays

## CELDUC

	
1	
<b>Part No.</b>	402049
<b>Ref. No.</b>	752401
<b>description</b>	solid state relay CELDUC 1 phase 60A 24-600V 3-32VDC L 58mm W 45mm screw type S0965460
<b>accessories for</b>	402049
	
<b>Part No.</b>	401564
<b>Ref. No.</b>	—
	heat-conducting foil L 62mm W 45mm for solid state relay



CRYDOM



1

<b>Part No.</b>	402052	<b>Ref. No.</b>	752665
<b>description</b>	solid state relay CRYDOM 1 phase 90A 600V 4-32VDC L 58.6mm W 45mm screw type H12WD4890PG		

relays

power relays

with flange mounting



1

<b>Part No.</b>	380131	<b>Ref. No.</b>	359289
<b>description</b>	power relays Italiana Relè 230VAC 16A 3CO connection male faston 6.3mm screw mounting manuf. no. B2-3-230AC		
<b>For models:</b>	Glaeserspuelautomat-325		

with bracket mounting



1

<b>Part No.</b>	380687	<b>Ref. No.</b>	849618
<b>description</b>	power relays FINDER 230VAC 30A 2NO connection F6.3 bracket mounting manuf. no. 66.82.8.230.0300		

time relays

time relays



1

<b>Part No.</b>	381009	<b>Ref. No.</b>	780421
<b>description</b>	time relay ABB CT-AHE time range 3-300s 220-240VAC 4A		



1

<b>Part No.</b>	380288	<b>Ref. No.</b>	332615
<b>description</b>	time relay ELEKTRON VZE 806 time range 60s 24-250 AC/DC 5A connection cable mounting measurements DIN railmm		
<b>For models:</b>	389595, 389609, 398950, 398969, 398977, 609188, 609196, 637599, 674648, 674656, 674664, 674885, 680583, 680591, Heissluftdaempfer-10x1-1, Heissluftdaempfer-5x2-3, Heissluftdaempfer-6x1-1		

transformers

encapsulated transformers

multiple connections



1

<b>Part No.</b>	400252	<b>Ref. No.</b>	570443
<b>description</b>	transformer		



1

<b>Part No.</b>	400251	<b>Ref. No.</b>	572217
<b>description</b>	transformer 44VA		



			
1			
<b>Part No.</b>	402051	<b>Ref. No.</b>	742775
<b>description</b>	transformer primary 230VAC secondary 16.5VAC 2x15VA connection male faston 50/60Hz		
<b>For models:</b>	754595, 754609, 754617, 754668, 754676, 754681, 754692, 754706, 754714, 754722, 754730, 754749, 754757, 754773, 754781, 757292, 757314, 757365, 757373, 757381, 757403, 757411, 757438, 757446, 757454, 757462, 757470, 758736, 758833, 759201, 759651, 759678, 759686, 759694, 759708, 759716		

<b>PMA</b>			
			
1			
<b>Part No.</b>	379054	<b>Ref. No.</b>	368849
<b>description</b>	transformer primary 230VAC secondary 12VAC 3VA secondary 0.25A H 40mm L 45mm W 50mm connection screw 50/60Hz type 153/M		
<b>For models:</b>	Pizza-Ofen-P501, Pizza-Ofen-P502		

## electronic controllers

### SHANGFANG

#### accessories

			
1			
<b>Part No.</b>	379054	<b>Ref. No.</b>	368849
<b>description</b>	transformer primary 230VAC secondary 12VAC 3VA secondary 0.25A H 40mm L 45mm W 50mm connection screw 50/60Hz type 153/M		
<b>For models:</b>	Pizza-Ofen-P501, Pizza-Ofen-P502		

### miscellaneous

#### universal controllers

			
1			
<b>Part No.</b>	400206	<b>Ref. No.</b>	332143 595047
<b>description</b>	electronic controller 230V Templ1 thermocouple K (NiCr-Ni) temperature controller		
<b>For models:</b>	389595, 389609, 398950, 398969, 398977, 609188, 609196, 637599, 674648, 674656, 674664, 674680, 674885, Heissluftdaempfer-10x1-1, Heissluftdaempfer-5x2-3, Heissluftdaempfer-6x1-1, Heissluftdaempfer-Varioplus-20x1-1, Heissluftdaempfer-Varioplus-20x2-1		

## probes

### producer-specific probes

#### probes

			
1			
<b>Part No.</b>	379117	<b>Ref. No.</b>	873241
<b>description</b>	core temperature probe Pt100 cable PVC probe -100 up to 450°C cable -10 up to 100°C connection male faston 6.3mm thread 1/4" probe ø4x82mm cable length 1.4m		

			
1			
<b>Part No.</b>	379087	<b>Ref. No.</b>	570621
<b>description</b>	temperature probe thermocouple K (NiCr-Ni) cable silicone probe -50 up to 1150°C cable -50 up to +180°C connection male faston 2.8mm thread probe ø1x30mm cable length 1.6m		

#### core probes

			
1			
<b>Part No.</b>	378358	<b>Ref. No.</b>	747017
<b>description</b>	core temperature probe		

			
1			
<b>Part No.</b>	379592 <sup>1</sup>	<b>Ref. No.</b>	752363
<b>description</b>	core temperature probe 3 point probe cable PTFE probe -40 up to +250°C cable -40 up to +250°C connection 5-wire probe ø4x100mm thread cable length 4.5m handle ø 12mm handle length 85mm		
<b>For models:</b>	754595, 754609, 754617, 754668, 754676, 754681, 754692, 754706, 754714, 754722, 754730, 754749, 754757, 754773, 754781, 757292, 757314, 757365, 757373, 757381, 757403, 757411, 757438, 757446, 757454, 757462, 757470, 758736, 758833, 759201, 759651, 759678, 759686, 759694, 759708, 759716		

<sup>1</sup>multipoint probe

			
1			
<b>Part No.</b>	379692	<b>Ref. No.</b>	783668
<b>description</b>	core temperature probe Pt100 cable PTFE probe -40 up to +250°C cable -40 up to +250°C connection 2-wire probe ø4x82mm thread 1/4" cable length 1.8m handle ø 12mm handle length 90mm		



1 

<b>Part No.</b>	379116	<b>Ref. No.</b>	32664
<b>description</b>	core temperature probe Pt100 cable PTFE probe -40 up to +250°C cable -40 up to +250°C connection 2-wire probe ø4x82mm thread 1/4" cable length 3m handle ø 12mm handle length 90mm		

## electronics

### rectifiers

1 

<b>Part No.</b>	400253	<b>Ref. No.</b>	570532
<b>description</b>	rectifier		

### PCBs

1 

<b>Part No.</b>	402619	<b>Ref. No.</b>	742465
<b>description</b>	keypad PCB combi-steamer 1121/2021 L 350mm W 121mm with display		

1 

<b>Part No.</b>	401000	<b>Ref. No.</b>	580740
<b>description</b>	keypad PCB suitable for ELOMA with display		

1 

<b>Part No.</b>	400013	<b>Ref. No.</b>	214582
<b>description</b>	PCB combi-steamer 6x1/1 5x2/3 level control		
<b>For models:</b>	674524, 674532, 674605, 805556, Heissluftdaempfer-10x1-1, Heissluftdaempfer-20x1-1, Heissluftdaempfer-5x1-1, Heissluftdaempfer-5x2-3		

1 

<b>Part No.</b>	400015	<b>Ref. No.</b>	332704
<b>description</b>	PCB combi-steamer MD 1011 without mounting angle pulse timer for steaming		

## solenoïd valves

### solenoïd valves (water)

ELBI

straight

1 

<b>Part No.</b>	373017	<b>Ref. No.</b>	883091	
<b>description</b>	solenoid valve single straight 230VAC inlet 3/4" outlet 11.5mm DN10 ELBI			
<b>spare parts for</b>	373017			
	<b>Part No.</b>	370467	<b>Ref. No.</b>	—
	solenoid valve filter suitable for ELBI			

### MÜLLER

medium temperature: 90°C  
duty cycle: 100%

1 



















<b>Part No.</b>	370004	<b>Ref. No.</b>	173266 297313	
<b>description</b>	solenoid valve double straight 230VAC inlet 3/4" outlet 14.5mm DN10 t.max. 90°C duty cycle 100% MÜLLER			
<b>For models:</b>	144819, 271500, 337xxx, 340022, 340030, 340049, 340057, 340073, 340xxx, 353167, 354392, 354457, 361763, 378933, 440078, 440086, 440094, 440140, 440655, 450111, 516678, 639087, 699063, Geschirrspuelautomat-330, Geschirrspuelautomat-335, Geschirrspuelautomat-336, Geschirrspuelautomat-700, GsP-350, GsP-500, GsP-600, Vario-Braeter-plus			
<b>spare parts for</b>	370004			
	<b>Part No.</b>	370129	<b>Ref. No.</b>	—
	solenoid valve body double straight inlet 3/4" outlet 14.5mm DN10 t.max. 90°C duty cycle 100% MÜLLER 230V			
	<b>Part No.</b>	371002	<b>Ref. No.</b>	—
	solenoid valve holder MÜLLER flange support			
	<b>Part No.</b>	371009	<b>Ref. No.</b>	—
	compression spring for solenoid coil			



Table continues overleaf





<b>spare parts for</b>	370004		
	Part No.	371011	Ref. No. —
	spare parts kit membrane with long star star high 8mm MÜLLER		
	Part No.	371017	Ref. No. —
	solenoid coil MÜLLER 230VAC connection male faston 6.3mm		
	Part No.	371122	Ref. No. 249688
	solenoid valve filter ø 19mm H 10mm suitable for MÜLLER		
	Part No.	501161	Ref. No. —
	tap head for solenoid valve holder for solenoid coils		
<b>accessories for</b>	370004		
	Part No.	371010	Ref. No. —
	solenoid coil 230VAC connection with cable cable length 2000mm		
	Part No.	371037	Ref. No. —
	solenoid coil 24VAC 50/60Hz connection male faston 6.3mm		
	Part No.	371038	Ref. No. —
	solenoid coil 230VAC connection appliance plug		

	1		
<b>Part No.</b>	370002	<b>Ref. No.</b>	334944
<b>description</b>	solenoid valve single straight 230VAC inlet 3/4" outlet 14.5mm DN10 t.max. 90°C duty cycle 100% MÜLLER		
<b>For models:</b>	144819, 340022, 340030, 340049, 340057, 340073, 353167, 354392, 354457, 361763, 378933, 440078, 440086, 440094, 440140, 440655, 450111		
<b>spare parts for</b>	370002		
	Part No.	370127	Ref. No. —
	solenoid valve body single straight inlet 3/4" outlet 14.5mm DN10 t.max. 90°C duty cycle 100% MÜLLER 230V		
	Part No.	371002	Ref. No. —
	solenoid valve holder MÜLLER flange support		
	Part No.	371009	Ref. No. —
	compression spring for solenoid coil		
	Part No.	371011	Ref. No. —
	spare parts kit membrane with long star star high 8mm MÜLLER		
	Part No.	371017	Ref. No. —
	solenoid coil MÜLLER 230VAC connection male faston 6.3mm		
	Part No.	371122	Ref. No. 249688
	solenoid valve filter ø 19mm H 10mm suitable for MÜLLER		
	Part No.	501161	Ref. No. —
	tap head for solenoid valve holder for solenoid coils		
<b>accessories for</b>	370002		
	Part No.	371010	Ref. No. —
	solenoid coil 230VAC connection with cable cable length 2000mm		

<b>accessories for</b>	370002		
	Part No.	371037	Ref. No. —
	solenoid coil 24VAC 50/60Hz connection male faston 6.3mm		
	Part No.	371038	Ref. No. —
	solenoid coil 230VAC connection appliance plug		

## spare parts and accessories

## filters



1

<b>Part No.</b>	371122	<b>Ref. No.</b>	249688
<b>description</b>	solenoid valve filter ø 19mm H 10mm suitable for MÜLLER		

## TP

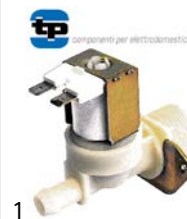

1

<b>Part No.</b>	370017	<b>Ref. No.</b>	987017
<b>description</b>	solenoid valve single straight 230VAC inlet 3/4" outlet 11.5mm DN10 TP p max 10bar		
<b>spare parts for</b>	370017		
	Part No.	371013	Ref. No. —
	solenoid coil TP 230VAC 50/60Hz		
<b>accessories for</b>	370017		
	Part No.	371220	Ref. No. —
	reducer TP flow rate 3l/min red tolerance ±15%		
	Part No.	371221	Ref. No. —
	reducer TP flow rate 5.5l/min yellow tolerance ±15%		
	Part No.	371222	Ref. No. —
	reducer TP flow rate 6l/min grey tolerance ±15%		
	Part No.	371223	Ref. No. —
	reducer TP flow rate 10l/min white tolerance ±15%		
	Part No.	371224	Ref. No. —
	reducer TP flow rate 12l/min bronze tolerance ±15%		
	Part No.	371225	Ref. No. —
	reducer TP flow rate 16l/min light brown tolerance ±15%		
	Part No.	371226	Ref. No. —
	reducer TP flow rate 20l/min red tolerance ±15%		
	Part No.	371230	Ref. No. —
	reducer TP flow rate 0.25l/min red tolerance ±25%		

Table continues overleaf





accessories for 370017		Part No.	371231	Ref. No.	—
	reducer TP flow rate 0.35l/min violet tolerance ±25%	Part No.	371232	Ref. No.	—
	reducer TP flow rate 0.5l/min orange tolerance ±25%	Part No.	371233	Ref. No.	—
	reducer TP flow rate 0.8l/min white tolerance ±25%	Part No.	371234	Ref. No.	—
	reducer TP flow rate 1l/min light blue tolerance ±25%	Part No.	371235	Ref. No.	—
	reducer TP flow rate 1.2l/min brown tolerance ±25%	Part No.	371236	Ref. No.	—
	reducer TP flow rate 1.5l/min light brown tolerance ±25%	Part No.	371237	Ref. No.	—
	reducer TP flow rate 2.5l/min yellow tolerance ±25%	Part No.	371238	Ref. No.	—
	reducer TP flow rate 3.4l/min dark green tolerance ±25%	Part No.	371239	Ref. No.	—
	reducer TP flow rate 5l/min black tolerance ±25%	Part No.	371240	Ref. No.	—
	reducer TP flow rate 8l/min blue tolerance ±20%				

metal

MÜLLER

2-way

	1				
<b>Part No.</b>	370069 <sup>1</sup>	<b>Ref. No.</b>	374806	586935	754471
<b>description</b>	solenoid valve 2-ways 230VAC inlet 1/8" IT outlet 1/8" IT L 30mm water MÜLLER DN10				
<b>For models:</b>	367788, 382191, 385018, 385026, 385034, 385042, 385050, 385514, 389595, 389609, 390003, 397210, 397229, 397237, 397245, 397253, 397261, 397288, 397296, 397318, 397326, 397334, 397342, 397350, 397431, 397776, 397784, 397792, 397806, 397814, 397822, 397830, 397849, 397857, 397865, 397873, 398047, 398055, 398063, 398071, 398098, 398101, 398128, 398136, 398144, 398152, 398950, 398969, 398977, 399019...(Other models you can see in the webshop)				

<sup>1</sup>with adjusting screw

	1				
<b>Part No.</b>	370037 <sup>1</sup>	<b>Ref. No.</b>	079561		
<b>description</b>	solenoid valve 2-ways 230VAC inlet 1/8" IT outlet M16x1 outer steam MÜLLER				
<b>For models:</b>	805149, 805300, 805408, 805459, 805xxx, 890502, 890510, 890529, 890553, 890561, 890588, 890596, 890618, 890626, Aromacarina, Aromacarina-Dampf, Aromacarina-EsA, Aromacarina-ETA, Aromacarina-ETA-EsA, Heissluftdaempfer-5x2-3				

<sup>1</sup>with adjusting screw

Solenoid valve - accessories

filters

	1				
<b>Part No.</b>	371122	<b>Ref. No.</b>	249688		
<b>description</b>	solenoid valve filter ø 19mm H 10mm suitable for MÜLLER				

	1				
<b>Part No.</b>	370863	<b>Ref. No.</b>	889555		
<b>description</b>	bracket thread 3/4" for solenoid valve L 100mm brass				

pressure switches

for coffee machines

ø 45mm

	1				
<b>Part No.</b>	541015	<b>Ref. No.</b>	030422	301523	
<b>description</b>	pressure control ø 45mm pressure range 400/360mbar pressure range 0.4/0.36bar p max 1.02bar pressure connection vertical coffee machine parts connection 1/4" ICO suitable for Palux, Bremer pressure connection 1/4"				
<b>For models:</b>	674524, 674532, 674605, 805149, 805300, 805408, 805459, 805556, 805xxx, 810002, 813303, 890502, 890510, 890529, 890553, 890561, 890588, 890596, 890618, 890626, Aromacarina, Aromacarina-Dampf, Aromacarina-EsA, Aromacarina-ETA, Aromacarina-ETA-EsA, Heissluftdaempfer-10x1-1, Heissluftdaempfer-20x1-1, Heissluftdaempfer-5x1-1, Heissluftdaempfer-5x2-3, standkaffeemaschine-solomatic-2, standkaffeemaschine-solomatic-4, Wandkaffeemaschine-800				



## for combi-steamers



1

<b>Part No.</b>	541526	<b>Ref. No.</b>	784028
<b>description</b>	pressure control p max 0.5bar pressure connection 1/8"		



## fans

## axial fans

## import



1

<b>Part No.</b>	601080 <sup>1</sup>	<b>Ref. No.</b>	693456
<b>description</b>	axial fan L 119mm W 119mm H 38mm 230VAC 50/60Hz 23/20W bearing ball bearing connection male faston 2.8mm metal ADDA fan wheel ø 110mm temp.-resist. 70°C		
<b>For models:</b>	671568, 671576, 671584, 671592, 671606, 671614, 671622, 671630, 758752, 758760, 758981, 759007, 759015, 759023, 759031, 759058, 759066, 759074, 759171, 759198		
<b>accessories for</b>	601080		
	<b>Part No.</b>	<b>Ref. No.</b>	—
	550898		
	connecting cable cable length 2000mm connection F 2.8 connection distance 7.9mm for axial flow fan		
	<b>Part No.</b>	<b>Ref. No.</b>	—
	692519		
	guard L 120mm W 120mm plastic		

<sup>1</sup>with ball bearings

## hot air motors



1

<b>Part No.</b>	510675	<b>Ref. No.</b>	373621
<b>description</b>	counterflange for fan motor ED ø 60mm int. ø 2 30mm thickness 5mm stainless steel		



1

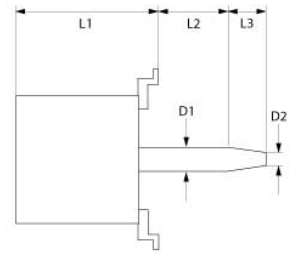



<b>Part No.</b>	500102	<b>Ref. No.</b>	332410
<b>description</b>	fan motor 230-240V 1 phase 50Hz 0.09kW 1390rpm speeds 1 L1 150mm L2 32mm L3 27mm ø 125mm M10R IT 1.1A suitable capacitor 4µF/400V power input 200W at 50Hz 1390rpm type L7yzw4B-207 no. X5 D1 ø 17mm D2 ø 14mm		
<b>For models:</b>	385018, 385026, 385034, 385042, 385050, 385514, 390003, 397229, 397237, 397245, 397253, 397261, 397288, 397296, 397318, 397326, 397334, 397342, 397350, 397776, 397784, 397792, 397806, 397814, 397822, 397830, 397849, 397857, 397865, 397873, 399019, 399027, 399035, 399043, 399051, 399078, 399086, 399094, 399108, 399116, 606294, 606316, 606324, 606332, 606340, 606359, 606367, 609544, 609552, 609560...(Other models you can see in the webshop)		

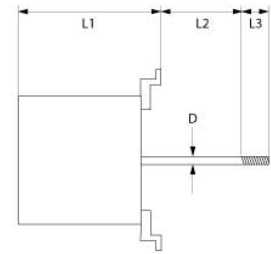

1



<b>Part No.</b>	601474	<b>Ref. No.</b>	693286
<b>description</b>	fan motor 230V 1 phase 50/60Hz 0.03kW 3600rpm speeds 1 L1 115mm L2 20mm L3 32mm ø 12mm shaft flat length 23mm 7.5/8 0.35/0.56A suitable capacitor 3µF400V power input 75/125W at 50Hz 3600rpm type L5ow2B-317 no. W9		
<b>For models:</b>	671568, 671576, 671584, 671592, 671606, 671614, 671622, 671630, 758752, 758760, 758981, 759007, 759015, 759023, 759031, 759058, 759066, 759074, 759171, 759198		
<b>spare parts for</b>	601474		
	<b>Part No.</b>	<b>Ref. No.</b>	—
	365191		
	operating capacitor capacity 3µF 400V tolerance 5% 60Hz ambient temperature max. -40 up to +85°C ø 30mm L 85mm M8 aluminium connection cable 400mm MLR25L40303063		
<b>accessories for</b>	601474		
	<b>Part No.</b>	<b>Ref. No.</b>	693375
	602166		
	fan wheel blades 9 D1 ø 175mm D2 ø 8mm D3 ø 8mm H1 30mm H2 28mm ED 6-23		

1



<b>Part No.</b>	601871	<b>Ref. No.</b>	302821
<b>description</b>	fan motor 230V 1 phase 50Hz 85kW 2400rpm speeds 1 L1 85mm L2 40mm L3 33mm L4 133.5mm fan wheel ø 180mm at 50Hz 230V at 60Hz 230V at 50Hz 2600rpm at 60Hz 2850rpm type R2E180-AU01-09		
<b>For models:</b>	389595, 389609, 398950, 398969, 398977, 609188, 609196, 637599, 674648, 674656, 674885, Heissluftdaempfer-5x2-3, Heissluftgeraet-5x2-3		

1



<b>Part No.</b>	514535	<b>Ref. No.</b>	743372
<b>description</b>	fan wheel blades 12 D1 ø 350mm D2 ø 13mm D3 ø 16.2mm H1 110mm H2 16mm seat ø 40mm		

2

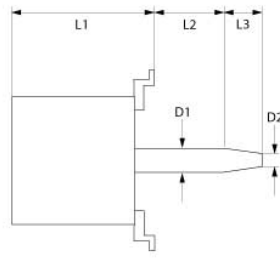
<b>Part No.</b>	500170	<b>Ref. No.</b>	580287
<b>description</b>	fan motor 3 phase		
<b>For models:</b>	671649, 671657, 671665, 671673, 671681, 671711, 671746, 671754, 671762, 671770, 671789, 671797, 671800, 671819, 671827, 671835, 671843, 671851, 671878, 671886, 671894, 671908, 671916, 671975, 671983, 671991, 680583, 680591		

1



<b>Part No.</b>	602166	<b>Ref. No.</b>	693375
<b>description</b>	fan wheel blades 9 D1 ø 175mm D2 ø 8mm D3 ø 8mm H1 30mm H2 28mm ED 6-23		
<b>accessories for</b>	602166		
	<b>Part No.</b>	601474	<b>Ref. No.</b>
			693286
<b>description</b>	fan motor 230V 1 phase 50/60Hz 0.03kW 3600rpm speeds 1 L1 115mm L2 20mm L3 32mm ø 12mm shaft flat length 23mm 7.5/8 0.35/0.56A suitable capacitor 3µF400V power input 75/125W at 50Hz 3600rpm type L5ow2B-317 no. W9		

1

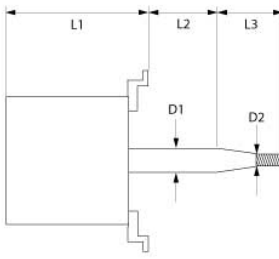
<b>Part No.</b>	601864	<b>Ref. No.</b>	742740
<b>description</b>	fan motor 380-415V 3 phase 50Hz 0.21kW 700/1400rpm speeds 2 L1 160mm L2 25mm L3 40mm D1 ø 17mm D2 ø 13mm M10R IT at 50Hz 700/1400rpm type 3081DH4052		

1



<b>Part No.</b>	510673	<b>Ref. No.</b>	580600
<b>description</b>	flange for fan motor ED ø 60mm int. ø 1 43mm int. ø 2 29mm thickness 6mm stainless steel		

1



<b>Part No.</b>	694997	<b>Ref. No.</b>	782939
<b>description</b>	speed sensor for hot air motors cable length 450mm		



radial fans

miscellaneous



1

<b>Part No.</b>	601475	<b>Ref. No.</b>	752525
<b>description</b>	radial fan 230V voltage AC 50/60Hz 20W H1 180mm L1 180mm D1 ø 86mm W1 40mm W2 34mm H2 122mm W3 40mm H3 172mm		
<b>For models:</b>	754668, 757314, 757462, 757470		

pumps

vibration pumps



1

<b>Part No.</b>	499010	<b>Ref. No.</b>	772550
<b>description</b>	vibration pump type E512/B46 230V 60W 50/60Hz inlet ø 7 outlet ø 1/8" IT CEME L 125mm		

condensators & interference suppression filters

operating capacitors

metal



1

<b>Part No.</b>	365002	<b>Ref. No.</b>	292753
<b>description</b>	operating capacitor capacity 4µF 400V tolerance 5% 50/60Hz ambient temperature max. -25 to +85°C ø 30mm L 75mm with cable M8 aluminium connection cable 300mm MKP protection IP65		

fuses

fine fuses



1

<b>Part No.</b>	358532	<b>Ref. No.</b>	190756
<b>description</b>	fine fuse size ø5x20mm 2A fast-acting rated 250V Qty 10 pcs		



1

<b>Part No.</b>	358608	<b>Ref. No.</b>	578975
<b>description</b>	fine fuse size ø5x20mm 10A slow-acting rated 250V Qty 10 pcs		

fine fuse holders



1

<b>Part No.</b>	358049	<b>Ref. No.</b>	751847
<b>description</b>	fuse holder		



1

<b>Part No.</b>	550105	<b>Ref. No.</b>	326941
<b>description</b>	rail-mounted terminal WIELAND type WK10/SIU 5X20 /V0 suitable fuse ø5x20mm 1.0-16mm <sup>2</sup> 10A rated 250V		

screw locks

D0-system (NEOZED)



1

<b>Part No.</b>	358043	<b>Ref. No.</b>	658294
<b>description</b>	fuse size D01 16A rated 250/400V E14 ø 11mm L 36mm Qty 10 pcs		





1

<b>Part No.</b>	358045	<b>Ref. No.</b>	751863
<b>description</b>	fuse size D02 35A rated 250/400V E18 ø 15mm L 36mm Qty 10 pcs		



 <p>1</p>			
<b>Part No.</b>	358046	<b>Ref. No.</b>	658286
<b>description</b>	fuse size D02 50A rated 250/400V E18 ø 15mm L 36mm Qty 10 pcs		

<p>gauge pieces (NEOZED)</p>			
 <p>1</p>			
<b>Part No.</b>	358067	<b>Ref. No.</b>	751855
<b>description</b>	gauge piece size D02 suitable for 35A		

 <p>1</p>			
<b>Part No.</b>	358068	<b>Ref. No.</b>	658278
<b>description</b>	gauge piece size D02 suitable for 50A		

## electric accessories

### terminals

#### connection terminals with screw/faston connections

 <p>1</p>			
<b>Part No.</b>	550762	<b>Ref. No.</b>	070858
<b>description</b>	connection terminal 2-pole max. 16A max 400V connection ø2.5mm <sup>2</sup> / F6.3 temp.-resist. 150°C		
<b>For models:</b>	140902, 144819, 361763, 378933, 440078, 440086, 440094, 440140, 440655, 450111, 502200, 502308, 502650, 502707, 503010, 503150, 505900, 505935, 515892, 515906, 516678, 517887, 541869, 626104, 626112, 626201, 626228, 626309, 626317, 637564, 638625, 639087, 649554, 649562, 650943, 650951, 657735, 663263, 663395, 667412, 670618, 670626, 684848, 686298, 686328, 686336, 686409, 687200, 688096, 688118...(Other models you can see in the webshop)		

### rail-mounted terminals

#### WIELAND



#### fuse terminal blocks

 <p>1</p>			
<b>Part No.</b>	550105	<b>Ref. No.</b>	326941
<b>description</b>	rail-mounted terminal WIELAND type WK10/SIU 5X20 /V0 suitable fuse ø5x20mm 1.0-16mm <sup>2</sup> 10A rated 250V		

<p>accessories</p>			
 <p>1</p>			
<b>Part No.</b>	550337	<b>Ref. No.</b>	327514
<b>description</b>	end barrier for fuse terminal clampsmm <sup>2</sup>		

## gas valves and ignition boxes

### gas control valves

<p>HONEYWELL</p>				
 <p>1</p>				
<b>Part No.</b>	106206	<b>Ref. No.</b>	744050	
<b>description</b>	gas valve type VK4115V 220-240V 50/60Hz gas inlet flange 32x32mm gas outlet flange 32x32mm thermocouple connection pilot connection pressure range 15-60mbar max 60mbar operator type HONEYWELL suitable for hole distance 24mm flange 32x32mm			
<b>accessories for</b>	106206			
	<b>Part No.</b>	102845	<b>Ref. No.</b>	—
	gas connection angled 1/2" flange 32x32mm hole distance 24x24mm Tandem			
	<b>Part No.</b>	102846	<b>Ref. No.</b>	—
	gas connection straight 1/2" flange 32x32mm hole distance 24x24mm suitable for Tandem			













SIT

ELETTROSIT



1

<b>Part No.</b>	101127	<b>Ref. No.</b>	321907
<b>description</b>	gas valve SIT type ELETTROSIT 230V gas inlet 3/4" gas outlet 3/4" thermocouple connection M9x1 pilot connection M10x1 lateral equiv. no. 0.810.175		
<b>spare parts for</b>	101127		
	<b>Part No.</b>	101312	<b>Ref. No.</b> —
microswitch			
	<b>Part No.</b>	101352	<b>Ref. No.</b> —
solenoid coil 230V 50Hz suitable for ELETTROSIT			
<b>accessories for</b>	101127		
	<b>Part No.</b>	100006	<b>Ref. No.</b> —
piezoelectric igniter suitable for ELETTROSIT body plastic blowing connection ø2.4mm ø 14mm			
	<b>Part No.</b>	100904	<b>Ref. No.</b> —
locking screw M10x1 for pipe ø 4mm Qty 1 pcs			
	<b>Part No.</b>	100905	<b>Ref. No.</b> —
locking screw M10x1 for pipe ø 6mm Qty 1 pcs			
	<b>Part No.</b>	101301	<b>Ref. No.</b> —
gas connection thread 1/2" straight ELETTROSIT screw with O-ring			
	<b>Part No.</b>	101303	<b>Ref. No.</b> —
gas connection straight thread 3/4" ELETTROSIT			
	<b>Part No.</b>	101309	<b>Ref. No.</b> —
extension			

ignition boxes

HONEYWELL



1

<b>Part No.</b>	101166	<b>Ref. No.</b>	371416
<b>description</b>	ignition box HONEYWELL type S4560B 1006 electrodes 1 waiting time 0s safety time 10s 220-240V 10VA 50Hz		

ignition parts

pilot burners

SIT

100 series



1















<b>Part No.</b>	106907	<b>Ref. No.</b>	321400 321699
<b>description</b>	pilot burner SIT type 100 series 3 flames nozzle ø 0.35mm gas connection 6mm		
<b>For models:</b>	710024, 710040, 710059, 710067, 910023, 910047, 910058, 910066, 910082, 910090, 910104, 910112, 910139, 910147, 910155, 910163, 910457, 910473, FOEM-Gas-Backofen		
<b>spare parts for</b>	106907		
	<b>Part No.</b>	100246	<b>Ref. No.</b> —
pilot burner nozzle natural gas bore ø 0.35mm Qty 1 pcs thread M8x0.75			
	<b>Part No.</b>	100855	<b>Ref. No.</b> —
pilot burner bracket triple			
	<b>Part No.</b>	100885	<b>Ref. No.</b> —
air mixing sleeve for pilot burner Qty 1 pcs			
	<b>Part No.</b>	100916	<b>Ref. No.</b> —
compression spring for pilot burner Qty 1 pcs			
	<b>Part No.</b>	100917	<b>Ref. No.</b> —
gasket for pilot burner Qty 1 pcs aluminium ID ø 8.5mm ED ø 11mm thickness 1.2mm			
	<b>Part No.</b>	100918	<b>Ref. No.</b> —
screw for pilot burner			
	<b>Part No.</b>	107162	<b>Ref. No.</b> —
pilot burner cap SIT 3 flames Hmm Lmm Qty 1 pcs			
	<b>Part No.</b>	107702	<b>Ref. No.</b> —
pilot burner bottom part SIT 100 series nozzle ø 0.35mm			

Table continues overleaf





accessories for		106907	
Part No.		100245	Ref. No.
	pilot burner nozzle	LPG code 20 bore $\varnothing$ 0.2mm Qty 1 pcs thread M8x0.75	—
	locking screw	M10x1 for pipe $\varnothing$ 4mm Qty 1 pcs	—
	locking screw	M10x1 for pipe $\varnothing$ 6mm Qty 1 pcs	—
	Part No.	102110	Ref. No.
	pilot tube	copper pipe $\varnothing$ 4mm thickness 1mm L 3000mm	—
	Part No.	102111	Ref. No.
	pilot tube	copper pipe $\varnothing$ 6mm thickness 1mm L 3000mm	—
	Part No.	107171	Ref. No.
	pilot burner nozzle	SIT natural/liquid gas bore $\varnothing$ 0.25mm Qty 1 pcs	—
	Part No.	107700	Ref. No.
	pilot burner bottom part	SIT 100 series nozzle $\varnothing$ 0.25mm	—
	Part No.	107701	Ref. No.
	pilot burner bottom part	SIT 100 series nozzle $\varnothing$ 0.2mm	—

**accessories**

**ignition electrodes**

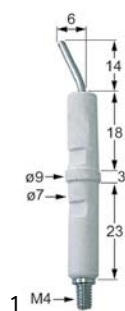

Part No.	100706	Ref. No.	321419
<b>description</b>	ignition electrode connection M4 Qty 1 pcs		
<b>For models:</b>	710059, 710067, 710083, 910023, 910047, 910058, 910066, 910082, 910090, 910104, 910112, 910139, 910147, 910155, 910163, 910457, 910473		

**electrodes**



Part No.	699472	Ref. No.	874833
<b>description</b>	gasket ignition electrode ID $\varnothing$ 13mm hole $\varnothing$ 6mm L 60mm W 22mm suitable for ELOMA graphite		

Part No.	100706	Ref. No.	321419
<b>description</b>	ignition electrode connection M4 Qty 1 pcs		
<b>For models:</b>	710059, 710067, 710083, 910023, 910047, 910058, 910066, 910082, 910090, 910104, 910112, 910139, 910147, 910155, 910163, 910457, 910473		

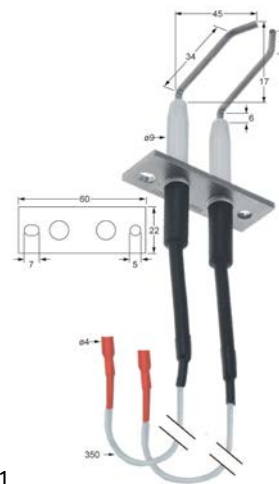

Part No.	106996	Ref. No.	874787
<b>description</b>	ignition electrode flange length 60mm flange width 22mm D1 $\varnothing$ 9mm L1 17mm L2 45mm L3 6mm L4 34/10mm BL1 37mm BL2 32mm cable length 350mm connection $\varnothing$ 4mm		
<b>accessories for</b>	106996		
	Part No.	699472	Ref. No.
			874833
<b>description</b>	gasket ignition electrode ID $\varnothing$ 13mm hole $\varnothing$ 6mm L 60mm W 22mm suitable for ELOMA graphite		



Part No.	106997	Ref. No.	874906
<b>description</b>	monitoring electrode connection $\varnothing$ F6.3mm flange length 23mm flange width 16mm D1 $\varnothing$ 7mm L1 60mm L2 44mm L3 60mm BL1 35mm BL2 25mm connection F6.3x0.8 cable length 450mm fixing dimensions $\varnothing$ 5mm		

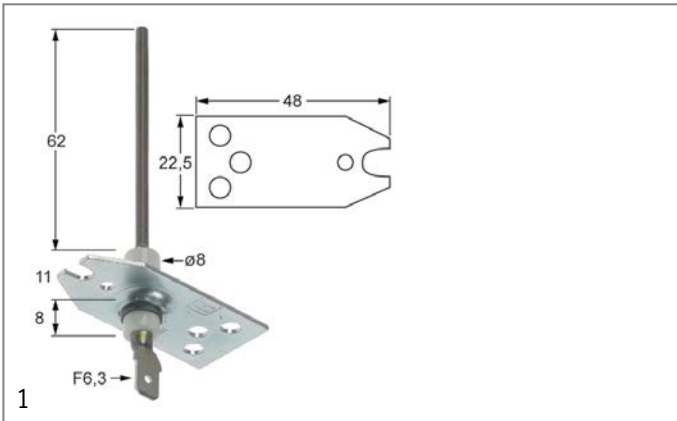

<b>Part No.</b>	109120	<b>Ref. No.</b>	373834
<b>description</b>	monitoring electrode flange length 48mm D1 ø 8mm flange width 22.5mm L1 62mm BL1 11mm BL2 8mm connection male faston 6.3mm		



<b>Part No.</b>	100906	<b>Ref. No.</b>	835803
<b>description</b>	screw connection thread M10x1 for ignition electrode brass Qty 1 pcs WS 10		

## thermocouples

### plug-in thermocouples

### plug-in thermocouples standard

### with barrel socket ø5mm - type Junkers with aluminised tip

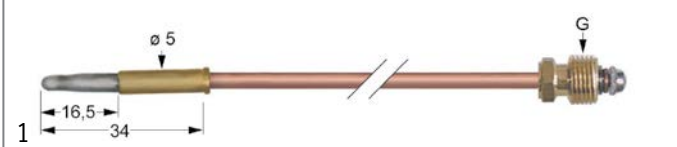

<b>Part No.</b>	102205	<b>Ref. No.</b>	697443
<b>description</b>	thermocouple M8x1 L 750mm plug connection ø5.0mm		
<b>For models:</b>	399701, 399728, 541419, 541427, 800163, 800171, 800198, 800201, 800228, 800236, 800244, 800252, 800260, 800279, 800287, 800295		

<b>accessories for</b>	102205			
	<b>Part No.</b>	101260	<b>Ref. No.</b>	—
	thermocouple fitting thread M8x1 Qty 1 pcs			

### with barrel socket ø6mm

### type Junkers with aluminised tip

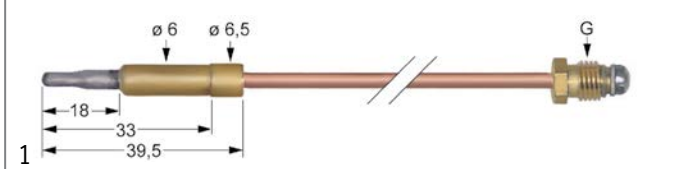

<b>Part No.</b>	102218	<b>Ref. No.</b>	384267
<b>description</b>	thermocouple M8x1 L 320mm plug connection ø6.0mm		
<b>For models:</b>	750123, 750131, 750158, 750166, 750174, 750182, 750190, 750379, 750387		



<b>Part No.</b>	102220	<b>Ref. No.</b>	384275
<b>description</b>	thermocouple M8x1 L 600mm plug connection ø6.0mm		
<b>For models:</b>	750123, 750131, 750158, 750166, 750174, 750182, 750190		

### with barrel socket ø6(6.5)mm

### thermocouples SIT

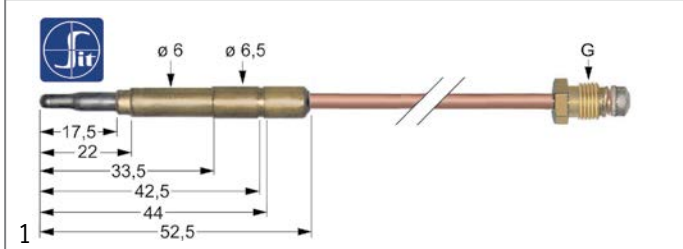

<b>Part No.</b>	107609	<b>Ref. No.</b>	321702
<b>description</b>	thermocouple SIT M9x1 L 600mm plug connection ø6.0(6.5)mm		
<b>For models:</b>	710059, 710067, 910104, 910112, 910139		

## threaded thermocouples

### threaded thermocouples standard

### with socket with thread M8x1

### SIT

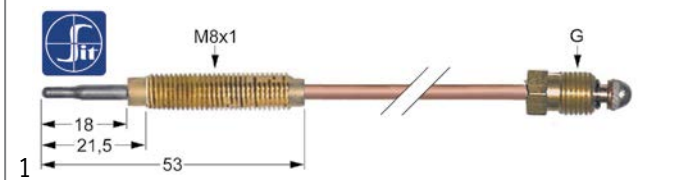

<b>Part No.</b>	107632	<b>Ref. No.</b>	001198
<b>description</b>	thermocouple SIT M8x1 L 1000mm M8x1		
<b>For models:</b>	Gasherd-64502		

<b>accessories for</b>	107632			
	<b>Part No.</b>	102067	<b>Ref. No.</b>	054240
	nut thread M8x1 H 3mm brass Qty 1 pcs type SEF 1			



accessories

nuts



1

<b>Part No.</b>	102067	<b>Ref. No.</b>	054240
-----------------	--------	-----------------	--------

**description** nut thread M8x1 H 3mm brass Qty 1 pcs type SEF 1

**For models:** 399701, 399728, 541419, 541427, 640018, 642053, 645005, 800163, 800171, 800198, 800201, 800228, 800236, 800244, 800252, 800260, 800279, 800287, 800295, Gas-Brater-641, Gas-Griddleplatte-642, Gasherd-645, Gasherd-64502, Gasherd-646, Gas-sudpfanne-643, Gas-Wurstgrill-640, Maxima-Gasherd-700-850, Maxima-Gasherd-neue-Ausfuhrung-700-850

gas nozzles

main nozzles

gas nozzles M13x1



1

<b>Part No.</b>	102471	<b>Ref. No.</b>	881715
-----------------	--------	-----------------	--------

**description** gas injector thread M13x1 bore ø 2.3mm WS 13

pilot burner nozzles

pilot burner nozzles POLIDORO



1

<b>Part No.</b>	102699	<b>Ref. No.</b>	835765
-----------------	--------	-----------------	--------

**description** pilot burner nozzle POLIDORO natural gas code 25.2 bore ø 2x0.25mm Qty 1 pcs 2 bores

screw connections

olives



1

<b>Part No.</b>	101273	<b>Ref. No.</b>	959715
-----------------	--------	-----------------	--------

**description** olive for pipe ø 12mm L 9.5mm brass Qty 1 pcs suitable for universal

**accessories for** 101273

<b>Part No.</b>	100944	<b>Ref. No.</b>	—
-----------------	--------	-----------------	---

**description** union nut thread M18x1.5 for pipe ø 12mm

<b>Part No.</b>	101276	<b>Ref. No.</b>	—
-----------------	--------	-----------------	---

**description** union screw thread 3/8" tube ø 12mm Qty 1 pcs

union screws



1

<b>Part No.</b>	100906	<b>Ref. No.</b>	835803
-----------------	--------	-----------------	--------

**description** screw connection thread M10x1 for ignition electrode brass Qty 1 pcs WS 10

consumables

thread sealants



1

<b>Part No.</b>	890058	<b>Ref. No.</b>	593567
-----------------	--------	-----------------	--------

**description** thread sealing LOCTITE 511 liquid bottle 50ml

**description** LOCTITE® 511™ - bottle 50ml  
It is designed for the locking and sealing of metal threaded pipes and fittings. The product cures rapidly when confined in the absence of air between close fitting metal surfaces.

equipmentspecific units

for convection ovens/combi-steamers

bushes



1

<b>Part No.</b>	692909	<b>Ref. No.</b>	782432
-----------------	--------	-----------------	--------

**description** bushing for door hinge H 7mm plastic D1 ø 18mm D2 ø 12mm ID ø 10mm

injection pipes



1

<b>Part No.</b>	692838	<b>Ref. No.</b>	753793
-----------------	--------	-----------------	--------

**description** injection pipe for combi-steamer straight ED ø 12mm ID ø 8mm L 180mm -



## cleaning system

## coupling bushings

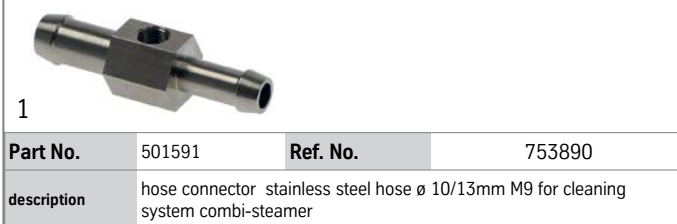

## cleaning arms

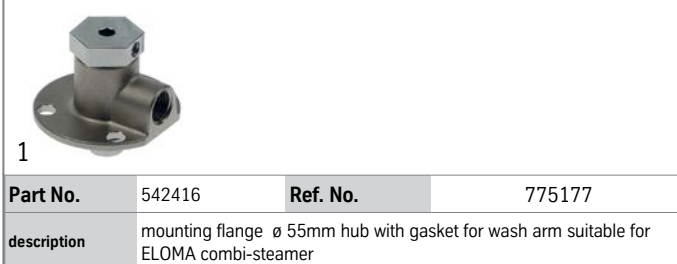

## drip water trays

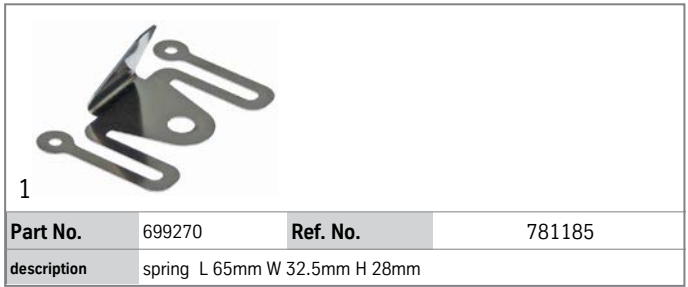
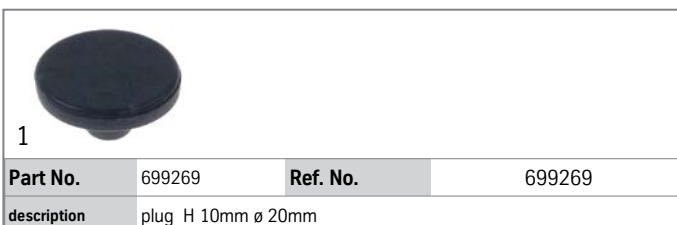

## door mechanics

## miscellaneous

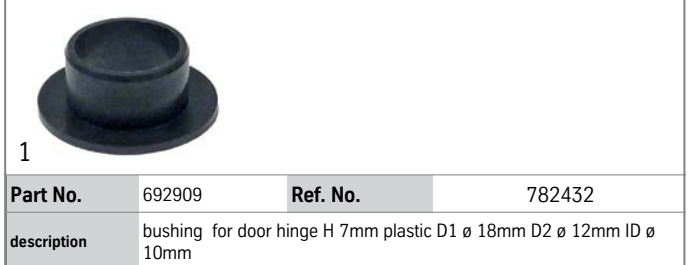

## door bumpers

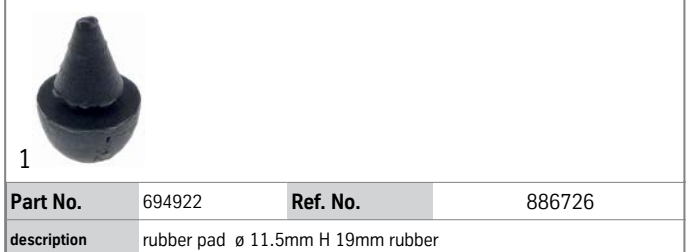

## locking mechanism

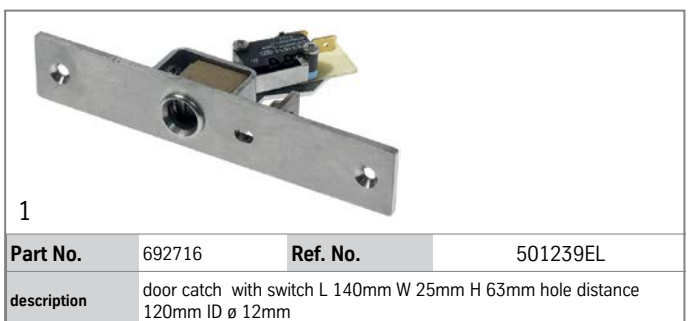
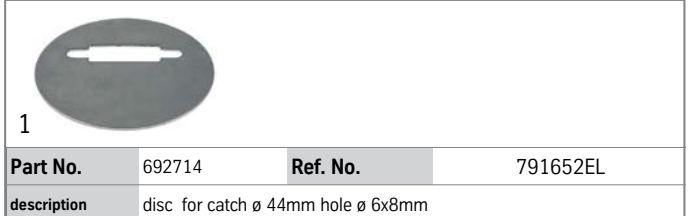



			
1			
<b>Part No.</b>	692715	<b>Ref. No.</b>	775061 888575
<b>description</b>	sleeve ø 50mm L 72mm W 59mm H 31mm hole distance 60mm ID ø 37mm		

accessories

			
1			
<b>Part No.</b>	699836	<b>Ref. No.</b>	569593
<b>description</b>	plug for door W 32mm plastic L 50mm		

vibration pumps

			
1			
<b>Part No.</b>	499010	<b>Ref. No.</b>	772550
<b>description</b>	vibration pump type E512/B46 230V 60W 50/60Hz inlet ø 7 outlet ø 1/8" IT CEME L 125mm		

miscellaneous

			
1			
<b>Part No.</b>	696857	<b>Ref. No.</b>	566594
<b>description</b>	boot L 42mm D1 ø 12mm D2 ø 36mm		

			
1			
<b>Part No.</b>	692306	<b>Ref. No.</b>	213519
<b>description</b>	pipe long D1 ø 10mm D2 ø 6mm L 134mm WS 19 thread 3/8"		
<b>For models:</b>	389595, 389609, 390003, 397229, 397237, 397245, 397253, 397261, 397288, 397296, 397318, 397326, 397334, 397342, 397350, 397776, 397784, 397792, 397806, 397814, 397822, 397830, 397849, 397857, 397865, 397873, 398047, 398055, 398063, 398071, 398098, 398101, 398128, 398136, 398144, 398152, 398950, 398969, 398977, 399019, 399027, 399035, 399043, 399051, 399078, 399086, 399094, 399108, 399116, 606316...(Other models you can see in the webshop)		

knobs

universal knobs

			
1			
<b>Part No.</b>	110235	<b>Ref. No.</b>	341894
<b>description</b>	knob energy regulator 1-3 t.max.°C ø 50mm shaft ø 6x4.6mm shaft flat upper black		
<b>For models:</b>	610038, 610429, 620203, 620424		

			
1			
<b>Part No.</b>	110244	<b>Ref. No.</b>	649058
<b>description</b>	knob thermostat t.max. 250°C ø 50mm shaft ø 6x4.6mm shaft flat upper/lower black temperature range 30-250°C rotation 270°		
<b>For models:</b>	626104, 626112, 626201, 626228, 626309, 626317		

			
1			
<b>Part No.</b>	110245	<b>Ref. No.</b>	087432 279862
<b>description</b>	knob thermostat t.max. 300°C ø 50mm shaft ø 6x4.6mm shaft flat upper black temperature range 50-300°C		
<b>For models:</b>	610003, 610038, 610402, 611018, 611050, 611220, 612006, 612057, 620009, 621005, 621056, 621110, 622001, 622052, 62510, 62520, 62530, 626104, 626112, 626201, 626228, 626309, 626317, 629006, 629022, Backofen-629, Brater-611, Brater-621, Griddle-Platte-612, Griddleplatte-622, Grill-680, Grill-681, Grill-682, Grill-683, Heissluftgeraet-672, Heissluftgeraet-673, Heissluftgeraet-67310, Wurst grill-610, Wurstgrill-620		

producer-specific knobs

PALUX

			
1			
<b>Part No.</b>	110235	<b>Ref. No.</b>	341894
<b>description</b>	knob energy regulator 1-3 t.max.°C ø 50mm shaft ø 6x4.6mm shaft flat upper black		
<b>For models:</b>	610038, 610429, 620203, 620424		





1

<b>Part No.</b>	110244	<b>Ref. No.</b>	649058
<b>description</b>	knob thermostat t.max. 250°C ø 50mm shaft ø 6x4.6mm shaft flat upper/lower black temperature range 30-250°C rotation 270°		
<b>For models:</b>	626104, 626112, 626201, 626228, 626309, 626317		



1

<b>Part No.</b>	110245	<b>Ref. No.</b>	087432 279862
<b>description</b>	knob thermostat t.max. 300°C ø 50mm shaft ø 6x4.6mm shaft flat upper black temperature range 50-300°C		
<b>For models:</b>	610003, 610038, 610402, 611018, 611050, 611220, 612006, 612057, 620009, 621005, 621056, 621110, 622001, 622052, 62510, 62520, 62530, 626104, 626112, 626201, 626228, 626309, 626317, 629006, 629022, Backofen-629, Brater-611, Brater-621, Griddle-Platte-612, Griddleplatte-622, Grill-680, Grill-681, Grill-682, Grill-683, Heissluftgeraet-672, Heissluftgeraet-673, Heissluftgeraet-67310, Wurst grill-610, Wurstgrill-620		

### accessories

#### covers



1

<b>Part No.</b>	111510	<b>Ref. No.</b>	748781 883136
<b>description</b>	lid t.max.°C°C ø 37mm shaft ømm shaft flat silver for knob ELOMA		
<b>For models:</b>	754595, 754609, 754617, 754668, 754676, 754681, 754692, 754706, 754714, 754722, 754730, 754749, 754757, 754773, 754781, 757292, 757314, 757365, 757373, 757381, 757403, 757411, 757438, 757446, 757454, 757462, 757470, 758736, 758833, 759201, 759651, 759678, 759686, 759694, 759708, 759716		

<b>accessories for</b>	111510	<b>Part No.</b>	111498	<b>Ref. No.</b>	743690
	knob t.max.°C°C ø 48mm shaft ø 6.5mm shaft flat blue				

## locks

### handle latches

#### producer-specific

#### PALUX



1

<b>Part No.</b>	694067	<b>Ref. No.</b>	747998
<b>description</b>	door catch with spigot 1-stage L 26mm total length 51mm thread M8		



1

<b>Part No.</b>	694254	<b>Ref. No.</b>	758272
<b>description</b>	door catch with spigot 2-stage L 36mm total length 60mm thread M8 thread L 25mm mounting pos. hinged at left		



1

<b>Part No.</b>	694253	<b>Ref. No.</b>	758264
<b>description</b>	door catch with spigot 2-stage L 36mm total length 60mm thread M8 thread L 25mm mounting pos. hinged at right		



1

<b>Part No.</b>	691990	<b>Ref. No.</b>	748765
<b>description</b>	door handle hinged at right L 155mm W 60mm H 58mm spring length 53mm blue mounting distance 40mm mounting thread M4		
<b>For models:</b>	754595, 754609, 754617, 754668, 754676, 754681, 754692, 754706, 754714, 754722, 754730, 754749, 754757, 754773, 754781, 757292, 757314, 757365, 757373, 757381, 757403, 757411, 757438, 757446, 757454, 757462, 757470, 758736, 758833, 759201, 759651, 759678, 759686, 759694, 759708, 759716		

<b>spare parts for</b>	691990	<b>Part No.</b>	514450	<b>Ref. No.</b>	—
------------------------	--------	-----------------	--------	-----------------	---



spring for door handle ø 6mm L 61mm W 27.5mm

<b>accessories for</b>	691990	<b>Part No.</b>	111510	<b>Ref. No.</b>	748781 883136
	lid t.max.°C°C ø 37mm shaft ømm shaft flat silver for knob ELOMA				

1

<b>Part No.</b>	691988	<b>Ref. No.</b>	749532
<b>description</b>	door handle L 155mm W 60mm H 58mm spring length 53mm blue mounting distance 40mm spring thickness 3mm		
<b>accessories for</b>	691988		
	<b>Part No.</b>	111510	<b>Ref. No.</b> 748781 883136
	lid t.max.°C ø 37mm shaft ømm shaft flat silver for knob ELOMA		

edgmount latches

handle latches

CAFF/FERMOD

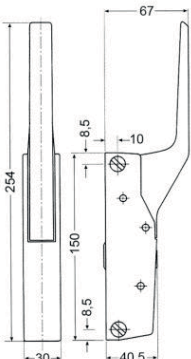

1

<b>Part No.</b>	701453	<b>Ref. No.</b>	215767 377732
<b>description</b>	handle latch L 150mm mounting distance 133mm metal heated units W 29.7mm type 790 / 791 total length 250mm handle length 100mm overall height 67mm		

RAHRBACH

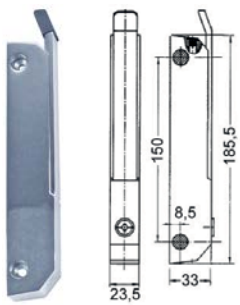

6188 ERGO series



1

<b>Part No.</b>	690808	<b>Ref. No.</b>	565458
<b>description</b>	handle latch L 185mm mounting distance 150mm chrome-plated non lockable for headed units 6188 type ERGO		
<b>accessories for</b>	690808		
	<b>Part No.</b>	690110	<b>Ref. No.</b> —
	base plate H 1mm L 38mm W 11mm mounting distance 26mm plastic		

**accessories for** 690808

	<b>Part No.</b>	690111	<b>Ref. No.</b>	—
	base plate H 2mm L 38mm W 11mm mounting distance 26mm plastic			
	<b>Part No.</b>	690114	<b>Ref. No.</b>	—
	base plate H 3.5mm L 185mm W 30mm mounting distance 150mm with inclination thread M5			
	<b>Part No.</b>	700082	<b>Ref. No.</b>	—
	door catch L 38mm W 18mm mounting distance 26mm			

door catches



1

<b>Part No.</b>	700061	<b>Ref. No.</b>	382833	
<b>description</b>	door catch L 58mm W 20mm H 35mm mounting distance 42mm chrome-plated brass for headed units			
<b>accessories for</b>	700061			
	<b>Part No.</b>	690414	<b>Ref. No.</b>	—
	handle latch L 150mm mounting distance 133mm non lockable refrigeration units G 791			

hinges

edgmount hinges

STUV

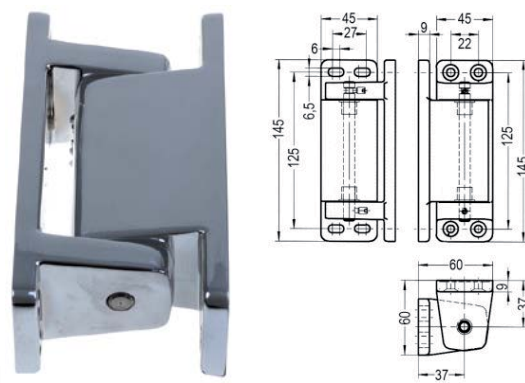

1

<b>Part No.</b>	700073	<b>Ref. No.</b>	000051	
<b>description</b>	edgmount hinge L 145mm W 45mm mounting distance 125mm hinging left/right without lift centre of rotation 37mm zinc die cast, chrome-plated refrigeration units			
<b>accessories for</b>	700073			
	<b>Part No.</b>	690310	<b>Ref. No.</b>	—
	base plate for 4000/4001 series thickness 5mm			

mechanical components, equipment accessories



## door bearing



1

<b>Part No.</b>	692688	<b>Ref. No.</b>	569178
<b>description</b>	hinge L 78mm W 40mm H 5mm mounting distance 21mm mounting pos. lower bolt 12mm bolt ø 6mm		

## accessories

## bushes



1

<b>Part No.</b>	692909	<b>Ref. No.</b>	782432
<b>description</b>	bushing for door hinge H 7mm plastic D1 ø 18mm D2 ø 12mm ID ø 10mm		

## miscellaneous



1

<b>Part No.</b>	694994	<b>Ref. No.</b>	875023
<b>description</b>	locking disc for hinge ID ø 12mm ED ø 30mm plastic		

## pullouts

## rollers

## rollers

## accessories



1

<b>Part No.</b>	560133	<b>Ref. No.</b>	251887
<b>description</b>	hexagonal nut thread M6 H 5mm WS 10 SS DIN/ISO DIN 934 / ISO 4032/8673 Qty 20 pcs		
<b>For models:</b>	140902, 144819, 271500, 337xxx, 340022, 340030, 340049, 340057, 340073, 340xxx, 353167, 354392, 354457, 354643, 354651, 354678, 354686, 354694, 354708, 361429, 361437, 361763, 367788, 378933, 382191, 385018, 385026, 385034, 385042, 385050, 385514, 389595, 389609, 390003, 397210, 397229, 397237, 397245, 397253, 397261, 397288, 397296, 397318, 397326, 397334, 397342, 397350, 397431, 397776, 397784...(Other models you can see in the webshop)		

## DERBY RUOTE

## spare parts and accessories

## miscellaneous



1

<b>Part No.</b>	560193	<b>Ref. No.</b>	349771
<b>description</b>	tooth lock washer ID ø 10.4mm ED ø 18mm zinc-coated steel DIN/ISO DIN 6798A Qty 1 pcs for thread M10		

## gaskets

## gaskets for heated units

## window seals

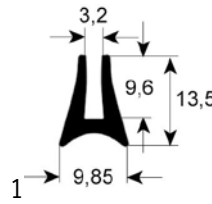

1

<b>Part No.</b>	900110	<b>Ref. No.</b>	215961
<b>description</b>	window gasket profile 1590 Qty supplied by meter		

## door seals

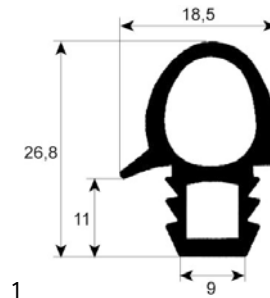

1

<b>Part No.</b>	900100	<b>Ref. No.</b>	384410
<b>description</b>	door seal profile 2070 W 460mm L 645mm external size Qty 1 6 x 1/1		

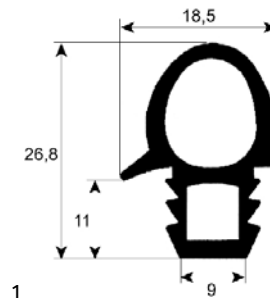

1

<b>Part No.</b>	900101	<b>Ref. No.</b>	382310
<b>description</b>	door seal profile 2070 W 645mm L 700mm external size Qty 1 10 x 1/1		
<b>For models:</b>	367788, 382191, 385018, 385026, 385034, 385042, 385050, 385514, 397210, 397229, 397237, 397245, 397253, 397261, 397288, 397296, 397318, 397326, 397334, 397342, 397350, 397431, 606294, 606308, 646768, 646776, 646784, 646792, 646806, 646814, 646822, 646830, 646849, 646857, 646865, 646873, 671789, 671797, 671800, 671819, 671827, 671835, 671843, 671851, 671878, 671886, 680583, 680591		

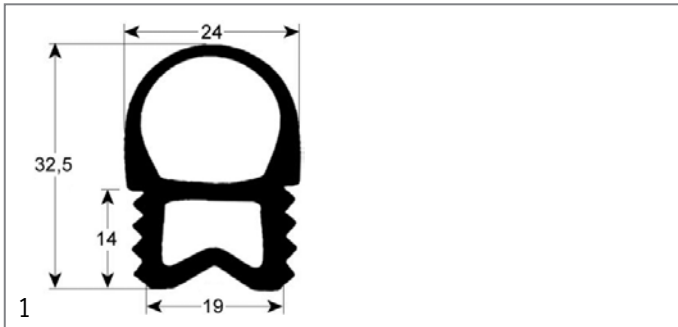

<b>Part No.</b>	900203	<b>Ref. No.</b>	425090
<b>description</b>	door seal profile 2448 W 730mm L 980mm external size Qty 1		



<b>Part No.</b>	901490	<b>Ref. No.</b>	742406
<b>description</b>	door seal profile 2449 W 690mm L 1550mm Qty 1		

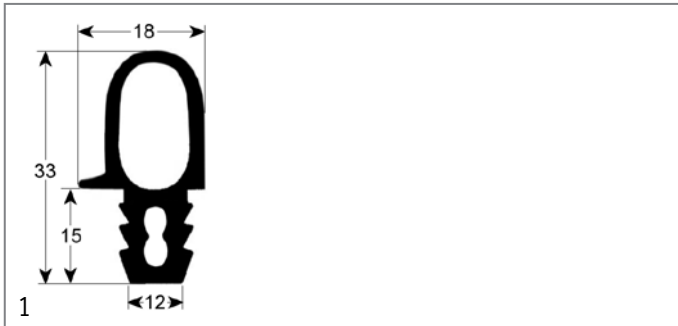

<b>Part No.</b>	900865	<b>Ref. No.</b>	742368
<b>description</b>	door seal profile 2449 W 490mm L 520mm Qty 1		
<b>For models:</b>	754595, 754609, 754676, 754681, 754692, 754706, 754749, 757365, 757373, 757381, 757403, 758736, 759201, 759678, 759686, 759694		

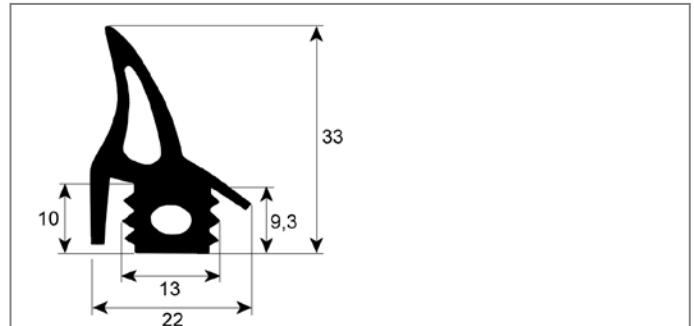

<b>Part No.</b>	901277	<b>Ref. No.</b>	E425207
<b>description</b>	door seal profile 2690 L 2275mm		

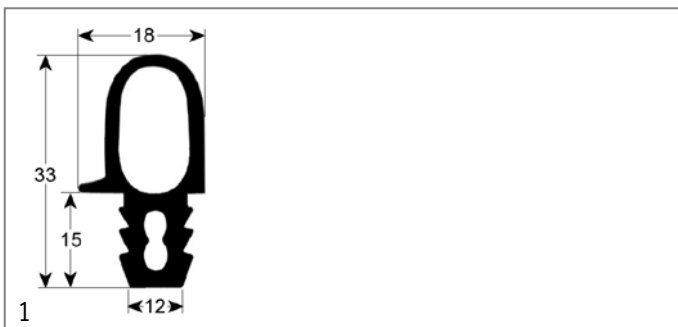

<b>Part No.</b>	901483	<b>Ref. No.</b>	742384
<b>description</b>	door seal profile 2449 W 520mm L 1505mm Qty 1		

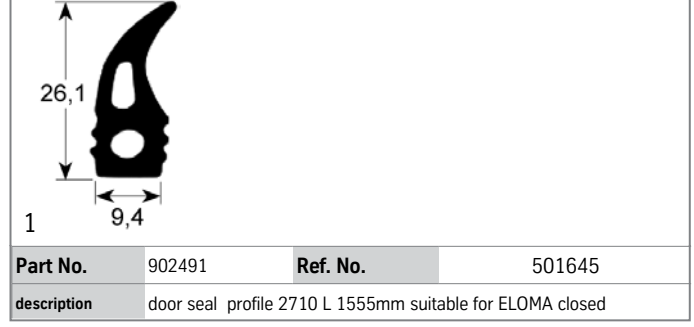

<b>Part No.</b>	902491	<b>Ref. No.</b>	501645
<b>description</b>	door seal profile 2710 L 1555mm suitable for ELOMA closed		



<b>Part No.</b>	900497	<b>Ref. No.</b>	742376
<b>description</b>	door seal profile 2449 W 520mm L 775mm Qty 1		
<b>For models:</b>	754617, 754714, 754722, 754730, 754757, 754773, 754781, 757292, 757411, 757438, 757446, 757454, 758833, 759651, 759708, 759716		

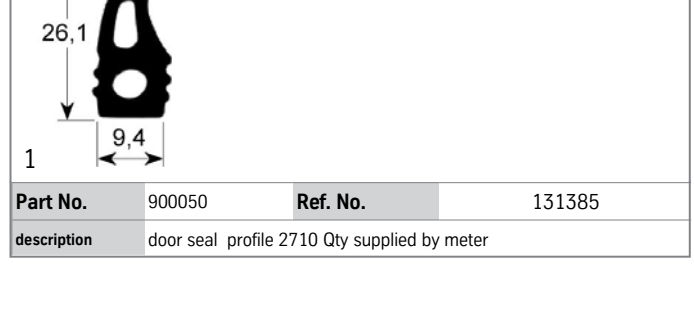

<b>Part No.</b>	900050	<b>Ref. No.</b>	131385
<b>description</b>	door seal profile 2710 Qty supplied by meter		

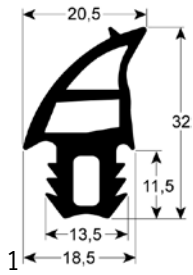

<b>Part No.</b>	902492	<b>Ref. No.</b>	742392
<b>description</b>	door seal profile 2736 W 695mm L 1000mm outer plug size Qty 1 suitable for ELOMA 12-21 silicone		

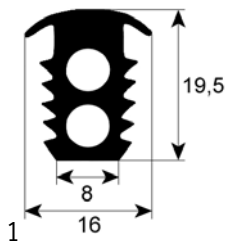

<b>Part No.</b>	901298	<b>Ref. No.</b>	693200
<b>description</b>	door seal profile 2775 Qty supplied by meter		

## gaskets for tray rack trolleys

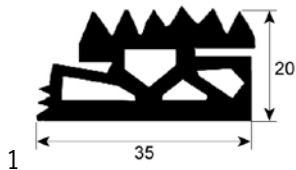

<b>Part No.</b>	900199	<b>Ref. No.</b>	549207
<b>description</b>	tray rack trolley gasket profile 4070 L 1000mm Qty 1		

## gaskets for control panels



<b>Part No.</b>	902493	<b>Ref. No.</b>	742309
<b>description</b>	gasket for control panel W 220mm L 890mm suitable for ELOMA for combi-steamer with 8 mounting clips		

## O-rings

## EPDM

ø1.78mm



<b>Part No.</b>	504574	<b>Ref. No.</b>	013471
<b>description</b>	O-ring EPDM thickness 1.78mm ID ø 9.25mm Qty 1 pcs		
<b>For models:</b>	140902, 367788, 382191, 385018, 385026, 385034, 385042, 385050, 385514, 389595, 389609, 390003, 397210, 397229, 397237, 397245, 397253, 397261, 397288, 397296, 397318, 397326, 397334, 397342, 397350, 397431, 397776, 397784, 397792, 397806, 397814, 397822, 397830, 397849, 397857, 397865, 397873, 398047, 398055, 398063, 398071, 398098, 398101, 398128, 398136, 398144, 398152, 398950, 398969, 398977...(Other models you can see in the webshop)		

ø5.34mm



<b>Part No.</b>	510408	<b>Ref. No.</b>	349232
<b>description</b>	O-ring EPDM thickness 5.34mm ID ø 47mm Qty 1 pcs		
<b>For models:</b>	665843, 665851, Glaeserspuelautomat-325, Glaeserspuelautomat-328		

ø7,00mm

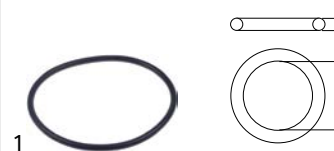

<b>Part No.</b>	532601	<b>Ref. No.</b>	335770
<b>description</b>	O-ring EPDM thickness 7mm ID ø 135.89mm Qty 1 pcs		
<b>For models:</b>	353167, 354392, 354457, 361763, 378933, 440078, 440086, 440094, 440140, 440655, 450111, GsP-350		

## silicone

ø1.50mm

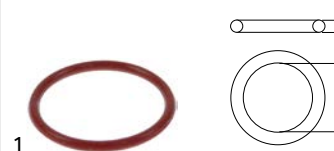

<b>Part No.</b>	532726	<b>Ref. No.</b>	577642
<b>description</b>	O-ring silicone thickness 1.5mm ID ø 17mm Qty 10 pcs		





**Viton**

ø2.62mm



1

<b>Part No.</b>	510579	<b>Ref. No.</b>	581410
<b>description</b>	O-ring Viton thickness 2.62mm ID ø 34.6mm Qty 1 pcs		

ø3.53mm



1

<b>Part No.</b>	529357	<b>Ref. No.</b>	753742
<b>description</b>	O-ring Viton thickness 3.53mm ID ø 23.4mm Qty 1 pcs		

**NBR**



1

<b>Part No.</b>	532735	<b>Ref. No.</b>	503932
<b>description</b>	O-ring NBR 70 thickness 1mm ID ø 6mm		

**sealing washers**

**copper gaskets**

**DIN-7603-A**



1

<b>Part No.</b>	528433	<b>Ref. No.</b>	097071 217840
<b>description</b>	flat gasket copper ED ø 14mm ID ø 10mm thickness 1mm		
<b>For models:</b>	390003, 397229, 397237, 397245, 397253, 397261, 397288, 397296, 397318, 397326, 397334, 397342, 397350, 397776, 397784, 397792, 397806, 397814, 397822, 397830, 397849, 397857, 397865, 397873, 398047, 398055, 398063, 398071, 398098, 398101, 398128, 398136, 398144, 398152, 399019, 399027, 399035, 399043, 399051, 399078, 399086, 399094, 399108, 399116, 606316, 606324, 606332, 606340, 606359, 606367...(Other models you can see in the webshop)		

**DIN-7603-C**



1

<b>Part No.</b>	510420	<b>Ref. No.</b>	002909
<b>description</b>	gasket copper ED ø 19.9mm ID ø 14.3mm thickness 2mm Qty 1 pcs		

**PTFE gaskets**



1

<b>Part No.</b>	518669	<b>Ref. No.</b>	373079	
<b>description</b>	gasket PTFE ED ø 21mm ID ø 15mm thickness 3.5mm			
<b>accessories for</b>	518669			
	<b>Part No.</b>	375889	<b>Ref. No.</b>	504602
	safety thermostat switch-off temp. 360°C 1-pole 16A probe ø 15mm probe L 6.5mm capillary pipe 1140mm capillary pipe isolated 1100mm gland nut probe			

**silicone gaskets**



1

<b>Part No.</b>	359721	<b>Ref. No.</b>	316296 693421
<b>description</b>	gasket silicone ED ø 48mm ID ø 39.5mm thickness 5mm Qty 1 pcs		
<b>For models:</b>	Heissluftdaempfer-10x1-1, Heissluftdaempfer-5x1-1, Heissluftdaempfer-5x2-3		

**special gaskets**

**for combi-steamers**



1

<b>Part No.</b>	699472	<b>Ref. No.</b>	874833
<b>description</b>	gasket ignition electrode ID ø 13mm hole ø 6mm L 60mm W 22mm suitable for ELOMA graphite		



1

<b>Part No.</b>	699471	<b>Ref. No.</b>	874876
<b>description</b>	gasket suitable for ELOMA for model Genius T 6-11 10-11 for burner chamber L 108mm W 100mm graphite combi-steamer		



1

<b>Part No.</b>	699470	<b>Ref. No.</b>	874841
<b>description</b>	gasket suitable for ELOMA for model Genius T 6-11 10-11 for radial fan L 65mm W 82mm for combi-steamer ID ø 25mm graphite thickness 1.7mm		

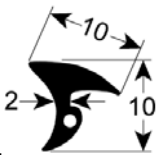

1

<b>Part No.</b>	560648	<b>Ref. No.</b>	584096
<b>description</b>	gasket suitable for ELOMA L 1000mm Qty 1m for combi-steamer		

### thermostat gaskets



1

<b>Part No.</b>	518669	<b>Ref. No.</b>	373079
<b>description</b>	gasket PTFE ED ø 21mm ID ø 15mm thickness 3.5mm		

<b>accessories for</b>	518669		
------------------------	--------	--	--

	<b>Part No.</b>	375889	<b>Ref. No.</b>	504602
	safety thermostat switch-off temp. 360°C 1-pole 16A probe ø 15mm probe L 6.5mm capillary pipe 1140mm capillary pipe isolated 1100mm gland nut probe			

### springs

#### torsion springs



1

<b>Part No.</b>	692523	<b>Ref. No.</b>	897531
<b>description</b>	torsion spring ø 27.8mm ID ø 21.7mm L2 44mm wire gauge ø 3mm L1 13mm L3 44mm Qty 1 pcs		



1

<b>Part No.</b>	692911	<b>Ref. No.</b>	791520
<b>description</b>	torsion spring ø 27mm wire gauge ø 2.3mm mounting pos. door handle L1 11mm Qty 1 pcs		

### hose reels and spray guns

#### spray guns





1

<b>Part No.</b>	548636	<b>Ref. No.</b>	393002
-----------------	--------	-----------------	--------

<b>description</b>	spray gun 1/2" ET L 250mm		
--------------------	---------------------------	--	--

<b>spare parts for</b>	548636		
------------------------	--------	--	--

	<b>Part No.</b>	540457	<b>Ref. No.</b>	—
	pressure pin ø 10mm D1 ø 18mm L 48.7mm with spring for spray gun edition from 03/2016			

	<b>Part No.</b>	549970	<b>Ref. No.</b>	—
	pressure pin ø 10mm D1 ø 18mm L 50.2mm with spring for spray gun			



1

<b>Part No.</b>	540301	<b>Ref. No.</b>	587583
-----------------	--------	-----------------	--------

<b>description</b>	spray gun for appliances 1/2" ET L 128mm		
--------------------	--	--	--

<b>For models:</b>	671568, 671576, 671584, 671592, 671606, 671614, 671622, 671630, 671649, 671657, 671665, 671673, 671681, 671711, 671746, 671754, 671762, 671770, 671789, 671797, 671800, 671819, 671827, 671835, 671843, 671851, 671878, 671886, 671894, 671908, 671916, 671975, 671983, 671991, 680583, 680591, 754595, 754609, 754617, 754668, 754676, 754681, 754692, 754706, 754714, 754722, 754730, 754749, 754757, 754773...(Other models you can see in the webshop)		
--------------------	--	--	--

<b>accessories for</b>	540301		
------------------------	--------	--	--

	<b>Part No.</b>	530922	<b>Ref. No.</b>	504696
	shower hose connections 1/2" L 800mm SS for combi-steamer			



1

<b>Part No.</b>	530922	<b>Ref. No.</b>	504696
-----------------	--------	-----------------	--------

<b>description</b>	shower hose connections 1/2" L 800mm SS for combi-steamer		
--------------------	---	--	--

<b>accessories for</b>	530922		
------------------------	--------	--	--

	<b>Part No.</b>	540301	<b>Ref. No.</b>	587583
	spray gun for appliances 1/2" ET L 128mm			



hose reels

appliance hose reels



1

<b>Part No.</b>	545067	<b>Ref. No.</b>	753181
<b>description</b>	hose reel without spray gun hose length 1.55m		



1

<b>Part No.</b>	540480	<b>Ref. No.</b>	580953
<b>description</b>	hose reel without spray gun hose length 1.7m		

hoses

supply hoses

PVC supply hoses

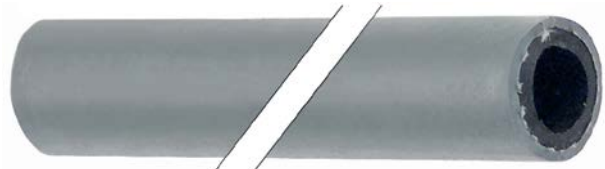

1

<b>Part No.</b>	520017	<b>Ref. No.</b>	040088
<b>description</b>	supply hose ID ø 13mm ED ø 20mm L 5m operating p. 20bar burst p. 60bar t.max. 95°C grey Qty 5m		
<b>For models:</b>	271500, 337xxx, 340022, 340030, 340049, 340057, 340073, 340xxx, 353167, 354392, 354457, 361763, 378933, 440078, 440086, 440094, 440655, 450111, Geschirrspuelautomat-330, Geschirrspuelautomat-335, Geschirrspuelautomat-336, Geschirrspuelautomat-700, GsP-350, GsP-500, GsP-600		

pre-rinse hoses

stainless steel spiral tubes



1

<b>Part No.</b>	530922	<b>Ref. No.</b>	504696
<b>description</b>	shower hose connections 1/2" L 800mm SS for combi-steamer		
<b>accessories for</b>	530922		
	<b>Part No.</b>	540301	<b>Ref. No.</b> 587583
	spray gun for appliances 1/2" ET L 128mm		

industrial hoses

nylon hoses



1

<b>Part No.</b>	520252	<b>Ref. No.</b>	785857
<b>description</b>	nylon hose ID ø 6mm ED ø 8mm L 5m thickness 1mm operating p. 10bar burst p. 50bar t.max. 100°C white		

silicone hoses

with fabric

with glass fibre sleeving



1

<b>Part No.</b>	520024	<b>Ref. No.</b>	253847 593303
<b>description</b>	silicone hose with glass fibre sleeving ID ø 9.5mm ED ø 17mm L 5m thickness 3.75mm operating p. 4bar burst pressure at 95°C 26bar burst pressure 130°C 14bar t.max. 200°C white		

fittings, hose and pipe connectors

hose connectors

miscellaneous



1

<b>Part No.</b>	501591	<b>Ref. No.</b>	753890
<b>description</b>	hose connector stainless steel hose ø 10/13mm M9 for cleaning system combi-steamer		

fittings

double nipples



1

<b>Part No.</b>	520160	<b>Ref. No.</b>	754447
<b>description</b>	double nipple nickel-plated brass thread 1/8" - 1/8" Qty 1 pcs		

1

<b>Part No.</b>	521187	<b>Ref. No.</b>	570451
<b>description</b>	double nipple nickel-plated brass thread 1/8" - 3/8" Qty 1 pcs int. ø 1.5mm int. ø 2 9.3mm		

### angle pieces



1

<b>Part No.</b>	520824	<b>Ref. No.</b>	773719
<b>description</b>	angle piece thread 1/8" ET - 1/8" IT nickel-plated brass		

## water cycle components

### pressure reduction valves

#### pressure reduction valves

#### producer-specific



1

<b>Part No.</b>	520502	<b>Ref. No.</b>	384437 577316 598198 874419
<b>description</b>	pressure reduction valve Norgren series R91 connection 1/8" default settingbar setting range 0.1-3bar p max 10bar t.max. 50°C brass		
<b>For models:</b>	367788, 382191, 385018, 385026, 385034, 385042, 385050, 385514, 389595, 389609, 390003, 397210, 397229, 397237, 397245, 397253, 397261, 397288, 397296, 397318, 397326, 397334, 397342, 397350, 397431, 397776, 397784, 397792, 397806, 397814, 397822, 397830, 397849, 397857, 397865, 397873, 398047, 398055, 398063, 398071, 398098, 398101, 398128, 398136, 398144, 398152, 398950, 398969, 398977, 399019...(Other models you can see in the webshop)		
<b>accessories for</b>	520502		
	<b>Part No.</b>	541979	<b>Ref. No.</b> —
	manometer ø 40mm pressure range 0-4bar connection at the rear in the centre thread 1/8"		
	<b>Part No.</b>	542449	<b>Ref. No.</b> —
	manometer ø 40mm pressure range 0-6bar connection at the rear in the centre thread 1/8"		

## ancillary products

### thread sealants



1

<b>Part No.</b>	890058	<b>Ref. No.</b>	593567
<b>description</b>	thread sealing LOCTITE 511 liquid bottle 50ml		
<b>description</b>	LOCTITE® 511™ - bottle 50ml It is designed for the locking and sealing of metal threaded pipes and fittings. The product cures rapidly when confined in the absence of air between close fitting metal surfaces.		

### clamps

#### security hose clamps

##### SS/brass



1

<b>Part No.</b>	520069	<b>Ref. No.</b>	276634
<b>description</b>	hose clamp SS/brass ø 14-19mm width 11mm Qty 5 pcs		



1

<b>Part No.</b>	520071	<b>Ref. No.</b>	276642 572160
<b>description</b>	hose clamp SS/brass ø 17-22mm width 11mm Qty 5 pcs		
<b>For models:</b>	340022, 340030, 340049, 340057, 340073, 353167, 354392, 354457, 361763, 378933, 398047, 398055, 398063, 398071, 398098, 398101, 398128, 398136, 398144, 398152, 440078, 440086, 440094, 440140, 440655, 450111, 609501, 609528, 609536, 671649, 671657, 671665, 671673, 671681, 671711, 671746, 671754, 671762, 671770, 671789, 671797, 671800, 671819, 671827, 671835, 671843, 671851, 671878, 671886, 671894...(Other models you can see in the webshop)		



1

<b>Part No.</b>	520067	<b>Ref. No.</b>	277665
<b>description</b>	hose clamp SS/brass ø 9-14mm width 10mm Qty 5 pcs		



## fastening material

### screws

#### flat-headed bolts



1

<b>Part No.</b>	560491	<b>Ref. No.</b>	162469
<b>description</b>	flat-headed bolt thread M3 thread L 16mm stainless steel DIN 7985 Qty 20 pcs intake Phillips head ø 6mm head thickness 2.5mm		

#### hexagonal screws



1

<b>Part No.</b>	560086	<b>Ref. No.</b>	251836
<b>description</b>	hexagonal screw thread M6 thread L 10mm SS WS 10 Qty 20 pcs DIN 933 / ISO 4017		

#### grub screws

##### DIN 913/ISO 4026



1

<b>Part No.</b>	560497	<b>Ref. No.</b>	753785
<b>description</b>	grub screw thread M8 L 8mm A2-A2L DIN 913/ISO 4026 WS 4 Qty 20 pcs		

##### DIN 916/ISO 4029



1

<b>Part No.</b>	560173	<b>Ref. No.</b>	588512 895415
<b>description</b>	grub screw thread M4 L 10mm SS DIN 916/ISO 4029 intake internal hexagon WS 2 Qty 20 pcs		
<b>For models:</b>	671568, 671576, 671584, 671592, 671606, 671614, 671622, 671630, 758752, 758760, 758981, 759007, 759015, 759023, 759031, 759058, 759066, 759074, 759171, 759198		

#### miscellaneous



1

<b>Part No.</b>	560621	<b>Ref. No.</b>	399280
<b>description</b>	grub screw thread 1/8" L 5mm brass WS hexagonal 5mm Qty 1 pcs		

### nuts

#### cap nuts



1

<b>Part No.</b>	560137	<b>Ref. No.</b>	057355
<b>description</b>	cap nuts thread M6 WS 10 SS Qty 20 pcs DIN/ISO DIN 1587		

#### hexagonal nuts

##### DIN 934 / ISO 4032/8673



1

<b>Part No.</b>	560340	<b>Ref. No.</b>	003905
<b>description</b>	hexagonal nut thread M4 H 3.2mm WS 7 SS DIN/ISO DIN 934 / ISO 4032/8673 Qty 1 pcs		



1

<b>Part No.</b>	560133	<b>Ref. No.</b>	251887
<b>description</b>	hexagonal nut thread M6 H 5mm WS 10 SS DIN/ISO DIN 934 / ISO 4032/8673 Qty 20 pcs		
<b>For models:</b>	140902, 144819, 271500, 337xxx, 340022, 340030, 340049, 340057, 340073, 340xxx, 353167, 354392, 354457, 354643, 354651, 354678, 354686, 354694, 354708, 361429, 361437, 361763, 367788, 378933, 382191, 385018, 385026, 385034, 385042, 385050, 385514, 389595, 389609, 390003, 397210, 397229, 397237, 397245, 397253, 397261, 397288, 397296, 397318, 397326, 397334, 397342, 397350, 397431, 397776, 397784...(Other models you can see in the webshop)		

#### DIN 985



1

<b>Part No.</b>	560143	<b>Ref. No.</b>	587095
<b>description</b>	hexagonal nut thread M8 H 8.5mm SS WS 13 Qty 20 pcs DIN/ISO DIN 985 self-locking		

#### hexagonal nuts metric (without norm)



1

<b>Part No.</b>	102067	<b>Ref. No.</b>	054240
<b>description</b>	nut thread M8x1 H 3mm brass Qty 1 pcs type SEF 1		
<b>For models:</b>	399701, 399728, 541419, 541427, 640018, 642053, 645005, 800163, 800171, 800198, 800201, 800228, 800236, 800244, 800252, 800260, 800279, 800287, 800295, Gas-Brater-641, Gas-Griddleplatte-642, Gasherd-645, Gasherd-64502, Gasherd-646, Gas-sudpfanne-643, Gas-Wurstgrill-640, Maxima-Gasherd-700-850, Maxima-Gas herd-neue-Ausfuhrung-700-850		





washers

washers

DIN 9021



1

<b>Part No.</b>	560117	<b>Ref. No.</b>	000582
<b>description</b>	plain washer ID ø 6.4mm ED ø 18mm thickness 1.5mm SS Qty 20 pcs DIN 9021 for thread M6		
<b>For models:</b>	271500, 337xxx, 340022, 340030, 340049, 340057, 340073, 340xxx, 353167, 354392, 354457, 361763, 367788, 378933, 382191, 385018, 385026, 385034, 385042, 385050, 385514, 390003, 397210, 397229, 397237, 397245, 397253, 397261, 397288, 397296, 397318, 397326, 397334, 397342, 397350, 397431, 397776, 397784, 397792, 397806, 397814, 397822, 397830, 397849, 397857, 397865, 397873, 398047, 398055, 398063...(Other models you can see in the webshop)		

tooth lock washers

DIN 6798A



1

<b>Part No.</b>	560193	<b>Ref. No.</b>	349771
<b>description</b>	tooth lock washer ID ø 10.4mm ED ø 18mm zinc-coated steel DIN/ISO DIN 6798A Qty 1 pcs for thread M10		



1

<b>Part No.</b>	560127	<b>Ref. No.</b>	006777 892912
<b>description</b>	tooth lock washer ID ø 6.2mm ED ø 11mm SS DIN/ISO DIN 6798A Qty 20 pcs for thread M6		
<b>For models:</b>	140902, 144819, 271500, 337xxx, 340022, 340030, 340049, 340057, 340073, 340xxx, 353167, 354392, 354457, 361763, 367788, 378933, 382191, 385018, 385026, 385034, 385042, 385050, 385514, 389595, 389609, 390003, 397210, 397229, 397237, 397245, 397253, 397261, 397288, 397296, 397318, 397326, 397334, 397342, 397350, 397431, 397776, 397784, 397792, 397806, 397814, 397822, 397830, 397849, 397857, 397865...(Other models you can see in the webshop)		

fasteners

slot nuts



1

<b>Part No.</b>	694995	<b>Ref. No.</b>	760978
<b>description</b>	slot nut W 4mm H 5mm L 12mm half-round for door latch DIN 6888		

clamps

security hose clamps

SS/brass



1

<b>Part No.</b>	520069	<b>Ref. No.</b>	276634
<b>description</b>	hose clamp SS/brass ø 14-19mm width 11mm Qty 5 pcs		



1

<b>Part No.</b>	520071	<b>Ref. No.</b>	276642 572160
<b>description</b>	hose clamp SS/brass ø 17-22mm width 11mm Qty 5 pcs		
<b>For models:</b>	340022, 340030, 340049, 340057, 340073, 353167, 354392, 354457, 361763, 378933, 398047, 398055, 398063, 398071, 398098, 398101, 398128, 398136, 398144, 398152, 440078, 440086, 440094, 440140, 440655, 450111, 609501, 609528, 609536, 671649, 671657, 671665, 671673, 671681, 671711, 671746, 671754, 671762, 671770, 671789, 671797, 671800, 671819, 671827, 671835, 671843, 671851, 671878, 671886, 671894...(Other models you can see in the webshop)		



1

<b>Part No.</b>	520067	<b>Ref. No.</b>	277665
<b>description</b>	hose clamp SS/brass ø 9-14mm width 10mm Qty 5 pcs		

consumables

sealants and adhesives

thread sealants



1

<b>Part No.</b>	890058	<b>Ref. No.</b>	593567
<b>description</b>	thread sealing LOCTITE 511 liquid bottle 50ml		
<b>description</b>	LOCTITE® 511™ - bottle 50ml It is designed for the locking and sealing of metal threaded pipes and fittings. The product cures rapidly when confined in the absence of air between close fitting metal surfaces.		



fuses

fine fuses



1

<b>Part No.</b>	358532	<b>Ref. No.</b>	190756
<b>description</b>	fine fuse size ø5x20mm 2A fast-acting rated 250V Qty 10 pcs		

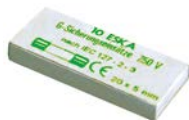

1

<b>Part No.</b>	358608	<b>Ref. No.</b>	578975
<b>description</b>	fine fuse size ø5x20mm 10A slow-acting rated 250V Qty 10 pcs		

fine fuse holders



1

<b>Part No.</b>	358049	<b>Ref. No.</b>	751847
<b>description</b>	fuse holder		

screw locks

D0-system (NEOZED)



1

<b>Part No.</b>	358043	<b>Ref. No.</b>	658294
<b>description</b>	fuse size D01 16A rated 250/400V E14 ø 11mm L 36mm Qty 10 pcs		



1

<b>Part No.</b>	358045	<b>Ref. No.</b>	751863
<b>description</b>	fuse size D02 35A rated 250/400V E18 ø 15mm L 36mm Qty 10 pcs		



1

<b>Part No.</b>	358046	<b>Ref. No.</b>	658286
<b>description</b>	fuse size D02 50A rated 250/400V E18 ø 15mm L 36mm Qty 10 pcs		

gauge pieces (NEOZED)



1

<b>Part No.</b>	358067	<b>Ref. No.</b>	751855
<b>description</b>	gauge piece size D02 suitable for 35A		



1

<b>Part No.</b>	358068	<b>Ref. No.</b>	658278
<b>description</b>	gauge piece size D02 suitable for 50A		

**GASTROPARTS.COM**



© 2020 Gastroparts Sp. J. All rights reserved.