



**GASTROPARTS**

# Modular Ovens

**[EN]** Cooking

**[DE]** Kochtechnik

**[ES]** Cocción

**[FR]** Cuisson

**[IT]** Cottura

**[PL]** Obróbka termiczna

**[RU]** Термическая обработка

✉ [gastroparts@gastroparts.com](mailto:gastroparts@gastroparts.com)

☎ tel. +48 56 657 00 66

📘 [fb.com/gastroparts.global](https://fb.com/gastroparts.global)

**GASTROPARTS.COM**







## heating elements

## heating elements for convection



1

<b>Part No.</b>	415966	<b>Ref. No.</b>	M563000800
<b>description</b>	heating element 2500W 230V heating circuits 1 ID $\varnothing$ 176mm ED $\varnothing$ 188mm L 210mm H 28mm L1 22mm W1 30mm H1 3mm H2 25mm flange length 70mm flange width 22mm hole distance 56mm connection male faston 6.3mm tube $\varnothing$ 6.3mm convection heating element hole $\varnothing$ 5mm rectangular flange		
<b>spare parts for</b>	415966		
	<b>Part No.</b>	510368	<b>Ref. No.</b> 553.008.00
	gasket L 70mm W 23.5mm hole $\varnothing$ 5mm hole distance 56mm FIBER thickness 2mm for heating element		
<b>accessories for</b>	415966		
	<b>Part No.</b>	510368	<b>Ref. No.</b> 553.008.00
	gasket L 70mm W 23.5mm hole $\varnothing$ 5mm hole distance 56mm FIBER thickness 2mm for heating element		



1

<b>Part No.</b>	418020	<b>Ref. No.</b>	999.22.042
<b>description</b>	heating element 7800W 230V heating circuits 3 ID $\varnothing$ 264mm ED $\varnothing$ 277mm L 315mm H 100mm L1 35mm W1 101mm H1 29mm H2 67mm flange length 142mm flange width 23mm hole distance 63mm connection M4 connection length 75mm tube $\varnothing$ 6.3mm convection heating element mounting thread M4 rectangular flange		

## accessories

## sealing washers

## fibre gaskets

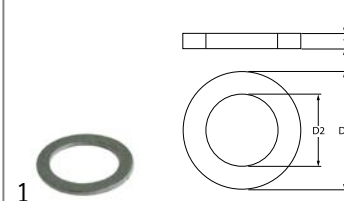

1

<b>Part No.</b>	510404	<b>Ref. No.</b>	953.031.00
<b>description</b>	flat gasket fibre ED $\varnothing$ 44mm ID $\varnothing$ 34mm thickness 2mm Qty 1 pcs		

## O-rings

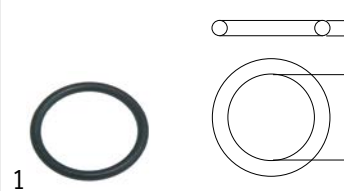

1

<b>Part No.</b>	510408	<b>Ref. No.</b>	0835534701
<b>description</b>	O-ring EPDM thickness 5.34mm ID $\varnothing$ 47mm Qty 1 pcs		

## flange gaskets



1

<b>Part No.</b>	510368	<b>Ref. No.</b>	553.008.00
<b>description</b>	gasket L 70mm W 23.5mm hole $\varnothing$ 5mm hole distance 56mm FIBER thickness 2mm for heating element		

## energy regulators

## EGO

## 1-circuit



1

<b>Part No.</b>	380015	<b>Ref. No.</b>	66105800
<b>description</b>	energy regulator 230V 13A single-circuit turn direction right shaft $\varnothing$ 6x4.6mm shaft L 23mm mounting thread M4 power release 6-100% no. 50.57021.010		
<b>For models:</b>	60/30CPE		



thermostats

control and safety thermostats

EGO

control thermostats

55.10/19\_ series



<b>Part No.</b>	375201	<b>Ref. No.</b>	RRC2190-00
<b>description</b>	thermostat t.max. 270°C temperature range 50-270°C 1-pole 1CO 16A probe ø 3mm probe L 219mm capillary pipe 3000mm capillary pipe isolated 2500mm gland nut M10x1 shaft L 23mm shaft position upper rotation 270° probe material SS		



<b>Part No.</b>	375216	<b>Ref. No.</b>	66107300
<b>description</b>	thermostat t.max. 280°C temperature range 50-280°C 1-pole 1NO 16A probe ø 3mm probe L 228mm capillary pipe 1300mm capillary pipe isolated 1150mm gland nut shaft L 23mm shaft position upper rotation 318°		
<b>For models:</b>	60/60CFE, 60/60CFGE		



<b>Part No.</b>	375945	<b>Ref. No.</b>	661.121.00
<b>description</b>	thermostat t.max. 470°C temperature range 90-470°C 1-pole 1NO 16A probe ø 3.9mm probe L 163mm capillary pipe 870mm capillary pipe isolated 600mm shaft ø 4.5x6mm shaft L 23mm shaft position upper rotation 270°		

55.34\_ series



<b>Part No.</b>	375143	<b>Ref. No.</b>	66100500
<b>description</b>	thermostat t.max. 110°C temperature range 32-110°C 3-pole 3NO 16A probe ø 6mm probe L 138mm capillary pipe 1480mm capillary pipe isolated 1100mm gland nut M9x1 shaft ø ø6x4.6mm shaft L 23mm shaft position upper rotation 270°		
<b>For models:</b>	65/70BME, 70/70BME		



<b>Part No.</b>	375192	<b>Ref. No.</b>	66102700 66111400
<b>description</b>	thermostat t.max. 300°C temperature range 50-300°C 3-pole 3NO 16A probe ø 3mm probe L 219mm capillary pipe 900mm capillary pipe isolatedmm gland nut shaft ø ø6x4.6mm shaft L 23mm shaft position upper rotation 270°		
<b>For models:</b>	65/110CFGE, 65/70CFE, 65/80BFE, 65/80TFE, 70/110CFGE, 70/70CFE, 70/70CFEQ, 70/70CFGE, 70/70CFVE		

safety thermostats

55.10/19\_ series



<b>Part No.</b>	375968	<b>Ref. No.</b>	56104600
<b>description</b>	safety thermostat switch-off temp. 360°C 1-pole 1NC 16A probe ø 6mm probe L 77mm capillary pipe 870mm capillary pipe isolated 660mm gland nut M10x1 probe probe material SS M8x1		

1 electric components



## 55.14\_series



<b>Part No.</b>	375610	<b>Ref. No.</b>	2198.00 RRC2198-00
<b>description</b>	safety thermostat switch-off temp. 340°C 1-pole 16A probe ø 3.03mm probe L 144mm capillary pipe 880mm capillary pipe isolated 750mm gland nut M9x1 probe		

## 55.32\_series



<b>Part No.</b>	375262	<b>Ref. No.</b>	66104500
<b>description</b>	safety thermostat switch-off temp. 350°C 3-pole 20A probe ø 4mm probe L 120mm capillary pipe 900mm capillary pipe isolated 900mm gland nut probe		
<b>For models:</b>	60/30FTE, 60/30FTE-CR, 60/30FTRE, 60/30FTRE-CR, 60/60FTE, 60/60FTE-CR, 60/60FTRE, 60/60FTRE-CR, 60/60FTRRE, 60/60FTRRE-CR, 65/110CFGE, 65/40FTE, 65/40FTRE, 65/70CFE, 65/70FTE, 65/70FTRE, 65/70FTRRE, 65/80BFE, 65/80TFE, 70/110CFGE, 70/40FTE, 70/40FTECR, 70/40FTES, 70/40FTRE, 70/40FTRE-CR, 70/70BRE, 70/70BREM, 70/70CFE, 70/70CFEQ, 70/70CFGE, 70/70CFVE, 70/70FTE, 70/70FTECR, 70/70FTES, 70/70FTRE, 70/70FTRE-CR, 70/70FTRRE, 70/70FTRRECR		



<b>Part No.</b>	375684	<b>Ref. No.</b>	561.022.00
<b>description</b>	safety thermostat switch-off temp. 360°C 1-pole 20A probe ø 11mm probe L 16mm capillary pipe 900mm capillary pipe isolated 900mm gland nut probe screw-in probe probe thread M14x1		

## accessories



<b>Part No.</b>	551083	<b>Ref. No.</b>	66103600
<b>description</b>	cap for safety thermostat thread M8x1		

## IMIT / TEMPOMATIC / ARATHERMO

## control thermostats



<b>Part No.</b>	390399	<b>Ref. No.</b>	461.003.00
<b>description</b>	thermostat t.max. 90°C temperature range°C 1-pole 1CO 16A probe ø 6.5mm probe L 110mm capillary pipe 1500mm capillary pipe isolated 1450mm shaft ø 6x4.6mm shaft L 19mm shaft position +135° rotation 270°		

## CAEM

## control thermostats



<b>Part No.</b>	375609	<b>Ref. No.</b>	RRC2185-00
<b>description</b>	thermostat t.max. 90°C temperature range 30-90°C 1-pole 1CO 16A probe ø 6mm probe L 95mm capillary pipe 1600mm capillary pipe isolated 1550mm shaft ø 6x4.6mm rotation 270°		

## CAMPINI

## safety thermostats



<b>Part No.</b>	375892	<b>Ref. No.</b>	561.036.00
<b>description</b>	safety thermostat switch-off temp. 318°C 1-pole 16A probe ø 3mm probe L 137mm capillary pipe 1260mm capillary pipe isolated 710mm gland nut probe SS type Ty 95-H		



accessories

connecting bows



<b>Part No.</b>	550060	<b>Ref. No.</b>	66101300
<b>description</b>	connecting bow long for thermostat Qty 1 pcs		
<b>For models:</b>	60/30BME, 60/30FRE, 60/30FTE, 60/30FTE-CR, 60/30FTRE, 60/30FTRECR, 60/60BME, 60/60FRE, 60/60FTE, 60/60FTRE, 60/60FTRE-CR, 60/60FTRRE, 60/60FTRRE-CR, 65/110CFGE, 65/40BME, 65/40FRE, 65/40FTE, 65/40FTRE, 65/70BME, 65/70CFE, 65/70FRE, 65/70FTE, 65/70FTRE, 65/70FTRRE, 65/80BFE, 65/80TFE, 70/110CFGE, 70/40BME, 70/40FRE10, 70/40FTE, 70/40FTE-CR, 70/40FTES, 70/40FTRE, 70/40FTRE-CR, 70/70BME, 70/70BRE, 70/70BREM, 70/70CFE, 70/70CFEQ, 70/70CFGE, 70/70CFVE, 70/70FRE10, 70/70FTE, 70/70FTECR, 70/70FTES, 70/70FTRE, 70/70FTRE-CR, 70/70FTRRE, 70/70FTRRECR		

switches and momentary switches

rocker/momentary rocker switches

19x13mm



<b>Part No.</b>	301066	<b>Ref. No.</b>	66107200
<b>description</b>	rocker switch mounting measurements 19x13mm black 2NO 250V 6A 0-I connection male faston 4.8mm ambient temperature max. 85°C protection IP40		
<b>For models:</b>	60/60CFE, 60/60CFGE		
<b>accessories for</b>	301066		
	<b>Part No.</b>	301064	<b>Ref. No.</b>
			—
	protective cover for pressure switch external size 23.4x17.4mm internal size 19x13mm H 7.5mm clear mounting measurementsmm		

30x11mm



<b>Part No.</b>	347350	<b>Ref. No.</b>	RRC2206-00
<b>description</b>	rocker switch mounting measurements 30x11mm black 1CO 250V 16A I O connection male faston 6.3mm ambient temperature max. 90°C protection IP40		

30x22mm

labelled



<b>Part No.</b>	301164	<b>Ref. No.</b>	763.001.00
<b>description</b>	rocker switch mounting measurements 30x22mm green 2NO 250V 16A illuminated connection male faston 6.3mm ambient temperature max. 85°C protection IP65 with cover cap		
<b>accessories for</b>	301164		
	<b>Part No.</b>	301036	<b>Ref. No.</b>
			—
	protective cover internal size 30x22mm for rocker switch mounting measurementsmm		

push/momentary push switches

30x22mm



<b>Part No.</b>	301086	<b>Ref. No.</b>	M561003500
<b>description</b>	push switch mounting measurements 30x22mm black 2NO 250V 12A 0-1 connection male faston 6.3mm ambient temperature max. 85/55°C protection IP54 with protective collar		

ø25mm



<b>Part No.</b>	345039	<b>Ref. No.</b>	961.049.00
<b>description</b>	protective cover round ED ø 33mm external size 23mm internal size 21mm H 12mm clear mounting ø 25mm		
<b>accessories for</b>	345039		
	<b>Part No.</b>	345001	<b>Ref. No.</b>
			—
	momentary push switch mounting ø 25mm yellow 1NO/indicator light 250V 16A cover connection male faston 6.3mm ambient temperature max. 85°C protection IP65		

microswitches

lever actuated



<b>Part No.</b>	345773	<b>Ref. No.</b>	76100400
<b>description</b>	microswitch with lever 250V 16A 1CO connection male faston 6.3mm L 60mm ambient temperature max. 125°C mounting distance 22mm actuating force: 65g lever length 51mm		



<b>Part No.</b>	345044	<b>Ref. No.</b>	66101500
<b>description</b>	microswitch with lever 250V 16A 1CO connection male faston 6.3mm ambient temperature max. 85°C mounting distance 25mm type C99ZP3 actuating force: 25g lever length 71mm		



## roller-lever actuated

## microswitches



1

<b>Part No.</b>	345250	<b>Ref. No.</b>	66105200
<b>description</b>	microswitch with handle with a switch 250V 16A 1CO connection male faston 6.3mm L 27mm L1 36mm ambient temperature max. 125°C mounting distance 22mm type RL6-1-FGE-P12-5-L actuating force: 90g		
<b>For models:</b>	70/70BRE, 70/70BREM, 70/70BRGM		

## pin-plunger actuated

## M10



1

<b>Part No.</b>	347216	<b>Ref. No.</b>	961.021.00
<b>description</b>	microswitch with plunger thread M10x0.75 thread L 14mm 250V 10A 1CO connection male faston 6.3mm stroke 7.5mm mounting distance 22mm L 28mm ambient temperature max. 125°C type NR6K5 actuating force: 260g		



1

<b>Part No.</b>	345032	<b>Ref. No.</b>	RRC6018-00
<b>description</b>	microswitch with plunger thread M10x1 thread L 12mm 250V 16A 1CO connection male faston 6.3mm stroke 7mm mounting distance 22mm L 28mm ambient temperature max. 125°C type SP9603 actuating force: 180g		

## cam switches

## 7-position



1

<b>Part No.</b>	300106	<b>Ref. No.</b>	96100000
<b>description</b>	cam switch 7 operating positions 1NO/2CO sequence 0-1-2-3-4-5-6 32A shaft ø 6x4.6mm shaft L 23mm connection screw 7-position shaft flat upper		

## 4 operating positions

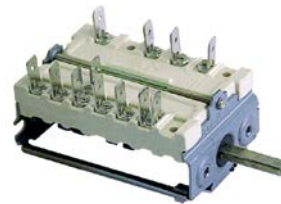

1

<b>Part No.</b>	300010	<b>Ref. No.</b>	661.117.00
<b>description</b>	cam switch 4 operating positions 2NO/2CO sequence 0-1-2-3 16A shaft ø 6x4.6mm shaft L 23mm connection male faston 6.3mm ceramic		

## operation switches



1

<b>Part No.</b>	300080	<b>Ref. No.</b>	66100000
<b>description</b>	cam switch 2 operating positions 4NO 16A sequence 0-1 shaft ø 6x4.6mm shaft L 23mm connection screw operation switch ceramic ambient temperature max. 150°C		
<b>For models:</b>	60/30FRE, 60/30FTE, 60/30FTE-CR, 60/30FTRE, 60/30FTRE-CR, 60/30SPE, 60/60BME, 60/60FRE, 60/60FTE, 60/60FTE-CR, 60/60FTRE, 60/60FTRE-CR, 60/60FTRRE, 60/60FTRRE-CR, 65/110CFGE, 65/40BME, 65/40FRE, 65/40FTE, 65/40FTRE, 65/40SPE, 65/70BME, 65/70CFE, 65/70FRE, 65/70FTE, 65/70FTRE, 65/70FTRRE, 65/80BFE, 65/80TFE, 70/110CFGE, 70/40BME, 70/40FRE10, 70/40FTE, 70/40FTE-CR, 70/40FTES, 70/40FTRE, 70/40FTRE-CR, 70/40SPE, 70/70BME, 70/70BRE, 70/70BREM, 70/70CFE, 70/70CFEQ, 70/70CFGE, 70/70CFVE, 70/70FRE10, 70/70FTE, 70/70FTE-CR, 70/70FTES, 70/70FTRE, 70/70FTRE-CR...(Other models you can see in the webshop)		
<b>accessories for</b>	300080		
	<b>Part No.</b>	551456	<b>Ref. No.</b> 953.020.00
	gasket for switch ED ø 14mm ID ø 2.5mm thickness 3.5mm white		

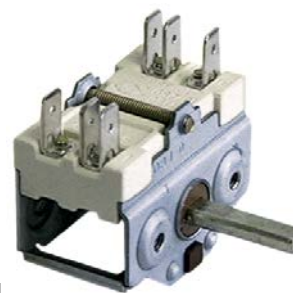

1

<b>Part No.</b>	300001	<b>Ref. No.</b>	661.093.00
<b>description</b>	cam switch operation switch 16A sequence 0-1 shaft ø 6x4.6mm connection male faston 6.3mm 2-pole		
<b>accessories for</b>	300001		
	<b>Part No.</b>	551456	<b>Ref. No.</b> 953.020.00
	gasket for switch ED ø 14mm ID ø 2.5mm thickness 3.5mm white		





rotary switches

TECNOMATIC



<b>Part No.</b>	347610	<b>Ref. No.</b>	RRC5500-00
<b>description</b>	rotary switch 4 0-1-2-3 sets of contacts 6 type HD16X143AR000 600V 16A shaft ø 6mm shaft L 22mm shaft round connection male faston 6.3mm		

encoders and potentiometers



<b>Part No.</b>	401169	<b>Ref. No.</b>	999.23.038
<b>description</b>	encoder cable length 125mm		



<b>Part No.</b>	300187	<b>Ref. No.</b>	99923037
<b>description</b>	potentiometer 4.7kOhm rotation 310° shaft ø 0.6x4.5mm shaft L 20mm cable length 650mm		

lamps

indicator lights

indicator lights 2-piece (lens and indicator lamp)

indicator light lenses

ø10mm (type SRZ-3)



<b>Part No.</b>	359123	<b>Ref. No.</b>	M568000200
<b>description</b>	indicator light housings mounting measurements ø10mm green round Qty 1 pcs		
<b>accessories for</b>	359123		
	<b>Part No.</b>	359132	<b>Ref. No.</b> M568000300
	indicator lamp green 250V connection male faston 6.3mm protection IP54 ambient temperature max. 85°C		

indicator lamps for socket type SRZ / SDK / SDY / SFK



<b>Part No.</b>	359132	<b>Ref. No.</b>	M568000300
<b>description</b>	indicator lamp green 250V connection male faston 6.3mm protection IP54 ambient temperature max. 85°C		

indicator lights (complete)

ø10mm

with plug-in socket



<b>Part No.</b>	359139	<b>Ref. No.</b>	463.014.00
<b>description</b>	indicator light ø 10mm green 230V connection male faston 6.3mm Qty 1 pcs		



<b>Part No.</b>	359140	<b>Ref. No.</b>	463.012.00
<b>description</b>	indicator light ø 10mm yellow 230V connection male faston 6.3mm Qty 1 pcs		

ø12mm

with screw socket



<b>Part No.</b>	359027	<b>Ref. No.</b>	963.012.00
<b>description</b>	indicator light ø 12mm 250V green connection male faston 6.3mm		



<b>Part No.</b>	359291	<b>Ref. No.</b>	66304300
<b>description</b>	indicator light ø 12mm 400V green connection male faston 6.3mm		
<b>For models:</b>	60/30BME, 60/30CPE, 60/30FRE, 60/30FTE, 60/30FTE-CR, 60/30FTRE, 60/30FTRE-CR, 60/30PCE, 60/30SPE, 60/60BME, 60/60CFG, 60/60CFGE, 60/60CPE, 60/60FRE, 60/60FTE, 60/60FTE-CR, 60/60FTRE, 60/60FTRE-CR, 60/60FTRRE, 60/60FTRRE-CR, 60/60PCE		





<b>Part No.</b>	359290	<b>Ref. No.</b>	66304400
<b>description</b>	indicator light ø 12mm 400V yellow connection male faston 6.3mm		
<b>For models:</b>	60/30CPE, 60/30FRE, 60/30FTE, 60/30FTE-CR, 60/30FTRE, 60/30FTRECR, 60/60BME, 60/60CFE, 60/60CFGE, 60/60CPE, 60/60FRE, 60/60FTE, 60/60FTE-CR, 60/60FTRE, 60/60FTRE-CR, 60/60FTRRE, 60/60FTRRE-CR		





			
1			
<b>Part No.</b>	360763	<b>Ref. No.</b>	96301400
<b>description</b>	indicator light ø 12mm red 230V connection male faston 6.3mm with O-ring		

ø13mm

with screw socket

			
1			
<b>Part No.</b>	359049	<b>Ref. No.</b>	66300000
<b>description</b>	indicator light ø 13mm 400V green		
<b>For models:</b>	65/110CFGE, 65/40BME, 65/40FRE, 65/40FTE, 65/40FTRE, 65/40PCE, 65/40PVE, 65/40SPE, 65/70BME, 65/70CFE, 65/70FRE, 65/70FTE, 65/70FTRE, 65/70FTRRE, 65/70PCE, 65/70PVE, 65/80BFE, 65/80TFE, 70/110CFGE, 70/40BME, 70/40CPE, 70/40FRE10, 70/40FTE, 70/40FTECR, 70/40FTES, 70/40FTRE, 70/40FTRE-CR, 70/40PCE, 70/40PCEQ, 70/40PVE, 70/40SPE, 70/70BME, 70/70BRE, 70/70BREM, 70/70CFE, 70/70CFEQ, 70/70CFGE, 70/70CFVE, 70/70CPE, 70/70FRE10, 70/70FTE, 70/70FTE-CR, 70/70FTES, 70/70FTRE, 70/70FTRE-CR, 70/70FTRRE, 70/70FTRRE-CR, 70/70PCE, 70/70PCEQ, 70/70PEI...(Other models you can see in the webshop)		
<b>accessories for</b>	359049		
	<b>Part No.</b>	510302	<b>Ref. No.</b> 0835.17124.1
	O-ring EPDM ID ø 12.42mm thickness 1.78mm Qty 1 pcs		
	<b>Part No.</b>	511505	<b>Ref. No.</b> —
	O-ring EPDM thickness 1.78mm ID ø 12.42mm Qty 10 pcs		

			
1			
<b>Part No.</b>	359050	<b>Ref. No.</b>	66300100
<b>description</b>	indicator light ø 13mm 400V yellow		
<b>For models:</b>	65/110CFGE, 65/40BME, 65/40FRE, 65/40FTE, 65/40FTRE, 65/70BME, 65/70CFE, 65/70FRE, 65/70FTE, 65/70FTRE, 65/70FTRRE, 65/80BFE, 65/80TFE, 70/110CFGE, 70/40BME, 70/40FRE10, 70/40FTE, 70/40FTECR, 70/40FTES, 70/40FTRE, 70/40FTRE-CR, 70/70BME, 70/70BRE, 70/70BREM, 70/70CFE, 70/70CFEQ, 70/70CFGE, 70/70CFVE, 70/70FRE10, 70/70FTE, 70/70FTE-CR, 70/70FTES, 70/70FTRE, 70/70FTRE-CR, 70/70FTRRE, 70/70FTRRE-CR		
<b>accessories for</b>	359050		
	<b>Part No.</b>	510302	<b>Ref. No.</b> 0835.17124.1
	O-ring EPDM ID ø 12.42mm thickness 1.78mm Qty 1 pcs		
	<b>Part No.</b>	511505	<b>Ref. No.</b> —
	O-ring EPDM thickness 1.78mm ID ø 12.42mm Qty 10 pcs		

## screw-on/push-on fit

## light bulbs

for ovens



			
1			
<b>Part No.</b>	359610	<b>Ref. No.</b>	66304500
<b>description</b>	light bulb t.max. 300°C socket E14 15W 230V ø 22mm L 47mm lens L 20mm for oven lamp type Philips		
<b>For models:</b>	60/60CFE, 60/60CFG, 60/60CFGE		

			
1			
<b>Part No.</b>	357153	<b>Ref. No.</b>	999.22.000 RRC2104-03
<b>description</b>	light bulb t.max. 300°C socket E14 25W 230V ø 25mm L 55mm lens L 30mm for oven type		

## oven lamps





## universal oven lamps





mounting diameter 35.5mm







			
1			
<b>Part No.</b>	359718	<b>Ref. No.</b>	66304700
<b>description</b>	oven lamp mounting ø 35.5mm 230V 15W socket E14 temp.-resist. 300°C connection male faston 6.3mm hard glas		
<b>For models:</b>	60/60CFE, 60/60CFG, 60/60CFGE		
<b>spare parts for</b>	359718		
	<b>Part No.</b>	359701	<b>Ref. No.</b> —
	lamp socket socket E14 220-230V mounting ø 35.5mm connection male faston 6.3mm 15W		
	<b>Part No.</b>	359740	<b>Ref. No.</b> —
	light bulb t.max. 300°C socket E14 15W 230V ø 22mm L 48mm lens L 20mm for oven lamp IMPORT		







55x100mm			
			
1			
<b>Part No.</b>	359698	<b>Ref. No.</b>	C2272-01 RRC2104-01
<b>description</b>	lamp socket L 100mm W 55mm socket E14 connection male faston 6.3mm		
<b>spare parts for</b>	359698		
	<b>Part No.</b>	358119	<b>Ref. No.</b> —
	frame L 118mm W 72mm mounting distance 143mm for bulb socket		
	<b>Part No.</b>	358122	<b>Ref. No.</b> —
	gasket L 112mm W 68mm silicone thickness 3mm for bulb socket		
	<b>Part No.</b>	358123	<b>Ref. No.</b> —
	lamp glass L 112mm W 68mm		
	<b>Part No.</b>	359612	<b>Ref. No.</b> —
	light bulb t.max. 300°C socket E14 25W 230V ø 25mm L 56mm lens L 30mm for oven lamp type Philips		
	<b>Part No.</b>	359714	<b>Ref. No.</b> —
	gasket silicone L 140mm W 75mm for bulb socket		
	<b>Part No.</b>	359715	<b>Ref. No.</b> —
	lamp glass L 110mm W 65mm thickness 5mm		
	<b>Part No.</b>	359716	<b>Ref. No.</b> —
	frame for bulb socket		
<b>accessories for</b>	359698		
	<b>Part No.</b>	359612	<b>Ref. No.</b> —
	light bulb t.max. 300°C socket E14 25W 230V ø 25mm L 56mm lens L 30mm for oven lamp type Philips		
	<b>Part No.</b>	359938	<b>Ref. No.</b> —
	borosilicate glass L 115mm W 69mm		

			
1			
<b>Part No.</b>	359698	<b>Ref. No.</b>	C2272-01 RRC2104-01
<b>description</b>	lamp socket L 100mm W 55mm socket E14 connection male faston 6.3mm		
<b>spare parts for</b>	359698		
	<b>Part No.</b>	358119	<b>Ref. No.</b> —
	frame L 118mm W 72mm mounting distance 143mm for bulb socket		
	<b>Part No.</b>	358122	<b>Ref. No.</b> —
	gasket L 112mm W 68mm silicone thickness 3mm for bulb socket		
	<b>Part No.</b>	358123	<b>Ref. No.</b> —
	lamp glass L 112mm W 68mm		

<b>spare parts for</b>	359698		
	<b>Part No.</b>	359612	<b>Ref. No.</b> —
	light bulb t.max. 300°C socket E14 25W 230V ø 25mm L 56mm lens L 30mm for oven lamp type Philips		
	<b>Part No.</b>	359714	<b>Ref. No.</b> —
	gasket silicone L 140mm W 75mm for bulb socket		
	<b>Part No.</b>	359715	<b>Ref. No.</b> —
	lamp glass L 110mm W 65mm thickness 5mm		
	<b>Part No.</b>	359716	<b>Ref. No.</b> —
	frame for bulb socket		
<b>accessories for</b>	359698		
	<b>Part No.</b>	359612	<b>Ref. No.</b> —
	light bulb t.max. 300°C socket E14 25W 230V ø 25mm L 56mm lens L 30mm for oven lamp type Philips		
	<b>Part No.</b>	359938	<b>Ref. No.</b> —
	borosilicate glass L 115mm W 69mm		

lamps			
light bulbs			
			
1			
<b>Part No.</b>	359610	<b>Ref. No.</b>	66304500
<b>description</b>	light bulb t.max. 300°C socket E14 15W 230V ø 22mm L 47mm lens L 20mm for oven lamp type Philips		
<b>For models:</b>	60/60CFE, 60/60CFG, 60/60CFGE		

			
1			
<b>Part No.</b>	357153	<b>Ref. No.</b>	999.22.000 RRC2104-03
<b>description</b>	light bulb t.max. 300°C socket E14 25W 230V ø 25mm L 55mm lens L 30mm for oven type		



## timers

## programme timers



1

<b>Part No.</b>	360528	<b>Ref. No.</b>	561.035.00
<b>description</b>	timer CDC 11902F3 engines 1 chambers 2 operation time 450s 230V motor type M48L ATS voltage AC		

## electric timers

## with time spread



1

<b>Part No.</b>	350074	<b>Ref. No.</b>	RRC5365-00
<b>description</b>	timer MS65 operation time 120min time spread 30min 1CO/2NO/1NC at 250V 16A permanent position yes impulse electric shaft $\varnothing$ 6x4.6mm shaft L 22mm mounting distance 28mm connection lateral Invensys 4-pole shaft position lower°		

## mechanical timers



1

<b>Part No.</b>	350186	<b>Ref. No.</b>	561.041.00
<b>description</b>	timer M2 2-pole operation time 120min impulse mechanical 2CO at 250V 16A permanent position yes shaft $\varnothing$ 6x4.6mm shaft L 23mm mounting distance 28mm		
<b>accessories for</b>	350186		
	<b>Part No.</b>	112627	<b>Ref. No.</b> —
	knob time 120min $\varnothing$ 58mm shaft $\varnothing$ 6x4.6mm shaft flat lower		

## audible timers



1

<b>Part No.</b>	350036	<b>Ref. No.</b>	RRC2191-00
<b>description</b>	audible timer operation time 60min $\varnothing$ 55mm shaft $\varnothing$ 6x4.6mm shaft L 22mm mounting distance 28mm		

## alarm devices

## buzzer boards



1

<b>Part No.</b>	350076	<b>Ref. No.</b>	256.052.00
<b>description</b>	buzzer board 12V connection male faston 6.3mm		

## contactors

## ABB

## power contactors



1

<b>Part No.</b>	380092	<b>Ref. No.</b>	M560003900
<b>description</b>	power contactor resistive load 20A 230VAC (AC3/400V) 12A/5.5kW main contacts 4NO auxiliary contacts connection screw connection type B7-40-00		

## ISKRA (FANAL)

## power contactors



1

<b>Part No.</b>	380547	<b>Ref. No.</b>	461.021.00 461.051.00
<b>description</b>	power contactor resistive load 20A 230VAC (AC3/400V) 5A/2.2kW main contacts 3NO auxiliary contacts 1NC connection screw connection type Fanal DSL3 01 type ISKRA K03M 01		



LOVATO

power contactors



1			
<b>Part No.</b>	380087	<b>Ref. No.</b>	66106600
<b>description</b>	power contactor resistive load 16A 230VAC (AC3/400V) 5A/2.2kW main contacts 3NO auxiliary contacts 1NO connection screw connection type 11BG0610A230		
<b>For models:</b>	70/70BRE, 70/70BREM		



1			
<b>Part No.</b>	380704	<b>Ref. No.</b>	66101700
<b>description</b>	power contactor resistive load 20A 230VAC (AC3/400V) 9A/4kW main contacts 3NO auxiliary contacts 1NC connection screw connection type 11BG0901A230		

relays

power relays

with bracket mounting



1			
<b>Part No.</b>	380808	<b>Ref. No.</b>	461.063.00
<b>description</b>	power relays FINDER 230VAC 16A 3CO connection male faston 6.3mm bracket mounting manuf. no. 62.83.8.230.0000		

relay sockets



1			
<b>Part No.</b>	380638	<b>Ref. No.</b>	961.037.00
<b>description</b>	relay socket 8-pole dimensions 51x41x23mm 250V 10A FINDER manuf. no. 90.26		

probes

universal probes

temperature probes



1			
<b>Part No.</b>	379222 <sup>1</sup>	<b>Ref. No.</b>	6000083
<b>description</b>	temperature probe Pt100 cable Vetrotex probe -200 up to +600°C cable -50 up to +350°C probe ø4x110mm cable length 1.4m 3-wire		

<sup>1</sup>3-wire



1			
<b>Part No.</b>	379051	<b>Ref. No.</b>	561.044.00
<b>description</b>	temperature probe thermocouple J (Fe-CuNi) cable Vetrotex probe -50 up to +750°C cable -50 up to +350°C probe ø6x100mm cable length 3m without screw connection cable colours red/blue 2-wire		

<b>accessories for</b>	379051		
		<b>Part No.</b>	379877
		<b>Ref. No.</b>	—
<b>description</b>	electronic controller HONEYWELL type DC10N-400 mounting measurements 92x92mm 24/230V voltage AC TC (J) relay outputs 1 CO-10A(6) TC (J) universal built-in depth 55mm protection IP54 accuracy 1% built-in version defr. funct. no 0 up to +400°C display 3 digits		

producer-specific probes

core probes



1			
<b>Part No.</b>	379597	<b>Ref. No.</b>	RRC2209-22
<b>description</b>	core temperature probe Pt100 cable PTFE probe -40 up to +250°C cable -40 up to +250°C connection 2-wire probe ø4x100mm thread cable length 1.7m handle ø 10mm handle length 80mm		

electronics

PCBs



1			
<b>Part No.</b>	350076	<b>Ref. No.</b>	256.052.00
<b>description</b>	buzzer board 12V connection male faston 6.3mm		



## solenoid valves

## solenoid valves (water)

ELBI

straight



1

<b>Part No.</b>	373021	<b>Ref. No.</b>	462.002.00
-----------------	--------	-----------------	------------

**description** solenoid valve double straight 230VAC inlet 3/4" outlet 11.5mm output 1x 4.7l/min DN10 ELBI

**spare parts for** 373021



<b>Part No.</b>	370467	<b>Ref. No.</b>	—
-----------------	--------	-----------------	---

solenoid valve filter suitable for ELBI



<b>Part No.</b>	371263	<b>Ref. No.</b>	—
-----------------	--------	-----------------	---

reducer ELBI flow rate 4.7l/min pressure range 0 up to 10bar tolerance ±15/25% grey



1

<b>Part No.</b>	373017	<b>Ref. No.</b>	462.000.00 462.010.00
-----------------	--------	-----------------	--------------------------

**description** solenoid valve single straight 230VAC inlet 3/4" outlet 11.5mm DN10 ELBI

**spare parts for** 373017



<b>Part No.</b>	370467	<b>Ref. No.</b>	—
-----------------	--------	-----------------	---

solenoid valve filter suitable for ELBI



1

<b>Part No.</b>	373025	<b>Ref. No.</b>	462.004.00
-----------------	--------	-----------------	------------

**description** solenoid valve triple straight 230VAC inlet 3/4" outlet 11.5mm DN10 ELBI

**spare parts for** 373025



<b>Part No.</b>	370467	<b>Ref. No.</b>	—
-----------------	--------	-----------------	---

solenoid valve filter suitable for ELBI



1

<b>Part No.</b>	370357	<b>Ref. No.</b>	61115000
-----------------	--------	-----------------	----------

**description** solenoid valve double straight 230VAC inlet 3/4" outlet 11.5mm plastic flow regulating valve outlet A 0.25

**For models:** 65/70GRG

## spare parts and accessories

## reducers

## inlet side



1

<b>Part No.</b>	371065	<b>Ref. No.</b>	471.002.00
-----------------	--------	-----------------	------------

**description** reducer ELBI type EATON (INVENSYS) flow rate 12l/min pressure range 0 up to 10bar tolerance ±15% brown

## fans

## axial fans

## ebm-papst



1

<b>Part No.</b>	601030 <sup>1</sup>	<b>Ref. No.</b>	6033175
-----------------	---------------------	-----------------	---------

**description** axial fan L 119mm W 119mm H 38mm 230VAC 50Hz 18W bearing ball bearing manuf. no. 4656Z metal connection male faston 2.8mm ebm-papst fan wheel ø 110mm temp.-resist. 75°C

**accessories for** 601030



<b>Part No.</b>	550898	<b>Ref. No.</b>	—
-----------------	--------	-----------------	---

connecting cable cable length 2000mm connection F 2.8 connection distance 7.9mm for axial flow fan



<b>Part No.</b>	692497	<b>Ref. No.</b>	—
-----------------	--------	-----------------	---

guard ø 105mm mounting distance 150mm for axial fan ebm-papstmm

<sup>1</sup>with ball bearings



hot air motors



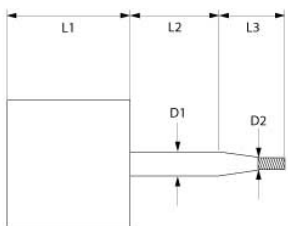

1

<b>Part No.</b>	602014	<b>Ref. No.</b>	56403914
<b>description</b>	fan motor 208-240V 1 phase 50/60Hz 0.19-0.26/0.34-0.35kW 2800/3450rpm speeds 2 L1 98mm L2 33mm D1 ø 8mm M5 1-1.2/1.7-1.5A type MFA80		

1

<b>Part No.</b>	500640	<b>Ref. No.</b>	6032122
<b>description</b>	fan motor 220-240V 1 phase 50Hz 0.05/0.25HP 1400/2700rpm speeds 2 L1 145mm L2 65mm L3 35mm D1 ø 15mm D2 ø 12mm M10L ET 1.1/0.55A suitable capacitor 12.5µF/450V at 50Hz 1400/2700rpm type 2758D2253 no. 6032122		
<b>spare parts for</b>	500640		
	<b>Part No.</b>	560280	<b>Ref. No.</b> —
	nut thread M10L H 8mm WS 17 SS DIN/ISO DIN 934 / ISO 4032/8673 Qty 1 pcs		



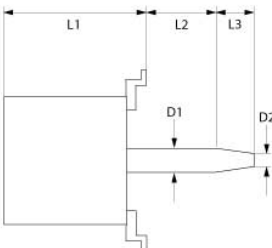

1

<b>Part No.</b>	500630	<b>Ref. No.</b>	C2901-00 RRC2901-00
<b>description</b>	fan motor 230/400V 3 phase 50Hz 0.37kW 2600rpm speeds 1 L1 175mm L2 50mm L3 28mm D1 ø 17mm D2 ø 12mm M8R IT 1.1/1.9A Cos(fi) 0.75 at 50Hz 2600rpm type 1020.5450		



1

<b>Part No.</b>	601178	<b>Ref. No.</b>	66400000 66403400
<b>description</b>	fan motor 230V 1 phase 50Hz 0.12kW 1400rpm speeds 1 L1 120mm L2 77mm D1 ø 12mm 1.1A suitable capacitor at 50Hz 230V type MA71TYP01DX		
<b>For models:</b>	65/110CFGE, 65/70CFE, 65/80BFE, 65/80TFE, 70/110CFGE, 70/70CFE, 70/70CFEQ, 70/70CFGE, 70/70CFVE		
<b>spare parts for</b>	601178		
	<b>Part No.</b>	365013	<b>Ref. No.</b> —
	operating capacitor capacity 8µF 400V tolerance 5%Hz ambient temperature max. -25 to +85°C ø 31.5mm L 55mm M8 plastic connection male faston 6.3mm protection		



1

<b>Part No.</b>	601993	<b>Ref. No.</b>	564.039.00
<b>description</b>	fan motor 230V 1 phase 50Hz 0.18/0.12kW 2800rpm speeds 1 L1 85mm L2 65mm L3 23mm D1 ø 8mm D2 ø 6mm M5x0.8 0.8A suitable capacitor 5µF/450V		
<b>accessories for</b>	601993		
	<b>Part No.</b>	365017	<b>Ref. No.</b> —
	operating capacitor capacity 5µF 450V tolerance 5% 50/60Hz ambient temperature max. -25 to +85°C ø 28mm L 54mm M8 plastic connection male faston 6.3mm 16.10.08 protection		



1

<b>Part No.</b>	601819	<b>Ref. No.</b>	644.000.00
<b>description</b>	fan wheel D1 ø 160mm H1 60mm blades 36 D2 ø 12mm D3 ø 12mm H2 23mm		





hot air fans

miscellaneous

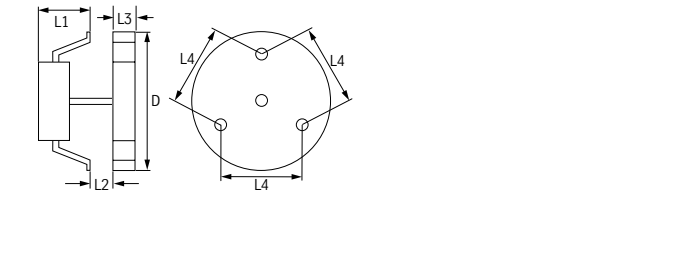
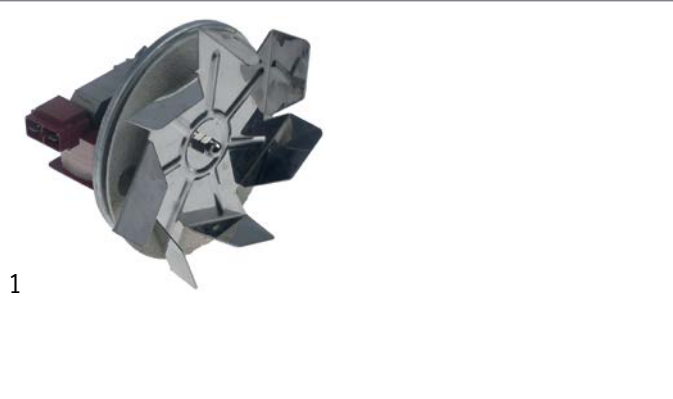

<b>Part No.</b>	601699	<b>Ref. No.</b>	66402500
<b>description</b>	hot air fan 220/240V 30W 50/60Hz L1 57mm L2 13mm L3 25mm L4 87mm fan wheel ø 150mm IMS type 7100VRD150H2023 fan wheel mounting 6x5mm		
<b>For models:</b>	60/60CFE, 60/60CFG		
<b>spare parts for</b>	601699		
	<b>Part No.</b>	601441	<b>Ref. No.</b> —
	fan wheel ø 150mm W 25mm shaft intake ø 6x5mm stainless steel blades 7		
<b>accessories for</b>	601699		
	<b>Part No.</b>	601441	<b>Ref. No.</b> —
	fan wheel ø 150mm W 25mm shaft intake ø 6x5mm stainless steel blades 7		

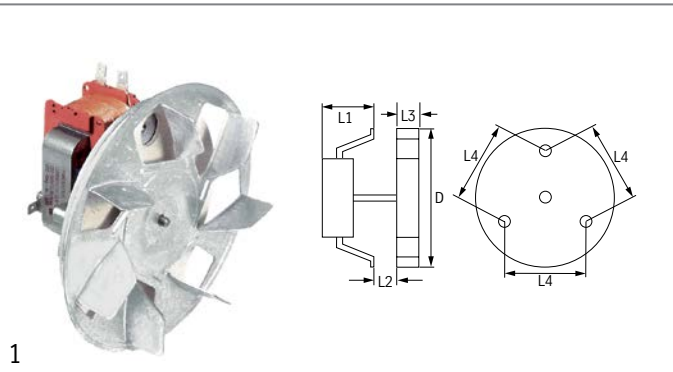

<b>Part No.</b>	601273	<b>Ref. No.</b>	M569010100
<b>description</b>	hot air fan 220-240V 32W 50/60Hz L1 60mm L2 10mm L3 25mm L4 87mm fan wheel ø 155mm FIME type C20X0E01/15CLH		

condensators & interference suppression filters

operating capacitors

plastic

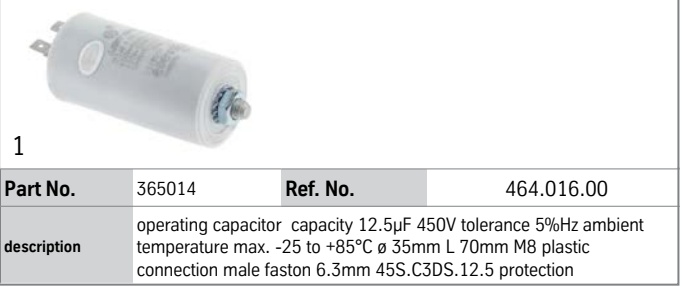

<b>Part No.</b>	365014	<b>Ref. No.</b>	464.016.00
<b>description</b>	operating capacitor capacity 12.5µF 450V tolerance 5%Hz ambient temperature max. -25 to +85°C ø 35mm L 70mm M8 plastic connection male faston 6.3mm 45S.C3DS.12.5 protection		

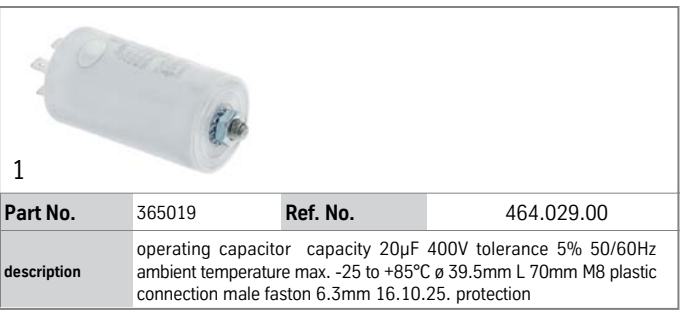

<b>Part No.</b>	365019	<b>Ref. No.</b>	464.029.00
<b>description</b>	operating capacitor capacity 20µF 400V tolerance 5% 50/60Hz ambient temperature max. -25 to +85°C ø 39.5mm L 70mm M8 plastic connection male faston 6.3mm 16.10.25. protection		

filters

interference suppression filters



<b>Part No.</b>	365044	<b>Ref. No.</b>	464.067.00 661.064.00
<b>description</b>	interference suppression filter type FC701Y2F 250V 50-60Hz conductor 2 with E connection cable 200mm L 42mm ø 23mm Hmm Wmm plastic Qty 1 pcs		





## electric accessories

### terminals

#### connection terminals with screw/faston connections



1

<b>Part No.</b>	550278	<b>Ref. No.</b>	M566050000
<b>description</b>	power terminal block 3-pole max. 40A max 400V connection $\phi 6\text{mm}^2$ / F6.3 temp.-resist. 150°C cross section 6mm <sup>2</sup>		



1

<b>Part No.</b>	550411	<b>Ref. No.</b>	M566050500
<b>description</b>	power terminal block 6-pole max. 40A max 450V connection $\phi 6\text{mm}^2$ / F6.3 temp.-resist. 150°C cross section 6mm <sup>2</sup>		

#### connection terminals with screw connection



1

<b>Part No.</b>	550507	<b>Ref. No.</b>	66303600
<b>description</b>	power terminal block 4-pole max. 40A max 450V connection M6/M6 temp.-resist. 150°C		

## gas thermostats

### PEL

#### 25ST series



1

<b>Part No.</b>	101172	<b>Ref. No.</b>	67103400 67108100
<b>description</b>	gas thermostat PEL type 25ST 100-300°C gas inlet M16x1.5 (tube $\phi$ 10mm) bypass nozzle $\phi$ 0.35mm gas outlet M16x1.5 (tube $\phi$ 10/8mm) thermocouple connection M9x1 pilot connection M10x1 capillary pipe 1200mm probe $\phi$ 6mm probe L 100mm shaft $\phi$ 8x6.5mm shaft L 21/15mm shaft flat upper		
<b>For models:</b>	60/30FTG-CR, 60/30FTRG-CR, 60/60FTG-CR, 60/60FTRG-CR, 60/60FTRRG-CR, 70/70FTG-CR, 70/70FTRG-CR, 70/70FTRRG-CR		
<b>spare parts for</b>	101172		
	<b>Part No.</b>	100259	<b>Ref. No.</b> —
	bypass nozzle type PEL22 bore $\phi$ 0.35mm thread M6x0.5		

<b>spare parts for</b>	101172		
	<b>Part No.</b>	101060	<b>Ref. No.</b> —
	magnet unit standard L 39mm D1 $\phi$ 15.4mm D2 $\phi$ 11mm suitable for PEL20-21/JUNKERS/EGA		
	<b>Part No.</b>	106200	<b>Ref. No.</b> —
	nut thread M9x1 suitable for PEL 24/25S		
<b>accessories for</b>	101172		
	<b>Part No.</b>	100908	<b>Ref. No.</b> 67301300
	union screw thread M10x1 for pipe $\phi$ 4mm Qty 1 pcs		
	<b>Part No.</b>	100909	<b>Ref. No.</b> —
	union screw thread M10x1 for pipe $\phi$ 6mm Qty 1 pcs		
	<b>Part No.</b>	101246	<b>Ref. No.</b> 67300400
	olive for pipe $\phi$ 4mm Qty 1 pcs		
	<b>Part No.</b>	101278	<b>Ref. No.</b> 67300100
	olive for pipe $\phi$ 10mm Qty 1 pcs		
	<b>Part No.</b>	101286	<b>Ref. No.</b> —
	olive ID $\phi$ 6mm Qty 1 pcs		
	<b>Part No.</b>	101300	<b>Ref. No.</b> —
	union nut thread M16x1.5 tube $\phi$ 10mm		
	<b>Part No.</b>	101450	<b>Ref. No.</b> —
	olive for pipe $\phi$ 8mm L 12.7mm Qty 1 pcs ED $\phi$ 10mm		
	<b>Part No.</b>	101451	<b>Ref. No.</b> —
	union nut thread M16x1.5 tube $\phi$ 8mm		
	<b>Part No.</b>	110079	<b>Ref. No.</b> —
	knob dial plate gas thermostat 1-8 silver		
	<b>Part No.</b>	110081	<b>Ref. No.</b> —
	knob $\phi$ 70mm shaft $\phi$ 8x6.5mm shaft flat universal		



## gas valves and ignition boxes

## gas control valves

SIT

NOVASIT

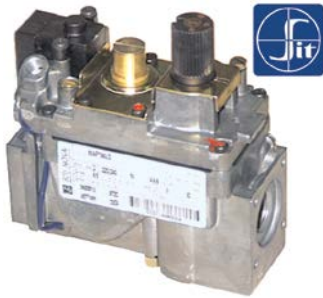









1

<b>Part No.</b>	101162	<b>Ref. No.</b>	RMC222500
<b>description</b>	gas valve SIT series Novasit 820 230V 50Hz gas inlet 1/2" gas outlet 1/2" thermocouple connection M9x1 pilot connection M10x1 ignition pressure 3-5mbar pressure range 3-30mbar pressure regulator connection blind equiv. no. 0.820.010		
<b>spare parts for</b>	101162		
	<b>Part No.</b>	101065	<b>Ref. No.</b> —
	magnet unit with cable L 44mm D1 ø 30mm D2 ø 20mm suitable for NOVASIT		
	<b>Part No.</b>	101313	<b>Ref. No.</b> —
	solenoid coil 230V 50Hz		
<b>accessories for</b>	101162		
	<b>Part No.</b>	100006	<b>Ref. No.</b> —
	piezoelectric igniter suitable for ELETTROSIT body plastic blowing connection ø2.4mm ø 14mm		
	<b>Part No.</b>	101305	<b>Ref. No.</b> —
	gas connection straight 1/2" flange 45x45mm ELETTROSIT/V4400/4600/4605 suitable for SIT/HONEYWELL hole distance 36x36mm		
	<b>Part No.</b>	101306	<b>Ref. No.</b> —
	gas connection angled flange 45x45mm hole distance 36x36mm 1/2" ELETTROSIT/V4400/4600/4605 screw with O-ring suitable for SIT/HONEYWELL		
	<b>Part No.</b>	101307	<b>Ref. No.</b> —
	gas connection straight flange 45x45mm hole distance 36x36mm 3/4" ELETTROSIT/V4400/4600/4605 screw with O-ring suitable for SIT/HONEYWELL		
	<b>Part No.</b>	101308	<b>Ref. No.</b> —
	gas connection angled flange 45x45mm hole distance 36x36mm 3/4" ELETTROSIT/V4400/4600/4605 screw with O-ring suitable for SIT/HONEYWELL		
	<b>Part No.</b>	101312	<b>Ref. No.</b> 968.501.00
	microswitch		
	<b>Part No.</b>	101314	<b>Ref. No.</b> —
	solenoid coil 24V 50Hz		
	<b>Part No.</b>	101317	<b>Ref. No.</b> —
	plug with cable L 1000mm suitable for NOVASIT		
	<b>Part No.</b>	101318	<b>Ref. No.</b> —
	cover cap for solenoid coil suitable for NOVASIT		







1

<b>Part No.</b>	101908	<b>Ref. No.</b>	256.331.00 256.335.00
<b>description</b>	gas valve SIT series Novasit 820 230V 50Hz gas inlet 1/2" gas outlet 1/2" thermocouple connection M9x1 pilot connection M10x1 ignition pressurembar pressure regulator connection blind equiv. no. 0.820.018 output pilot burner M10x1 input pressure max. 60bar setting range 3-30bar		
<b>spare parts for</b>	101908		
	<b>Part No.</b>	101065	<b>Ref. No.</b> —
	magnet unit with cable L 44mm D1 ø 30mm D2 ø 20mm suitable for NOVASIT		
	<b>Part No.</b>	101313	<b>Ref. No.</b> —
	solenoid coil 230V 50Hz		
<b>accessories for</b>	101908		
	<b>Part No.</b>	100006	<b>Ref. No.</b> —
	piezoelectric igniter suitable for ELETTROSIT body plastic blowing connection ø2.4mm ø 14mm		
	<b>Part No.</b>	101305	<b>Ref. No.</b> —
	gas connection straight 1/2" flange 45x45mm ELETTROSIT/V4400/4600/4605 suitable for SIT/HONEYWELL hole distance 36x36mm		
	<b>Part No.</b>	101306	<b>Ref. No.</b> —
	gas connection angled flange 45x45mm hole distance 36x36mm 1/2" ELETTROSIT/V4400/4600/4605 screw with O-ring suitable for SIT/HONEYWELL		
	<b>Part No.</b>	101307	<b>Ref. No.</b> —
	gas connection straight flange 45x45mm hole distance 36x36mm 3/4" ELETTROSIT/V4400/4600/4605 screw with O-ring suitable for SIT/HONEYWELL		
	<b>Part No.</b>	101308	<b>Ref. No.</b> —
	gas connection angled flange 45x45mm hole distance 36x36mm 3/4" ELETTROSIT/V4400/4600/4605 screw with O-ring suitable for SIT/HONEYWELL		
	<b>Part No.</b>	101312	<b>Ref. No.</b> 968.501.00
	microswitch		
	<b>Part No.</b>	101314	<b>Ref. No.</b> —
	solenoid coil 24V 50Hz		
	<b>Part No.</b>	101317	<b>Ref. No.</b> —
	plug with cable L 1000mm suitable for NOVASIT		
	<b>Part No.</b>	101318	<b>Ref. No.</b> —
	cover cap for solenoid coil suitable for NOVASIT		



1

<b>Part No.</b>	101967	<b>Ref. No.</b>	RRC5350-00
<b>description</b>	gas valve SIT series Novasit 822 230V 50Hz gas inlet 1/2" gas outlet 1/2" thermocouple connection pilot connection M10x1 ignition pressure 3-5mbar pressure range 3-30mbar pressure regulator connection perforated equiv. no. 0.822.110		
<b>spare parts for</b>	101967		
	<b>Part No.</b>	101313	<b>Ref. No.</b> —
	solenoid coil 230V 50Hz		
	<b>Part No.</b>	101542	<b>Ref. No.</b> —
	solenoid coil 50Hz NOVA 822/826/827 suitable for NOVASIT 230V		
<b>accessories for</b>	101967		
	<b>Part No.</b>	100904	<b>Ref. No.</b> 671.011.00
	locking screw M10x1 for pipe ø 4mm Qty 1 pcs		
	<b>Part No.</b>	100905	<b>Ref. No.</b> —
	locking screw M10x1 for pipe ø 6mm Qty 1 pcs		
	<b>Part No.</b>	101305	<b>Ref. No.</b> —
	gas connection straight 1/2" flange 45x45mm ELETROSIT/V4400/4600/4605 suitable for SIT/HONEYWELL hole distance 36x36mm		
	<b>Part No.</b>	101306	<b>Ref. No.</b> —
	gas connection angled flange 45x45mm hole distance 36x36mm 1/2" ELETROSIT/V4400/4600/4605 screw with O-ring suitable for SIT/HONEYWELL		
	<b>Part No.</b>	101307	<b>Ref. No.</b> —
	gas connection straight flange 45x45mm hole distance 36x36mm 3/4" ELETROSIT/V4400/4600/4605 screw with O-ring suitable for SIT/HONEYWELL		
	<b>Part No.</b>	101308	<b>Ref. No.</b> —
	gas connection angled flange 45x45mm hole distance 36x36mm 3/4" ELETROSIT/V4400/4600/4605 screw with O-ring suitable for SIT/HONEYWELL		
	<b>Part No.</b>	101503	<b>Ref. No.</b> —
	O-ring EPDM thickness 2mm ID ø 32mm Qty 1 pcs		
	<b>Part No.</b>	101924	<b>Ref. No.</b> —
	plug with cable L 1090mm suitable for NOVA 822/826/827		

accessories



1

<b>Part No.</b>	101312	<b>Ref. No.</b>	968.501.00
<b>description</b>	microswitch		

ignition boxes

SIT



1

<b>Part No.</b>	102346	<b>Ref. No.</b>	572.015.00
<b>description</b>	ignition box SIT type 577DBC electrodes 2 waiting time 1.5s safety time 6s 220/240V 20VA 50/60Hz protection IP40		

miscellaneous



1

<b>Part No.</b>	401171	<b>Ref. No.</b>	999.23.033
<b>description</b>	ignition box		

ignition parts

pilot burners

SIT

100 series



1

































<b>Part No.</b>	106902	<b>Ref. No.</b>	67206900
<b>description</b>	pilot burner SIT type 100 series 2 flames nozzle ø 0.2mm gas connection 6mm		
<b>For models:</b>	65/110TPFG, 65/70TPFG, 65/70TPG, 70/110TPFG, 70/70TPFG, 70/70TPG		
<b>spare parts for</b>	106902		
	<b>Part No.</b>	100245	<b>Ref. No.</b> —
	pilot burner nozzle LPG code 20 bore ø 0.2mm Qty 1 pcs thread M8x0.75		
	<b>Part No.</b>	100842	<b>Ref. No.</b> —
	pilot burner cap 2 flames Qty 1 pcs		
	<b>Part No.</b>	100885	<b>Ref. No.</b> 972.031.00
	air mixing sleeve for pilot burner Qty 1 pcs		
	<b>Part No.</b>	100916	<b>Ref. No.</b> —
	compression spring for pilot burner Qty 1 pcs		

Table continues overleaf



spare parts for		106902		
	Part No.	100917	Ref. No.	—
	gasket for pilot burner Qty 1 pcs aluminium ID ø 8.5mm ED ø 11mm thickness 1.2mm			
	Part No.	100918	Ref. No.	—
	screw for pilot burner			
	Part No.	107161	Ref. No.	—
	pilot burner cap SIT 2 flames Hmm Lmm Qty 1 pcs			
	Part No.	107701	Ref. No.	672.094.00 97202900
	pilot burner bottom part SIT 100 series nozzle ø 0.2mm			
accessories for		106902		
	Part No.	100246	Ref. No.	672.059.00
	pilot burner nozzle natural gas bore ø 0.35mm Qty 1 pcs thread M8x0.75			
	Part No.	100904	Ref. No.	671.011.00
	locking screw M10x1 for pipe ø 4mm Qty 1 pcs			
	Part No.	100905	Ref. No.	—
	locking screw M10x1 for pipe ø 6mm Qty 1 pcs			
	Part No.	102110	Ref. No.	97514000
	pilot tube copper pipe ø 4mm thickness 1mm L 3000mm			
	Part No.	102111	Ref. No.	—
	pilot tube copper pipe ø 6mm thickness 1mm L 3000mm			
	Part No.	107171	Ref. No.	672.058.00
	pilot burner nozzle SIT natural/liquid gas bore ø 0.25mm Qty 1 pcs			
	Part No.	107700	Ref. No.	—
	pilot burner bottom part SIT 100 series nozzle ø 0.25mm			
	Part No.	107702	Ref. No.	—
	pilot burner bottom part SIT 100 series nozzle ø 0.35mm			









				
<b>1</b>				
<b>Part No.</b>	106907	<b>Ref. No.</b>	67205700	
<b>description</b>	pilot burner SIT type 100 series 3 flames nozzle ø 0.35mm gas connection 6mm			
spare parts for		106907		
	Part No.	100246	Ref. No.	672.059.00
	pilot burner nozzle natural gas bore ø 0.35mm Qty 1 pcs thread M8x0.75			
	Part No.	100855	Ref. No.	—
	pilot burner bracket triple			
	Part No.	100885	Ref. No.	972.031.00
	air mixing sleeve for pilot burner Qty 1 pcs			
	Part No.	100916	Ref. No.	—
	compression spring for pilot burner Qty 1 pcs			

spare parts for		106907		
	Part No.	100917	Ref. No.	—
	gasket for pilot burner Qty 1 pcs aluminium ID ø 8.5mm ED ø 11mm thickness 1.2mm			
	Part No.	100918	Ref. No.	—
	screw for pilot burner			
	Part No.	107162	Ref. No.	—
	pilot burner cap SIT 3 flames Hmm Lmm Qty 1 pcs			
	Part No.	107702	Ref. No.	—
	pilot burner bottom part SIT 100 series nozzle ø 0.35mm			
accessories for		106907		
	Part No.	100245	Ref. No.	—
	pilot burner nozzle LPG code 20 bore ø 0.2mm Qty 1 pcs thread M8x0.75			
	Part No.	100904	Ref. No.	671.011.00
	locking screw M10x1 for pipe ø 4mm Qty 1 pcs			
	Part No.	100905	Ref. No.	—
	locking screw M10x1 for pipe ø 6mm Qty 1 pcs			
	Part No.	102110	Ref. No.	97514000
	pilot tube copper pipe ø 4mm thickness 1mm L 3000mm			
	Part No.	102111	Ref. No.	—
	pilot tube copper pipe ø 6mm thickness 1mm L 3000mm			
	Part No.	107171	Ref. No.	672.058.00
	pilot burner nozzle SIT natural/liquid gas bore ø 0.25mm Qty 1 pcs			
	Part No.	107700	Ref. No.	—
	pilot burner bottom part SIT 100 series nozzle ø 0.25mm			
	Part No.	107701	Ref. No.	672.094.00 97202900
	pilot burner bottom part SIT 100 series nozzle ø 0.2mm			

accessories				
pilot burner bottom parts				
				
<b>1</b>				
<b>Part No.</b>	107701	<b>Ref. No.</b>	672.094.00 97202900	
<b>description</b>	pilot burner bottom part SIT 100 series nozzle ø 0.2mm			
spare parts for		107701		
	Part No.	100245	Ref. No.	—
	pilot burner nozzle LPG code 20 bore ø 0.2mm Qty 1 pcs thread M8x0.75			
	Part No.	100916	Ref. No.	—
	compression spring for pilot burner Qty 1 pcs			

Table continues overleaf



spare parts for		107701	
	Part No.	100917	Ref. No. —
gasket for pilot burner Qty 1 pcs aluminium ID $\varnothing$ 8.5mm ED $\varnothing$ 11mm thickness 1.2mm			
	Part No.	100918	Ref. No. —
screw for pilot burner			
accessories for		107701	
	Part No.	100246	Ref. No. 672.059.00
pilot burner nozzle natural gas bore $\varnothing$ 0.35mm Qty 1 pcs thread M8x0.75			
	Part No.	100904	Ref. No. 671.011.00
locking screw M10x1 for pipe $\varnothing$ 4mm Qty 1 pcs			
	Part No.	100905	Ref. No. —
locking screw M10x1 for pipe $\varnothing$ 6mm Qty 1 pcs			
	Part No.	102110	Ref. No. 97514000
pilot tube copper pipe $\varnothing$ 4mm thickness 1mm L 3000mm			
	Part No.	102111	Ref. No. —
pilot tube copper pipe $\varnothing$ 6mm thickness 1mm L 3000mm			
	Part No.	102742	Ref. No. 67434600
pilot burner nozzle LPG code 25 bore $\varnothing$ 0.25mm Qty 1 pcs			

pilot burner nozzles			
	1		
Part No.	100246	Ref. No.	672.059.00
description pilot burner nozzle natural gas bore $\varnothing$ 0.35mm Qty 1 pcs thread M8x0.75			

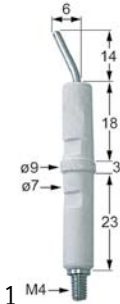
ignition electrodes			
	1		
Part No.	100706	Ref. No.	67206000
description ignition electrode connection M4 Qty 1 pcs			
For models: 65/110TPFG, 65/70TPFG, 65/70TPG, 70/110TPFG, 70/70TPFG, 70/70TPG			

miscellaneous			
	1		
Part No.	100885	Ref. No.	972.031.00
description air mixing sleeve for pilot burner Qty 1 pcs			















140 - 145 -150 series			
	1		
Part No.	107836	Ref. No.	672.173.00 67201300
description pilot burner SIT type 140 series 2 flames nozzle $\varnothing$ 0.40/0.38mm complete			
For models: 60/30FTG, 60/30FTG-CR, 60/30FTGR, 60/30FTRG-CR, 60/60FTG, 60/60FTG-CR, 60/60FTRG, 60/60FTRRG, 60/60FTRRG-CR, 65/40FTG, 65/40FTRG, 65/40GRG, 65/40GRL, 65/70FTG, 65/70FTRG, 65/70GRL, 70/40CPG, 70/40FTG, 70/40FTGS, 70/40FTRG, 70/40GRG, 70/40GRL, 70/70BRG, 70/70BRGM, 70/70CPG, 70/70FTG, 70/70FTG-CR, 70/70FTGS, 70/70FTRG, 70/70FTRG-CR, 70/70FTRRG, 70/70FTRRG-CR, 70/70GRG, 70/70GRL, 70/70PGI			
spare parts for		107836	
	Part No.	100207	Ref. No. 674.091.00
pilot burner nozzle SIT natural gas code 27 bore $\varnothing$ 0.40/0.38mm suitable for SIT 140 series			
	Part No.	100701	Ref. No. 256.017.00 256.060.00 67201500 672.028.00
ignition electrode connection M4 Qty 1 pcs			
	Part No.	100897	Ref. No. 67300300
olive for pipe $\varnothing$ 4mm Qty 1 pcs for pilot burner			
	Part No.	100906	Ref. No. 67301400
screw connection thread M10x1 for ignition electrode brass Qty 1 pcs WS 10			
	Part No.	100909	Ref. No. —
union screw thread M10x1 for pipe $\varnothing$ 6mm Qty 1 pcs			
accessories for		107836	
	Part No.	100801	Ref. No. —
gasket for pilot burner Qty 1 pcs			
	Part No.	102110	Ref. No. 97514000
pilot tube copper pipe $\varnothing$ 4mm thickness 1mm L 3000mm			
	Part No.	102111	Ref. No. —
pilot tube copper pipe $\varnothing$ 6mm thickness 1mm L 3000mm			





			
<b>1</b>			
<b>Part No.</b>	107114 <sup>1</sup>	<b>Ref. No.</b>	67201400
<b>description</b>	pilot burner SIT type 140 series 2 flames nozzle 0mm gas connectionmm		
<b>spare parts for</b>	107114		
	<b>Part No.</b>	100907	<b>Ref. No.</b> —
	screw connection thread M10x1 Qty 1 pcs type SEF 1 0mm for thermocouple		
<b>accessories for</b>	107114		
	<b>Part No.</b>	100204	<b>Ref. No.</b> —
	pilot burner nozzle SIT LPG code 14 bore ø 0.18/0.20mm Qty 1 pcs suitable for 140 series		
	<b>Part No.</b>	100205	<b>Ref. No.</b> 67400100
	pilot burner nozzle SIT LPG code 19 bore ø 0.23/0.26mm Qty 1 pcs suitable for SIT 150 series		
	<b>Part No.</b>	100206	<b>Ref. No.</b> 67400000
	pilot burner nozzle SIT natural gas code 36 bore ø 0.60/0.55mm Qty 1 pcs suitable for SIT 150 series		
	<b>Part No.</b>	100207	<b>Ref. No.</b> 674.091.00
	pilot burner nozzle SIT natural gas code 27 bore ø 0.40/0.38mm suitable for SIT 140 series		
	<b>Part No.</b>	100216	<b>Ref. No.</b> —
	pilot burner nozzle SIT natural gas code 38 bore ø 0.45mm Qty 1 pcs suitable for SIT 150 series		
	<b>Part No.</b>	100701	<b>Ref. No.</b> 256.017.00 256.060.00 67201500 672.028.00
	ignition electrode connection M4 Qty 1 pcs		
	<b>Part No.</b>	100801	<b>Ref. No.</b> —
	gasket for pilot burner Qty 1 pcs		
	<b>Part No.</b>	100897	<b>Ref. No.</b> 67300300
	olive for pipe ø 4mm Qty 1 pcs for pilot burner		
	<b>Part No.</b>	100898	<b>Ref. No.</b> —
	olive for pipe ø 6mm Qty 1 pcs for pilot burner		
	<b>Part No.</b>	100906	<b>Ref. No.</b> 67301400
	screw connection thread M10x1 for ignition electrode brass Qty 1 pcs WS 10		
	<b>Part No.</b>	100908	<b>Ref. No.</b> 67301300
	union screw thread M10x1 for pipe ø 4mm Qty 1 pcs		
	<b>Part No.</b>	100909	<b>Ref. No.</b> —
	union screw thread M10x1 for pipe ø 6mm Qty 1 pcs		
	<b>Part No.</b>	102110	<b>Ref. No.</b> 97514000
	pilot tube copper pipe ø 4mm thickness 1mm L 3000mm		
	<b>Part No.</b>	102111	<b>Ref. No.</b> —
	pilot tube copper pipe ø 6mm thickness 1mm L 3000mm		

<sup>1</sup>incl. thermocouple fitting

<b>160 series</b>			
			
<b>1</b>			
<b>Part No.</b>	100056	<b>Ref. No.</b>	672042 67204200
<b>description</b>	pilot burner SIT type 160 series 3 flames nozzle 0mm gas connectionmm		
<b>For models:</b>	60/30FRG, 60/60FRG, 65/40FRG, 65/70FRG, 70/40FRG13, 70/70FRG13		
<b>spare parts for</b>	100056		
	<b>Part No.</b>	100907	<b>Ref. No.</b> —
	screw connection thread M10x1 Qty 1 pcs type SEF 1 0mm for thermocouple		
<b>accessories for</b>	100056		
	<b>Part No.</b>	100202	<b>Ref. No.</b> —
	pilot burner nozzle natural gas code 41 Qty 1 pcs nozzle ø 0.41mm		
	<b>Part No.</b>	100203	<b>Ref. No.</b> —
	pilot burner nozzle LPG code 25 Qty 1 pcs nozzle ø 0.25mm		
	<b>Part No.</b>	100701	<b>Ref. No.</b> 256.017.00 256.060.00 67201500 672.028.00
	ignition electrode connection M4 Qty 1 pcs		
	<b>Part No.</b>	100801	<b>Ref. No.</b> —
	gasket for pilot burner Qty 1 pcs		
	<b>Part No.</b>	100869	<b>Ref. No.</b> —
	pilot burner nozzle natural gas code 51 Qty 1 pcs suitable for 160 series nozzle ø 0.51mm		
	<b>Part No.</b>	100870	<b>Ref. No.</b> 673.007.00
	olive for pipe ø 4mm Qty 1 pcs suitable for 160 series for pilot burner		
	<b>Part No.</b>	100906	<b>Ref. No.</b> 67301400
	screw connection thread M10x1 for ignition electrode brass Qty 1 pcs WS 10		
	<b>Part No.</b>	100908	<b>Ref. No.</b> 67301300
	union screw thread M10x1 for pipe ø 4mm Qty 1 pcs		
	<b>Part No.</b>	100909	<b>Ref. No.</b> —
	union screw thread M10x1 for pipe ø 6mm Qty 1 pcs		
	<b>Part No.</b>	101287	<b>Ref. No.</b> —
	olive for pipe ø 6mm Qty 1 pcs		
	<b>Part No.</b>	102110	<b>Ref. No.</b> 97514000
	pilot tube copper pipe ø 4mm thickness 1mm L 3000mm		
	<b>Part No.</b>	102111	<b>Ref. No.</b> —
	pilot tube copper pipe ø 6mm thickness 1mm L 3000mm		
	<b>Part No.</b>	107650	<b>Ref. No.</b> 674052 674.052.00
	pilot burner nozzle SIT LPG code 30 Qty 1 pcs		





electrodes

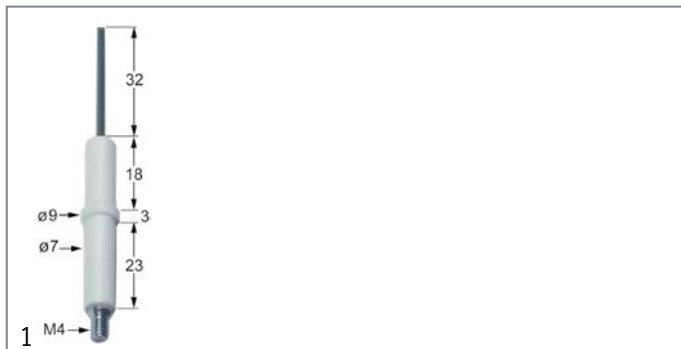

<b>Part No.</b>	100701	<b>Ref. No.</b>	256..060.00 256.017.00 672.028.00 67201500
-----------------	--------	-----------------	---

**description** ignition electrode connection M4 Qty 1 pcs

**For models:** 60/30FTG, 60/30FTG-CR, 60/30FTGR, 60/30FTRG-CR, 60/60FTG, 60/60FTG-CR, 60/60FTRG, 60/60FTRG-CR, 60/60FTRRG, 60/60FTRRGCR, 65/40FTG, 65/40FTRG, 65/40GRG, 65/40GRL, 65/70FTG, 65/70FTRG, 65/70GRG, 65/70GRL, 70/40CPG, 70/40FTG, 70/40FTGS, 70/40FTRG, 70/40GRG, 70/40GRL, 70/70BRG, 70/70BRGM, 70/70CPG, 70/70FTG, 70/70FTG-CR, 70/70FTGS, 70/70FTRG, 70/70FTRG-CR, 70/70FTRRG, 70/70FTRRG-CR, 70/70GRG, 70/70GRL, 70/70PGI

**accessories for** 100701

	<b>Part No.</b>	100906	<b>Ref. No.</b>	67301400
---	-----------------	--------	-----------------	----------

screw connection thread M10x1 for ignition electrode brass Qty 1 pcs WS 10

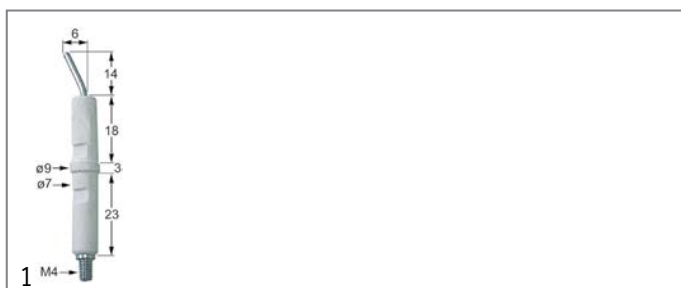

<b>Part No.</b>	100706	<b>Ref. No.</b>	67206000
-----------------	--------	-----------------	----------

**description** ignition electrode connection M4 Qty 1 pcs

**For models:** 65/110TPFG, 65/70TPFG, 65/70TPG, 70/110TPFG, 70/70TPFG, 70/70TPG



<b>Part No.</b>	102315	<b>Ref. No.</b>	999.22.037 RRC2497-00
-----------------	--------	-----------------	--------------------------

**description** ignition electrode flange length 23mm flange width 15mm D1 ø 7mm L1 5mm BL1 30mm BL2 23mm connection F 2.8x0.8mm fixing dimensions ø5x4mm with flange

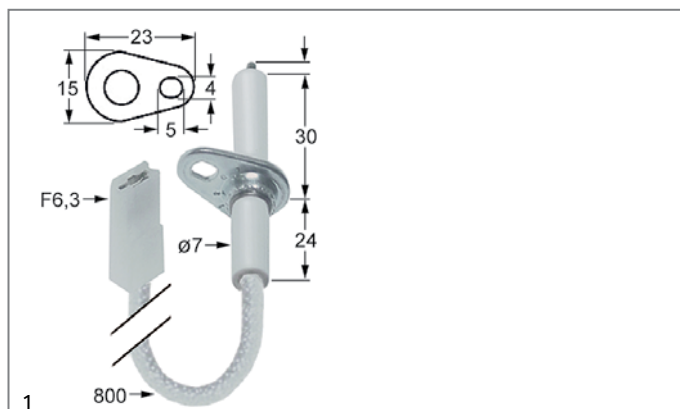

<b>Part No.</b>	102316	<b>Ref. No.</b>	999.22.036
-----------------	--------	-----------------	------------

**description** ignition electrode flange length 23mm flange width 15mm D1 ø 7mm L1 5mm BL1 30mm BL2 24mm connection F 6.3 cable length 800mm fixing dimensions ø5x4mm with flange



<b>Part No.</b>	100906	<b>Ref. No.</b>	67301400
-----------------	--------	-----------------	----------

**description** screw connection thread M10x1 for ignition electrode brass Qty 1 pcs WS 10

**For models:** 60/30FRG, 60/30FTG, 60/30FTG-CR, 60/30FTGR, 60/30FTRG-CR, 60/60FRG, 60/60FTG, 60/60FTG-CR, 60/60FTRG, 60/60FTRRG, 60/60FTRRG-CR, 65/40FRG, 65/40FTG, 65/40FTRG, 65/40GRG, 65/70FRG, 65/70FTG, 65/70FTRG, 65/70GRG, 70/40CPG, 70/40FRG13, 70/40FTG, 70/40FTGS, 70/40FTRG, 70/40GRG, 70/40GRL, 70/70BRG, 70/70BRGM, 70/70CPG, 70/70FRG13, 70/70FTG, 70/70FTG-CR, 70/70FTGS, 70/70FTRG, 70/70FTRG-CR, 70/70FTRRG, 70/70FTRRG-CR, 70/70GRG, 70/70GRL, 70/70PGI



ignition cables

pre-assembled cables



<b>Part No.</b>	100018	<b>Ref. No.</b>	66600100
-----------------	--------	-----------------	----------

**description** ignition cable cable length 600mm connection  $\varnothing$ 2.4mm /  $\varnothing$ 4mm permanent temperature 200°C

**For models:** 60/30FRG, 60/30FTG-CR, 60/30FTGR, 60/30FTRG-CR, 60/60FRG, 60/60FTG, 60/60FTG-CR, 60/60FTRG, 60/60FTRG-CR, 60/60FTRRG, 60/60FTRRG-CR, 65/110TPFG, 65/40FRG, 65/40FTG, 65/40FTRG, 65/40GRG, 65/40GRL, 65/70FRG, 65/70FTG, 65/70FTRG, 65/70GRG, 65/70GRL, 65/70TPFG, 65/70TPG, 70/110TPFG, 70/40CPG, 70/40FTG, 70/40FTGS, 70/40FTRG, 70/40GRG, 70/40GRL, 70/70CPG, 70/70FTG, 70/70FTG-CR, 70/70FTGS, 70/70FTRG, 70/70FTRG-CR, 70/70FTRRG, 70/70FTRRG-CR, 70/70GRG, 70/70GRL, 70/70PGI, 70/70TPFG, 70/70TPG



<b>Part No.</b>	100025	<b>Ref. No.</b>	66605100
-----------------	--------	-----------------	----------

**description** ignition cable cable length 600mm connection  $\varnothing$ 4mm / F6.3mm

**For models:** 70/40FRG13, 70/70BRG, 70/70BRGM, 70/70FRG13



<b>Part No.</b>	100178	<b>Ref. No.</b>	66600000
-----------------	--------	-----------------	----------

**description** ignition cable cable length 900mm connection F2.8mm /  $\varnothing$ 2.4mm

**For models:** 65/110CFG, 65/110CFGE, 65/110TPFG, 65/40PCG, 65/70CFG, 65/70PCG

piezoelectric igniters

mounting diameter 22mm



<b>Part No.</b>	100013	<b>Ref. No.</b>	672.006.00
-----------------	--------	-----------------	------------

**description** piezoelectric igniter body plastic blowing mounting  $\varnothing$  22mm connection  $\varnothing$ 2.4mm cable lengthmm

**For models:** 60/30FRG, 60/30FTG, 60/30FTG-CR, 60/30FTGR, 60/30FTRG CR, 60/30PCG, 60/60FRG, 60/60FTG, 60/60FTG-CR, 60/60FTRG, 60/60FTRG-CR, 60/60FTRRG, 60/60FTRRG-CR, 60/60PCG, 65/110CFG, 65/110CFGE, 65/110CFGG, 65/110TPFG, 65/40FRG, 65/40FTG, 65/40FTRG, 65/40GRG, 65/40GRL, 65/40PCG, 65/70CFG, 65/70FRG, 65/70FTG, 65/70FTRG, 65/70GRG, 65/70GRL, 65/70PCG, 65/70TPFG, 65/70TPG, 70/110CFG, 70/110TPFG, 70/40FTG, 70/40FTGS, 70/40FTRG, 70/40GRG, 70/40GRL, 70/70CFG, 70/70CPG, 70/70FTG, 70/70FTG-CR, 70/70FTGS, 70/70FTRG, 70/70FTRG-CR, 70/70FTRRG, 70/70FTRRG-CR, 70/70GRG...(Other models you can see in the webshop)

**accessories for** 100013



<b>Part No.</b>	100023	<b>Ref. No.</b>	—
-----------------	--------	-----------------	---

female bullet size 2.3mm 0.5-1.5mm<sup>2</sup> CuZn t.max. 125°C Qty 20 pcs

ignition units



<b>Part No.</b>	101012	<b>Ref. No.</b>	96103000
-----------------	--------	-----------------	----------

**description** ignition unit outputs 2 230VAC dimensions 48x32x32mm mounting distance 56mm inlet F2.8x0.8 outlet F2.8x0.8 type ZIG2 50-60Hz



<b>Part No.</b>	101002	<b>Ref. No.</b>	661.118.00
-----------------	--------	-----------------	------------

**description** ignition unit outputs 2 230VAC dimensions 88x23x34mm mounting distance 73mm inlet F6.3x0.8 outlet F2.8x0.8 0.6VA 50/60Hz



<b>Part No.</b>	101023	<b>Ref. No.</b>	66304200
-----------------	--------	-----------------	----------

**description** ignition unit outputs 4 230VAC dimensions 111x28x34mm mounting distance 98mm inlet F6.3x0.8 outlet F2.8x0.8 type ZAG4 0.3VA 50-60Hz

**For models:** 60/60CFG, 60/60CFGE

**accessories for** 101023

<b>Part No.</b>	103257	<b>Ref. No.</b>	—
-----------------	--------	-----------------	---

**description** ignition unit outputs 4 230VAC dimensions 111x28x34mm mounting distance 98mm inlet F6.3x0.8 outlet F2.8x0.8 type FZ4 set 6-piece 0.3VA 50-60Hz

thermocouples

plug-in thermocouples

plug-in thermocouples standard

with barrel socket  $\varnothing$ 6(6.5)mm

thermocouples SIT

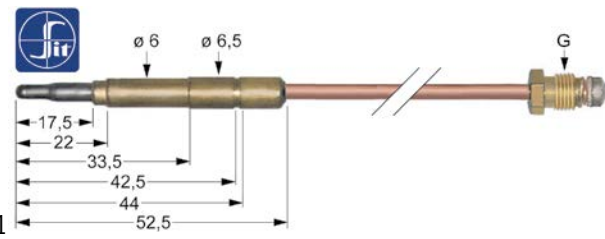

<b>Part No.</b>	107613	<b>Ref. No.</b>	672.154.00
-----------------	--------	-----------------	------------

**description** thermocouple SIT M9x1 L 1200mm plug connection  $\varnothing$ 6.0(6.5)mm

gas components



<b>Part No.</b>	107614	<b>Ref. No.</b>	672.179.00 67210400
<b>description</b>	thermocouple SIT M9x1 L 1500mm plug connection ø6.0(6.5)mm		

<b>Part No.</b>	107608	<b>Ref. No.</b>	67200100 67202500
<b>description</b>	thermocouple SIT M9x1 L 500mm plug connection ø6.0(6.5)mm		
<b>For models:</b>	60/30FTRG, 60/60FRG, 60/60FTG, 60/60FTG-CR, 60/60FTRG-CR, 60/60FTRRG-CR, 65/40FRG, 65/40FTG, 65/40FTRG, 65/40GRG, 65/40GRL, 65/40PG-40P, 65/70FRG, 65/70FTG, 65/70FTRG, 65/70GRG, 65/70GRL, 65/70TPFG, 65/70TPG, 70/110CFG, 70/110CFGE, 70/110PCG, 70/110TPFG, 70/40CPG, 70/40FRG13, 70/40FTG, 70/40FTGS, 70/40FTRG, 70/40GRG, 70/40GRL, 70/40PCG, 70/70BRG, 70/70BRGM, 70/70CFG, 70/70CFGE, 70/70CPG, 70/70FRG13, 70/70FTG, 70/70FTG-CR, 70/70FTGS, 70/70FTRG, 70/70FTRG-CR, 70/70FTRRG, 70/70FTRRG-CR, 70/70GRG, 70/70GRL, 70/70PCG, 70/70TPFG, 70/70TPG		

<b>Part No.</b>	107611	<b>Ref. No.</b>	67208300 67209900
<b>description</b>	thermocouple SIT M9x1 L 850mm plug connection ø6.0(6.5)mm		
<b>For models:</b>	70/70PGI		

plug-in thermocouples with interruption

<b>Part No.</b>	107177	<b>Ref. No.</b>	672.055.00
<b>description</b>	thermocouple SIT with interrupter M9x1 L 600mm plug connection ø6.0mm F 6.3mm		

threaded thermocouples  
threaded thermocouples standard  
with socket with thread M8x1  
SIT

<b>Part No.</b>	107633	<b>Ref. No.</b>	67201800
<b>description</b>	thermocouple SIT M8x1 L 1200mm M8x1		
<b>For models:</b>	65/110CFG, 65/110CFGG, 65/110TPFG, 65/70CFG, 65/70TPFG, 70/110CFG, 70/110TPFG, 70/70CFG, 70/70TPFG		
<b>accessories for</b>	107633		

<b>Part No.</b>	102067	<b>Ref. No.</b>	—
<b>description</b>	nut thread M8x1 H 3mm brass Qty 1 pcs type SEF 1		

<b>Part No.</b>	107630	<b>Ref. No.</b>	67200000
<b>description</b>	thermocouple SIT M8x1 L 600mm M8x1		
<b>For models:</b>	65/110CFG, 65/110CFGE, 65/110CFGG, 65/110TPFG, 65/40PCG, 65/70CFG, 65/70PCG, 70/70K, CEG110, CEG70		
<b>accessories for</b>	107630		

<b>Part No.</b>	102067	<b>Ref. No.</b>	—
<b>description</b>	nut thread M8x1 H 3mm brass Qty 1 pcs type SEF 1		

extensions

<b>Part No.</b>	102811	<b>Ref. No.</b>	672.100.00
<b>description</b>	thermocouple extension thread M9x1 - M9x1 L 600mm		

accessories

screws

<b>Part No.</b>	101260	<b>Ref. No.</b>	672.002.00
<b>description</b>	thermocouple fitting thread M8x1 Qty 1 pcs		

gas components



interrupters



1

<b>Part No.</b>	101265	<b>Ref. No.</b>	67202000
<b>description</b>	interrupter thread M9x1		
<b>For models:</b>	60/30FRG, 60/60FRG, 65/40FRG, 65/70FRG		

gas burners

bar burners

bar burners



1



<b>Part No.</b>	105776	<b>Ref. No.</b>	999.23.050
<b>description</b>	bar burner ø 50mm Wmm Hmm L 305mm with bolt M5x12 flange width 52mm convection oven flange ø 75mm		

accessories

nozzle holders



1

<b>Part No.</b>	104108	<b>Ref. No.</b>	67302300
<b>description</b>	nozzle holder nozzle mounting M10x1 tube ø 10mm gas inlet M16x1.5 gas outlet M14x1		
<b>accessories for</b>	104108		
	<b>Part No.</b>	102382	<b>Ref. No.</b> 673.024.00
	nut thread M14x1 H 3.5mm WS 18 brass Qty 1 pcs		
	<b>Part No.</b>	104105	<b>Ref. No.</b> —
	burner lower part for burner cap ø 80mm 3.5kW		
	<b>Part No.</b>	104107	<b>Ref. No.</b> —
	burner lower part for burner cap ø 100mm 6.4kW		

gas nozzles

main nozzles

gas nozzles M10x1



1

<b>Part No.</b>	101975	<b>Ref. No.</b>	67407200
<b>description</b>	gas injector thread M10x1 bore ø 1.55mm L 30mm WS 12		



1

<b>Part No.</b>	100816	<b>Ref. No.</b>	67407100
<b>description</b>	gas injector thread M10x1 bore ø 1.5mm WS 12		

pilot burner nozzles

pilot burner nozzles SIT

100 series



1

<b>Part No.</b>	100246	<b>Ref. No.</b>	672.059.00
<b>description</b>	pilot burner nozzle natural gas bore ø 0.35mm Qty 1 pcs thread M8x0.75		



1

<b>Part No.</b>	107171	<b>Ref. No.</b>	672.058.00
<b>description</b>	pilot burner nozzle SIT natural/liquid gas bore ø 0.25mm Qty 1 pcs		

140/150 series



1

<b>Part No.</b>	100205	<b>Ref. No.</b>	67400100
<b>description</b>	pilot burner nozzle SIT LPG code 19 bore ø 0.23/0.26mm Qty 1 pcs suitable for SIT 150 series		



1

<b>Part No.</b>	100207	<b>Ref. No.</b>	674.091.00
<b>description</b>	pilot burner nozzle SIT natural gas code 27 bore ø 0.40/0.38mm suitable for SIT 140 series		





1

<b>Part No.</b>	100206	<b>Ref. No.</b>	67400000
<b>description</b>	pilot burner nozzle SIT natural gas code 36 bore ø 0.60/0.55mm Qty 1 pcs suitable for SIT 150 series		



## 160 series

			
1			
<b>Part No.</b>	107172	<b>Ref. No.</b>	67405400
<b>description</b>	pilot burner nozzle SIT LPG code 25 Qty 1 pcs		
<b>For models:</b>	K4/240		





			
1			
<b>Part No.</b>	107650	<b>Ref. No.</b>	674.052.00 674052
<b>description</b>	pilot burner nozzle SIT LPG code 30 Qty 1 pcs		



			
1			
<b>Part No.</b>	107174	<b>Ref. No.</b>	674.053.00
<b>description</b>	pilot burner nozzle SIT natural gas code 41 Qty 1 pcs		



			
1			
<b>Part No.</b>	107175	<b>Ref. No.</b>	674.051.00
<b>description</b>	pilot burner nozzle SIT natural gas code 51 Qty 1 pcs suitable for 160 series		



## screw connections

### olives

				
1				
<b>Part No.</b>	101278	<b>Ref. No.</b>	67300100	
<b>description</b>	olive for pipe ø 10mm Qty 1 pcs			
<b>accessories for</b>	101278			
	<b>Part No.</b>	100943	<b>Ref. No.</b>	—
	union nut thread M17x1 tube ø 10mm			
	<b>Part No.</b>	101300	<b>Ref. No.</b>	—
	union nut thread M16x1.5 tube ø 10mm			
	<b>Part No.</b>	101478	<b>Ref. No.</b>	—
	union nut thread 3/8" for pipe ø 10mm			

				
1				
<b>Part No.</b>	101273	<b>Ref. No.</b>	673.006.00 673.008.00	
<b>description</b>	olive for pipe ø 12mm L 9.5mm brass Qty 1 pcs suitable for universal			
<b>accessories for</b>	101273			
	<b>Part No.</b>	100944	<b>Ref. No.</b>	—
	union nut thread M18x1.5 for pipe ø 12mm			
	<b>Part No.</b>	101276	<b>Ref. No.</b>	—
	union screw thread 3/8" tube ø 12mm Qty 1 pcs			

				
1				
<b>Part No.</b>	101256	<b>Ref. No.</b>	67302700	
<b>description</b>	olive for pipe ø 16mm Qty 1 pcs			
<b>accessories for</b>	101256			
	<b>Part No.</b>	101253	<b>Ref. No.</b>	67302800
	union nut thread M24x1.5 PEL for pipe ø 16mm			

				
1				
<b>Part No.</b>	101246	<b>Ref. No.</b>	67300400	
<b>description</b>	olive for pipe ø 4mm Qty 1 pcs			
<b>For models:</b>	60/30FTG, 60/30FTG-CR, 60/30FTGR, 60/30FTRG-CR, 60/60FTG, 60/60FTG-CR, 60/60FTRG-CR, 60/60FTRRG, 60/60FTRRG-CR, 65/110TPFG, 65/40FTG, 65/40FTRG, 65/40GRG, 65/40GRL, 65/40PG-40P, 65/70FTG, 65/70FTRG, 65/70GRG, 65/70GRL, 65/70TPFG, 65/70TPG, 70/110CFGE, 70/110PCG, 70/110TPFG, 70/40CPG, 70/40FTG, 70/40FTGS, 70/40FTRG, 70/40GRG, 70/40GRL, 70/40PCG, 70/70BRG, 70/70BRGM, 70/70CFG, 70/70CPG, 70/70FTG, 70/70FTGCR, 70/70FTGS, 70/70FTRG, 70/70FTRG-CR, 70/70FTRRG, 70/70FTRRG-CR, 70/70GRG, 70/70GRL, 70/70K, 70/70PCG, 70/70PGI			
<b>accessories for</b>	101246			
	<b>Part No.</b>	100908	<b>Ref. No.</b>	67301300
	union screw thread M10x1 for pipe ø 4mm Qty 1 pcs			

			
1			
<b>Part No.</b>	100897	<b>Ref. No.</b>	67300300
<b>description</b>	olive for pipe ø 4mm Qty 1 pcs for pilot burner		
<b>For models:</b>	60/30FTG, 60/30FTG-CR, 60/30FTGR, 60/30FTRG-CR, 60/60FTG, 60/60FTG-CR, 60/60FTRG, 60/60FTRG-CR, 60/60FTRRG, 60/60FTRRG-CR, 65/40FTG, 65/40FTRG, 65/70FTG, 65/70FTRG, 70/40CPG, 70/40FTG, 70/40FTGS, 70/40FTRG, 70/40GRG, 70/40GRL, 70/70BRG, 70/70BRGM, 70/70CPG, 70/70FTG, 70/70FTG-CR, 70/70FTGS, 70/70FTRG, 70/70FTRG-CR, 70/70FTRRG, 70/70FTRRG-CR, 70/70GRG, 70/70GRL, 70/70PGI		







1

<b>Part No.</b>	100870	<b>Ref. No.</b>	673.007.00
<b>description</b>	olive for pipe ø 4mm Qty 1 pcs suitable for 160 series for pilot burner		

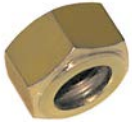
## union nuts



1

<b>Part No.</b>	101253	<b>Ref. No.</b>	67302800
<b>description</b>	union nut thread M24x1.5 PEL for pipe ø 16mm		
<b>accessories for</b>	101253		
	<b>Part No.</b>	101256	<b>Ref. No.</b>
			67302700
	olive for pipe ø 16mm Qty 1 pcs		

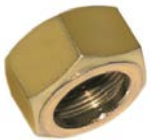

1

<b>Part No.</b>	101254	<b>Ref. No.</b>	67303000
<b>description</b>	union nut thread M28x1.5 tube ø 20mm		
<b>accessories for</b>	101254		
	<b>Part No.</b>	101257	<b>Ref. No.</b>
			—
	olive for pipe ø 20mm Qty 1 pcs		

## union screws



1

<b>Part No.</b>	100904	<b>Ref. No.</b>	671.011.00
<b>description</b>	locking screw M10x1 for pipe ø 4mm Qty 1 pcs		



1

<b>Part No.</b>	100906	<b>Ref. No.</b>	67301400
<b>description</b>	screw connection thread M10x1 for ignition electrode brass Qty 1 pcs WS 10		
<b>For models:</b>	60/30FRG, 60/30FTG, 60/30FTG-CR, 60/30FTGR, 60/30FTRG-CR, 60/60FRG, 60/60FTG, 60/60FTG-CR, 60/60FTRG, 60/60FTRG-CR, 60/60FTRRG, 60/60FTRRG-CR, 65/40FRG, 65/40FTG, 65/40FTRG, 65/40GRG, 65/70FRG, 65/70FTG, 65/70FTRG, 65/70GRG, 70/40CPG, 70/40FRG13, 70/40FTG, 70/40FTGS, 70/40FTRG, 70/40GRG, 70/40GRL, 70/70BRG, 70/70BRGM, 70/70CPG, 70/70FRG13, 70/70FTG, 70/70FTG-CR, 70/70FTGS, 70/70FTRG, 70/70FTRG-CR, 70/70FTRRG, 70/70FTRRG-CR, 70/70GRG, 70/70GRL, 70/70PGI		



1

<b>Part No.</b>	100908	<b>Ref. No.</b>	67301300
<b>description</b>	union screw thread M10x1 for pipe ø 4mm Qty 1 pcs		
<b>For models:</b>	60/30FRG, 60/30FTG, 60/30FTG-CR, 60/30FTGR, 60/30FTRG-CR, 60/60FRG, 60/60FTG, 60/60FTG-CR, 60/60FTRG, 60/60FTRG-CR, 60/60FTRRG, 60/60FTRRG-CR, 65/110TPFG, 65/40FTG, 65/40FTRG, 65/40GRG, 65/40GRL, 65/40PG-40P, 65/70FRG, 65/70FTG, 65/70FTRG, 65/70GRG, 65/70GRL, 65/70TPFG, 65/70TPG, 70/110CFG, 70/110CFGE, 70/110TPFG, 70/40CPG, 70/40FRG13, 70/40FTG, 70/40FTGS, 70/40FTRG, 70/40GRG, 70/40GRL, 70/40PCG, 70/70BRG, 70/70BRGM, 70/70CFG, 70/70CFGE, 70/70CPG, 70/70FRG13, 70/70FTG, 70/70FTGCR, 70/70FTGS, 70/70FTRG, 70/70FTRG-CR, 70/70FTRRG, 70/70FTRRGCR, 70/70GRG...(Other models you can see in the webshop)		
<b>accessories for</b>	100908		
	<b>Part No.</b>	100897	<b>Ref. No.</b>
			67300300
	olive for pipe ø 4mm Qty 1 pcs for pilot burner		
	<b>Part No.</b>	101246	<b>Ref. No.</b>
			67300400
	olive for pipe ø 4mm Qty 1 pcs		
	<b>Part No.</b>	101280	<b>Ref. No.</b>
			—
	olive for pipe ø 4mm Qty 1 pcs		
	<b>Part No.</b>	101282	<b>Ref. No.</b>
			—
	olive for pipe ø 4mm L 7.4mm Qty 1 pcs		

## knobs

## universal knobs



1

<b>Part No.</b>	111533	<b>Ref. No.</b>	MANOP003
<b>description</b>	knob thermostat t.max. 500°C ø 50mm shaft ø 6x4.6mm shaft flat upper black temperature range 0-500°C rotation 270°		
<b>accessories for</b>	111533		
	<b>Part No.</b>	110135	<b>Ref. No.</b>
			—
	rosette knob up to ø 52mm		





locks

edgemount latches

handle latches

producer-specific

HOUNÖ



1

<b>Part No.</b>	694784	<b>Ref. No.</b>	RRC2211-01
<b>description</b>	catch L 172mm mounting distance 124/133mm chrome-plated non lockable heated units 6200 H 65mm type DUPLO total length 248mm		
<b>accessories for</b>	694784		
	<b>Part No.</b>	690123	<b>Ref. No.</b> 999.22.070
	door catch H 69mm D 37mm W 20mm mounting distance 43mm with roller		

door catches



1

<b>Part No.</b>	690487	<b>Ref. No.</b>	CC2211-02 RRC2211-02
<b>description</b>	door catch H 41mm L 70mm W 21mm mounting distance 40mm nickel-plated brass with roller rollerø 8mm		



1

<b>Part No.</b>	690123	<b>Ref. No.</b>	999.22.070
<b>description</b>	door catch H 69mm D 37mm W 20mm mounting distance 43mm with roller		

snap locks

universal



1

<b>Part No.</b>	690596	<b>Ref. No.</b>	684.012.00
<b>description</b>	snap lock L 60mm W 15mm H 36mm mounting distance 48/28mm spring thickness 1.5mm complete with door catch zamak		

espagnolette locks

universal



1

<b>Part No.</b>	690041	<b>Ref. No.</b>	5900121 999.23.025
<b>description</b>	cam L 148mm mounting distance 32mm		



1

<b>Part No.</b>	700771	<b>Ref. No.</b>	5900123
<b>description</b>	latch gear opening to the left shaft intake ø 8x8mm L 170mm W 40mm H 40mm		

hinges

oven hinges

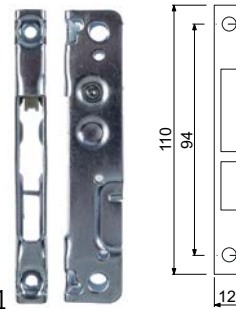

1

<b>Part No.</b>	693045	<b>Ref. No.</b>	584.005.00
<b>description</b>	opposite support L 110mm W 12mm mounting distance 94mm		

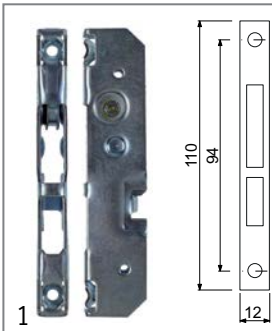

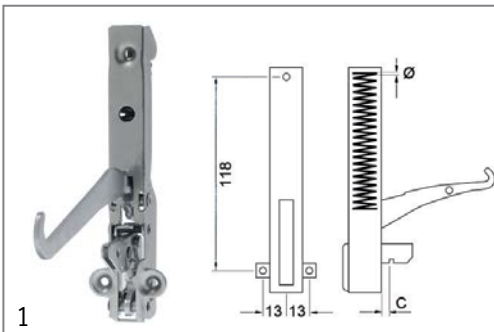

1

<b>Part No.</b>	700003	<b>Ref. No.</b>	68402300
<b>description</b>	opposite support L 110mm W 12mm mounting distance 94mm		
<b>For models:</b>	60/60CFE, 60/60CFG, 60/60CFGE		



1

<b>Part No.</b>	690030	<b>Ref. No.</b>	68402200
<b>description</b>	oven hinge mounting distance 118mm lug mounting 13mm lever length 117mm groove distance 10mm spring thickness 3.5mm mounting ear position left/right spring length 60mm L 155mm W 21mm		
<b>For models:</b>	60/60CFE, 60/60CFG, 60/60CFGE		
<b>accessories for</b>	690030		
		<b>Part No.</b>	700003
		<b>Ref. No.</b>	68402300
	opposite support L 110mm W 12mm mounting distance 94mm		

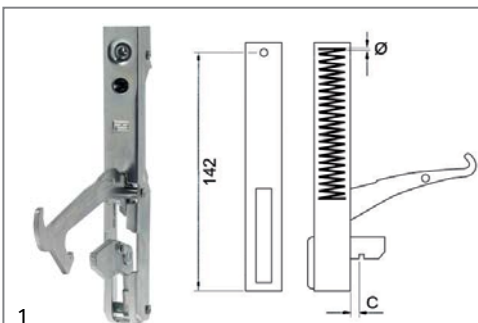

1

<b>Part No.</b>	700459	<b>Ref. No.</b>	584.001.00
<b>description</b>	oven hinge mounting distance 142mm mounting distance 2mm lug mountingmm lever length 117mm groove distance 7mm spring thickness 3.5mm mounting ear position spring length 58mm L 156mm W 22mm		
<b>accessories for</b>	700459		
		<b>Part No.</b>	693045
		<b>Ref. No.</b>	584.005.00
	opposite support L 110mm W 12mm mounting distance 94mm		

## gaskets

## gaskets for heated units

## window seals

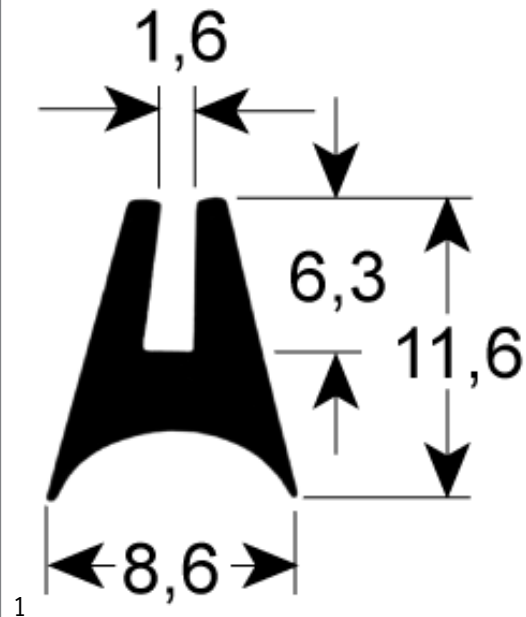

<b>Part No.</b>	902541	<b>Ref. No.</b>	RRC2183-02
<b>description</b>	window gasket profile 1577 L 2100mm Qty 2		

## door seals

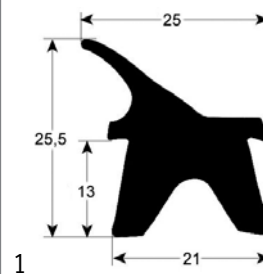

<b>Part No.</b>	900348	<b>Ref. No.</b>	RRC2215-03 RRC22150315MT
<b>description</b>	door seal profile 2402 Qty supplied by meter		

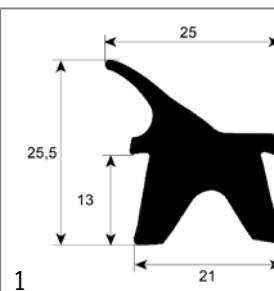

<b>Part No.</b>	901129	<b>Ref. No.</b>	RRC2215-02
<b>description</b>	door seal profile 2402 W 580mm L 765mm Qty 1 4-piece		



<b>Part No.</b>	900417	<b>Ref. No.</b>	RRC5220-00
<b>description</b>	door seal profile 2470 L 2300mm Qty 1		

<b>Part No.</b>	900420	<b>Ref. No.</b>	RRC5221-00
<b>description</b>	door seal profile 2470 L 2850mm Qty 1		

<b>Part No.</b>	900439	<b>Ref. No.</b>	7070166
<b>description</b>	door seal profile 2750 Qty supplied by meter		

### O-rings

EPDM

ø5.34mm

<b>Part No.</b>	510408	<b>Ref. No.</b>	0835534701
<b>description</b>	O-ring EPDM thickness 5.34mm ID ø 47mm Qty 1 pcs		

<b>Part No.</b>	510409	<b>Ref. No.</b>	835535651
<b>description</b>	O-ring EPDM thickness 5.34mm ID ø 56.52mm Qty 1 pcs		

### sealing washers

#### fibre gaskets

<b>Part No.</b>	510404	<b>Ref. No.</b>	953.031.00
<b>description</b>	flat gasket fibre ED ø 44mm ID ø 34mm thickness 2mm Qty 1 pcs		

### shaft gaskets

#### shaft gaskets

<b>Part No.</b>	550549	<b>Ref. No.</b>	7070150
<b>description</b>	shaft sealing for fan motor		

## transmission technology and ball bearings

### ball bearings

#### deep-groove ball bearings 2RS

<b>Part No.</b>	523510	<b>Ref. No.</b>	06501503500
<b>description</b>	deep-groove ball bearing type 6202-2RS shaft ø 15mm ED ø 35mm W 11mm with sealing discs deep-groove ball bearing DIN 625-1		
<b>For models:</b>	70/70BRE, 70/70BRG		

## dosing pumps

### accessories

#### container filters with non-return valve

<b>Part No.</b>	361058	<b>Ref. No.</b>	451.048.00
<b>description</b>	container filter with non-return valve SS hose ø 4x6mm ø 20mm L 56mm		

mechanical components, equipment accessories





## hoses

### supply hoses

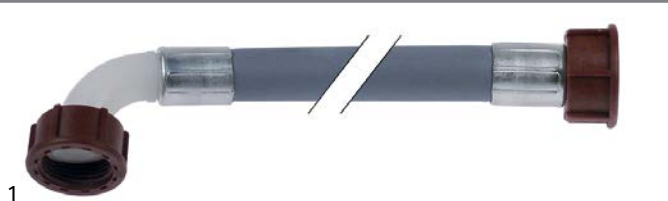
#### PVC supply hoses



1

<b>Part No.</b>	520010	<b>Ref. No.</b>	452.033.00
<b>description</b>	supply hose PVC straight-curved DN13 connections 3/4" L 1500mm operating p. 10bar burst p. 32bar t.max. 90°C blue approval VDE flat seal		
<b>accessories for</b>	520010		
	<b>Part No.</b>	520053	<b>Ref. No.</b> —
<b>description</b>	screen connection 3/4" D1 ø 26mm D2 ø 15mm Qty 10 pcs rubber thickness 8mm		
	<b>Part No.</b>	520054	<b>Ref. No.</b> —
<b>description</b>	flat gasket rubber ED ø 23.5mm ID ø 14mm thickness 2.3mm Qty 10 pcs		

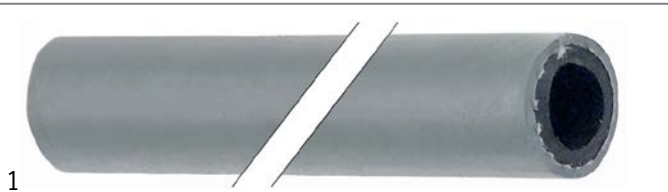

1

<b>Part No.</b>	520016	<b>Ref. No.</b>	452.061.00
<b>description</b>	supply hose ID ø 13mm ED ø 20mm L 40m operating p. 20bar burst p. 60bar t.max. 95°C grey Qty 40m		

## ancillary products

### clamps

#### hose clamps

##### DIN 3017 - W2



1

<b>Part No.</b>	520117	<b>Ref. No.</b>	0620.04060.4
<b>description</b>	hose clamp stainless steel ø 40-60mm width 9mm Qty 5 pcs DIN 3017		

## measuring equipment

### thermometers

#### built-in thermometers

##### ø52mm



1

<b>Part No.</b>	541090	<b>Ref. No.</b>	66103000
<b>description</b>	thermometer mounting ø 52mm t.max. 350°C 0 up to +350°C probe ø 6.5mm probe L 22mm capillary pipe 1450mm		
<b>For models:</b>	65/80BFE, 65/80TFE		

## fastening material

### fasteners

#### clamps

##### hose clamps

##### DIN 3017 - W2



1

<b>Part No.</b>	520117	<b>Ref. No.</b>	0620.04060.4
<b>description</b>	hose clamp stainless steel ø 40-60mm width 9mm Qty 5 pcs DIN 3017		

#### retaining rings

##### DIN 6799



1

<b>Part No.</b>	518557	<b>Ref. No.</b>	0552.05065.4 238.000.00
<b>description</b>	retaining ring E D1 ø 5mm D2 ø 11mm SS DIN 6799 thickness 0.7mm		

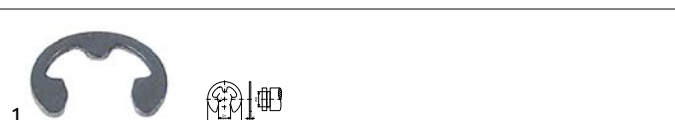

1

<b>Part No.</b>	516198	<b>Ref. No.</b>	0552.06074.4
<b>description</b>	retaining ring E D1 ø 6mm D2 ø 12mm SS DIN 6799 thickness 0.7mm for shaft ø 7-9mm		

**GASTROPARTS.COM**



© 2020 Gastroparts Sp. J. All rights reserved.