



**GASTROPARTS**

# Mareno Ovens

**[EN]** Cooking

**[DE]** Kochtechnik

**[ES]** Cocción

**[FR]** Cuisson

**[IT]** Cottura

**[PL]** Obróbka termiczna

**[RU]** Термическая обработка

✉ [gastroparts@gastroparts.com](mailto:gastroparts@gastroparts.com)

☎ tel. +48 56 657 00 66

📘 [fb.com/gastroparts.global](https://fb.com/gastroparts.global)

**GASTROPARTS.COM**









## heating elements

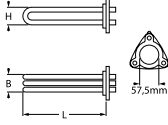

## immersion heating elements

## 3 hole flange ø57.5mm

			
			
<b>Part No.</b>	415021	<b>Ref. No.</b>	1037305500 110349 MA1037305500
<b>description</b>	heating element 6000W 230V mounting ø 57.5mm heating circuits 3 L 343mm W 37mm H 50mm number of thermostat sleeves 1 thermostat sleeves ø 7mm length thermostat sleeves 294mm thermostat sleeve not clinging tube ø 8.5mm hole distance 72mm hole ø 8mm connection M5 3 hole flange		
<b>For models:</b>	DLS30, DLS303, DLS30P, DLS30P3, DLS31, DLS313, DLS31P3, MLC50, MLC503, MLS30, MLS303, MLS30P, MLS30P3, MLS31, MLS313, MLS31P3, MLS35, MLS353, MPLS30P		
<b>spare parts for</b>	415021		
	<b>Part No.</b>	510409	<b>Ref. No.</b> 1036504200 LA70045010 LAR70045010 R70045010
	O-ring EPDM thickness 5.34mm ID ø 56.52mm Qty 1 pcs		
<b>accessories for</b>	415021		
	<b>Part No.</b>	550002	<b>Ref. No.</b> —
	tension strap H 10mm L 21mm W 10mm hole ø 6.5mm for heating element		

## with round flange ø57.5mm

			
<b>Part No.</b>	415849	<b>Ref. No.</b>	R65020420 R65020421
<b>description</b>	heating element 15000W 230V heating circuits 3 mounting ø 57.5mm L 530mm W 45mm H 30mm round flange connection M4 immersion heater tube ø 8.5mm connection length 15mm thermostat sleeves ø 7mm number of thermostat sleeves 1 length thermostat sleeves 272mm thermostat sleeve eccentric, clinging		
<b>For models:</b>	ME102D, ME102M, ME102P, ME102T, ME201D, ME201M, ME201P, ME201T, ME202D, ME202M, ME202P, ME202T, ME220M, ME220P, ME220X, MEC40M, MEMENT20D, MEMENT20P, MEMENT21D, MEMENT21P, MEMENT40D, MEMENT40P		
<b>spare parts for</b>	415849		
	<b>Part No.</b>	550002	<b>Ref. No.</b> —
	tension strap H 10mm L 21mm W 10mm hole ø 6.5mm for heating element		



			
<b>Part No.</b>	415848	<b>Ref. No.</b>	R65020350
<b>description</b>	heating element 7500W 230V heating circuits 3 mounting ø 57.5mm L 365mm W 36mm H 50mm round flange connection M4 immersion heater tube ø 8.5mm thermostat sleeves ø 7.5mm number of thermostat sleeves 1 length thermostat sleeves 270mm thermostat sleeve eccentric, clinging		
<b>For models:</b>	EM010M+SC, EM106H, EM106M, EM106M+SC, EM106P, EM110H, EM110M, EM110M+SC, EM110P, EM210H, EM210M, EM210M+SC, EM210P, ME061D, ME061P, ME061T, ME101D, ME101M, ME101P, ME101T, ME106M, ME106P, ME106X, ME110M, ME110P, ME110X, ME120M, ME120P, ME120X, ME210M, ME210P, ME210X, MEC24H, MEMT06D, MEMT06P, MEMENT10D, MEMENT10P		
<b>accessories for</b>	415848		
	<b>Part No.</b>	550002	<b>Ref. No.</b> —
	tension strap H 10mm L 21mm W 10mm hole ø 6.5mm for heating element		

## heating elements for convection

			
<b>Part No.</b>	415828	<b>Ref. No.</b>	LAR65011310
<b>description</b>	heating element 15000W 230V heating circuits 3 ID ø 388mm ED ø 408mm L 428mm H 132mm L1 20mm W1 105mm H1 114mm H2 18mm flange length 140mm flange width 25mm hole distance 126mm connection M4 connection length 65mm tube ø 8.5mm convection heating element hole ø 6.3mm rectangular flange		
<b>For models:</b>	EC110M, EC210M, EM010M+SC, EM110H, EM110M, EM110M+SC, EM110P, EM210H, EM210M, EM210M+SC, EM210P, EV110H, EV110M, EV110M+SC, EV110P, EV210H, EV210M, EV210M+SC, EV210P, MACE10M, ME101D, ME101M, ME101P, ME101T, ME102D, ME102M, ME102P, ME102T, ME110M, ME110P, ME110X, ME120M, ME120P, ME120X, ME201D, ME201M, ME201P, ME201T, ME202D, ME202M, ME202P, ME202T, ME210M, ME210P, ME210X, ME220M, ME220P, ME220X, MEC24H, MEC40M...(Other models you can see in the webshop)		

			
<b>Part No.</b>	418197	<b>Ref. No.</b>	LAR65011250
<b>description</b>	heating element 15000W 230V heating circuits 3 ID ø 512mm ED ø 530mm L 545mm H 130mm L1 15mm W1 105mm H1 25mm H2 105mm flange length 142mm flange width 25mm hole distance 126mm connection M4 connection length 68mm tube ø 8.5mm convection heating element hole ø 6mm rectangular flange		
<b>For models:</b>	EC210M, EM210H, EM210M, EM210M+SC, EM210P, EV210H, EV210M, EV210M+SC, EV210P, ME102D, ME102M, ME102P, ME102T, ME202D, ME202M, ME202P, ME202T, MEC24H, MEC40M, MEMENT20D, MEMENT20P, MEMENT40D, MEMENT40P, MEVT20D, MEVT20P, MEVT40D, MEVT40P		



<b>Part No.</b>	415966	<b>Ref. No.</b>	1037300200 1037300400 4330700 MA1037300200 MA4330700
<b>description</b>	heating element 2500W 230V heating circuits 1 ID ø 176mm ED ø 188mm L 210mm H 28mm L1 22mm W1 30mm H1 3mm H2 25mm flange length 70mm flange width 22mm hole distance 56mm connection male faston 6.3mm tube ø 6.3mm convection heating element hole ø 5mm rectangular flange		
<b>For models:</b>	CFE60, CFE60P, CFGE60, CFGE61, CFGE61D, CFGE61L, CFGE61P, CFVE60, FOE60M, OFOE60M, SNA12, SNA16, SNA20, SNAC12, SNAC16, SNAC20, SNG08, SNG12, SNG16, SNG20, SVAC16, SVAC20, SVCG08, SVCG12, SVCG16, SVCG20, SVCG8		
<b>spare parts for</b>	415966		
	<b>Part No.</b>	510368	<b>Ref. No.</b> —
	gasket L 70mm W 23.5mm hole ø 5mm hole distance 56mm FIBER thickness 2mm for heating element		
<b>accessories for</b>	415966		
	<b>Part No.</b>	510368	<b>Ref. No.</b> —
	gasket L 70mm W 23.5mm hole ø 5mm hole distance 56mm FIBER thickness 2mm for heating element		

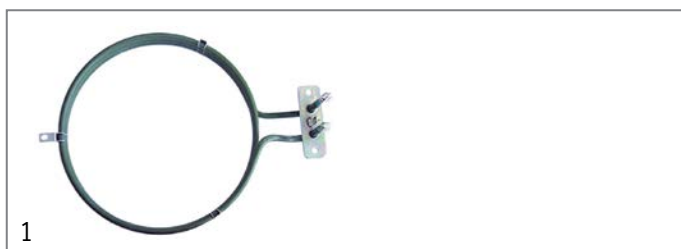

<b>Part No.</b>	415251	<b>Ref. No.</b>	65010200 7800400 LA65010200 LAR65010200 MA7800400
<b>description</b>	heating element 2500W 230V heating circuits 1 ID ø 178mm ED ø 190mm L 242mm H 35mm L1 46mm W1 31mm H1 10mm H2 25mm flange length 70mm flange width 22mm hole distance 56mm connection male faston 6.3mm horizontal tube ø 6.3mm convection heating element hole ø 5mm rectangular flange		
<b>For models:</b>	AC, AR712PA, AR712PP, AR712PS, AR713PA, AR713PP, AR713PS, AR714PA, AR714PP, AR714PS, AR715PA, AR715PP, AR715PS, AR716PA, AR716PP, AR716PS, AR717PA, AR717PP, AR717PS, AR718PA, AR718PP, AR718PS, AR719PA, AR719PP, AR719PS, AR720PA, AR720PP, AR720PS, AU04, AU05, AU08, AU10, AU20, EAR612PA, EAR612PP, EAR612PS, EAR613PA, EAR613PP, EAR613PS, EAR614PA, EAR614PP, EAR614PS, EAR615PA, EAR615PP, EAR615PS, EAR616PA, EAR616PP, EAR616PS, EAR617PA, EAR617PP...(Other models you can see in the webshop)		
<b>spare parts for</b>	415251		
	<b>Part No.</b>	510368	<b>Ref. No.</b> —
	gasket L 70mm W 23.5mm hole ø 5mm hole distance 56mm FIBER thickness 2mm for heating element		



<b>Part No.</b>	415845	<b>Ref. No.</b>	R65010320
<b>description</b>	heating element 3150W 230V heating circuits 3 ID ø 201mm ED ø 215mm L 272mm H 35mm L1 57mm W1 60mm H1 8mm H2 27mm flange length 95mm flange width 22mm hole distance 77mm connection male faston 6.3mm connection length 20mm tube ø 6.5mm convection heating element hole ø 6mm rectangular flange		
<b>For models:</b>	CVE004H, CVE004M, MACE04M, MVE042P, VE004M, VE004X		

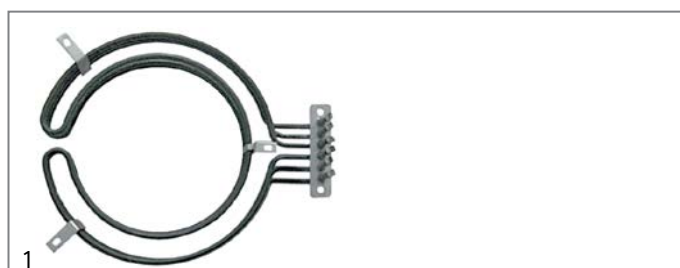

<b>Part No.</b>	415855	<b>Ref. No.</b>	R65010450
<b>description</b>	heating element 3900W 230V heating circuits 3 ID ø 176mm ED ø 244mm L 282mm H 43mm L1 38mm W1 61mm H1 13mm H2 30mm flange length 92mm flange width 22mm hole distance 78mm connection male faston 6.3mm connection length 60mm tube ø 6.3mm convection heating element hole ø 6.3mm rectangular flange		
<b>For models:</b>	CVE104H, CVE104M, VE104M, VE104X		





<b>Part No.</b>	418196	<b>Ref. No.</b>	R65011530
<b>description</b>	heating element 6000W 230V heating circuits 3 ID ø 215mm ED ø 228mm L 266mm H 78mm L1 38mm W1 102mm H1 10mm H2 68mm flange length 142mm flange width 25mm hole distance 57mm connection M4 connection length 66mm tube ø 6.3mm convection heating element hole ø 6mm rectangular flange		
<b>For models:</b>	MACE05M, MVE051P		





<b>Part No.</b>	415871	<b>Ref. No.</b>	R65011520
<b>description</b>	heating element 6000W 230V heating circuits 3 ID ø 217mm ED ø 230mm L 267mm H 75mm L1 38mm W1 103mm H1 65mm H2 10mm flange length 140mm flange width 23mm hole distance 67mm connection M4 connection length 25mm tube ø 6.5mm convection heating element hole ø 5mm rectangular flange		
<b>For models:</b>	CVE105H, CVE105M, MVE042P, VE105M, VE105X		





			
1			
<b>Part No.</b>	415993	<b>Ref. No.</b>	R65010680
<b>description</b>	heating element 7200W 230V heating circuits 3 ID $\phi$ 215mm ED $\phi$ 230mm L 270mm H 78mm L1 30mm W1 102mm H1 10mm H2 68mm flange length 140mm flange width 22mm hole distance 63mm connection M4 connection length 65mm tube $\phi$ 6.3mm convection heating element hole $\phi$ 5mm rectangular flange		
<b>For models:</b>	FE105M, FE105X, PE040M, PE040X		

			
1			
<b>Part No.</b>	415829	<b>Ref. No.</b>	R65011540
<b>description</b>	heating element 7500W 230V heating circuits 3 ID $\phi$ 248mm ED $\phi$ 260mm L 287mm H 88mm L1 20mm W1 105mm H1 23mm H2 65mm flange length 142mm flange width 25mm hole distance 64mm connection M4 connection length 78mm convection heating element hole $\phi$ 5mm rectangular flange		
<b>For models:</b>	EC106M, EM106H, EM106M, EM106M+SC, EM106P, EV006M, EV106H, EV106M, EV106M+SC, EV106P, MACE07M, ME061D, ME061P, ME061T, ME106M, ME106P, ME106X, MEMT06D, MEMT06P, MEVT06D, MEVT06P, VE106M, VE106P, VE106X		
<b>accessories for</b>	415829		
		<b>Part No.</b>	531270
		<b>Ref. No.</b>	—
	gasket L 141mm W 22mm D1 $\phi$ 10mm D2 $\phi$ 9mm 9 holes graphite thickness 1mm suitable for UNOX		

			
1			
<b>Part No.</b>	415827	<b>Ref. No.</b>	R65011210
<b>description</b>	heating element 9000W 230V heating circuits 3 ID $\phi$ 508mm ED $\phi$ 526mm L 550mm H 122mm L1 24mm W1 105mm H1 26mm H2 96mm flange length 140mm flange width 25mm hole distance 126mm connection M4 connection length 68mm tube $\phi$ 9mm convection heating element hole $\phi$ 6.3mm rectangular flange		
<b>For models:</b>	ME210M, ME210P, ME210X, ME220M, ME220P, ME220X, VE210M, VE210P, VE210X, VE220M, VE220P, VE220X		

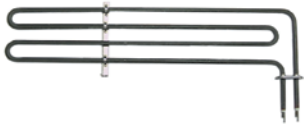
			
1			
<b>Part No.</b>	415737	<b>Ref. No.</b>	R65010180
<b>description</b>	heating element 2500W 230V heating circuits 1 L 655mm W 120mm L1 30mm L2 625mm W2 90mm flange length 70mm flange width 22mm hole distance 56mm connection length 100mm connection M4 tube $\phi$ 6.3mm hole $\phi$ 5.5mm W1 30mm rectangular flange convection heating element windings 2		
<b>For models:</b>	FE110M, FE110X, PE080M, PE080X		

			
1			
<b>Part No.</b>	415998	<b>Ref. No.</b>	5152100 MA5152100
<b>description</b>	heating element 3000W 400V heating circuits 1 L 513mm W 120mm L1 33mm L2 480mm W2 100mm flange length 50mm flange width 26mm connection M4 tube $\phi$ 8.5mm hole $\phi$ 6mm W1 20mm compression flange convection heating element		
<b>For models:</b>	CON10E, CON10EP, CON201E, CON201EP, CSM102E, CSM102EP, CSM10E, CSM10EP, CSM201E, CSM201EP		

			
1			
<b>Part No.</b>	415736	<b>Ref. No.</b>	R65010390
<b>description</b>	heating element 3500W 230V heating circuits 1 L 655mm W 125mm L1 30mm L2 625mm W2 88mm flange length 70mm flange width 22mm hole distance 56mm connection length 97mm connection M4 tube $\phi$ 6.25mm hole $\phi$ 5mm W1 30mm rectangular flange convection heating element windings 2 mounting distance 58mm		
<b>For models:</b>	FE210M		

## accessories

## washers

			
1			
<b>Part No.</b>	560112	<b>Ref. No.</b>	15830499 MA15830499
<b>description</b>	plain washer ID $\phi$ 5.3mm ED $\phi$ 10mm thickness 1mm SS Qty 20 pcs DIN 125A for thread M5		
<b>For models:</b>	BR707E, BR707EI, BR707G, BR707GI, BR94E, BR94EI, BR94G, BR94GI, BR96E, BR96EI, BR96G, BR96GI, BR9M4E, BR9M4EI, BR9M4G, BR9M4GI, BR9M6E, BR9M6EI, BR9M6G, BR9M6GI, BR9SB4E, BR9SB4EI, BR9SB4G, BR9SB4GI, EPC74E, EPC74G, PC12C4E, PC12C4G, PC12C9E, PC12C9G, PC74E, PC74G, PC76E, PC76G, PC78E, PC78G, PC94E, PC94G, PC96E, PC96G, PC98E, PC98G, PD707G, PI707E, PI707G, SER15, SER15A, SER18, SER18A, SER21		





sealing washers			
fibre gaskets			
1			
<b>Part No.</b>	510404	<b>Ref. No.</b>	CR0682770
<b>description</b>	flat gasket fibre ED ø 44mm ID ø 34mm thickness 2mm Qty 1 pcs		
<b>For models:</b>	NPI76E5, NPI76G5, NPI78E8, NPI78G8, NPI96E5, NPI96G5, NPI98E10, NPI98E15, NPI98G10, NPI98G14, NPI98G14A		

O-rings			
1			
<b>Part No.</b>	505092	<b>Ref. No.</b>	2604100 BN0119472130 MA2604100
<b>description</b>	O-ring EPDM thickness 5.34mm ID ø 43.82mm Qty 1 pcs		
<b>For models:</b>	CS102E, CS102EP, CS10E, CS10EP, CS6E, CS6EP, FV4E, FV4E1, P9I5E, P1707E, P176E5, P196E5, P198E10, P198E15, P19S8E10		

1			
<b>Part No.</b>	510408	<b>Ref. No.</b>	200820 BN0118462630
<b>description</b>	O-ring EPDM thickness 5.34mm ID ø 47mm Qty 1 pcs		

## energy regulators

### EGO

#### 1-circuit

1			
<b>Part No.</b>	380015	<b>Ref. No.</b>	1037035310 1037110113 426710 65080250 MA1037110113
<b>description</b>	energy regulator 230V 13A single-circuit turn direction right shaft ø 6x4.6mm shaft L 23mm mounting thread M4 power release 6-100% no. 50.57021.010		
<b>For models:</b>	CFVE60, CON102E, CON102EP, CON102G, CON102GP, CON10E, CON10EP, CON10G, CON10GP, CON201E, CON201EP, CON201G, CON201GP, CON202E, CON202EP, CON202G, CON202GP, CON6E, CON6EP, CON6G, CON6GP, CP704E, CP92E, CP92E2, CP94E, CP94E2, CP9SB2E, CP9SB2E2, CP9SB4E, CP9SB4E2, CPE60, CRE6220, CRE6230, CRE6320, CRE6330, CS102E, CS102EP, CS102G, CS102GP, CS10E, CS10EP, CS10G, CS6E, CS6EP, CS6G, CWE42, CWE62, FC10E, FC10G, FC20E...(Other models you can see in the webshop)		

## thermostats

### control and safety thermostats

#### EGO

#### control thermostats

#### 55.10/19\_ series

1			
<b>Part No.</b>	390067	<b>Ref. No.</b>	27097700
<b>description</b>	thermostat t.max. 266°C temperature range 65-266°C 1-pole 1NO 16A probe ø 3mm probe L 219mm capillary pipe 900mm capillary pipe isolatedmm gland nut shaft ø 6x4.6mm shaft L 23mm shaft position upper° rotation 270° probe material SS		

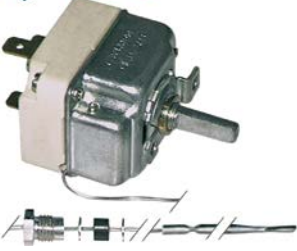

			
			
<b>Part No.</b>	390068	<b>Ref. No.</b>	2709700 2709714
<b>description</b>	thermostat t.max. 269°C temperature range 55-269°C 1-pole 1C0 16A probe ø 3.1mm probe L 219mm capillary pipe 1280mm capillary pipe isolated 1270mm gland nut shaft ø 6x4.6mm shaft L 23mm shaft position upper° rotation 318°		

			
			
<b>Part No.</b>	375201	<b>Ref. No.</b>	2992900 MA2992900
<b>description</b>	thermostat t.max. 270°C temperature range 50-270°C 1-pole 1C0 16A probe ø 3mm probe L 219mm capillary pipe 3000mm capillary pipe isolated 2500mm gland nut M10x1 shaft L 23mm shaft position upper rotation 270° probe material SS		
<b>For models:</b>	CON102E, CON102EP, CON102G, CON102GP, CON10E, CON10EP, CON10G, CON10GP, CON201E, CON201EP, CON201G, CON201GP, CON202E, CON202EP, CON202G, CON202GP, CON6E, CON6EP, CON6G, CON6GP, CSM102E, CSM102EP, CSM102G, CSM102GP, CSM10E, CSM10EP, CSM10G, CSM10GP, CSM201, CSM201E, CSM201EP, CSM201G, CSM201GP, CSM202, CSM202E, CSM202EP, CSM202G, CSM202GP, CSM6E, CSM6EP, CSM6G, CSM6GP		

			
			
<b>Part No.</b>	375216	<b>Ref. No.</b>	LA65070210 LAR65070210
<b>description</b>	thermostat t.max. 280°C temperature range 50-280°C 1-pole 1N0 16A probe ø 3mm probe L 228mm capillary pipe 1300mm capillary pipe isolated 1150mm gland nut shaft L 23mm shaft position upper rotation 318°		
<b>For models:</b>	CVE004M, CVE104M, CVE105M, CVG105M, EC106M, EC110M, EC210M, EM010M+SC, EM106M, EM106M+SC, EM110M, EM110M+SC, EM210M, EM210M+SC, EV006M, EV106M, EV106M+SC, EV110M, EV-110M+SC, EV210M, EV210M+SC, FE105M, FE105X, FE110M, FE110X, FE210M, FG105M, FG105X, FG110M, FG110X, FG210M, FG210X, GC106M, GC110M, GC210M, GM106M, GM106M+SC, GM110M, GM110M+SC, GM210M, GM210M+SC, GV106M, GV106M+SC, GV110M, GV110M+SC, GV210M, GV210M+SC, ME106M, ME106X, ME110M...(Other models you can see in the webshop)		

			
			
<b>Part No.</b>	375184	<b>Ref. No.</b>	1037102300 MA1037102300
<b>description</b>	thermostat t.max. 298°C temperature range 55-294°C 1-pole 1N0 16A probe ø 3.1mm probe L 226mm capillary pipe 870mm capillary pipe isolated 350mm gland nut shaft L 23mm shaft position upper probe material SS		
<b>For models:</b>	BR707E, BR707EI, BR78EF, BR78EI, BR912EFM, BR912EIM, BR912GFM, BR912GIM, BR94E, BR94EI, BR94G, BR94GI, BR94GI, BR98EF, BR98EFM, BR98EI, BR98EIM, BR98GF, BR98GFM, BR98GI, BR98GIM, BR9M4E, BR9M4EI, BR9M4G, BR9M4GI, BR9M6E, BR9M6EI, BR9M6G, BR9M6GI, BR9S8EF, BR9S8EI, BR9S8GF, BR9S8GI, BR9SB4E, BR9SB4EI, BR9SB4G, BR9SB4GI, CFE60, CFE60P, CFGE60, CFGE61, CFGE61D, CFGE61L, CFGE61P, CFVE60, FOE60M, MS10AG, MS10IG, MS70AG, MS70IG, MS70IGS... (Other models you can see in the webshop)		

			
			
<b>Part No.</b>	375667	<b>Ref. No.</b>	R65070360
<b>description</b>	thermostat t.max. 300°C temperature range 68-300°C 1-pole 1N0 16A probe ø 3.1mm probe L 226mm capillary pipe 980mm capillary pipe isolated 980mm gland nut shaft ø 6x4.6mm shaft L 23mm shaft position upper rotation 318°		
<b>For models:</b>	MACE04M, MACE05M, MACE07M, MACE10M, MACE20M, MACG05M, MACG07M, MACG10M, MACG20M, ME061M, ME101M, ME102M, ME201M, ME202M, MG061M, MG101M, MG102M, MG201M, MG202M		

			
			
<b>Part No.</b>	375945	<b>Ref. No.</b>	CRO734520
<b>description</b>	thermostat t.max. 470°C temperature range 90-470°C 1-pole 1N0 16A probe ø 3.9mm probe L 163mm capillary pipe 870mm capillary pipe isolated 600mm shaft ø 4.5x6mm shaft L 23mm shaft position upper rotation 270°		
<b>For models:</b>	NCT78E, NCT7FE8E, NCT98E, NCT98E2, NCT9FE8E, NCT9FE8E2		



<b>Part No.</b>	375332	<b>Ref. No.</b>	MA1037118000
<b>description</b>	thermostat t.max. 55°C temperature range fixed 55°C 1-pole 1CO 16A probe ø 9/15mm probe L 22mm capillary pipe 1500mm capillary pipe isolated 800mm gland nut		



<b>Part No.</b>	375217	<b>Ref. No.</b>	R65070240
<b>description</b>	thermostat t.max. 70°C temperature range fixed 70°C 1-pole 1CO 16A probe ø 6mm probe L 130mm capillary pipe 900mm capillary pipe isolated 900mm gland nut shaft Lmm shaft position probe material SS		
<b>For models:</b>	CVE004M, CVE104M, CVE105M, CVG105M, EM010M+SC, EM106M, EM106M+SC, EM110M, EM110M+SC, EM210M, EM210M+SC, EV006M, EV106M, EV106M+SC, EV110M, EV110M+SC, EV210M, EV-210M+SC, GM106M, GM106M+SC, GM110M, GM110M+SC, GM210M, GM210M+SC, GV106M, GV106M+SC, GV110M, GV110M+SC, GV210M, GV210M+SC, ME061M, ME101M, ME102D, ME102M, ME106M, ME106X, ME110M, ME110X, ME120M, ME120X, ME201M, ME202M, ME210M, ME210X, ME220M, ME220X, MEC40M, MG061M, MG101M, MG102M...(Other models you can see in the webshop)		



<b>Part No.</b>	375219	<b>Ref. No.</b>	R65070100
<b>description</b>	thermostat t.max. 55°C temperature range fixed 55°C 1-pole 1NO 16A probe ø 6mm probe L 130mm capillary pipe 900mm capillary pipe isolated 850mm gland nut shaft Lmm shaft position probe material SS		
<b>For models:</b>	EM010M+SC, EM106M, EM106M+SC, EM110M, EM110M+SC, EM210M, EM210M+SC, GM106M, GM106M+SC, GM110M, GM110M+SC, GM210M, GM210M+SC, ME061M, ME101M, ME102D, ME102M, ME106M, ME106X, ME110M, ME110X, ME120M, ME120X, ME201M, ME202M, ME210M, ME210X, ME220M, ME220X, MEC40M, MG061M, MG101M, MG102M, MG106M, MG106X, MG110M, MG110X, MG120M, MG120X, MG201M, MG202M, MG210M, MG210X, MG220M, MG220X, MGC20X		
<b>accessories for</b>	375219		
	<b>Part No.</b>	<b>Ref. No.</b>	—
	gland duct ET M12x0.75 IT M9x1 probe ø max. 6.5mm WS 17 silicone		

55.13\_ series



<b>Part No.</b>	375505	<b>Ref. No.</b>	643800 MA643800
<b>description</b>	thermostat t.max. 320°C temperature range 50-320°C 1-pole 1NO 16A probe ø 3mm probe L 160mm capillary pipe 870mm capillary pipe isolatedmm gland nut shaft ø 6x4.6mm shaft L 23mm shaft position upper rotation 270°		
<b>For models:</b>	BR94E, BR94EI, BR94G, BR94GI, BR96G, BR96GI, BR9M4E, BR9M4EI, BR9M4G, BR9M4GI, BR9M6E, BR9M6EI, BR9M6G, BR9M6GI, BR9SB4E, BR9SB4EI		



<b>Part No.</b>	375215	<b>Ref. No.</b>	R65070165
<b>description</b>	thermostat t.max. 65°C temperature range fixed 65°C 1-pole 1CO 16A probe ø 6mm probe L 130mm capillary pipe 900mm capillary pipe isolated 900mm gland nut shaft Lmm shaft position		
<b>For models:</b>	CVE004M, CVE104M, CVE105M, CVG105M, EM010M+SC, EM106M, EM106M+SC, EM110M, EM110M+SC, EM210M, EM210M+SC, EV006M, EV106M, EV106M+SC, EV110M, EV110M+SC, EV210M, EV-210M+SC, GM106M, GM106M+SC, GM110M, GM110M+SC, GM210M, GM210M+SC, GV106M, GV106M+SC, GV110M, GV110M+SC, GV210M, GV210M+SC, ME061M, ME101M, ME102D, ME102M, ME106M, ME106X, ME110M, ME110X, ME120M, ME120X, ME201M, ME202M, ME210M, ME210X, ME220M, ME220X, MEC40M, MG061M, MG101M, MG102M...(Other models you can see in the webshop)		



## 55.34\_ series

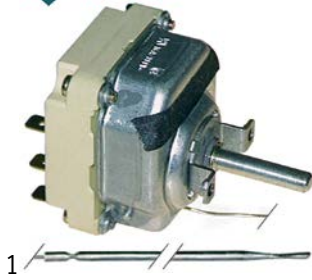

<b>Part No.</b>	375183	<b>Ref. No.</b>	1037100600 MA1037100600
<b>description</b>	thermostat t.max. 298°C temperature range 50-298°C 3-pole 3NO 16A probe ø 3mm probe L 219mm capillary pipe 900mm capillary pipe isolatedmm gland nut shaft ø 6x4.6mm shaft L 23mm shaft position upper rotation 318°		
<b>For models:</b>	FTE100B, FTE100BR, FTE100CRL, FTE40B, FTE40C, FTE60B, FTE60BR, FTE60C		

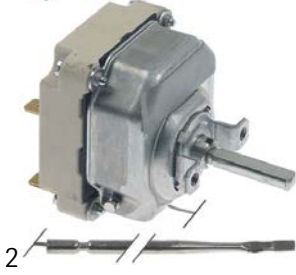

<b>Part No.</b>	375192	<b>Ref. No.</b>	1309100 1309115 MA1309115
<b>description</b>	thermostat t.max. 300°C temperature range 50-300°C 3-pole 3NO 16A probe ø 3mm probe L 219mm capillary pipe 900mm capillary pipe isolatedmm gland nut shaft ø 6x4.6mm shaft L 23mm shaft position upper rotation 270°		
<b>For models:</b>	BF78E, BF98E, BIE40, BIE40B, BIE60, BIE60B, BR707E, BR707EI, BR94E, BR94EI, BR96E, BR96EI, BR9M4E, BR9M4EI, BR9M6E, BR9M6EI, BRE40, BRE40D, BRE40DB, BRE40DG, BRE40DGB, BRE40G, C12FEP9G, C7011EFE, C7011EFEQ, C707EFE, C707EFEQ, C7FE12G, C7FE8E, C7FE8EC, C7FE8G, C9F4E, C9F6E, C9FE12G, C9FE6GS, C9FE8E, C9FE8EC, C9FE8G, C9V2E, C9V4E, CFE70, CWE42, CWE422, CWE62, CWE622, EC74EVG, EC78EVG, EC7FE8E, EFT74ELVG, EFT74ERVG... (Other models you can see in the webshop)		



<b>Part No.</b>	375412	<b>Ref. No.</b>	1037035200 1732000 BN6A044600 MA1037035200 MA1732000 No More Available
<b>description</b>	thermostat t.max. 320°C temperature range 50-320°C 3-pole 3NO 16A probe ø 3.1mm probe L 226mm capillary pipe 1480mm capillary pipe isolated 1400mm gland nut shaft ø 6x4.6mm shaft L 23mm shaft position upper rotation 318°		
<b>For models:</b>	BIE40, BIE60, BRE40, BRE40G, FT74E, FT74ER, FT74ERL, FT77E, FT77EC, FT77ERL, FTE100B, FTE100BR, FTE100CRL, FTE40B, FTE40C, FTE60B, FTE60BR, FTE60C		

## safety thermostats

## 55.32\_ series



<b>Part No.</b>	375394	<b>Ref. No.</b>	2613300 MA2613300
<b>description</b>	safety thermostat switch-off temp. 135°C 3-pole 1CO/2NC 20A probe ø 6mm probe L 73mm capillary pipe 1490mm capillary pipe isolated 1350mm gland nut M9x1 probe SS		
<b>For models:</b>	CS4E, CS4EP, FV4E, FV4E1		

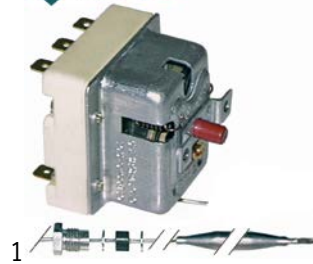

<b>Part No.</b>	375208	<b>Ref. No.</b>	2865100 MA2865100
<b>description</b>	safety thermostat switch-off temp. 139°C 3-pole 2x20/1x0.5A probe ø 6mm probe L 77mm capillary pipe 890mm capillary pipe isolatedmm gland nut M9x1 probe SS		
<b>For models:</b>	CS102E, CS102EP, CS102G, CS102GP, CS10E, CS10EP, CS10G, CS6E, CS6EP, CS6G, CSM102E, CSM102EP, CSM102G, CSM102GP, CSM10E, CSM10EP, CSM10G, CSM10GP, CSM201E, CSM201EP, CSM201G, CSM201GP, CSM202E, CSM202EP, CSM202G, CSM202GP, CSM6E, CSM6EP, CSM6G, CSM6GP		



1 

<b>Part No.</b>	375668	<b>Ref. No.</b>	R65070020
<b>description</b>	safety thermostat switch-off temp. 140°C 3-pole 20A probe ø 6mm probe L 88mm capillary pipe 890mm capillary pipe isolated 800mm gland nut		
<b>For models:</b>	AC, AU04, AU05, AU08, AU10, AU20		



1 

<b>Part No.</b>	375206	<b>Ref. No.</b>	2864714 MA2864714
<b>description</b>	safety thermostat switch-off temp. 325°C 3-pole 20A probe ø 3.1mm probe L 188mm capillary pipe 900mm capillary pipe isolated 700mm gland nut M10x1 probe SS		
<b>For models:</b>	CON102E, CON102EP, CON102G, CON102GP, CON10E, CON10EP, CON10G, CON10GP, CON201E, CON201EP, CON201G, CON201GP, CON202E, CON202EP, CON202G, CON202GP, CON6E, CON6EP, CON6G, CON6GP, CS102E, CS102EP, CS102G, CS102GP, CS10E, CS10G, CS4E, CS4EP, CS6E, CS6G, CSM102E, CSM102EP, CSM102G, CSM102GP, CSM10E, CSM10EP, CSM10G, CSM10GP, CSM201E, CSM201EP, CSM201G, CSM201GP, CSM202E, CSM202EP, CSM202G, CSM202GP, CSM6E, CSM6EP, CSM6G, CSM6GP...(Other models you can see in the webshop)		



1 

<b>Part No.</b>	375209	<b>Ref. No.</b>	1037305000
<b>description</b>	safety thermostat switch-off temp. 140°C 3-pole 20A probe ø 6mm probe L 89mm capillary pipe 900mm capillary pipe isolated 900mm gland nut probe SS		
<b>For models:</b>	DLS30, DLS303, DLS30P, DLS30P3, DLS31, DLS313, DLS31P3, MLC50, MLC503, MLC65, MLC653, MLS30, MLS303, MLS30P, MLS30P3, MLS31, MLS313, MLS31P3, MLS35, MLS353, MPLS30P		



1 

<b>Part No.</b>	375220	<b>Ref. No.</b>	R65070050
<b>description</b>	safety thermostat switch-off temp. 330°C 3-pole 20A probe ø 11mm probe L 18.5mm capillary pipe 900mm capillary pipe isolated 900mm gland nut probe screw-in probe probe thread M14x1		
<b>For models:</b>	CVE004H, CVE004M, CVE104H, CVE104M, VE004M, VE004X, VE104M, VE104X		



1 

<b>Part No.</b>	390159	<b>Ref. No.</b>	R65070080 R65070081
<b>description</b>	safety thermostat switch-off temp. 150°C 1-pole 20A probe ø 6mm probe L 89mm capillary pipe 900mm capillary pipe isolated 800mm gland nut probe		
<b>For models:</b>	EM010M+SC, EM106H, EM106M, EM106M+SC, EM106P, EM110H, EM110M, EM110M+SC, EM110P, EM210H, EM210M, EM210M+SC, EM210P, GM106H, GM106M, GM106M+SC, GM106P, GM110H, GM110M, GM110M+SC, GM110P, GM210H, GM210M, GM210M+SC, GM210P, GMT06D, GMT20D, ME061D, ME061M, ME061P, ME061T, ME101D, ME101M, ME101P, ME101T, ME102D, ME102M, ME102P, ME102T, ME106M, ME106P, ME106X, ME110M, ME110P, ME110X, ME120M, ME120P, ME120X, ME201D, ME201M...(Other models you can see in the webshop)		



1 

<b>Part No.</b>	375291	<b>Ref. No.</b>	R65070060
<b>description</b>	safety thermostat switch-off temp. 344°C 1-pole 20A probe ø 6mm probe L 79mm capillary pipe 900mm capillary pipe isolated 900mm gland nut probe		
<b>For models:</b>	FE105M, FE105X, FE110M, FE110X, FE210M, FE210X, FG105M, FG105X, FG110M, FG110X, FG210M, FG210X, PE040M, PE040X, PE080M, PE080X, PG040M, PG040X, PG080M, PG080X		





E-G-O



1

<b>Part No.</b>	375455	<b>Ref. No.</b>	R65070070
<b>description</b>	safety thermostat switch-off temp. 350°C 1-pole 16A probe $\varnothing$ 11mm probe L 16mm capillary pipe 900mm capillary pipe isolated 900mm gland nut probe screw-in probe probe thread M14x1		
<b>For models:</b>	CVE105H, CVE105M, CVG105H, CVG105M, EC106M, EC110M, EC210M, EM010M+SC, EM106H, EM106M, EM106M+SC, EM106P, EM110H, EM110M, EM110M+SC, EM110P, EM210H, EM210M, EM210M+SC, EM210P, EV006M, EV106H, EV106M, EV106M+SC, EV106P, EV110H, EV110M, EV110M+SC, EV110P, EV210H, EV210M, EV210M+SC, EV210P, GC106M, GC110M, GC210M, GM106H, GM106M, GM106M+SC, GM106P, GM110H, GM110M, GM110M+SC, GM110P, GM210H, GM210M, GM210M+SC, GM210P, GV106H, GV106M...(Other models you can see in the webshop)		

E-G-O

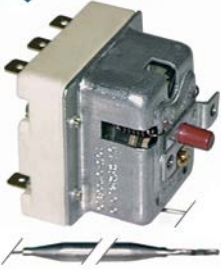

1

<b>Part No.</b>	375163	<b>Ref. No.</b>	1475513
<b>description</b>	safety thermostat switch-off temp. 350°C 3-pole 0.5A probe $\varnothing$ 6mm probe L 79mm capillary pipe 3000mm capillary pipe isolated 2800mm gland nut probe SS		
<b>For models:</b>	F9V4EC, F9V4ECR, FT74E, FT74ER, FT74ERL, FT77E, FT77EC		

E-G-O



1

<b>Part No.</b>	375684	<b>Ref. No.</b>	LA65070350 LAR65070350
<b>description</b>	safety thermostat switch-off temp. 360°C 1-pole 20A probe $\varnothing$ 11mm probe L 16mm capillary pipe 900mm capillary pipe isolated 900mm gland nut probe screw-in probe probe thread M14x1		
<b>For models:</b>	GMT06D, GMT20D, GVT06D, GVT20D, MACE04M, MACE05M, MACE07M, MACE10M, MACE20M, MACG05M, MACG07M, MACG10M, MACG20M, ME061D, ME061M, ME061P, ME061T, ME101D, ME101M, ME101P, ME101T, ME102D, ME102M, ME102P, ME102T, ME201D, ME201M, ME201P, ME201T, ME202D, ME202M, ME202P, ME202T, MEMT06D, MEMT06P, MEMT10D, MEMT10P, MEMT20D, MEMT20P, MEMT21D, MEMT21P, MEMT40D, MEMT40P, MEVT06D, MEVT06P, MEVT10D, MEVT10P, MEVT20D, MEVT20P, MEVT21D...(Other models you can see in the webshop)		

## control thermostats with operation switch

55.34\_ series

E-G-O



1



<b>Part No.</b>	375140	<b>Ref. No.</b>	21351299 CR0688650
<b>description</b>	thermostat t.max. 650°C temperature range 50°C/50-600°C/70-650°C 3-pole 3NO 16A probe $\varnothing$ 4mm probe L 228mm capillary pipe 1200mm capillary pipe isolated 1200mm gland nut shaft $\varnothing$ 6x4.6mm shaft L 23mm shaft position left rotation 318° outer switch 2NO		
<b>For models:</b>	NV94E, NV98E, NV9FE8E, V9F4E, V9V2E, V9V4E		

## IMIT / TEMPOMATIC / ARTERMO

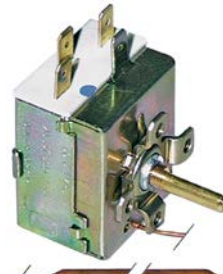
## control thermostats



1

<b>Part No.</b>	390006	<b>Ref. No.</b>	120501
<b>description</b>	thermostat t.max. 86°C temperature range 0-86°C 1-pole 1CO 16A probe $\varnothing$ 6.5mm probe L 95mm capillary pipe 1500mm capillary pipe isolatedmm gland nut shaft $\varnothing$ 6x4.6mm shaft L 19mm rotation 270°		
<b>accessories for</b>	390006		
	<b>Part No.</b>	110100	<b>Ref. No.</b> 450315
	knob thermostat t.max. 90°C 0-90°C $\varnothing$ 42mm shaft $\varnothing$ 6x4.6mm shaft flat -135° black		
	<b>Part No.</b>	110105	<b>Ref. No.</b> —
	rosette knob $\varnothing$ 42mm $\varnothing$ 56mm zero mark		

## accessories

## gland nut accessories

## bolts with slot







1

<b>Part No.</b>	520244	<b>Ref. No.</b>	1570200 MA1570200
<b>description</b>	bolt with slot thread M10x1 Qty 10 pcs nickel-plated brass		







			
1			
<b>Part No.</b>	520243	<b>Ref. No.</b>	CR0500550
<b>description</b>	bolt with slot thread M9x1 Qty 10 pcs nickel-plated brass		
<b>accessories for</b>	520243		
	<b>Part No.</b>	510591	<b>Ref. No.</b> —
	washer with slot ED ø 8.8mm slit width 1.2mm Qty 10		
	<b>Part No.</b>	510592	<b>Ref. No.</b> —
	gasket ø 8x8.7mm Qty 10 pcs slotted silicone		



connecting bows			
			
1			
<b>Part No.</b>	550060	<b>Ref. No.</b>	1037003300 1037033300 1988500 1998500 921200 MA1988500 MA921200
<b>description</b>	connecting bow long for thermostat Qty 1 pcs		
<b>For models:</b>	AR712PA, AR712PP, AR712PS, AR713PA, AR713PP, AR713PS, AR-714PA, AR714PP, AR714PS, AR715PA, AR715PP, AR715PS, AR716PA, AR716PP, AR716PS, AR717PA, AR717PP, AR717PS, AR718PA, AR718PP, AR718PS, AR719PA, AR719PP, AR719PS, AR720PA, AR720PP, AR720PS, B9SB2E, B9SB2G, B9SB4E, B9SB4G, B9V2E, B9V2G, B9V4E, B9V4G, BIE40, BIE40B, BIE60, BIE60B, BM74E, BM77E, BME40DM, BME40D, MB, BME40M, BME60, BME602, BME60DM, BME60DMB, BME60M, BME80M...(Other models you can see in the webshop)		



## switches and momentary switches

### rocker/momentary rocker switches



30x22mm			
			
1			
<b>Part No.</b>	347791	<b>Ref. No.</b>	4640500 MA4640500
<b>description</b>	rocker switch mounting measurements 30x22mm green 2NO 230V 20A illuminated 0-I connection male faston 6.3mm ambient temperature max. 125/55°C protection IP65 with rubber collar		
<b>For models:</b>	B124E, CRE6220, CRE6230, CRE6320, CRE6330, CSP6220, CSP6230, EF140DF, EF140DN, EF140DP, EF140MB, EF140MC, EF140MF, EF140MI, EF140MN, EF140MP, EF143DNF, EF143MNI, EF70DF, EF70DN, EF70DP, EF70MB, EF70MC, EF70MF, EF70MI, EF70MN, EF70MP, EF72DNF, EF72MNF, F140DF, F140DI, F140DN, F140DP, F14DFG, F14DNG, F70DF, F70DI, F70DN, F70DP, F7DFG, F7DNG, HF140DPF, IR13C, IR13CC, IR13CV, IR13M, IR13MC, IR13MV, IR13V, IR17C...(Other models you can see in the webshop)		

			
1			
<b>Part No.</b>	301003	<b>Ref. No.</b>	0109015 211101.99
<b>description</b>	rocker switch mounting measurements 30x22mm green 2NO 250V 16A illuminated 0-I connection male faston 6.3mm ambient temperature max. 125/55°C protection IP65		
<b>For models:</b>	AF140MB, AF140MC, AF140MF, AF140MI, AF140MN, AF140MP, AF-70MB, AF70MC, AF70MF, AF70MI, AF70MN, AF70MP, AFC14, AFC14V, AFC7, AFC7V, AFCP214, AFCP214P, AFCP214V, AFR1143P, AFR14, AFR14V, AFR214P, AFR214PV, AFR7, AFR7P, AFR7PV, AFR7V, AFRC214, AFRC214V, AFRV14, AFRV14A, AFRV14V, AFRV7, AFRV74A, AFRV7V, C9F6E, C9FE6GS, EF140MB, EF140MC, EF140MF, EF140MI, EF140MN, EF140MP, EF143MNI, EF70MB, EF70MC, EF70MF, EF70MI, EF70MN...(Other models you can see in the webshop)		
<b>accessories for</b>	301003		
	<b>Part No.</b>	301036	<b>Ref. No.</b> —
	protective cover internal size 30x22mm for rocker switch mounting measurementsmm		



			
1			
<b>Part No.</b>	301017	<b>Ref. No.</b>	211102.99 MA21110299
<b>description</b>	rocker switch mounting measurements 30x22mm green 2CO 250V 16A illuminated connection male faston 6.3mm ambient temperature max. 125/55°C protection IP40		
<b>For models:</b>	AF140MB, AF140MC, AF140MF, AF140MI, AF140MN, AF140MP, AF-70MB, AF70MC, AF70MF, AF70MI, AF70MN, AF70MP, SER15, SER15A, SER18, SER18A, SER21		
<b>accessories for</b>	301017		
	<b>Part No.</b>	301036	<b>Ref. No.</b> —
	protective cover internal size 30x22mm for rocker switch mounting measurementsmm		

blank			
			
1			
<b>Part No.</b>	347706	<b>Ref. No.</b>	R65260510
<b>description</b>	momentary rocker switch mounting measurements 30x22mm black 2CO 250V 16A connection male faston 6.3mm ambient temperature max. 100/55°C protection IP65 with cover cap		
<b>For models:</b>	EC106M, EC110M, EC210M, EM010M+SC, EM106M, EM106M+SC, EM110M, EM110M+SC, EM210M, EM210M+SC, EV006M, EV106M, EV106M+SC, EV110M, EV110M+SC, EV210M, EV210M+SC, FE105M, FE105X, FE110M, FE110X, FE210M, FG105M, FG105X, FG110M, FG110X, FG210M, FG210X, GC106M, GC110M, GC210M, GM106M, GM106M+SC, GM110M, GM110M+SC, GM210M, GM210M+SC, GV106M, GV106M+SC, GV110M, GV110M+SC, GV210M, GV210M+SC, PE040M, PE040X, PE080M, PE080X, PG040M, PG040X, PG080M...(Other models you can see in the webshop)		
<b>accessories for</b>	347706		
	<b>Part No.</b>	301036	<b>Ref. No.</b> —
	protective cover internal size 30x22mm for rocker switch mounting measurementsmm		





			
1			
<b>Part No.</b>	345982	<b>Ref. No.</b>	4640400 MA4640400
<b>description</b>	rocker switch mounting measurements 30x22mm green 2CO 250V 16A illuminated connection male faston 6.3mm ambient temperature max. 125/55°C protection IP65 with cover cap		
<b>For models:</b>	F140DF, F140DI, F140DN, F140DP, F14DFG, F14DNG, F70DF, F70DI, F70DN, F70DP, F7DFG, F7DNG, IR13C, IR13CC, IR13CV, IR13M, IR13MC, IR13MV, IR13V, IR17C, IR17CC, IR17CV, IR17M, IR17MC, IR17MV, IR17V, NF140DF, NF140DFN, NF140DN, NF140DNI, NF140DNN, NF140DP, NF140DPN, NF140DPP, NF143DNF, NF143DNI, NF143DNP, NF14DNG, NF70DF, NF70DI, NF70DN, NF70DP, NF72DNF, NF72DNI, NF72DNN, NF7DFG, NF7DNG, SPAR16, SPAR20, SPRG12... (Other models you can see in the webshop)		
<b>accessories for</b>	345982		
	<b>Part No.</b>	301036	<b>Ref. No.</b> —
	protective cover internal size 30x22mm for rocker switch mounting measurementsmm		

## labelled

			
1			
<b>Part No.</b>	301200	<b>Ref. No.</b>	R65260050
<b>description</b>	rocker switch mounting measurements 30x22mm black 2NO 230V 16A 0-1 connection male faston 6.3mm ambient temperature max. 85°C protection IP65 with cover cap		
<b>For models:</b>	AC, AU04, AU05, AU08, AU10, AU20, EC106M, EC110M, EC210M, EM106M, EM110M, EM210M, EV006M, EV106M, EV110M, EV210M, FE105X, FG105X, FG110X, FG210X, GC106M, GC110M, GC210M, GM106M, GM110M, GM210M, GV106M, GV110M, GV210M, PE040X, PG040X, PG080X		
<b>accessories for</b>	301200		
	<b>Part No.</b>	301036	<b>Ref. No.</b> —
	protective cover internal size 30x22mm for rocker switch mounting measurementsmm		

## with symbol

			
1			
<b>Part No.</b>	301228	<b>Ref. No.</b>	R65260210
<b>description</b>	rocker switch mounting measurements 30x22mm black 2CO 250V 16A I-II connection male faston 6.3mm ambient temperature max. 125/55°C protection IP65 with cover cap		
<b>For models:</b>	FE105X, FG105X, FG110X, FG210X, PE040X, PG040X, PG080X		
<b>accessories for</b>	301228		
	<b>Part No.</b>	301036	<b>Ref. No.</b> —
	protective cover internal size 30x22mm for rocker switch mounting measurementsmm		

## push/momentary push switches

## ø16mm

			
1			
<b>Part No.</b>	301172	<b>Ref. No.</b>	R65260610
<b>description</b>	momentary push switch mounting ø 16mm black 1NO 250V 16A connection male faston 6.3mm protection IP40 ambient temperature max. 150°C		
<b>For models:</b>	MACE04M, MACE05M, MACE07M, MACE10M, MACE20M, MACG05M, MACG07M, MACG10M, MACG20M, ME061M, ME101M, ME102M, ME201M, ME202M, MG061M, MG101M, MG102M, MG201M, MG202M		

			
1			
<b>Part No.</b>	346287 <sup>1</sup>	<b>Ref. No.</b>	R65260480
<b>description</b>	momentary push switch mounting ø 16mm red 1NO 250V 3A illuminated connection male faston 2.8mm ambient temperature max. 125/55°C protection IP65 with cover cap		
<b>For models:</b>	GC106M, GC110M, GC210M, GM106H, GM106M, GM106M+SC, GM106P, GM110H, GM110M, GM110M+SC, GM110P, GM210H, GM210M, GM210M+SC, GM210P, GV106H, GV106M, GV106M+SC, GV106P, GV110H, GV110M, GV110M+SC, GV110P, GV210H, GV210M, GV210M+SC, GV210P		

<sup>1</sup>illuminated

			
1			
<b>Part No.</b>	301227	<b>Ref. No.</b>	R65260120 R65260600
<b>description</b>	push switch mounting ø 16mm black 1NO 250V 16A connection male faston 6.3mm protection IP40 ambient temperature max. 150°C		
<b>For models:</b>	MACE04M, MACE05M, MACE07M, MACE10M, MACE20M, MACG05M, MACG07M, MACG10M, MACG20M, ME061M, ME101M, ME102M, ME201M, ME202M, MEC40M, MG061M, MG101M, MG102M, MG201M, MG202M		

## ø25mm

			
1			
<b>Part No.</b>	345038	<b>Ref. No.</b>	CR0410290
<b>description</b>	momentary push switch mounting ø 25mm black 2NO 250V 16A connection male faston 6.3mm ambient temperature max. 85°C protection IP40		
<b>For models:</b>	CFG70, CFG70M, NBR912EFM, NBR912EIM, NBR912GFM, NBR912GIM, NBR98EF, NBR98EFM, NBR98EI, NBR98EIM, NBR98GF, NBR98GFM, NBR98GI, NBR98GIM		



 <p>1</p>			
<b>Part No.</b>	345039	<b>Ref. No.</b>	1037115000 CR0410310 MACR0410310
<b>description</b>	protective cover round ED ø 33mm external size 23mm internal size 21mm H 12mm clear mounting ø 25mm		
<b>For models:</b>	CFG70, CFG70M, EF140DF, EF140DN, EF140DP, EF143DNF, EF70DF, EF70DN, EF70DP, EF72DNF, F140DF, F140DI, F140DN, F140DP, F14DFG, F14DNG, F70DF, F70DI, F70DN, F70DP, F7DFG, F7DNG, FB110F, FB110N, FB110P, FB140F, FB140FN, FB140N, FB140NN, FB140P, FB140PF, FB140PN, FB140PP, FB143NI, FB55F, FB55N, FB55P, FB70F, FB70N, FB70P, FB72F, FB72N, FB72NF, FB72P, FR92G22T, FR94G22T, FS140F, FS140FI, FS140FN, FS140I...(Other models you can see in the webshop)		
<b>accessories for</b>	345039		
	 <p>Part No.</p>	345001	Ref. No. —
	momentary push switch mounting ø 25mm yellow 1NO/indicator light 250V 16A cover connection male faston 6.3mm ambient temperature max. 85°C protection IP65		



pin-plunger actuated			
M10			
 <p>1</p>			
<b>Part No.</b>	345032	<b>Ref. No.</b>	1267300 MA1267300 R65260540
<b>description</b>	microswitch with plunger thread M10x1 thread L 12mm 250V 16A 1CO connection male faston 6.3mm stroke 7mm mounting distance 22mm L 28mm ambient temperature max. 125°C type SP9603 actuating force: 180g		
<b>For models:</b>	BR94G, BR94GI, BR9M4G, BR9M4GI, EC106M, EC110M, EC210M, EM010M+SC, EM106H, EM106M, EM106M+SC, EM106P, EM110H, EM110M, EM110M+SC, EM110P, EM210H, EM210M, EM210M+SC, EM210P, EV006M, EV106H, EV106M, EV106M+SC, EV106P, EV110H, EV110M, EV110M+SC, EV110P, EV210H, EV210M, EV210M+SC, EV210P, FC10E, FC10G, FC20E, FC20G, FC5E, FC5G, FC7E, FC7G, FE105M, FE105X, FE110M, FE110X, FE210M, FG105M, FG105X, FG110M, FG110X...(Other models you can see in the webshop)		

microswitches

lever actuated

 <p>1</p>			
<b>Part No.</b>	345254	<b>Ref. No.</b>	1037111300 1037304200 MA1037111300 MA1037304200
<b>description</b>	microswitch with lever 250V 16A 1CO connection male faston 6.3mm ambient temperature max. 120°C mounting distance 22mm actuating force: 60g lever length 58mm		
<b>For models:</b>	BR78EF, BR78EI, BR78GF, BR78GI, BR912EFM, BR912EIM, BR912GFM, BR912GIM, BR98EF, BR98EFM, BR98EI, BR98EIM, BR98GF, BR98GFM, BR98GI, BR98GIM, BR9S8EF, BR9S8EI, BR9S8GF, BR9S8GI, DLS30, DLS303, DLS30P, DLS30P3, DLS31, DLS313, DLS31P3, EF140DF, EF-140DN, EF140DP, EF140MB, EF140MC, EF140MF, EF140MI, EF140MN, EF140MP, EF143DNF, EF143MNI, EF70DF, EF70DN, EF70DP, EF70MB, EF70MC, EF70MF, EF70MI, EF70MN, EF70MP, EF72DNF, EF72MNF, EF74E10VG...(Other models you can see in the webshop)		

M12

 <p>1</p>			
<b>Part No.</b>	345350	<b>Ref. No.</b>	R65260530
<b>description</b>	microswitch with plunger mounting distance 22mm thread M12x0.75 thread L 16mm 250V 16A 1CO connection male faston 6.3mm stroke 4mm ambient temperature max. 125°C type EF83161.3 actuating force: 66g		
<b>For models:</b>	CVE004H, CVE004M, CVE104H, CVE104M, CVE105H, CVE105M, CVG105H, CVG105M, VE004M, VE004X, VE104M, VE104X, VE105M, VE105X, VG105M, VG105X		
<b>accessories for</b>	345350		
	 <p>Part No.</p>	345351	Ref. No. —
	nut thread M12x0.75 H 1.6mm WS 14 chrome-plated brass Qty 1 pcs		

roller-lever actuated

microswitches

 <p>1</p>			
<b>Part No.</b>	345276	<b>Ref. No.</b>	SIR0108059
<b>description</b>	microswitch with handle with a switch 250V 16A 1CO connection F6.3 L 33mm L1 28mm ambient temperature max. 125°C mounting distance 22.2mm actuating force: 190g black		

system switches (ROLD)

 <p>1</p>			
<b>Part No.</b>	345131	<b>Ref. No.</b>	190140
<b>description</b>	element holder mounting measurements 28.5x28.5mm grey single element holder		



1

<b>Part No.</b>	345133	<b>Ref. No.</b>	450321
<b>description</b>	push button ø 23mm grey		

## cam switches

## 4-position



1

<b>Part No.</b>	300103	<b>Ref. No.</b>	501400 MA501400
<b>description</b>	cam switch 4 operating positions 1NO/2CO sequence 0-1-2-3 32A shaft ø 6x4.6mm shaft L 23mm connection screw ceramic		
<b>For models:</b>	C9F4E, C9F6E, C9V2E, C9V4E		

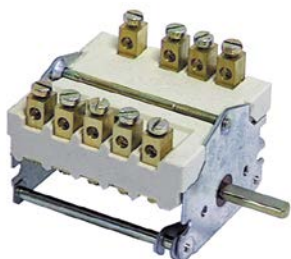

1

<b>Part No.</b>	300104	<b>Ref. No.</b>	1037100500 790700 MA790700
<b>description</b>	cam switch 4 operating positions 3NO/1CO sequence 0-1-2-3 32A shaft ø 6x4.6mm shaft L 23mm connection screw ceramic		
<b>For models:</b>	CP704E, CP92E, CP94E, CP9SB2E, CP9SB4E, CPE40, CPE402, CPE60, CPE602, FP1E		

## 7-position



1

<b>Part No.</b>	300106	<b>Ref. No.</b>	1937800 21131099 MA1937800
<b>description</b>	cam switch 7 operating positions 1NO/2CO sequence 0-1-2-3-4-5-6 32A shaft ø 6x4.6mm shaft L 23mm connection screw 7-position shaft flat upper		
<b>For models:</b>	C74E, C78EC, C78EQC, C7FE8E, C7FE8EC, C7FE8EQ, C94E, C94EC, C98E, C98EC, C9FE8E, C9FE8EC, NC94E, NC94E2, NC98E, NC98E2, NC9FE8E, NC9FE8E2		

## 4 operating positions



1

<b>Part No.</b>	300010	<b>Ref. No.</b>	2709600 MA2709600 R65080010
<b>description</b>	cam switch 4 operating positions 2NO/2CO sequence 0-1-2-3 16A shaft ø 6x4.6mm shaft L 23mm connection male faston 6.3mm ceramic		
<b>For models:</b>	EC106M, EC110M, EC210M, FE105M, FE105X, FE110M, FE110X, FE210M, FG105M, FG105X, FG110M, FG110X, FG210M, FG210X, GC106M, GC110M, GC210M, MACE04M, MACE05M, MACE07M, MACE10M, MACE20M, MACG05M, MACG07M, MACG10M, MACG20M, PE040M, PE040X, PE080M, PE080X, PG040M, PG040X, PG080M, PG080X		

## 5 operating positions

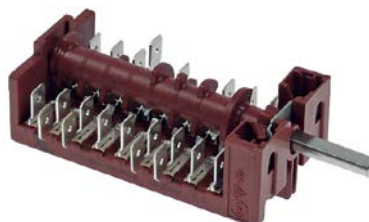

1

<b>Part No.</b>	347191	<b>Ref. No.</b>	R65080020
<b>description</b>	cam switch 5 operating positions 9NO sequence 1-0-2-3-4 16A shaft ø 6x4.6mm shaft L 23mm connection male faston 6.3mm plastic		
<b>For models:</b>	CVE004M, CVE104M, CVE105M, CVG105M, EM010M+SC, EM106M, EM106M+SC, EM110M, EM110M+SC, EM210M, EM210M+SC, EV006M, EV106M, EV106M+SC, EV110M, EV110M+SC, EV210M, EV-210M+SC, GM106M, GM106M+SC, GM110M, GM110M+SC, GM210M, GM210M+SC, GV106M, GV106M+SC, GV110M, GV110M+SC, GV210M, GV210M+SC, ME061M, ME101M, ME102M, ME106M, ME106X, ME110M, ME110X, ME120M, ME120X, ME201M, ME202M, ME210M, ME210X, ME220M, ME220X, MEC40M, MG061M, MG101M, MG102M, MG106M...(Other models you can see in the webshop)		



operation switches



1

<b>Part No.</b>	300080	<b>Ref. No.</b>	1037033200 218111 65085010 710300 LAR65085010 MA218111 MA710300
<b>description</b>	cam switch 2 operating positions 4NO 16A sequence 0-1 shaft $\varnothing$ 6x4.6mm shaft L 23mm connection screw operation switch ceramic ambient temperature max. 150°C		
<b>For models:</b>	B9SB2E, B9SB2G, B9SB4E, B9SB4G, B9V2E, B9V2G, B9V4E, B9V4G, BIE40, BIE40B, BIE60, BIE60B, BM74E, BM77E, BME40DM, BME40DMB, BME40M, BME60, BME602, BME60DM, BME60DMB, BME60M, BME80M, BR912GFM, BR912GIM, BR94G, BR94GI, BR96G, BR96GI, BR98GF, BR98GFM, BR98GI, BR98GIM, BR9M4G, BR9M4GI, BR9M6G, BR9M6GI, BR9S8GF, BR9S8GI, BR9SB4G, BR9SB4GI, BRE40, BRE40D, BRE40DB, BRE40DG, BRE40DGB, BRE40G, BSE40M, C7011EFE, C7011EFEQ...(Other models you can see in the webshop)		
<b>accessories for</b>	300080		
		<b>Part No.</b>	551456 <b>Ref. No.</b> —
	gasket for switch ED $\varnothing$ 14mm ID $\varnothing$ 2.5mm thickness 3.5mm white		



1

<b>Part No.</b>	300200	<b>Ref. No.</b>	1037313200 65260030 LAR65260030 MA1037313200
<b>description</b>	operation switch 2 operating positions 2NO 16A sequence 0-1 shaft $\varnothing$ 6x4.6mm shaft L 23mm connection male faston 6.3mm operation switch ceramic		
<b>For models:</b>	AR712PA, AR712PP, AR712PS, AR713PA, AR713PP, AR713PS, AR-714PA, AR714PP, AR714PS, AR715PA, AR715PP, AR715PS, AR716PA, AR716PP, AR716PS, AR717PA, AR717PP, AR717PS, AR718PA, AR718PP, AR718PS, AR719PA, AR719PP, AR719PS, AR720PA, AR720PP, AR720PS, BME40DM, BME40DMB, BME40M, BME60DM, BME60DMB, BME60M, BME80M, BR707E, BR707EI, BR78EF, BR78EI, BR912EFM, BR912EIM, BR912GFM, BR912GIM, BR94E, BR94EI, BR98EF, BR98EFM, BR98EI, BR98EIM, BR98GF, BR98GFM...(Other models you can see in the webshop)		

touch sensitive light switches



1

<b>Part No.</b>	346388	<b>Ref. No.</b>	R65260750
<b>description</b>	touch sensitive light switch 1NOVA for combi-steamer L 47mm W 20mm H 30mm		
<b>For models:</b>	GMT06D, GMT20D, GVT06D, GVT20D, MACE07M, MACE10M, MACE20M, MACG07M, MACG10M, MACG20M, ME061D, ME061M, ME061P, ME061T, ME101D, ME101M, ME101P, ME101T, ME102D, ME102M, ME102P, ME102T, ME201D, ME201M, ME201P, ME201T, ME202D, ME202M, ME202P, ME202T, MEMT06D, MEMT06P, MEMT10D, MEMT10P, MEMT20D, MEMT20P, MEMT21D, MEMT21P, MEVT40D, MEVT40P, MEVT06D, MEVT06P, MEVT10D, MEVT10P, MEVT20D, MEVT20P, MEVT21D, MEVT21P, MEVT40D, MEVT40P...(Other models you can see in the webshop)		

magnetic switches

36x13mm



1

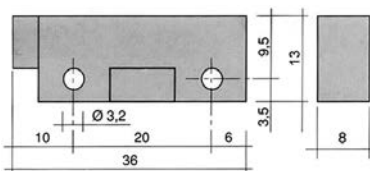

<b>Part No.</b>	345335	<b>Ref. No.</b>	5169100 MA5169100
<b>description</b>	magnetic switch L 36mm W 13mm 1NO 250V 0.04A P max. 10W connection cable cable length 960mm		
<b>For models:</b>	CON102E, CON102EP, CON102G, CON102GP, CON10E, CON10EP, CON10G, CON10GP, CON201E, CON201EP, CON201G, CON201GP, CON202E, CON202EP, CON202G, CON202GP, CON6E, CON6EP, CON6G, CON6GP, CSM102E, CSM102EP, CSM102G, CSM102GP, CSM10E, CSM10EP, CSM10G, CSM10GP, CSM201E, CSM201EP, CSM201G, CSM201GP, CSM202E, CSM202EP, CSM202G, CSM202GP, CSM6E, CSM6EP, CSM6G, CSM6GP		
<b>accessories for</b>	345335		
		<b>Part No.</b>	519049 <b>Ref. No.</b> —
	magnet $\varnothing$ mm L 63mm H 10.7mm W 18.8mm hole distance 52mm M2 hole $\varnothing$ 2mm		







37x16mm

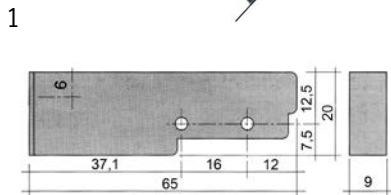
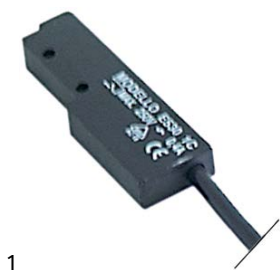

<b>Part No.</b>	347790	<b>Ref. No.</b>	LAR65265100
<b>description</b>	magnetic switch L 37mm W 16mm 1NO 250V connection cable cable length 1960mm 10W with magnet nominal 0.04A		
<b>For models:</b>	GMT06D, GMT20D, GVT06D, GVT20D, ME061D, ME061M, ME061P, ME061T, ME101D, ME101M, ME101P, ME101T, ME102D, ME102M, ME102P, ME102T, ME106M, ME106P, ME106X, ME110M, ME110P, ME110X, ME120M, ME120P, ME120X, ME201D, ME201M, ME201P, ME201T, ME202D, ME202M, ME202P, ME202T, ME210M, ME210P, ME210X, ME220M, ME220P, ME220X, MEC24H, MEC40M, MEMT06D, MEMT06P, MEMT10D, MEMT10P, MEMT20D, MEMT20P, MEMT21D, MEMT21P, MEMT40D...(Other models you can see in the webshop)		

65x20mm



<b>Part No.</b>	345116	<b>Ref. No.</b>	120348 BN161801
<b>description</b>	magnetic switch L 65mm W 20mm 1NO 250V 0.4A P max. 100W connection cable cable length 3000mm		
<b>accessories for</b>	345116		
	<b>Part No.</b>	<b>Ref. No.</b>	—
	345399		
	magnet ø 3.3mm L 40mm H 8mm W 13mm hole distance 30mm M3		

miscellaneous



<b>Part No.</b>	401961	<b>Ref. No.</b>	R66110300
<b>description</b>	magnetic switch door contact		
<b>For models:</b>	GMT20D, GVT06D, GVT20D, MACE07M, MACE10M, MACE20M, MACG07M, MACG10M, MACG20M, ME061M, ME061P, ME061T, ME101M, ME101P, ME101T, ME102M, ME102P, ME102T, ME201M, ME201P, ME201T, ME202D, ME202M, ME202P, ME202T, MEMT06D, MEMT06P, MEMT10D, MEMT10P, MEMT20D, MEMT20P, MEMT21D, MEMT21P, MEMT40D, MEMT40P, MEVT06D, MEVT06P, MEVT10D, MEVT10P, MEVT20D, MEVT20P, MEVT21D, MEVT21P, MEVT40D, MEVT40P, MG061M, MG061P, MG061T, MG101M, MG101P...(Other models you can see in the webshop)		

accessories

magnets



<b>Part No.</b>	691178	<b>Ref. No.</b>	1334900 MA1334900
<b>description</b>	magnet ø 22mm Lmm H 7mm Wmm ED ø 22mm M5		

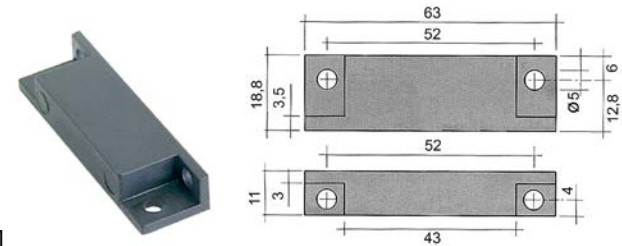

<b>Part No.</b>	345336	<b>Ref. No.</b>	5169200 BN3108890 MA5169200
<b>description</b>	magnet ø 4.8mm L 63mm H 11mm W 18.8mm hole distance 51mm M4		
<b>For models:</b>	CON102E, CON102EP, CON102G, CON102GP, CON10E, CON10EP, CON10G, CON10GP, CON201E, CON201EP, CON201G, CON201GP, CON202E, CON202EP, CON202G, CON202GP, CON6E, CON6EP, CON6G, CON6GP, CSM102E, CSM102EP, CSM102G, CSM102GP, CSM10E, CSM10EP, CSM10G, CSM10GP, CSM201, CSM201E, CSM201EP, CSM201G, CSM201GP, CSM202, CSM202E, CSM202EP, CSM202G, CSM202GP, CSM6E, CSM6EP, CSM6G, CSM6GP		

encoders and potentiometers



<b>Part No.</b>	401338	<b>Ref. No.</b>	R65301450
<b>description</b>	encoder		
<b>For models:</b>	GMT06D, GMT20D, GVT06D, GVT20D, ME061D, ME061P, ME061T, ME101D, ME101P, ME101T, ME102D, ME102P, ME102T, ME201D, ME201P, ME201T, ME202D, ME202P, ME202T, MEMT06D, MEMT06P, MEMT10D, MEMT10P, MEMT20D, MEMT20P, MEMT21D, MEMT21P, MEMT40D, MEMT40P, MEVT06D, MEVT06P, MEVT10D, MEVT10P, MEVT20D, MEVT20P, MEVT21D, MEVT21P, MEVT40D, MEVT40P, MG061D, MG061P, MG061T, MG101D, MG101P, MG101T, MG102D, MG102P, MG102T, MG201D, MG201P...(Other models you can see in the webshop)		



<b>Part No.</b>	403835	<b>Ref. No.</b>	LA65302500
<b>description</b>	encoder rotation 360° shaft ø 6x4.6mm shaft L 26mm for combi-steamer cable length 600mm SS		





			
1			
<b>Part No.</b>	403084	<b>Ref. No.</b>	LA65301941 LAR65301940
<b>description</b>	encoder shaft L 18mm cable length 200mm shaft 6x4.6mm		

## lamps

### indicator lights

#### indicator lights 2-piece (lens and indicator lamp)

##### indicator light lenses

##### ø 6mm (type SQ-20)

			
1			
<b>Part No.</b>	359803	<b>Ref. No.</b>	130704
<b>description</b>	indicator light lens green Qty 1 pcs ø 6mm		

##### ø12mm (type SDY-3)

			
1			
<b>Part No.</b>	359262	<b>Ref. No.</b>	130711 BN6A001438
<b>description</b>	indicator light housings mounting measurements ø12mm green round Qty 1 pcs		

			
1			
<b>Part No.</b>	359261	<b>Ref. No.</b>	130710
<b>description</b>	indicator light housings mounting measurements ø12mm red round Qty 1 pcs		

#### indicator lamps for socket type SRZ / SDK / SDY / SFK

			
1			
<b>Part No.</b>	359132	<b>Ref. No.</b>	1037303400
<b>description</b>	indicator lamp green 250V connection male faston 6.3mm protection IP54 ambient temperature max. 85°C		
<b>For models:</b>	DLS30, DLS303, DLS30P, DLS30P3, DLS31, DLS313, DLS31P3, MLC50, MLC503, MLC65, MLC653, MLS30, MLS303, MLS30P, MLS30P3, MLS31, MLS313, MLS31P3, MLS35, MLS353, MPLS30P		

#### indicator lights (complete)

##### ø 6mm

			
1			
<b>Part No.</b>	359004	<b>Ref. No.</b>	2998600 MA2998600
<b>description</b>	indicator light ø 6mm 230V green cable length 400mm temp.-resist. 106°C		
<b>For models:</b>	CON102E, CON102EP, CON102G, CON102GP, CON10E, CON10EP, CON10G, CON10GP, CON201E, CON201EP, CON201G, CON201GP, CON202E, CON202EP, CON202G, CON202GP, CON6E, CON6EP, CON6G, CON6GP		

			
1			
<b>Part No.</b>	359005	<b>Ref. No.</b>	2998700 MA2998700
<b>description</b>	indicator light ø 6mm 230V yellow cable length 400mm		
<b>For models:</b>	CON102E, CON102EP, CON102G, CON102GP, CON10E, CON10EP, CON10G, CON10GP, CON201E, CON201EP, CON201G, CON201GP, CON202E, CON202EP, CON202G, CON202GP, CON6E, CON6EP, CON6G, CON6GP		

			
1			
<b>Part No.</b>	359284	<b>Ref. No.</b>	2959600 MA2959600
<b>description</b>	indicator light ø 6mm 24V green cable length 150mm		
<b>For models:</b>	CON201E, CON201EP, CON201G, CON201GP, CON202E, CON202EP, CON202G, CON202GP, CS4E, CS4EP, CSM102E, CSM102EP, CSM102G, CSM102GP, CSM10E, CSM10EP, CSM10G, CSM10GP, CSM201, CSM201E, CSM201EP, CSM201G, CSM201GP, CSM202, CSM202E, CSM202EP, CSM202G, CSM202GP, CSM6E, CSM6EP, CSM6G, CSM6GP		

			
1			
<b>Part No.</b>	359285	<b>Ref. No.</b>	2959700 MA2959700
<b>description</b>	indicator light ø 6mm 24V yellow cable length 150mm		
<b>For models:</b>	CON201E, CON201EP, CON201G, CON201GP, CON202E, CON202EP, CON202G, CON202GP, CS4E, CS4EP, CSM102E, CSM102EP, CSM102G, CSM102GP, CSM10E, CSM10EP, CSM10G, CSM10GP, CSM201, CSM201E, CSM201EP, CSM201G, CSM201GP, CSM202, CSM202E, CSM202EP, CSM202G, CSM202GP, CSM6E, CSM6EP, CSM6G, CSM6GP		

			
1			
<b>Part No.</b>	359031	<b>Ref. No.</b>	130157
<b>description</b>	indicator light ø 6mm 230V green		



ø10mm

with screw socket



1

<b>Part No.</b>	359378	<b>Ref. No.</b>	1037300800 1037300810 MA1037300810
<b>description</b>	indicator light ø 10mm 230V green connection male faston 6.3mm socket screw base		
<b>For models:</b>	B9SB2E, B9SB4E, B9V2E, B9V4E, BIE40, BIE40B, BIE60, BIE60B, BM74E, BM77E, BME40DM, BME40DMB, BME40M, BME60, BME602, BME60DM, BME60DMB, BME60M, BME80M, BRE40, BRE40D, BRE40DB, BRE40DG, BRE40DGB, BRE40G, BSE40M, BSEI40M, CB3, CB5, CD24, CFE60, CFE60P, CFE70, CFGE60, CFGE61, CFGE61D, CFGE61L, CFGE61P, CFVE60, CPE40, CPE402, CPE60, CPE602, CWE42, CWE422, CWE62, CWE622, F9V2E, F9V2E2, F9V2ER...(Other models you can see in the webshop)		



1

<b>Part No.</b>	359379	<b>Ref. No.</b>	CR0587500
<b>description</b>	indicator light ø 10mm 230V yellow connection male faston 6.3mm socket screw base		
<b>For models:</b>	EF74E10VG, EF74E12, NB74E, NB78E, NBR78EF, NBR78EI, NBR912EFM, NBR912EIM, NBR912GFM, NBR912GIM, NBR98EF, NBR98EFM, NBR98EI, NBR98EIM, NBR98GF, NBR98GFM, NBR98GI, NBR98GIM, NC74E2, NC74EC, NC74EQC, NC78E2, NC78EC, NC78EQC, NC7FE8E, NC7FE8E2, NC7FE8EQ, NC94E, NC94E2, NC98E, NC98E2, NC9FE8E, NC9FE8E2, NCT78E, NCT7FE8E, NCT98E, NCT98E2, NCT9FE8E, NCT9FE8E2, NF74E10, NF74E15, NF76E10, NF78E15, NF94E10, NF94E15, NF94E22, NF94E222, NF96E10, NF98E15, NF98E22...(Other models you can see in the webshop)		

with plug-in socket



1

<b>Part No.</b>	359140	<b>Ref. No.</b>	1037300900 1037300910 MA1037300910
<b>description</b>	indicator light ø 10mm yellow 230V connection male faston 6.3mm Qty 1 pcs		
<b>For models:</b>	AR712PA, AR712PP, AR712PS, AR713PA, AR713PP, AR713PS, AR714PA, AR714PP, AR714PS, AR715PA, AR715PP, AR715PS, AR716PA, AR716PP, AR716PS, AR717PA, AR717PP, AR717PS, AR718PA, AR718PP, AR718PS, AR719PA, AR719PP, AR719PS, AR720PA, AR720PP, AR720PS, B124E, B74E, B78E, B94E, B98E, B9SB2E, B9SB4E, B9V2E, B9V4E, BF78E, BF98E, BIE40, BIE40B, BIE60, BIE60B, BM74E, BM77E, BME40DM, BME40DMB, BME40M, BME60, BME602, BME60DM...(Other models you can see in the webshop)		

ø12mm

with screw socket



1

<b>Part No.</b>	359027	<b>Ref. No.</b>	R65270230
<b>description</b>	indicator light ø 12mm 250V green connection male faston 6.3mm		
<b>For models:</b>	CVE004M, CVE104M, CVE105M, CVG105M, EC106M, EC110M, EC210M, EM010M+SC, EM106M, EM106M+SC, EM110M, EM110M+SC, EM210M, EM210M+SC, EV006M, EV106M, EV106M+SC, EV110M, EV-110M+SC, EV210M, EV210M+SC, FE105M, FE105X, FE110M, FE110X, FE210M, FG105M, FG105X, FG110M, FG110X, FG210M, FG210X, GC106M, GC110M, GC210M, GM106M, GM106M+SC, GM110M, GM110M+SC, GM210M, GM210M+SC, GV106M, GV106M+SC, GV110M, GV110M+SC, GV210M, GV210M+SC, ME106M, ME106X, ME110M...(Other models you can see in the webshop)		



1

<b>Part No.</b>	359290	<b>Ref. No.</b>	R65270220
<b>description</b>	indicator light ø 12mm 400V yellow connection male faston 6.3mm		
<b>For models:</b>	AC, AU04, AU05, AU08, AU10, AU20, CVE004M, CVE104M, CVE105M, CVG105M, EC106M, EC110M, EC210M, EM010M+SC, EM106M, EM106M+SC, EM110M, EM110M+SC, EM210M, EM210M+SC, EV006M, EV106M, EV106M+SC, EV110M, EV110M+SC, EV210M, EV210M+SC, FE105M, FE105X, FE110M, FE110X, FE210M, FG105M, FG105X, FG110M, FG110X, FG210M, FG210X, GC106M, GC110M, GC210M, GM106M, GM106M+SC, GM110M, GM110M+SC, GM210M, GM210M+SC, GV106M, GV106M+SC, GV110M...(Other models you can see in the webshop)		

ø12.5mm



1

<b>Part No.</b>	359998	<b>Ref. No.</b>	MA21016099
<b>description</b>	indicator light ø 12.5mm 230V red connection male faston 6.3mm		

ø13mm

with plug-in socket



1

<b>Part No.</b>	359142	<b>Ref. No.</b>	1819800 21016199 MA1819800 MA21016199
<b>description</b>	indicator light ø 13mm green 230V connection male faston 6.3mm temp.-resist. 120°C Qty 1 pcs		
<b>For models:</b>	B9SB2E, B9SB4E, B9V2E, B9V4E, B9VP2E, B9VP4E, BM74E, BM77E, BR707E, BR707EI, C7011E, C7011EFE, C7011EFEQ, C704E, C707E, C707EFE, C707EFEQ, C9F4E, C9F6E, C9V2E, C9V4E, F9V2E, F9V2ER, F9V4E, F9V4EC, F9V4ECR, F9V4ER, F9V4ERL, FC10E, FC10G, FC20E, FC20G, FC5E, FC5G, FC7E, FC7G, FR74E, FR74E10, FR77E, FR77E10, FR92E10, FR92E13, FR92E132, FR92E22, FR94E10, FR94E13, FR94E132, FR94E22, FR9P2E10, FR9P4E10...(Other models you can see in the webshop)		



 <p>1</p>			
<b>Part No.</b>	359143	<b>Ref. No.</b>	1819900 21016299 MA1819900 MA21016299
<b>description</b>	indicator light ø 13mm yellow 230V connection male faston 6.3mm temp.-resist. 120°C Qty 1 pcs		
<b>For models:</b>	B9SB2E, B9SB4E, B9V2E, B9V4E, B9VP2E, B9VP4E, BM74E, BM77E, BR707E, BR707EI, C7011EFE, C7011EFEQ, C707EFE, C707EFEQ, C9F4E, C9F6E, C9V2E, C9V4E, CP704E, CP92E, CP94E, CP9SB2E, CP9SB4E, F9V2E, F9V2ER, F9V4E, F9V4EC, F9V4ECR, F9V4ER, F9V4ERL, FC10E, FC10G, FC20E, FC20G, FC5E, FC5G, FC7E, FC7G, FP1E, FR74E, FR74E10, FR77E, FR77E10, FR92E10, FR92E13, FR92E132, FR92E22, FR94E10, FR94E13, FR94E132...(Other models you can see in the webshop)		

ø16mm

with plug-in socket

 <p>1</p>			
<b>Part No.</b>	359788	<b>Ref. No.</b>	R65270160
<b>description</b>	indicator light ø 16mm 230V green connection male faston 6.3mm		
<b>For models:</b>	MACE04M, MACE05M, MACE07M, MACE10M, MACE20M, MACG05M, MACG07M, MACG10M, MACG20M, ME061M, ME101M, ME102M, ME201M, ME202M, MGO61M, MG101M, MG102M, MG201M, MG202M		

 <p>1</p>			
<b>Part No.</b>	359789	<b>Ref. No.</b>	R65270150
<b>description</b>	indicator light ø 16mm 230V yellow connection male faston 6.3mm		
<b>For models:</b>	MACE04M, MACE05M, MACE07M, MACE10M, MACE20M, MACG05M, MACG07M, MACG10M, MACG20M, ME061M, ME101M, ME102M, ME201M, ME202M, MGO61M, MG101M, MG102M, MG201M, MG202M		

screw-on/push-on fit

light bulbs

for ovens

 <p>1</p>			
<b>Part No.</b>	359612	<b>Ref. No.</b>	2861900 MA2861900
<b>description</b>	light bulb t.max. 300°C socket E14 25W 230V ø 25mm L 56mm lens L 30mm for oven lamp type Philips		
<b>For models:</b>	CON102E, CON102EP, CON102G, CON102GP, CON201E, CON201EP, CON201G, CON201GP, CON202E, CON202EP, CON202G, CON202GP, CS102E, CS102EP, CS102G, CS102GP, CS10E, CS10EP, CS10G, CS6E, CS6EP, CS6G, CSM102E, CSM102EP, CSM102G, CSM102GP, CSM10E, CSM10EP, CSM10G, CSM10GP, CSM201E, CSM201EP, CSM201G, CSM201GP, CSM202E, CSM202EP, CSM202G, CSM202GP, CSM6E, CSM6EP, CSM6G, CSM6GP		

halogen lamp

for socket E14 / E27

 <p>1</p>			
<b>Part No.</b>	359728	<b>Ref. No.</b>	4625800 MA4625800
<b>description</b>	halogen lamp socket E14 230V 40W ø 25mm lens L 54mm L 80mm temp.-resist. 300°C Qty 1		
<b>For models:</b>	F140DF, F140DI, F140DN, F140DP, F143, F70DF, F70DI, F70DN, F70DP, F72, F7DFG, F7DNG, FB110F, FB110N, FB110P, FB140F, FB140FN, FB140N, FB140NN, FB140P, FB140PF, FB140PN, FB140PP, FB143NI, FB55F, FB55N, FB55P, FB70F, FB70N, FB70P, FB72F, FB72N, FB72NF, FB72P, FS140F, FS140FI, FS140FN, FS140I, FS140N, FS140NG, FS140NI, FS140NN, FS140P, FS140PN, FS140PP, FS143F, FS143FI, FS143N, FS143NF, FS143NI...(Other models you can see in the webshop)		

for socket G4 / G6.35 / G9

 <p>1 <b>500°C</b></p>			
<b>Part No.</b>	359599	<b>Ref. No.</b>	LA65270020 LAR65270020
<b>description</b>	halogen lamp socket G4 12V 20W temp.-resist. 500°C		
<b>For models:</b>	EC106M, EC110M, EC210M, EM010M+SC, EM106H, EM106M, EM106M+SC, EM106P, EM110H, EM110M, EM110M+SC, EM110P, EM210H, EM210M, EM210M+SC, EM210P, EV006M, EV106H, EV106M, EV106M+SC, EV106P, EV110H, EV110M, EV110M+SC, EV110P, EV210H, EV210M, EV210M+SC, EV210P, FE105X, FG105X, FG110X, FG210X, GC106M, GC110M, GC210M, GM106H, GM106M, GM106M+SC, GM106P, GM110H, GM110M, GM110M+SC, GM110P, GM210H, GM210M, GM210M+SC, GM210P, GMT06D, GMT20D... (Other models you can see in the webshop)		

oven lamps

universal oven lamps

mounting diameter 35.5mm

 <p>1</p>			
<b>Part No.</b>	359718	<b>Ref. No.</b>	1037300100 1037317000 MA1037300100 MA1037317000
<b>description</b>	oven lamp mounting ø 35.5mm 230V 15W socket E14 temp.-resist. 300°C connection male faston 6.3mm hard glas		
<b>For models:</b>	CFE60, CFE60P, CFGE60, CFGE61, CFGE61D, CFGE61L, CFGE61P, CFVE60, F0E60M, OCFE60, OCFGE61, OF0E60M		
<b>spare parts for</b>	359718		
	<b>Part No.</b>	359701	<b>Ref. No.</b> —
lamp socket socket E14 220-230V mounting ø 35.5mm connection male faston 6.3mm 15W			
	<b>Part No.</b>	359740	<b>Ref. No.</b> —
light bulb t.max. 300°C socket E14 15W 230V ø 22mm L 48mm lens L 20mm for oven lamp IMPORT			



55x70mm



1

<b>Part No.</b>	359375	<b>Ref. No.</b>	R65270510
<b>description</b>	lamp socket complete version socket E14 mounting measurements 55x70mm		
<b>For models:</b>	MACE04M, MACE05M, MACG05M, MVE042P, MVE051P, MVG051P		

55x100mm



1

<b>Part No.</b>	101372	<b>Ref. No.</b>	2862100 MA2862100
<b>description</b>	oven lamp complete L 100mm W 55mm 230V 25W socket E14 rectangular temp.-resist. 300°C connection male faston 6.3mm		
<b>For models:</b>	CON102E, CON102EP, CON102G, CON102GP, CON201E, CON201EP, CON201G, CON201GP, CON202E, CON202EP, CON202G, CON202GP, CS102E, CS102EP, CS102G, CS102GP, CS10E, CS10EP, CS10G, CS6E, CS6EP, CS6G, CSM102E, CSM102EP, CSM102G, CSM102GP, CSM10E, CSM10EP, CSM10G, CSM10GP, CSM201E, CSM201EP, CSM201G, CSM201GP, CSM202E, CSM202EP, CSM202G, CSM202GP, CSM6E, CSM6EP, CSM6G, CSM6GP		
<b>spare parts for</b>	101372		
	<b>Part No.</b>	359612	<b>Ref. No.</b> 2861900 MA2861900
	light bulb t.max. 300°C socket E14 25W 230V ø 25mm L 56mm lens L 30mm for oven lamp type Philips		
	<b>Part No.</b>	359698	<b>Ref. No.</b> —
	lamp socket L 100mm W 55mm socket E14 connection male faston 6.3mm		
	<b>Part No.</b>	359714	<b>Ref. No.</b> —
	gasket silicone L 140mm W 75mm for bulb socket		
	<b>Part No.</b>	359715	<b>Ref. No.</b> —
	lamp glass L 110mm W 65mm thickness 5mm		
	<b>Part No.</b>	359716	<b>Ref. No.</b> —
	frame for bulb socket		

## lamps

## light bulbs



1

<b>Part No.</b>	359612	<b>Ref. No.</b>	2861900 MA2861900
<b>description</b>	light bulb t.max. 300°C socket E14 25W 230V ø 25mm L 56mm lens L 30mm for oven lamp type Philips		
<b>For models:</b>	CON102E, CON102EP, CON102G, CON102GP, CON201E, CON201EP, CON201G, CON201GP, CON202E, CON202EP, CON202G, CON202GP, CS102E, CS102EP, CS102G, CS102GP, CS10E, CS10EP, CS10G, CS6E, CS6EP, CS6G, CSM102E, CSM102EP, CSM102G, CSM102GP, CSM10E, CSM10EP, CSM10G, CSM10GP, CSM201E, CSM201EP, CSM201G, CSM201GP, CSM202E, CSM202EP, CSM202G, CSM202GP, CSM6E, CSM6EP, CSM6G, CSM6GP		

## halogen lamps

for socket E14 / E27



1

<b>Part No.</b>	359728	<b>Ref. No.</b>	4625800 MA4625800
<b>description</b>	halogen lamp socket E14 230V 40W ø 25mm lens L 54mm L 80mm temp.-resist. 300°C Qty 1		
<b>For models:</b>	F140DF, F140DI, F140DN, F140DP, F143, F70DF, F70DI, F70DN, F70DP, F72, F7DFG, F7DNG, FB110F, FB110N, FB110P, FB140F, FB140FN, FB140N, FB140NN, FB140P, FB140PF, FB140PN, FB140PP, FB143NI, FB55F, FB55N, FB55P, FB70F, FB70N, FB70P, FB72F, FB72N, FB72NF, FB72P, FS140F, FS140FI, FS140FN, FS140I, FS140N, FS140NG, FS140NI, FS140NN, FS140P, FS140PN, FS140PP, FS143F, FS143FI, FS143N, FS143NF, FS143NI...(Other models you can see in the webshop)		

for socket G4 / G6.35 / G9



1

<b>Part No.</b>	359599	<b>Ref. No.</b>	LA65270020 LAR65270020
<b>description</b>	halogen lamp socket G4 12V 20W temp.-resist. 500°C		
<b>For models:</b>	EC106M, EC110M, EC210M, EM010M+SC, EM106H, EM106M, EM106M+SC, EM106P, EM110H, EM110M, EM110M+SC, EM110P, EM210H, EM210M, EM210M+SC, EM210P, EV006M, EV106H, EV106M, EV106M+SC, EV106P, EV110H, EV110M, EV110M+SC, EV110P, EV210H, EV210M, EV210M+SC, EV210P, FE105X, FG105X, FG110X, FG210X, GC106M, GC110M, GC210M, GM106H, GM106M, GM106M+SC, GM106P, GM110H, GM110M, GM110M+SC, GM110P, GM210H, GM210M, GM210M+SC, GM210P, GMT06D, GMT20D...(Other models you can see in the webshop)		

## timers

## programme timers



1

<b>Part No.</b>	403577	<b>Ref. No.</b>	LAR65090220 LAR65095000
<b>description</b>	gear motor CDC 4901F1 engines 1 chambers 1 operation time 20s 230V 50Hz shaft ø 6x4.6mm shaft L 24mm		
<b>For models:</b>	ME061P, ME061T, ME101P, ME101T, ME102P, ME102T, ME106P, ME110P, ME120P, ME201P, ME201T, ME202P, ME202T, ME210P, ME220P, MEC24H, MEMT06P, MEMT10P, MEMT20P, MEMT21P, MEMT40P, MEVT06P, MEVT10P, MEVT20P, MEVT21P, MEVT40P, MG061P, MG061T, MG101P, MG101T, MG102P, MG102T, MG106P, MG110P, MG120P, MG201P, MG201T, MG202P, MG202T, MG210P, MG220P, MGC24H, MGC40H, MGMT06P, MGMT10P, MGMT20P, MGMT21P, MGMT40P, MGMT06P, MGMT10P...(Other models you can see in the webshop)		

1

<b>Part No.</b>	360752	<b>Ref. No.</b>	R65090190
<b>description</b>	timer CDC 4902F1 engines 1 chambers 2 operation time 8min 230V shaft ømm shaft Lmm		
<b>For models:</b>	CVE004M, CVE104M, CVE105M, CVG105M, EC106M, EC110M, EC210M, EM010M+SC, EM106M, EM106M+SC, EM110M, EM110M+SC, EM210M, EM210M+SC, EV006M, EV106M, EV106M+SC, EV110M, EV-110M+SC, EV210M, EV210M+SC, FE105M, FE105X, FE110M, FE110X, FE210M, FG105M, FG105X, FG110M, FG110X, FG210M, FG210X, GC106M, GC110M, GC210M, GM106M, GM106M+SC, GM110M, GM110M+SC, GM210M, GM210M+SC, GV106M, GV106M+SC, GV110M, GV110M+SC, GV210M, GV210M+SC, MACE04M, MACE05M, MACE07M...(Other models you can see in the webshop)		



1

<b>Part No.</b>	360332	<b>Ref. No.</b>	2971200 MA2971200
<b>description</b>	timer FIBER P25 engines 1 chambers 1 operation time 60s 230V shaft ømm shaft Lmm manuf. no. P255J01H191 motor type M51BJOR6400		
<b>For models:</b>	CON102E, CON102EP, CON102G, CON102GP, CON10E, CON10EP, CON10G, CON10GP, CON6E, CON6EP, CON6G, CON6GP, CS102E, CS102EP, CS102G, CS102GP		
<b>spare parts for</b>	360332		
	<b>Part No.</b>	360673	<b>Ref. No.</b> —
	motor kit pinion ø 6.8mm teeth 15 230V voltage AC 50/60Hz turn direction clockwise motor ø 48mm H 18.5mm motor type UDS-40NE1RNZ165 cable length 150mm with holder		

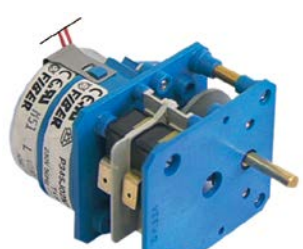

1

<b>Part No.</b>	350038	<b>Ref. No.</b>	R65090020
<b>description</b>	timer FIBER P34 engines 1 chambers 2 operation time 144min 230V shaft ø 6x4.6mm shaft L 20mm manuf. no. P345J02N765 motor type M51BJOL6400 impulse electric		
<b>For models:</b>	EC106M, EC110M, EC210M, FE105M, FE105X, FE110M, FE110X, FE210M, FG105M, FG105X, FG110M, FG110X, FG210M, FG210X, GC106M, GC110M, GC210M, MACE04M, MACE05M, MACE07M, MACE10M, MACE20M, MACG05M, MACG07M, MACG10M, MACG20M, PE040M, PE040X, PE080M, PE080X, PG040M, PG040X, PG080M, PG080X		
<b>spare parts for</b>	350038		
	<b>Part No.</b>	360674	<b>Ref. No.</b> —
	motor kit pinion ø 6.8mm teeth 15 230V voltage AC 50/60Hz turn direction counterclockwise motor ø 48mm H 18.5mm motor type UDS40NE1RNZ165 cable length 150mm with holder		

mechanical timers



1

<b>Part No.</b>	350003	<b>Ref. No.</b>	2709900 2812300 MA2709900
<b>description</b>	timer M2 with bell 2-pole operation time 120min impulse mechanical 2NO at 250V 16A permanent position no shaft ø 6x4.6mm shaft 6x4.6mm shaft L 23mm mounting distance 28mm connection lateral		
<b>For models:</b>	FC10E, FC10G, FC20E, FC20G, FC5E, FC5G, FC7E, FC7G		
<b>accessories for</b>	350003		
	<b>Part No.</b>	110366	<b>Ref. No.</b> —
	knob switch zero mark t.max.°C ø 44mm shaft ø 6x4.6mm shaft flat upper black		
	<b>Part No.</b>	111199	<b>Ref. No.</b> —
	dial plate graduation 120min permanent position no rotation 0-330° ø 60mm timers knob ø 45mm		



1

<b>Part No.</b>	350049	<b>Ref. No.</b>	1037103400 MA1037103400
<b>description</b>	timer M2 with bell 2-pole operation time 30min impulse mechanical 2NO at 250V 16A permanent position yes shaft ø 6x4.6mm shaft 6x4.6mm shaft L 23mm mounting distance 28mm connection lateral		
<b>For models:</b>	SPE60M, SPW60M		
<b>accessories for</b>	350049		
	<b>Part No.</b>	110366	<b>Ref. No.</b> —
	knob switch zero mark t.max.°C ø 44mm shaft ø 6x4.6mm shaft flat upper black		
	<b>Part No.</b>	111205	<b>Ref. No.</b> —
	dial plate graduation 30min permanent position yes rotation 30-300° ø 60mm		



1



<b>Part No.</b>	350040	<b>Ref. No.</b>	3100640
<b>description</b>	timer M2 with bell 2-pole operation time 60min impulse mechanical 2NO at 250V 16A permanent position yes shaft ø 6x4.6mm shaft 6x4.6mm shaft L 23mm mounting distance 28mm connection lateral		
<b>accessories for</b>	350040		
	<b>Part No.</b>	110366	<b>Ref. No.</b> —
	knob switch zero mark t.max.°C ø 44mm shaft ø 6x4.6mm shaft flat upper black		

Table continues overleaf





accessories for	350040		
	Part No.	111202	Ref. No.
			—
	dial plate graduation 60min permanent position yes rotation 0-300° ø 60mm timers knob ø 45mm with permanent position		

## audible timers

	1		
Part No.	350036	Ref. No.	1031006400 2600200 MA1031006400
description	audible timer operation time 60min ø 55mm shaft ø 6x4.6mm shaft L 22mm mounting distance 28mm		
For models:	CFE60, CFE60P, CFG60, CFG61, CFG61D, CFG61L, CFG61P, CFVE60, FOE60M, FV4E, FV4E1, OCFE60, OCFGE61, OFOE60M		

## alarm devices

## buzzer boards

	1		
Part No.	350078	Ref. No.	2864400 MA2864400
description	buzzer board		
For models:	CON102E, CON102EP, CON102G, CON102GP, CON10E, CON10EP, CON10G, CON10GP, CON6E, CON6EP, CON6G, CON6GP, CP9A15GD, CS102E, CS102EP, CS102G, CS102GP, CS10E, CS10EP, CS10G, CS6E, CS6EP, CS6G		

	1		
Part No.	350079	Ref. No.	5152000 MA5152000
description	buzzer board		
For models:	CON201E, CON201EP, CON201G, CON201GP, CON202E, CON202EP, CON202G, CON202GP, CSM102E, CSM102EP, CSM102G, CSM102GP, CSM10E, CSM10EP, CSM10G, CSM10GP, CSM201E, CSM201EP, CSM201G, CSM201GP, CSM202E, CSM202EP, CSM202G, CSM202GP, CSM6E, CSM6EP, CSM6G, CSM6GP		

	1		
Part No.	400143	Ref. No.	R65300670
description	buzzer board		
For models:	ME106P, ME110P, ME120P, ME210P, ME220P, MG106P, MG110P, MG120P, MG210P, MG220P, VE106P, VE120P, VE210P, VE220P, VG106P, VG110P, VG120P, VG210P, VG220P		

## buzzers

	1		
Part No.	350055	Ref. No.	R65330040
description	buzzer 12VDC connection cable 200mm PCB buzzer 20dB		
For models:	CVE004H, CVE104H, CVE105H, CVG105H, ME106P, ME110P, ME120P, ME210P, ME220P, MEC24H, MG106P, MG110P, MG120P, MG210P, MG220P, MGC24H, MGC40H, VE106P, VE120P, VE210P, VE220P, VG106P, VG110P, VG120P, VG210P, VG220P		

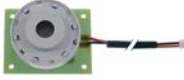
	1		
Part No.	350086	Ref. No.	R65301440 RA919008
description	buzzer 12VDC connection cable 200mm PCB buzzer 20dB		
For models:	DP018T, DP112T, DPC20T, DPC40T, DX018T, DX110T, DX112T, DXC20T, DXC40T, GMT06D, GMT20D, GVT06D, GVT20D, MDP112T, MDPC20T, MDPC40T, MDX112T, MDXC20T, MDXC40T, ME061D, ME061P, ME061T, ME101D, ME101P, ME101T, ME102D, ME102P, ME102T, ME201D, ME201P, ME201T, ME202D, ME202P, ME202T, MEMENT06D, MEMENT06P, MEMENT10D, MEMENT10P, MEMENT20D, MEMENT20P, MEMENT21D, MEMENT21P, MEMENT40D, MEMENT40P, MEVT06D, MEVT06P, MEVT10D, MEVT10P, MEVT20D, MEVT20P...(Other models you can see in the webshop)		

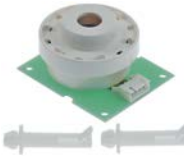
	1		
Part No.	350223	Ref. No.	LA65302450
description	buzzer 12VDC connection coded PCB buzzer 20dB		

	1		
Part No.	350050	Ref. No.	R65330010
description	buzzer 230VAC connection male faston 6.3mm screw mounting thread M4 60dB		
For models:	CVE004M, CVE104M, CVE105M, CVG105M, EC106M, EC110M, EC210M, EM010M+SC, EM106M, EM106M+SC, EM110M, EM110M+SC, EM210M, EM210M+SC, EVO06M, EV106M, EV106M+SC, EV110M, EV-110M+SC, EV210M, EV210M+SC, FE105M, FE105X, FE110M, FE110X, FE210M, FG105M, FG105X, FG110M, FG110X, FG210M, FG210X, GC106M, GC110M, GC210M, GM106M, GM106M+SC, GM110M, GM110M+SC, GM210M, GM210M+SC, GV106M, GV106M+SC, GV110M, GV110M+SC, GV210M, GV210M+SC, MACE04M, MACE05M, MACE07M...(Other models you can see in the webshop)		





contactors

LOVATO

power contactors



1

<b>Part No.</b>	380083	<b>Ref. No.</b>	120444
<b>description</b>	power contactor resistive load 25A 230VAC (AC3/400V) 9A/4.2kW main contacts 3NO auxiliary contacts 1NC connection screw connection type BF0901A230		

MOELLER/EATON

power contactors



1

<b>Part No.</b>	380550	<b>Ref. No.</b>	R65140550
<b>description</b>	power contactor resistive load 20A 230VAC (AC3/400V) 9A/4kW main contacts 3NO auxiliary contacts 1NC connection screw connection type DILM9 01		
<b>For models:</b>	GMT06D, GVT06D, MACE04M, MACE05M, MACE07M, MACE10M, MACE20M, MACG07M, MACG10M, MACG20M, MEMT06D, MEMT06P, MEMT10D, MEMT10P, MEVT06D, MEVT06P, MEVT10D, MEVT10P, MGMT06D, MGMT06P, MGMT10D, MGMT10P, MGVT06D, MGVT06P, MGVT10D, MGVT10P, MVE042P, MVE051P		
<b>accessories for</b>	380550		
	<b>Part No.</b>	380555	<b>Ref. No.</b> —
		auxiliary contact contacts 2NO/2NC AC15 16A for contactors DILEM connection screw type DILA-XHI22	
	<b>Part No.</b>	380556	<b>Ref. No.</b> —
		auxiliary contact contacts 4NO AC15 16A for contactors DILM 7-32 connection screw type DILA-XHI40	
	<b>Part No.</b>	380557	<b>Ref. No.</b> —
		auxiliary contact contacts 4NC AC15 16A for contactors DILM 7-32 connection screw type DILA-XHI04	
	<b>Part No.</b>	380558	<b>Ref. No.</b> —
		auxiliary contact contacts 3NO/1NC AC15 16A for contactors DILM 7-32 connection screw type DILA-XHI31	
	<b>Part No.</b>	380559	<b>Ref. No.</b> —
		auxiliary contact contacts 1NO/3NC AC15 16A for contactors DILM 7-32 connection screw type DILA-XHI13	
	<b>Part No.</b>	380568	<b>Ref. No.</b> —
		RC circuit suitable for DILM 9-12 rated 110-240V	



1

<b>Part No.</b>	381005	<b>Ref. No.</b>	R65140560
<b>description</b>	power contactor resistive load 35A 230VAC (AC3/400V) 17A/7.5kW main contacts 3NO auxiliary contacts 1NC connection screw connection type DILM 17-01		
<b>For models:</b>	MACE10M, MACE20M, MEMT10D, MEMT10P, MEVT10D, MEVT10P		

overload switches



1

<b>Part No.</b>	381006	<b>Ref. No.</b>	R65160420
<b>description</b>	overload switch connection screw setting range 1-1.6A type ZB12		
<b>For models:</b>	MACE10M, MACE20M, MEMT10D, MEVT10D		

auxiliary contacts



1

<b>Part No.</b>	380565	<b>Ref. No.</b>	R65140600
<b>description</b>	auxiliary contact contacts 1NO/1NC AC15 10A for contactors DIL 17-32 connection screw type DILM 32-CHI11-S		
<b>For models:</b>	MEMT10D, MEMT10P, MEVT10D, MEVT10P		



## SIEMENS

## power contactors



1

<b>Part No.</b>	380645	<b>Ref. No.</b>	R65140240
<b>description</b>	power contactor 230VAC with auxiliary contacts		
<b>For models:</b>	EC110M, EC210M, EM010M+SC, EM110H, EM110M, EM110M+SC, EM110P, EM210H, EM210M, EM210M+SC, EM210P, EV110H, EV110M, EV110M+SC, EV110P, EV210H, EV210M, EV210M+SC, EV210P, FE110M, FE110X, ME110M, ME110P, ME110X, ME120M, ME120P, ME120X, ME210M, ME210P, ME210X, ME220M, ME220P, ME220X, MEC24H, MEC40M, PE080M, PE080X, VE110M, VE110X, VE120M, VE120P, VE120X, VE210M, VE210P, VE210X, VE220M, VE220P, VE220X		



2

<b>Part No.</b>	381387	<b>Ref. No.</b>	CM187301 MACM187301
<b>description</b>	power contactor resistive load 22A 230VAC (AC3/400V) 4kW main contacts 3NO auxiliary contacts 1NO connection screw connection type 3RT2016-1AP01		



1

<b>Part No.</b>	380652	<b>Ref. No.</b>	LA65140380 LAR65140380
<b>description</b>	power contactor resistive load 22A 230VAC (AC3/400V) 9A/4kW main contacts 3NO auxiliary contacts 1NC connection screw connection type 3RT10-16-1AP02		
<b>For models:</b>	GMT20D, GVT20D, ME061D, ME061M, ME061P, ME061T, ME101D, ME101M, ME101P, ME101T, ME102D, ME102M, ME102P, ME102T, ME201D, ME201M, ME201P, ME201T, ME202D, ME202M, ME202P, ME202T, MEMT20D, MEMT20P, MEMT21D, MEMT21P, MEMT40D, MEMT40P, MEVT20D, MEVT20P, MEVT21D, MEVT21P, MEVT40D, MEVT40P, MG061D, MG061M, MG061P, MG061T, MG101D, MG101M, MG101P, MG101T, MG102D, MG102M, MG102P, MG102T, MG201D, MG201M, MG201P, MG201T...(Other models you can see in the webshop)		



1

<b>Part No.</b>	380389	<b>Ref. No.</b>	1037104800 21450299 21453199 CM187300 MACM187300
<b>description</b>	power contactor resistive load 22A 230VAC (AC3/400V) 9A/4kW main contacts 3NO auxiliary contacts 1NO connection screw connection type 3RT10-16-1AP01		
<b>For models:</b>	AF140MB, AF140MC, AF140MF, AF140MI, AF140MN, AF140MP, AF-70MB, AF70MC, AF70MF, AF70MI, AF70MN, AF70MP, BR707E, BR707EI, BR78EF, BR78EI, BR912EFM, BR912EIM, BR94E, BR94EI, BR98EF, BR98EFM, BR98EI, BR98EIM, BR9M4E, BR9M4EI, BR9M6E, BR9M6EI, BR-9S8EF, BR9S8EI, BR9SB4E, BR9SB4EI, CON102E, CON102EP, CON102G, CON102GP, CON10E, CON10EP, CON10G, CON10GP, CON6E, CON6EP, CON6G, CON6GP, CP704E, CP92E, CP92E2, CP94E, CP94E2, CP9SB2E...(Other models you can see in the webshop)		



1

<b>Part No.</b>	380390	<b>Ref. No.</b>	21407999 21452399 21453599 CM187400 CM187401 MACM187400 MACM187401
<b>description</b>	power contactor resistive load 40A 230VAC (AC3/400V) 12A/5.5kW main contacts 3NO auxiliary contacts connection screw connection type 3RT10-24-1AL20 50/60Hz		
<b>For models:</b>	BR78EF, BR78EI, BR912EFM, BR912EIM, BR94E, BR94EI, BR98EF, BR98EFM, BR98EI, BR98EIM, BR9M4E, BR9M4EI, BR9M6E, BR9M6EI, BR9S8EF, BR9S8EI, BR9SB4E, BR9SB4EI, CON102E, CON102EP, CON10E, CON10EP, CON201E, CON201EP, CS10E, CS10EP, F74E12, F78E12, F94E12, F94E18, F94E18K, F98E12, F98E18, F98E18K, F9S4E12, F9S4E18, F9S4E18K, F9S8E12, F9S8E18, F9S8E18K, FC7E, FR92E13, FR92E132, FR92E13T, FR92E13T2, FR92E22, FR92E22T, FR94E13, FR94E132, FR94E13T...(Other models you can see in the webshop)		



			
1			
<b>Part No.</b>	380646	<b>Ref. No.</b>	R65140400
<b>description</b>	power contactor resistive load 40A 230VAC (AC3/400V) 17A/7.5kW main contacts 3NO auxiliary contacts connection screw connection type 3RT10-25-1AL20		
<b>For models:</b>	ME101D, ME101M, ME101P, ME101T, ME102D, ME102M, ME102P, ME102T, ME201D, ME201M, ME201P, ME201T, ME202D, ME202M, ME202P, ME202T, MEMENT20D, MEMENT20P, MEMENT21D, MEMENT21P, MEVT40D, MEVT40P, MEVT20D, MEVT20P, MEVT21D, MEVT21P, MEVT40D, MEVT40P		

auxiliary contacts

			
1			
<b>Part No.</b>	380653	<b>Ref. No.</b>	R65140420
<b>description</b>	auxiliary contact contacts 1NO/1NC AC15 3A for contactors 3RT101 connection screw connection type 3RH1911-1FA11		
<b>For models:</b>	ME061D, ME061M, ME061P, ME061T, ME101D, ME101M, ME101P, ME101T		

			
1			
<b>Part No.</b>	380647	<b>Ref. No.</b>	R65140430
<b>description</b>	auxiliary contact contacts 1NO/1NC AC15 3A for contactors 3RT102 3 RT103 connection screw connection type 3RH1921-1EA11 resistive load 10A AC-12 10A		
<b>For models:</b>	ME101D, ME101P, ME101T, ME102D, ME102M, ME102P, ME102T, ME201D, ME201M, ME201P, ME201T, ME202D, ME202M, ME202P, ME202T, MEMENT20D, MEMENT20P, MEMENT21D, MEMENT21P, MEMENT40D, MEMENT40P, MEVT20P, MEVT21D, MEVT21P, MEVT40D, MEVT40P		

overload switches

			
1			
<b>Part No.</b>	380655	<b>Ref. No.</b>	R65160150
<b>description</b>	overload switch setting range 0.25-0.4A		
<b>For models:</b>	CVE004H, CVE004M, CVE104H, CVE104M, VE004M, VE004X, VE104M, VE104X		

			
1			
<b>Part No.</b>	380656	<b>Ref. No.</b>	R65160100 R65160110
<b>description</b>	overload switch setting range 0.63-1A		
<b>For models:</b>	CVE105H, CVE105M, CVG105H, CVG105M, EM110H, EM110P, EM210H, EM210P, EV110H, EV110P, EV210H, EV210P, ME106M, ME106P, ME106X, ME110P, ME110X, ME120P, ME120X, ME210P, ME210X, ME220P, ME220X, MEC24H, MG106M, MG106P, MG106X, VE105M, VE105X, VE106M, VE106P, VE106X, VE110X, VE120P, VE120X, VE210P, VE210X, VE220P, VE220X, VG105M, VG105X, VG106M, VG106P, VG106X		

			
1			
<b>Part No.</b>	380659	<b>Ref. No.</b>	R65160570
<b>description</b>	overload switch setting range 0.7-1A connection screw type 3RU1116-0JB0 (AC3/400V) 0.25kW		
<b>For models:</b>	ME101P, ME101T, ME102P, ME102T, ME201P, ME201T, ME202P, ME202T, MEMENT20P, MEMENT21P, MEMENT40P, MEVT20P, MEVT21P, MEVT40P		

			
1			
<b>Part No.</b>	380661	<b>Ref. No.</b>	LA65160620 LAR65160620
<b>description</b>	overload switch setting range 1.4-2.0A connection screw type 3RU1116-1BB0 (AC3/400V) 0.75kW		
<b>For models:</b>	ME101D, ME101M, ME101P, ME101T, ME201D, ME201M, ME201P, ME201T, MEMENT21D, MEMENT21P, MEVT21D, MEVT21P, MG101P, MG101T, MG201P, MG201T, MG202P, MG202T, MGMT21P, MGMT40P, MGVT21P, MGVT40P		



			
1			
<b>Part No.</b>	380657	<b>Ref. No.</b>	R65160120
<b>description</b>	overload switch setting range 1.8-2.5A		
<b>For models:</b>	EC110M, EC210M, EM010M+SC, EM110H, EM110M, EM110M+SC, EM110P, EM210H, EM210M, EM210M+SC, EM210P, EV110H, EV110M, EV110M+SC, EV110P, EV210H, EV210M, EV210M+SC, EV210P, FE110M, FE110X, FE210M, FG110X, FG210X, GM110H, GM110P, GM210H, GM210P, GV110H, GV110P, GV210H, GV210P, ME110M, ME110P, ME110X, ME120M, ME120P, ME120X, ME210M, ME210P, ME210X, ME220M, ME220P, ME220X, MEC24H, MEC40M, MG110P, MG110X, MG120P, MG120X...(Other models you can see in the webshop)		





			
2			
<b>Part No.</b>	381002	<b>Ref. No.</b>	R65160580
<b>description</b>	overload switch setting range 1.8-2.5A		

## motor protection circuit breakers

			
1			
<b>Part No.</b>	382000	<b>Ref. No.</b>	R65160590
<b>description</b>	motor protection circuit breaker type 3RU1116-1EBO setting range 2.8-4A (AC3/400V) 1.5kW		
<b>For models:</b>	GMT20D, GVT20D, MG101D, MG101M, MG101P, MG101T, MG201D, MG201M, MG201P, MG201T, MG202D, MG202M, MG202P, MG202T, MGMT21D, MGMT21P, MGMT40D, MGMT40P, MGVT21D, MGVT21P, MGVT40D, MGVT40P		

## miscellaneous

## kits

				
1				
<b>Part No.</b>	381158	<b>Ref. No.</b>	R65160130	
<b>description</b>	overload switch kit			
<b>For models:</b>	FG110M, FG110X, FG210M, FG210X, GC110M, GC210M, GM110H, GM110M, GM110M+SC, GM110P, GM210H, GM210M, GM210M+SC, GM210P, GV110H, GV110M, GV110M+SC, GV110P, GV210H, GV210M, GV210M+SC, GV210P, MG110M, MG110P, MG110X, MG120M, MG120P, MG120X, MG210M, MG210P, MG210X, MG220M, MG220P, MG220X, MGC20X, MGC24H, MGC40H, PG080M, PG080X, VG110M, VG110P, VG110X, VG120M, VG120P, VG120X, VG210M, VG210P, VG210X, VG220M, VG220P...(Other models you can see in the web-shop)			
<b>spare parts for</b>	381158			
	<b>Part No.</b>	380652	<b>Ref. No.</b>	LA65140380 LAR65140380 R65140380
	power contactor resistive load 22A 230VAC (AC3/400V) 9A/4kW main contacts 3NO auxiliary contacts 1NC connection screw connection type 3RT10-16-1AP02			
	<b>Part No.</b>	380660	<b>Ref. No.</b>	—
	base			
	<b>Part No.</b>	381071	<b>Ref. No.</b>	—
	overload switch setting range 3.5-5A			

## power contactors

			
1			
<b>Part No.</b>	380654	<b>Ref. No.</b>	R65140150 R65140170
<b>description</b>	power contactor 230V with auxiliary contacts		
<b>For models:</b>	CVE004H, CVE004M, CVE104H, CVE104M, CVE105H, CVE105M, CVG105H, CVG105M, EC106M, EC110M, EC210M, EM010M+SC, EM106H, EM106M, EM106M+SC, EM106P, EM110H, EM110M, EM110M+SC, EM110P, EM210H, EM210M, EM210M+SC, EM210P, EV006M, EV106H, EV106M, EV106M+SC, EV106P, EV110H, EV110M, EV110M+SC, EV110P, EV210H, EV210M, EV210M+SC, EV210P, FE105M, FE105X, FE110M, FE110X, FE210M, FG105M, FG105X, FG110M, FG110X, FG210M, FG210X, GC106M, GC110M...(Other models you can see in the webshop)		



relays





power relays

with DIN rail mounting

lateral



1

<b>Part No.</b>	380336	<b>Ref. No.</b>	R65170100
<b>description</b>	power relays FINDER 230VAC 16A 2NO connection male faston 6.3mm DIN rail manuf. no. 62.82.8.230.0308		
<b>For models:</b>	CVE004H, CVE104H, MVE042P, MVE051P, MVG051P		
<b>accessories for</b>	380336		
	<b>Part No.</b>	380703	<b>Ref. No.</b> —
	adapter for flange mounting suitable for Finder relay 62 series.		
	<b>Part No.</b>	380811	<b>Ref. No.</b> —
	adapter with bracket mounting suitable for Finder relay 62 series.		
	<b>Part No.</b>	380954	<b>Ref. No.</b> —
	adapter hole distance 54mm bracket mounting suitable for Finder relay 62 series. L 41mm W 39mm H 49mm		
	<b>Part No.</b>	381003	<b>Ref. No.</b> —
	adapter for DIN rail mounting suitable for Finder relay 62 series.		
	<b>Part No.</b>	381039	<b>Ref. No.</b> —
	adapter for DIN rail mounting suitable for Finder relay 62 series.		



1

<b>Part No.</b>	380379	<b>Ref. No.</b>	890029 SIRA890029 SIRRA890029
<b>description</b>	power relays SCHRACK 230VAC 25A 2CO connection male faston 6.3mm DIN rail manuf. no. RM809730		

with flange mounting



1

<b>Part No.</b>	380131	<b>Ref. No.</b>	120459
<b>description</b>	power relays Italiana Relè 230VAC 16A 3CO connection male faston 6.3mm screw mounting manuf. no. B2-3-230AC		

with bracket mounting



1

<b>Part No.</b>	380815	<b>Ref. No.</b>	CR0687240
<b>description</b>	power relays 230VAC 16A 2NO connection male faston 6.3mm flange dimensions 36x38x68mm		

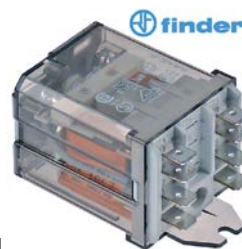

1

<b>Part No.</b>	380139	<b>Ref. No.</b>	CR0413170
<b>description</b>	power relays FINDER 230VAC 16A 2CO connection F6.3 bracket mounting dimensions 68x38.2x35.8mm manuf. no. 62.82.8.230.0000		
<b>For models:</b>	FB110F, FB110N, FB110P, FB140F, FB140FN, FB140N, FB140NN, FB140P, FB140PF, FB140PN, FB140PP, FB143NI, FB55F, FB55N, FB55P, FB70F, FB70N, FB70P, FB72F, FB72N, FB72NF, FB72P, SPAR16, SPAR20, SPRG12, SPRG16, SPRG20, SVAR16, SVAR20, SVRG12, SVRG16, SVRG20		





with male contacts

female contact 2.0mm



1

<b>Part No.</b>	380382	<b>Ref. No.</b>	2998400 MA2998400
<b>description</b>	power relays 16A 1CO plug-in connection 250V connection 2mm		
<b>For models:</b>	CON102E, CON102EP, CON102G, CON102GP, CON10E, CON10EP, CON10G, CON10GP, CON6E, CON6EP, CON6G, CON6GP		
<b>accessories for</b>	380382		
	<b>Part No.</b>	380341	<b>Ref. No.</b> 2998500
	relay socket 4-pole contacts 12 300V voltage AC 6A Italiana Relè manuf. no. ZMD4		
	<b>Part No.</b>	380378	<b>Ref. No.</b> —
	relay socket 2-pole 55/85 dimensions 70.5x30x27mm 250V voltage AC 10A FINDER manuf. no. 94.72		
	<b>Part No.</b>	380384	<b>Ref. No.</b> —
	relay socket 2-pole contacts male faston 2.8mm 250V voltage AC 10A W 23mm for		
	<b>Part No.</b>	380399	<b>Ref. No.</b> —
	relay socket 4-pole dimensions 76.2x27x86.1mm 250V voltage AC 1A FINDER manuf. no. 94.94.3		

plug-in/print relays



1

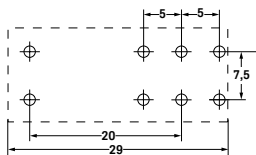

<b>Part No.</b>	380333	<b>Ref. No.</b>	R65170050
<b>description</b>	print relay 230VAC 2CO at 250V 8A connection pins raster size 5mm FINDER manuf. no. 40.52.8.230.0000 95.65/95.75		
<b>For models:</b>	ME061M, ME101M, ME102D, ME102M, ME106M, ME106X, ME110M, ME110X, ME120M, ME120X, ME201M, ME202M, ME210M, ME210X, ME220M, ME220X, MEC40M, MEMT06P, MEMT10P, MEMT20P, MEMT21P, MEMT40P, MG061M, MG101M, MG102M, MG106M, MG106X, MG110M, MG110X, MG120M, MG120X, MG201M, MG202M, MG210M, MG210X, MG220M, MG220X, MGC20X, MGMT06P, MGMT10P, MGMT20P, MGMT21P, MGMT40P, VE106M, VE106X, VE110M, VE110X, VE120M, VE120X, VE210M...(Other models you can see in the webshop)		
<b>accessories for</b>	380333		
	<b>Part No.</b>	380340	<b>Ref. No.</b> 5151400 MA5151400
	relay socket dimensions 62x36x15mm 250V voltage AC 10A Italiana Relè manuf. no. ZMEM/5		
	<b>Part No.</b>	380505	<b>Ref. No.</b> —
	relay socket 2CO 40.52 dimensions 81.9x15.5x75mm 250V voltage AC 10A FINDER manuf. no. 95.95.3		
	<b>Part No.</b>	381181	<b>Ref. No.</b> —
	relay socket 2-pole 40.51/40.52/40.61 connection screw clamp dimensions 15.8x78.6mm 250V voltage AC 10A FINDER manuf. no. 95.75		



1

<b>Part No.</b>	380331	<b>Ref. No.</b>	51513.00 MA5151300
<b>description</b>	print relay 24VAC 1CO at 250V 10A connection pins raster size 5mm		
<b>For models:</b>	CON201E, CON201EP, CON201G, CON201GP, CON202E, CON202EP, CON202G, CON202GP, CP9A15GD, CSM102E, CSM102EP, CSM102G, CSM102GP, CSM10E, CSM10EP, CSM10G, CSM10GP, CSM201E, CSM201EP, CSM201G, CSM201GP, CSM202E, CSM202EP, CSM202G, CSM202GP, CSM6E, CSM6EP, CSM6G, CSM6GP		
<b>accessories for</b>	380331		
	<b>Part No.</b>	380340	<b>Ref. No.</b> 5151400 MA5151400
	relay socket dimensions 62x36x15mm 250V voltage AC 10A Italiana Relè manuf. no. ZMEM/5		
	<b>Part No.</b>	380505	<b>Ref. No.</b> —
	relay socket 2CO 40.52 dimensions 81.9x15.5x75mm 250V voltage AC 10A FINDER manuf. no. 95.95.3		
	<b>Part No.</b>	381181	<b>Ref. No.</b> —
	relay socket 2-pole 40.51/40.52/40.61 connection screw clamp dimensions 15.8x78.6mm 250V voltage AC 10A FINDER manuf. no. 95.75		

relay sockets



1

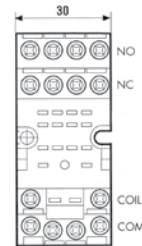

<b>Part No.</b>	380341	<b>Ref. No.</b>	2998500
<b>description</b>	relay socket 4-pole contacts 12 300V voltage AC 6A Italiana Relè manuf. no. ZMD4		
<b>For models:</b>	CON102E, CON102EP, CON102G, CON102GP, CON10E, CON10EP, CON10G, CON10GP, CON6E, CON6EP, CON6G, CON6GP, CP9A15GD		
<b>accessories for</b>	380341		
	<b>Part No.</b>	380804	<b>Ref. No.</b> —
	support bracket		



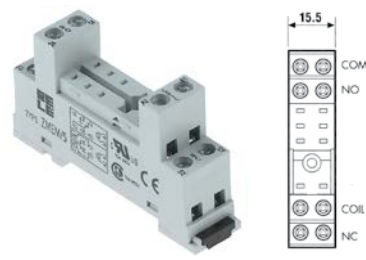

			
1			
<b>Part No.</b>	380638	<b>Ref. No.</b>	2609500 MA2609500
<b>description</b>	relay socket 8-pole dimensions 51x41x23mm 250V 10A FINDER manuf. no. 90.26		
<b>For models:</b>	CS10E, CS10EP, CS10G, CS6E, CS6EP, CS6G, FV4E, FV4E1, HF140DPF, NF140DF, NF140DFN, NF140DN, NF140DNI, NF140DNN, NF140DP, NF140DPN, NF140DPP, NF143DNF, NF143DNI, NF143DNP, NF14DNG, NF70DF, NF70DI, NF70DN, NF70DP, NF72DNF, NF72DNI, NF72DNN, NF7DFG, NF7DNG, NPI76E5, NPI76G5, NPI78E8, NPI78G8, NPI96E5, NPI96G5, NPI98E10, NPI98E15, NPI98G10, NPI98G14, NPI98G14A, SPAR16, SPAR20, SPRG12, SPRG16, SPRG20, SVAR16, SVAR20, SVRG12, SVRG16...(Other models you can see in the webshop)		

			
2			
<b>Part No.</b>	380340	<b>Ref. No.</b>	5151400 MA5151400
<b>description</b>	relay socket dimensions 62x36x15mm 250V voltage AC 10A Italiana Relè manuf. no. ZMEM/5		
<b>For models:</b>	CON201E, CON201EP, CON201G, CON201GP, CON202E, CON202EP, CON202G, CON202GP, CP9A15GD, CSM102E, CSM102EP, CSM102G, CSM102GP, CSM10E, CSM10EP, CSM10G, CSM10GP, CSM201E, CSM201EP, CSM201G, CSM201GP, CSM202E, CSM202EP, CSM202G, CSM202GP, CSM6E, CSM6EP, CSM6G, CSM6GP		

level relays

GICAR



			
1			
<b>Part No.</b>	401224	<b>Ref. No.</b>	R65120010
<b>description</b>	level relay 230V connection F6.3 type RL30/3ES/F/G		
<b>For models:</b>	EM010M+SC, EM106M, EM106M+SC, EM110M, EM110M+SC, EM210M, EM210M+SC, GM106M, GM106M+SC, GM110M, GM110M+SC, GM210M, GM210M+SC, ME061M, ME101M, ME102D, ME102M, ME106M, ME106X, ME110M, ME110X, ME120M, ME120X, ME201M, ME202M, ME210M, ME210X, ME220M, ME220X, MEC40M, MG061M, MG101M, MG102M, MG106M, MG106X, MG110M, MG110X, MG120M, MG120X, MG201M, MG202M, MG210M, MG210X, MG220M, MG220X, MGC20X		

time relays

time relays

			
1			
<b>Part No.</b>	381421	<b>Ref. No.</b>	R65090450
<b>description</b>	time relay CROUZET EMAR7 88 829 117 time range 0.1s-20h 240VAC 5A NO connection grip connection		
<b>For models:</b>	CVG105H, CVG105M, MACG05M, MACG07M, MACG10M, MACG20M, ME061M, ME101M, ME102D, ME102M, ME201M, ME202M, MEC40M, MG061M, MG101M, MG102M, MG106M, MG106P, MG106X, MG110M, MG110P, MG110X, MG120M, MG120P, MG120X, MG201M, MG202M, MG210M, MG210P, MG210X, MG220M, MG220P, MG220X, MGC20X, MGC24H, MGC40H, VG105M, VG105X, VG106M, VG106P, VG106X, VG110M, VG110P, VG110X, VG120M, VG120P, VG120X, VG210M, VG210P, VG210X...(Other models you can see in the webshop)		

			
1			
<b>Part No.</b>	380489	<b>Ref. No.</b>	LA65090480 LAR65090480
<b>description</b>	time relay CROUZET MUR1-88826105 time range 0.1s-100h 24-240VAC/24VDC 8A mounting measurements DIN railmm 1CO connection grip connection		
<b>For models:</b>	EM010M+SC, EM106M, EM106M+SC, EM110M, EM110M +SC, EM210M, EM210M+SC, GM106M, GM106M+SC, GM110M, GM110M+SC, GM210M, GM210M+SC, MVE042P		

			
1			
<b>Part No.</b>	380329	<b>Ref. No.</b>	R65090460
<b>description</b>	time relay FIBER 85.02.8.240 time range 0.05s - 100h 230-240VAC 10A mounting measurements 20.6x27.7mm 2CO connection 2.0		
<b>For models:</b>	ME106M, ME106X, ME110M, ME110X, ME120M, ME120X, ME210M, ME210X, ME220M, ME220X, MG106M, MG106X, MG110M, MG110X, MG120M, MG120X, MG210M, MG210X, MG220M, MG220X		
<b>accessories for</b>	380329		
		<b>Part No.</b>	380378
		<b>Ref. No.</b>	—
		relay socket 2-pole 55/85 dimensions 70.5x30x27mm 250V voltage AC 10A FINDER manuf. no. 94.72	
		<b>Part No.</b>	380803
		<b>Ref. No.</b>	—
		relay socket 2-pole dimensions 76.2x27x86.1mm 250V voltage AC 10A FINDER manuf. no. 94.92.3	



## transformers

### open transformers

#### with clamp terminal



<b>Part No.</b>	401152	<b>Ref. No.</b>	5153000 MA5153000
<b>description</b>	transformer primary 230/400V secondary 12V 100VA		
<b>For models:</b>	CP9A15GD, CSM102G, CSM102GP, CSM10G, CSM10GP, CSM6E, CSM6EP, CSM6G, CSM6GP		



<b>Part No.</b>	401153	<b>Ref. No.</b>	5153100 MA5153100
<b>description</b>	transformer primary 230/400V secondary 12V 160VA		
<b>For models:</b>	CON201E, CON201EP, CON201G, CON201GP, CON202E, CON202EP, CON202G, CON202GP, CSM102E, CSM102EP, CSM10E, CSM10EP, CSM201E, CSM201EP, CSM201G, CSM201GP, CSM202E, CSM202EP, CSM202G, CSM202GP		

### toroidal core transformers

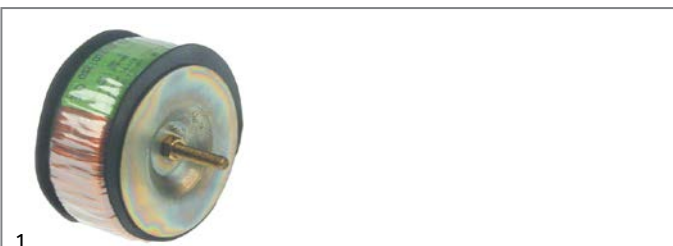

<b>Part No.</b>	401151	<b>Ref. No.</b>	5159300 MA5159300
<b>description</b>	transformer primary 230V secondary 12V 20VA		
<b>For models:</b>	CON102E, CON102EP, CON102G, CON102GP, CON10E, CON10EP, CON10G, CON10GP, CON201E, CON201EP, CON201G, CON201GP, CON202E, CON202EP, CON202G, CON202GP, CON6E, CON6EP, CON6G, CON6GP, CP9A15GD, CSM102E, CSM102EP, CSM102G, CSM102GP, CSM10E, CSM10EP, CSM10G, CSM10GP, CSM201E, CSM201EP, CSM201G, CSM201GP, CSM202E, CSM202EP, CSM202G, CSM202GP, CSM6E, CSM6EP, CSM6G, CSM6GP		

## encapsulated transformers

### with screw connection



<b>Part No.</b>	400127	<b>Ref. No.</b>	LA65180430 LAR65180430
<b>description</b>	transformer primary 230VAC secondary 12VAC 40VA secondary 3.2A H 63mm L 75mm W 78mm connection 2-wire connection systems 50/60Hz moulded		
<b>For models:</b>	EC110M, EC210M, EM010M+SC, EM110H, EM110M, EM110M+SC, EM110P, EM210H, EM210M, EM210M+SC, EM210P, EV110H, EV110M, EV110M+SC, EV110P, EV210H, EV210M, EV210M+SC, EV210P, FG110X, FG210X, GC110M, GC210M, GM110H, GM110M, GM110M+SC, GM110P, GM210H, GM210M+SC, GM210P, GMT20D, GV110H, GV110M, GV110M+SC, GV110P, GV210H, GV210M+SC, GV210P, GVT20D, ME101D, ME101M, ME101P, ME101T, ME102D, ME102M, ME102P, ME102T, ME110P, ME110X, ME120P...(Other models you can see in the webshop)		

### PMA



<b>Part No.</b>	401340	<b>Ref. No.</b>	R65180770
<b>description</b>	transformer primary 220/240V secondary 24V 50VA secondary 2.1A connection screw 50/60Hz		
<b>For models:</b>	GMT06D, GMT20D, GVT06D, GVT20D, MACG05M, MACG07M, MACG10M, MACG20M, MG061D, MG061M, MG061P, MG061T, MG101D, MG101M, MG101P, MG101T, MG102D, MG102M, MG102P, MG102T, MG201D, MG201M, MG201P, MG201T, MG202D, MG202M, MG202P, MG202T, MGMT06D, MGMT06P, MGMT10D, MGMT10P, MGMT20D, MGMT20P, MGMT21D, MGMT21P, MGMT40D, MGMT40P, MGVT06D, MGVT06P, MGVT10D, MGVT10P, MGVT20D, MGVT20P, MGVT21D, MGVT21P, MGVT40D, MGVT40P, MVG051P		

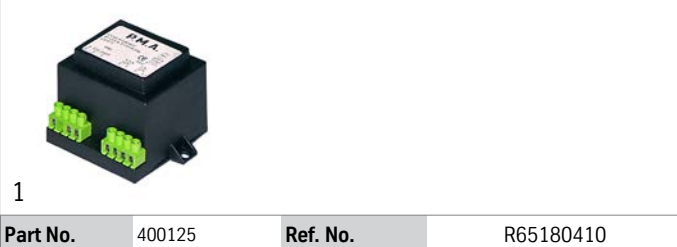

<b>Part No.</b>	400125	<b>Ref. No.</b>	R65180410
<b>description</b>	transformer primary 220-240V secondary 12V 16VA secondary 12V/0.3A/1AA connection screw 50Hz		
<b>For models:</b>	EM106P, EM110P, EM210P, EV106P, EV110P, EV210P, GM106P, GM110P, GM210P, GV106P, GV110P, GV210P, ME106P, ME110P, ME120P, ME210P, ME220P, MG106P, MG110P, MG120P, MG210P, MG220P, VE106P, VE120P, VE210P, VE220P, VG106P, VG110P, VG120P, VG210P, VG220P		



<p>1</p>			
<b>Part No.</b>	400126	<b>Ref. No.</b>	LA65180420 LAR65180420
<b>description</b>	transformer primary 230VAC secondary 12VAC 20VA secondary 2.1A connection screw 50Hz		
<b>For models:</b>	EC106M, EM106H, EM106M, EM106M+SC, EM106P, EV006M, EV106H, EV106M, EV106M+SC, EV106P, FE105X, FG105X, GC106M, GM106H, GM106M, GM106M+SC, GM106P, GMT06D, GMT20D, GV106H, GV106M, GV106M+SC, GV106P, GVT06D, GVT20D, MACE07M, MACE10M, MACE20M, MACG07M, MACG10M, MACG20M, ME061D, ME061M, ME061P, ME061T, ME101P, ME101T, ME102P, ME102T, ME106P, ME106X, ME201P, ME201T, ME202P, ME202T, MEMT06D, MEMT06P, MEMT10D, MEMT10P, MEMT20D...(Other models you can see in the webshop)		

<p>1</p>			
<b>Part No.</b>	379054	<b>Ref. No.</b>	24706.00 MA2470600
<b>description</b>	transformer primary 230VAC secondary 12VAC 3VA secondary 0.25A H 40mm L 45mm W 50mm connection screw 50/60Hz type 153/M		
<b>For models:</b>	SER15, SER15A, SER18, SER18A, SER21		

<b>accessories for</b>	379563			
	<b>Part No.</b>	379064	<b>Ref. No.</b>	23745.00 MA2374500
	temperature probe PTC 1kOhm cable silicone probe -50 up to +150°C cable -50 up to +180°C probe ø6x40mm cable length 3m without screw connection 2-wire			
	<b>Part No.</b>	379161	<b>Ref. No.</b>	—
	temperature probe NTC 10kOhm cable thermoplastic probe -40 up to +110°C cable -40 up to +110°C probe ø6x14mm cable length 3m without screw connection 2-wire			
	<b>Part No.</b>	379782	<b>Ref. No.</b>	—
	temperature probe PTC 1kOhm cable thermoplastic probe -50 up to +150°C cable -40 up to +110°C probe ø6x14mm cable length 3m 2-wire resistor 1kOhm			

SHANGFANG

accessories

<p>1</p>			
<b>Part No.</b>	379054	<b>Ref. No.</b>	24706.00 MA2470600
<b>description</b>	transformer primary 230VAC secondary 12VAC 3VA secondary 0.25A H 40mm L 45mm W 50mm connection screw 50/60Hz type 153/M		
<b>For models:</b>	SER15, SER15A, SER18, SER18A, SER21		

electronic controllers

ELIWELL

universal controllers

built-in version

<p>71 x 29mm</p> <p>1</p>				
<b>Part No.</b>	379563	<b>Ref. No.</b>	2959300 MA2959300	
<b>description</b>	electronic controller ELIWELL type ICPlus902 mounting measurements 71x29mm 230V voltage AC NTC/PTC relay outputs 1 relay CO-8A(4) defr. funct. no -55 up to +150°C display 3½ digits Templn1 yes 8A			
<b>For models:</b>	CON102E, CON102EP, CON102G, CON102GP, CON10E, CON10EP, CON10G, CON10GP, CON201E, CON201EP, CON201G, CON201GP, CON202E, CON202EP, CON202G, CON202GP, CON6E, CON6EP, CON6G, CON6GP, CP9A15GD, CS4E, CS4EP, CSM102E, CSM102EP, CSM102G, CSM102GP, CSM10E, CSM10EP, CSM10G, CSM10GP, CSM201, CSM201E, CSM201EP, CSM201G, CSM201GP, CSM202, CSM202E, CSM202EP, CSM202G, CSM202GP, CSM6E, CSM6EP, CSM6G, CSM6GP			
<b>accessories for</b>	379563			
	<b>Part No.</b>	379053	<b>Ref. No.</b>	—
	temperature probe PTC 1kOhm cable PVC probe -50 up to +150°C cable -10 up to 100°C probe ø6x30mm cable length 3m without screw connection 2-wire			

probes

universal probes

temperature probes

<p>1</p>			
<b>Part No.</b>	379130 <sup>1</sup>	<b>Ref. No.</b>	R65325000
<b>description</b>	temperature probe Pt100 cable Vetrotex probe -200 up to +600°C cable -50 up to +350°C probe ø6x100mm cable length 1.4m without screw connection 3-wire resistance at 0°C 100Ohm		
<b>For models:</b>	CVE004H, CVE104H, CVE105H, CVG105H, EM106H, EM106P, EM110H, EM110P, EM210H, EM210P, EV106H, EV106P, EV110H, EV110P, EV210H, EV210P, GM106H, GM106P, GM110H, GM110P, GM210H, GM210P, GMT06D, GMT20D, GV106H, GV106P, GV110H, GV110P, GV210H, GV210P, GVT06D, GVT20D, ME061D, ME061P, ME061T, ME101D, ME101P, ME101T, ME102P, ME102T, ME106P, ME110P, ME120P, ME201D, ME201P, ME201T, ME202D, ME202P, ME202T, ME210P... (Other models you can see in the webshop)		

<sup>1</sup>3-wire

<p>1</p>			
<b>Part No.</b>	379050 <sup>1</sup>	<b>Ref. No.</b>	R65325010
<b>description</b>	temperature probe Pt100 cable Vetrotex probe -200 up to +600°C cable -50 up to +350°C probe ø6x100mm cable length 2.7m without screw connection 3-wire		
<b>For models:</b>	ME201D, ME202D, ME220P, MEC24H, MEMT21D, MEMT21P, MEMT40D, MEVT21D, MEVT21P, MEVT40D, MEVT40P, MG201D, MG202D, MG220P, MGC24H, MGC40H, MGMT21D, MGMT21P, MGMT40D, MGVT21D, MGVT21P, MGVT40D, MGVT40P		

<sup>1</sup>3-wire



<b>Part No.</b>	379064	<b>Ref. No.</b>	23745.00 MA2374500
<b>description</b>	temperature probe PTC 1kOhm cable silicone probe -50 up to +150°C cable -50 up to +180°C probe ø6x40mm cable length 3m without screw connection 2-wire		
<b>For models:</b>	BR120, BR160, EF140DF, EF140DN, EF140DP, EF143DNF, EF70DF, EF-70DN, EF70DP, EF72DNF, F140DF, F140DI, F140DN, F140DP, F14DFG, F14DNG, F70DF, F70DI, F70DN, F70DP, F7DFG, F7DNG, IR13C, IR13CC, IR13CV, IR13M, IR13MC, IR13MV, IR13V, IR17C, IR17CC, IR17CV, IR17M, IR17MC, IR17MV, IR17V, NF140DF, NF140DFN, NF140DN, NF140DNI, NF140DNN, NF140DP, NF140DPN, NF140DPP, NF143DNF, NF143DNI, NF143DNP, NF14DNG, NF70DF, NF70DI...(Other models you can see in the webshop)		

<b>Part No.</b>	381363	<b>Ref. No.</b>	LAR65320220
<b>description</b>	temperature probe thermocouple K (NiCr-Ni) probe -50 up to 1150°C cable -50 up to +180°C cable length 1.5m thread M10x1 adapter length 93mm adapter ø 6mm cable colours silver/yellow probe L 90/14mm probe ø 6/3mm		

producer-specific probes

probes

<b>Part No.</b>	379143	<b>Ref. No.</b>	R65325020
<b>description</b>	temperature probe Pt100 cable Vetrotex probe -200 up to +600°C cable -50 up to +350°C connection 2-wire thread probe ø3-6x90mm cable length 5m		
<b>For models:</b>	ME220P, MG220P, MGC40H, VE220P, VG220P		
<b>spare parts for</b>	379143		
	<b>Part No.</b>	100909	<b>Ref. No.</b> LA62060223 LAR62060223
	union screw thread M10x1 for pipe ø 6mm Qty 1 pcs		
	<b>Part No.</b>	101286	<b>Ref. No.</b> 961500 LA62070023 LAR62070023
	olive ID ø 6mm Qty 1 pcs		

core probes

<b>Part No.</b>	379134	<b>Ref. No.</b>	R65320900
<b>description</b>	core temperature probe Pt100 cable PTFE probe -40 up to +250°C cable -40 up to +250°C connection plug probe ø4x100mm thread cable length 1m handle ø 15mm handle length 83mm		
<b>For models:</b>	CVE004H, CVE104H, CVE105H, CVG105H, EM010M+SC, EM106H, EM106M+SC, EM106P, EM110H, EM110M+SC, EM110P, EM210H, EM210M+SC, EM210P, EV106H, EV106M+SC, EV106P, EV110H, EV110M+SC, EV110P, EV210H, EV210M+SC, EV210P, GM106H, GM106M+SC, GM106P, GM110H, GM110M+SC, GM110P, GM210H, GM210M+SC, GM210P, GV106H, GV106M+SC, GV106P, GV110H, GV-110M+SC, GV110P, GV210H, GV210M+SC, GV210P, ME061M, ME101M, ME102M, ME106P, ME106X, ME110P, ME110X, ME120P, ME120X...(Other models you can see in the webshop)		

<b>Part No.</b>	379132	<b>Ref. No.</b>	2912400 LAR65320180
<b>description</b>	core temperature probe Pt100 cable SS corrugated hose probe -40 up to +250°C cable -40 up to +250°C connection 2-wire probe ø4x100mm thread 1/8" cable length 2.5m handle ø 9mm handle length 85mm		
<b>For models:</b>	CS10E, CS10EP, CS10G, CS6E, CS6EP, CS6G		

<b>Part No.</b>	379510	<b>Ref. No.</b>	LA65321102 LAR65321100
<b>description</b>	core temperature probe thermocouple K (NiCr-Ni) cable PTFE probe -40 up to +250°C cable -40 up to +250°C connection 6-pin connector probe ø3.5x90mm thread cable length 1.1m handle ømm handle length 90mm		
<b>For models:</b>	ME061T, ME101T, ME102T, ME201T, ME202T, MG061T, MG101T, MG102T, MG201T, MG202T		

<b>Part No.</b>	379773 <sup>1</sup>	<b>Ref. No.</b>	R65321120
<b>description</b>	core temperature probe thermocouple K (NiCr-Ni) cable PTFE probe -40 up to +250°C cable -40 up to +250°C connection plug probe ø3.5x90mm thread cable length 1.1m handle ømm handle length 90mm		
<b>For models:</b>	GMT06D, GMT20D, GVT06D, GVT20D, ME061D, ME061P, ME101D, ME101P, ME102D, ME102P, ME201D, ME201P, ME202D, ME202P, MEMT06D, MEMT06P, MEMT10D, MEMT10P, MEMT20D, MEMT20P, MEMT21D, MEMT21P, MEMT40D, MEMT40P, MEVT06D, MEVT06P, MEVT10D, MEVT10P, MEVT20D, MEVT20P, MEVT21D, MEVT21P, MEVT40D, MEVT40P, MG061D, MG061P, MG101D, MG101P, MG102D, MG102P, MG201D, MG201P, MG202D, MG202P, MGMT06D, MGMT06P, MGMT10D, MGMT10P, MGMT20D, MGMT20P...(Other models you can see in the webshop)		

<sup>1</sup>multipoint probe

accessories

plugs/bushes

<b>Part No.</b>	378016	<b>Ref. No.</b>	R65320920
<b>description</b>	female connector 4-pole		
<b>For models:</b>	CVE004H, CVE104H, CVE105H, CVG105H, EM010M+SC, EM106H, EM106M+SC, EM106P, EM110H, EM110M+SC, EM110P, EM210H, EM210M+SC, EM210P, EV106H, EV106M+SC, EV106P, EV110H, EV110M+SC, EV110P, EV210H, EV210M+SC, EV210P, GM106H, GM106M+SC, GM106P, GM110H, GM110M+SC, GM110P, GM210H, GM210M+SC, GM210P, GMT06D, GMT20D, GV106H, GV106M+SC, GV106P, GV110H, GV110M+SC, GV110P, GV210H, GV210M+SC, GV210P, GVT06D, GVT20D, ME061D, ME061M, ME061P, ME101D, ME101M...(Other models you can see in the webshop)		



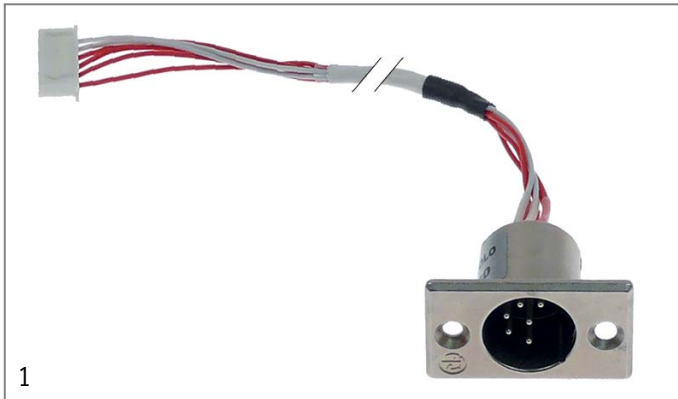

1	<b>Part No.</b>	381462	<b>Ref. No.</b>	LA65321360
	<b>description</b>	female connector with cable 6-pole for combi-steamer L 1000mm		



1	<b>Part No.</b>	378017	<b>Ref. No.</b>	R65321020
	<b>description</b>	lid for plug contact		
<b>For models:</b>	CVE004H, CVE104H, CVE105H, CVG105H, EM010M+SC, EM106H, EM106M+SC, EM106P, EM110H, EM110M+SC, EM110P, EM210H, EM210M+SC, EM210P, EV106H, EV106M+SC, EV106P, EV110H, EV110M+SC, EV110P, EV210H, EV210M+SC, EV210P, GM106H, GM106M+SC, GM106P, GM110H, GM110M+SC, GM110P, GM210H, GM210M+SC, GM210P, GMT06D, GMT20D, GV106H, GV106M+SC, GV106P, GV110H, GV110M+SC, GV110P, GV210H, GV210M+SC, GV210P, GVT06D, GVT20D, ME061D, ME061M, ME061P, ME061T, ME101D...(Other models you can see in the webshop)			

miscellaneous



1	<b>Part No.</b>	379856	<b>Ref. No.</b>	R86020420
	<b>description</b>	bag for core temperature probe		
<b>For models:</b>	CVE004H, CVE104H, CVE105H, CVG105H, EM010M+SC, EM106H, EM106M+SC, EM106P, EM110H, EM110M+SC, EM110P, EM210H, EM210M+SC, EM210P, EV106H, EV106M+SC, EV106P, EV110H, EV110M+SC, EV110P, EV210H, EV210M+SC, EV210P, GM106H, GM106M+SC, GM106P, GM110H, GM110M+SC, GM110P, GM210H, GM210M+SC, GM210P, GMT06D, GMT20D, GV106H, GV106M+SC, GV106P, GV110H, GV110M+SC, GV110P, GV210H, GV210M+SC, GV210P, GVT06D, GVT20D, ME061D, ME061M, ME101D, ME101M, ME102D...(Other models you can see in the webshop)			

electronics

frequency converters

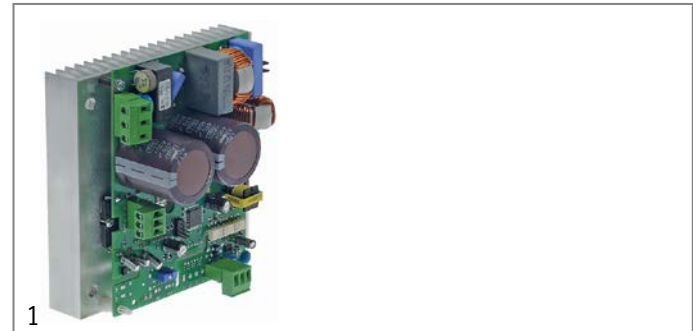

1	<b>Part No.</b>	403841	<b>Ref. No.</b>	LAR65140890
	<b>description</b>	frequency converter with heat sink for combi-steamer L 135mm W 135mm 800W ECS P0010205-0		

PCBs

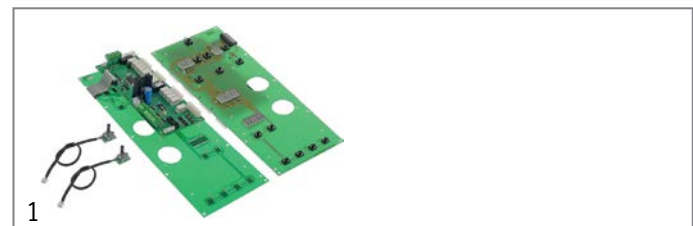

1	<b>Part No.</b>	403472	<b>Ref. No.</b>	R65301400
	<b>description</b>	control PCB combi-steamer VE 061/1011 L 410mm W 150mm suitable for LAINOX		
<b>For models:</b>	MEVT06P, MEVT10P, MEVT20P, MEVT21P, MEVT40P, MGVT06P, MGVT10P, MGVT20P, MGVT21P, MGVT40P			

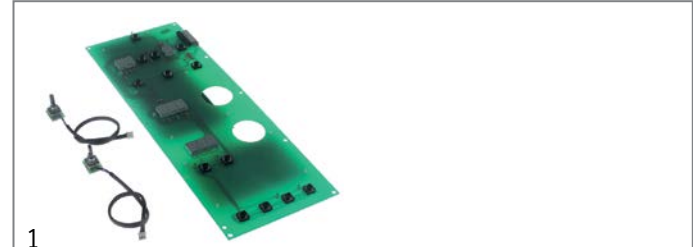



1	<b>Part No.</b>	402427	<b>Ref. No.</b>	R65301370 R65301390
	<b>description</b>	control PCB L 410mm W 150mm for LAINOX buttons 13		
<b>For models:</b>	ME061P, ME101P, ME102P, ME201P, ME202P, MEMT06P, MEMT10P, MEMT20P, MEMT21P, MEMT40P, MEVT06P, MEVT10P, MEVT20P, MEVT21P, MEVT40P, MG061P, MG101P, MG102P, MG201P, MG202P, MGMT06P, MGMT10P, MGMT20P, MGMT21P, MGMT40P, MGVT06P, MGVT10P, MGVT20P, MGVT21P, MGVT40P			





1	<b>Part No.</b>	400149	<b>Ref. No.</b>	R65300580
	<b>description</b>	keypad PCB		
<b>For models:</b>	VE004X, VE104X, VE105X, VG105X			

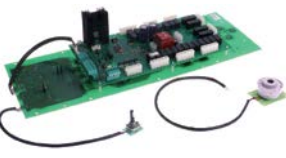





			
1			
<b>Part No.</b>	401591	<b>Ref. No.</b>	R65301410 R65301420 R65301460
<b>description</b>	keypad PCB combi-steamer ME061T complete		
<b>For models:</b>	ME061T, ME101T, ME102T, ME201T, ME202T, MG061T, MG101T, MG102T, MG201T, MG202T		
<b>spare parts for</b>	401591		
	<b>Part No.</b>	350086	<b>Ref. No.</b> R65301440 RA919008
buzzer 12VDC connection cable 200mm PCB buzzer 20dB			
	<b>Part No.</b>	401338	<b>Ref. No.</b> R65301450
encoder			

			
1			
<b>Part No.</b>	400140	<b>Ref. No.</b>	R65300500
<b>description</b>	keypad PCB combi-steamer ME106M with keypad		
<b>For models:</b>	ME106M, ME110M, ME120M, ME210M, MG106M, MG110M, MG120M, MG210M, MG220M, VE106M, VE110M, VE120M, VE210M, VE220M, VG106M, VG110M, VG120M, VG210M, VG220M		

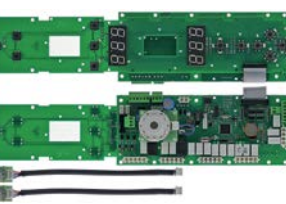
			
1			
<b>Part No.</b>	401661	<b>Ref. No.</b>	R65301800 R65301810 R65301820
<b>description</b>	keypad PCB combi-steamer MVE04 kit		
<b>For models:</b>	MVE042P, MVE051P, MVG051P		

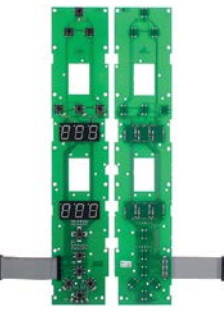
			
1			
<b>Part No.</b>	403829	<b>Ref. No.</b>	LAR65302100
<b>description</b>	keypad PCB for combi-steamer L 437mm W 103mm		

			
1			
<b>Part No.</b>	403823	<b>Ref. No.</b>	LA65302240 LAR65302240
<b>description</b>	keypad PCB for combi-steamer L 443mm W 83mm		

			
1			
<b>Part No.</b>	400142	<b>Ref. No.</b>	R65300570
<b>description</b>	keypad PCB L 100mm W 95mm buttons 8		
<b>For models:</b>	ME106X, ME110X, ME120X, ME210X, ME220M, ME220X, MG106X, MG110X, MG120X, MG210X, MG220X, VE106X, VE110X, VE120X, VE210X, VE220X, VG106X, VG110X, VG120X, VG210X, VG220X		

			
1			
<b>Part No.</b>	400150	<b>Ref. No.</b>	R65300830
<b>description</b>	main PCB		
<b>For models:</b>	CVE004H, CVE104H, CVE105H, CVG105H		

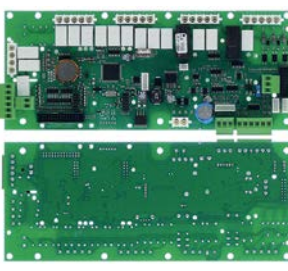
			
1			
<b>Part No.</b>	403824	<b>Ref. No.</b>	LA65302250 LAR65302250
<b>description</b>	main PCB for combi-steamer L 250mm W 103mm		

1

<b>Part No.</b>	401333	<b>Ref. No.</b>	R65300490
<b>description</b>	PCB		
<b>For models:</b>	EM010M+SC, EM106M+SC, EM110M+SC, EM210M+SC, EV106M+SC, EV110M+SC, EV210M+SC, GM106M+SC, GM110M+SC, GM210M+SC, GV106M+SC, GV110M+SC, GV210M+SC, ME061M, ME101M, ME102M, ME201M, ME202M, MG061M, MG101M, MG102M, MG201M, MG202M, MGC20X		



1

<b>Part No.</b>	401341	<b>Ref. No.</b>	R63130020
<b>description</b>	PCB		
<b>For models:</b>	GMT06D, GMT20D, GVT06D, GVT20D, MACG05M, MACG07M, MACG10M, MACG20M, MG061D, MG061M, MG061P, MG061T, MG101D, MG101M, MG101P, MG101T, MG102D, MG102M, MG102P, MG102T, MG201D, MG201M, MG201P, MG201T, MG202D, MG202M, MG202P, MG202T, MGMT06D, MGMT06P, MGMT10D, MGMT10P, MGMT20D, MGMT20P, MGMT21D, MGMT21P, MGMT40D, MGMT40P, MGVT06D, MGVT06P, MGVT10D, MGVT10P, MGVT20D, MGVT20P, MGVT21D, MGVT21P, MGVT40D, MGVT40P, MVG051P		



1

<b>Part No.</b>	402825	<b>Ref. No.</b>	R65301480
<b>description</b>	PCB combi-steamer GEMT L 130mm W 86mm new edition level control steam generator EVCO		
<b>For models:</b>	GMT06D, GMT20D, ME061D, ME061P, ME101D, ME101P, ME102D, ME102P, ME201D, ME201P, ME202D, ME202P, MEMENT06D, MEMENT06P, MEMENT10D, MEMENT10P, MEMENT20D, MEMENT20P, MEMENT21D, MEMENT21P, MEMENT40D, MEMENT40P, MG061D, MG061P, MG101D, MG101P, MG102D, MG102P, MG201D, MG201P, MG202D, MG202P, MGMT06D, MGMT06P, MGMT10D, MGMT10P, MGMT20D, MGMT20P, MGMT21D, MGMT21P, MGMT40D, MGMT40P		



1

<b>Part No.</b>	403668	<b>Ref. No.</b>	LA65302530 LAR65302530
<b>description</b>	PCB combi-steamer NABOO L 103mm W 85mm suitable for LAINOX		



1

<b>Part No.</b>	400152	<b>Ref. No.</b>	R65300850
<b>description</b>	PCB core temperature		
<b>For models:</b>	CVE004H, CVE104H, CVE105H, CVG105H		

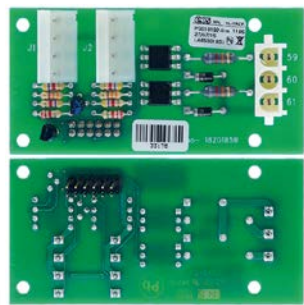

1

<b>Part No.</b>	403828	<b>Ref. No.</b>	LA65301950 LAR65301950
<b>description</b>	PCB for combi-steamer L 85mm W 42mm		



1

<b>Part No.</b>	402972	<b>Ref. No.</b>	011AD1600001 0509630R BN011AD1600001 CR0509630R
<b>description</b>	relay PCB L 69mm W 59mm		
<b>For models:</b>	V94E, V98E		





## solenoid valves

## solenoid valves (water)

ELBI

straight



<b>Part No.</b>	373021	<b>Ref. No.</b>	R65110040 R65115000
<b>description</b>	solenoid valve double straight 230VAC inlet 3/4" outlet 11.5mm output 1x 4.7l/min DN10 ELBI		
<b>For models:</b>	CVE105H, CVE105M, CVG105H, CVG105M, EM010M+SC, EM106H, EM106M, EM106M+SC, EM106P, EM110H, EM110M, EM110M+SC, EM110P, EM210H, EM210M, EM210M+SC, EM210P, GM106H, GM106M, GM106M+SC, GM106P, GM110H, GM110M, GM110M+SC, GM110P, GM210H, GM210M, GM210M+SC, GM210P, ME106M, ME106P, ME106X, ME110M, ME110P, ME110X, ME120M, ME120P, ME120X, ME210M, ME210P, ME210X, ME220M, ME220P, ME220X, MEC24H, MEC40M, MG106M, MG106P, MG106X, MG110M...(Other models you can see in the webshop)		
<b>spare parts for</b>	373021		
	<b>Part No.</b>	370467	<b>Ref. No.</b> —
	solenoid valve filter suitable for ELBI		
	<b>Part No.</b>	371263	<b>Ref. No.</b> —
	reducer ELBI flow rate 4.7l/min pressure range 0 up to 10bar tolerance ±15/25% grey		



<b>Part No.</b>	373017	<b>Ref. No.</b>	R65110010
<b>description</b>	solenoid valve single straight 230VAC inlet 3/4" outlet 11.5mm DN10 ELBI		
<b>For models:</b>	EM010M+SC, EM106M, EM106M+SC, EM110M, EM110M+SC, EM210M, EM210M+SC, EV006M, EV106H, EV106M, EV106M+SC, EV106P, EV110H, EV110M, EV110M+SC, EV110P, EV210H, EV210M, EV210M+SC, EV210P, FE105M, FE105X, FE110M, FE110X, FE210M, FG105M, FG105X, FG110M, FG110X, FG210M, FG210X, GM106M, GM106M+SC, GM110M, GM110M+SC, GM210M, GM210M+SC, GV106H, GV106M, GV106M+SC, GV106P, GV110H, GV110M, GV110M+SC, GV110P, GV210H, GV210M, GV210M+SC, GV210P, ME106M...(Other models you can see in the webshop)		
<b>spare parts for</b>	373017		
	<b>Part No.</b>	370467	<b>Ref. No.</b> —
	solenoid valve filter suitable for ELBI		



<b>Part No.</b>	370360	<b>Ref. No.</b>	R65115040
<b>description</b>	solenoid valve single straight 230VAC inlet 3/4" outlet 11.5mm output 0.25l/min t.max. 90°C ELBI plastic flow regulating valve outlet white flow regulating valve inlet clear		
<b>For models:</b>	EC110M, EC210M, EV110M, EV110M+SC, EV210M, EV210M+SC, GC110M, GC210M, GV110M, GV110M+SC, GV210M, GV210M+SC, VE106M, VE106P, VE106X, VE110M, VE110X, VE210M, VE210P, VE210X, VG106M, VG106P, VG106X, VG110M, VG110P, VG110X, VG210M, VG210P, VG210X		



<b>Part No.</b>	370359	<b>Ref. No.</b>	R65115050
<b>description</b>	solenoid valve double straight 230VAC inlet 3/4" outlet 11.5mm input 5.5l/min t.max. 90°C ELBI plastic flow regulating valve inlet yellow output A 5.5l/min output B 2l/min output A brown output B white		
<b>For models:</b>	CVE004H, CVE004M, CVE104H, CVE104M, VE004M, VE004X, VE104M, VE104X		



<b>Part No.</b>	370361	<b>Ref. No.</b>	R65115060
<b>description</b>	solenoid valve double straight 230VAC inlet 3/4" outlet 11.5mm plastic output A 0.25l/min		
<b>For models:</b>	VE120M, VE120P, VE120X, VE220M, VE220P, VE220X, VG120M, VG120P, VG120X, VG220M, VG220P, VG220X		

## spare parts and accessories

## reducers

## outlet side



<b>Part No.</b>	371060	<b>Ref. No.</b>	LA65110520 LAR65110520
<b>description</b>	reducer ELBI flow rate 0.25l/min pressure range 0 up to 10bar tolerance ±15/25% green		
<b>For models:</b>	MGVT10D, MGVT10P		





RPE			
JOHN GUEST			
 <p>1</p>			
<b>Part No.</b>	374032 <sup>1</sup>	<b>Ref. No.</b>	R65110230
<b>description</b>	solenoid valve double straight 230VAC inlet 3/4" outlet 10mm DN10 plastic output A w/t membrane (constantly open)		
<b>For models:</b>	GVT06D, GVT20D, ME061P, ME061T, ME101P, ME101T, ME102P, ME102T, ME201P, ME201T, ME202P, ME202T, MEMENT40P, MEVT06D, MEVT06P, MEVT10D, MEVT10P, MEVT20D, MEVT20P, MG061P, MG061T, MG101P, MG101T, MG102P, MG102T, MG201P, MG201T, MG202P, MG202T, MGMT06P, MGMT40P, MGVT06D, MGVT06P, MGVT10D, MGVT10P, MGVT20D, MGVT20P, MGVT40P, MVE042P, MVE051P, MVG051P		

<sup>1</sup>cylindrical outlet

 <p>1</p>			
<b>Part No.</b>	370768 <sup>1</sup>	<b>Ref. No.</b>	LA65110200 LAR65110200
<b>description</b>	solenoid valve single straight 230VAC inlet 3/4" outlet 10mm input/ min output/min DN10 t.max. 90°C duty cycle 100% RPE		
<b>For models:</b>	GMT06D, GMT20D, GVT06D, GVT20D, MACE04M, MACE05M, MACE07M, MACE10M, MACE20M, MACG05M, MACG07M, MACG10M, MACG20M, ME061D, ME061M, ME101D, ME101M, ME102D, ME102M, ME201D, ME201M, ME202D, ME202M, MEMENT06D, MEMENT06P, MEMENT10D, MEMENT10P, MEMENT20D, MEMENT20P, MEMENT21D, MEMENT21P, MEMENT40D, MEVT06D, MEVT06P, MEVT10D, MEVT10P, MEVT20D, MEVT20P, MEVT21D, MEVT21P, MEVT40D, MEVT40P, MG061D, MG061M, MG101D, MG101M, MG102D, MG102M, MG201D, MG201M...(Other models you can see in the webshop)		

<sup>1</sup>cylindrical outlet

reducers			
outlet side			
 <p>1</p>			
<b>Part No.</b>	371269	<b>Ref. No.</b>	LA65110500 LAR65110500 R65110420
<b>description</b>	reducer flow rate 0.07-0.14l/min brown		
<b>For models:</b>	CVE004H, CVE004M, CVE104H, CVE104M, EV106H, EV106P, EV110H, GMT06D, GV106H, GV106P, MACE04M, MACE05M, MACE07M, MACG05M, ME202D, ME202M, ME202P, MEMENT06D, MEMENT06P, MEMENT40D, MEMENT40P, MEVT06D, MEVT06P, MEVT40D, MEVT40P, MG202D, MG202M, MG202P, MG202T, MGMT06D, MGMT06P, MGMT40D, MGMT40P, MGVT40D, MGVT40P, MVE042P, MVE051P, MVG051P, VE004M, VE004X, VE104M, VE104X		

solenoid valves with reducers			
2-fold			
 <p>1</p>			
<b>Part No.</b>	374031	<b>Ref. No.</b>	R65110210
<b>description</b>	solenoid valve double straight 230VAC inlet 3/4 outlet JG 10 input 10-12l/min t.max. 90°C RPE plastic flow regulating valve inlet white + outlet reducer red		
<b>For models:</b>	GMT06D, GMT20D, ME061D, ME061M, ME061P, ME061T, ME101D, ME101M, ME101P, ME101T, ME102D, ME102M, ME102P, ME102T, ME201D, ME201M, ME201P, ME201T, ME202D, ME202M, ME202P, ME202T, MEMENT06D, MEMENT06P, MEMENT10D, MEMENT10P, MEMENT20D, MEMENT20P, MEMENT21D, MEMENT21P, MEMENT40D, MEMENT40P, MG061D, MG061M, MG061P, MG061T, MG101D, MG101M, MG101P, MG101T, MG102D, MG102M, MG102P, MG102T, MG201D, MG201M, MG201P, MG201T, MG202D, MG202M...(Other models you can see in the webshop)		

3-fold			
 <p>1</p>			
<b>Part No.</b>	374014 <sup>1</sup>	<b>Ref. No.</b>	LAR65110280
<b>description</b>	solenoid valve triple straight 230VAC inlet 3/4" outlet 10mm input 10-12l/min RPE plastic flow regulating valve inlet white flow regulating valve outlet A red/green flow regulating valve outlet B red/green flow regulating valve outlet C red/green		





<sup>1</sup>cylindrical outlet

 <p>1</p>			
<b>Part No.</b>	374033	<b>Ref. No.</b>	LAR65110240
<b>description</b>	solenoid valve triple straight 230VAC inlet 3/4" outlet 10mm input 10-12l/min t.max. 90°C RPE plastic flow regulating valve inlet white output B w/t membrane (constantly open)		
<b>For models:</b>	ME061T, ME101T, ME102T, ME201T, MEMENT40P, MEVT21D, MEVT21P, MEVT40D, MEVT40P, MG102T, MG201T, MG202T, MGMT40P, MGVT21D, MGVT21P, MGVT40D		





TP			
 			
<b>Part No.</b>	370017	<b>Ref. No.</b>	2709000 MA2709000
<b>description</b>	solenoid valve single straight 230VAC inlet 3/4" outlet 11.5mm DN10 TP p max 10bar		
<b>For models:</b>	B124E, CON102E, CON102EP, CON102G, CON102GP, CON10E, CON10EP, CON10G, CON10GP, CON6E, CON6EP, CON6G, CON6GP, CRE6220, CRE6230, CRE6320, CRE6330, CS102E, CS102EP, FC10E, FC10G, FC20E, FC20G, FC5E, FC5G, FC7E, FC7G, SBA, SBAC, SNA12, SNA16, SNA20, SNAC12, SNAC16, SNAC20, SNG08, SNG12, SNG16, SNG20, SVAC, SVAC12, SVAC16, SVAC20, SVCG, SVCG08, SVCG12, SVCG16, SVCG20, SVCG8		
<b>accessories for</b>	370017		
	Part No.	371220	Ref. No. —
reducer TP flow rate 3l/min red tolerance ±15%			
	Part No.	371221	Ref. No. —
reducer TP flow rate 5.5l/min yellow tolerance ±15%			
	Part No.	371222	Ref. No. —
reducer TP flow rate 6l/min grey tolerance ±15%			
	Part No.	371223	Ref. No. —
reducer TP flow rate 10l/min white tolerance ±15%			
	Part No.	371224	Ref. No. —
reducer TP flow rate 12l/min bronze tolerance ±15%			
	Part No.	371225	Ref. No. —
reducer TP flow rate 16l/min light brown tolerance ±15%			
	Part No.	371226	Ref. No. —
reducer TP flow rate 20l/min red tolerance ±15%			
	Part No.	371230	Ref. No. —
reducer TP flow rate 0.25l/min red tolerance ±25%			
	Part No.	371231	Ref. No. —
reducer TP flow rate 0.35l/min violet tolerance ±25%			
	Part No.	371232	Ref. No. —
reducer TP flow rate 0.5l/min orange tolerance ±25%			
	Part No.	371233	Ref. No. —
reducer TP flow rate 0.8l/min white tolerance ±25%			
	Part No.	371234	Ref. No. —
reducer TP flow rate 1l/min light blue tolerance ±25%			
	Part No.	371235	Ref. No. —
reducer TP flow rate 1.2l/min brown tolerance ±25%			
	Part No.	371236	Ref. No. —
reducer TP flow rate 1.5l/min light brown tolerance ±25%			

accessories for 370017			
	Part No.	371237	Ref. No. —
reducer TP flow rate 2.5l/min yellow tolerance ±25%			
	Part No.	371238	Ref. No. —
reducer TP flow rate 3.4l/min dark green tolerance ±25%			
	Part No.	371239	Ref. No. —
reducer TP flow rate 5l/min black tolerance ±25%			
	Part No.	371240	Ref. No. —
reducer TP flow rate 8l/min blue tolerance ±20%			





















			
<b>Part No.</b>	370029	<b>Ref. No.</b>	2956900
<b>description</b>	solenoid valve single straight 24VAC inlet 3/4" outlet 11.5mm DN10 TP flow regulating valve inlet white		
<b>For models:</b>	CON201E, CON201EP, CON201G, CON201GP, CON202E, CON202EP, CON202G, CON202GP, CS4E, CS4EP, CSM102E, CSM102EP, CSM102G, CSM102GP, CSM10E, CSM10EP, CSM10G, CSM10GP, CSM201E, CSM201EP, CSM201G, CSM201GP, CSM202E, CSM202EP, CSM202G, CSM202GP, CSM6E, CSM6EP, CSM6G, CSM6GP		
<b>spare parts for</b>	370029		
	Part No.	371035	Ref. No. —
solenoid coil 24VAC			
<b>accessories for</b>	370029		
	Part No.	371220	Ref. No. —
reducer TP flow rate 3l/min red tolerance ±15%			
	Part No.	371221	Ref. No. —
reducer TP flow rate 5.5l/min yellow tolerance ±15%			
	Part No.	371222	Ref. No. —
reducer TP flow rate 6l/min grey tolerance ±15%			
	Part No.	371223	Ref. No. —
reducer TP flow rate 10l/min white tolerance ±15%			
	Part No.	371224	Ref. No. —
reducer TP flow rate 12l/min bronze tolerance ±15%			
	Part No.	371225	Ref. No. —
reducer TP flow rate 16l/min light brown tolerance ±15%			
	Part No.	371226	Ref. No. —
reducer TP flow rate 20l/min red tolerance ±15%			
	Part No.	371230	Ref. No. —
reducer TP flow rate 0.25l/min red tolerance ±25%			
	Part No.	371231	Ref. No. —
reducer TP flow rate 0.35l/min violet tolerance ±25%			













Table continues overleaf





accessories for		370029	
Part No.	Ref. No.	Part No.	Ref. No.
	371232	—	—
reducer TP flow rate 0.5l/min orange tolerance ±25%			
	371233	—	—
reducer TP flow rate 0.8l/min white tolerance ±25%			
	371234	—	—
reducer TP flow rate 1l/min light blue tolerance ±25%			
	371235	—	—
reducer TP flow rate 1.2l/min brown tolerance ±25%			
	371236	—	—
reducer TP flow rate 1.5l/min light brown tolerance ±25%			
	371237	—	—
reducer TP flow rate 2.5l/min yellow tolerance ±25%			
	371238	—	—
reducer TP flow rate 3.4l/min dark green tolerance ±25%			
	371239	—	—
reducer TP flow rate 5l/min black tolerance ±25%			
	371240	—	—
reducer TP flow rate 8l/min blue tolerance ±20%			

 			
1			
Part No.	Ref. No.	Part No.	Ref. No.
370019	120142	—	—
description solenoid valve double angled 230VAC inlet 3/4" outlet 11.5mm DN10 TP plastic			
spare parts for		370019	
	371013	—	—
solenoid coil TP 230VAC 50/60Hz			
accessories for		370019	
	371220	—	—
reducer TP flow rate 3l/min red tolerance ±15%			
	371221	—	—
reducer TP flow rate 5.5l/min yellow tolerance ±15%			
	371222	—	—
reducer TP flow rate 6l/min grey tolerance ±15%			
	371223	—	—
reducer TP flow rate 10l/min white tolerance ±15%			
	371224	—	—
reducer TP flow rate 12l/min bronze tolerance ±15%			

accessories for		370019	
Part No.	Ref. No.	Part No.	Ref. No.
	371225	—	—
reducer TP flow rate 16l/min light brown tolerance ±15%			
	371226	—	—
reducer TP flow rate 20l/min red tolerance ±15%			
	371230	—	—
reducer TP flow rate 0.25l/min red tolerance ±25%			
	371231	—	—
reducer TP flow rate 0.35l/min violet tolerance ±25%			
	371232	—	—
reducer TP flow rate 0.5l/min orange tolerance ±25%			
	371233	—	—
reducer TP flow rate 0.8l/min white tolerance ±25%			
	371234	—	—
reducer TP flow rate 1l/min light blue tolerance ±25%			
	371235	—	—
reducer TP flow rate 1.2l/min brown tolerance ±25%			
	371236	—	—
reducer TP flow rate 1.5l/min light brown tolerance ±25%			
	371237	—	—
reducer TP flow rate 2.5l/min yellow tolerance ±25%			
	371238	—	—
reducer TP flow rate 3.4l/min dark green tolerance ±25%			
	371239	—	—
reducer TP flow rate 5l/min black tolerance ±25%			
	371240	—	—
reducer TP flow rate 8l/min blue tolerance ±20%			



 			
1			
Part No.	Ref. No.	Part No.	Ref. No.
370109	5151500 MA5151500	—	—
description solenoid valve double angled 24VAC inlet 3/4" outlet 11.5mm DN10 t.max. 90°C TP plastic flow regulating valve inlet white			
For models: CSM201E, CSM201EP, CSM201G, CSM201GP, CSM202E, CSM202EP, CSM202G, CSM202GP			
spare parts for		370109	
	371035	—	—
solenoid coil 24VAC			

Table continues overleaf





accessories for		370109	
	Part No.	371220	Ref. No. —
reducer TP flow rate 3l/min red tolerance ±15%			
	Part No.	371221	Ref. No. —
reducer TP flow rate 5.5l/min yellow tolerance ±15%			
	Part No.	371222	Ref. No. —
reducer TP flow rate 6l/min grey tolerance ±15%			
	Part No.	371223	Ref. No. —
reducer TP flow rate 10l/min white tolerance ±15%			
	Part No.	371224	Ref. No. —
reducer TP flow rate 12l/min bronze tolerance ±15%			
	Part No.	371225	Ref. No. —
reducer TP flow rate 16l/min light brown tolerance ±15%			
	Part No.	371226	Ref. No. —
reducer TP flow rate 20l/min red tolerance ±15%			
	Part No.	371230	Ref. No. —
reducer TP flow rate 0.25l/min red tolerance ±25%			
	Part No.	371231	Ref. No. —
reducer TP flow rate 0.35l/min violet tolerance ±25%			
	Part No.	371232	Ref. No. —
reducer TP flow rate 0.5l/min orange tolerance ±25%			
	Part No.	371233	Ref. No. —
reducer TP flow rate 0.8l/min white tolerance ±25%			
	Part No.	371234	Ref. No. —
reducer TP flow rate 1l/min light blue tolerance ±25%			
	Part No.	371235	Ref. No. —
reducer TP flow rate 1.2l/min brown tolerance ±25%			
	Part No.	371236	Ref. No. —
reducer TP flow rate 1.5l/min light brown tolerance ±25%			
	Part No.	371237	Ref. No. —
reducer TP flow rate 2.5l/min yellow tolerance ±25%			
	Part No.	371238	Ref. No. —
reducer TP flow rate 3.4l/min dark green tolerance ±25%			
	Part No.	371239	Ref. No. —
reducer TP flow rate 5l/min black tolerance ±25%			
	Part No.	371240	Ref. No. —
reducer TP flow rate 8l/min blue tolerance ±20%			





Part No.	370015	Ref. No.	1037308800
description	solenoid valve single angled 230VAC inlet 3/4" outlet 11.5mm DN10 TP		
For models:	DLS30, DLS303, DLS30P, DLS30P3, DLS31, DLS313, DLS31P3, MLC50, MLC503, MLC65, MLC653, MLS30, MLS303, MLS30P, MLS30P3, MLS31, MLS313, MLS31P3, MLS35, MLS353, MPLS30P		
accessories for	370015		
	Part No.	371220	Ref. No. —
reducer TP flow rate 3l/min red tolerance ±15%			
	Part No.	371221	Ref. No. —
reducer TP flow rate 5.5l/min yellow tolerance ±15%			
	Part No.	371222	Ref. No. —
reducer TP flow rate 6l/min grey tolerance ±15%			
	Part No.	371223	Ref. No. —
reducer TP flow rate 10l/min white tolerance ±15%			
	Part No.	371224	Ref. No. —
reducer TP flow rate 12l/min bronze tolerance ±15%			
	Part No.	371225	Ref. No. —
reducer TP flow rate 16l/min light brown tolerance ±15%			
	Part No.	371226	Ref. No. —
reducer TP flow rate 20l/min red tolerance ±15%			
	Part No.	371230	Ref. No. —
reducer TP flow rate 0.25l/min red tolerance ±25%			
	Part No.	371231	Ref. No. —
reducer TP flow rate 0.35l/min violet tolerance ±25%			
	Part No.	371232	Ref. No. —
reducer TP flow rate 0.5l/min orange tolerance ±25%			
	Part No.	371233	Ref. No. —
reducer TP flow rate 0.8l/min white tolerance ±25%			
	Part No.	371234	Ref. No. —
reducer TP flow rate 1l/min light blue tolerance ±25%			
	Part No.	371235	Ref. No. —
reducer TP flow rate 1.2l/min brown tolerance ±25%			
	Part No.	371236	Ref. No. —
reducer TP flow rate 1.5l/min light brown tolerance ±25%			
	Part No.	371237	Ref. No. —
reducer TP flow rate 2.5l/min yellow tolerance ±25%			

Table continues overleaf



accessories for		370015	
Part No.	371238	Ref. No.	—
	reducer TP flow rate 3.4l/min dark green tolerance ±25%		
Part No.	371239	Ref. No.	—
	reducer TP flow rate 5l/min black tolerance ±25%		
Part No.	371240	Ref. No.	—
	reducer TP flow rate 8l/min blue tolerance ±20%		

spare parts and accessories			
reducers			
outlet side			
	1		
Part No.	691081	Ref. No.	R65110410
<b>description</b>	reducer flow rate 0.25l/min green tolerance ±25%		
<b>For models:</b>	CVE105H, CVE105M, CVG105H, CVG105M, EV110P, EV210H, EV210P, GV110H, GV110P, GV210H, GV210P, VE105M, VE105X, VG105M, VG105X		

various			
	1		
Part No.	370363	Ref. No.	R65110260
<b>description</b>	solenoid valve single straight cable length 600mm suitable for LAINOX		
<b>For models:</b>	ME061T, ME101T, ME102T, ME201T, MEMT06P, MEMT10P, MEMT20P, MEMT21P, MEMT40P, MG102T, MG201T, MG202T, MGMT06P, MGMT10P, MGMT20P, MGMT21P, MGMT40P		

## ball valves electric

	1		
Part No.	401190	Ref. No.	R65110560
<b>description</b>	ball valve inlet 3/4" IT outlet 3/4" IT IP42 230V L 68mm 50/60Hz closed off-current mode of operation electric connection cable 300mm 3.5W duty cycle 50%		

## pressure switches

### for gas equipment

	1		
Part No.	541051	Ref. No.	5151000 MA5151000
<b>description</b>	pressure control ø 45mm pressure range adjustable 10-50mbar pressure connection vertical gas technology connection 1/4" pressure connection ø 1/4"mm		
<b>For models:</b>	CON102G, CON102GP, CON10G, CON10GP, CON201G, CON201GP, CON202G, CON202GP, CON6G, CON6GP, CP9A15GD, CSM102G, CSM102GP, CSM10G, CSM10GP, CSM201G, CSM201GP, CSM202G, CSM202GP, CSM6G, CSM6GP		

	1		
Part No.	541073	Ref. No.	LA63070010 LAR63070010
<b>description</b>	pressure control ø 45mm pressure range adjustable 5-20mbar pressure connection vertical gas technology connection 1/4" pressure connection ø 1/4"mm		
<b>For models:</b>	CVG105H, CVG105M, GC106M, GC110M, GC210M, GM106H, GM106M, GM106M+SC, GM106P, GM110H, GM110M, GM110M+SC, GM110P, GM210H, GM210M, GM210M+SC, GM210P, GMT06D, GMT20D, GV106H, GV106M, GV106M+SC, GV106P, GV110H, GV110M, GV110M+SC, GV110P, GV210H, GV210M, GV210M+SC, GV210P, GVT06D, GVT20D, MACG05M, MACG07M, MACG10M, MACG20M, MG061D, MG061M, MG061P, MG061T, MG101D, MG101M, MG101P, MG101T, MG102D, MG102M, MG102P, MG102T, MG106M...(Other models you can see in the webshop)		

### for steam control

	1		
Part No.	541074	Ref. No.	LAR63070050
<b>description</b>	pressure control ø 45mm triggering pressure 0.5bar reset pressure 0.35bar pressure connection vertical steam control pressure range 0.35/0.51bar connection 1/8" pressure connection 1/8"		
<b>For models:</b>	EV106H, EV106P, EV110H, EV110P, EV210H, EV210P, GV106H, GV106P, GV110H, GV110P, GV210H, GV210P, GVT06D, GVT20D, MEVT06D, MEVT06P, MEVT10D, MEVT10P, MEVT20D, MEVT20P, MEVT21D, MEVT21P, MEVT40D, MEVT40P, MGVT06D, MGVT06P, MGVT10D, MGVT10P, MGVT20D, MGVT20P, MGVT21D, MGVT21P, MGVT40D, MGVT40P, MVE042P, MVE051P, MVG051P, VE106P, VE120P, VE210P, VE220P, VG106P, VG110P, VG120P, VG210P, VG220P		

**electrodes**

1 electric components

			
1			
<b>Part No.</b>	401154	<b>Ref. No.</b>	2911600
<b>description</b>	level electrode 1/4" total length 126mm probe L 100mm insulated probe length 26mm connection male faston 6.3mm stainless steel ø 2.5mm		
<b>For models:</b>	CS6G, CSM6G, CSM6GP		

			
1			
<b>Part No.</b>	401162	<b>Ref. No.</b>	2916100
<b>description</b>	level electrode 1/4" total length 129mm probe L 103mm insulated probe length 26mm connection male faston 6.3mm stainless steel ø 2.5mm		
<b>For models:</b>	CS4E, CS4EP, CS6E, CS6EP, CSM6E, CSM6EP		

			
1			
<b>Part No.</b>	401155	<b>Ref. No.</b>	2911700
<b>description</b>	level electrode 1/4" total length 133mm probe L 106mm insulated probe length 26mm connection male faston 6.3mm stainless steel ø 2.5mm		
<b>For models:</b>	CS6G, CSM6G, CSM6GP		

			
1			
<b>Part No.</b>	401163	<b>Ref. No.</b>	2916200
<b>description</b>	level electrode 1/4" total length 136mm probe L 110mm insulated probe length 27mm connection male faston 6.3mm stainless steel ø 2.5mm		
<b>For models:</b>	CS4E, CS4EP, CS6E, CS6EP, CSM6E, CSM6EP		

			
1			
<b>Part No.</b>	401164	<b>Ref. No.</b>	2899600
<b>description</b>	level electrode 1/4" total length 147mm probe L 120mm insulated probe length 26mm connection male faston 6.3mm stainless steel ø 2.5mm		
<b>For models:</b>	CS10E, CS10EP, CSM10E, CSM10EP		

			
1			
<b>Part No.</b>	401158	<b>Ref. No.</b>	2908200
<b>description</b>	level electrode 1/4" total length 162mm probe L 134mm insulated probe length 26mm connection male faston 6.3mm stainless steel ø 2.5mm		
<b>For models:</b>	CS102E, CS102EP, CS10G, CSM102E, CSM102EP, CSM10G, CSM10GP, CSM201E, CSM201EP, CSM201G, CSM201GP, CSM202E, CSM202EP		

			
1			
<b>Part No.</b>	401165	<b>Ref. No.</b>	2899800
<b>description</b>	level electrode 1/4" total length 165mm probe L 138mm insulated probe length 26mm connection male faston 6.3mm stainless steel ø 2.5mm		
<b>For models:</b>	CS10E, CS10EP, CSM10E, CSM10EP		

			
1			
<b>Part No.</b>	401160	<b>Ref. No.</b>	2908100
<b>description</b>	level electrode 1/4" total length 186mm probe L 158mm insulated probe length 26mm connection male faston 6.3mm stainless steel ø 2.5mm		
<b>For models:</b>	CS102E, CS102EP, CS102G, CS102GP, CS10G, CSM102G, CSM102GP, CSM201E, CSM201EP, CSM201G, CSM201GP, CSM202E, CSM202EP, CSM202G, CSM202GP		

			
1			
<b>Part No.</b>	401159	<b>Ref. No.</b>	2987000
<b>description</b>	level electrode 1/4" total length 187mm probe L 160mm insulated probe length 26mm connection male faston 6.3mm stainless steel ø 2.5mm		
<b>For models:</b>	CS102G, CS102GP, CSM102E, CSM102EP, CSM102G, CSM102GP, CSM10G, CSM10GP, CSM201E, CSM201EP, CSM201G, CSM201GP, CSM202G, CSM202GP		

			
1			
<b>Part No.</b>	401161	<b>Ref. No.</b>	2927500 MA2927500
<b>description</b>	level electrode 1/4" total length 210mm probe L 184mm insulated probe length 26mm connection male faston 6.3mm stainless steel ø 2.5mm		
<b>For models:</b>	CS102G, CS102GP, CSM102G, CSM102GP, CSM201E, CSM201EP, CSM201G, CSM201GP, CSM202G, CSM202GP		

			
1			
<b>Part No.</b>	400130	<b>Ref. No.</b>	R65320010
<b>description</b>	level electrode M14x1.25 total length 220mm probe L 194mm insulated probe length 26mm connection male faston 6.3mm ø 2.5mm		
<b>For models:</b>	EM010M+SC, EM106H, EM106M, EM106M+SC, EM106P, EM110H, EM110M, EM110M+SC, EM110P, EM210H, EM210M, EM210M+SC, EM210P, GM106H, GM106M, GM106M+SC, GM106P, GM110H, GM110M, GM110M+SC, GM110P, GM210H, GM210M, GM210M+SC, GM210P, GMT06D, GMT20D, ME061D, ME061P, ME061T, ME101D, ME101M, ME101P, ME101T, ME102D, ME102M, ME102P, ME102T, ME106M, ME106P, ME106X, ME110M, ME110P, ME110X, ME120M, ME120P, ME120X, ME201D, ME201M, ME201P...(Other models you can see in the webshop)		





fans

axial fans

ebm-papst



1

<b>Part No.</b>	601030 <sup>1</sup>	<b>Ref. No.</b>	LAG65060050 LAR65060050
<b>description</b>	axial fan L 119mm W 119mm H 38mm 230VAC 50Hz 18W bearing ball bearing manuf. no. 4656Z metal connection male faston 2.8mm ebm-papst fan wheel ø 110mm temp.-resist. 75°C		
<b>For models:</b>	EC106M, EC110M, EC210M, EM010M+SC, EM106H, EM106M, EM106M+SC, EM106P, EM110H, EM110M, EM110M+SC, EM110P, EM210H, EM210M, EM210M+SC, EM210P, EV006M, EV106H, EV106M, EV106M+SC, EV106P, EV110H, EV110M, EV110M+SC, EV110P, EV210H, EV210M, EV210M+SC, EV210P, GC106M, GC110M, GC210M, GM106H, GM106M, GM106M+SC, GM106P, GM110H, GM110M, GM110M+SC, GM110P, GM210H, GM210M, GM210M+SC, GM210P, GMT06D, GMT20D, GV106H, GV106M, GV106M+SC, GV106P...(Other models you can see in the webshop)		
<b>accessories for</b>	601030		
	<b>Part No.</b>	550898	<b>Ref. No.</b> —
	connecting cable cable length 2000mm connection F 2.8 connection distance 7.9mm for axial flow fan		
	<b>Part No.</b>	692497	<b>Ref. No.</b> —
	guard ø 105mm mounting distance 150mm for axial fan ebm-papstmm		

<sup>1</sup>with ball bearings



1



<b>Part No.</b>	601038 <sup>1</sup>	<b>Ref. No.</b>	CM250700 MACM250700
<b>description</b>	axial fan L 80mm W 80mm H 38mm 230VAC 50/60Hz 12W bearing ball bearing manuf. no. 8556N metal connection cable 300mm ebmpapst fan wheel ø 75mm temp.-resist. 90°C airflow 50m³/h		
<b>For models:</b>	F94E18K, F94G22K, F98E18K, F98G22K, F9S4E18K, F9S4G22K, F9S8E18K, F9S8G22K		
<b>accessories for</b>	601038		
	<b>Part No.</b>	691102	<b>Ref. No.</b> —
	guard ø 75mm mounting distance 71mm for axial fan 80mm		

<sup>1</sup>with ball bearings

import



1

<b>Part No.</b>	601080 <sup>1</sup>	<b>Ref. No.</b>	CM303000 MACM303000
<b>description</b>	axial fan L 119mm W 119mm H 38mm 230VAC 50/60Hz 23/20W bearing ball bearing connection male faston 2.8mm metal ADDA fan wheel ø 110mm temp.-resist. 70°C		
<b>For models:</b>	CT78EC, CT7FE8EC, CT98EC, CT9FE8EC, NCT78E, NCT7FE8E, NCT98E, NCT98E2, NCT9FE8E, NCT9FE8E2, NF94G23K, NF98G23K		
<b>accessories for</b>	601080		
	<b>Part No.</b>	550898	<b>Ref. No.</b> —
	connecting cable cable length 2000mm connection F 2.8 connection distance 7.9mm for axial flow fan		
	<b>Part No.</b>	692519	<b>Ref. No.</b> —
	guard L 120mm W 120mm plastic		

<sup>1</sup>with ball bearings



1

<b>Part No.</b>	601081 <sup>1</sup>	<b>Ref. No.</b>	R65060010
<b>description</b>	axial fan L 80mm W 80mm H 38mm 230VAC 50/60Hz 14/13.5W bearing ball bearing connection male faston 2.8mm metal ADDA fan wheel ø 75mm temp.-resist. 70°C		
<b>For models:</b>	CVE105H, CVE105M, CVG105H, CVG105M, ME106M, ME106P, ME106X, ME110M, ME110P, ME110X, ME120M, ME120P, ME120X, ME210M, ME210P, ME210X, ME220M, ME220P, ME220X, MG106M, MG106P, MG106X, MG110M, MG110P, MG110X, MG120M, MG120P, MG120X, MG210M, MG210P, MG210X, MG220M, MG220P, MG220X, MVE042P, MVE051P, MVG051P, VE105M, VE105X, VE106M, VE106P, VE106X, VE110M, VE110X, VE120M, VE120P, VE120X, VE210M, VE210P, VE210X...(Other models you can see in the webshop)		
<b>accessories for</b>	601081		
	<b>Part No.</b>	691102	<b>Ref. No.</b> —
	guard ø 75mm mounting distance 71mm for axial fan 80mm		

<sup>1</sup>with ball bearings







1

<b>Part No.</b>	602151	<b>Ref. No.</b>	R65060060
<b>description</b>	axial fan L 172mm W 150mm H 51mm 220-240V 50-60Hz manuf. no. AA1752HB-AW connection cable cable length 3000mm ADDA suitable for combi-steamer fan wheel ø 140mm 0.27/0.23A		
<b>For models:</b>	ME101M, ME101P, ME101T, ME201D, ME201M, ME201P, ME201T, ME202D, ME202M, ME202P, ME202T, MEMT40D, MEMT40P, MEVT40D, MEVT40P, MG101M, MG101P, MG101T, MG201D, MG201M, MG201P, MG201T, MG202D, MG202M, MG202P, MG202T, MGMT40D, MGMT40P, MGVT40D, MGVT40P		

hot air motors



1

<b>Part No.</b>	550857	<b>Ref. No.</b>	LA58003870 LAR58003870
<b>description</b>	counterflange for fan motor ED ø 50mm int. ø 1 25mm int. ø 2 16mm thickness 6mm brass		
<b>For models:</b>	CVE105H, CVE105M, CVG105H, CVG105M, EC106M, EM106H, EM106M, EM106M+SC, EM106P, EV006M, EV106H, EV106M, EV106M+SC, EV106P, FE105M, FE105X, FG105M, FG105X, GC106M, GM106H, GM106M, GM106M+SC, GM106P, GMT06D, GV106H, GV106M, GV106M+SC, GV106P, GVT06D, MACE07M, MACG07M, ME061D, ME061M, ME061P, ME061T, ME106M, ME106P, ME106X, MEMT06D, MEMT06P, MEVT06D, MEVT06P, MG061D, MG061M, MG061P, MG061T, MG106M, MG106P, MG106X, MGMT06D...(Other models you can see in the webshop)		



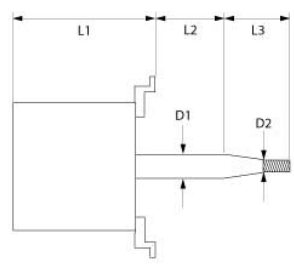

1

<b>Part No.</b>	550859	<b>Ref. No.</b>	LA58003850 LAR58003850
<b>description</b>	counterflange for fan motor ED ø 60mm int. ø 1 34mm int. ø 2 25mm thickness 6mm brass		
<b>For models:</b>	EC110M, EC210M, EM010M+SC, EM110H, EM110M, EM110M+SC, EM110P, EM210H, EM210M, EM210M+SC, EM210P, EV110H, EV110M, EV110M+SC, EV110P, EV210H, EV210M, EV210M+SC, EV210P, FE110M, FE110X, FE210M, FG110M, FG110X, FG210M, FG210X, GC110M, GC210M, GM110H, GM110M, GM110M+SC, GM110P, GM210H, GM210M, GM210M+SC, GM210P, GMT20D, GV110H, GV110M, GV-110M+SC, GV110P, GV210H, GV210M, GV210M+SC, GV210P, GVT20D, MACE10M, MACE20M, MACG10M, MACG20M...(Other models you can see in the webshop)		

1

<b>Part No.</b>	500656	<b>Ref. No.</b>	LAR65040520
<b>description</b>	fan motor 200-240/415V 3 phase 50/60Hz 0.15/0.55kW 900/1400rpm speeds 2 L1 150mm L2 50mm L3 48mm D1 ø 24mm D2 ø 20mm M12L IT 2.3/1.3-1.2/0.7A at 50Hz 200-240/415V at 60Hz 200-240/480V at 50Hz 900/1400rpm at 60Hz 1100/1700rpm type 3042D4050		
<b>For models:</b>	ME101P, ME101T, ME201P, ME201T		
<b>spare parts for</b>	500656		
	<b>Part No.</b>	511172	<b>Ref. No.</b> LA70020050 LAR70020050 R70020050
shaft sealing ID ø 24mm ED ø 29mm thickness 3mm			



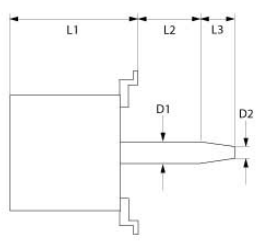

1

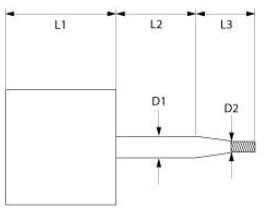
<b>Part No.</b>	500671	<b>Ref. No.</b>	R65040071
<b>description</b>	fan motor 200-240V 1 phase 50/60Hz 0.11kW 2760/3320rpm speeds 1 L1 130mm L2 55mm L3 30mm D1 ø 15mm D2 ø 12mm M10L ET at 50Hz 2760rpm at 60Hz 3320rpm		
<b>For models:</b>	CVE105H, CVE105M, CVG105H, CVG105M, VE105M, VE105X, VG105M, VG105X		



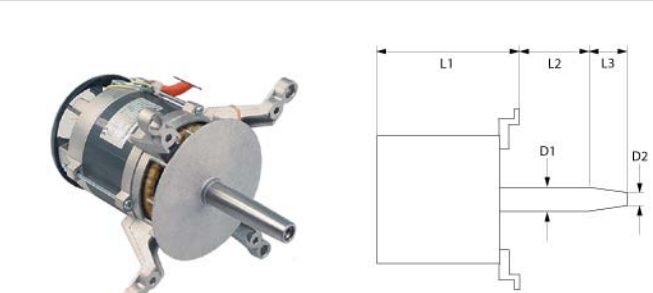

1

<b>Part No.</b>	500134	<b>Ref. No.</b>	R65040021
<b>description</b>	fan motor 200-240V 1 phase 50/60Hz 0.25HP 1400/1700rpm speeds 1 L1 115mm L2 77mm L3 30mm D1 ø 15mm D2 ø 12mm M10L ET 1A suitable capacitor 5µF/400V at 50Hz 1400rpm at 60Hz 1700rpm type 1060.1950		
<b>For models:</b>	ME106M, MG106M, VE106M, VG106M		
<b>accessories for</b>	500134		
	<b>Part No.</b>	380659	<b>Ref. No.</b> R65160570
overload switch setting range 0.7-1A connection screw type 3RU1116-0JB0 (AC3/400V) 0.25kW			

1

<b>Part No.</b>	500135	<b>Ref. No.</b>	R65040031
<b>description</b>	fan motor 200-240V 1 phase 50Hz 0.185/0.55kW 900/1400rpm speeds 2 L1 195mm L2 45mm L3 47mm D1 $\varnothing$ 24mm D2 $\varnothing$ 20mm M12L IT 3.6/2A suitable capacitor 16 $\mu$ F-450V/12.5 $\mu$ F-450V at 50Hz 900/1400rpm type 1063D2250		
<b>For models:</b>	FG110X, FG210X, GM110H, GM110P, GM210H, GM210P, GV110H, GV110P, GV210H, GV210P, MG102P, MG102T, MG110P, MG110X, MG120P, MG120X, MG210P, MG210X, MG220P, MG220X, MGC24H, MGC40H, MGMT10P, MGMT20P, MGMT21P, MGVT10P, MGVT20P, MGVT21P, PG080X, VG110P, VG110X, VG120P, VG120X, VG210P, VG210X, VG220P, VG220X		
<b>accessories for</b>	500135		
	<b>Part No.</b>	550682	<b>Ref. No.</b> —
	hexagonal screw thread M8 thread L 20mm SS WS 13 Qty 1 pcs DIN 933 / ISO 4017		



1

<b>Part No.</b>	501587	<b>Ref. No.</b>	R65040051
<b>description</b>	fan motor 220-240V 1 phase 50/60Hz 0.55kW 1400/1700rpm L1 190mm L2 45mm L3 47mm D1 $\varnothing$ 24mm D2 $\varnothing$ 20mm M12L IT 3.6A type 1063A2250		
<b>For models:</b>	EM110H, EM110P, EM210H, EM210P, EV110H, EV110P, EV210H, EV210P, ME102P, ME102T, ME110P, ME110X, ME120P, ME120X, ME202P, ME202T, ME210P, ME210X, ME220P, ME220X, MEC24H, MEMT10P, MEMT20P, MEMT21P, MEVT40P, MEVT10P, MEVT20P, MEVT21P, MEVT40P, VE110X, VE120P, VE120X, VE210P, VE210X, VE220P, VE220X		

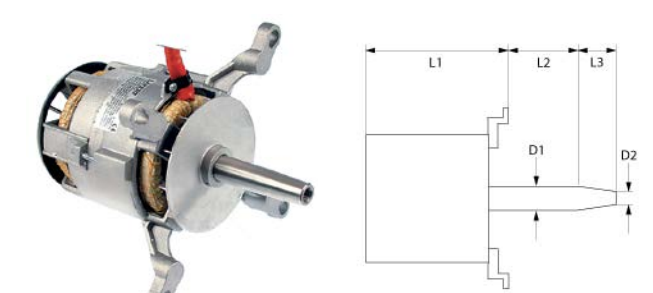

1

<b>Part No.</b>	601046	<b>Ref. No.</b>	R65040061
<b>description</b>	fan motor 220/380V 3 phase 50/60Hz 0.75kW 1350/1650rpm speeds 1 L1 185mm L2 42mm L3 47mm D1 $\varnothing$ 24mm D2 $\varnothing$ 20mm M12L IT 1.9/3.3A Cos(fi) 0.83 at 50Hz 200-240/346-415V at 60Hz 200-277/346-480V at 50Hz 1350rpm at 60Hz 1650rpm type ST80/4 no. 661512		
<b>For models:</b>	EC110M, EC210M, EM010M+SC, EM110M, EM110M+SC, EM210M, EM210M+SC, EV110M, EV110M+SC, EV210M, EV210M+SC, FE110M, FE210M, ME102D, ME102M, ME110M, ME120M, ME202D, ME202M, ME210M, ME220M, MEC40M, MEMT10D, MEMT20D, MEMT21D, MEMT40D, MEVT10D, MEVT20D, MEVT21D, MEVT40D, PE080M, VE110M, VE120M, VE210M, VE220M		
<b>accessories for</b>	500136		
	<b>Part No.</b>	511172	<b>Ref. No.</b> LA70020050 LAR70020050 R70020050
	shaft sealing ID $\varnothing$ 24mm ED $\varnothing$ 29mm thickness 3mm		

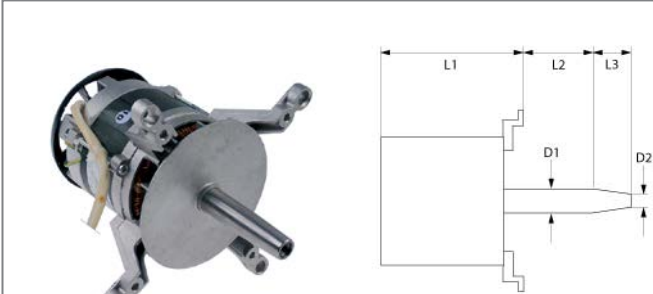

1

<b>Part No.</b>	500136	<b>Ref. No.</b>	R65040041
<b>description</b>	fan motor 220-240V 1 phase 50/60Hz 0.55kW 1400rpm speeds 1 L1 190mm L2 47mm L3 47mm D1 $\varnothing$ 24mm D2 $\varnothing$ 20mm M12L IT 3.6A suitable capacitor 16 $\mu$ F/450V Cos(fi) 0.9 at 50Hz 1400rpm at 60Hz 1700rpm type 1063/4M		
<b>For models:</b>	FG110M, FG210M, GC110M, GC210M, GM110M, GM110M+SC, GM210M, GM210M+SC, GMT20D, GV110M, GV110M+SC, GV210M, GV210M+SC, GVT20D, MG102D, MG102M, MG110M, MG120M, MG210M, MG220M, MGC20X, MGMT10D, MGMT20D, MGMT21D, MGVT10D, MGVT20D, MGVT21D, PG080M, VG110M, VG120M, VG210M, VG220M		
<b>accessories for</b>	500136		
	<b>Part No.</b>	511172	<b>Ref. No.</b> LA70020050 LAR70020050 R70020050
	shaft sealing ID $\varnothing$ 24mm ED $\varnothing$ 29mm thickness 3mm		

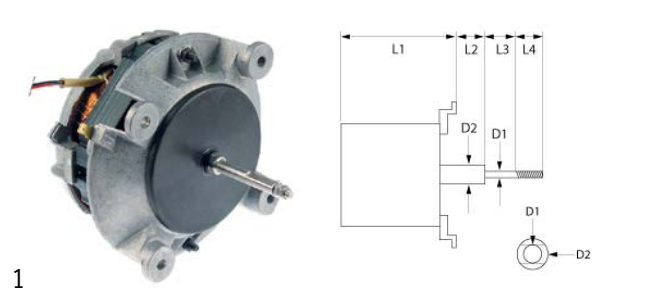

1

<b>Part No.</b>	500662	<b>Ref. No.</b>	R65041000
<b>description</b>	fan motor 220-240V 1 phase 50/60Hz 0.12kW 2800/3200rpm speeds 1 L1 85mm L2 7mm L3 47mm L4 12mm D1 $\varnothing$ 8/6mm D2 $\varnothing$ 12mm M5R ET 1.6A power input 0.25W suitable capacitor 5 $\mu$ F/400V		
<b>For models:</b>	MACE04M, MACE05M, MACG05M, MVE042P, MVE051P, MVG051P		

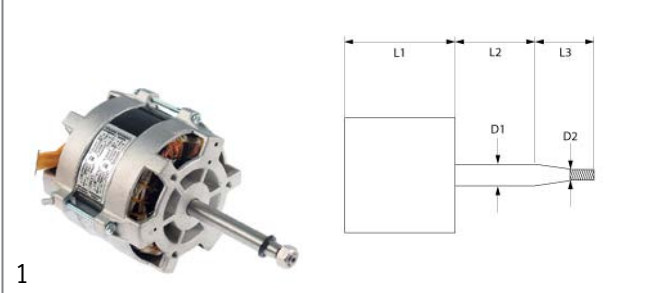

1

<b>Part No.</b>	500661	<b>Ref. No.</b>	R65040431
<b>description</b>	fan motor 220-240V 1 phase 50Hz 0.03/0.2kW 0.05/0.25HP 1400/2700rpm speeds 2 L1 123mm L2 77mm L3 30mm D1 $\varnothing$ 15mm D2 $\varnothing$ 12mm M10L ET 1.6/0.6A suitable capacitor 10 $\mu$ F/450 V at 50Hz 1400/2700rpm type 1057D1901		
<b>For models:</b>	ME061P, ME061T, MEMT06P, MEVT06P, MGO61P, MGMT06P, MGVT06P		

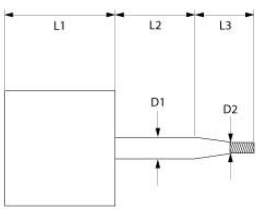



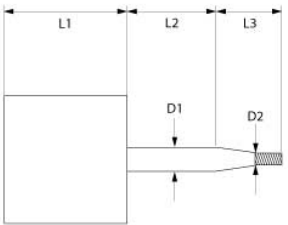

1

<b>Part No.</b>	500133	<b>Ref. No.</b>	R65040011
<b>description</b>	fan motor 220-240V 1 phase 50Hz 0.1/0.25HP 900/1400rpm speeds 2 L1 123mm L2 77mm L3 30mm D1 ø 15mm D2 ø 12mm M10L ET 1/0.6A suitable capacitor 5µF/450V at 50Hz 900/1400rpm at 60Hz 1100/1700rpm type 1061.1950		
<b>For models:</b>	ME106P, ME106X, MG106P, MG106X, VE106P, VE106X, VG106P, VG106X		





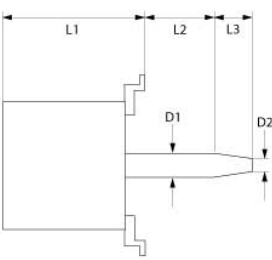

1

<b>Part No.</b>	601043	<b>Ref. No.</b>	R65040260
<b>description</b>	fan motor 220-240V 1 phase 50Hz 0.37/0.07kW 0.1/0.5HP 1400/2700rpm speeds 2 L1 123mm L2 107mm L3 15mm D1 ø 15mm D2 ø 12mm M10L ET 2/0.7A suitable capacitor 20µF/250V at 50Hz 1400/2700rpm type 1057		
<b>For models:</b>	FE105M, FE105X, FG105M, FG105X, PE040M, PE040X, PG040M, PG040X		
<b>accessories for</b>	601043		
	<b>Part No.</b>	365019	<b>Ref. No.</b> —
	operating capacitor capacity 20µF 400V tolerance 5% 50/60Hz ambient temperature max. -25 to +85°C ø 39.5mm L 70mm M8 plastic connection male faston 6.3mm 16.10.25. protection		

1

<b>Part No.</b>	500658	<b>Ref. No.</b>	LAR65040530
<b>description</b>	fan motor 230/400V 3 phase 50/60Hz 0.55kW 1400/1700rpm speeds 1 L1 145mm L2 47mm L3 47mm D1 ø 24mm D2 ø 20mm M12L IT 2.6-2.3/1.5-1.3A (at 50-60Hz)A Cos(fi) 0.73 at 50Hz 200-240/415V at 60Hz 200-240/480V at 50Hz 1400rpm at 60Hz 1700rpm		
<b>For models:</b>	MACE10M, MACE20M, ME101D, ME101M, ME201D, ME201M		
<b>spare parts for</b>	500658		
	<b>Part No.</b>	511172	<b>Ref. No.</b> LA70020050 LAR70020050 R70020050
	shaft sealing ID ø 24mm ED ø 29mm thickness 3mm		
	<b>Part No.</b>	551476	<b>Ref. No.</b> —

<b>accessories for</b>	500658		
	<b>Part No.</b>	560449	<b>Ref. No.</b> LA58004000 LAR58004000 R58004000
	hexagonal screw thread M12x1.5 L thread L 22mm bore ø 6.3mm WS 19 total length 30mm		
	<b>Part No.</b>	601244	<b>Ref. No.</b> LA75400440 LAR75400440 R75400440
	fan wheel D1 ø 350mm H1 114mm blades 12 D2 ø 19.5mm D3 ø 23mm H2 45mm		



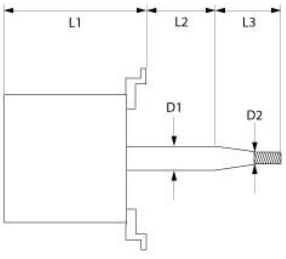

1

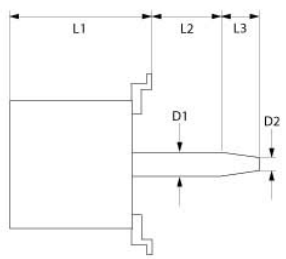
<b>Part No.</b>	500659	<b>Ref. No.</b>	LAR65040550
<b>description</b>	fan motor 230V 1 phase 50/60Hz 0.55kW 1400/1700rpm speeds 1 L1 150mm L2 52mm L3 45mm D1 ø 24mm D2 ø 20mm M12L IT 3A suitable capacitor 20µF/450V Cos(fi) 0.9 at 50Hz 1400rpm at 60Hz 1700rpm type 3042A2350		
<b>For models:</b>	GMT20D, GVT20D, MACG10M, MACG20M, MG101D, MG101M, MG201D, MG201M, MG202D, MG202M, MGMT40D, MGVT40D		
<b>spare parts for</b>	500659		
	<b>Part No.</b>	511172	<b>Ref. No.</b> LA70020050 LAR70020050 R70020050
	shaft sealing ID ø 24mm ED ø 29mm thickness 3mm		

1

<b>Part No.</b>	500657	<b>Ref. No.</b>	R65040540
<b>description</b>	fan motor 230V 1 phase 50Hz 0.15/0.55kW 900/1400rpm speeds 2 L1 150mm L2 45mm L3 47mm D1 ø 24mm D2 ø 20mm M12L IT 1.3/3.0A suitable capacitor 20/10µF Cos(fi) 0.98 at 50Hz 900/1400rpm at 60Hz 1100/1700rpm 4P/6P type LM/FB 100L no. 472986		
<b>For models:</b>	MG101P, MG101T, MG201P, MG201T, MG202P, MG202T, MGMT40P, MGVT40P		
<b>spare parts for</b>	500657		
	<b>Part No.</b>	511172	<b>Ref. No.</b> LA70020050 LAR70020050 R70020050
	shaft sealing ID ø 24mm ED ø 29mm thickness 3mm		

1

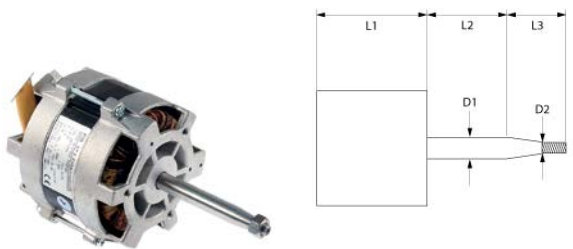
<b>Part No.</b>	500663	<b>Ref. No.</b>	R65040421
<b>description</b>	fan motor 230V 1 phase 50Hz 0.18kW 0.25HP 2800rpm speeds 1 L1 123mm L2 77mm L3 30mm D1 ø 15mm D2 ø 12mm M10L ET 1.6A suitable capacitor 10µF/400V Cos(fi) 0.95 at 50Hz 2800rpm type 1057C2401		
<b>For models:</b>	GMT06D, GVT06D, MACE07M, MACG07M, ME061D, ME061M, MEMT06D, MEVT06D, MG061D, MG061M, MGMT06D, MGVT06D		



1

<b>Part No.</b>	602148	<b>Ref. No.</b>	LA75400471 LAR75400471
<b>description</b>	fan wheel blades 12 D1 ø 350mm D2 ø 19.5mm D3 ø 23mm H1 118mm H2 50mm		

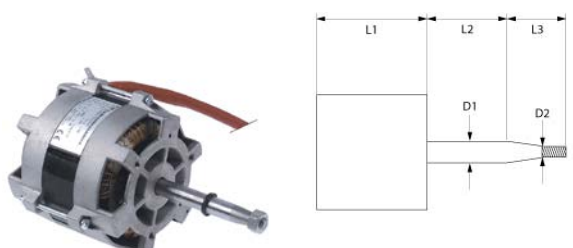

1

<b>Part No.</b>	500680	<b>Ref. No.</b>	LAR65040420
<b>description</b>	fan motor 230V 1 phase 50Hz 0.37kW 2800rpm speeds 1 L1 121mm L2 77mm L3 31mm D1 ø 16mm D2 ø 11mm 2.5A Cos(fi) 0.95 at 50Hz 230V at 50Hz 2800rpm type 1057.2155		
<b>For models:</b>	EC106M, EM106M, EM106M+SC, EV006M, EV106M, EV106M+SC, GC106M, GM106M, GM106M+SC, GV106M, GV106M+SC		
<b>accessories for</b>	500680		
	<b>Part No.</b>	601060	<b>Ref. No.</b> R75400130
	fan wheel D1 ø 180mm H1 60mm blades 16 D2 ø 11mm D3 ø 16mm H2 30mm		



1

<b>Part No.</b>	601067	<b>Ref. No.</b>	R75400040
<b>description</b>	fan wheel D1 ø 150mm H1 38mm blades 36 D2 ø 6mm D3 ø 6mm H2 14mm		
<b>For models:</b>	CVE004H, CVE004M, CVE104H, CVE104M, VE004M, VE004X, VE104M, VE104X		



1

<b>Part No.</b>	501566	<b>Ref. No.</b>	LAR65040600
<b>description</b>	fan motor 230V 3 phase 50Hz 0.25kW 2700rpm L1 122mm L2 77mm L3 30mm D1 ø 15mm D2 ø 8mm M10 1.5A type FIR no. 1057.2650		



1

<b>Part No.</b>	601353	<b>Ref. No.</b>	R75400510
<b>description</b>	fan wheel D1 ø 150mm H1 50mm blades 36 D2 ø 8mm D3 ø 6/8mm H2 26mm		
<b>For models:</b>	MACE04M, MVE042P		



1

<b>Part No.</b>	602150	<b>Ref. No.</b>	LA75400550
<b>description</b>	fan wheel blades 12 D1 ø 325mm D2 ø 19.5mm D3 ø 23mm H1 130mm H2 42mm H3 87mm		



1

<b>Part No.</b>	601068	<b>Ref. No.</b>	R75400080
<b>description</b>	fan wheel D1 ø 160mm H1 70mm blades 16 D2 ø 12mm D3 ø 16mm H2 29mm		
<b>For models:</b>	CVE105H, CVE105M, CVG105H, CVG105M, VE105M, VE105X, VG105M, VG105X		





1

<b>Part No.</b>	601060	<b>Ref. No.</b>	R75400130
<b>description</b>	fan wheel D1 ø 180mm H1 60mm blades 16 D2 ø 11mm D3 ø 16mm H2 30mm		
<b>For models:</b>	FE105M, FE105X, FG105M, FG105X, PE040M, PE040X, PG040M, PG040X		



1

<b>Part No.</b>	601064	<b>Ref. No.</b>	R75400230
<b>description</b>	fan wheel D1 ø 220mm H1 78mm blades 20 D2 ø 11.5mm D3 ø 16.5mm H2 30mm		
<b>For models:</b>	ME106M, ME106P, ME106X, MG106M, MG106P, MG106X, VE106M, VE106P, VE106X, VG106M, VG106P, VG106X		



1

<b>Part No.</b>	601246	<b>Ref. No.</b>	R75400410
<b>description</b>	fan wheel D1 ø 180mm H1 77mm blades 12 D2 ø 8mm D3 ø 6mm H2 25.5mm		
<b>For models:</b>	MACE05M, MACG05M, MVE051P, MVG051P		



1

<b>Part No.</b>	601065	<b>Ref. No.</b>	R75400290
<b>description</b>	fan wheel D1 ø 300mm H1 120mm blades 20 D2 ø 19.5mm D3 ø 23mm H2 46mm		
<b>For models:</b>	EC110M, EM010M+SC, EM110H, EM110M, EM110M+SC, EM110P, EV110H, EV110M, EV110M+SC, EV110P, GC110M, GM110H, GM110M, GM110M+SC, GM110P, GV110H, GV110M, GV110M+SC, GV110P, ME110M, ME110P, ME110X, ME120M, ME120P, ME120X, MG110M, MG110P, MG110X, MG120M, MG120P, MG120X, MGC20X, VE110M, VE110X, VE120M, VE120P, VE120X, VG110M, VG110P, VG110X, VG120M, VG120P, VG120X		



1

<b>Part No.</b>	601243	<b>Ref. No.</b>	R75400400
<b>description</b>	fan wheel D1 ø 220mm H1 78mm blades 12 D2 ø 11mm D3 ø 16mm H2 29mm		
<b>For models:</b>	EC106M, EM106H, EM106M, EM106M+SC, EM106P, EV006M, EV106H, EV106M, EV106M+SC, EV106P, GC106M, GM106H, GM106M, GM106M+SC, GM106P, GMT06D, GV106H, GV106M, GV106M+SC, GV106P, GVT06D, MACE07M, MACG07M, ME061D, ME061M, ME061P, ME061T, MEMT06D, MEMT06P, MEVT06D, MEVT06P, MG061D, MG061M, MG061P, MG061T, MGMT06D, MGMT06P, MGVT06D, MGVT06P		



1

<b>Part No.</b>	601244	<b>Ref. No.</b>	LA75400440 LAR75400440
<b>description</b>	fan wheel D1 ø 350mm H1 114mm blades 12 D2 ø 19.5mm D3 ø 23mm H2 45mm		
<b>For models:</b>	GMT20D, GVT20D, MACE10M, MACE20M, MACG10M, MACG20M, ME101D, ME101M, ME101P, ME101T, ME102D, ME102M, ME102P, ME102T, ME201D, ME201M, ME201P, ME201T, ME202D, ME202M, ME202P, ME202T, MEMT10D, MEMT10P, MEMT20D, MEMT20P, MEMT21D, MEMT21P, MEMT40D, MEMT40P, MEVT10D, MEVT10P, MEVT20D, MEVT20P, MEVT21D, MEVT21P, MEVT40D, MEVT40P, MG101D, MG101M, MG101P, MG101T, MG102D, MG102M, MG102P, MG102T, MG201D, MG201M, MG201P, MG201T...(Other models you can see in the webshop)		







			
1			
<b>Part No.</b>	601066	<b>Ref. No.</b>	R75400380
<b>description</b>	fan wheel D1 ø 350mm H1 120mm blades 24 D2 ø 19.5mm D3 ø 23.5mm H2 45mm		
<b>For models:</b>	EC210M, EM210H, EM210M, EM210M+SC, EM210P, EV210H, EV210M, EV210M+SC, EV210P, GC210M, GM210H, GM210M, GM210M+SC, GM210P, GV210H, GV210M, GV210M+SC, GV210P, ME210M, ME210P, ME210X, ME220M, ME220P, ME220X, MEC24H, MEC40M, MG210M, MG210P, MG210X, MG220M, MG220P, MG220X, MGC24H, MGC40H, VE210M, VE210P, VE210X, VE220M, VE220P, VE220X, VG210M, VG210P, VG210X, VG220M, VG220P, VG220X		

			
1			
<b>Part No.</b>	514039	<b>Ref. No.</b>	5103414
<b>description</b>	fan wheel D1 ø 350mm H1 190mm blades 16 D2 ø 12mm D3 ø 23.5mm H2 47mm		
<b>For models:</b>	CON202E, CON202EP, CON202G, CON202GP, CSM202E, CSM202EP, CSM202G, CSM202GP		

			
1			
<b>Part No.</b>	550855	<b>Ref. No.</b>	R58005510
<b>description</b>	flange for fan motor ED ø 35mm int. ø 1 22mm int. ø 2 8mm thickness 8mm brass		
<b>For models:</b>	CVE004H, CVE004M, CVE104H, CVE104M, VE004M, VE004X, VE104M, VE104X		

			
1			
<b>Part No.</b>	550856	<b>Ref. No.</b>	LA58003860 LAR58003860
<b>description</b>	flange for fan motor ED ø 50mm int. ø 1 19.5mm int. ø 2 16mm thickness 3mm brass		
<b>For models:</b>	CVE105H, CVE105M, CVG105H, CVG105M, EC106M, EM106H, EM106M, EM106M+SC, EM106P, EV006M, EV106H, EV106M, EV106M+SC, EV106P, FE105M, FE105X, FG105M, FG105X, GC106M, GM106H, GM106M, GM106M+SC, GM106P, GMT06D, GV106H, GV106M, GV106M+SC, GV106P, GVT06D, MACE07M, MACG07M, ME061D, ME061M, ME061P, ME061T, ME106M, ME106P, ME106X, MEMT06D, MEMT06P, MEVT06D, MEVT06P, MG061D, MG061M, MG061P, MG061T, MG106M, MG106P, MG106X, MGMT06D...(Other models you can see in the webshop)		

			
1			
<b>Part No.</b>	550858	<b>Ref. No.</b>	LA58003840 LAR58003840
<b>description</b>	flange for fan motor ED ø 60mm int. ø 1 28.5mm int. ø 2 25mm thickness 4mm brass		
<b>For models:</b>	EC110M, EC210M, EM010M+SC, EM110H, EM110M, EM110M+SC, EM110P, EM210H, EM210M, EM210M+SC, EM210P, EV110H, EV110M, EV110M+SC, EV110P, EV210H, EV210M, EV210M+SC, EV210P, FE110M, FE110X, FE210M, FG110M, FG110X, FG210M, FG210X, GC110M, GC210M, GM110H, GM110M, GM110M+SC, GM110P, GM210H, GM210M, GM210M+SC, GM210P, GMT20D, GV110H, GV110M, GV-110M+SC, GV110P, GV210H, GV210M, GV210M+SC, GV210P, GVT20D, MACE10M, MACE20M, MACG10M, MACG20M...(Other models you can see in the webshop)		

			
1			
<b>Part No.</b>	550860	<b>Ref. No.</b>	R58005500
<b>description</b>	flange for gasket ED ø 35mm int. ø 1 22mm int. ø 2 9mm thickness 8mm brass		
<b>For models:</b>	MACE04M, MACE05M, MACG05M, MVE042P, MVE051P, MVG051P		

			
1			
<b>Part No.</b>	560449	<b>Ref. No.</b>	LA58004000 LAR58004000
<b>description</b>	hexagonal screw thread M12x1.5 L thread L 22mm bore ø 6.3mm WS 19 total length 30mm		
<b>For models:</b>	EC110M, EC210M, EM010M+SC, EM110H, EM110M, EM110M+SC, EM110P, EM210H, EM210M, EM210M+SC, EM210P, EV110H, EV110M, EV110M+SC, EV110P, EV210H, EV210M, EV210M+SC, EV210P, FE110M, FE110X, FE210M, FG110M, FG110X, FG210M, FG210X, GC110M, GC210M, GM110H, GM110M, GM110M+SC, GM110P, GM210H, GM210M, GM210M+SC, GM210P, GMT20D, GV110H, GV110M, GV-110M+SC, GV110P, GV210H, GV210M, GV210M+SC, GV210P, GVT20D, MACE10M, MACE20M, MACG10M, MACG20M...(Other models you can see in the webshop)		

			
1			
<b>Part No.</b>	500639	<b>Ref. No.</b>	R65040101
<b>description</b>	motor kit 220/240V 1 phase 50/60Hz 0.25kW type K48210		
<b>For models:</b>	CVE004H, CVE004M, CVE104H, CVE104M, VE004M, VE004X, VE104M, VE104X		
<b>spare parts for</b>	500639		
		<b>Part No.</b>	511170
		<b>Ref. No.</b>	R70020010
		shaft seal ID ø 7mm ED ø 22mm thickness 7mm	
		<b>Part No.</b>	550855
		<b>Ref. No.</b>	R58005510
		flange for fan motor ED ø 35mm int. ø 1 22mm int. ø 2 8mm thickness 8mm brass	
		<b>Part No.</b>	601067
		<b>Ref. No.</b>	R75400040
		fan wheel D1 ø 150mm H1 38mm blades 36 D2 ø 6mm D3 ø 6mm H2 14mm	

Table continues overleaf



spare parts for	500639		
	Part No.	601856	Ref. No. —
	fan motor 220-240V 1 phase 50/60Hz 0.075kW 2800/3200rpm speeds 1 L1 85mm L2 30mm L3 23mm L4 12mm D1 ø 8x6mm D2 ø 8mm 0.6A suitable capacitor 5µF/400V		

1 			
Part No.	550861	Ref. No.	R70020020
description	shaft seal for fan motor ID ø 7.5mm ED ø 22mm thickness 7mm		
For models:	MACE04M, MACE05M, MACG05M, MVE042P, MVE051P, MVG051P		

1 			
Part No.	511171	Ref. No.	LA70020040 LAR70020040
description	shaft seal ID ø 14.5mm ED ø 20mm thickness 3mm		
For models:	CVE105H, CVE105M, CVG105H, CVG105M, EC106M, EM106H, EM106M, EM106M+SC, EM106P, EVO06M, EV106H, EV106M, EV106M+SC, EV106P, FE105M, FE105X, FG105M, FG105X, GC106M, GM106H, GM106M, GM106M+SC, GM106P, GMT06D, GV106H, GV106M, GV106M+SC, GV106P, GVT06D, MACE07M, MACG07M, ME061D, ME061M, ME061P, ME061T, ME106M, ME106P, ME106X, MEMT06D, MEMT06P, MEVT06D, MEVT06P, MGO61D, MGO61M, MGO61P, MGO61T, MG106M, MG106P, MG106X, MGMT06D...(Other models you can see in the webshop)		

1 			
Part No.	511170	Ref. No.	R70020010
description	shaft seal ID ø 7mm ED ø 22mm thickness 7mm		
For models:	CVE004H, CVE004M, CVE104H, CVE104M, VE004M, VE004X, VE104M, VE104X		

1 			
Part No.	511172	Ref. No.	LA70020050 LAR70020050
description	shaft sealing ID ø 24mm ED ø 29mm thickness 3mm		
For models:	EC110M, EC210M, EM010M+SC, EM110H, EM110M, EM110M+SC, EM110P, EM210H, EM210M, EM210M+SC, EM210P, EV110H, EV110M, EV110M+SC, EV110P, EV210H, EV210M, EV210M+SC, EV210P, FE110M, FE110X, FE210M, FG110M, FG110X, FG210M, FG210X, GC110M, GC210M, GM110H, GM110M, GM110M+SC, GM110P, GM210H, GM210M, GM210M+SC, GM210P, GMT20D, GV110H, GV110M, GV-110M+SC, GV110P, GV210H, GV210M, GV210M+SC, GV210P, GVT20D, MACE10M, MACE20M, MACG10M, MACG20M...(Other models you can see in the webshop)		



## hot air fans

## miscellaneous

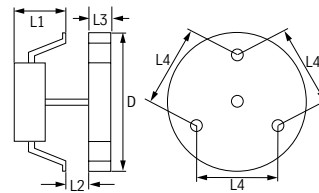

1



Part No.	601054	Ref. No.	1037117200 7800200 MA1037117200 MA7800200
description	hot air fan 220-240V 32W 50/60Hz L1 60mm L2 10mm L3 25mm L4 87mm fan wheel ø 150mm FIME type C20X0E01/46		
For models:	CFE60, CFE60P, CFGE61, CFGE61D, CFGE61L, CFGE61P, CFVE60, OCFE60, OCFGE61, TP12, TP126, TP126E, TP12E, TP13, TP136, TP136E, TP13E, TP14, TP146, TP146E, TP14E, TP15, TP156, TP156E, TP15E, TP16, TP166, TP166E, TP16E, TP17, TP176, TP176E, TP17E, TP18, TP186, TP186E, TP18E, TP19, TP196, TP196E, TP19E, TP20, TP206, TP206E, TP20E, TP21, TP212, TP2126, TP2126E, TP212E...(Other models you can see in the webshop)		
spare parts for	601054		
	Part No.	601441	Ref. No. —
	fan wheel ø 150mm W 25mm shaft intake ø 6x5mm stainless steel blades 7		
accessories for	601054		
	Part No.	550879	Ref. No. —
	insulation ø 130mm thickness 3mm hole ø 18mm for hot air fan		



1

<b>Part No.</b>	601339	<b>Ref. No.</b>	1037300300 37300030 MA1037300300
<b>description</b>	hot air fan 230V 45W L1 78mm L2 13mm L3 25mm L4 87mm fan wheel ø 150mm Medys type 30.200.CLH		

accessories

miscellaneous

1

<b>Part No.</b>	551434	<b>Ref. No.</b>	LA58004010 LAR58004010
<b>description</b>	plain washer ø 30mm thickness 3mm hole ø 12.5mm for fan wheel combi-steamer		
<b>For models:</b>	EC110M, EC210M, EM010M+SC, EM110H, EM110M, EM110M+SC, EM110P, EM210H, EM210M, EM210M+SC, EM210P, EV110H, EV110M, EV110M+SC, EV110P, EV210H, EV210M, EV210M+SC, EV210P, FE110M, FE110X, FE210M, FG110M, FG110X, FG210M, FG210X, GC110M, GC210M, GM110H, GM110M, GM110M+SC, GM110P, GM210H, GM210M, GM210M+SC, GM210P, GMT20D, GV110H, GV110M, GV-110M+SC, GV110P, GV210H, GV210M, GV210M+SC, GV210P, GVT20D, MACE10M, MACE20M, MACG10M, MACG20M...(Other models you can see in the webshop)		

radial fans

1

<b>Part No.</b>	601181	<b>Ref. No.</b>	LA65060360 LAR65060360
<b>description</b>	radial fan 230V voltage AC 50Hz 100W H1 170mm L1 175mm D1 ø 50mm W1 115mm W2 40mm H2 45mm		

1

Image not available

<b>Part No.</b>	601245	<b>Ref. No.</b>	R63130010
<b>description</b>	radial fan 24V voltage DC 50Hz 45W H1 170mm L1 170mm D1 ø 50mm W1 90mm W2 44mm H2 57mm W3 83mm H3 83mm		
<b>For models:</b>	GMT06D, GMT20D, GVT06D, GVT20D, MACG05M, MACG07M, MACG10M, MACG20M, MG061D, MG061M, MG061P, MG061T, MG101D, MG101M, MG101P, MG101T, MG102D, MG102M, MG102P, MG102T, MG201D, MG201M, MG201P, MG201T, MG202D, MG202M, MG202P, MG202T, MGMT06D, MGMT06P, MGMT10D, MGMT10P, MGMT20D, MGMT20P, MGMT21D, MGMT21P, MGMT40D, MGMT40P, MGVT06D, MGVT06P, MGVT10D, MGVT10P, MGVT20D, MGVT20P, MGVT21D, MGVT21P, MGVT40D, MGVT40P, MVG051P		
<b>accessories for</b>	601245		
<b>Part No.</b>	104309	<b>Ref. No.</b>	R63140020
<b>description</b>	gasket L 106mm W 100mm H 3mm 4 holes		

motors

gear motors

for combi-steamers

1

<b>Part No.</b>	502288	<b>Ref. No.</b>	LAR65090250
<b>description</b>	gear kit 8W 230V voltage AC 30rpm shaft ø 6mm L 75mm W 87mm H 84mm conversion kit		
<b>spare parts for</b>	502288		
<b>Part No.</b>	502291	<b>Ref. No.</b>	LA65090260
<b>description</b>	gear motor METEOR type 58U59DB4A1/00 8W 230V voltage AC 50Hz 30rpm shaft ø 6x5mm L 69mm W 49mm H 65mm		





1

<b>Part No.</b>	502291	<b>Ref. No.</b>	LA65090260
<b>description</b>	gear motor METEOR type 58U59DB4A1/00 8W 230V voltage AC 50Hz 30rpm shaft ø 6x5mm L 69mm W 49mm H 65mm		

vibration pumps



1

<b>Part No.</b>	500568	<b>Ref. No.</b>	LAR65110600
<b>description</b>	vibration pump 230V 32W 50Hz inlet ø 7 outlet ø 1/8" IT CEME type E512/A32		
<b>For models:</b>	ME061T, ME101T, ME102T, ME201T, MEMT06P, MEMT10P, MEMT20P, MEMT21P, MEMT40P, MG102T, MG201T, MG202T, MGMT06P, MGMT10P, MGMT20P, MGMT21P, MGMT40P		
<b>spare parts for</b>	500568		
		<b>Part No.</b>	390698 <b>Ref. No.</b> —
	thermal fuse switch-off temp. 110°C suitable for ULKA pump		
		<b>Part No.</b>	520153 <b>Ref. No.</b> —
	bracket rubber dimensions 53x34x28mm		

pumps

drain pumps

miscellaneous



1

<b>Part No.</b>	500201	<b>Ref. No.</b>	R65110300
<b>description</b>	drain pump inlet ø 24mm outlet ø 22mm 230V 34W		
<b>For models:</b>	GMT06D		

booster pumps II

accessories



1

<b>Part No.</b>	365015	<b>Ref. No.</b>	1037305100 631206 LA65190180 LAR65190180
<b>description</b>	operating capacitor capacity 10µF 400V tolerance 5%Hz ambient temperature max. -25 to +85°C ø 35.5mm L 59mm M8 plastic connection male faston 6.3mm protection		
<b>For models:</b>	EC106M, EM106H, EM106M, EM106M+SC, EM106P, EV006M, EV106H, EV106M, EV106M+SC, EV106P, GC106M, GM106H, GM106M, GM106M+SC, GM106P, GMT06D, GV106H, GV106M, GV106M+SC, GV106P, GVT06D, MACE04M, MACE05M, MACE07M, MACE10M, MACE20M, MACG05M, MACG07M, MACG10M, MACG20M, ME061D, ME061M, ME061P, ME061T, MEMT06D, MEMT06P, MEVT06D, MEVT06P, MG061D, MG061M, MG061P, MG061T, MG101D, MG101M, MG101P, MG101T, MG201D, MG201M, MG201P, MG201T...(Other models you can see in the webshop)		

condensators & interference suppression filters

operating capacitors

plastic



1

<b>Part No.</b>	365015	<b>Ref. No.</b>	1037305100 631206 LA65190180 LAR65190180
<b>description</b>	operating capacitor capacity 10µF 400V tolerance 5%Hz ambient temperature max. -25 to +85°C ø 35.5mm L 59mm M8 plastic connection male faston 6.3mm protection		
<b>For models:</b>	EC106M, EM106H, EM106M, EM106M+SC, EM106P, EV006M, EV106H, EV106M, EV106M+SC, EV106P, GC106M, GM106H, GM106M, GM106M+SC, GM106P, GMT06D, GV106H, GV106M, GV106M+SC, GV106P, GVT06D, MACE04M, MACE05M, MACE07M, MACE10M, MACE20M, MACG05M, MACG07M, MACG10M, MACG20M, ME061D, ME061M, ME061P, ME061T, MEMT06D, MEMT06P, MEVT06D, MEVT06P, MG061D, MG061M, MG061P, MG061T, MG101D, MG101M, MG101P, MG101T, MG201D, MG201M, MG201P, MG201T...(Other models you can see in the webshop)		

1

<b>Part No.</b>	365021	<b>Ref. No.</b>	631202 LAR65190030
<b>description</b>	operating capacitor capacity 16µF 425V tolerance 5% 50/60Hz ambient temperature max. -25 to +85°C ø 35mm L 73mm single M8 plastic connection male faston 6.3mm 416.10.99 protection		
<b>For models:</b>	GC110M, GC210M, GM110H, GM110M, GM110M+SC, GM110P, GM210H, GM210M, GM210M+SC, GM210P, GMT20D, GV110H, GV110M, GV110M+SC, GV110P, GV210H, GV210M, GV210M+SC, GV210P, GVT20D, MG102D, MG102M, MG102P, MG102T, MG110M, MG110P, MG110X, MG120M, MG120P, MG120X, MG210M, MG210P, MG210X, MG220M, MG220P, MG220X, MGC20X, MGC24H, MGC40H, MGMT20D, MGMT20P, MGV20D, MGV20P, VG110M, VG110P, VG110X, VG120M, VG120P, VG120X, VG210M...(Other models you can see in the webshop)		



2

<b>Part No.</b>	365033	<b>Ref. No.</b>	R65190080
<b>description</b>	operating capacitor capacity 5µF with plastic sheathing		
<b>For models:</b>	CVE004H, CVE004M, CVE104H, CVE104M, CVE105H, CVE105M, CVG105H, CVG105M, ME106M, ME106P, ME106X, MG106M, MG106P, MG106X, VE004M, VE004X, VE104M, VE104X, VE105M, VE105X, VE106M, VE106P, VE106X, VG105M, VG105X, VG106M, VG106P, VG106X		

ferrite rings



1

<b>Part No.</b>	691295	<b>Ref. No.</b>	R65280450
<b>description</b>	ferrite ring ID ø 17mm ED ø 28mm H 20mm for protection		
<b>For models:</b>	EM106H, EM106P, EM110H, EM110P, EM210H, EM210P, EV106H, EV106P, EV110H, EV110P, EV210H, EV210P, GM106H, GM106P, GM110H, GM110P, GM210H, GM210P, GMT06D, GMT20D, GV106H, GV106P, GV110H, GV110P, GV210H, GV210P, GVT06D, GVT20D, ME061D, ME061P, ME061T, ME101D, ME101P, ME101T, ME102P, ME102T, ME201D, ME201P, ME201T, ME202D, ME202P, ME202T, MEC24H, MEMT06D, MEMT06P, MEMT10D, MEMT10P, MEMT20D, MEMT20P, MEMT21D...(Other models you can see in the webshop)		



1

<b>Part No.</b>	365054	<b>Ref. No.</b>	LAR65280490
<b>description</b>	ferrite ring ID ø 22mm ED ø 38mm H 17mm for protection		

filters

interference suppression filters



1

<b>Part No.</b>	365046	<b>Ref. No.</b>	631209
<b>description</b>	interference suppression filter type 10S7E-G1474253105-Q 115/250V 50/60Hz conductor 2 with E connection male faston 6.3mm L 40mm ø 40mm Hmm Wmm M8 plastic Qty 1 pcs		



1

<b>Part No.</b>	365044	<b>Ref. No.</b>	1984000 LA65280200 LAR65280200 MA1984000
<b>description</b>	interference suppression filter type FC701Y2F 250V 50-60Hz conductor 2 with E connection cable 200mm L 42mm ø 23mm Hmm Wmm plastic Qty 1 pcs		
<b>For models:</b>	CP704E, CP92E, CP92E2, CP94E, CP94E2, CP9SB2E, CP9SB2E2, CP9SB4E, CP9SB4E2, DE92142, DE94242, EC106M, EC110M, EC210M, EM010M+SC, EM106H, EM106M, EM106M+SC, EM106P, EM110H, EM110M, EM110M+SC, EM110P, EM210H, EM210M, EM210M+SC, EM210P, EV006M, EV106H, EV106M, EV106M+SC, EV106P, EV110H, EV110M, EV110M+SC, EV110P, EV210H, EV210M, EV210M+SC, EV210P, FR74E, FR74E10, FR74E10L, FR74E10L2, FR74E2, FR77E, FR77E10, FR77E10L, FR77E10L2, FR77E2...(Other models you can see in the webshop)		

RC circuits



1

<b>Part No.</b>	365155	<b>Ref. No.</b>	R65280130
<b>description</b>	RC circuit 250/630V connection male faston 6.3mm cable length 65mm capacity 47nF 1000hm		
<b>For models:</b>	EC106M, EC110M, EC210M, EM010M+SC, EM106M, EM106M+SC, EM110M, EM110M+SC, EM210M, EM210M+SC, EV006M, EV106M, EV106M+SC, EV110M, EV110M+SC, EV210M, EV210M+SC, GC106M, GC110M, GC210M, GM106M, GM106M+SC, GM110M, GM110M+SC, GM210M, GM210M+SC, GV106M, GV106M+SC, GV110M, GV110M+SC, GV210M, GV210M+SC, MACE04M, MACE05M, MACE07M, MACE10M, MACE20M, MACG05M, MACG07M, MACG10M, MACG20M, ME061M, ME101M, ME102D, ME102M, ME201M, ME202M, MEC40M, MG061M, MG101M...(Other models you can see in the webshop)		





# fuses

## fine fuses

1 electric components



1

Part No.	358532	Ref. No.	R65200200
description	fine fuse size ø5x20mm 2A fast-acting rated 250V Qty 10 pcs		
For models:	CVE004H, CVE004M, CVE104H, CVE104M, CVE105H, CVE105M, CVG105H, CVG105M, EC106M, EC110M, EC210M, EM010M+SC, EM106H, EM106M, EM106M+SC, EM106P, EM110H, EM110M, EM110M+SC, EM110P, EM210H, EM210M, EM210M+SC, EM210P, EV006M, EV106H, EV106M, EV106M+SC, EV106P, EV110H, EV110M, EV110M+SC, EV110P, EV210H, EV210M, EV210M+SC, EV210P, FE105M, FE105X, FE110M, FE110X, FE210M, FG105M, FG105X, FG110M, FG110X, FG210M, FG210X, GC106M, GC110M...(Other models you can see in the webshop)		



1

Part No.	358593	Ref. No.	R65200086
description	fine fuse size ø5x20mm 0.125A slow-acting rated 250V Qty 10 pcs		
For models:	CVE004H, CVE104H, CVE105H, CVG105H, EM010M+SC, EM106H, EM106M+SC, EM106P, EM110M+SC, EM110P, EM210M+SC, EM210P, EV106H, EV106M+SC, EV106P, EV110M+SC, EV110P, EV210M+SC, EV210P, GM106H, GM106M+SC, GM106P, GM110M+SC, GM110P, GM210M+SC, GM210P, GV106H, GV106M+SC, GV106P, GV110M+SC, GV110P, GV210M+SC, GV210P, ME061P, ME061T, ME101P, ME101T, ME102P, ME102T, ME106M, ME106P, ME106X, ME110M, ME110P, ME110X, ME120M, ME120P, ME120X, ME201P, ME201T...(Other models you can see in the webshop)		



1

Part No.	358592	Ref. No.	R65200140
description	fine fuse size ø5x20mm 0.1A slow-acting rated 250V Qty 10 pcs		
For models:	GMT20D, MG061M, MG101D, MG101M, MG102D, MG102M, MG201D, MG201M, MGMT20D		



1

Part No.	358595	Ref. No.	R65200320
description	fine fuse size ø5x20mm 0.2A slow-acting rated 250V Qty 10 pcs		
For models:	EC106M, EM106H, EM106M, EM106M+SC, EM106P, EM110H, EM110P, EM210H, EM210P, EV006M, EV106H, EV106M, EV106M+SC, EV106P, EV110H, EV110P, EV210H, EV210P, FG105X, GC106M, GM106H, GM106M, GM106M+SC, GM106P, GM110H, GM210H, GV106H, GV106M, GV106M+SC, GV106P, GV110H, GV210H, MACE10M, MACE20M, ME061P, ME061T, ME101D, ME101M, ME102D, ME102M, ME106P, ME106X, ME110P, ME120P, ME201D, ME201M, ME210P, ME220P, MEC24H, MEMT10D...(Other models you can see in the webshop)		



1

Part No.	358703	Ref. No.	R65200350
description	fine fuse size ø5x20mm 0.4A slow-acting rated 250V Qty 10 pcs		
For models:	EC110M, EC210M, EM010M+SC, EM110H, EM110M, EM110M+SC, EM110P, EM210H, EM210M, EM210M+SC, EM210P, EV110H, EV110M, EV110M+SC, EV110P, EV210H, EV210M, EV210M+SC, EV210P, FE105X, FG110X, FG210X, GC110M, GC210M, GM110H, GM110M, GM110M+SC, GM110P, GM210H, GM210M, GM210M+SC, GM210P, GV110H, GV110M, GV110M+SC, GV110P, GV210H, GV210M, GV210M+SC, GV210P, ME110P, ME110X, ME120P, ME120X, ME210P, ME210X, ME220P, ME220X, MEC24H, MEC40M...(Other models you can see in the webshop)		

## fine fuse holders



1

Part No.	550104	Ref. No.	R65210020
description	fuse holder WIELAND type WK4/THSI 5 U/V0 suitable fuse ø5x30mm 0.5-6mm <sup>2</sup> top-hat rail 35mm 10A rated 600V		

## overload switches



1

Part No.	358514	Ref. No.	R65160300
description	overload switch drop-away current 0.8A		
For models:	EM106H, EM106P, EV106H, EV106P, GM106H, GM106P, GV106H, GV106P, ME061P, ME061T, MEMT06P, MEVT06P, MG061P, MG061T, MGMT06P, MGVT06P		



1

Part No.	358515	Ref. No.	LA65160310 LAR65160310
description	overload switch drop-away current 2.5A		
For models:	EC106M, EM106H, EM106M, EM106M+SC, EM106P, EV006M, EV106H, EV106M, EV106M+SC, EV106P, GC106M, GM106H, GM106M, GM106M+SC, GM106P, GV106H, GV106M, GV106M+SC, GV106P, MG061T		



1

Part No.	358520	Ref. No.	R65160220
description	overload switch drop-away current 2.5A connection male faston 6.3mm		
For models:	FE105M, FE105X, FG105M, FG105X, PE040M, PE040X, PG040M, PG040X		



1 

<b>Part No.</b>	358516	<b>Ref. No.</b>	R65160320
<b>description</b>	overload switch drop-away current 2A		
<b>For models:</b>	GMT06D, GVT06D, MACE07M, MACG07M, ME061D, ME061M, ME061P, ME061T, MEMT06D, MEMT06P, MEVT06D, MEVT06P, MG061D, MG061M, MG061P, MGMT06D, MGMT06P, MGVT06D, MGVT06P		

1 

<b>Part No.</b>	401960	<b>Ref. No.</b>	LA66110320 LAR66110320
<b>description</b>	kable set		
<b>For models:</b>	GMT20D, GVT20D, MACE07M, MACE10M, MACE20M, MACG07M, MACG10M, MACG20M, ME101D, ME101M, ME101P, ME101T, ME102D, ME102M, ME102P, ME102T, ME201D, ME201M, ME201P, ME201T, ME202D, ME202M, ME202P, ME202T, MEMT10D, MEMT10P, MEMT20D, MEMT20P, MEVT10D, MEVT10P, MEVT20D, MEVT20P, MG101D, MG101M, MG101P, MG101T, MG102D, MG102M, MG102P, MG102T, MG201D, MG201M, MG201P, MG201T, MG202D, MG202M, MG202P, MG202T, MGMT10D, MGMT10P...(Other models you can see in the webshop)		

## electric accessories

### cables

#### accessories

#### cable glands

#### threaded cable glands

#### screw connections

1 

<b>Part No.</b>	550971	<b>Ref. No.</b>	1037115100 MA1037115100
<b>description</b>	cable gland thread PG16 cable ø 14mm mounting ø 22.5mm Qty 1 pcs plastic WS 27		
<b>For models:</b>	AR712PA, AR712PP, AR712PS, AR713PA, AR713PP, AR713PS, AR-714PA, AR714PP, AR714PS, AR715PA, AR715PP, AR715PS, AR716PA, AR716PP, AR716PS, AR717PA, AR717PP, AR717PS, AR718PA, AR718PP, AR718PS, AR719PA, AR719PP, AR719PS, AR720PA, AR720PP, AR720PS, B124E, B9SB2E, B9SB4E, B9V2E, B9V4E, BIE40, BIE40B, BIE60, BIE60B, BME40DM, BME40DMB, BME40M, BME60, BME602, BME60DM, BME60DMB, BME60M, BME80M, BRE40, BRE40D, BRE40DB, BRE40DG, BRE40DGB...(Other models you can see in the webshop)		

### ribbon cables

#### group 1

1 

<b>Part No.</b>	403107	<b>Ref. No.</b>	R65301470
<b>description</b>	ribbon cable 16-pole L 85mm plug type 2 row coded		
<b>For models:</b>	ME061P, ME101P, ME102P, ME201P, ME202P, MEMT06P, MEMT10P, MEMT20P, MEMT21P, MEMT40P, MEVT06P, MEVT10P, MEVT20P, MEVT21P, MEVT40P, MG061P, MG101P, MG102P, MG201P, MG202P, MGMT06P, MGMT10P, MGMT20P, MGMT21P, MGMT40P, MGVT06P, MGVT10P, MGVT20P, MGVT21P, MGVT40P		

### miscellaneous

1 

<b>Part No.</b>	403839	<b>Ref. No.</b>	LA66110310
<b>description</b>	cable for combi-steamer L 370m copper insulation glass fibre braiding/silicone rubber		

### terminals and connectors

#### not insulated

#### female bullets

1 

<b>Part No.</b>	100023	<b>Ref. No.</b>	20418099 MA20418099
<b>description</b>	female bullet size 2.3mm 0.5-1.5mm <sup>2</sup> CuZn t.max. 125°C Qty 20 pcs		

### terminals

#### porcelain clamps

1 

<b>Part No.</b>	550115	<b>Ref. No.</b>	1037117600 MA1037117600
<b>description</b>	porcelain terminal block 2-pole 10mm <sup>2</sup> max. 30A max 450V L 37mm W 37mm H 23mm mounting distancemm Qty 1 pcs		
<b>For models:</b>	CT78EC, CT7FE8EC, CT98EC, CT9FE8EC, ERA10, ERA12, ERA14, ERA16, ERA18, ERA20, ERA210, ERA212, ERA214, ERA216, ERA218, ERA220, NSP74E, NSP94E, SP74E, SP94E		



## connection terminals with screw/faston connections



1

<b>Part No.</b>	550278	<b>Ref. No.</b>	1037117300 MA1037117300
<b>description</b>	power terminal block 3-pole max. 40A max 400V connection $\phi 6\text{mm}^2$ / F6.3 temp.-resist. 150°C cross section 6mm <sup>2</sup>		
<b>For models:</b>	AR712PA, AR712PP, AR712PS, AR713PA, AR713PP, AR713PS, AR714PA, AR714PP, AR714PS, AR715PA, AR715PP, AR715PS, AR716PA, AR716PP, AR716PS, AR717PA, AR717PP, AR717PS, AR718PA, AR718PP, AR718PS, AR719PA, AR719PP, AR719PS, AR720PA, AR720PP, AR720PS, B124E, BME40DM, BME40DMB, BME40M, BME60DM, BME60DMB, BME60M, BME80M, BSEI40M, EAR612PA, EAR612PP, EAR612PS, EAR613PA, EAR613PP, EAR613PS, EAR614PA, EAR614PP, EAR614PS, EAR615PA, EAR615PP, EAR615PS, EAR616PA, EAR616PP...(Other models you can see in the webshop)		



2

<b>Part No.</b>	550411	<b>Ref. No.</b>	1037104000 1616200 MA1037104000
<b>description</b>	power terminal block 6-pole max. 40A max 450V connection $\phi 6\text{mm}^2$ / F6.3 temp.-resist. 150°C cross section 6mm <sup>2</sup>		
<b>For models:</b>	BIE40B, BIE60B, BM74E, BM77E, BME40M, BME60, BME602, BME60M, BME80M, BRE40, BRE40D, BRE40DB, BRE40DG, BRE40DGB, BRE40G, BSE40M, CFE60, CFE60P, CFGE60, CFGE61, CFGE61D, CFGE61L, CFGE61P, CFVE60, CPE60, CPE602, CPE60DB, CRE6220, CRE6230, CRE6320, CRE6330, CSP6220, CSP6230, CWE42, CWE422, CWE62, CWE622, DLS30, DLS303, DLS30P, DLS30P3, DLS31, DLS313, DLS31P3, FQE40, FQE40D, FQE40DSP, FQE41, FQE41L, FQE41L2...(Other models you can see in the webshop)		



1

<b>Part No.</b>	550977 <sup>1</sup>	<b>Ref. No.</b>	CR0588170
<b>description</b>	power terminal block 6-pole max. 40A max 450V connection $\phi 6\text{mm}^2$ / F6.3 temp.-resist. 150°C cross section 6mm <sup>2</sup> with ground lug		
<b>For models:</b>	EC74EVG, EC78EVG, EC7FE8E, EFT74ELVG, EFT74ERVG, EFT78ELVG, EFT78EMVG, EPC74E, NBR78EF, NBR78EI, NC74E2, NC74EC, NC74EQC, NC78E2, NC78EC, NC78EQC, NC7FE8E, NC7FE8E2, NC7FE8EQ, NC94E, NC94E2, NC98E, NC98E2, NC9FE8E, NC9FE8E2, NCT78E, NCT7FE8E, NFT74EL, NFT74ELC, NFT74ELCO, NFT74ELO, NFT74ER, NFT74ERC, NFT76EL, NFT76ELC, NFT76EM, NFT76EMC, NFT76ER, NFT78EL, NFT78ELC, NFT78ELCO, NFT78ELO, NFT78EM, NFT78EMC, NFT78ER, NFT78ERC, NFT94EL, NFT94ELC, NFT94ELO, NFT94ER...(Other models you can see in the webshop)		

<sup>1</sup>with ground lug

## rail-mounted terminals

## rail-mounted terminal blocks



1

<b>Part No.</b>	550421 <sup>1</sup>	<b>Ref. No.</b>	R65220090
<b>description</b>	rail-mounted terminal block 5-pole contacts 3P+N+E cross section 1.0-10mm <sup>2</sup>		
<b>For models:</b>	CVE004H, CVE004M, CVE104H, CVE104M, CVE105H, CVE105M, CVG105H, CVG105M, EC106M, EM106H, EM106M, EM106M+SC, EM106P, EV006M, EV106H, EV106M, EV106M+SC, EV106P, FE105M, FE105X, FE110M, FE110X, FG110M, FG110X, FG210M, FG210X, MACE04M, MACE05M, MACE07M, MACG05M, ME061D, ME061M, ME061P, ME061T, ME106M, ME106P, ME106X, MEMT06D, MEMT06P, MEVT06D, MEVT06P, MG106M, MG106P, MG106X, MG110M, MG110P, MG110X, MG120M, MG120P, MG120X...(Other models you can see in the webshop)		

<sup>1</sup>with fused terminal block

1

<b>Part No.</b>	550420	<b>Ref. No.</b>	R65220080
<b>description</b>	rail-mounted terminal block 5-pole contacts 3P+N+E cross section 1.5-16mm <sup>2</sup>		
<b>For models:</b>	EC110M, EM010M+SC, EM110H, EM110M, EM110M+SC, EM110P, EV110H, EV110M, EV110M+SC, EV110P, FE210M, MACE10M, ME101D, ME101M, ME101P, ME101T, ME110M, ME110P, ME110X, MEMT10D, MEMT10P, MEVT10D, MEVT10P, VE110M, VE110X, VE210P		



1

<b>Part No.</b>	550422	<b>Ref. No.</b>	R65220130
<b>description</b>	rail-mounted terminal block 9-pole		
<b>For models:</b>	EC210M, EM210H, EM210M, EM210M+SC, EM210P, EV210H, EV210M, EV210M+SC, EV210P, ME102D, ME102M, ME102P, ME102T, ME120M, ME120P, ME120X, ME201D, ME201M, ME201P, ME201T, ME202D, ME202M, ME202P, ME202T, ME210M, ME210P, ME210X, ME220M, ME220P, ME220X, MEC24H, MEC40M, MEMT20D, MEMT20P, MEMT21D, MEMT21P, MEMT40D, MEMT40P, MEVT20D, MEVT20P, MEVT21D, MEVT21P, MEVT40D, MEVT40P, MG202P, MG202T, MGMT40P, MGVT40P, VE120M, VE120P...(Other models you can see in the webshop)		





WIELAND			
fuse terminal blocks			
			
1			
Part No.	550104	Ref. No.	R65210020
description	fuse holder WIELAND type WK4/THSI 5 U/V0 suitable fuse ø5x30mm 0.5-6mm <sup>2</sup> top-hat rail 35mm 10A rated 600V		



various			
			
1			
Part No.	693955	Ref. No.	1878400 MA1878400
description	terminal grounding cable		
For models:	AR712PA, AR712PP, AR712PS, AR713PA, AR713PP, AR713PS, AR-714PA, AR714PP, AR714PS, AR715PA, AR715PP, AR715PS, AR716PA, AR716PP, AR716PS, AR717PA, AR717PP, AR717PS, AR718PA, AR718PP, AR718PS, AR719PA, AR719PP, AR719PS, AR720PA, AR720PP, AR720PS, BIE40B, BIE60B, BME40DM, BME40DMB, BME40M, BME60, BME602, BME60DM, BME60DMB, BME60M, BME80M, BRE40, BRE40D, BRE40DB, BRE40DG, BRE40DGB, BRE40G, BSE40M, BSEI40M, CRE6220, CRE6230, CRE6320, CRE6330...(Other models you can see in the webshop)		

## gas valves and ignition boxes





### gas control valves





HONEYWELL				
				
1				
Part No.	106004	Ref. No.	R63020150	
description	gas valve type VK4105C 220-240V 50/60Hz gas inlet flange 32x32mm gas outlet flange 32x32mm thermocouple connection pilot connection pressure range 15-60mbar max 60mbar operator type pressure controller type V5306E 1234 1 suitable for HONEYWELL hole distance 24mm flange 32x32mm			
For models:	GC106M, GC110M, GC210M, GV106M, GV106M+SC, GV110M, GV-110M+SC, GV210M, GV210M+SC			
accessories for	106004			
	Part No.	102845	Ref. No.	—
	gas connection angled 1/2" flange 32x32mm hole distance 24x24mm Tandem			
	Part No.	102846	Ref. No.	—
	gas connection straight 1/2" flange 32x32mm hole distance 24x24mm suitable for Tandem			





				
1				
Part No.	102320	Ref. No.	R63020160	
description	gas valve type VK4105Q 220-240V 50/60Hz gas inlet flange 32x32mm gas outlet flange 32x32mm thermocouple connection pilot connection pressure range 15-60mbar max 60mbar operator type HONEYWELL coil type 220/240V (V4336A 2212 1) hole distance 24mm flange 32x32mm			
For models:	GM106H, GM106M, GM106M+SC, GM106P, GM110H, GM110M, GM110M+SC, GM110P, GM210H, GM210M, GM210M+SC, GM210P, GV106H, GV106P, GV110H, GV110P, GV210H, GV210P			
accessories for	102320			
	Part No.	102845	Ref. No.	—
	gas connection angled 1/2" flange 32x32mm hole distance 24x24mm Tandem			
	Part No.	102846	Ref. No.	—
	gas connection straight 1/2" flange 32x32mm hole distance 24x24mm suitable for Tandem			

				
1				
Part No.	106012	Ref. No.	LAR63020170	
description	gas valve type VK4115V 220-240V 50/60Hz gas inlet flange 32x32mm gas outlet flange 32x32mm thermocouple connection pilot connection pressure range 15-60mbar max 60mbar operator type HONEYWELL hole distance 24mm flange 32x32mm			
For models:	GMT06D, GMT20D, GVT06D, GVT20D, MACG05M, MACG07M, MACG10M, MACG20M, MG061D, MG061M, MG061P, MG061T, MG101D, MG101M, MG101P, MG101T, MG102D, MG102M, MG102P, MG102T, MG201D, MG201M, MG201P, MG201T, MG202D, MG202M, MG202P, MG202T, MGMT06D, MGMT06P, MGMT10D, MGMT10P, MGMT20D, MGMT20P, MGMT21D, MGMT21P, MGMT40D, MGMT40P, MGVT06D, MGVT06P, MGVT10D, MGVT10P, MGVT20D, MGVT20P, MGVT21D, MGVT21P, MGVT40D, MGVT40P, MVG051P			
accessories for	106012			
	Part No.	102845	Ref. No.	—
	gas connection angled 1/2" flange 32x32mm hole distance 24x24mm Tandem			
	Part No.	102846	Ref. No.	—
	gas connection straight 1/2" flange 32x32mm hole distance 24x24mm suitable for Tandem			



			
1			
<b>Part No.</b>	101395	<b>Ref. No.</b>	R63020010
<b>description</b>	gas valve type VR4605P 230V 50Hz gas inlet 1/2" gas outlet 1/2" thermocouple connection pilot connection pressure range 8-50mbar operator type 230V (V404A 1071) pressure controller type 220/240V (V404A 1071 4) HONEYWELL coil type 220/240V (V4336A 2220) flange 45x45mm		
<b>For models:</b>	CVG105H, CVG105M, MG106M, MG106P, MG106X, MG110M, MG110P, MG110X, MG120M, MG120P, MG120X, MG210M, MG210P, MG210X, MG220M, MG220P, MG220X, MGC20X, MGC24H, MGC40H, VG105M, VG105X, VG106M, VG106P, VG106X, VG110M, VG110P, VG110X, VG120M, VG120P, VG120X, VG210M, VG210P, VG210X, VG220M, VG220P, VG220X		
<b>accessories for</b>	101395		
	<b>Part No.</b>	101320	<b>Ref. No.</b> —
	cover suitable for gas valves HONEYWELL		
	<b>Part No.</b>	102845	<b>Ref. No.</b> —
	gas connection angled 1/2" flange 32x32mm hole distance 24x24mm Tandem		
	<b>Part No.</b>	102846	<b>Ref. No.</b> —
	gas connection straight 1/2" flange 32x32mm hole distance 24x24mm suitable for Tandem		

SIT			
ELETTROSIT			
			
1			
<b>Part No.</b>	101126	<b>Ref. No.</b>	R63025020
<b>description</b>	gas valve SIT type ELETTROSIT 230V gas inlet 1/2" gas outlet 1/2" thermocouple connection M9x1 pilot connection M10x1 bottom equiv. no. 0.810.136		
<b>For models:</b>	FG105M, FG105X, PG040M, PG040X		
<b>spare parts for</b>	101126		
	<b>Part No.</b>	101312	<b>Ref. No.</b> 1454900 CR0507660 MA1454900
	microswitch		
	<b>Part No.</b>	101352	<b>Ref. No.</b> —
	solenoid coil 230V 50Hz suitable for ELETTROSIT		
<b>accessories for</b>	101126		
	<b>Part No.</b>	100006	<b>Ref. No.</b> —
	piezoelectric igniter suitable for ELETTROSIT body plastic blowing connection ø2.4mm ø 14mm		

<b>accessories for</b>	101126		
	<b>Part No.</b>	100904	<b>Ref. No.</b> 1388000 1394700 MA1394700
	locking screw M10x1 for pipe ø 4mm Qty 1 pcs		
	<b>Part No.</b>	100905	<b>Ref. No.</b> 1394800 MA1394800
	locking screw M10x1 for pipe ø 6mm Qty 1 pcs		
	<b>Part No.</b>	101301	<b>Ref. No.</b> —
	gas connection thread 1/2" straight ELETTROSIT screw with O-ring		
	<b>Part No.</b>	101303	<b>Ref. No.</b> 1451300
	gas connection straight thread 3/4" ELETTROSIT		
	<b>Part No.</b>	101309	<b>Ref. No.</b> —
	extension		









			
1			
<b>Part No.</b>	101127	<b>Ref. No.</b>	1450100 LAR63025030
<b>description</b>	gas valve SIT type ELETTROSIT 230V gas inlet 3/4" gas outlet 3/4" thermocouple connection M9x1 pilot connection M10x1 lateral equiv. no. 0.810.175		
<b>For models:</b>	BR94G, BR94GI, BR96G, BR96GI, BR9M4G, BR9M4GI, BR9M6G, BR9M-6GI, FC10G, FC20G, FC5G, FC7G, FG110M, FG110X, FG210M, FG210X, FR92G22, FR94G23, P9110G, P91A10G, PG080M, PG080X		
<b>spare parts for</b>	101127		
	<b>Part No.</b>	101312	<b>Ref. No.</b> 1454900 CR0507660 MA1454900
	microswitch		
	<b>Part No.</b>	101352	<b>Ref. No.</b> —
	solenoid coil 230V 50Hz suitable for ELETTROSIT		
<b>accessories for</b>	101127		
	<b>Part No.</b>	100006	<b>Ref. No.</b> —
	piezoelectric igniter suitable for ELETTROSIT body plastic blowing connection ø2.4mm ø 14mm		
	<b>Part No.</b>	100904	<b>Ref. No.</b> 1388000 1394700 MA1394700
	locking screw M10x1 for pipe ø 4mm Qty 1 pcs		
	<b>Part No.</b>	100905	<b>Ref. No.</b> 1394800 MA1394800
	locking screw M10x1 for pipe ø 6mm Qty 1 pcs		
	<b>Part No.</b>	101301	<b>Ref. No.</b> —
	gas connection thread 1/2" straight ELETTROSIT screw with O-ring		
	<b>Part No.</b>	101303	<b>Ref. No.</b> 1451300
	gas connection straight thread 3/4" ELETTROSIT		

Table continues overleaf















accessories for		101127	
	Part No.	101309	Ref. No. —
	extension		

**NOVASIT**



Part No.		101162		Ref. No.		2863300 MA2863300	
description		gas valve SIT series Novasit 820 230V 50Hz gas inlet 1/2" gas outlet 1/2" thermocouple connection M9x1 pilot connection M10x1 ignition pressure 3-5mbar pressure range 3-30mbar pressure regulator connection blind equiv. no. 0.820.010					
For models:		BR912GFM, BR912GIM, BR94G, BR94GI, BR98GF, BR98GFM, BR98GI, BR98GIM, BR9M4G, BR9M4GI, BR9M6G, BR9M6GI, BR9S8GF, BR9S8GI, BR9SB4G, BR9SB4GI, CS10, CS102G, CS102GP, CS6, MS10AG, MS10IG, MS70AG, MS70IG, MS70IGS					
spare parts for		101162					
	Part No.	101065	Ref. No.	—			
	magnet unit with cable L 44mm D1 ø 30mm D2 ø 20mm suitable for NOVASIT						
	Part No.	101313	Ref. No.	—			
	solenoid coil 230V 50Hz						
accessories for		101162					
	Part No.	100006	Ref. No.	—			
	piezoelectric igniter suitable for ELETTROSIT body plastic blowing connection ø2.4mm ø 14mm						
	Part No.	101305	Ref. No.	2865700 MA2865700 R63080010			
	gas connection straight 1/2" flange 45x45mm ELETTROSIT/V4400/4600/4605 suitable for SIT/HONEYWELL hole distance 36x36mm						
	Part No.	101306	Ref. No.	2865800 MA2865800 R63080020			
	gas connection angled flange 45x45mm hole distance 36x36mm 1/2" ELETTROSIT/V4400/4600/4605 screw with O-ring suitable for SIT/HONEYWELL						
	Part No.	101307	Ref. No.	—			
	gas connection straight flange 45x45mm hole distance 36x36mm 3/4" ELETTROSIT/V4400/4600/4605 screw with O-ring suitable for SIT/HONEYWELL						
	Part No.	101308	Ref. No.	—			
	gas connection angled flange 45x45mm hole distance 36x36mm 3/4" ELETTROSIT/V4400/4600/4605 screw with O-ring suitable for SIT/HONEYWELL						
	Part No.	101312	Ref. No.	1454900 CR0507660 MA1454900			
	microswitch						
	Part No.	101314	Ref. No.	—			
	solenoid coil 24V 50Hz						

accessories for		101162		
	Part No.	101317	Ref. No.	1880600 MA1880600
	plug with cable L 1000mm suitable for NOVASIT			
	Part No.	101318	Ref. No.	—
	cover cap for solenoid coil suitable for NOVASIT			













Part No.		101908		Ref. No.		1871200 MA1871200	
description		gas valve SIT series Novasit 820 230V 50Hz gas inlet 1/2" gas outlet 1/2" thermocouple connection M9x1 pilot connection M10x1 ignition pressurebar pressure regulator connection blind equiv. no. 0.820.018 output pilot burner M10x1 input pressure max. 60bar setting range 3-30bar					
For models:		BR912GFM, BR912GIM, BR98GF, BR98GFM, BR98GI, BR98GIM, F94G22K, F98G22K, F9S4G22K, F9S8G22K, FR92G22T, FR94G22T, NBR912GFM, NBR912GIM, NBR98GF, NBR98GFM, NBR98GI, NBR98GIM, NF94G23K, NF98G23K, NPC74G, NPC76G, NPC78G, NPC94G, NPC96G, NPC98G, NPD76G5, NPD78G8, NPD96G5, NPD98G10, NPD98G15, NPD98G15A, NPI76G5, NPI78G8, NPI96G5, NPI98G10, NPI98G14, NPI98G14A					
spare parts for		101908					
	Part No.	101065	Ref. No.	—			
	magnet unit with cable L 44mm D1 ø 30mm D2 ø 20mm suitable for NOVASIT						
	Part No.	101313	Ref. No.	—			
	solenoid coil 230V 50Hz						
accessories for		101908					
	Part No.	100006	Ref. No.	—			
	piezoelectric igniter suitable for ELETTROSIT body plastic blowing connection ø2.4mm ø 14mm						
	Part No.	101305	Ref. No.	2865700 MA2865700 R63080010			
	gas connection straight 1/2" flange 45x45mm ELETTROSIT/V4400/4600/4605 suitable for SIT/HONEYWELL hole distance 36x36mm						
	Part No.	101306	Ref. No.	2865800 MA2865800 R63080020			
	gas connection angled flange 45x45mm hole distance 36x36mm 1/2" ELETTROSIT/V4400/4600/4605 screw with O-ring suitable for SIT/HONEYWELL						
	Part No.	101307	Ref. No.	—			
	gas connection straight flange 45x45mm hole distance 36x36mm 3/4" ELETTROSIT/V4400/4600/4605 screw with O-ring suitable for SIT/HONEYWELL						
	Part No.	101308	Ref. No.	—			
	gas connection angled flange 45x45mm hole distance 36x36mm 3/4" ELETTROSIT/V4400/4600/4605 screw with O-ring suitable for SIT/HONEYWELL						







Table continues overleaf







accessories for		101908	
	Part No.	101312	Ref. No. 1454900 CR0507660 MA1454900
microswitch			
	Part No.	101314	Ref. No. —
solenoid coil 24V 50Hz			
	Part No.	101317	Ref. No. 1880600 MA1880600
plug with cable L 1000mm suitable for NOVASIT			
	Part No.	101318	Ref. No. —
cover cap for solenoid coil suitable for NOVASIT			





1

Part No.	101967	Ref. No.	5118500 MA5118500
description	gas valve SIT series Novasit 822 230V 50Hz gas inlet 1/2" gas outlet 1/2" thermocouple connection pilot connection M10x1 ignition pressure 3-5mbar pressure range 3-30mbar pressure regulator connection perforated equiv. no. 0.822.110		
For models:	CON102G, CON102GP, CON201G, CON201GP, CON202G, CON202GP, CP9A15GD, CSM102G, CSM102GP, CSM201G, CSM201GP, CSM202G, CSM202GP		
spare parts for	101967		
	Part No.	101313	Ref. No. —
solenoid coil 230V 50Hz			
	Part No.	101542	Ref. No. —
solenoid coil 50Hz NOVA 822/826/827 suitable for NOVASIT 230V			
accessories for		101967	
	Part No.	100904	Ref. No. 1388000 1394700 MA1394700
locking screw M10x1 for pipe ø 4mm Qty 1 pcs			
	Part No.	100905	Ref. No. 1394800 MA1394800
locking screw M10x1 for pipe ø 6mm Qty 1 pcs			
	Part No.	101305	Ref. No. 2865700 MA2865700 R63080010
gas connection straight 1/2" flange 45x45mm ELETTROSIT/V4400/4600/4605 suitable for SIT/HONEYWELL hole distance 36x36mm			
	Part No.	101306	Ref. No. 2865800 MA2865800 R63080020
gas connection angled flange 45x45mm hole distance 36x36mm 1/2" ELETTROSIT/V4400/4600/4605 screw with O-ring suitable for SIT/HONEYWELL			
	Part No.	101307	Ref. No. —
gas connection straight flange 45x45mm hole distance 36x36mm 3/4" ELETTROSIT/V4400/4600/4605 screw with O-ring suitable for SIT/HONEYWELL			

accessories for		101967	
	Part No.	101308	Ref. No. —
gas connection angled flange 45x45mm hole distance 36x36mm 3/4" ELETTROSIT/V4400/4600/4605 screw with O-ring suitable for SIT/HONEYWELL			
	Part No.	101503	Ref. No. —
O-ring EPDM thickness 2mm ID ø 32mm Qty 1 pcs			
	Part No.	101924	Ref. No. —
plug with cable L 1090mm suitable for NOVA 822/826/827			

accessories			
	1		
Part No.	101306	Ref. No.	2865800 MA2865800 R63080020
description	gas connection angled flange 45x45mm hole distance 36x36mm 1/2" ELETTROSIT/V4400/4600/4605 screw with O-ring suitable for SIT/HONEYWELL		
For models:	BR912GFM, BR912GIM, BR94G, BR94GI, BR98GF, BR98GFM, BR98GI, BR98GIM, BR9M4G, BR9M4GI, BR9M6G, BR9M6GI, BR9S8GF, BR9S8GI, BR9S8GIM, BR9SB4G, BR9SB4GI, CON10G, CON10GP, CON201G, CON201GP, CON202G, CON202GP, CON6G, CON6GP, CS10, CS102G, CS102GP, CS6, CSM10G, CSM10GP, CSM201G, CSM201GP, CSM202G, CSM202GP, CSM6G, CSM6GP, CVG105H, CVG105M, MG106M, MG106P, MG106X, MG110M, MG110P, MG110X, MG120M, MG120P, MG120X, MG210M, MG210P, MG210X...(Other models you can see in the webshop)		
spare parts for	101306		
	Part No.	517104	Ref. No. —
O-ring EPDM thickness 2.62mm ID ø 31.42mm Qty 1 pcs			

	1		
Part No.	101305	Ref. No.	2865700 MA2865700 R63080010
description	gas connection straight 1/2" flange 45x45mm ELETTROSIT/V4400/4600/4605 suitable for SIT/HONEYWELL hole distance 36x36mm		
For models:	BR94G, BR94GI, BR9M4G, BR9M4GI, BR9M6G, BR9M6GI, BR9SB4G, BR9SB4GI, CON10G, CON10GP, CON201G, CON201GP, CON202G, CON202GP, CON6G, CON6GP, CS10, CS102G, CS102GP, CS6, CSM10G, CSM10GP, CSM201G, CSM201GP, CSM202G, CSM202GP, CSM6G, CSM6GP, MG106M, MG106P, MG106X, MG110M, MG110P, MG110X, MG210M, MG210P, MG210X, MS10AG, MS10IG, MS70AG, MS70IG, MS70IGS, VG106M, VG106P, VG106X, VG110M, VG110P, VG110X, VG210M, VG210P...(Other models you can see in the webshop)		
spare parts for	101305		
	Part No.	101503	Ref. No. —
O-ring EPDM thickness 2mm ID ø 32mm Qty 1 pcs			



1 

<b>Part No.</b>	100905	<b>Ref. No.</b>	1394800 MA1394800
<b>description</b>	locking screw M10x1 for pipe ø 6mm Qty 1 pcs		
<b>For models:</b>	BR707G, CS10, CS102G, CS102GP, CS6, CSM201E, CSM201EP, CSM201G, CSM201GP, CSM202E, CSM202EP, CSM202G, CSM202GP, FR74G, FR77G		

1 

<b>Part No.</b>	101312	<b>Ref. No.</b>	1454900 CR0507660 MA1454900
<b>description</b>	microswitch		
<b>For models:</b>	BR912GFM, BR912GIM, BR98GF, BR98GFM, BR98GI, BR98GIM, CS10, CS102G, CS102GP, CS6, FR92G22, FR94G23, NBR912GFM, NBR912GIM, NBR98GF, NBR98GFM, NBR98GI, NBR98GIM, NF94G23K, NF98G23K, NPC74G, NPC78G, NPC94G, NPC98G, NPD76G5, NPD78G8, NPD96G5, NPD98G10, NPD98G15, NPD98G15A, NPI76G5, NPI78G8, NPI96G5, NPI98G10, NPI98G14, NPI98G14A		

1 

<b>Part No.</b>	101317	<b>Ref. No.</b>	1880600 MA1880600
<b>description</b>	plug with cable L 1000mm suitable for NOVASIT		
<b>For models:</b>	BR912GFM, BR912GIM, BR94G, BR94GI, BR98GF, BR98GFM, BR98GI, BR98GIM, BR9M4G, BR9M4GI, BR9M6G, BR9M6GI, BR9S8GF, BR9S8GI, BR9SB4G, BR9SB4GI, CON201G, CON201GP, CON202G, CON202GP, CSM201G, CSM201GP, CSM202G, CSM202GP, F94G22K, F98G22K, F9S-4G22K, F9S8G22K, FR92G22T, FR94G22T, MS10AG, MS10IG, MS70AG, MS70IG, MS70IGS, NBR912GFM, NBR912GIM, NBR98GF, NBR98GFM, NBR98GI, NBR98GIM, NF94G23K, NF98G23K, NPC74G, NPC78G, NPC94G, NPC98G, NPD76G5, NPD78G8, NPD96G5...(Other models you can see in the webshop)		

TANDEM

1 

<b>Part No.</b>	101189	<b>Ref. No.</b>	2942600 MA2942600
<b>description</b>	gas valve 230V 50Hz gas inlet 1/2" gas outlet 1/2" pilot connection M10x1 level slow ignition ignition times pressure range 3-50mbar power supply for modulator equiv. no. 0.830.040 suitable for Tandem		
<b>For models:</b>	CON10G, CON10GP, CON6G, CON6GP, CSM10G, CSM10GP, CSM6G, CSM6GP, PI98G10, PI98G14, PI98G14A		
<b>spare parts for</b>	101189		
	<b>Part No.</b>	101379	<b>Ref. No.</b> —
	solenoid coil 230V 50Hz suitable for Tandem		
<b>accessories for</b>	101189		
	<b>Part No.</b>	100904	<b>Ref. No.</b> 1388000 1394700 MA1394700
	locking screw M10x1 for pipe ø 4mm Qty 1 pcs		
	<b>Part No.</b>	100905	<b>Ref. No.</b> 1394800 MA1394800
	locking screw M10x1 for pipe ø 6mm Qty 1 pcs		
	<b>Part No.</b>	101274	<b>Ref. No.</b> —
	olive for pipe ø 16mm Qty 1 pcs		
	<b>Part No.</b>	101275	<b>Ref. No.</b> —
	union screw thread 1/2" for pipe ø 16mm Qty 1 pcs		
	<b>Part No.</b>	101925	<b>Ref. No.</b> —
	plug with O-ring thread M10x1 for pilot burner suitable for NOVASIT		
	<b>Part No.</b>	102845	<b>Ref. No.</b> —
	gas connection angled 1/2" flange 32x32mm hole distance 24x24mm Tandem		
	<b>Part No.</b>	102846	<b>Ref. No.</b> —
	gas connection straight 1/2" flange 32x32mm hole distance 24x24mm suitable for Tandem		
	<b>Part No.</b>	102847	<b>Ref. No.</b> —
	O-ring		



ignition boxes

HONEYWELL

Honeywell



1			
<b>Part No.</b>	102367	<b>Ref. No.</b>	LAR63060120
<b>description</b>	ignition box HONEYWELL type S4565A 2092 1 electrodes 3 waiting times safety time 10s 220-240V 4VA 50/60Hz		
<b>For models:</b>	GMT06D, GMT20D, GVT06D, GVT20D, MACG05M, MACG07M, MACG10M, MACG20M, MG061D, MG061M, MG061P, MG061T, MG101D, MG101M, MG101P, MG101T, MG102D, MG102M, MG102P, MG102T, MG201D, MG201M, MG201P, MG201T, MG202D, MG202M, MG202P, MG202T, MGMT06D, MGMT06P, MGMT10D, MGMT10P, MGMT20D, MGMT20P, MGMT21D, MGMT21P, MGMT40D, MGMT40P, MGVT06D, MGVT06P, MGVT10D, MGVT10P, MGVT20D, MGVT20P, MGVT21D, MGVT21P, MGVT40D, MGVT40P, MVG051P		

Honeywell



1			
<b>Part No.</b>	102318	<b>Ref. No.</b>	R63060100
<b>description</b>	ignition box HONEYWELL type S4565AF 1007V01 electrodes 2 waiting times safety time 10s 220-240V 4VA 50/60Hz		
<b>For models:</b>	GC106M, GC110M, GC210M, GM106H, GM106M, GM106M+SC, GM106P, GM110H, GM110M, GM110M+SC, GM110P, GM210H, GM210M, GM210M+SC, GM210P, GV106H, GV106M, GV106M+SC, GV106P, GV110H, GV110M, GV110M+SC, GV110P, GV210H, GV210M, GV210M+SC, GV210P		

Honeywell



1			
<b>Part No.</b>	103109	<b>Ref. No.</b>	LAR63060160 LAR63060160
<b>description</b>	ignition box HONEYWELL type S4565C 1116 electrodes 2 waiting times safety time 5s 220-240V 4VA 50/60Hz		

SIT



1			
<b>Part No.</b>	103278	<b>Ref. No.</b>	5153200
<b>description</b>	ignition box kit SIT type 571DBC electrodes 2 waiting time 1.5s safety time 5s 250V 10VA 50/60Hz		
<b>spare parts for</b>	103278		
	<b>Part No.</b>	<b>Ref. No.</b>	—
	ignition box SIT type 571DBC electrodes 2 waiting time 1s safety time 10s 230V 12VA 50/60Hz		

ignition parts

pilot burners

SIT

100 series























1			
<b>Part No.</b>	106902	<b>Ref. No.</b>	94400
<b>description</b>	pilot burner SIT type 100 series 2 flames nozzle ø 0.2mm gas connection 6mm		
<b>spare parts for</b>	106902		
	<b>Part No.</b>	<b>Ref. No.</b>	1415100 2402299 3020054 MA1415100
	pilot burner nozzle LPG code 20 bore ø 0.2mm Qty 1 pcs thread M8x0.75		
	<b>Part No.</b>	<b>Ref. No.</b>	—
	pilot burner cap 2 flames Qty 1 pcs		
	<b>Part No.</b>	<b>Ref. No.</b>	1324900 MA1324900
	air mixing sleeve for pilot burner Qty 1 pcs		
	<b>Part No.</b>	<b>Ref. No.</b>	—
	compression spring for pilot burner Qty 1 pcs		
	<b>Part No.</b>	<b>Ref. No.</b>	—
	gasket for pilot burner Qty 1 pcs aluminium ID ø 8.5mm ED ø 11mm thickness 1.2mm		
	<b>Part No.</b>	<b>Ref. No.</b>	—
	screw for pilot burner		
	<b>Part No.</b>	<b>Ref. No.</b>	—
	pilot burner cap SIT 2 flames Hmm Lmm Qty 1 pcs		
	<b>Part No.</b>	<b>Ref. No.</b>	—
	pilot burner bottom part SIT 100 series nozzle ø 0.2mm		















Table continues overleaf



















accessories for		106902	
	Part No.	100246	Ref. No. 1422600 MA1422600
	pilot burner nozzle natural gas bore $\varnothing$ 0.35mm Qty 1 pcs thread M8x0.75		
	Part No.	100904	Ref. No. 1388000 1394700 MA1394700
	locking screw M10x1 for pipe $\varnothing$ 4mm Qty 1 pcs		
	Part No.	100905	Ref. No. 1394800 MA1394800
	locking screw M10x1 for pipe $\varnothing$ 6mm Qty 1 pcs		
	Part No.	102110	Ref. No. 1413100 1413200 1682300 1876500
	pilot tube copper pipe $\varnothing$ 4mm thickness 1mm L 3000mm		
	Part No.	102111	Ref. No. 1690200
	pilot tube copper pipe $\varnothing$ 6mm thickness 1mm L 3000mm		
	Part No.	107171	Ref. No. 1031502100 1842300 MA1031502100 MA1842300
	pilot burner nozzle SIT natural/liquid gas bore $\varnothing$ 0.25mm Qty 1 pcs		
	Part No.	107700	Ref. No. —
	pilot burner bottom part SIT 100 series nozzle $\varnothing$ 0.25mm		
	Part No.	107702	Ref. No. 1031501800 1314800 MA1314800
	pilot burner bottom part SIT 100 series nozzle $\varnothing$ 0.35mm		



 <p>1</p>			
<b>Part No.</b>	106906	<b>Ref. No.</b>	1040511 1314500 1842700 431500 6A013200 BN6A013200 LAR63050020 MA1040511 MA431500
<b>description</b>	pilot burner SIT type 100 series 3 flames nozzle $\varnothing$ 0.2mm gas connection 6mm		
<b>For models:</b>	B9SB2G, B9SB4G, B9V2G, B9V4G, F9SB2G, F9SB2GR, F9SB4G, F9SB-4GR, F9SB4GRL, F9V2G, F9V2GR, F9V4G, F9V4GR, F9V4GRL, FG105M, FG105X, FG110M, FG110X, FG210M, FG210X, P910G, P91A10G, PG040M, PG040X, PG080M, PG080X, T7011GFG, T707G, T707GFG, T9F4G, T9F6GS, T9SB4G, T9V4G, T9V6GS		
<b>spare parts for</b>	106906		
	Part No.	100245	Ref. No. 1415100 24022299 3020054 MA1415100
	pilot burner nozzle LPG code 20 bore $\varnothing$ 0.2mm Qty 1 pcs thread M8x0.75		
	Part No.	100855	Ref. No. —
	pilot burner bracket triple		
	Part No.	100885	Ref. No. 1324900 MA1324900
	air mixing sleeve for pilot burner Qty 1 pcs		

spare parts for		106906	
	Part No.	100916	Ref. No. —
	compression spring for pilot burner Qty 1 pcs		
	Part No.	100917	Ref. No. —
	gasket for pilot burner Qty 1 pcs aluminium ID $\varnothing$ 8.5mm ED $\varnothing$ 11mm thickness 1.2mm		
	Part No.	100918	Ref. No. —
	screw for pilot burner		
	Part No.	107162	Ref. No. —
	pilot burner cap SIT 3 flames Hmm Lmm Qty 1 pcs		
	Part No.	107701	Ref. No. —
	pilot burner bottom part SIT 100 series nozzle $\varnothing$ 0.2mm		
<b>accessories for 106906</b>			
	Part No.	100245	Ref. No. 1415100 24022299 3020054 MA1415100
	pilot burner nozzle LPG code 20 bore $\varnothing$ 0.2mm Qty 1 pcs thread M8x0.75		
	Part No.	100246	Ref. No. 1422600 MA1422600
	pilot burner nozzle natural gas bore $\varnothing$ 0.35mm Qty 1 pcs thread M8x0.75		
	Part No.	100904	Ref. No. 1388000 1394700 MA1394700
	locking screw M10x1 for pipe $\varnothing$ 4mm Qty 1 pcs		
	Part No.	100905	Ref. No. 1394800 MA1394800
	locking screw M10x1 for pipe $\varnothing$ 6mm Qty 1 pcs		
	Part No.	102110	Ref. No. 1413100 1413200 1682300 1876500
	pilot tube copper pipe $\varnothing$ 4mm thickness 1mm L 3000mm		
	Part No.	102111	Ref. No. 1690200
	pilot tube copper pipe $\varnothing$ 6mm thickness 1mm L 3000mm		
	Part No.	107171	Ref. No. 1031502100 1842300 MA1031502100 MA1842300
	pilot burner nozzle SIT natural/liquid gas bore $\varnothing$ 0.25mm Qty 1 pcs		
	Part No.	107700	Ref. No. —
	pilot burner bottom part SIT 100 series nozzle $\varnothing$ 0.25mm		
	Part No.	107702	Ref. No. 1031501800 1314800 MA1314800
	pilot burner bottom part SIT 100 series nozzle $\varnothing$ 0.35mm		





			
1			
<b>Part No.</b>	106907	<b>Ref. No.</b>	1315100 CR0588730
<b>description</b>	pilot burner SIT type 100 series 3 flames nozzle ø 0.35mm gas connection 6mm		
<b>For models:</b>	C9F4G, C9F4GS, C9F6G, C9F6GS, C9F8G, C9F8GS, NG74G, NG78G, NG94G, NG98G, P9D10G, P9D15G, P9DA10G, P9DA15G, T9F4G, T9F6GS		
<b>spare parts for</b>	106907		
	<b>Part No.</b>	100246	<b>Ref. No.</b> 1422600 MA1422600
	pilot burner nozzle natural gas bore ø 0.35mm Qty 1 pcs thread M8x0.75		
	<b>Part No.</b>	100855	<b>Ref. No.</b> —
	pilot burner bracket triple		
	<b>Part No.</b>	100885	<b>Ref. No.</b> 1324900 MA1324900
	air mixing sleeve for pilot burner Qty 1 pcs		
	<b>Part No.</b>	100916	<b>Ref. No.</b> —
	compression spring for pilot burner Qty 1 pcs		
	<b>Part No.</b>	100917	<b>Ref. No.</b> —
	gasket for pilot burner Qty 1 pcs aluminium ID ø 8.5mm ED ø 11mm thickness 1.2mm		
	<b>Part No.</b>	100918	<b>Ref. No.</b> —
	screw for pilot burner		
	<b>Part No.</b>	107162	<b>Ref. No.</b> —
	pilot burner cap SIT 3 flames Hmm Lmm Qty 1 pcs		
	<b>Part No.</b>	107702	<b>Ref. No.</b> 1031501800 1314800 MA1314800
	pilot burner bottom part SIT 100 series nozzle ø 0.35mm		
<b>accessories for</b>	106907		
	<b>Part No.</b>	100245	<b>Ref. No.</b> 1415100 2402299 3020054 MA1415100
	pilot burner nozzle LPG code 20 bore ø 0.2mm Qty 1 pcs thread M8x0.75		
	<b>Part No.</b>	100904	<b>Ref. No.</b> 1388000 1394700 MA1394700
	locking screw M10x1 for pipe ø 4mm Qty 1 pcs		
	<b>Part No.</b>	100905	<b>Ref. No.</b> 1394800 MA1394800
	locking screw M10x1 for pipe ø 6mm Qty 1 pcs		
	<b>Part No.</b>	102110	<b>Ref. No.</b> 1413100 1413200 1682300 1876500
	pilot tube copper pipe ø 4mm thickness 1mm L 3000mm		
	<b>Part No.</b>	102111	<b>Ref. No.</b> 1690200
	pilot tube copper pipe ø 6mm thickness 1mm L 3000mm		

<b>accessories for</b>	106907		
	<b>Part No.</b>	107171	<b>Ref. No.</b> 1031502100 1842300 MA1031502100 MA1842300
	pilot burner nozzle SIT natural/liquid gas bore ø 0.25mm Qty 1 pcs		
	<b>Part No.</b>	107700	<b>Ref. No.</b> —
	pilot burner bottom part SIT 100 series nozzle ø 0.25mm		
	<b>Part No.</b>	107701	<b>Ref. No.</b> —
	pilot burner bottom part SIT 100 series nozzle ø 0.2mm		













<b>accessories</b>			
<b>pilot burner bottom parts</b>			
			
1			
<b>Part No.</b>	107702	<b>Ref. No.</b>	1031501800 1314800 MA1314800
<b>description</b>	pilot burner bottom part SIT 100 series nozzle ø 0.35mm		
<b>For models:</b>	C7011G, C7011GFE, C7011GFG, C704G, C707G, C707GFE, C707GFG, C9F4G, C9F4GS, C9F6G, C9F6GS, C9F8G, C9F8GS, C9SB4GS, C9V2G, C9V2GS, C9V4G, C9V4GS, C9V6G, C9V6GS, C9V8G, C9V8GS		
<b>spare parts for</b>	107702		
	<b>Part No.</b>	100246	<b>Ref. No.</b> 1422600 MA1422600
	pilot burner nozzle natural gas bore ø 0.35mm Qty 1 pcs thread M8x0.75		
	<b>Part No.</b>	100916	<b>Ref. No.</b> —
	compression spring for pilot burner Qty 1 pcs		
	<b>Part No.</b>	100917	<b>Ref. No.</b> —
	gasket for pilot burner Qty 1 pcs aluminium ID ø 8.5mm ED ø 11mm thickness 1.2mm		
	<b>Part No.</b>	100918	<b>Ref. No.</b> —
	screw for pilot burner		
<b>accessories for</b>	107702		
	<b>Part No.</b>	100245	<b>Ref. No.</b> 1415100 2402299 3020054 MA1415100
	pilot burner nozzle LPG code 20 bore ø 0.2mm Qty 1 pcs thread M8x0.75		
	<b>Part No.</b>	100904	<b>Ref. No.</b> 1388000 1394700 MA1394700
	locking screw M10x1 for pipe ø 4mm Qty 1 pcs		
	<b>Part No.</b>	100905	<b>Ref. No.</b> 1394800 MA1394800
	locking screw M10x1 for pipe ø 6mm Qty 1 pcs		
	<b>Part No.</b>	102110	<b>Ref. No.</b> 1413100 1413200 1682300 1876500
	pilot tube copper pipe ø 4mm thickness 1mm L 3000mm		

Table continues overleaf



accessories for 107702	
	Part No. 102111 Ref. No. 1690200
pilot tube copper pipe ø 6mm thickness 1mm L 3000mm	
	Part No. 102742 Ref. No. —
pilot burner nozzle LPG code 25 bore ø 0.25mm Qty 1 pcs	

	
1	
Part No.	100880 Ref. No. 1874100 MA1874100
description pilot burner bottom part SIT 100 series nozzle ø 0.4mm	
For models: EF74G15, F12C4G15, F74G10, F74G15, F76G10, F78G15, F94G10, F94G15, F94G22, F94G22K, F96G10, F98G15, F98G22, F98G22K, F9S4G15, F9S4G22, F9S4G22K, F9S8G15, F9S8G22, F9S8G22K, FR74G, FR77G, FR92G13, FR92G22, FR92G22T, FR94G13, FR94G22, FR94G22T, NF74G15T, NF78G15T	

pilot burner nozzles	
	
1	
Part No.	100245 Ref. No. 1415100 24022299 3020054 MA1415100
description pilot burner nozzle LPG code 20 bore ø 0.2mm Qty 1 pcs thread M8x0.75	
For models: B9SB2G, B9SB4G, B9V2G, B9V4G, C7011G, C7011GFE, C7011GFG, C704G, C707G, C707GFE, C707GFG, C9F4G, C9F4GS, C9F6G, C9F6GS, C9F8G, C9F8GS, C9SB4GS, C9V2G, C9V2GS, C9V4G, C9V4GS, C9V6G, C9V6GS, C9V8G, C9V8GS, EF74G15, F12C4G15, F74G10, F74G15, F76G10, F78G15, F94G10, F94G15, F94G22, F94G22K, F96G10, F98G15, F98G22, F98G22K, F9S4G15, F9S4G22, F9S4G22K, F9S8G15, F9S8G22, F9S8G22K, F9SB2G, F9SB2GR, F9SB4G, F9SB4GR...(Other models you can see in the webshop)	

	
1	
Part No.	100246 Ref. No. 1422600 MA1422600
description pilot burner nozzle natural gas bore ø 0.35mm Qty 1 pcs thread M8x0.75	
For models: B9SB2G, B9SB4G, B9V2G, B9V4G, C7011G, C7011GFE, C7011GFG, C704G, C707G, C707GFE, C707GFG, C9F4G, C9F4GS, C9F6G, C9F6GS, C9F8G, C9F8GS, C9SB4GS, C9V2G, C9V2GS, C9V4G, C9V4GS, C9V6G, C9V6GS, C9V8G, C9V8GS, F9SB2G, F9SB2GR, F9SB4G, F9SB4GR, F9SB-4GRL, F9V2G, F9V2GR, F9V4G, F9V4GR, F9V4GRL, P9D10G, P9D15G, P9DA10G, P9DA15G, P9I10G, P9IA10G, T7011GFG, T707G, T707GFG, T9F4G, T9F6GS, T9SB4G, T9V4G, T9V6GS	

	
1	
Part No.	102972 Ref. No. 1996200 CR0684580 MA1996200
description pilot burner nozzle natural gas code 40 bore ø 0.4mm Qty 1 pcs	
For models: EF74G15, F12C4G15, F74G10, F74G15, F76G10, F78G15, F94G10, F94G15, F94G22, F94G22K, F96G10, F98G15, F98G22, F98G22K, F9S4G15, F9S4G22, F9S4G22K, F9S8G15, F9S8G22, F9S8G22K, NF-74G15T, NF78G15T, NG74G, NG78G, NG94G, NG98G	

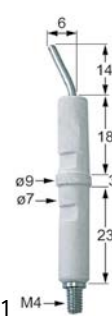
ignition electrodes	
	
Part No.	100706 Ref. No. 1031502500 224211 636700 MA224211 MA636700
description ignition electrode connection M4 Qty 1 pcs	
For models: 702BMG, 706, 706S, B9SB2G, B9SB4G, B9V2G, B9V4G, BIG40, BIG60, BMG40, BMG60, BR707G, BR94G, BR94GI, BR96G, BR96GI, BR9M4G, BR9M4GI, BR9M6G, BR9M6GI, BRG40, BRG40G, C7011GFE, C7011GFG, C707GFE, C707GFG, C9F4G, C9F4GS, C9F6G, C9F6GS, C9F8G, C9F8GS, CFG101, CFG101D, CFG101L, CFG101P, CFG120, CFG70, CFG70D, CFG70L, CFG70M, CFG70P, CP707G, CP92G, CP94G, CS10, CS102G, CS102GP, CS6, EC74GVG...(Other models you can see in the webshop)	







	
Part No.	100707 Ref. No. BN6A013302 R63050010
description ignition electrode D1 ø 7mm D2 ø 9mm connection ø2.4mm L1 14mm L2 6mm BL1 18mm BL2 3mm BL3 23mm to clip Qty 1 pcs	
For models: FG105M, FG105X, FG110M, FG110X, FG210M, FG210X, PG040M, PG040X, PG080M, PG080X	

miscellaneous	
	
1	
Part No.	100885 Ref. No. 1324900 MA1324900
description air mixing sleeve for pilot burner Qty 1 pcs	
For models: C7011G, C7011GFE, C7011GFG, C704G, C707G, C707GFE, C707GFG, C9F4G, C9F4GS, C9F6G, C9F6GS, C9F8G, C9F8GS, C9SB4GS, C9V2G, C9V2GS, C9V4G, C9V4GS, C9V6G, C9V6GS, C9V8G, C9V8GS	





gas components



140 - 145 -150 series

			
1			
<b>Part No.</b>	107114 <sup>1</sup>	<b>Ref. No.</b>	CM029000 MACM029000
<b>description</b>	pilot burner SIT type 140 series 2 flames nozzle ømm gas connectionmm		
<b>For models:</b>	B74G, B78G, B94G, B98G, BR78GF, BR78GI, BR912GFM, BR912GIM, BR98GF, BR98GFM, BR98GI, BR98GIM, BR9S8GF, BR9S8GI, C7FG9G, EFT74GLVG, EFT74GRVG, EFT78GLVG, EFT78GMVG, ET78GVG, ET-7FG8G, FT129GLC, FT129GM, FT12C9GL, FT12C9GM, FT12C9GTL, FT-12C9GTMC, FT74GL, FT74GLC, FT74GR, FT74GRC, FT76GL, FT76GLC, FT76GM, FT76GMC, FT76GR, FT78GL, FT78GLC, FT78GLT, FT78GM, FT78GMC, FT78GMT, FT78GR, FT78GRT, FT94G, FT94GL, FT94GLC, FT-94GR, FT94GRC, FT96GL...(Other models you can see in the webshop)		
<b>spare parts for</b>	107114		
	<b>Part No.</b>	100907	<b>Ref. No.</b> 1891700 24010899 MA1891700 MA24010899
	screw connection thread M10x1 Qty 1 pcs type SEF 1 ømm for thermocouple		
<b>accessories for</b>	107114		
	<b>Part No.</b>	100204	<b>Ref. No.</b> 1888000 MA1888000
	pilot burner nozzle SIT LPG code 14 bore ø 0.18/0.20mm Qty 1 pcs suitable for 140 series		
	<b>Part No.</b>	100205	<b>Ref. No.</b> 1033722000 BN822140380 MA1033722000
	pilot burner nozzle SIT LPG code 19 bore ø 0.23/0.26mm Qty 1 pcs suitable for SIT 150 series		
	<b>Part No.</b>	100206	<b>Ref. No.</b>
	pilot burner nozzle SIT natural gas code 36 bore ø 0.60/0.55mm Qty 1 pcs suitable for SIT 150 series		
	<b>Part No.</b>	100207	<b>Ref. No.</b> 1887800 MA1887800
	pilot burner nozzle SIT natural gas code 27 bore ø 0.40/0.38mm suitable for SIT 140 series		
	<b>Part No.</b>	100216	<b>Ref. No.</b>
	pilot burner nozzle SIT natural gas code 38 bore ø 0.45mm Qty 1 pcs suitable for SIT 150 series		
	<b>Part No.</b>	100701	<b>Ref. No.</b> 1888300 1949900 MA1888300 MA1949900
	ignition electrode connection M4 Qty 1 pcs		
	<b>Part No.</b>	100801	<b>Ref. No.</b>
	gasket for pilot burner Qty 1 pcs		
	<b>Part No.</b>	100897	<b>Ref. No.</b> 1881000 1888100 MA1888100
	olive for pipe ø 4mm Qty 1 pcs for pilot burner		
	<b>Part No.</b>	100898	<b>Ref. No.</b>
	olive for pipe ø 6mm Qty 1 pcs for pilot burner		
	<b>Part No.</b>	100906	<b>Ref. No.</b> 1888400 MA1888400
	screw connection thread M10x1 for ignition electrode brass Qty 1 pcs WS 10		

<sup>1</sup>incl. thermocouple fitting

<b>accessories for</b>	107114		
	<b>Part No.</b>	100908	<b>Ref. No.</b> 0100777 673500 MA673500 R0100777 SIR0100777
	union screw thread M10x1 for pipe ø 4mm Qty 1 pcs		
	<b>Part No.</b>	100909	<b>Ref. No.</b> LA62060223 LAR62060223
	union screw thread M10x1 for pipe ø 6mm Qty 1 pcs		
	<b>Part No.</b>	102110	<b>Ref. No.</b> 1413100 1413200 1682300 1876500
	pilot tube copper pipe ø 4mm thickness 1mm L 3000mm		
	<b>Part No.</b>	102111	<b>Ref. No.</b> 1690200
	pilot tube copper pipe ø 6mm thickness 1mm L 3000mm		

190 series













			
1			
<b>Part No.</b>	100110	<b>Ref. No.</b>	1949700 MA1949700
<b>description</b>	pilot burner SIT type 190 series 3 flames nozzle ømm gas connectionmm		
<b>For models:</b>	MM10IG, P9110G, P9IA10G		
<b>accessories for</b>	100110		
	<b>Part No.</b>	100202	<b>Ref. No.</b>
	pilot burner nozzle natural gas code 41 Qty 1 pcs nozzle ø 0.41mm		
	<b>Part No.</b>	100203	<b>Ref. No.</b>
	pilot burner nozzle LPG code 25 Qty 1 pcs nozzle ø 0.25mm		
	<b>Part No.</b>	100701	<b>Ref. No.</b> 1888300 1949900 MA1888300 MA1949900
	ignition electrode connection M4 Qty 1 pcs		
	<b>Part No.</b>	100906	<b>Ref. No.</b> 1888400 MA1888400
	screw connection thread M10x1 for ignition electrode brass Qty 1 pcs WS 10		
	<b>Part No.</b>	100907	<b>Ref. No.</b> 1891700 24010899 MA1891700 MA24010899
	screw connection thread M10x1 Qty 1 pcs type SEF 1 ømm for thermocouple		
	<b>Part No.</b>	100908	<b>Ref. No.</b> 0100777 673500 MA673500 R0100777 SIR0100777
	union screw thread M10x1 for pipe ø 4mm Qty 1 pcs		
	<b>Part No.</b>	100909	<b>Ref. No.</b> LA62060223 LAR62060223
	union screw thread M10x1 for pipe ø 6mm Qty 1 pcs		
	<b>Part No.</b>	101282	<b>Ref. No.</b> 469000 MA469000
	olive for pipe ø 4mm L 7.4mm Qty 1 pcs		

Table continues overleaf







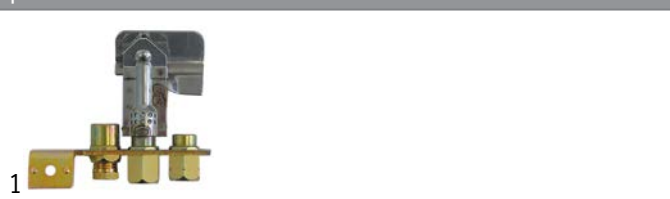

accessories for		100110	
	Part No.	101287	Ref. No. —
olive for pipe ø 6mm Qty 1 pcs			
	Part No.	102110	Ref. No. 1413100 1413200 1682300 1876500
pilot tube copper pipe ø 4mm thickness 1mm L 3000mm			
	Part No.	102111	Ref. No. 1690200
pilot tube copper pipe ø 6mm thickness 1mm L 3000mm			
	Part No.	107650	Ref. No. 0100802 CR0410100 R0100802 SIR0100802
pilot burner nozzle SIT LPG code 30 Qty 1 pcs			

**POLIDORO**

**pilot burners**



<b>Part No.</b>	100076	<b>Ref. No.</b>	BN6A013220
<b>description</b>	pilot burner POLIDORO 3 flames natural gas code 29.2 gas connection 6mm		
<b>spare parts for</b>	100076		
	Part No.	100907	Ref. No. 1891700 24010899 MA1891700 MA24010899
screw connection thread M10x1 Qty 1 pcs type SEF 1 ømm for thermocouple			
<b>accessories for</b>	100076		
	Part No.	100000	Ref. No. —
pilot burner nozzle POLIDORO LPG code 22 bore ø 0.22mm Qty 1 pcs			
	Part No.	100208	Ref. No. —
pilot burner nozzle POLIDORO LPG code 20 bore ø 0.2mm Qty 1 pcs			
	Part No.	100209	Ref. No. —
pilot burner nozzle POLIDORO natural gas code 40 bore ø 0.4mm Qty 1 pcs			
	Part No.	100701	Ref. No. 1888300 1949900 MA1888300 MA1949900
ignition electrode connection M4 Qty 1 pcs			
	Part No.	100906	Ref. No. 1888400 MA1888400
screw connection thread M10x1 for ignition electrode brass Qty 1 pcs WS 10			
	Part No.	100907	Ref. No. 1891700 24010899 MA1891700 MA24010899
screw connection thread M10x1 Qty 1 pcs type SEF 1 ømm for thermocouple			
	Part No.	100908	Ref. No. 0100777 673500 MA673500 R0100777 SIR0100777
union screw thread M10x1 for pipe ø 4mm Qty 1 pcs			

accessories for		100076	
	Part No.	100909	Ref. No. LA62060223 LAR62060223
union screw thread M10x1 for pipe ø 6mm Qty 1 pcs			
	Part No.	102110	Ref. No. 1413100 1413200 1682300 1876500
pilot tube copper pipe ø 4mm thickness 1mm L 3000mm			
	Part No.	102111	Ref. No. 1690200
pilot tube copper pipe ø 6mm thickness 1mm L 3000mm			
	Part No.	102508	Ref. No. —
union screw thread M10x1 for pipe ø 4mm Qty 5 pcs			
	Part No.	102509	Ref. No. —
union screw thread M10x1 for pipe ø 6mm Qty 5 pcs			
	Part No.	102699	Ref. No. —
pilot burner nozzle POLIDORO natural gas code 25.2 bore ø 2x0.25mm Qty 1 pcs 2 bores			
	Part No.	102795	Ref. No. —
olive for pipe ø 4mm Qty 1 pcs			
	Part No.	102797	Ref. No. —
olive for pipe ø 6mm Qty 1 pcs			
	Part No.	106703	Ref. No. —
pilot burner nozzle POLIDORO natural gas code 27.2 bore ø 2x0.27mm Qty 1 pcs			
	Part No.	106704	Ref. No. —
pilot burner nozzle POLIDORO LPG code 16.2 bore ø 2x0.16mm Qty 1 pcs			
	Part No.	106763	Ref. No. —
pilot burner nozzle POLIDORO natural gas code 27.2A bore ø 2x 0.27mm Qty 1 pcs			
	Part No.	106859	Ref. No. —
pilot burner nozzle POLIDORO LPG code 24 bore ø 0.24mm Qty 1 pcs			



electrodes

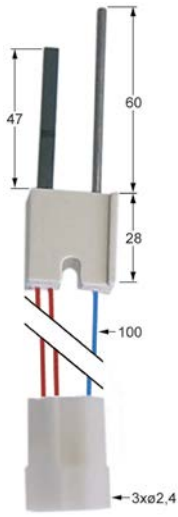

<b>Part No.</b>	100730	<b>Ref. No.</b>	R63050040
<b>description</b>	glow plug cable length 100mm connection ø2.4mm L1 47mm L2 60mm		
<b>For models:</b>	CVG105H, CVG105M, MG106M, MG106P, MG106X, MG110M, MG110X, MG120M, MG120P, MG120X, MG210M, MG210P, MG210X, MG220M, MG220P, MG220X, MGC20X, MGC24H, MGC40H, VG105M, VG105X, VG106M, VG106P, VG106X, VG110M, VG110P, VG110X, VG120M, VG120P, VG120X, VG210M, VG210P, VG210X, VG220M, VG220P, VG220X		

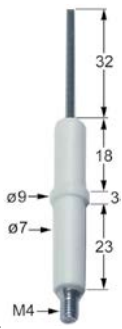

<b>Part No.</b>	100701	<b>Ref. No.</b>	1888300 1949900 MA1888300 MA1949900
<b>description</b>	ignition electrode connection M4 Qty 1 pcs		
<b>For models:</b>	B74G, B78G, B94G, B98G, B9SB2G, B9SB4G, B9V2G, B9V4G, B9VP4G, BF78G, BF912G, BF912GH, BF98G, BM74G, BM77G, BR707G, BR707GI, BR78GF, BR78GI, BR912GFM, BR912GIM, BR94G, BR94GI, BR98GF, BR98GFM, BR98GI, BR98GIM, BR9M4G, BR9M4GI, BR9M6G, BR9M6GI, BR9S8GF, BR9S8GI, BR9SB4G, BR9SB4GI, C124G, C129G, C12C2G9, C12C9G, C12FG9G, C12FGP9G, C7011G, C7011GFE, C7011GFG, C704G, C707G, C707GFE, C707GFG, C712G, C74G...(Other models you can see in the webshop)		

<b>accessories for</b>	100701		
	<b>Part No.</b>	100906	<b>Ref. No.</b> 1888400 MA1888400
	screw connection thread M10x1 for ignition electrode brass Qty 1 pcs WS 10		

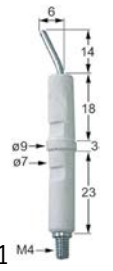

<b>Part No.</b>	100706	<b>Ref. No.</b>	1031502500 224211 636700 MA224211 MA636700
<b>description</b>	ignition electrode connection M4 Qty 1 pcs		
<b>For models:</b>	702BMG, 706, 706S, B9SB2G, B9SB4G, B9V2G, B9V4G, BIG40, BIG60, BMG40, BMG60, BR707G, BR94G, BR94GI, BR96G, BR96GI, BR9M4G, BR9M4GI, BR9M6G, BR9M6GI, BRG40, BRG40G, C7011GFE, C7011GFG, C707GFE, C707GFG, C9F4G, C9F4GS, C9F6G, C9F6GS, C9F8G, C9F8GS, CFG101, CFG101D, CFG101L, CFG101P, CFG120, CFG70, CFG70D, CFG70L, CFG70M, CFG70P, CP707G, CP92G, CP94G, CS10, CS102G, CS102GP, CS6, EC74GVG...(Other models you can see in the webshop)		



<b>Part No.</b>	100707	<b>Ref. No.</b>	BN6A013302 R63050010
<b>description</b>	ignition electrode D1 ø 7mm D2 ø 9mm connection ø2.4mm L1 14mm L2 6mm BL1 18mm BL2 3mm BL3 23mm to clip Qty 1 pcs		
<b>For models:</b>	FG105M, FG105X, FG110M, FG110X, FG210M, FG210X, PG040M, PG040X, PG080M, PG080X		

2 gas components





1

<b>Part No.</b>	104687	<b>Ref. No.</b>	R63050080 R63050090
<b>description</b>	ignition electrode flange length 17mm flange width 24mm D1 ø 9.5mm D2 ø 9.5mm L1 49mm BL1 64mm BL2 52mm connection male faston 2.8mm fixing dimensions 4.5mm flange		
<b>For models:</b>	MG102M, MG102P, MG102T, MG201M, MG201P		

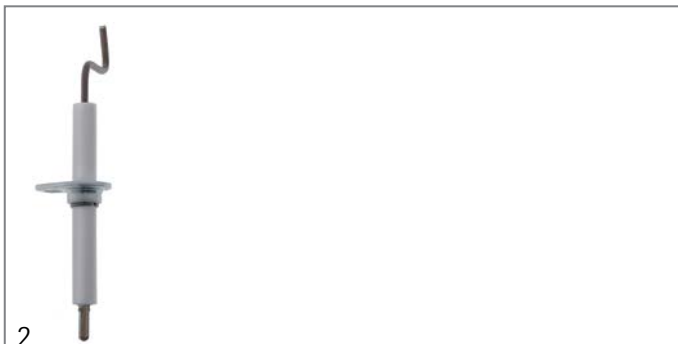

2

<b>Part No.</b>	104695	<b>Ref. No.</b>	R63050310
<b>description</b>	ignition electrode flange length 23mm flange width 15mm D1 ø 7mm D2 ø 7mm L1 13mm L2 19mm L3 13mm BL1 31mm BL2 24mm connection M4 fixing dimensions 4x5mm flange		
<b>For models:</b>	GC106M, GM106H, GM106M, GM106M+SC, GM106P, GV106H, GV106M, GV106M+SC, GV106P		

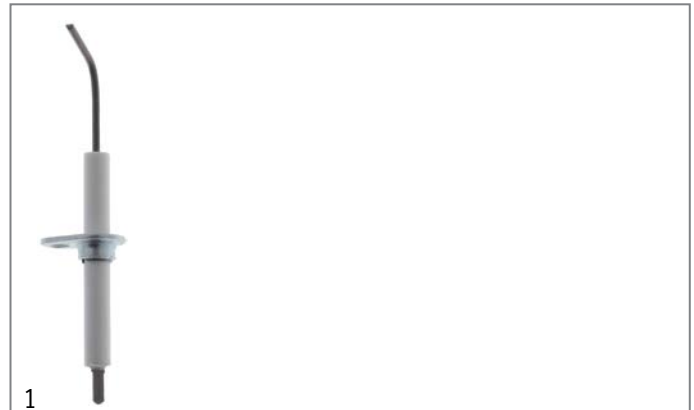

1

<b>Part No.</b>	104686	<b>Ref. No.</b>	R63050340
<b>description</b>	ignition electrode flange length 23mm flange width 15mm D1 ø 7mm D2 ø 7mm L1 20mm L2 15mm BL1 22mm BL2 4mm BL3 28mm connection male faston 2.8mm		
<b>For models:</b>	GC110M, GC210M, GM110H, GM110M, GM110M+SC, GM110P, GM210H, GM210M, GM210M+SC, GM210P, GV110H, GV110M, GV-110M+SC, GV110P, GV210H, GV210M, GV210M+SC, GV210P		

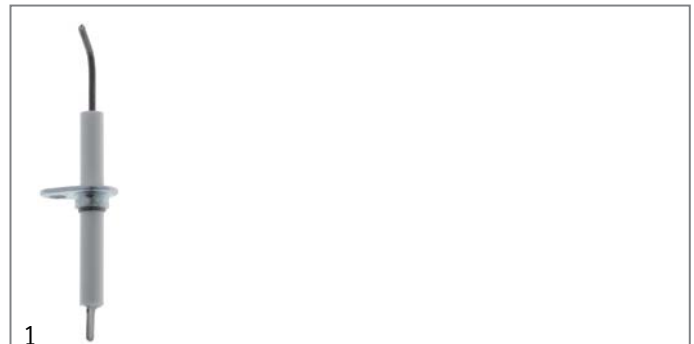

1

<b>Part No.</b>	104685	<b>Ref. No.</b>	R63050300
<b>description</b>	ignition electrode flange length 23mm flange width 15mm D1 ø 7mm L1 15mm L2 12mm BL1 22mm BL2 31mm connection male faston 2.8mm fixing dimensions ø4mm with flange		
<b>For models:</b>	GC106M, GM106H, GM106M, GM106M+SC, GM106P, GV106H, GV106M, GV106M+SC, GV106P		

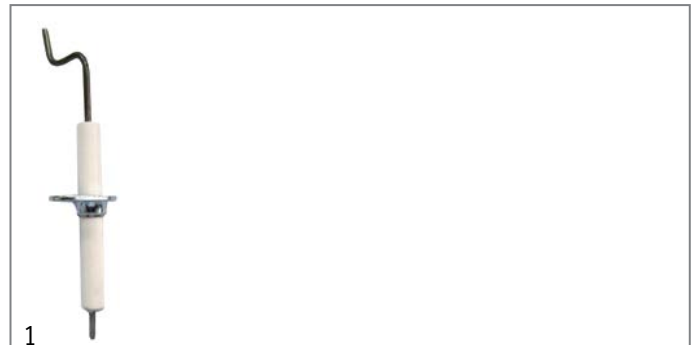

1

<b>Part No.</b>	104451	<b>Ref. No.</b>	R63050350
<b>description</b>	ignition electrode flange length 23mm flange width 15mm D1 ø 7mm L1 25mm L2 14mm L4 15mm BL1 22mm BL2 34mm		
<b>For models:</b>	GC110M, GC210M, GM110H, GM110M, GM110M+SC, GM110P, GM210H, GM210M, GM210M+SC, GM210P, GV110H, GV110M, GV-110M+SC, GV110P, GV210H, GV210M, GV210M+SC, GV210P		

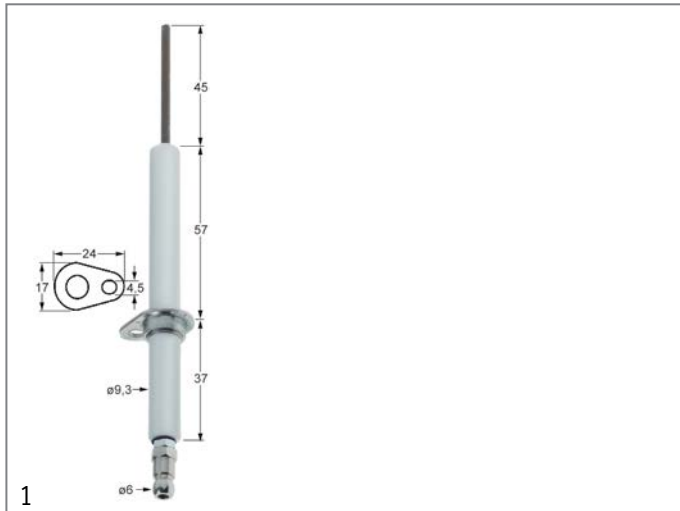

<b>Part No.</b>	106756	<b>Ref. No.</b>	LAR63050130
<b>description</b>	ignition electrode flange length 24mm flange width 17mm D1 ø 9.3mm L1 45mm BL1 57mm BL2 37mm connection ø6 fixing dimensions ø4.5mm A1/B13/C2		

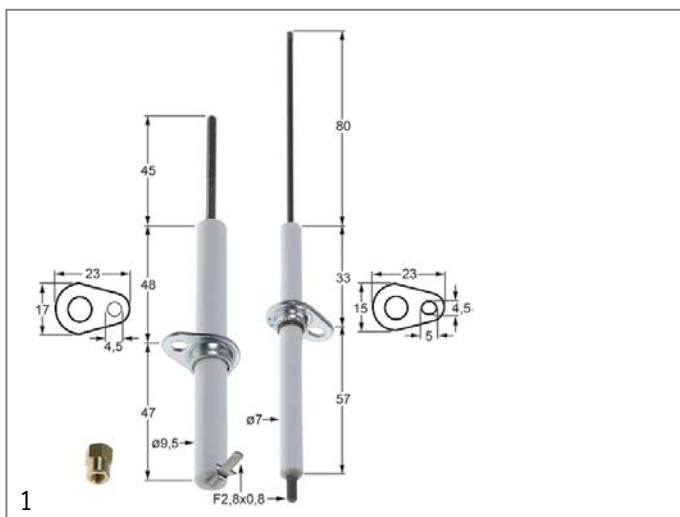

<b>Part No.</b>	106525	<b>Ref. No.</b>	R63050070
<b>description</b>	ignition electrode set Qty 2 flange length 23mm flange width 15/17mm D1 ø 7/9.5mm L1 80/45mm BL1 33/48mm BL2 57/47mm connection F2.8x0.8 fixing dimensions ø4.5mm		
<b>For models:</b>	MACG05M, MACG07M, MG061D, MG061M, MG061P, MG061T, MG101M, MG101P, MG101T, MG201T, MVG051P		

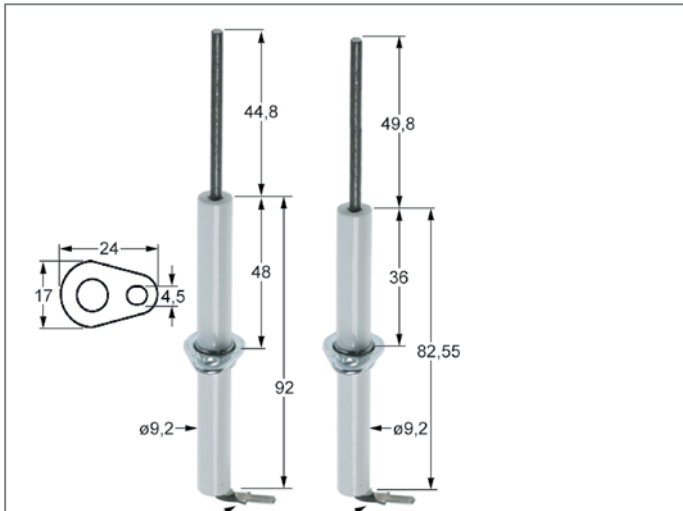

<b>Part No.</b>	106647	<b>Ref. No.</b>	R63050100
<b>description</b>	ignition electrode set flange length 24mm flange width 17mm D1 ø 9.5mm L1 45mm BL1 48mm BL2 48mm connection male faston 2.8mm with screw connection 1x ignition 1x flame monitoring		
<b>For models:</b>	GMT06D, GMT20D, GVT06D, GVT20D, MACG10M, MACG20M, MG101D, MG101M, MG101P, MG102D, MG102M, MG102P, MG102T, MG201D, MG201M, MG201P, MG201T, MG202D, MG202M, MG202P, MG202T, MGMT06D, MGMT06P, MGMT10D, MGMT10P, MGMT20D, MGMT20P, MGMT21D, MGMT21P, MGMT40D, MGMT40P, MGVT06D, MGVT06P, MGVT10D, MGVT10P, MGVT20D, MGVT20P, MGVT21D, MGVT21P, MGVT40D, MGVT40P		



<b>Part No.</b>	100906	<b>Ref. No.</b>	1888400 MA1888400
<b>description</b>	screw connection thread M10x1 for ignition electrode brass Qty 1 pcs WS 10		
<b>For models:</b>	B74G, B78G, B94G, B98G, B9SB2G, B9SB4G, B9V2G, B9V4G, B9VP4G, BF78G, BF912G, BF912GH, BF98G, BM74G, BM77G, BR707G, BR707GI, BR78GF, BR78GI, BR912GFM, BR912GIM, BR94G, BR94GI, BR98GF, BR98GFM, BR98GI, BR98GIM, BR9M4G, BR9M4GI, BR9M6G, BR9M6GI, BR9S8GF, BR9S8GI, BR9SB4G, BR9SB4GI, C124G, C129G, C12C2G9, C12C9G, C12FG9G, C12FGP9G, C7011G, C7011GFE, C7011GFG, C704G, C707G, C707GFE, C707GFG, C712G, C74G...(Other models you can see in the webshop)		

ignition cables

terminals and connectors



<b>Part No.</b>	100023	<b>Ref. No.</b>	20418099 MA20418099
<b>description</b>	female bullet size 2.3mm 0.5-1.5mm² CuZn t.max. 125°C Qty 20 pcs		



pre-assembled cables

1			
<b>Part No.</b>	100026	<b>Ref. No.</b>	548300 BN2532997
<b>description</b>	ignition cable cable length 1000mm connection ø4mm / F6.3mm		

1			
<b>Part No.</b>	100179	<b>Ref. No.</b>	R66600400
<b>description</b>	ignition cable cable length 1200mm connection F2.8mm / ø2.4mm		
<b>For models:</b>	FG105M, FG105X, PG040M, PG040X		

1			
<b>Part No.</b>	100195	<b>Ref. No.</b>	1950312 1950324 MA1950324
<b>description</b>	ignition cable cable length 1200mm connection ø2.4mm / lug M4		
<b>For models:</b>	BF78G, BF912G, BF912GH, BF98G, C124G, C129G, C12C2G9, C12C9G, C12FG9G, C7011G, C7011GFE, C7011GFG, C704G, C707G, C707GFE, C707GFG, C712G, C74G, C78G, C7FE12G, C7FE8G, C7FG12G, C7FG8G, C7FG9G, C7FGM12G, C912G, C912GS, C94G, C94GP, C94GS, C98G, C98GP, C98GS, C9F4GS, C9F6GS, C9F8GS, C9FE12G, C9FE12GS, C9FE4GS, C9FE6GS, C9FE8G, C9FE8GS, C9FEP4GS, C9FEP6GS, C9FEP8GS, C9FG12G, C9FG12GS, C9FG16G, C9FG8G, C9FG8GP... (Other models you can see in the webshop)		

1			
<b>Part No.</b>	102163	<b>Ref. No.</b>	R66600410
<b>description</b>	ignition cable cable length 1500mm connection F2.8mm / ø2.4mm		
<b>For models:</b>	FG110M, FG110X, FG210M, FG210X, PG080M, PG080X		

1			
<b>Part No.</b>	107851	<b>Ref. No.</b>	R66110370
<b>description</b>	ignition cable cable length 300mm set 2-piece		
<b>For models:</b>	MACG05M, MACG07M, MACG10M, MACG20M, MG061D, MG061M, MG061P, MG061T, MG101D, MG101M, MG101P, MG101T, MG201D, MG201M, MG201P, MG201T, MVG051P		

1			
<b>Part No.</b>	100186	<b>Ref. No.</b>	1047024400 1936300 MA1047024400 MA1936300
<b>description</b>	ignition cable cable length 600mm connection ø2.4mm / lug M4		
<b>For models:</b>	B74G, B78G, B94G, B98G, B9SB2G, B9SB4G, B9V2G, B9V4G, BIG40, BIG60, BM74G, BM77G, BMG40, BMG60, BR707G, BR707GI, BR912GFM, BR912GIM, BR98GF, BR98GFM, BR98GI, BR98GIM, BRG40, BRG40G, CP704G, EF74G15, EF74G8VA, EF74G8VG, EFT74GLVG, EFT74GRVG, EFT78GLVG, EFT78GMVG, EPC74G, F12C4G15, F74G10, F74G15, F74G6, F76G10, F78G15, F94G10, F94G15, F94G22, F94G22K, F94G6, F96G10, F98G15, F98G22, F98G22K, F9S4G15, F9S4G22...(Other models you can see in the webshop)		

1			
<b>Part No.</b>	100199	<b>Ref. No.</b>	1088300 1088600 1088900 1152700 1152800 MA1152800
<b>description</b>	ignition cable cable length 600mm connection ø4mm / F2.8mm		
<b>For models:</b>	B9SB2G, B9V2G, BR94G, BR94GI, BR96G, BR96GI, BR9M4G, BR9M4GI, BR9M6G, BR9M6GI, CP92G, CP94G, F9SB2G, F9SB2GR, F9SB4G, F9SB-4GR, F9SB4GRL, F9V2G, F9V2GR, F9V4G, F9V4GR, F9V4GRL, FR74G, FR77G, FR92G22, FR94G23, FT74G, FT74GR, FT77G, FT77GRL, GB707G, P9D2G, T7011GFG, T707G, T707GFG		

1			
<b>Part No.</b>	100025	<b>Ref. No.</b>	1394600 671300 671400 671500 672400 MA1394600
<b>description</b>	ignition cable cable length 600mm connection ø4mm / F6.3mm		
<b>For models:</b>	FR92G13, FR94G13		

1			
<b>Part No.</b>	100019	<b>Ref. No.</b>	1047024600 1936400 1950300 BN4185326050610 CR0688770 MA1936400
<b>description</b>	ignition cable cable length 900mm connection ø2.4mm / ø4mm		
<b>For models:</b>	B9SB2G, B9SB4G, B9V2G, B9V4G, B9VP4G, BF78G, BF912G, BF912GH, BF98G, BR78GF, BR78GI, BR912GFM, BR912GIM, BR98GF, BR98GFM, BR98GI, BR98GIM, BR9S8GF, BR9S8GI, C12FGP9G, C7FG12G, C7FG8G, C9F4E, C9F4GS, C9F6E, C9F6GS, C9F8GS, C9FE4GS, C9FE6GS, C9FE8GS, C9FG12G, C9FG16G, C9FG8G, C9FG8GP, C9FGM12G, C9FP, C9FP4GS, C9FP6GS, C9FP8GS, C9V2GS, C9V4GS, C9V6GS, C9V8GS, CP92G, CP94G, CP9SB2G, CP9SB4G, ET78GVG, ET7FG8G, FT129GLC... (Other models you can see in the webshop)		

1			
<b>Part No.</b>	102155	<b>Ref. No.</b>	1152600 SI9303074 SIR9303074
<b>description</b>	ignition cable cable length 900mm connection ø4mm / F2.8mm		
<b>For models:</b>	B9SB4G, B9V4G, C9F4G, C9F4GS, C9F6G, C9F6GS, C9F8G, C9F8GS, T9F4G, T9F6GS, T9SB4G, T9V4G, T9V6GS		

1			
<b>Part No.</b>	107853	<b>Ref. No.</b>	R66605900
<b>description</b>	ignition cable for combi-steamer set 2-piece L 800mm		
<b>For models:</b>	GC106M, GC110M, GC210M, GM106H, GM106M, GM106M+SC, GM106P, GM110H, GM110M, GM110M+SC, GM110P, GM210H, GM210M, GM210M+SC, GM210P, GV106H, GV106M, GV106M+SC, GV106P, GV110H, GV110M, GV110M+SC, GV110P, GV210H, GV210M, GV210M+SC, GV210P		

2 gas components





			
1			
<b>Part No.</b>	107786	<b>Ref. No.</b>	LA66605120 LAR66605120
<b>description</b>	ignition cable ID ø 7/4mm thicknessmm Qty 1m silicone permanent temperature°C t.max. 155°C flashover voltage 30000V red L 800mm		

			
1			
<b>Part No.</b>	107855	<b>Ref. No.</b>	R66110380
<b>description</b>	ignition cable set 2-piece L 700mm		
<b>For models:</b>	MG102M, MG102P, MG102T		

			
1			
<b>Part No.</b>	107787	<b>Ref. No.</b>	LAR66605801
<b>description</b>	ignition cable set L 700mm		

piezoelectric igniters

mounting diameter 22mm

			
1			
<b>Part No.</b>	100013	<b>Ref. No.</b>	1031500600
<b>description</b>	piezoelectric igniter body plastic blowing mounting ø 22mm connection ø2.4mm cable lengthmm		
<b>accessories for</b>	100013		
	<b>Part No.</b>	<b>Ref. No.</b>	<b>20418099</b> MA20418099
	female bullet size 2.3mm 0.5-1.5mm² CuZn t.max. 125°C Qty 20 pcs		

ignition units

			
1			
<b>Part No.</b>	104688	<b>Ref. No.</b>	LA65180270 LAR65180270
<b>description</b>	ignition unit outputs 1 220-240VAC dimensions 84x62x38mm mounting distance 59mm inlet F6.3x0.8 outlet ø4mm type TRK2-30PVD 69VA 50/60Hz 0.3A protection IP00		

			
1			
<b>Part No.</b>	102485	<b>Ref. No.</b>	1450300 2971400 BN6A050100 MA2971400 R65180290
<b>description</b>	ignition unit outputs 2 220-240VAC 0.6VA 50-60Hz		
<b>For models:</b>	BR912GFM, BR912GIM, BR94G, BR94GI, BR98GF, BR98GFM, BR98GI, BR98GIM, BR9M4G, BR9M4GI, BR9M6G, BR9M6GI, BR9SB4G, BR9SB4GI, CS10, CS102G, CS102GP, CS6, FC10G, FC20G, FC5G, FC7G, FG105M, FG105X, FG110M, FG110X, FG210M, FG210X, FR92G22, FR94G23, MS10AG, MS10IG, MS70AG, MS70IG, MS70IGS, NBR912GFM, NBR912GIM, NBR98GF, NBR98GFM, NBR98GI, NBR98GIM, NF94G23K, NF98G23K, NPC74G, NPC76G, NPC78G, NPC94G, NPC96G, NPC98G, NPD76G5...(Other models you can see in the webshop)		

			
1			
<b>Part No.</b>	102388	<b>Ref. No.</b>	1037301400 MA1037301400
<b>description</b>	ignition unit outputs 4 230VAC dimensions 111x23x34mm mounting distance 100mm inlet F6.3x0.8 outlet F2.8x0.8 type WAC-T4 0.6VA 50/60Hz		

ignition switches

			
1			
<b>Part No.</b>	345038	<b>Ref. No.</b>	CRO410290
<b>description</b>	momentary push switch mounting ø 25mm black 2NO 250V 16A connection male faston 6.3mm ambient temperature max. 85°C protection IP40		
<b>For models:</b>	CFG70, CFG70M, NBR912EFM, NBR912EIM, NBR912GFM, NBR912GIM, NBR98EF, NBR98EFM, NBR98EI, NBR98EIM, NBR98GF, NBR98GFM, NBR98GI, NBR98GIM		



thermocouples

plug-in thermocouples

plug-in thermocouples standard

with barrel socket  $\varnothing 6(6.5)$ mm

thermocouples SIT

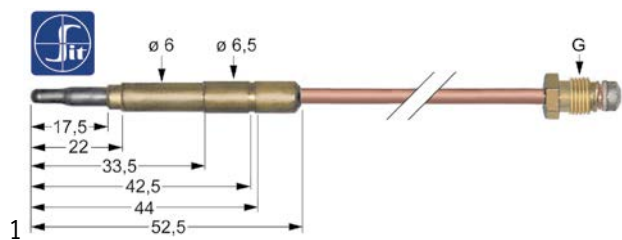

<b>Part No.</b>	107618	<b>Ref. No.</b>	641600 MA641600
<b>description</b>	thermocouple SIT M10x1 L 750mm plug connection $\varnothing 6.0(6.5)$ mm		

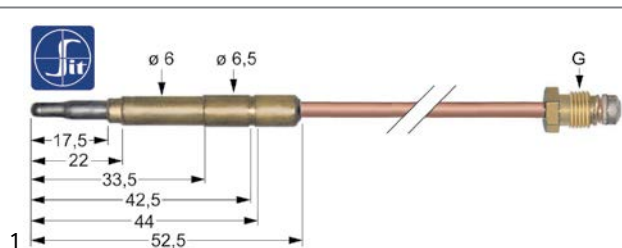

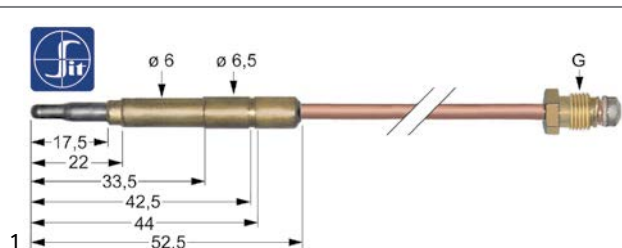

<b>Part No.</b>	107601	<b>Ref. No.</b>	1033027500 1033027800 1206400 MA1033027800 MA1206400
<b>description</b>	thermocouple SIT M8x1 L 600mm plug connection $\varnothing 6.0(6.5)$ mm		

**For models:** BIG40, BIG60, BRG40, BRG40G, CFG101, CFG101D, CFG101L, CFG101P, CFG120, CFG70, CFG70D, CFG70L, CFG70M, CFG70P, CFGE61, CFGE61D, CFGE61L, CFGE61P, FTG40B, FTG40BLC, FTG40BR, FTG60B, FTG60BLC, FTG60BR, FTG60BRR, FTG80B, FTG80BLC, FTG80BR, OCFG101, OCFG120, OCFG70, OCFGE61, OPCG41, OPCG61, PCG41, PCG41D, PCG41L, PCG41P, PCG61, PCG61D, PCG61L, PCG61P, PCGD41, PCGD41D, PCGD41L, PCGD41P, PCGD61, PCGD61D, PCGD61L, PCGD61P



<b>Part No.</b>	107602	<b>Ref. No.</b>	1206500 MA1206500
<b>description</b>	thermocouple SIT M8x1 L 850mm plug connection $\varnothing 6.0(6.5)$ mm		
<b>For models:</b>	BR96G, BR96GI, BR9M6G, BR9M6GI, GB707G		

**accessories for** 107602

	<b>Part No.</b>	100920	<b>Ref. No.</b>	—
	thermocouple fitting thread M8x1 / M9x1 Qty 1 pcs			
	<b>Part No.</b>	100922	<b>Ref. No.</b>	—
	thermocouple fitting thread M10x1 / ASA 11/32 Qty 1 pcs			

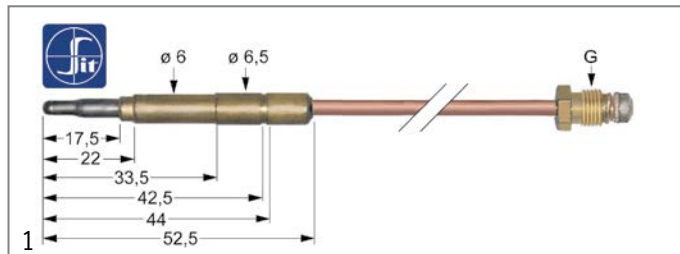

<b>Part No.</b>	107613	<b>Ref. No.</b>	263800 MA263800
<b>description</b>	thermocouple SIT M9x1 L 1200mm plug connection $\varnothing 6.0(6.5)$ mm		
<b>For models:</b>	704, 704S, 706, 706AS, 706S, B9SB2G, B9SB4G, B9V2G, B9V4G, B9VP4G, C7FG9G, CS10, CS6, MM10DG, MM10DGS, MM15DG, NC7FG12G44, NC7FG8G32, NC7FG8G36, NC7FG8G48, NC9FG12G52, NC9FG16G72, NC9FG8G32, NC9FG8G36, NC9FG8G48, NT7FG12G, NT-7FG8G, NT9FG12G, NT9FG8G, P9D10G, P9D15G, P9DA10G, P9DA15G, P9DASB10G, P9DSB10G, PDASB10G, TPF706, TPF706S		

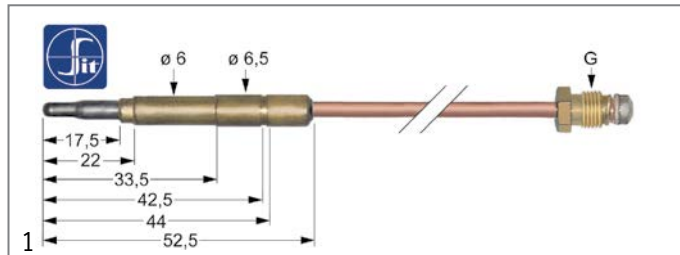

<b>Part No.</b>	107614	<b>Ref. No.</b>	2639-00 6A011800 R63040030 SI0100818 SIR0100818
<b>description</b>	thermocouple SIT M9x1 L 1500mm plug connection $\varnothing 6.0(6.5)$ mm		
<b>For models:</b>	CS102G, CS102GP, FG110M, FG110X, FG210M, FG210X, PG080M, PG080X		

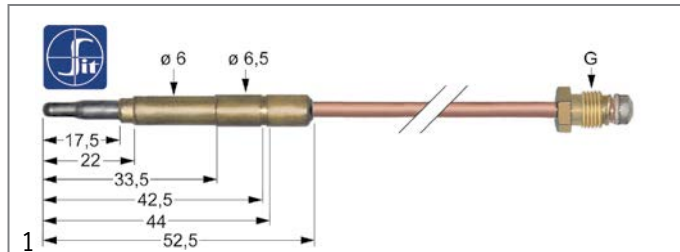

<b>Part No.</b>	107606	<b>Ref. No.</b>	1031500400 MA1031500400
<b>description</b>	thermocouple SIT M9x1 L 320mm plug connection $\varnothing 6.0(6.5)$ mm		
<b>For models:</b>	FQG40, FQG60		





gas components

<b>Part No.</b>	107608	<b>Ref. No.</b>	1031504300 641900 6A011912 BN6A011912 MA1031504300 MA641900
<b>description</b>	thermocouple SIT M9x1 L 500mm plug connection ø6.0(6.5)mm		
<b>For models:</b>	C124G, C129G, C12C2G9, C12C9G, C12FG9G, EFT74GLVG, EFT74GRVG, EFT78GLVG, EFT78GMVG, FT74G, FT74GR, FT77G, FT77GRL		

<b>Part No.</b>	107609	<b>Ref. No.</b>	1031501500 1033027600 90520 MA1031501500 MA1033027600 MA90520
<b>description</b>	thermocouple SIT M9x1 L 600mm plug connection ø6.0(6.5)mm		
<b>For models:</b>	B9SB2G, B9V2G, BMG40, BMG60, BR707G, C9F4G, C9F4GS, C9F6G, C9F6GS, C9F8G, C9F8GS, CP92G, CP94G, F9SB2G, F9SB2GR, F9SB4G, F9SB4GR, F9SB4GRL, F9V2G, F9V2GR, F9V4G, F9V4GR, F9V4GRL, FR15G, FR15G2, FR2G, FR2G15, FR4G, FR4G15, P9D2G, PD707G, T7011GFG, T707G, T707GFG, T9F4G, T9F6GS, T9SB4G, T9V4G, T9V6GS		

<b>Part No.</b>	107611	<b>Ref. No.</b>	1031501600 1916000 2716500 CM029100 MA1031501600 MA1916000 MA2716500 MACM029100 R63040020
<b>description</b>	thermocouple SIT M9x1 L 850mm plug connection ø6.0(6.5)mm		
<b>For models:</b>	B74G, B78G, B94G, B98G, B9SB2G, B9SB4G, B9V2G, B9V4G, BF78G, BF912G, BF912GH, BF98G, BM74G, BM77G, BMG40, BMG60, BR707G, BR707GI, BR78GF, BR78GI, BR94G, BR94GI, BR9M4G, BR9M4GI, BR9M6G, BR9M6GI, C12FGP9G, C7011G, C7011GFE, C7011GFG, C704G, C707G, C707GFE, C707GFG, C712G, C74G, C74GS, C78G, C78GS, C79G, C7FE12G, C7FE12GS, C7FE8G, C7FE8GS, C7FG12G, C7FG12GS, C7FG8G, C7FG8GS, C7FG9G, C7FGM12G...(Other models you can see in the webshop)		

plug-in thermocouples with interruption

<b>Part No.</b>	107164	<b>Ref. No.</b>	CR0843660
<b>description</b>	thermocouple SIT with interrupter M9x1 L 1000mm plug connection ø6.0(6.5)mm soldering connection		

<b>Part No.</b>	107177	<b>Ref. No.</b>	41826920050 BN41826920050
<b>description</b>	thermocouple SIT with interrupter M9x1 L 600mm plug connection ø6.0mm F 6.3mm		

threaded thermocouples  
threaded thermocouples standard  
with socket with thread M8x1

SIT

<b>Part No.</b>	107633	<b>Ref. No.</b>	1665000 MA1665000
<b>description</b>	thermocouple SIT M8x1 L 1200mm M8x1		
<b>For models:</b>	C7011GFG, C707GFE, C707GFG, CFG101, CFG101D, CFG101L, CFG101P, CFG120, CFG70, CFG70D, CFG70L, CFG70M, CFG70P, EC74GVG, EC78GVG, EC7FG8G, OCFG101, OCFG120, OCFG70, T7011GFG, T707GFG		
<b>accessories for</b>	107633		
	<b>Part No.</b>	102067	<b>Ref. No.</b> 6A012300 939300 BN6A012300 MA939300
nut thread M8x1 H 3mm brass Qty 1 pcs type SEF 1			



<b>Part No.</b>	107628	<b>Ref. No.</b>	1033027100 641400 MA1033027100 MA641400
<b>description</b>	thermocouple SIT M8x1 L 320mm M8x1		
<b>For models:</b>	704S, 706S, C7011G, C7011GFE, C7011GFG, C704G, C707G, C707GFE, C707GFG, C9F4GS, C9F6GS, C9F8GS, C9SB4GS, C9V2GS, C9V4GS, C9V6GS, C9V8GS, TPF706S		
<b>accessories for</b>	107628		
	<b>Part No.</b>	102067	<b>Ref. No.</b> 6A012300 939300 BN6A012300 MA939300
nut thread M8x1 H 3mm brass Qty 1 pcs type SEF 1			

<b>Part No.</b>	107630	<b>Ref. No.</b>	641300 MA1033027200 MA641300
<b>description</b>	thermocouple SIT M8x1 L 600mm M8x1		
<b>For models:</b>	704S, 706S, C7011G, C7011GFE, C7011GFG, C704G, C707G, C707GFE, C707GFG, C9F4GS, C9F6GS, C9F8GS, C9SB4GS, C9V2GS, C9V4GS, C9V6GS, C9V8GS, TPF706S		
<b>accessories for</b>	107630		
	<b>Part No.</b>	102067	<b>Ref. No.</b> 6A012300 939300 BN6A012300 MA939300
nut thread M8x1 H 3mm brass Qty 1 pcs type SEF 1			

### thermopiles

<b>Part No.</b>	102116	<b>Ref. No.</b>	1870712 MA1870712
<b>description</b>	thermopile ROBERTSHAW L 900mm probe ø 9mm probe L 57mm 250-750mV screw connection 7/16"		
<b>For models:</b>	F94G22, F98G22, F9S4G22, F9S8G22, FR92G22, FR94G22, MM10IG, P9I10G, P9IA10G		

### accessories

#### display adapters

<b>Part No.</b>	101337	<b>Ref. No.</b>	MA2969400
<b>description</b>	display adapter thread M9x1		

### displays

<b>Part No.</b>	101414	<b>Ref. No.</b>	2969300
<b>description</b>	display soldering connection		

### nuts

<b>Part No.</b>	102067	<b>Ref. No.</b>	6A012300 939300 BN6A012300 MA939300
<b>description</b>	nut thread M8x1 H 3mm brass Qty 1 pcs type SEF 1		
<b>For models:</b>	702BMG, 704S, 706, 706S, C7011G, C7011GFE, C7011GFG, C704G, C707G, C707GFE, C707GFG, C9F4GS, C9F6G, C9F6GS, C9F8GS, C9SB-4GS, C9V2GS, C9V4GS, C9V6GS, C9V8GS, CFG101, CFG101D, CFG101L, CFG101P, CFG120, CFG70, CFG70D, CFG70L, CFG70M, CFG70P, EC74GVG, EC78GVG, EC7F68G, OCFG101, OCFG120, OCFG70, T7011GFG, T707GFG, T9F6GS, TPF706, TPF706S		

### screws

<b>Part No.</b>	101262	<b>Ref. No.</b>	1162800
<b>description</b>	thermocouple fitting thread M10x1 Qty 1 pcs		
<b>For models:</b>	C9F4G, C9F4GS, C9F6G, C9F6GS, C9F8G, C9F8GS, MM10DG, MM10DGS, MM15DG, P9D10G, P9D15G, P9DA10G, P9DA15G, P9DASB10G, P9DSB10G, PDASB10G, T9F4G, T9F6GS, T9SB4G, T9V4G, T9V6GS		

1

<b>Part No.</b>	101260	<b>Ref. No.</b>	1359100 MA1359100
<b>description</b>	thermocouple fitting thread M8x1 Qty 1 pcs		
<b>For models:</b>	BR96G, BR96GI, BR9M6G, BR9M6GI, C7FG9G, CP707G, CP92G, CP94G, F9SB2G, F9SB2GR, F9SB4G, F9SB4GR, F9SB4GRL, F9V2G, F9V2GR, F9V4G, F9V4GR, F9V4GRL, FT74G, FT74GR, FT77G, FT77GRL, FTG40B, FTG60B, FTG60BLC, FTG60BR, FTG80B, FTG80BR, GB707G, OPLG40, OPLG80, P9D2G, PCG42, PCG82, PD707G, PLG40, PLG80, T7011GFG, T707G, T707GFG		

interrupters



1

<b>Part No.</b>	101265	<b>Ref. No.</b>	1031500500 1531500500 1533400 MA1533400 R63040210
<b>description</b>	interrupter thread M9x1		
<b>For models:</b>	FG105M, FG105X, FG110M, FG110X, FG210M, FG210X, FQG40, FQG60, PG040M, PG040X, PG080M, PG080X		



1

<b>Part No.</b>	105543	<b>Ref. No.</b>	R63016060
<b>description</b>	bar burner 1-row ø 40mm Wmm Hmm L 420mm flange width 43mm flange length 43mm bain marie		



1

<b>Part No.</b>	105831	<b>Ref. No.</b>	R63016050
<b>description</b>	bar burner 2 row L 425mm Wmm ø 40mm Hmm flange width 43mm flange length 43mm combi-steamer MG106, VG106		
<b>For models:</b>	MG106M, MG106P, MG106X, VG106M, VG106P, VG106X		



1

<b>Part No.</b>	105845	<b>Ref. No.</b>	R63015280
<b>description</b>	bar burner 2 row L 550mm W 165mm ø 50mm H 85mm combi-steamer MG21		
<b>For models:</b>	FG110M, FG110X, PG080M, PG080X		



1

<b>Part No.</b>	107774	<b>Ref. No.</b>	R63016090
<b>description</b>	bar burner ø 50mm L 495mm flange width 58mm flange length 58mm		



1

<b>Part No.</b>	104244	<b>Ref. No.</b>	2708500 2708514 MA2708514
<b>description</b>	bar burner ø 50mm Wmm Hmm L 410mm flange width 52mm flange ø 75mm kettle		
<b>For models:</b>	CP92G, CP94G, CP9SB2G, CP9SB4G, FC10G, FC20G, FC5G, FC7G, MM10DG, MM10DGS, MM10IG, MM15DG, P9D10G, P9D15G, P9D2G, P9DA10G, P9DA15G, P9DASB10G, P9DSB10G, P9I10G, P9IA10G, PDASB10G		

gas burners

bar burners

bar burners



1

<b>Part No.</b>	106885	<b>Ref. No.</b>	R63016110
<b>description</b>	bar burner		



1

<b>Part No.</b>	108098	<b>Ref. No.</b>	R63016070 R63016520
<b>description</b>	bar burner 1-row L 440mm ø 50mm flange width 57mm flange length 57mm MG110, VG110		
<b>For models:</b>	GC110M, GM110H, GM110M, GM110M+SC, GM110P, GV110H, GV110M, GV110M+SC, GV110P		





			
1			
<b>Part No.</b>	105730	<b>Ref. No.</b>	2862914 MA2862914
<b>description</b>	bar burner ø 50mm Wmm Hmm L 460mm flange width 52mm flange ø 75mm with bolt M5x12 combi-steamer for convection oven with 10 grids 1/1		
<b>For models:</b>	CON6G, CON6GP, CSM6G, CSM6GP		

			
1			
<b>Part No.</b>	105735	<b>Ref. No.</b>	5163800 MA5163800
<b>description</b>	bar burner ø 50mm Wmm Hmm L 480mm flange width 52mm flange ø 75mm with bolt M5x12 combi-steamer for boiler 10 grids 1/1		
<b>For models:</b>	CSM10G, CSM10GP		

### forced air burners

			
1			
<b>Part No.</b>	104309	<b>Ref. No.</b>	R63140020
<b>description</b>	gasket L 106mm W 100mm H 3mm 4 holes		
<b>For models:</b>	GMT20D, GVT20D, MACG10M, MACG20M, MG101D, MG101M, MG101P, MG101T, MG102D, MG102M, MG102P, MG102T, MG201D, MG201M, MG201P, MG201T, MG202D, MG202M, MG202P, MG202T, MGMT10D, MGMT10P, MGMT20D, MGMT20P, MGMT21D, MGMT21P, MGMT40D, MGMT40P, MGVT10D, MGVT10P, MGVT20D, MGVT20P, MGVT21D, MGVT21P, MGVT40D, MGVT40P		

			
1			
<b>Part No.</b>	104314	<b>Ref. No.</b>	R63140060
<b>description</b>	gasket L 108mm W 103mm H 3mm 6 holes		
<b>For models:</b>	GMT20D, GVT20D, MACG10M, MACG20M		





			
1			
<b>Part No.</b>	108149	<b>Ref. No.</b>	LA63120030 LAR63120020 LAR63120030 LAR63120040
<b>description</b>	venturi for combi-steamer LAINOX		
<b>For models:</b>	GMT06D, GMT20D, GVT06D, GVT20D, MACG05M, MACG07M, MACG20M, MG061D, MG061M, MG061P, MG061T, MG102D, MG102M, MG102P, MG102T, MG201D, MG201M, MG201P, MG201T, MG202D, MG202M, MG202P, MG202T, MGMT06D, MGMT06P, MGMT20D, MGMT20P, MGMT21D, MGMT21P, MGMT40D, MGMT40P, MGVT06D, MGVT06P, MGVT20D, MGVT20P, MGVT21D, MGVT21P, MGVT40D, MGVT40P, MVG051P		

### accessories

#### gaskets

			
1			
<b>Part No.</b>	510254	<b>Ref. No.</b>	R63140000
<b>description</b>	gasket L 77mm W 70mm H 3mm hole ø 7mm hole distance 55x60mm graphite for gas burner		
<b>For models:</b>	GMT06D, GVT06D, MACG05M, MACG07M, MG061D, MG061M, MG061P, MG061T, MGMT06D, MGMT06P, MGVT06D, MGVT06P, MVG051P		

#### nozzle holders

			
1			
<b>Part No.</b>	104108	<b>Ref. No.</b>	1031504900 MA1031504900
<b>description</b>	nozzle holder nozzle mounting M10x1 tube ø 10mm gas inlet M16x1.5 gas outlet M14x1		
<b>accessories for</b>	104108		
		<b>Part No.</b>	102382
		<b>Ref. No.</b>	1033700200 MA1033700200
		nut thread M14x1 H 3.5mm WS 18 brass Qty 1 pcs	
		<b>Part No.</b>	104105
		<b>Ref. No.</b>	—
		burner lower part for burner cap ø 80mm 3.5kW	
		<b>Part No.</b>	104107
		<b>Ref. No.</b>	—
		burner lower part for burner cap ø 100mm 6.4kW	



## gas nozzles

## main nozzles

## gas nozzles M10x1



1

Part No.	100156	Ref. No.	1421700 MA1421700
description	gas injector thread M10x1 bore $\varnothing$ 1.3mm L 30mm WS 12		
For models:	B74G, B78G, B94G, B98G, C7FG9G, CS10, CS6, ET78GVG, ET7FG8G, FT74GL, FT74GLC, FT74GR, FT74GRC, FT76GL, FT76GLC, FT76GM, FT76GMC, FT76GR, FT78GL, FT78GLC, FT78GLT, FT78GM, FT78GMC, FT78GMT, FT94GL, FT94GLC, FT94GR, FT94GRC, FT96GL, FT96GLC, FT96GM, FT96GMC, FT96GR, FT98GL, FT98GLC, FT98GLT, FT98GM, FT98GMC, FT98GMT, FT98GR, FT98GRT, GL12C4G, GL12C9G, GL74G, GL78G, GL94G, GL98G, MM10DG, MM10DGS, MM10IG...(Other models you can see in the webshop)		



1

Part No.	100155	Ref. No.	2902500 MA2902500
description	gas injector thread M10x1 bore $\varnothing$ 1.45mm L 30mm WS 12		
For models:	BF78G, BF912G, BF912GH, BF98G, BMG40, BMG60, C7FG12G, C7FG8G, C7FG9G, C9FG12G, C9FG16G, C9FG8G, C9FG8GP, C9FGM12G, CON10G, CON10GP, CS10, CS6, CSM10G, CSM10GP, EF74G8VA, EF74G8VG, EPC74G, FQG41, FQG61, FT129GLC, FT129GM, FT14G8L90, FT14G8LC90, FT14G8R2L90, FT14G8R2LC90, FT14G8R90, FT14G8RC90, FT74GL, FT74GLC, FT74GR, FT74GRC, FT76GL, FT76GLC, FT76GM, FT76GMC, FT76GR, FT78GL, FT78GLC, FT78GLT, FT78GM, FT78GMC, FT78GMT, FT78G4L90, FT78G4LC90...(Other models you can see in the webshop)		



1

Part No.	100816	Ref. No.	2715300 MA2715300
description	gas injector thread M10x1 bore $\varnothing$ 1.5mm WS 12		
For models:	B74G, B78G, B94G, B98G, BIG40, BIG60, BMG40, BMG60, ET78GVG, ET7FG8G, FC10G, FC5G, FQG41, FQG61, FT12G7L70, FT12G7LC70, FT12G7R70, FT12G7RC70, FT12G7RL70, FT12G7RLC70, FT6G4L70, FT6G4LC70, FT6G4R70, FT6G4RC70, FT74G, FT74GL, FT74GLC, FT74GR, FT74GRC, FT76GL, FT76GLC, FT76GM, FT76GMC, FT76GR, FT77G, FT77GRL, FT78GL, FT78GLC, FT78GLT, FT78GM, FT78GMC, FT78GMT, FT94GL, FT94GLC, FT94GR, FT94GRC, FT96GL, FT96GLC, FT96GM, FT96GMC...(Other models you can see in the webshop)		



1

Part No.	100151	Ref. No.	1631300 MA1631300
description	gas injector thread M10x1 bore $\varnothing$ 1.65mm L 30mm WS 12		
For models:	BR78GF, BR78GI, FT129GLC, FT129GM, FT74GL, FT74GLC, FT74GR, FT74GRC, FT76GL, FT76GLC, FT76GM, FT76GMC, FT76GR, FT78GL, FT78GLC, FT78GLT, FT78GM, FT78GMC, FT78GMT, FT94GL, FT94GLC, FT94GR, FT94GRC, FT96GL, FT96GLC, FT96GM, FT96GMC, FT96GR, FT98GL, FT98GLC, FT98GLT, FT98GM, FT98GMC, FT98GMT, FT98GR, FT98GRT, NBR78GF, NBR78GI, NF94G23, NF98G23, NPC74G, NPC76G, NPC78G, NPC94G, NPC96G, NPC98G, PC12C9G, PC74G, PC76G, PC78G...(Other models you can see in the webshop)		



1

Part No.	106403	Ref. No.	707200 MA707200
description	gas injector thread M10x1 bore $\varnothing$ 1.9mm L 30mm WS 12		
For models:	B74G, B78G, B94G, B98G, BR78GF, BR78GI, CON202G, CON202GP, CP704G, CP707G, CSM202G, CSM202GP, FT12C9GL, FT12C9GM, FT12C9GLC, FT12C9GTMC, FT74GL, FT74GLC, FT74GR, FT74GRC, FT76GL, FT76GLC, FT76GM, FT76GMC, FT76GR, FT78GL, FT78GLC, FT78GLT, FT78GM, FT78GMC, FT78GMT, FT78GR, FT78GRT, FT94G, FT94GL, FT94GLC, FT94GR, FT94GRC, FT96GL, FT96GLC, FT96GM, FT96GMC, FT96GR, FT98GL, FT98GLC, FT98GLT, FT98GM, FT98GMC, FT98GMT, FT98GR...(Other models you can see in the webshop)		



1

Part No.	106408	Ref. No.	1695300 MA1695300
description	gas injector thread M10x1 bore $\varnothing$ 3mm L 30mm WS 12		
For models:	BR707G, BR78GF, BR78GI, CP92G, CP94G, FT74G, FT74GR, FT77G, FT-77GRL, NBR78GF, NBR78GI, P9D2G, PD98G10, PD98G15, PD98G15A, PD9S8G10		



1

Part No.	100477	Ref. No.	522611 MA522611
description	gas injector thread M10x1 WS 12 bore $\varnothing$ 1.65mm		



1

Part No.	100447	Ref. No.	523911
description	gas injector thread M10x1 WS 12 bore $\varnothing$ 2.3mm		



1

Part No.	100490	Ref. No.	524711 MA524711
description	gas injector thread M10x1 WS 12 bore $\varnothing$ 2.7mm		





pilot burner nozzles

pilot burner nozzles SIT

100 series



<b>Part No.</b>	100245	<b>Ref. No.</b>	1415100 24022299 3020054 MA1415100
<b>description</b>	pilot burner nozzle LPG code 20 bore $\varnothing$ 0.2mm Qty 1 pcs thread M8x0.75		
<b>For models:</b>	B9SB2G, B9SB4G, B9V2G, B9V4G, C7011G, C7011GFE, C7011GFG, C704G, C707G, C707GFE, C707GFG, C9F4G, C9F4GS, C9F6G, C9F6GS, C9F8G, C9F8GS, C9SB4GS, C9V2G, C9V2GS, C9V4G, C9V4GS, C9V6G, C9V6GS, C9V8G, C9V8GS, EF74G15, F12C4G15, F74G10, F74G15, F76G10, F78G15, F94G10, F94G15, F94G22, F94G22K, F96G10, F98G15, F98G22, F98G22K, F9S4G15, F9S4G22, F9S4G22K, F9S8G15, F9S8G22, F9S8G22K, F9SB2G, F9SB2GR, F9SB4G, F9SB4GR...(Other models you can see in the webshop)		



<b>Part No.</b>	100246	<b>Ref. No.</b>	1422600 MA1422600
<b>description</b>	pilot burner nozzle natural gas bore $\varnothing$ 0.35mm Qty 1 pcs thread M8x0.75		
<b>For models:</b>	B9SB2G, B9SB4G, B9V2G, B9V4G, C7011G, C7011GFE, C7011GFG, C704G, C707G, C707GFE, C707GFG, C9F4G, C9F4GS, C9F6G, C9F6GS, C9F8G, C9F8GS, C9SB4GS, C9V2G, C9V2GS, C9V4G, C9V4GS, C9V6G, C9V6GS, C9V8G, C9V8GS, F9SB2G, F9SB2GR, F9SB4G, F9SB4GR, F9SB4GRL, F9V2G, F9V2GR, F9V4G, F9V4GR, F9V4GRL, P9D10G, P9D15G, P9DA10G, P9DA15G, P9I10G, P9IA10G, T7011GFG, T707G, T707GFG, T9F4G, T9F6GS, T9SB4G, T9V4G, T9V6GS		



<b>Part No.</b>	102972	<b>Ref. No.</b>	1996200 CRO684580 MA1996200
<b>description</b>	pilot burner nozzle natural gas code 40 bore $\varnothing$ 0.4mm Qty 1 pcs		
<b>For models:</b>	EF74G15, F12C4G15, F74G10, F74G15, F76G10, F78G15, F94G10, F94G15, F94G22, F94G22K, F96G10, F98G15, F98G22, F98G22K, F9S4G15, F9S4G22, F9S4G22K, F9S8G15, F9S8G22, F9S8G22K, NF-74G15T, NF78G15T, NG74G, NG78G, NG94G, NG98G		



<b>Part No.</b>	107171	<b>Ref. No.</b>	1031502100 1842300 MA1031502100 MA1842300
<b>description</b>	pilot burner nozzle SIT natural/liquid gas bore $\varnothing$ 0.25mm Qty 1 pcs		
<b>For models:</b>	EF74G15, F12C4G15, F74G10, F74G15, F76G10, F78G15, F94G10, F94G15, F94G22, F94G22K, F96G10, F98G15, F98G22, F98G22K, F9S4G15, F9S4G22, F9S4G22K, F9S8G15, F9S8G22, F9S8G22K, FR74G, FR77G, FR92G13, FR92G22, FR92G22T, FR94G13, FR94G22, FR94G22T, NF74G15T, NF78G15T, NG74G, NG78G, NG94G, NG98G		

140/150 series



<b>Part No.</b>	100204	<b>Ref. No.</b>	1888000 MA1888000
<b>description</b>	pilot burner nozzle SIT LPG code 14 bore $\varnothing$ 0.18/0.20mm Qty 1 pcs suitable for 140 series		
<b>For models:</b>	B9SB2G, B9SB4G, B9V2G, B9V4G, B9VP4G, BM74G, BM77G, BR707G, BR707GI, BR78GF, BR78GI, BR912GFM, BR912GIM, BR94G, BR94GI, BR98GF, BR98GFM, BR98GI, BR98GIM, BR9M4G, BR9M4GI, BR9M6G, BR9M6GI, BR9S8GF, BR9S8GI, BR9SB4G, BR9SB4GI, C124G, C129G, C12C2G9, C12C9G, C12FG9G, C7011G, C7011GFE, C7011GFG, C704G, C707G, C707GFE, C707GFG, C712G, C74G, C78G, C7FE12G, C7FE8G, C7FG12G, C7FG8G, C7FG9G, C7FGM12G, C912G, C912GS...(Other models you can see in the webshop)		



<b>Part No.</b>	100205	<b>Ref. No.</b>	1033722000 BN822140380 MA1033722000
<b>description</b>	pilot burner nozzle SIT LPG code 19 bore $\varnothing$ 0.23/0.26mm Qty 1 pcs suitable for SIT 150 series		
<b>For models:</b>	EFT74GLVG, EFT74GRVG, EFT78GLVG, EFT78GMVG		



<b>Part No.</b>	100207	<b>Ref. No.</b>	1887800 MA1887800
<b>description</b>	pilot burner nozzle SIT natural gas code 27 bore $\varnothing$ 0.40/0.38mm suitable for SIT 140 series		
<b>For models:</b>	B74G, B78G, B94G, B98G, B9SB2G, B9SB4G, B9V2G, B9V4G, B9VP4G, BM74G, BM77G, BR707G, BR707GI, BR78GF, BR78GI, BR912GFM, BR912GIM, BR94G, BR94GI, BR98GF, BR98GFM, BR98GI, BR98GIM, BR9M4G, BR9M4GI, BR9M6G, BR9M6GI, BR9S8GF, BR9S8GI, BR9SB4G, BR9SB4GI, C124G, C129G, C12C2G9, C12C9G, C12FG9G, C7011G, C7011GFE, C7011GFG, C704G, C707G, C707GFE, C707GFG, C712G, C74G, C78G, C7FE12G, C7FE8G, C7FG12G, C7FG8G...(Other models you can see in the webshop)		

160 series



<b>Part No.</b>	107649	<b>Ref. No.</b>	1033719600 MA1033719600
<b>description</b>	pilot burner nozzle SIT LPG code 20 Qty 1 pcs		
<b>For models:</b>	BF78G, BF912G, BF912GH, BF98G, C74GS, C78GS, C79G, C7FE12GS, C7FE8GS, C7FG12G, C7FG12GS, C7FG8G, C7FG8GS, C7FG9G, C7FGM12G, C9FG12G, C9FG16G, C9FG8G, C9FG8GP, C9FGM12G, CFG101, CFG70, CFG70M, CFGE61, CFGE61D, CFGE61P, CFGE61P, EC74GVG, EC78GVG, EC7FG8G, EF74G8VA, EF74G8VG, FQG41, FQG61, FT12C9GL, FT12C9GM, FT12C9GTLC, FT12C9GTMC, FT74GL, FT74GR, FT76GL, FT76GLC, FT76GM, FT76GMC, FT78GL, FT78GLC, FT78GLT, FT78GM, FT78GMC, FT78GMT...(Other models you can see in the webshop)		



			
1			
<b>Part No.</b>	107172	<b>Ref. No.</b>	1874700 MA1874700
<b>description</b>	pilot burner nozzle SIT LPG code 25 Qty 1 pcs		
<b>For models:</b>	BF78G, BF912G, BF912GH, BF98G, C12FGP9G, C7FG12G, C7FG8G, C7FG9G, C7FGM12G, C9FG12G, C9FG16G, C9FG8G, C9FG8GP, C9FGM12G, EF74G8VA, EF74G8VG, EPC74G, FQG41, FQG61, MM10IG, NC7FG12G44, NC7FG8G32, NC7FG8G36, NC7FG8G48, NC7FGM12G, NC9FG12G52, NC9FG16G72, NC9FG8G32, NC9FG8G36, NC9FG8G48, NF74G10, NF74G15, NF74G8, NF76G10, NF76G8, NF78G15, NF94G15, NF94G23, NF94G23K, NF96G10, NF98G15, NF98G23, NF98G23K, NPC74G, NPC78G, NPC94G, NPC98G, NPD76G5, NPD78G8, NPD96G5...(Other models you can see in the webshop)		

			
1			
<b>Part No.</b>	107650	<b>Ref. No.</b>	0100802 CR0410100 R0100802 SIR0100802
<b>description</b>	pilot burner nozzle SIT LPG code 30 Qty 1 pcs		
<b>For models:</b>	C12FGP9G, EF74G8VA, EF74G8VG, EPC74G, NC712G36, NC74G12, NC78G24, NC7FE12G36, NC7FE8G24, NC7FG12G44, NC7FG8G32, NC7FGM12G, NC912G44, NC94G16, NC94G20, NC98G28, NC98G40, NC9FE12G44, NC9FE8G28, NC9FG12G52, NC9FG16G72, NC9FG8G32, NC9FG8G36, NC9FG8G48, NC9FGM12G, NF74G10, NF74G15, NF74G8, NF76G10, NF76G8, NF78G15, NF94G15, NF94G23, NF94G23K, NF96G10, NF98G15, NF98G23, NF98G23K, NPC74G, NPC78G, NPC94G, NPC98G, NPD98G10, NPD98G15, NPD98G15A, NPI98G10, NPI98G14, NPI98G14A, NS78GS, NS7FG12GS...(Other models you can see in the webshop)		

			
1			
<b>Part No.</b>	107174	<b>Ref. No.</b>	1033719700 MA1033719700
<b>description</b>	pilot burner nozzle SIT natural gas code 41 Qty 1 pcs		
<b>For models:</b>	BF78G, BF912G, BF912GH, BF98G, C12FGP9G, C74GS, C78GS, C79G, C7FE12GS, C7FE8GS, C7FG12G, C7FG12GS, C7FG8G, C7FG8GS, C7FG9G, C7FGM12G, C9FG12G, C9FG16G, C9FG8G, C9FG8GP, C9FGM12G, CFG101, CFG70, CFG70M, CFGE61, CFGE61D, CFGE61L, CFGE61P, EC74GVG, EC78GVG, EC7FG8G, EF74G8VA, EF74G8VG, EPC74G, FQG41, FQG61, NC7FG12G44, NC7FG8G32, NC7FG8G36, NC7FG8G48, NC7FGM12G, NC9FG12G52, NC9FG16G72, NC9FG8G32, NC9FG8G36, NC9FG8G48, NF74G10, NF74G15, NF74G8, NF76G10...(Other models you can see in the webshop)		

			
1			
<b>Part No.</b>	107175	<b>Ref. No.</b>	1874400 MA1874400
<b>description</b>	pilot burner nozzle SIT natural gas code 51 Qty 1 pcs suitable for 160 series		
<b>For models:</b>	MM10IG, P9110G, P91A10G		



screw connections



olives



			
1			
<b>Part No.</b>	101278	<b>Ref. No.</b>	867-20 MA86720
<b>description</b>	olive for pipe ø 10mm Qty 1 pcs		
<b>For models:</b>	704S, 706S, B74G, B78G, B94G, B98G, B9SB2G, B9SB4G, B9V2G, B9V4G, BF78G, BF912G, BF912GH, BF98G, BIG40, BIG60, BMG40, BMG60, BR707G, BR707GI, BR78GF, BR78GI, BRG40, BRG40G, C124G, C129G, C12C2G9, C12C9G, C12FG9G, C12FGP9G, C7011G, C7011GFE, C7011GFG, C704G, C707G, C707GFE, C707GFG, C712G, C74G, C74GS, C78G, C78GS, C79G, C7FE12G, C7FE12GS, C7FE8G, C7FE8GS, C7FG12G, C7FG12GS, C7FG8G...(Other models you can see in the webshop)		
<b>accessories for</b>	101278		
	<b>Part No.</b>	100943	<b>Ref. No.</b> —
union nut thread M17x1 tube ø 10mm			
	<b>Part No.</b>	101300	<b>Ref. No.</b> 1326500 MA1326500
union nut thread M16x1.5 tube ø 10mm			
	<b>Part No.</b>	101478	<b>Ref. No.</b> 1665200 MA1665200
union nut thread 3/8" for pipe ø 10mm			



			
1			
<b>Part No.</b>	101273	<b>Ref. No.</b>	0100842 417810 673300 MA417810 MA673300 R0100842 SIR0100842
<b>description</b>	olive for pipe ø 12mm L 9.5mm brass Qty 1 pcs suitable for universal		
<b>For models:</b>	704, 704S, 706, 706AS, 706S, B9SB2G, B9SB4G, B9V2G, B9V4G, B9VP4G, BF78G, BF912G, BF912GH, BF98G, BM74G, BM77G, BR707G, BR707GI, BR78GF, BR78GI, BRG40, BRG40G, C12FGP9G, C7FG12G, C7FG8G, C7FGM12G, C9F4G, C9F4GS, C9F6G, C9F6GS, C9F8G, C9F-8GS, C9FG12G, C9FG16G, C9FG8G, C9FG8GP, C9FGM12G, C9FP4GS, C9FP6GS, C9FP8GS, C9SB4GS, C9V2G, C9V2GS, C9V4G, C9V4GS, C9V6G, C9V6GS, C9V8G, C9V8GS, CP92G...(Other models you can see in the webshop)		
<b>accessories for</b>	101273		
	<b>Part No.</b>	100944	<b>Ref. No.</b> —
union nut thread M18x1.5 for pipe ø 12mm			
	<b>Part No.</b>	101276	<b>Ref. No.</b> 459300 MA459300
union screw thread 3/8" tube ø 12mm Qty 1 pcs			







 <p>1</p>							
<b>Part No.</b>	101256	<b>Ref. No.</b>	1127400 MA1127400				
<b>description</b>	olive for pipe Ø 16mm Qty 1 pcs						
<b>For models:</b>	BR707G, BR912GFM, BR912GIM, BR94G, BR94GI, BR98GF, BR98GFM, BR98GI, BR98GIM, BR9M4G, BR9M4GI, BR9M6G, BR9M6GI, BR9S8GF, BR9S8GI, BR9SB4G, BR9SB4GI, C9FEP4GS, C9FEP6GS, C9FEP8GS, C9FP4GS, C9FP6GS, C9FP8GS, C9VP4GS, C9VP6GS, C9VP8GS, CON10G, CON10GP, CON201G, CON201GP, CON202G, CON202GP, CON6G, CON6GP, CP707G, CP92E, CP92G, CP94E, CP94G, CS10, CS102G, CS102GP, CS6, CSM10G, CSM10GP, CSM201G, CSM201GP, CSM202G, CSM202GP, CSM6G...(Other models you can see in the webshop)						
<b>accessories for</b>	101256						
 <table border="1"> <tr> <td><b>Part No.</b></td> <td>101253</td> <td><b>Ref. No.</b></td> <td>1421000 MA1421000</td> </tr> </table> <p>union nut thread M24x1.5 PEL for pipe Ø 16mm</p>				<b>Part No.</b>	101253	<b>Ref. No.</b>	1421000 MA1421000
<b>Part No.</b>	101253	<b>Ref. No.</b>	1421000 MA1421000				

 <p>1</p>							
<b>Part No.</b>	101257	<b>Ref. No.</b>	1347000 MA1347000				
<b>description</b>	olive for pipe Ø 20mm Qty 1 pcs						
<b>For models:</b>	MM10DG, MM10DGS, MM15DG, P9D10G, P9D15G, P9DA10G, P9DA15G, P9DASB10G, P9DSB10G, PD98G10, PD98G15, PD98G15A, PD9S8G10, PDASB10G, PI98G10, PI98G14, PI98G14A, T9F4G, T9F6GS, T9SB4G, T9V4G, T9V6GS						
<b>accessories for</b>	101257						
 <table border="1"> <tr> <td><b>Part No.</b></td> <td>101254</td> <td><b>Ref. No.</b></td> <td>1346900 MA1346900</td> </tr> </table> <p>union nut thread M28x1.5 tube Ø 20mm</p>				<b>Part No.</b>	101254	<b>Ref. No.</b>	1346900 MA1346900
<b>Part No.</b>	101254	<b>Ref. No.</b>	1346900 MA1346900				

 <p>1</p>							
<b>Part No.</b>	101282	<b>Ref. No.</b>	469000 MA469000				
<b>description</b>	olive for pipe Ø 4mm L 7.4mm Qty 1 pcs						
<b>For models:</b>	704S, 706S, BIG40, BIG60, BMG40, BMG60, BRG40, BRG40G, CP707G, CP92G, CP94G, FQG40, FQG60, FT74G, FT74GR, FT77G, FT77GRL, FTG40B, FTG40BLC, FTG40BR, FTG60B, FTG60BLC, FTG60BR, FTG-60BRR, FTG80B, FTG80BLC, FTG80BR, GB707G, P9D2G, PD707G, PI707G, TPF706S						
<b>accessories for</b>	101282						
 <table border="1"> <tr> <td><b>Part No.</b></td> <td>100908</td> <td><b>Ref. No.</b></td> <td>0100777 673500 MA673500 R0100777 SIR0100777</td> </tr> </table> <p>union screw thread M10x1 for pipe Ø 4mm Qty 1 pcs</p>				<b>Part No.</b>	100908	<b>Ref. No.</b>	0100777 673500 MA673500 R0100777 SIR0100777
<b>Part No.</b>	100908	<b>Ref. No.</b>	0100777 673500 MA673500 R0100777 SIR0100777				
 <table border="1"> <tr> <td><b>Part No.</b></td> <td>101283</td> <td><b>Ref. No.</b></td> <td>468800 MA468800</td> </tr> </table> <p>union screw thread M10x1 for pipe Ø 4mm Qty 1 pcs</p>				<b>Part No.</b>	101283	<b>Ref. No.</b>	468800 MA468800
<b>Part No.</b>	101283	<b>Ref. No.</b>	468800 MA468800				

 <p>1</p>							
<b>Part No.</b>	101246	<b>Ref. No.</b>	673600 MA673600				
<b>description</b>	olive for pipe Ø 4mm Qty 1 pcs						
<b>For models:</b>	704S, 706S, B74G, B78G, B94G, B98G, B9SB2G, B9SB4G, B9V2G, B9V4G, BF78G, BF912G, BF912GH, BF98G, BIG40, BIG60, BR78GF, BR78GI, BR912GFM, BR912GIM, BR94G, BR94GI, BR98GF, BR98GFM, BR98GI, BR98GIM, BR9M4G, BR9M4GI, BR9M6G, BR9M6GI, BR9S8GF, BR9S8GI, BR9SB4G, BR9SB4GI, BRG40, BRG40G, C124G, C129G, C12C2G9, C12C9G, C12FG9G, C12FGP9G, C7011G, C7011GFE, C7011GFG, C704G, C707G, C707GFE, C707GFG, C712G...(Other models you can see in the webshop)						
<b>accessories for</b>	101246						
 <table border="1"> <tr> <td><b>Part No.</b></td> <td>100908</td> <td><b>Ref. No.</b></td> <td>0100777 673500 MA673500 R0100777 SIR0100777</td> </tr> </table> <p>union screw thread M10x1 for pipe Ø 4mm Qty 1 pcs</p>				<b>Part No.</b>	100908	<b>Ref. No.</b>	0100777 673500 MA673500 R0100777 SIR0100777
<b>Part No.</b>	100908	<b>Ref. No.</b>	0100777 673500 MA673500 R0100777 SIR0100777				

 <p>1</p>			
<b>Part No.</b>	100897	<b>Ref. No.</b>	1881000 1888100 MA1888100
<b>description</b>	olive for pipe Ø 4mm Qty 1 pcs for pilot burner		
<b>For models:</b>	B9SB2G, B9SB4G, B9V2G, B9V4G, B9VP4G, BM74G, BM77G, BR707G, BR707GI, BR78GF, BR78GI, BR94G, BR94GI, BR9M4G, BR9M4GI, BR9M6G, BR9M6GI, BR9SB4G, BR9SB4GI, C124G, C129G, C12C2G9, C12C9G, C12FG9G, C7011G, C7011GFE, C7011GFG, C704G, C707G, C707GFE, C707GFG, C712G, C74G, C74GS, C78G, C78GS, C79G, C7FE12G, C7FE12GS, C7FE8G, C7FE8GS, C7FG12G, C7FG12GS, C7FG8G, C7FG8GS, C7FG9G, C7FGM12G, C912G, C912GS, C94G...(Other models you can see in the webshop)		

 <p>1</p>							
<b>Part No.</b>	101286	<b>Ref. No.</b>	961500 LA62070023 LAR62070023				
<b>description</b>	olive ID Ø 6mm Qty 1 pcs						
<b>accessories for</b>	101286						
 <table border="1"> <tr> <td><b>Part No.</b></td> <td>100909</td> <td><b>Ref. No.</b></td> <td>LA62060223 LAR62060223</td> </tr> </table> <p>union screw thread M10x1 for pipe Ø 6mm Qty 1 pcs</p>				<b>Part No.</b>	100909	<b>Ref. No.</b>	LA62060223 LAR62060223
<b>Part No.</b>	100909	<b>Ref. No.</b>	LA62060223 LAR62060223				
 <table border="1"> <tr> <td><b>Part No.</b></td> <td>101464</td> <td><b>Ref. No.</b></td> <td>—</td> </tr> </table> <p>union nut thread M12x1 for pipe Ø 6mm</p>				<b>Part No.</b>	101464	<b>Ref. No.</b>	—
<b>Part No.</b>	101464	<b>Ref. No.</b>	—				



## union nuts

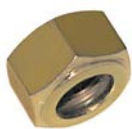

1

Part No.	101253	Ref. No.	1421000 MA1421000	
<b>description</b>	union nut thread M24x1.5 PEL for pipe ø 16mm			
<b>For models:</b>	BR912GFM, BR912GIM, BR94G, BR94GI, BR98GF, BR98GFM, BR98GI, BR98GIM, BR9M4G, BR9M4GI, BR9M6G, BR9M6GI, BR9S8GF, BR9S8GI, BR9SB4G, BR9SB4GI, C9FEP4GS, C9FEP6GS, C9FEP8GS, C9FP4GS, C9FP6GS, C9FP8GS, C9VP4GS, C9VP6GS, C9VP8GS, CON10G, CON10GP, CON201G, CON201GP, CON202G, CON202GP, CON6G, CON6GP, CP707G, CP92E, CP92G, CP94E, CP94G, CS10, CS102G, CS102GP, CS6, CSM10G, CSM10GP, CSM201G, CSM201GP, CSM202G, CSM202GP, CSM6G, CSM6GP...(Other models you can see in the webshop)			
<b>accessories for</b>	101253			
	Part No.	101256	Ref. No.	1127400 MA1127400
	olive for pipe ø 16mm Qty 1 pcs			

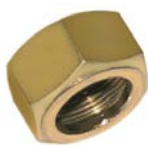

1

Part No.	101254	Ref. No.	1346900 MA1346900	
<b>description</b>	union nut thread M28x1.5 tube ø 20mm			
<b>For models:</b>	MM10DG, MM10DGS, MM15DG, P9D10G, P9D15G, P9DA10G, P9DA15G, P9DASB10G, P9DSB10G, PD98G10, PD98G15, PD98G15A, PD9S8G10, PDASB10G, PI98G10, PI98G14, PI98G14A, T9F4G, T9F6GS, T9SB4G, T9V4G, T9V6GS			
<b>accessories for</b>	101254			
	Part No.	101257	Ref. No.	1347000 MA1347000
	olive for pipe ø 20mm Qty 1 pcs			

## union screws



1

Part No.	100904	Ref. No.	1388000 1394700 MA1394700
<b>description</b>	locking screw M10x1 for pipe ø 4mm Qty 1 pcs		
<b>For models:</b>	B9SB2G, B9SB4G, B9V2G, B9V4G, B9VP4G, BF78G, BF912G, BF912GH, BF98G, BM74G, BM77G, BMG40, BMG60, BR707G, BR707GI, BR78GF, BR78GI, C12FGP9G, C7FG12G, C7FG8G, C7FGM12G, C9F4G, C9F4GS, C9F6G, C9F6GS, C9F8G, C9F8GS, C9FG12G, C9FG16G, C9FG8G, C9FG8GP, C9FGM12G, C9FP4GS, C9FP6GS, C9FP8GS, EF74G15, EF74G8VA, EF74G8VG, F12C4G15, F74G10, F74G15, F74G6, F76G10, F78G15, F94G10, F94G15, F94G22, F94G22K, F94G6, F96G10...(Other models you can see in the webshop)		



1

Part No.	100905	Ref. No.	1394800 MA1394800
<b>description</b>	locking screw M10x1 for pipe ø 6mm Qty 1 pcs		
<b>For models:</b>	BR707G, CS10, CS102G, CS102GP, CS6, CSM201E, CSM201EP, CSM201G, CSM201GP, CSM202E, CSM202EP, CSM202G, CSM202GP, FR74G, FR77G		



1





Part No.	100906	Ref. No.	1888400 MA1888400
<b>description</b>	screw connection thread M10x1 for ignition electrode brass Qty 1 pcs WS 10		
<b>For models:</b>	B74G, B78G, B94G, B98G, B9SB2G, B9SB4G, B9V2G, B9V4G, B9VP4G, BF78G, BF912G, BF912GH, BF98G, BM74G, BM77G, BR707G, BR707GI, BR78GF, BR78GI, BR912GFM, BR912GIM, BR94G, BR94GI, BR98GF, BR98GFM, BR98GI, BR98GIM, BR9M4G, BR9M4GI, BR9M6G, BR9M6GI, BR9S8GF, BR9S8GI, BR9SB4G, BR9SB4GI, C124G, C129G, C12C2G9, C12C9G, C12FG9G, C12FGP9G, C7011G, C7011GFE, C7011GFG, C704G, C707G, C707GFE, C707GFG, C712G, C74G...(Other models you can see in the webshop)		







1

Part No.	100907	Ref. No.	1891700 24010899 MA1891700 MA24010899
<b>description</b>	screw connection thread M10x1 Qty 1 pcs type SEF 1 ømm for thermocouple		
<b>For models:</b>	B9SB2G, B9SB4G, B9V2G, B9V4G, B9VP4G, BF78G, BF912G, BF912GH, BF98G, BIG40, BIG60, BM74G, BM77G, BR707G, BR707GI, BR912GFM, BR912GIM, BR94G, BR94GI, BR96G, BR96GI, BR98GF, BR98GFM, BR98GI, BR98GIM, BR9M4G, BR9M4GI, BR9M6G, BR9M6GI, BR9SB4G, BR9SB4GI, C124G, C129G, C12C2G9, C12C9G, C12FG9G, C12FGP9G, C7011G, C7011GFE, C7011GFG, C704G, C707G, C707GFE, C707GFG, C712G, C74G, C78G, C7FE12G, C7FE8G, C7FG12G...(Other models you can see in the webshop)		



			
1			
<b>Part No.</b>	100908	<b>Ref. No.</b>	0100777 673500 MA673500 R0100777 SIR0100777
<b>description</b>	union screw thread M10x1 for pipe ø 4mm Qty 1 pcs		
<b>For models:</b>	704S, 706S, B74G, B78G, B94G, B98G, B9SB2G, B9SB4G, B9V2G, B9V4G, B9VP4G, BF78G, BF912G, BF912GH, BF98G, BIG40, BIG60, BM74G, BM77G, BR707G, BR707GI, BR912GFM, BR912GIM, BR94G, BR94GI, BR98GF, BR98GFM, BR98GI, BR98GIM, BR9M4G, BR9M4GI, BR9M6G, BR9M6GI, BR9S8GF, BR9S8GI, BR9SB4G, BR9SB4GI, BRG40, BRG40G, C124G, C129G, C12C2G9, C12C9G, C12FG9G, C12FGP9G, C7011G, C7011GFE, C7011GFG, C704G, C707G...(Other models you can see in the webshop)		
<b>accessories for</b>	100908		
	<b>Part No.</b>	100897	<b>Ref. No.</b> 1881000 1888100 MA1888100
olive for pipe ø 4mm Qty 1 pcs for pilot burner			
	<b>Part No.</b>	101246	<b>Ref. No.</b> 673600 MA673600
olive for pipe ø 4mm Qty 1 pcs			
	<b>Part No.</b>	101280	<b>Ref. No.</b> —
olive for pipe ø 4mm Qty 1 pcs			
	<b>Part No.</b>	101282	<b>Ref. No.</b> 469000 MA469000
olive for pipe ø 4mm L 7.4mm Qty 1 pcs			

			
1			
<b>Part No.</b>	100909	<b>Ref. No.</b>	LA62060223 LAR62060223
<b>description</b>	union screw thread M10x1 for pipe ø 6mm Qty 1 pcs		
<b>accessories for</b>	100909		
	<b>Part No.</b>	100898	<b>Ref. No.</b> —
olive for pipe ø 6mm Qty 1 pcs for pilot burner			
	<b>Part No.</b>	101286	<b>Ref. No.</b> 961500 LA62070023 LAR62070023
olive ID ø 6mm Qty 1 pcs			
	<b>Part No.</b>	101287	<b>Ref. No.</b> —
olive for pipe ø 6mm Qty 1 pcs			
	<b>Part No.</b>	101288	<b>Ref. No.</b> —
olive for pipe ø 6mm L 6mm aluminium Qty 1 pcs ED ø 8.5mm			

## gas ball valves

with DIN-DVGW approval

			
1			
<b>Part No.</b>	520326	<b>Ref. No.</b>	1031103600 1546500
<b>description</b>	ball valve straight t-handle inlet 3/4" IT outlet 3/4" IT DN20 L 80mm approval DVGW gas technology operating p. 1bar		

## gas lines

pilot tubes

universal

			
1			
<b>Part No.</b>	102111	<b>Ref. No.</b>	1690200
<b>description</b>	pilot tube copper pipe ø 6mm thickness 1mm L 3000mm		
<b>For models:</b>	BR707G		

## pressure switches

			
1			
<b>Part No.</b>	541051	<b>Ref. No.</b>	5151000 MA5151000
<b>description</b>	pressure control ø 45mm pressure range adjustable 10-50mbar pressure connection vertical gas technology connection 1/4" pressure connection ø 1/4"mm		
<b>For models:</b>	CON102G, CON102GP, CON10G, CON10GP, CON201G, CON201GP, CON202G, CON202GP, CON6G, CON6GP, CP9A15GD, CSM102G, CSM102GP, CSM10G, CSM10GP, CSM201G, CSM201GP, CSM202G, CSM202GP, CSM6G, CSM6GP		

2 gas components





1

<b>Part No.</b>	541073	<b>Ref. No.</b>	LA63070010 LAR63070010
<b>description</b>	pressure control $\varnothing$ 45mm pressure range adjustable 5-20mbar pressure connection vertical gas technology connection 1/4" pressure connection $\varnothing$ 1/4"mm		
<b>For models:</b>	CVG105H, CVG105M, GC106M, GC110M, GC210M, GM106H, GM106M, GM106M+SC, GM106P, GM110H, GM110M, GM110M+SC, GM110P, GM210H, GM210M, GM210M+SC, GM210P, GMT06D, GMT20D, GV106H, GV106M, GV106M+SC, GV106P, GV110H, GV110M, GV110M+SC, GV110P, GV210H, GV210M, GV210M+SC, GV210P, GVT06D, GVT20D, MACG05M, MACG07M, MACG10M, MACG20M, MG061D, MG061M, MG061P, MG061T, MG101D, MG101M, MG101P, MG101T, MG102D, MG102M, MG102P, MG102T, MG106M...(Other models you can see in the webshop)		

## equipmentspecific units

for convection ovens/combi-steamers

### drain units

#### drip rails



1

<b>Part No.</b>	691961	<b>Ref. No.</b>	LA69180010 LAR69180010 R69180000
<b>description</b>	drain unit L 90mm edition since 2009		
<b>For models:</b>	GMT20D, GVT06D, GVT20D		



1

<b>Part No.</b>	698946	<b>Ref. No.</b>	LAR69180220
<b>description</b>	drip rail L 557mm plastic W 33.5mm		



1

<b>Part No.</b>	698947	<b>Ref. No.</b>	LAR69180230
<b>description</b>	drip rail L 797mm plastic W 33.5mm		



1

<b>Part No.</b>	694606	<b>Ref. No.</b>	R11200520
<b>description</b>	drip rail L 90mm edition from 2000 until 2009		
<b>For models:</b>	ME061M, ME061P, ME061T, ME101M, ME101P, ME101T, ME102M, ME102P, ME102T, MG061M, MG061P, MG061T, MG101M, MG101P, MG101T, MG102M, MG102P, MG102T		

### drain valves



1

<b>Part No.</b>	694977	<b>Ref. No.</b>	LA62280038
<b>description</b>	drain pipe angled 90° polypropylene DN50 for combi-steamer		

### bushes



1

<b>Part No.</b>	699451	<b>Ref. No.</b>	R70080010
<b>description</b>	bush for steam generator ID $\varnothing$ 60mm ED $\varnothing$ 76mm L 70mm ceramic suitable for combi-steamer		
<b>For models:</b>	GMT20D, MG101D, MG101M, MG101P, MG101T, MG102D, MG102M, MG102P, MG102T, MG201D, MG201M, MG201P, MG201T, MG202D, MG202M, MG202P, MG202T, MGMT10D, MGMT10P, MGMT20D, MGMT20P, MGMT21D, MGMT21P, MGMT40D, MGMT40P		



injection nozzles



<b>Part No.</b>	691278	<b>Ref. No.</b>	R58006130 R58006140
<b>description</b>	injection nozzle bore ø 1mm for combi-steamer		
<b>For models:</b>	GMT06D, GMT20D, GVT06D, GVT20D, ME061P, ME061T, ME101D, ME101M, ME101P, ME101T, ME102D, ME102M, ME102P, ME102T, ME201D, ME201M, ME201P, ME201T, ME202D, ME202M, ME202P, ME202T, MEMT06D, MEMT06P, MEMT10D, MEMT10P, MEMT20D, MEMT20P, MEMT21D, MEMT21P, MEMT40D, MEMT40P, MEVT06D, MEVT06P, MEVT10D, MEVT10P, MEVT20D, MEVT20P, MEVT21D, MEVT21P, MEVT40D, MEVT40P, MG061D, MG061M, MG061P, MG061T, MG101D, MG101M, MG101P, MG101T...(Other models you can see in the webshop)		



<b>Part No.</b>	692326	<b>Ref. No.</b>	R58006080
<b>description</b>	injection nozzle bore ø 2mm L 33mm WS 14 brass for combi-steamer T1: M10x1 T2: M10x1		
<b>For models:</b>	EM210H, EM210M, EM210M+SC, EM210P, EV210H, EV210M, EV210M+SC, EV210P, GM210H, GM210M, GM210M+SC, GM210P, GV210H, GV210M, GV210M+SC, GV210P, ME120M, ME120P, ME120X, ME210M, ME210P, ME210X, ME220M, ME220P, ME220X, MEC24H, MEC40M, MG120M, MG120P, MG120X, MG210M, MG210P, MG210X, MG220M, MG220P, MG220X, MGC20X, MGC24H, MGC40H, VE120M, VE120P, VE120X, VE210M, VE210P, VE210X, VE220M, VE220P, VE220X, VG120M, VG120P...(Other models you can see in the webshop)		

injection pipes



<b>Part No.</b>	696767	<b>Ref. No.</b>	R10206480
<b>description</b>	extension U-shape for injection pipe ED ø 8/12mm ID ø 6/8mm		
<b>For models:</b>	EC110M, EC210M, EM010M+SC, EM110H, EM110M, EM110M+SC, EM110P, EM210H, EM210M, EM210M+SC, EM210P, EV110H, EV110M, EV110M+SC, EV110P, EV210H, EV210M, EV210M+SC, EV210P, GC110M, GC210M, GM110H, GM110M, GM110M+SC, GM110P, GM210H, GM210M, GM210M+SC, GM210P, GV110H, GV110M, GV-110M+SC, GV110P, GV210H, GV210M, GV210M+SC, GV210P, MEC24H, MEC40M, MGC20X, MGC24H, MGC40H, VE110M, VE110X, VE120M, VE120P, VE120X, VE210M, VE210P, VE210X...(Other models you can see in the webshop)		



<b>Part No.</b>	692819	<b>Ref. No.</b>	R11201980
<b>description</b>	injection pipe for combi-steamer ED ø 8mm ID ø 5.5mm L 170mm W 115mm		
<b>For models:</b>	GVT20D, MGVT10D, MGVT10P, MGVT20D, MGVT20P, MGVT40D, MGVT40P		



<b>Part No.</b>	692821	<b>Ref. No.</b>	R18200540
<b>description</b>	injection pipe for combi-steamer H 75mm ED ø 8mm ID ø 6mm L 105mm		
<b>For models:</b>	MACE04M, MACE05M, MACG05M, MVE042P, MVE051P, MVG051P		



<b>Part No.</b>	692832	<b>Ref. No.</b>	R11201990
<b>description</b>	injection pipe for combi-steamer U-shape ED ø 8mm ID ø 6mm		
<b>For models:</b>	GMT20D, MACG10M, MACG20M, MG101M, MG101P, MG101T, MG102D, MG102M, MG102P, MG102T, MGMT20D, MGMT20P		



<b>Part No.</b>	694318	<b>Ref. No.</b>	R10206540
<b>description</b>	injection pipe L1 66mm L2 49mm tube ø 8mm mounting distance 36mm		
<b>For models:</b>	EC106M, EC110M, EC210M, EM010M+SC, EM106H, EM106M, EM106M+SC, EM106P, EM110H, EM110M, EM110M+SC, EM110P, EM210H, EM210M, EM210M+SC, EM210P, EV006M, EV106H, EV106M, EV106M+SC, EV106P, EV110H, EV110M, EV110M+SC, EV110P, EV210H, EV210M, EV210M+SC, EV210P, GC106M, GC110M, GC210M, GM106H, GM106M, GM106M+SC, GM106P, GM110H, GM110M, GM110M+SC, GM110P, GM210H, GM210M, GM210M+SC, GM210P, GV106H, GV106M, GV106M+SC, GV106P, GV110H, GV110M...(Other models you can see in the webshop)		



			
1			
<b>Part No.</b>	692820	<b>Ref. No.</b>	R11200650
<b>description</b>	injection pipe with holder for combi-steamer ED ø 8mm ID ø 6mm L 150mm H 75mm		
<b>For models:</b>	GMT06D, GVT06D, MACE07M, MACG07M, ME061D, ME061M, ME061P, ME061T, MEMT06D, MEMT06P, MEVT06D, MEVT06P, MG061D, MG061M, MG061P, MG061T, MGMT06D, MGMT06P, MGMT06D, MGMT06P, MGMT06D, MGMT06P		

## spare parts and accessories

			
1			
<b>Part No.</b>	692835	<b>Ref. No.</b>	LAR58003110
<b>description</b>	pin for air baffle combi-steamer L 38mm ø 7mm		

			
1			
<b>Part No.</b>	694979	<b>Ref. No.</b>	LA69180110 LAR69180110
<b>description</b>	thermostatic steam trap for combi-steamer plastic		

## filters

			
1			
<b>Part No.</b>	691269	<b>Ref. No.</b>	R18200260
<b>description</b>	drain filter ø 43mm		
<b>For models:</b>	MACE04M, MVE042P		

			
1			
<b>Part No.</b>	691270	<b>Ref. No.</b>	R02200280 R10201700
<b>description</b>	drain filter ø 76mm		
<b>For models:</b>	EC106M, EC110M, EC210M, EM010M+SC, EM106H, EM106M, EM106M+SC, EM106P, EM110H, EM110M, EM110M+SC, EM110P, EM210H, EM210M, EM210M+SC, EM210P, EV006M, EV106H, EV106M, EV106M+SC, EV106P, EV110H, EV110M, EV110M+SC, EV110P, EV210H, EV210M, EV210M+SC, EV210P, FE105M, FE105X, FE110M, FE110X, FG105M, FG105X, FG110M, FG110X, GC106M, GC110M, GC210M, GM106H, GM106M, GM106M+SC, GM106P, GM110H, GM110M, GM110M+SC, GM110P, GM210H, GM210M... (Other models you can see in the webshop)		

			
1			
<b>Part No.</b>	691271	<b>Ref. No.</b>	LA10201710 LAR10201710 R10201720
<b>description</b>	drain filter ø 87mm		
<b>For models:</b>	GMT06D, GMT20D, GVT06D, MACE10M, MACE20M, MACG10M, MACG20M, ME102D, ME102M, ME102P, ME102T, ME120M, ME120P, ME120X, ME201D, ME201M, ME201P, ME201T, ME202D, ME202M, ME202P, ME202T, ME220M, ME220P, ME220X, MEC24H, MEC40M, MEMT06D, MEMT06P, MEMT10D, MEMT10P, MEMT20D, MEMT20P, MEMT21D, MEMT21P, MEMT40D, MEMT40P, MEVT06D, MEVT06P, MEVT10D, MEVT10P, MEVT20D, MEVT20P, MEVT21D, MEVT21P, MEVT40D, MEVT40P, MG120M, MG120P, MG120X... (Other models you can see in the webshop)		

## glass panels

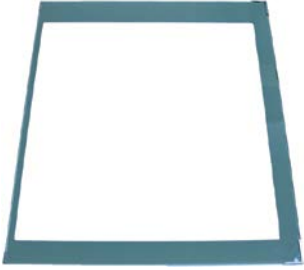
			
1			
<b>Part No.</b>	696396	<b>Ref. No.</b>	R11100140
<b>description</b>	glass panel L 860mm W 730mm thickness 6mm mounting pos. inner for combi-steamer		
<b>For models:</b>	GMT20D, GVT20D, ME101D, ME101M, ME101P, ME101T, ME102D, ME102M, ME102P, ME102T, MEMT20D, MEMT20P, MEVT20D, MEVT20P, MG101D, MG101M, MG101P, MG101T, MG102D, MG102M, MG102P, MG102T, MGMT20D, MGMT20P, MGMT20D, MGMT20P		

## cleaning system

## nozzles

			
1			
<b>Part No.</b>	550864	<b>Ref. No.</b>	R62210042
<b>description</b>	nozzle flow rate 0.56l/min for combi-steamer		
<b>For models:</b>	ME061T, ME101T, ME102T, ME201T, MEMT06P, MEMT10P, MEMT20P, MEMT21P, MEMT40P, MG102T, MG201T, MG202T, MGMT06P, MGMT10P, MGMT20P, MGMT21P, MGMT40P		



			
<b>Part No.</b>	550865	<b>Ref. No.</b>	R62210032
<b>description</b>	nozzle flow rate 1.3l/min for combi-steamer		
<b>For models:</b>	ME061T, ME101T, ME102T, ME201T, MEMT06P, MEMT10P, MEMT20P, MEMT21P, MEMT40P, MG102T, MG201T, MG202T, MGMT06P, MGMT10P, MGMT20P, MGMT21P, MGMT40P		

coupling bushings

			
<b>Part No.</b>	550863	<b>Ref. No.</b>	R58004980
<b>description</b>	bush for wash arm		
<b>For models:</b>	ME061T, ME101T, ME102T, ME201T, MEMT06P, MEMT10P, MEMT20P, MEMT21P, MEMT40P, MG102T, MG201T, MG202T, MGMT06P, MGMT10P, MGMT20P, MGMT21P, MGMT40P		

cleaning arms

			
<b>Part No.</b>	542409	<b>Ref. No.</b>	LAR58007020
<b>description</b>	mounting flange with gasket for wash arm suitable for LAINOX combi-steamer		

hoses

			
<b>Part No.</b>	694953	<b>Ref. No.</b>	LA80150040 LAR70070080
<b>description</b>	hose ID ø 13mm ED ø 23mm L 1mm EPDM blue/white t.max. 120°C for combi-steamer		

screw connections

			
<b>Part No.</b>	542412	<b>Ref. No.</b>	LAR58007000
<b>description</b>	bolt for flange wash arm L 50mm M12x1 suitable for combi-steamer		

pipes

			
<b>Part No.</b>	520970	<b>Ref. No.</b>	R62180022
<b>description</b>	drain pipe flexible L 135mm ID ø 18mm ED ø 27.5mm connection 3/4" ET - 3/4" IT SS for combi-steamer		
<b>For models:</b>	GMT06D, ME201D, ME201M, ME201P, ME201T, MEMT21D, MEMT21P, MG061D, MG061M, MG061P, MG061T, MG101D, MG101M, MG101P, MG101T, MG120M, MG120P, MG120X, MG201D, MG201M, MG201P, MG201T, MG202D, MG202M, MG202P, MG202T, MGC20X, MGMT06D, MGMT06P, MGMT10D, MGMT10P, MGMT21D, MGMT21P, MGMT40D, MGMT40P		

hoses

			
<b>Part No.</b>	530904	<b>Ref. No.</b>	LAR77700056
<b>description</b>	hose ID ø 30mm ED ø 36mm L 3000mm for combi-steamer		

			
<b>Part No.</b>	520534	<b>Ref. No.</b>	LA70060040 LAR70060040
<b>description</b>	hose ID ø 50mm ED ø 58mm L 50mm silicone Qty 1 for combi-steamer thickness 4mm		

<b>For models:</b>	FE105M, FE105X, FE110M, FE110X, FG105M, FG105X, FG110M, FG110X, GMT20D, ME061P, ME061T, ME101M, ME101P, ME101T, ME102M, ME102P, ME102T, ME106M, ME106P, ME106X, ME110M, ME110P, ME110X, ME120M, ME120P, ME120X, ME201D, ME201M, ME201P, ME201T, ME202D, ME202M, ME202P, ME202T, ME210M, ME210P, ME210X, ME220M, ME220P, ME220X, MEC24H, MEC40M, MEMT21D, MEMT21P, MEMT40D, MEMT40P, MEVT21D, MEVT21P, MEVT40D, MEVT40P...(Other models you can see in the webshop)		
--------------------	--	--	--

			
<b>Part No.</b>	530901	<b>Ref. No.</b>	LA70060050 R70060050
<b>description</b>	hose ID ø 54mm ED ø 60mm L 50mm for combi-steamer		

<b>For models:</b>	FE210M, FG210M, FG210X, ME102P, ME102T, ME202D, ME202M, ME202P, ME202T, MEMT40D, MEMT40P, MEVT40D, MEVT40P, MG102P, MG102T, MG202D, MG202M, MG202P, MG202T, MGMT40D, MGMT40P, MGVT40D, MGVT40P		
--------------------	--	--	--



## service kits

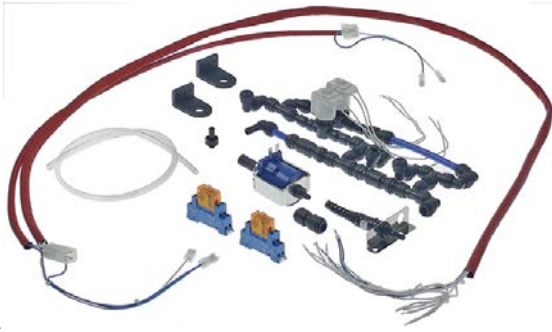

1

<b>Part No.</b>	512503	<b>Ref. No.</b>	R62300028
<b>description</b>	backflow preventer kit		
<b>For models:</b>	ME061T, ME101T, ME102T, ME201T, MEMT06P, MEMT10P, MEMT20P, MG102T, MG201T, MGMT06P, MGMT10P, MGMT20P		



1

<b>Part No.</b>	699468	<b>Ref. No.</b>	R58003100
<b>description</b>	mounting set for air baffle 4-piece		
<b>For models:</b>	GMT06D, GMT20D, GVT06D, GVT20D, ME061D, ME061M, ME061P, ME061T, ME101D, ME101M, ME101P, ME101T, ME102D, ME102M, ME102P, ME106M, ME106P, ME106X, ME110M, ME110P, ME110X, ME120M, ME120P, ME120X, ME201D, ME201M, ME201P, ME201T, ME202D, ME202M, ME202P, ME202T, ME210M, ME210P, ME210X, ME220M, ME220P, ME220X, MEC24H, MEC40M, MEMT06D, MEMT06P, MEMT10D, MEMT10P, MEMT20D, MEMT20P, MEMT21D, MEMT21P, MEMT40D, MEMT40P...(Other models you can see in the webshop)		

## doors



1

<b>Part No.</b>	692325	<b>Ref. No.</b>	R71010010
<b>description</b>	glass panel W 514mm H 314mm thickness 4mm for hot air oven Qty 1 pcs		
<b>For models:</b>	FE105M, FE105X, FG105M, FG105X, PE040M, PE040X, PG040M, PG040X		



1

<b>Part No.</b>	691298	<b>Ref. No.</b>	R18100000
<b>description</b>	oven door complete		
<b>For models:</b>	MACE04M, MVE042P		

1

<b>Part No.</b>	692836	<b>Ref. No.</b>	R11401360
<b>description</b>	protective plate lower for glass plate combi-steamer H 8mm W 8mm		
<b>For models:</b>	GMT06D, GMT20D, GVT06D, GVT20D, ME061D, ME061M, ME061P, ME061T, ME101D, ME101M, ME101P, ME101T, ME102D, ME102M, ME102P, ME102T, MEMT06D, MEMT06P, MEMT10D, MEMT10P, MEMT20D, MEMT20P, MEVT06D, MEVT06P, MEVT10D, MEVT10P, MEVT20D, MEVT20P, MG061D, MG061M, MG061P, MG061T, MG101D, MG101M, MG101P, MG101T, MG102D, MG102M, MG102P, MG102T, MGMT06D, MGMT06P, MGMT10D, MGMT10P, MGMT20D, MGMT20P, MGVT06D, MGVT06P, MGVT10D, MGVT10P...(Other models you can see in the webshop)		

1

<b>Part No.</b>	692837	<b>Ref. No.</b>	R11401340
<b>description</b>	protective plate upper for glass plate combi-steamer H 8mm W 8mm		
<b>For models:</b>	GMT06D, GMT20D, GVT06D, GVT20D, MACE07M, MACE10M, MACE20M, MACG07M, MACG10M, MACG20M, ME061D, ME061M, ME061P, ME061T, ME101D, ME101M, ME101P, ME101T, ME102D, ME102M, ME102P, ME102T, MEMT06D, MEMT06P, MEMT10D, MEMT10P, MEMT20D, MEMT20P, MEVT06D, MEVT06P, MEVT10D, MEVT10P, MEVT20D, MEVT20P, MG061D, MG061M, MG061P, MG061T, MG101D, MG101M, MG101P, MG101T, MG102D, MG102M, MG102P, MG102T, MGMT06D, MGMT06P, MGMT10D, MGMT10P...(Other models you can see in the webshop)		





door mechanics

holders



1			
<b>Part No.</b>	691272	<b>Ref. No.</b>	R18203910
<b>description</b>	bracket for glass plate mounting pos. lower		
<b>For models:</b>	MACE07M, MACE10M, MACE20M, MACG07M, MACG10M, MACG20M		



1			
<b>Part No.</b>	691273	<b>Ref. No.</b>	R18203920
<b>description</b>	bracket for glass plate mounting pos. upper		
<b>For models:</b>	MACE07M, MACE10M, MACE20M, MACG07M, MACG10M, MACG20M		



accessories



1			
<b>Part No.</b>	692834	<b>Ref. No.</b>	R10207680
<b>description</b>	fixing plate for door W 30mm L 50mm		
<b>For models:</b>	ME120M, ME120P, ME120X, ME201D, ME201M, ME201P, ME201T, ME202D, ME202M, ME202P, ME202T, ME220M, ME220P, ME220X, MEC24H, MEC40M, MEMT21D, MEMT21P, MEMT40D, MEMT40P, MEVT21D, MEVT21P, MEVT40D, MEVT40P, MG120M, MG120P, MG120X, MG201D, MG201M, MG201P, MG201T, MG202D, MG202M, MG202P, MG202T, MG220M, MG220P, MG220X, MGC20X, MGC24H, MGC40H, MGMT21D, MGMT21P, MGMT40D, MGMT40P, MGVT21D, MGVT21P, MGVT40D, MGVT40P, VE120M...(Other models you can see in the webshop)		

vibration pumps



1			
<b>Part No.</b>	500568	<b>Ref. No.</b>	LAR65110600
<b>description</b>	vibration pump 230V 32W 50Hz inlet ø 7 outlet ø 1/8" IT CEME type E512/A32		
<b>For models:</b>	ME061T, ME101T, ME102T, ME201T, MEMT06P, MEMT10P, MEMT20P, MEMT21P, MEMT40P, MG102T, MG201T, MG202T, MGMT06P, MGMT10P, MGMT20P, MGMT21P, MGMT40P		
<b>spare parts for</b>	500568		
	<b>Part No.</b>	390698	<b>Ref. No.</b> —
	thermal fuse switch-off temp. 110°C suitable for ULKA pump		
	<b>Part No.</b>	520153	<b>Ref. No.</b> —
	bracket rubber dimensions 53x34x28mm		

heat exchangers



1			
<b>Part No.</b>	520509	<b>Ref. No.</b>	LA58004170 LAR58004170
<b>description</b>	reducing washer gas burner brass ID ø 3mm ED ø 16mm thickness 2.2mm code 3		
<b>For models:</b>	MACG05M, MVG051P		

miscellaneous



1			
<b>Part No.</b>	696428	<b>Ref. No.</b>	R11201970
<b>description</b>	extension U-shape for injection pipe D1 ø 8mm D2 ø 10mm L 212mm WS 12 stainless steel		
<b>For models:</b>	MACE10M, MACE20M, ME101D, ME101M, ME101P, ME101T, ME102D, ME102M, ME102P, ME201D, ME201M, ME201P, ME201T, ME202D, ME202M, ME202P, ME202T, MEMT10D, MEMT10P, MEMT20D, MEMT20P, MEMT21D, MEMT21P, MEMT40D, MEMT40P, MEVT10D, MEVT10P, MEVT20D, MEVT20P, MEVT21D, MEVT21P, MEVT40D, MEVT40P, MG101D, MG201D, MG201M, MG201P, MG201T, MG202D, MG202M, MG202P, MG202T, MGMT10D, MGMT10P, MGMT21D, MGMT21P, MGMT40D, MGMT40P, MGVT21D, MGVT21P		



1			
<b>Part No.</b>	696394	<b>Ref. No.</b>	R10206470
<b>description</b>	extension U-shape for injection pipe D1 ø 8mm D2 ø 12mm L 113mm W 72mm		
<b>For models:</b>	EC106M, EM106H, EM106M, EM106M+SC, EM106P, EV006M, EV106H, EV106M, EV106M+SC, EV106P, GC106M, GM106H, GM106M, GM106M+SC, GM106P, GV106H, GV106M, GV106M+SC, GV106P, VE106M, VE106P, VE106X, VG106M, VG106P, VG106X		

3 mechanical components, equipment accessories

1

<b>Part No.</b>	691290	<b>Ref. No.</b>	R10100140
<b>description</b>	extractor stubs complete		
<b>For models:</b>	ME061P, ME061T, ME101P, ME101T, ME106M, ME106P, ME106X, ME110M, ME110P, ME110X, ME120M, ME120P, ME120X, ME210M, ME210P, ME210X, ME220M, ME220P, ME220X, MEC24H, MEMT06P, MEMT10P, MEVT06P, MEVT10P, MG061P, MG061T, MG101P, MG101T, MG106M, MG106P, MG106X, MG110M, MG110P, MG110X, MG120M, MG120P, MG120X, MG210M, MG210P, MG210X, MG220M, MG220P, MG220X, MGC24H, MGC40H, MGMT06P, MGMT10P, MGVT06P, MGVT10P, VE106M...(Other models you can see in the webshop)		



1

<b>Part No.</b>	691282	<b>Ref. No.</b>	R58005350
<b>description</b>	gasket for door handle D1 ø 30mm D2 ø 18mm mounting pos. upper H 1.4mm		
<b>For models:</b>	CVE004H, CVE004M, CVE104H, CVE104M, CVE105H, CVE105M, CVG105H, CVG105M, EC106M, EC110M, EC210M, EM010M+SC, EM106H, EM106M, EM106M+SC, EM106P, EM110H, EM110M, EM110M+SC, EM110P, EM210H, EM210M, EM210M+SC, EM210P, EV006M, EV106H, EV106M, EV106M+SC, EV106P, EV110H, EV110M, EV110M+SC, EV110P, EV210H, EV210M, EV210M+SC, EV210P, FE105M, FE105X, FE110M, FE110X, FE210M, FG105M, FG105X, FG110M, FG110X, FG210M, FG210X, GC106M, GC110M...(Other models you can see in the webshop)		



1

<b>Part No.</b>	691291	<b>Ref. No.</b>	R70060020
<b>description</b>	gasket for extractor stubs D1 ø 30mm D2 ø 35mm W 9mm		
<b>For models:</b>	ME061P, ME061T, ME101P, ME101T, ME106M, ME106P, ME106X, ME110M, ME110P, ME110X, ME120M, ME120P, ME120X, ME210M, ME210P, ME210X, ME220M, ME220P, ME220X, MEC24H, MEMT06P, MEMT10P, MEVT06P, MEVT10P, MG061P, MG061T, MG101P, MG101T, MG106M, MG106P, MG106X, MG110M, MG110P, MG110X, MG120M, MG120P, MG120X, MG210M, MG210P, MG210X, MG220M, MG220P, MG220X, MGC24H, MGC40H, MGMT06P, MGMT10P, MGVT06P, MGVT10P, VE106M...(Other models you can see in the webshop)		



1

<b>Part No.</b>	690099	<b>Ref. No.</b>	LA58002150 LAR58002150
<b>description</b>	hinge pin mounting pos. upper for door		
<b>For models:</b>	EC106M, EC110M, EC210M, EM010M+SC, EM106H, EM106M, EM106M+SC, EM106P, EM110H, EM110M, EM110M+SC, EM110P, EM210H, EM210M, EM210M+SC, EM210P, EV006M, EV106H, EV106M, EV106M+SC, EV106P, EV110H, EV110M, EV110M+SC, EV110P, EV210H, EV210M, EV210M+SC, EV210P, GC106M, GC110M, GC210M, GM106H, GM106M, GM106M+SC, GM106P, GM110H, GM110M, GM110M+SC, GM110P, GM210H, GM210M, GM210M+SC, GM210P, GMT06D, GMT20D, GV106H, GV106M, GV106M+SC, GV106P...(Other models you can see in the webshop)		



1

<b>Part No.</b>	506229	<b>Ref. No.</b>	R11200380
<b>description</b>	injection pipe for combi-steamer L 205mm ø 10mm		
<b>For models:</b>	GMT06D, GMT20D, GVT06D, GVT20D, MACE07M, MACE10M, MACE20M, MACG07M, MACG10M, MACG20M, ME061D, ME061M, ME061P, ME061T, ME101D, ME101M, ME101P, ME101T, ME102D, ME102M, ME102P, ME201D, ME201M, ME201P, ME201T, ME202D, ME202M, ME202P, ME202T, MEMT06D, MEMT06P, MEMT10D, MEMT10P, MEMT20D, MEMT20P, MEMT21D, MEMT21P, MEMT40D, MEMT40P, MEVT06D, MEVT06P, MEVT10D, MEVT10P, MEVT20D, MEVT20P, MEVT21D, MEVT21P, MEVT40D, MEVT40P, MG061D...(Other models you can see in the webshop)		



1

<b>Part No.</b>	691289	<b>Ref. No.</b>	R58004830
<b>description</b>	nut thread M18x1 H 5mm WS 22 brass Qty 1 pcs for door handle		
<b>For models:</b>	CVE004H, CVE004M, CVE104H, CVE104M, CVE105H, CVE105M, CVG105H, CVG105M, EC106M, EC110M, EC210M, EM010M+SC, EM106H, EM106M, EM106M+SC, EM106P, EM110H, EM110M, EM110M+SC, EM110P, EM210H, EM210M, EM210M+SC, EM210P, EV006M, EV106H, EV106M, EV106M+SC, EV106P, EV110H, EV110M, EV110M+SC, EV110P, EV210H, EV210M, EV210M+SC, EV210P, FE105M, FE105X, FE110M, FE110X, FE210M, FG105M, FG105X, FG110M, FG110X, FG210M, FG210X, GC106M, GC110M...(Other models you can see in the webshop)		





1

<b>Part No.</b>	691296	<b>Ref. No.</b>	R61400052
<b>description</b>	plain washer ID ø 10.5mm ED ø 21mm thickness 2mm SS Qty 1 pcs for fan wheel		
<b>For models:</b>	CVE105H, CVE105M, CVG105H, CVG105M, EC106M, EM106H, EM106M, EM106M+SC, EM106P, EV006M, EV106H, EV106M, EV106M+SC, EV106P, FE105M, FE105X, FG105M, FG105X, GC106M, GM106H, GM106M, GM106M+SC, GM106P, GMT06D, GV106H, GV106M, GV106M+SC, GV106P, GVT06D, MACE07M, MACG07M, ME061D, ME061M, ME061P, ME061T, ME106M, ME106P, ME106X, MEMT06D, MEMT06P, MEVT06D, MEVT06P, MG061D, MG061M, MG061P, MG061T, MG106M, MG106P, MG106X, MGMT06D...(Other models you can see in the webshop)		





			
1			
<b>Part No.</b>	691292	<b>Ref. No.</b>	R10401710
<b>description</b>	plain washer ID ø 12mm ED ø 17.5mm thickness 1mm SS Qty 1 pcs		
<b>For models:</b>	GMT06D, GMT20D, GVT06D, GVT20D, MACE07M, MACE10M, MACE20M, MACG07M, MACG10M, MACG20M, ME061D, ME061M, ME061P, ME061T, ME101D, ME101M, ME101P, ME101T, ME102D, ME102M, ME102P, ME102T, ME106M, ME106P, ME106X, ME110M, ME110P, ME110X, ME210M, ME210P, ME210X, MEMT06D, MEMT06P, MEMT10D, MEMT10P, MEMT20D, MEMT20P, MEVT06D, MEVT06P, MEVT10D, MEVT10P, MEVT20D, MEVT20P, MG061D, MG061M, MG061P, MG061T, MG101D, MG101M, MG101P...(Other models you can see in the webshop)		

			
1			
<b>Part No.</b>	691280	<b>Ref. No.</b>	R58005340
<b>description</b>	sealing disc for door handle mounting pos. lower ED ø 25mm ID ø 5.5mm H 5mm		
<b>For models:</b>	CVE004H, CVE004M, CVE104H, CVE104M, CVE105H, CVE105M, CVG105H, CVG105M, EC106M, EC110M, EC210M, EM010M+SC, EM106H, EM106M, EM106M+SC, EM106P, EM110H, EM110M, EM110M+SC, EM110P, EM210H, EM210M, EM210M+SC, EM210P, EV006M, EV106H, EV106M, EV106M+SC, EV106P, EV110H, EV110M, EV110M+SC, EV110P, EV210H, EV210M, EV210M+SC, EV210P, FE105M, FE105X, FE110M, FE110X, FE210M, FG105M, FG105X, FG110M, FG110X, FG210M, FG210X, GC106M, GC110M...(Other models you can see in the webshop)		

			
1			
<b>Part No.</b>	691283	<b>Ref. No.</b>	R58003240
<b>description</b>	pressure bolt for door handle D1 ø 8mm D2 ø 11mm L 73mm thread M6 bolt 16mm bolt ø 5mm		
<b>For models:</b>	CVE105H, CVE105M, CVG105H, CVG105M, FE105M, FE105X, FE110M, FE110X, FE210M, FG105M, FG105X, FG110M, FG110X, FG210M, FG210X, MACE04M, MACE05M, MACE07M, MACE10M, MACE20M, MACG05M, MACG07M, MACG10M, MACG20M, ME106M, ME106P, ME106X, ME110M, ME110P, ME110X, ME210M, ME210P, ME210X, MG106M, MG106P, MG106X, MG110M, MG110P, MG110X, MG210M, MG210P, MG210X, MVE042P, MVE051P, MVG051P, PE040M, PE040X, PE080M, PE080X, PG040M...(Other models you can see in the web-shop)		

			
1			
<b>Part No.</b>	691281	<b>Ref. No.</b>	R58004270
<b>description</b>	spacer piece for door handle L 34mm ID ø 6mm ED ø 8mm		
<b>For models:</b>	CVE004H, CVE004M, CVE104H, CVE104M, CVE105H, CVE105M, CVG105H, CVG105M, FE105M, FE105X, FE110M, FE110X, FE210M, FG105M, FG105X, FG110M, FG110X, FG210M, FG210X, MACE04M, MACE05M, MACE07M, MACE10M, MACE20M, MACG05M, MACG07M, MACG10M, MACG20M, ME106M, ME106P, ME106X, ME110M, ME110P, ME110X, ME210M, ME210P, ME210X, MG106M, MG106P, MG106X, MG110M, MG110P, MG110X, MG210M, MG210P, MG210X, MVE042P, MVE051P, MVG051P, PE040M...(Other models you can see in the webshop)		

			
1			
<b>Part No.</b>	691297	<b>Ref. No.</b>	LAG2030113 R62030118
<b>description</b>	reducer thread 1/4 / 1/8		
<b>For models:</b>	GVT06D, GVT20D, MEVT06D, MEVT06P, MEVT10D, MEVT10P, MEVT20D, MEVT20P, MEVT21D, MEVT21P, MEVT40D, MEVT40P, MGVT06D, MGVT06P, MGVT10D, MGVT10P, MGVT20D, MGVT20P, MGVT21D, MGVT21P, MGVT40D, MVE042P, MVE051P, MVG051P		
<b>accessories for</b>	691297		
	<b>Part No.</b>	529544	<b>Ref. No.</b>
			—
	 O-ring EPDM thickness 2.62mm ID ø 7.59mm Qty 1 pcs		

			
1			
<b>Part No.</b>	692300	<b>Ref. No.</b>	LAR70050180 R70050100
<b>description</b>	stopper with screw connection for glass plate D1 ø 15mm L 8mm thread M4		
<b>For models:</b>	GMT06D, GMT20D, GVT06D, GVT20D, MACE07M, MACE10M, MACE20M, MACG07M, MACG10M, MACG20M, ME061D, ME061M, ME061P, ME061T, ME101D, ME101M, ME101P, ME101T, ME102D, ME102M, ME102P, ME102T, ME201M, ME201P, ME201T, ME202D, ME202M, ME202P, ME202T, MEMT06D, MEMT06P, MEMT10D, MEMT10P, MEMT20D, MEMT20P, MEMT21D, MEMT21P, MEMT40D, MEMT40P, MEVT06D, MEVT06P, MEVT10D, MEVT10P, MEVT20D, MEVT20P, MEVT21D, MEVT21P, MEVT40D, MEVT40P...(Other models you can see in the webshop)		

			
1			
<b>Part No.</b>	694319	<b>Ref. No.</b>	R58003390
<b>description</b>	screw connection for pressure switch L 50mm WS 30 brass thread 1/4"		
<b>For models:</b>	CVE004H, CVE004M, CVE104H, CVE104M, CVE105H, CVE105M, CVG105H, CVG105M, EV106H, EV106P, EV110H, EV110P, EV210H, EV210P, GV106H, GV106P, GV110H, GV110P, GV210H, GV210P, MG202D, MG202M, MG202P, MG202T, MGMT40D, MGMT40P, MGVT40D, MGVT40P, VE004M, VE004X, VE104M, VE104X, VE105M, VE105X, VE106P, VE120P, VE210P, VE220P, VG105M, VG105X, VG106P, VG110P, VG120P, VG210P, VG220P		

## knobs

### producer-specific knobs

MARENO			
			
1			
<b>Part No.</b>	110997	<b>Ref. No.</b>	1323500 1323513 MA1323513
<b>description</b>	knob dial plate oven BH/TH/BH+TH t.max. °C		



accessories

button springs



1

<b>Part No.</b>	550132	<b>Ref. No.</b>	9003088700 MA9003088700
<b>description</b>	knob spring $\varnothing$ 6x4.6mm Qty 10 pcs		

handles and hand wheels

cylindrical handles

fixed



1

<b>Part No.</b>	110703	<b>Ref. No.</b>	1829200 MA1829200
<b>description</b>	cylindrical handle thread M10 $\varnothing$ 28mm L 87mm		
<b>For models:</b>	CRE6220, CRE6230, CRE6320, CRE6330, GB704G, GB707G, GB92G, GB94G, GL12C4G, GL12C9G, GL74G, GL78G, GL94G, GL98G, NGL74G, NGL78G, OPLG40, OPLG80, PLG40, PLG80, SME62M, SME63M, SME70M, SPE60M, SPW60M, TSE60M		

bracket handles



1

<b>Part No.</b>	700551	<b>Ref. No.</b>	1851800 MA1851800
<b>description</b>	pull handle L 200mm H 62mm mounting distance 179mm handle M8		

locks

edgemount latches

handle latches

CAFF/FERMOD

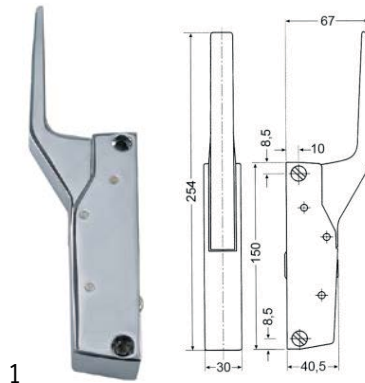

1

<b>Part No.</b>	700060	<b>Ref. No.</b>	2872000 MA2872000	
<b>description</b>	handle latch L 150mm mounting distance 133mm non lockable heated units G 791			
<b>For models:</b>	CON102E, CON102EP, CON102G, CON102GP, CON10E, CON10EP, CON10G, CON10GP, CON6E, CON6EP, CON6G, CON6GP, CS102E, CS102EP, CS102G, CS102GP, CSM102E, CSM102EP, CSM102G, CSM102GP, CSM10E, CSM10EP, CSM10G, CSM10GP, CSM6E, CSM6EP, CSM6G, CSM6GP			
<b>accessories for</b>	700060			
	<b>Part No.</b>	700061	<b>Ref. No.</b>	5129900 MA5129900
	door catch L 58mm W 20mm H 35mm mounting distance 42mm chrome-plated brass for headed units			
	<b>Part No.</b>	700062	<b>Ref. No.</b>	—
	handle protection heated units			

door catches



1

<b>Part No.</b>	700061	<b>Ref. No.</b>	5129900 MA5129900	
<b>description</b>	door catch L 58mm W 20mm H 35mm mounting distance 42mm chrome-plated brass for headed units			
<b>For models:</b>	CON102E, CON102EP, CON102G, CON102GP, CON10E, CON10EP, CON10G, CON10GP, CON6E, CON6EP, CON6G, CON6GP, CSM102E, CSM102EP, CSM102G, CSM102GP, CSM10E, CSM10EP, CSM10G, CSM10GP, CSM6E, CSM6EP, CSM6G, CSM6GP			
<b>accessories for</b>	700061			
	<b>Part No.</b>	690414	<b>Ref. No.</b>	—
	handle latch L 150mm mounting distance 133mm non lockable refrigeration units G 791			



snap locks

universal

 <p>1</p>			
<b>Part No.</b>	690596	<b>Ref. No.</b>	2711200 2844800 2844800R LA69050010 LAR69050010
<b>description</b>	snap lock L 60mm W 15mm H 36mm mounting distance 48/28mm spring thickness 1.5mm complete with door catch zamak		
<b>For models:</b>	CS4E, CS4EP, FC10E, FC20GP, FC5E, FC7E		

producer-specific

MARENO

 <p>1</p>			
<b>Part No.</b>	694586	<b>Ref. No.</b>	SIRZR960029 SIRZ960029
<b>description</b>	snap lock repair set		

espagnolette locks

universal

 <p>1</p>			
<b>Part No.</b>	690041	<b>Ref. No.</b>	5145100 MA5145100
<b>description</b>	cam L 148mm mounting distance 32mm		
<b>For models:</b>	CSM201, CSM202		





 <p>1</p>			
<b>Part No.</b>	690040	<b>Ref. No.</b>	5156000 MA5156000
<b>description</b>	door catch with roller H 42mm L 40mm W 40mm zinc die cast mounting distance 26mm type 0751 series		
<b>For models:</b>	CSM201, CSM202		

producer-specific

MARENO

 <p>1</p>			
<b>Part No.</b>	690041	<b>Ref. No.</b>	5145100 MA5145100
<b>description</b>	cam L 148mm mounting distance 32mm		
<b>For models:</b>	CSM201, CSM202		

 <p>1</p>			
<b>Part No.</b>	690040	<b>Ref. No.</b>	5156000 MA5156000
<b>description</b>	door catch with roller H 42mm L 40mm W 40mm zinc die cast mounting distance 26mm type 0751 series		
<b>For models:</b>	CSM201, CSM202		

 <p>1</p>			
<b>Part No.</b>	690042	<b>Ref. No.</b>	5154800 MA5154800
<b>description</b>	latch gear opening to the right shaft intake ø 8x8mm L 170mm H 40mm		
<b>For models:</b>	CSM201, CSM202		
<b>accessories for</b>	690042		
	<b>Part No.</b>	<b>Ref. No.</b>	5156000 MA5156000
	 door catch with roller H 42mm L 40mm W 40mm zinc die cast mounting distance 26mm type 0751 series		
	<b>Part No.</b>	<b>Ref. No.</b>	5145100 MA5145100
	 cam L 148mm mounting distance 32mm		
	<b>Part No.</b>	<b>Ref. No.</b>	—
	 bar ø 10mm for door latch L 113.5mm		

miscellaneous

 <p>1</p>			
<b>Part No.</b>	691286	<b>Ref. No.</b>	LAR58001780
<b>description</b>	catch for glass plate		
<b>For models:</b>	GMT06D, GMT20D, GVT06D, GVT20D, MACE07M, MACE10M, MACE20M, MACG07M, MACG10M, MACG20M, ME061D, ME061M, ME061P, ME061T, ME101D, ME101M, ME101P, ME101T, ME102D, ME102M, ME102P, ME102T, ME201D, ME201M, ME201P, ME201T, ME202D, ME202M, ME202P, ME202T, MEMT06D, MEMT06P, MEMT10D, MEMT10P, MEMT20D, MEMT20P, MEMT21D, MEMT21P, MEMT40D, MEMT40P, MEVT06D, MEVT06P, MEVT10D, MEVT10P, MEVT20D, MEVT20P, MEVT21D, MEVT21P, MEVT40D, MEVT40P... (Other models you can see in the webshop)		





## hinges

## oven hinges

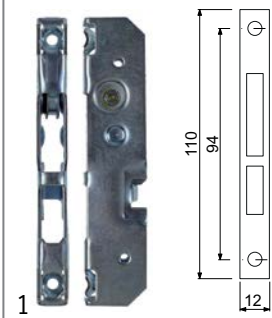

<b>Part No.</b>	700003	<b>Ref. No.</b>	1031106000 1034400800 MA1031106000 MA1034400800
<b>description</b>	opposite support L 110mm W 12mm mounting distance 94mm		
<b>For models:</b>	CFE60, CFE60P, CFGE60, CFGE61, CFGE61D, CFGE61L, CFGE61P, CFVE60, FOE60M, OCFE60, OCFGE61, OFOE60M		

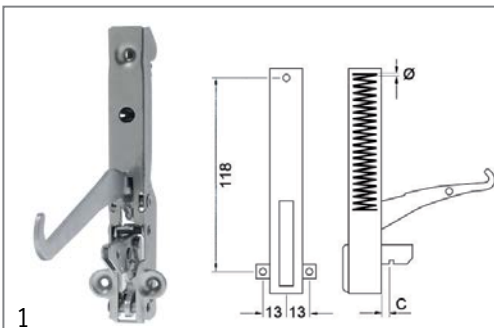

<b>Part No.</b>	690030	<b>Ref. No.</b>	1034400400 CR1075440 MA1034400400	
<b>description</b>	oven hinge mounting distance 118mm lug mounting 13mm lever length 117mm groove distance 10mm spring thickness 3.5mm mounting ear position left/right spring length 60mm L 155mm W 21mm			
<b>For models:</b>	CFE60, CFE60P, CFGE61, CFGE61D, CFGE61L, CFGE61P, CFVE60, OCFE60, OCFGE61			
<b>accessories for</b>	690030			
	<b>Part No.</b>	700003	<b>Ref. No.</b>	1031106000 1034400800 MA1031106000 MA1034400800
opposite support L 110mm W 12mm mounting distance 94mm				

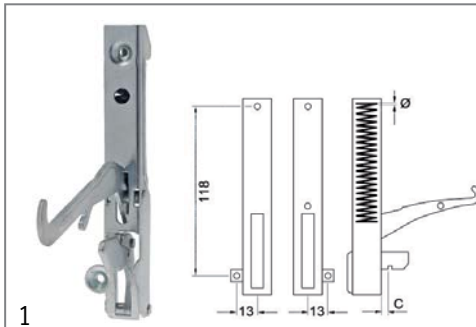

<b>Part No.</b>	700013	<b>Ref. No.</b>	1031102000 MA1031102000	
<b>description</b>	oven hinge mounting distance 118mm lug mounting 13mm lever length 119mm groove distance 13mm spring thickness 3.5mm mounting ear position left spring length 60mm L 154mm			
<b>For models:</b>	CFE60, CFE60P, CFGE60, CFGE61, CFGE61D, CFGE61L, CFGE61P, CFVE60			
<b>accessories for</b>	700013			
	<b>Part No.</b>	700003	<b>Ref. No.</b>	1031106000 1034400800 MA1031106000 MA1034400800
opposite support L 110mm W 12mm mounting distance 94mm				

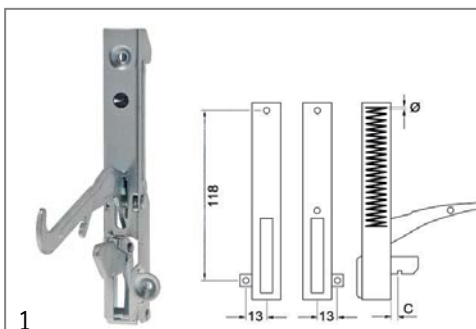

<b>Part No.</b>	700014	<b>Ref. No.</b>	1031105500 MA1031105500	
<b>description</b>	oven hinge mounting distance 118mm mounting distance 2mm lug mounting 13mm lever length 119mm groove distance 13mm spring thickness 3.5mm mounting ear position right spring length 60mm L 154mm			
<b>For models:</b>	CFE60, CFE60P, CFGE60, CFGE61, CFGE61D, CFGE61L, CFGE61P, CFVE60			
<b>accessories for</b>	700014			
	<b>Part No.</b>	700003	<b>Ref. No.</b>	1031106000 1034400800 MA1031106000 MA1034400800
opposite support L 110mm W 12mm mounting distance 94mm				



door bearing



1

<b>Part No.</b>	691288	<b>Ref. No.</b>	R58002520
<b>description</b>	door bolt		
<b>For models:</b>	GMT06D, GMT20D, GVT06D, GVT20D, MACE07M, MACE10M, MACE20M, MACG07M, MACG10M, MACG20M, ME061D, ME101D, ME102D, MEMT06D, MEMT06P, MEMT10D, MEMT10P, MEMT20D, MEMT20P, MEVT06D, MEVT06P, MEVT10D, MEVT10P, MEVT20D, MEVT20P, MG061D, MG101D, MG102D, MGMT06D, MGMT06P, MGMT10D, MGMT10P, MGMT20D, MGMT20P, MGVT06D, MGVT06P, MGVT10D, MGVT10P, MGVT20D, MGVT20P		



2

<b>Part No.</b>	692831	<b>Ref. No.</b>	LA58002670 LAR58002670
<b>description</b>	door bolt mounting pos. bottom left thread M12 bolt 15mm bolt ø 10mm		
<b>For models:</b>	GMT20D, GVT06D, GVT20D		



1

<b>Part No.</b>	690098	<b>Ref. No.</b>	R10201330
<b>description</b>	door hinge mounting pos. lower with holder		
<b>For models:</b>	ME120M, ME120P, ME120X, ME220M, ME220P, ME220X, MEC24H, MEC40M, MG120M, MG120P, MG120X, MG220M, MG220P, MG220X, MGC20X, MGC24H, MGC40H, VE120M, VE120P, VE120X, VE220M, VE220P, VE220X, VG120M, VG120P, VG120X, VG220M, VG220P, VG220X		



1

<b>Part No.</b>	690097	<b>Ref. No.</b>	R10201290
<b>description</b>	door hinge mounting pos. upper		
<b>For models:</b>	ME106M, ME106P, ME106X, ME110M, ME110P, ME110X, ME120M, ME120P, ME120X, ME210M, ME210P, ME210X, MG106M, MG106P, MG106X, MG110M, MG110P, MG110X, MG120M, MG120P, MG120X, MG210M, MG210P, MG210X, MGC20X, VE106M, VE106P, VE106X, VE110M, VE110X, VE120M, VE120P, VE120X, VE210M, VE210P, VE210X, VG106M, VG106P, VG106X, VG110M, VG110P, VG110X, VG120M, VG120P, VG120X, VG210M, VG210P, VG210X		



1

<b>Part No.</b>	691287	<b>Ref. No.</b>	R18404500
<b>description</b>	hinge		
<b>For models:</b>	MACE07M, MACE10M, MACE20M, MACG07M, MACG10M, MACG20M		



1

<b>Part No.</b>	691284	<b>Ref. No.</b>	LA58001760 LAR58001760
<b>description</b>	hinge for glass plate		
<b>For models:</b>	GMT06D, GMT20D, GVT06D, GVT20D, MACE07M, MACE10M, MACE20M, MACG07M, MACG10M, MACG20M, ME061D, ME061M, ME061P, ME061T, ME101D, ME101M, ME101P, ME101T, ME102D, ME102M, ME102P, ME102T, ME201D, ME201M, ME201P, ME201T, ME202D, ME202M, ME202P, ME202T, MEMT06D, MEMT06P, MEMT10D, MEMT10P, MEMT20D, MEMT20P, MEMT21D, MEMT21P, MEMT40D, MEMT40P, MEVT06D, MEVT06P, MEVT10D, MEVT10P, MEVT20D, MEVT20P, MEVT21D, MEVT21P, MEVT40D, MEVT40P... (Other models you can see in the webshop)		



1

<b>Part No.</b>	691277	<b>Ref. No.</b>	R18201270
<b>description</b>	hinge mounting pos. bottom left		
<b>For models:</b>	MACE04M, MACE05M, MACG05M, MVE042P, MVE051P, MVG051P		



1

<b>Part No.</b>	690587	<b>Ref. No.</b>	R11200550 R11200551
<b>description</b>	hinge bearing mounting pos. lower with bolt		
<b>For models:</b>	ME061M, ME061P, ME061T, ME101M, ME101P, ME101T, ME102M, ME102P, ME102T, MG061M, MG061P, MG061T, MG101M, MG101P, MG101T, MG102M, MG102P, MG102T		



1

<b>Part No.</b>	690096	<b>Ref. No.</b>	R10201190
<b>description</b>	hinge bearing mounting pos. lower without bolt		
<b>For models:</b>	ME106M, ME106P, ME106X, ME110M, ME110P, ME110X, ME210M, ME210P, ME210X, MG106M, MG106P, MG106X, MG110M, MG110P, MG110X, MG210M, MG210P, MG210X, VE106M, VE106P, VE106X, VE110M, VE110X, VE210M, VE210P, VE210X, VG106M, VG106P, VG106X, VG110M, VG110P, VG110X, VG120M, VG120P, VG120X, VG210M, VG210P, VG210X		



1

<b>Part No.</b>	691276	<b>Ref. No.</b>	R18201260
<b>description</b>	hinge bearing mounting pos. upper left		
<b>For models:</b>	MACE04M, MACE05M, MACG05M, MVE042P, MVE051P, MVG051P		



1

<b>Part No.</b>	690586	<b>Ref. No.</b>	LA11426830 R11200560
<b>description</b>	hinge bearing mounting pos. upper left without bolt		
<b>For models:</b>	GMT06D, GMT20D, GVT06D, GVT20D, MACE07M, MACE10M, MACE20M, MACG07M, MACG10M, MACG20M, ME061D, ME061M, ME061P, ME061T, ME101D, ME101M, ME101P, ME101T, ME102D, ME102M, ME102P, ME102T, ME201D, ME201M, ME201P, ME201T, ME202D, ME202M, ME202P, ME202T, MEMT06D, MEMT06P, MEMT10D, MEMT10P, MEMT20D, MEMT20P, MEMT21D, MEMT21P, MEMT40D, MEMT40P, MEVT06D, MEVT06P, MEVT10D, MEVT10P, MEVT20D, MEVT20P, MEVT21D, MEVT21P, MEVT40D, MEVT40P... (Other models you can see in the webshop)		



1

<b>Part No.</b>	514524	<b>Ref. No.</b>	LA11207240 LAR11207240
<b>description</b>	hinge bearing without bolt for combi-steamer mounting pos. bottom left		
<b>For models:</b>	GMT20D, GVT06D, GVT20D		



1

<b>Part No.</b>	691285	<b>Ref. No.</b>	LA58001770 LAR58001770
<b>description</b>	hinge bolt		
<b>For models:</b>	GMT06D, GMT20D, GVT06D, GVT20D, MACE07M, MACE10M, MACE20M, MACG07M, MACG10M, MACG20M, ME061D, ME061M, ME061P, ME061T, ME101D, ME101M, ME101P, ME101T, ME102D, ME102M, ME102P, ME102T, ME201D, ME201M, ME201P, ME201T, ME202D, ME202M, ME202P, ME202T, MEMT06D, MEMT06P, MEMT10D, MEMT10P, MEMT20D, MEMT20P, MEMT21D, MEMT21P, MEMT40D, MEMT40P, MEVT06D, MEVT06P, MEVT10D, MEVT10P, MEVT20D, MEVT20P, MEVT21D, MEVT21P, MEVT40D, MEVT40P... (Other models you can see in the webshop)		



1

<b>Part No.</b>	690099	<b>Ref. No.</b>	LA58002150 LAR58002150
<b>description</b>	hinge pin mounting pos. upper for door		
<b>For models:</b>	EC106M, EC110M, EC210M, EM010M+SC, EM106H, EM106M, EM106M+SC, EM106P, EM110H, EM110M, EM110M+SC, EM110P, EM210H, EM210M, EM210M+SC, EM210P, EV006M, EV106H, EV106M, EV106M+SC, EV106P, EV110H, EV110M, EV110M+SC, EV110P, EV210H, EV210M, EV210M+SC, EV210P, GC106M, GC110M, GC210M, GM106H, GM106M, GM106M+SC, GM106P, GM110H, GM110M, GM110M+SC, GM110P, GM210H, GM210M, GM210M+SC, GM210P, GMT06D, GMT20D, GV106H, GV106M, GV106M+SC, GV106P...(Other models you can see in the webshop)		

## accessories

## miscellaneous



1

<b>Part No.</b>	690595	<b>Ref. No.</b>	LA58002550 LAR58002550
<b>description</b>	bush for door hinge		
<b>For models:</b>	ME120M, ME120P, ME120X, ME201D, ME201M, ME201P, ME201T, ME202D, ME202M, ME202P, ME202T, ME220M, ME220P, ME220X, MEC24H, MEC40M, MEMT21D, MEMT21P, MEMT40D, MEMT40P, MEVT21D, MEVT21P, MEVT40D, MEVT40P, MG120M, MG120P, MG120X, MG201D, MG201M, MG201P, MG201T, MG202D, MG202M, MG202P, MG202T, MG220M, MG220P, MG220X, MGC20X, MGC24H, MGC40H, MGMT21D, MGMT21P, MGMT40D, MGMT40P, MGVT21D, MGVT21P, MGVT40D, MGVT40P, VE120M...(Other models you can see in the webshop)		



1

<b>Part No.</b>	690592	<b>Ref. No.</b>	LAR58002540
<b>description</b>	pin for hinge		
<b>For models:</b>	ME120M, ME120P, ME120X, ME201D, ME201M, ME201P, ME201T, ME202D, ME202M, ME202P, ME202T, ME220M, ME220P, ME220X, MEC24H, MEC40M, MEMT21D, MEMT21P, MEMT40D, MEMT40P, MEVT21D, MEVT21P, MEVT40D, MEVT40P, MG120M, MG120P, MG120X, MG201D, MG201M, MG201P, MG201T, MG202D, MG202M, MG202P, MG202T, MG220M, MG220P, MG220X, MGC20X, MGC24H, MGC40H, MGMT21D, MGMT21P, MGMT40D, MGMT40P, MGVT21D, MGVT21P, MGVT40D, MGVT40P, VE120M...(Other models you can see in the webshop)		



 <p>1</p>			
<b>Part No.</b>	690593	<b>Ref. No.</b>	LA58002570 LAR58002570
<b>description</b>	plain washer ID ø 15mm ED ø 30mm thickness 3mm Qty 1 pcs for door hinge		
<b>For models:</b>	ME120M, ME120P, ME120X, ME201D, ME201M, ME201P, ME201T, ME202D, ME202M, ME202P, ME202T, ME220M, ME220P, ME220X, MEC24H, MEC40M, MEMT21D, MEMT21P, MEMT40D, MEMT40P, MEVT21D, MEVT21P, MEVT40D, MEVT40P, MG120M, MG120P, MG120X, MG201D, MG201M, MG201P, MG201T, MG202D, MG202M, MG202P, MG202T, MG220M, MG220P, MG220X, MGC20X, MGC24H, MGC40H, MGMT21D, MGMT21P, MGMT40D, MGMT40P, MGVT21D, MGVT21P, MGVT40D, MGVT40P, VE120M...(Other models you can see in the webshop)		

 <p>1</p>			
<b>Part No.</b>	690594	<b>Ref. No.</b>	LA58002560 LAR58002560
<b>description</b>	pressure screw for door hinge		
<b>For models:</b>	ME120M, ME120P, ME120X, ME201D, ME201M, ME201P, ME201T, ME202D, ME202M, ME202P, ME202T, ME220M, ME220P, ME220X, MEC24H, MEC40M, MEMT21D, MEMT21P, MEMT40D, MEMT40P, MEVT21D, MEVT21P, MEVT40D, MEVT40P, MG120M, MG120P, MG120X, MG201D, MG201M, MG201P, MG201T, MG202D, MG202M, MG202P, MG202T, MG220M, MG220P, MG220X, MGC20X, MGC24H, MGC40H, MGMT21D, MGMT21P, MGMT40D, MGMT40P, MGVT21D, MGVT21P, MGVT40D, MGVT40P, VE120M...(Other models you can see in the webshop)		

## pullouts

### rollers

### rollers

### accessories

 <p>1</p>			
<b>Part No.</b>	560133	<b>Ref. No.</b>	260404
<b>description</b>	hexagonal nut thread M6 H 5mm WS 10 SS DIN/ISO DIN 934 / ISO 4032/8673 Qty 20 pcs		

## fittings for catering equipment

### outlet taps

### producer-specific

### MARENO

 <p>1</p>			
<b>Part No.</b>	540658	<b>Ref. No.</b>	1450500 MA1450500
<b>description</b>	ball valve connection 3/4" IT - 3/4" IT DN20 total length 69mm		
<b>For models:</b>	CP704E, CP704G, CP92E, CP92E2, CP92G, CP94E, CP94E2, CP94G, CP9SB2E, CP9SB2E2, CP9SB2G, CP9SB4E, CP9SB4E2, CP9SB4G, CPE40, CPE402, CPE60, CPE602, CPE60DB, F74E10, F74E6, F76E10, F94E10, F94E6, F96E10, FR74E, FR74E10, FR74E10L, FR74E10L2, FR74G, FR77E, FR77E10, FR77E10L, FR77E10L2, FR77G, FR92E10, FR92E10L, FR92E10L2, FR92E13, FR92E22, FR92G22, FR94E10, FR94E10L, FR94E10L2, FR94E13, FR94E22, FR94G23, FR9P2E10, FR9P4E10, NF74E10...(Other models you can see in the webshop)		

 <p>1</p>			
<b>Part No.</b>	514099	<b>Ref. No.</b>	1515900 MA1515900
<b>description</b>	centring piece L 20mm for extension thread ID ø 10mm D1 ø 18mm D2 ø 20mm		
<b>For models:</b>	CP92E, CP92E2, CP92G, CP94E, CP94E2, CP94G, CP9SB2E, CP9SB2E2, CP9SB2G, CP9SB4E, CP9SB4E2, CP9SB4G, EPC74E, EPC74G, NPC74E, NPC74G, NPC76E, NPC76G, NPC78E, NPC78G, NPC94E, NPC94G, NPC98E, NPC98G, PC12C4E, PC12C4G, PC12C9E, PC12C9G, PC74E, PC74G, PC76E, PC76G, PC78E, PC78G, PC94E, PC94G, PC96E, PC96G, PC98E, PC98G, PC9S4E, PC9S4G, PC9S6E, PC9S6G, PC9S8E, PC9S8G		

## DERBY RUOTE

### with bolt hole

### chrome-plated steel

 <p>1</p>			
<b>Part No.</b>	700201 <sup>1</sup>	<b>Ref. No.</b>	30700699
<b>description</b>	swivel castor with swivel brake ø 100mm bolt hole bolt hole ø 12mm housing chrome-plated sheet steel capacity 80kg bearing ball bearing wheel body polypropylene tread TPE tyres H 132mm wheel width 30mm Qty 1 pcs		
<b>For models:</b>	CB3, CB5, CD24		

<sup>1</sup>with swivel brake



spare parts and accessories

miscellaneous



<b>Part No.</b>	560193	<b>Ref. No.</b>	15812699 MA15812699
<b>description</b>	tooth lock washer ID ø 10.4mm ED ø 18mm zinc-coated steel DIN/ISO DIN 6798A Qty 1 pcs for thread M10		
<b>For models:</b>	CPE60, CPE60Z, CPE60DB, OCP66, OCP60		

TENTE

with fixing plate

stainless steel



<b>Part No.</b>	701624	<b>Ref. No.</b>	R69090100
<b>description</b>	swivel castor with swivel brake ø 125mm plate fixing housing stainless steel plate size 105x85mm hole distance 78x60mm capacity 200kg bearing slide bearing wheel body polyamide tread polyurethane H 155mm wheel width 32mm		
<b>For models:</b>	ME201D, ME201M, ME201P, ME201T, ME202D, ME202M, ME202T, MEMENT21D, MEMENT21P, MEMENT40D, MEMENT40P, MEVT21D, MEVT21P, MEVT40D, MEVT40P, MG201D, MG201M, MG201P, MG201T, MG202D, MG202M, MG202P, MG202T, MGMT21D, MGMT21P, MGMT40D, MGMT40P, MGMT21D, MGMT21P, MGMT40D, MGMT40P		



<b>Part No.</b>	701622	<b>Ref. No.</b>	R69090090
<b>description</b>	swivel castor without brake ø 125mm plate fixing housing stainless steel plate size 105x85mm hole distance 78x60mm capacity 200kg bearing slide bearing wheel body polyamide tread polyurethane H 155mm wheel width 32mm		
<b>For models:</b>	ME201D, ME201M, ME201P, ME201T, ME202D, ME202M, ME202P, ME202T, MEMENT21D, MEMENT21P, MEMENT40D, MEMENT40P, MEVT21D, MEVT21P, MEVT40D, MEVT40P, MG201D, MG201M, MG201P, MG201T, MG202D, MG202M, MG202P, MG202T, MGMT21D, MGMT21P, MGMT40D, MGMT40P, MGMT21D, MGMT21P, MGMT40D, MGMT40P		

shelves and shelf rails

grates

universal

with upstand

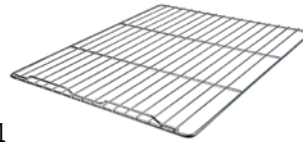

<b>Part No.</b>	970527	<b>Ref. No.</b>	2306800 MA2306800
<b>description</b>	grate W 530mm D 650mm GN 2/1 chrome-plated steel with hinge camp crossing wires 2 suitable for refrigerator		
<b>For models:</b>	AF140B, AF140C, AF140F, AF140I, AF140MB, AF140MC, AF140MF, AF140MI, AF140MN, AF140MP, AF140N, AF140P, AF70B, AF70C, AF70F, AF70I, AF70MB, AF70MC, AF70MF, AF70MI, AF70MN, AF70MP, AF70N, AF70P, AFR1143P, AFR1143PE, BF78G, BF912G, BF912GH, BF98G, C7FG12G, C7FG8G, C9F4GS, C9F6E, C9F6GS, C9F8GS, C9FE6GS, C9FG12G, C9FG16G, C9FG8G, C9FG8GP, C9FGM12G, EF140DF, EF-140DN, EF140DP, EF140MB, EF140MC, EF140MF, EF140MI, EF140MN... (Other models you can see in the webshop)		
<b>accessories for</b>	970527		
	<b>Part No.</b>	690330	<b>Ref. No.</b> —
	rack L 1000mm W 22mm H 4mm aperture 3x8mm hole distance 12.5mm stainless steel		
	<b>Part No.</b>	694700	<b>Ref. No.</b> —
	shelf support L 31/28mm W 22mm H 18mm SS Qty 12 pcs		
	<b>Part No.</b>	694701	<b>Ref. No.</b> —
	shelf support L 31/28mm W 22mm H 17mm SS with hook Qty 12 pcs		

gaskets

gaskets for heated units

window seals

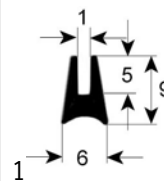

<b>Part No.</b>	900787	<b>Ref. No.</b>	R70044650
<b>description</b>	window gasket profile 1515 L 2200mm suitable for LAINOX		
<b>For models:</b>	MACE07M, MACG07M		

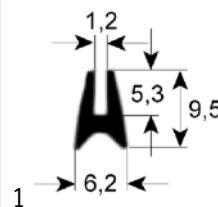

<b>Part No.</b>	900129	<b>Ref. No.</b>	R70040840
<b>description</b>	window gasket profile 1530 L 1015mm Qty 1		
<b>For models:</b>	ME110M, ME110P, ME110X, ME210M, ME210P, ME210X, MG110M, MG110P, MG110X, MG210M, MG210P, MG210X, VE110M, VE110X, VE210M, VE210P, VE210X, VG110M, VG110P, VG110X, VG210M, VG210P, VG210X		





<b>Part No.</b>	900501	<b>Ref. No.</b>	R70044260
<b>description</b>	window gasket profile 1530 L 1200mm Qty 1		
<b>For models:</b>	MACE10M, MACE20M, MACG10M, MACG20M, ME101D, ME101M, ME101P, ME101T, ME102M, ME102P, ME102T, MG101D, MG101M, MG101P, MG101T, MG102M, MG102P, MG102T		

<b>Part No.</b>	900483	<b>Ref. No.</b>	R70044150
<b>description</b>	window gasket profile 1530 L 2400mm Qty 1		
<b>For models:</b>	GMT20D, GVT20D, MACE10M, MACE20M, MACG10M, MACG20M, ME061D, ME061M, ME061P, ME061T, ME101D, ME101M, ME101P, ME101T, ME102D, ME102M, ME102P, ME102T, MEMENT20D, MEMENT20P, MEVT20D, MEVT20P, MG061D, MG061M, MG061P, MG061T, MG101D, MG101M, MG101P, MG101T, MG102D, MG102M, MG102P, MG102T, MGMT20D, MGMT20P, MGVT20D, MGVT20P		

<b>Part No.</b>	900130	<b>Ref. No.</b>	R70040850
<b>description</b>	window gasket profile 1530 L 1750mm Qty 1		
<b>For models:</b>	ME120M, ME120P, ME120X, ME220M, ME220P, ME220X, MEC40M, MG120M, MG120P, MG120X, MG220M, MG220P, MG220X, MGC20X, MGC40H, VE120M, VE120P, VE120X, VE220M, VE220P, VE220X, VG120M, VG120P, VG120X, VG220M, VG220P, VG220X		

<b>Part No.</b>	900484	<b>Ref. No.</b>	R70044160
<b>description</b>	window gasket profile 1530 L 3720mm Qty 1		
<b>For models:</b>	ME201D, ME201M, ME201P, ME201T, ME202D, ME202M, ME202P, ME202T, MEMENT40D, MEMENT40P, MEVT40D, MEVT40P, MG201D, MG201M, MG201P, MG201T, MG202D, MG202M, MG202P, MG202T, MGMT40D, MGMT40P, MGVT40D, MGVT40P		

<b>Part No.</b>	900503	<b>Ref. No.</b>	R70044280
<b>description</b>	window gasket profile 1530 L 1800mm Qty 1		
<b>For models:</b>	ME201D, ME201M, ME201P, ME201T, MG201D, MG201M, MG201P, MG201T		

<b>Part No.</b>	900117	<b>Ref. No.</b>	R70040810
<b>description</b>	window gasket profile 1530 L 505mm Qty 1		
<b>For models:</b>	CVE004H, CVE004M, CVE104H, CVE104M, VE004M, VE004X, VE104M, VE104X		

<b>Part No.</b>	900504	<b>Ref. No.</b>	R70044290
<b>description</b>	window gasket profile 1530 L 1950mm Qty 1		
<b>For models:</b>	ME202D, ME202M, ME202P, ME202T, MEMENT21D, MEMENT21P, MEMENT40D, MEMENT40P, MEVT21D, MEVT21P, MEVT40D, MEVT40P, MG202D, MG202M, MG202P, MG202T, MGMT21D, MGMT21P, MGMT40D, MGMT40P, MGVT21D, MGVT21P, MGVT40D, MGVT40P		

<b>Part No.</b>	900118	<b>Ref. No.</b>	R70040820
<b>description</b>	window gasket profile 1530 L 595mm Qty 1		
<b>For models:</b>	CVE105H, CVE105M, CVG105H, CVG105M, VE105M, VE105X, VG105M, VG105X		

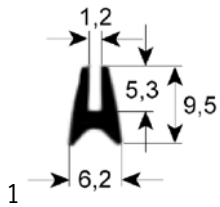

<b>Part No.</b>	900128	<b>Ref. No.</b>	R70040830
<b>description</b>	window gasket profile 1530 L 750mm Qty 1		
<b>For models:</b>	ME106M, ME106P, ME106X, MG106M, MG106P, MG106X, VE106M, VE106P, VE106X, VG106M, VG106P, VG106X		

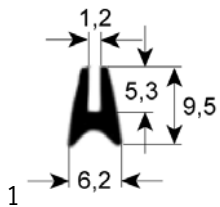

<b>Part No.</b>	900500	<b>Ref. No.</b>	R70044250
<b>description</b>	window gasket profile 1530 L 900mm Qty 1		
<b>For models:</b>	MACE07M, MACG07M, ME061D, ME061M, ME061P, ME061T, MG061D, MG061M, MG061P, MG061T, MVE042P, MVE051P, MVG051P		

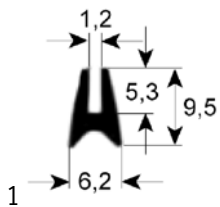

<b>Part No.</b>	900637	<b>Ref. No.</b>	R70040640
<b>description</b>	window gasket profile 1530 Qty supplied by meter		
<b>For models:</b>	FE110M, FE110X, FE210M, FG110M, FG110X, FG210M, FG210X, MEMT10D, MEMT10P, MEVT10D, MEVT10P, MGMT10D, MGMT10P, MGVT10D, MGVT10P, PE080M, PE080X, PG080M, PG080X		

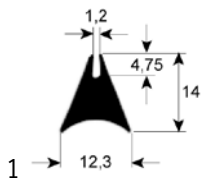

<b>Part No.</b>	900120	<b>Ref. No.</b>	R70040050
<b>description</b>	window gasket profile 1620 L 1175mm Qty 1		
<b>For models:</b>	CVE004H, CVE004M, CVE104H, CVE104M, VE004M, VE004X, VE104M, VE104X		

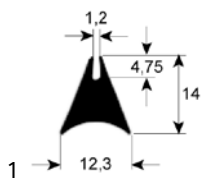

<b>Part No.</b>	900119	<b>Ref. No.</b>	R70040010
<b>description</b>	window gasket profile 1620 L 1500mm Qty 1		
<b>For models:</b>	CVE105H, CVE105M, CVG105H, CVG105M, VE105M, VE105X, VG105M, VG105X		

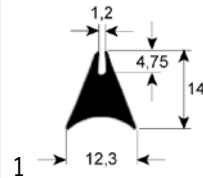

<b>Part No.</b>	900121	<b>Ref. No.</b>	R70040080
<b>description</b>	window gasket profile 1620 L 1690mm Qty 1		
<b>For models:</b>	ME106M, ME106P, ME106X, MG106M, MG106P, MG106X, VE106M, VE106P, VE106X, VG106M, VG106P, VG106X		

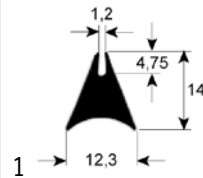

<b>Part No.</b>	900122	<b>Ref. No.</b>	R70040200
<b>description</b>	window gasket profile 1620 L 2125mm Qty 1		
<b>For models:</b>	ME110M, ME110P, ME110X, ME120M, ME120P, ME120X, ME210M, ME210P, ME210X, ME220M, ME220P, ME220X, MEC24H, MEC40M, MG110M, MG110P, MG110X, MG120M, MG120P, MG120X, MG210M, MG210P, MG210X, MG220M, MG220P, MG220X, MGC20X, MGC24H, MGC40H, VE110M, VE110X, VE120M, VE120P, VE120X, VE210M, VE210P, VE210X, VE220M, VE220P, VE220X, VG110M, VG110P, VG110X, VG120M, VG120P, VG120X, VG210M, VG210P, VG210X, VG220M... (Other models you can see in the webshop)		

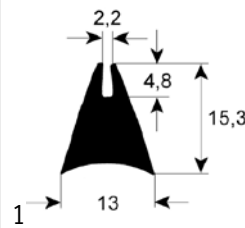

<b>Part No.</b>	900437	<b>Ref. No.</b>	2838000 MA2838000
<b>description</b>	window gasket profile 1640 L 10000mm Qty 1		
<b>For models:</b>	CSM201, CSM202, SER15, SER15A, SER18, SER18A, SER21		

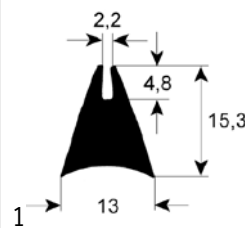

<b>Part No.</b>	900436	<b>Ref. No.</b>	2891700
<b>description</b>	window gasket profile 1640 L 2170mm Qty 1		
<b>For models:</b>	CON102E, CON102EP, CON102G, CON102GP, CON10E, CON10EP, CON10G, CON10GP, CS102E, CS102EP, CS102G, CS102GP, CSM102E, CSM102EP, CSM102G, CSM102GP, CSM10E, CSM10EP, CSM10G, CSM10GP		



<b>Part No.</b>	900435	<b>Ref. No.</b>	2885800
<b>description</b>	window gasket profile 1640 L 2350mm Qty 1		
<b>For models:</b>	CON6E, CON6EP, CON6G, CON6GP, CSM6E, CSM6EP, CSM6G, CSM6GP		

<b>Part No.</b>	902460	<b>Ref. No.</b>	LAR70042680
<b>description</b>	window gasket profile 1887 L 3200mm Qty 1 suitable for LAINOX		
<b>For models:</b>	EC210M, EM210H, EM210M, EM210M+SC, EM210P, EV210H, EV210M, EV210M+SC, EV210P, GC210M, GM210H, GM210M, GM210M+SC, GM210P, GV210H, GV210M, GV210M+SC, GV210P		

<b>Part No.</b>	902459	<b>Ref. No.</b>	R70042770 R70042780
<b>description</b>	window gasket profile 1887/1515 L 2200mm suitable for LAINOX set 2-piece		
<b>For models:</b>	EC110M, EC210M, EM010M+SC, EM110H, EM110M, EM110M+SC, EM110P, EM210H, EM210M, EM210M+SC, EM210P, EV110H, EV110M, EV110M+SC, EV110P, EV210H, EV210M, EV210M+SC, EV210P, GC110M, GC210M, GM110H, GM110M, GM110M+SC, GM110P, GM210H, GM210M, GM210M+SC, GM210P, GV110H, GV110M, GV-110M+SC, GV110P, GV210H, GV210M, GV210M+SC, GV210P		

**door seals**

<b>Part No.</b>	902461	<b>Ref. No.</b>	R70042860
<b>description</b>	door seal profile 2010 L 1900mm Qty 1 suitable for LAINOX		
<b>For models:</b>	EC106M, EM106H, EM106M, EM106M+SC, EM106P, EV006M, EV106H, EV106M, EV106M+SC, EV106P, GC106M, GM106H, GM106M, GM106M+SC, GM106P, GV106H, GV106M, GV106M+SC, GV106P		

<b>Part No.</b>	901147	<b>Ref. No.</b>	R70042880
<b>description</b>	door seal profile 2010 L 3000mm Qty 1		
<b>For models:</b>	EC210M, EM210H, EM210M, EM210M+SC, EM210P, EV210H, EV210M, EV210M+SC, EV210P, GC210M, GM210H, GM210M, GM210M+SC, GM210P, GV210H, GV210M, GV210M+SC, GV210P		

<b>Part No.</b>	900142	<b>Ref. No.</b>	R70043280 R70043290
<b>description</b>	door seal profile 2010 Qty supplied by meter		
<b>For models:</b>	MEC24H, MGC20X, MGC24H		

<b>Part No.</b>	900131	<b>Ref. No.</b>	R70040980
<b>description</b>	door seal profile 2010 W 520mm L 610mm external size Qty 1		
<b>For models:</b>	ME106M, ME106P, ME106X, MG106M, MG106P, MG106X, VE106M, VE106P, VE106X, VG106M, VG106P, VG106X		

<b>Part No.</b>	900132	<b>Ref. No.</b>	R70040990
<b>description</b>	door seal profile 2010 W 625mm L 750mm external size Qty 1		
<b>For models:</b>	ME110M, ME110P, ME110X, MG110M, MG110P, MG110X, VE110M, VE110X, VG110M, VG110P, VG110X		

<b>Part No.</b>	900134	<b>Ref. No.</b>	R70041010
<b>description</b>	door seal profile 2010 W 680mm L 1425mm external size Qty 1		
<b>For models:</b>	ME120M, ME120P, ME120X, MG120M, MG120P, MG120X, VE120M, VE120P, VE120X, VG120M, VG120P, VG120X		

<b>Part No.</b>	900135	<b>Ref. No.</b>	R70041020
<b>description</b>	door seal profile 2010 W 700mm L 1410mm external size Qty 1		
<b>For models:</b>	ME220M, ME220P, ME220X, MG220M, MG220P, MG220X, VE220M, VE220P, VE220X, VG220M, VG220P, VG220X		

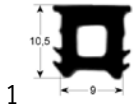

<b>Part No.</b>	900133	<b>Ref. No.</b>	R70041000
<b>description</b>	door seal profile 2010 W 740mm L 765mm external size Qty 1		
<b>For models:</b>	ME210M, ME210P, ME210X, MG210M, MG210P, MG210X, VE210M, VE210P, VE210X, VG210M, VG210P, VG210X		

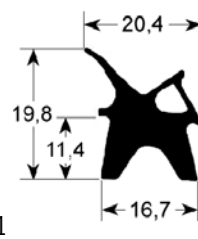

<b>Part No.</b>	900818	<b>Ref. No.</b>	R70042570
<b>description</b>	door seal profile 2410 W 465mm L 765mm external size Qty 1		
<b>For models:</b>	EC110M, EM010M+SC, EM110H, EM110M, EM110M+SC, EM110P, EV110H, EV110M, EV110M+SC, EV110P, GC110M, GM110H, GM110M, GM110M+SC, GM110P, GV110H, GV110M, GV110M+SC, GV110P		

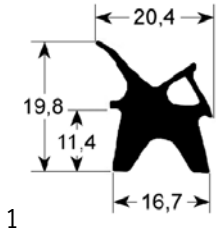

<b>Part No.</b>	900115	<b>Ref. No.</b>	R70041990
<b>description</b>	door seal profile 2410 W 320mm L 420mm external size Qty 1		
<b>For models:</b>	CVE004H, CVE004M, CVE104H, CVE104M, VE004M, VE004X, VE104M, VE104X		

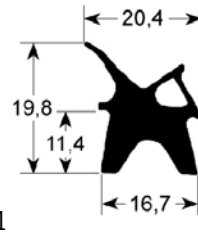

<b>Part No.</b>	900123	<b>Ref. No.</b>	R70042010
<b>description</b>	door seal profile 2410 W 500mm L 627mm external size Qty 1		
<b>For models:</b>	ME106M, ME106P, ME106X, MG106M, MG106P, MG106X, VE106M, VE106P, VE106X, VG106M, VG106P, VG106X		

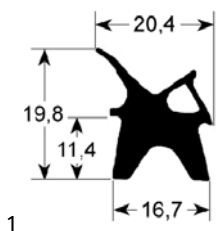

<b>Part No.</b>	900116	<b>Ref. No.</b>	R70042000
<b>description</b>	door seal profile 2410 W 380mm L 608mm external size Qty 1		
<b>For models:</b>	CVE105H, CVE105M, CVG105H, CVG105M, VE105M, VE105X, VG105M, VG105X		

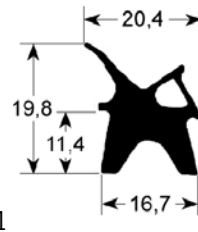

<b>Part No.</b>	900124	<b>Ref. No.</b>	R70042020
<b>description</b>	door seal profile 2410 W 627mm L 738mm external size Qty 1		
<b>For models:</b>	ME110M, ME110P, ME110X, MG110M, MG110P, MG110X, VE110M, VE110X, VG110M, VG110P, VG110X		

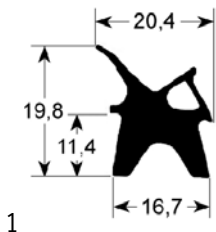

<b>Part No.</b>	900157	<b>Ref. No.</b>	R70041540
<b>description</b>	door seal profile 2410 W 380mm L 632mm external size Qty 1		
<b>For models:</b>	FE105M, FE105X, FG105M, FG105X, PE040M, PE040X, PG040M, PG040X		

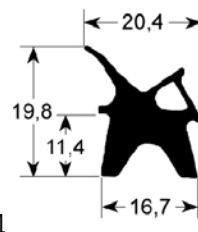

<b>Part No.</b>	900820	<b>Ref. No.</b>	LAR70042580
<b>description</b>	door seal profile 2410 W 645mm L 765mm external size Qty 1		
<b>For models:</b>	EC210M, EM210H, EM210M, EM210M+SC, EM210P, EV210H, EV210M, EV210M+SC, EV210P, GC210M, GM210H, GM210M, GM210M+SC, GM210P, GV210H, GV210M, GV210M+SC, GV210P		

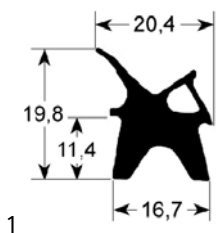

<b>Part No.</b>	900817	<b>Ref. No.</b>	R70042560
<b>description</b>	door seal profile 2410 W 465mm L 495mm external size Qty 1		
<b>For models:</b>	EC106M, EM106H, EM106M, EM106M+SC, EM106P, EV006M, EV106H, EV106M, EV106M+SC, EV106P, GC106M, GM106H, GM106M, GM106M+SC, GM106P, GV106H, GV106M, GV106M+SC, GV106P		



1			
<b>Part No.</b>	900486	<b>Ref. No.</b>	R70041550
<b>description</b>	door seal profile 2410 W 666mm L 701mm external size Qty 1		
<b>For models:</b>	FE110M, FE110X, FG110M, FG110X, PE080M, PE080X, PG080M, PG080X		

1			
<b>Part No.</b>	900762	<b>Ref. No.</b>	R70041350
<b>description</b>	door seal profile 2410 W 701mm L 705mm external size Qty 1		
<b>For models:</b>	FE210M, FG210M, FG210X		

1			
<b>Part No.</b>	900568	<b>Ref. No.</b>	R70042150
<b>description</b>	door seal profile 2410 W 710mm L 1310mm external size Qty 1		
<b>For models:</b>	MGC20X		

1			
<b>Part No.</b>	900126	<b>Ref. No.</b>	R70042040
<b>description</b>	door seal profile 2410 W 710mm L 1430mm external size Qty 1		
<b>For models:</b>	ME120M, ME120P, ME120X, MG120M, MG120P, MG120X, VE120M, VE120P, VE120X, VG120M, VG120P, VG120X		

1			
<b>Part No.</b>	900813	<b>Ref. No.</b>	R70042160
<b>description</b>	door seal profile 2410 W 735mm L 1310mm external size Qty 1		
<b>For models:</b>	MEC40M, MGC40H		

1			
<b>Part No.</b>	900127	<b>Ref. No.</b>	R70042050
<b>description</b>	door seal profile 2410 W 735mm L 1430mm external size Qty 1		
<b>For models:</b>	ME220M, ME220P, ME220X, MG220M, MG220P, MG220X, VE220M, VE220P, VE220X, VG220M, VG220P, VG220X		

1			
<b>Part No.</b>	900815	<b>Ref. No.</b>	R70041940
<b>description</b>	door seal profile 2410 W 735mm L 830mm external size Qty 1		
<b>For models:</b>	MEC24H, MGC24H		

1			
<b>Part No.</b>	900125	<b>Ref. No.</b>	R70042030
<b>description</b>	door seal profile 2410 W 738mm L 777mm external size Qty 1		
<b>For models:</b>	ME210M, ME210P, ME210X, MG210M, MG210P, MG210X, VE210M, VE210P, VE210X, VG210M, VG210P, VG210X		

1			
<b>Part No.</b>	900722	<b>Ref. No.</b>	2725600 MA2725600
<b>description</b>	door seal profile 2440 W 415mm L 580mm external size Qty 1		
<b>For models:</b>	FC10G, FC5E, FC5G, FC7G		



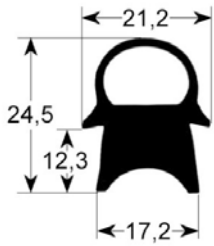

1

<b>Part No.</b>	900106	<b>Ref. No.</b>	2885900 MA2885900
<b>description</b>	door seal profile 2440 W 490mm L 645mm external size Qty 1		
<b>For models:</b>	CON6G, CON6GP, CSM6E, CSM6EP, CSM6G, CSM6GP		

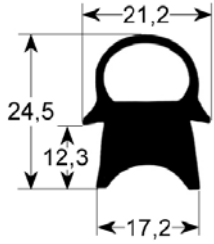

1

<b>Part No.</b>	900724	<b>Ref. No.</b>	2725700 MA2725700
<b>description</b>	door seal profile 2440 W 530mm L 580mm external size Qty 1		
<b>For models:</b>	FC7E, FC7G		

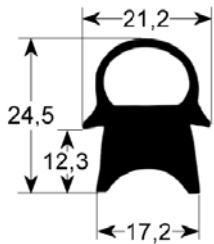

1

<b>Part No.</b>	900107	<b>Ref. No.</b>	2891900 MA2891900
<b>description</b>	door seal profile 2440 W 645mm L 740mm external size Qty 1		
<b>For models:</b>	CON102E, CON102EP, CON102G, CON102GP, CON10E, CON10EP, CON10G, CON10GP, CS102E, CS102EP, CS102G, CS102GP, CSM102E, CSM102EP, CSM102G, CSM102GP, CSM10E, CSM10EP, CSM10G, CSM10GP		

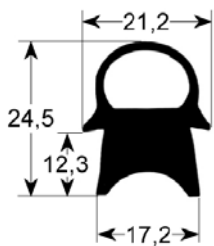

1

<b>Part No.</b>	900108	<b>Ref. No.</b>	5113500 MA5113500
<b>description</b>	door seal profile 2440 W 720mm L 1460mm external size Qty 1		
<b>For models:</b>	CSM201, CSM202		

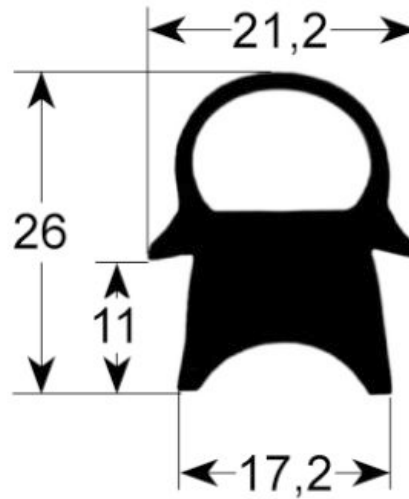

1

<b>Part No.</b>	900769	<b>Ref. No.</b>	2842100 2842114
<b>description</b>	door seal profile 2441 W 340mm L 405mm external size Qty 1		
<b>For models:</b>	CS4E, CS4EP		

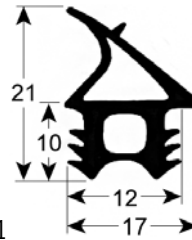

1

<b>Part No.</b>	902023	<b>Ref. No.</b>	LA70048012 LAR70048010
<b>description</b>	door seal profile 2761 W 46mm L 775mm external size Qty 1 suitable for LAINOX		

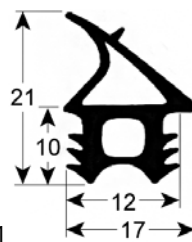

1

<b>Part No.</b>	902024	<b>Ref. No.</b>	LA70048002 LAR70048000
<b>description</b>	door seal profile 2761 W 470mm L 560mm external size Qty 1		

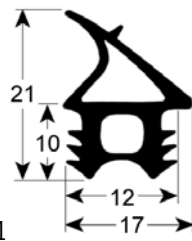

1

<b>Part No.</b>	902153	<b>Ref. No.</b>	LA70044812 LAR70044810
<b>description</b>	door seal profile 2761 W 550mm L 700mm external size Qty 1 suitable for LAINOX		



<b>Part No.</b>	902454	<b>Ref. No.</b>	LA70044882 LAR70044880
<b>description</b>	door seal profile 2761 W 690mm L 775mm outer plug size Qty 1 suitable for LAINOX		

<b>Part No.</b>	902154	<b>Ref. No.</b>	LA70044922 LAR70044920
<b>description</b>	door seal profile 2761 W 700mm L 1510mm external size Qty 1 suitable for LAINOX		

<b>Part No.</b>	901573	<b>Ref. No.</b>	R70044270
<b>description</b>	door seal profile 2770/2771 H 1550mm W 470mm outer plug size Qty 1		
<b>For models:</b>	GMT20D, GVT20D, ME102D, MEMENT20D, MEMENT20P, MEMENT21D, MEMENT21P, MEVT20D, MEVT20P, MEVT21D, MEVT21P, MG102D, MGMT20D, MGMT20P, MGMT21D, MGMT21P, MGVT20D, MGVT20P, MGVT21D, MGVT21P		

1

<b>Part No.</b>	900493	<b>Ref. No.</b>	R70044130
<b>description</b>	door seal profile 2770/2771 H 1550mm W 680mm outer plug size Qty 1		
<b>For models:</b>	ME201D, ME201M, ME201P, ME201T, MG201D, MG201M, MG201P, MG201T		

1

<b>Part No.</b>	900494	<b>Ref. No.</b>	R70044140
<b>description</b>	door seal profile 2770/2771 H 1550mm W 700mm outer plug size Qty 1		
<b>For models:</b>	ME202D, ME202M, ME202P, ME202T, MEMENT40D, MEMENT40P, MEVT40D, MEVT40P, MG202D, MG202M, MG202P, MG202T, MGMT40D, MGMT40P, MGVT40D, MGVT40P		

1

<b>Part No.</b>	900488	<b>Ref. No.</b>	R70044330
<b>description</b>	door seal profile 2770/2771 H 380mm W 420mm outer plug size Qty 1		
<b>For models:</b>	MACE04M, MVE042P		



1

<b>Part No.</b>	900489	<b>Ref. No.</b>	R70044340
<b>description</b>	door seal profile 2770/2771 H 440mm W 600mm outer plug size Qty 1		
<b>For models:</b>	MACE05M, MACG05M, MVE051P, MVG051P		



1

<b>Part No.</b>	900788	<b>Ref. No.</b>	R70044230
<b>description</b>	door seal profile 2770/2771 H 580mm W 680mm outer plug size Qty 1		
<b>For models:</b>	MACE07M, MACG07M		



1

<b>Part No.</b>	901679	<b>Ref. No.</b>	R70044210
<b>description</b>	door seal profile 2770/2771 H 520mm W 470mm outer plug size suitable for LAINOX		
<b>For models:</b>	GMT06D, GVT06D, MEMT06D, MEMT06P, MEVT06D, MEVT06P, MGMT06D, MGMT06P, MGVT06D, MGVT06P		



1

<b>Part No.</b>	901276	<b>Ref. No.</b>	R70044220
<b>description</b>	door seal profile 2770/2771 H 800mm W 470mm outer plug size Qty 1 suitable for LAINOX		
<b>For models:</b>	MEMT10D, MEMT10P, MEVT10D, MEVT10P, MGMT10D, MGMT10P, MGVT10D, MGVT10P		



1

<b>Part No.</b>	900490	<b>Ref. No.</b>	R70044100
<b>description</b>	door seal profile 2770/2771 H 520mm W 620mm outer plug size Qty 1		
<b>For models:</b>	ME061D, ME061M, ME061P, ME061T, MG061D, MG061M, MG061P, MG061T		



1

<b>Part No.</b>	900491	<b>Ref. No.</b>	R70044110
<b>description</b>	door seal profile 2770/2771 H 800mm W 680mm outer plug size Qty 1		
<b>For models:</b>	MACE10M, MACG10M, ME101D, ME101M, ME101P, ME101T, MG101D, MG101M, MG101P, MG101T		



1

<b>Part No.</b>	900492	<b>Ref. No.</b>	R70044120
<b>description</b>	door seal profile 2770/2771 H 800mm W 700mm outer plug size Qty 1		
<b>For models:</b>	GMT20D, GVT20D, ME102D, ME102M, ME102P, MEMT20D, MEMT20P, MEVT20D, MEVT20P, MG102D, MG102M, MG102P, MG102T, MGMT20D, MGMT20P, MGVT20D, MGVT20P		

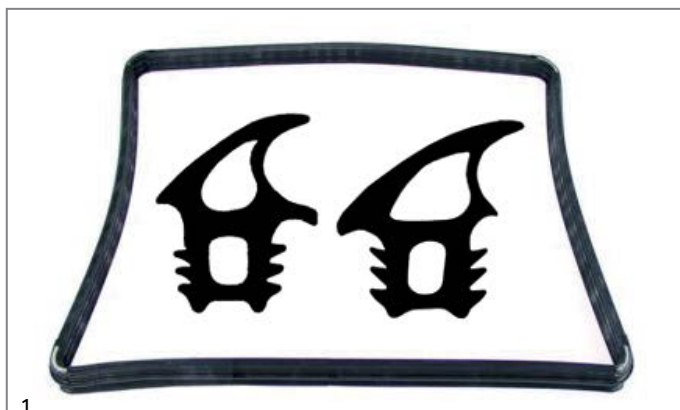

1

<b>Part No.</b>	901603	<b>Ref. No.</b>	R70044240
<b>description</b>	door seal profile 2770/2771 H 800mm W 760mm outer plug size Qty 1		
<b>For models:</b>	MACE20M, MACG20M		

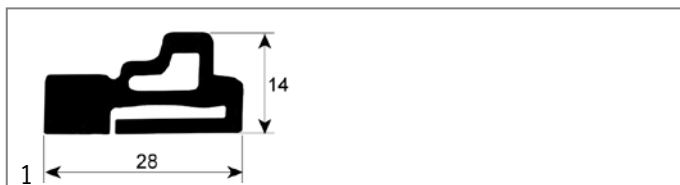

1

<b>Part No.</b>	900745	<b>Ref. No.</b>	R70044300
<b>description</b>	door seal profile 2954 L 700mm		
<b>For models:</b>	ME201D, ME201M, ME201P, ME201T, ME202D, ME202M, ME202P, ME202T, MEMT40D, MEMT40P, MEVT40D, MEVT40P, MG201D, MG201M, MG201P, MG201T, MG202D, MG202M, MG202P, MG202T, MGMT40D, MGMT40P, MGVT40D, MGVT40P		

door seals with fixing hook



1

<b>Part No.</b>	900405	<b>Ref. No.</b>	1036101400 MA1036101400
<b>description</b>	door seal L 430mm W 260mm external size		
<b>For models:</b>	FOE60M, OFOE60M		

gaskets for tray rack trolleys



1

<b>Part No.</b>	901160	<b>Ref. No.</b>	LAR70044360 LAR70044362
<b>description</b>	tray rack trolley gasket L <700mm 3-piece		



1

<b>Part No.</b>	901161	<b>Ref. No.</b>	LA80100910 LAR80100910
<b>description</b>	tray rack trolley gasket L 1000mm		





<b>Part No.</b>	900776	<b>Ref. No.</b>	R70041150
<b>description</b>	tray rack trolley gasket profile 4050 L 1020mm Qty 1		
<b>For models:</b>	MEC24H, MEC40M, MGC20X, MGC24H, MGC40H		

## O-rings

## EPDM

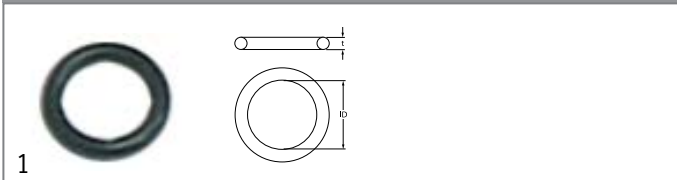
ø1.78mm



<b>Part No.</b>	510303	<b>Ref. No.</b>	200818
<b>description</b>	O-ring EPDM thickness 1.78mm ID ø 6.75mm Qty 1 pcs		

ø5.34mm

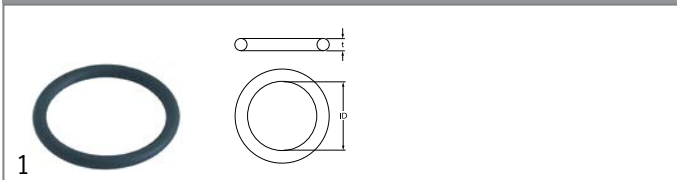

<b>Part No.</b>	505092	<b>Ref. No.</b>	2604100 BN0119472130 MA2604100
<b>description</b>	O-ring EPDM thickness 5.34mm ID ø 43.82mm Qty 1 pcs		
<b>For models:</b>	CS102E, CS102EP, CS10E, CS10EP, CS6E, CS6EP, FV4E, FV4E1, P915E, P1707E, P176E5, P196E5, P198E10, P198E15, P19S8E10		

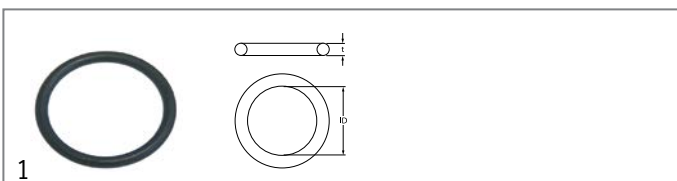

<b>Part No.</b>	510408	<b>Ref. No.</b>	200820 BN0118462630
<b>description</b>	O-ring EPDM thickness 5.34mm ID ø 47mm Qty 1 pcs		

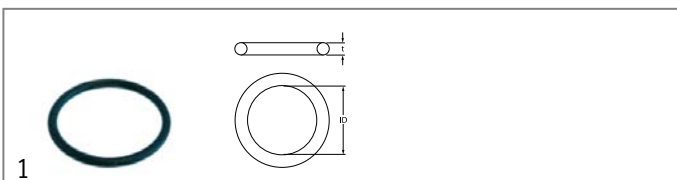

<b>Part No.</b>	510409	<b>Ref. No.</b>	1036504200 LA70045010 LAR70045010
<b>description</b>	O-ring EPDM thickness 5.34mm ID ø 56.52mm Qty 1 pcs		
<b>For models:</b>	DLS30, DLS303, DLS30P, DLS30P3, DLS31, DLS313, DLS31P3, ME101M, ME101P, ME101T, ME102D, ME102M, ME102P, ME102T, ME201D, ME201M, ME201P, ME201T, ME202D, ME202M, ME202P, ME202T, MEMT06D, MEMT06P, MEMT10D, MEMT10P, MEMT20D, MEMT20P, MEMT21D, MEMT21P, MEMT40D, MEMT40P, MLC50, MLC503, MLC65, MLC653, MLS30, MLS303, MLS30P, MLS30P3, MLS31, MLS313, MLS31P3, MLS35, MLS353, MPLS30P		

## miscellaneous

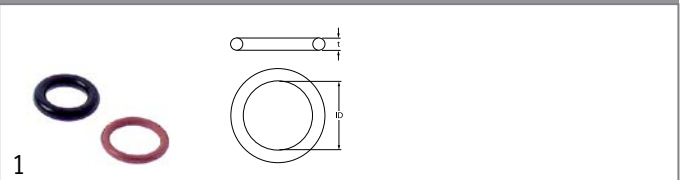

<b>Part No.</b>	532492	<b>Ref. No.</b>	LAR70010050
<b>description</b>	O-ring set EPDM thickness 1.78/2.62mm ID ø 9.25/7.59mm Qty 2 pcs		
<b>For models:</b>	ME061T, ME101T, ME102T, ME201T, MEMT06P, MEMT10P, MEMT20P, MEMT21P, MEMT40P, MG102T, MG201T, MG202T, MGMT06P, MGMT10P, MGMT20P, MGMT21P, MGMT40P		

## Viton

ø2.00mm

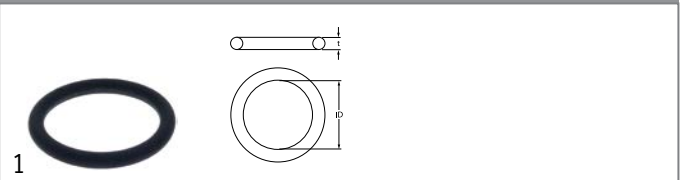

<b>Part No.</b>	512506	<b>Ref. No.</b>	LA70010080 LAR70010080
<b>description</b>	O-ring Viton thickness 2mm ID ø 14mm Qty 1 pcs		

## sealing washers

## fibre gaskets



<b>Part No.</b>	510404	<b>Ref. No.</b>	CR0682770
<b>description</b>	flat gasket fibre ED ø 44mm ID ø 34mm thickness 2mm Qty 1 pcs		
<b>For models:</b>	NPI76E5, NPI76G5, NPI78E8, NPI78G8, NPI96E5, NPI96G5, NPI98E10, NPI98E15, NPI98G10, NPI98G14, NPI98G14A		

## graphite gaskets



<b>Part No.</b>	696702	<b>Ref. No.</b>	LA63140070 LAR63140070
<b>description</b>	gasket graphite ED ø 84mm ID ø 61mm thickness 3mm Qty 1 pcs		





shaft gaskets

shaft gaskets



1

<b>Part No.</b>	511171	<b>Ref. No.</b>	LA70020040 LAR70020040
<b>description</b>	shaft seal ID ø 14.5mm ED ø 20mm thickness 3mm		
<b>For models:</b>	CVE105H, CVE105M, CVG105H, CVG105M, EC106M, EM106H, EM106M, EM106M+SC, EM106P, EV006M, EV106H, EV106M, EV106M+SC, EV106P, FE105M, FE105X, FG105M, FG105X, GC106M, GM106H, GM106M, GM106M+SC, GM106P, GMT06D, GV106H, GV106M, GV106M+SC, GV106P, GVT06D, MACE07M, MACG07M, ME061D, ME061M, ME061P, ME061T, ME106M, ME106P, ME106X, MEMT06D, MEMT06P, MEVT06D, MEVT06P, MG061D, MG061M, MG061P, MG061T, MG106M, MG106P, MG106X, MGMT06D...(Other models you can see in the webshop)		



2

<b>Part No.</b>	511170	<b>Ref. No.</b>	R70020010
<b>description</b>	shaft seal ID ø 7mm ED ø 22mm thickness 7mm		
<b>For models:</b>	CVE004H, CVE004M, CVE104H, CVE104M, VE004M, VE004X, VE104M, VE104X		



1

<b>Part No.</b>	511172	<b>Ref. No.</b>	LA70020050 LAR70020050
<b>description</b>	shaft sealing ID ø 24mm ED ø 29mm thickness 3mm		
<b>For models:</b>	EC110M, EC210M, EM010M+SC, EM110H, EM110M, EM110M+SC, EM110P, EM210H, EM210M, EM210M+SC, EM210P, EV110H, EV110M, EV110M+SC, EV110P, EV210H, EV210M, EV210M+SC, EV210P, FE110M, FE110X, FE210M, FG110M, FG110X, FG210M, FG210X, GC110M, GC210M, GM110H, GM110M, GM110M+SC, GM110P, GM210H, GM210M, GM210M+SC, GM210P, GMT20D, GV110H, GV110M, GV-110M+SC, GV110P, GV210H, GV210M, GV210M+SC, GV210P, GVT20D, MACE10M, MACE20M, MACG10M, MACG20M...(Other models you can see in the webshop)		

special gaskets

for combi-steamers



1

<b>Part No.</b>	512507	<b>Ref. No.</b>	LA70050090 LAR70050090
<b>description</b>	gasket suitable for LAINOX ED ø 23mm ID ø 15.5mm rubber thickness 3.2mm 21 Qty 1 pcs		

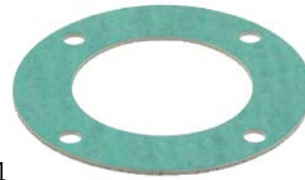

1

<b>Part No.</b>	699384	<b>Ref. No.</b>	LA63140050 LAR63140050
<b>description</b>	gasket suitable for LAINOX ED ø 84mm ID ø 50mm fibre thickness 2mm hole distance 50mm hole ø 6mm		
<b>For models:</b>	GMT06D, GMT20D, GVT06D, GVT20D, MACG05M, MACG07M, MACG10M, MACG20M, MG061D, MG061M, MG061P, MG061T, MG101D, MG101M, MG101P, MG101T, MG102D, MG102M, MG102P, MG102T, MG201D, MG201M, MG201P, MG201T, MG202D, MG202M, MG202P, MG202T, MGMT06D, MGMT06P, MGMT10D, MGMT10P, MGMT20D, MGMT20P, MGMT21D, MGMT21P, MGMT40D, MGMT40P, MGVT06D, MGVT06P, MGVT10D, MGVT10P, MGVT20D, MGVT20P, MGVT21D, MGVT21P, MGVT40D, MGVT40P, MVG051P		

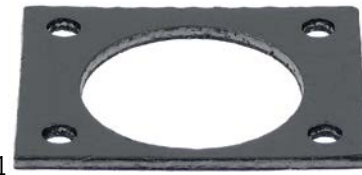

1

<b>Part No.</b>	694955	<b>Ref. No.</b>	LA63140010 LAR63140010
<b>description</b>	gasket suitable for LAINOX L 80mm W 65mm combi-steamer ID ø 51mm graphite thickness 3mm hole distance 45x60mm		
<b>For models:</b>	GMT06D, GVT06D, MACG05M, MACG07M, MG061D, MG061M, MG061P, MG061T, MGMT06D, MGMT06P, MGVT06D, MGVT06P, MVG051P		

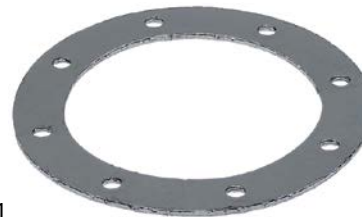

1

<b>Part No.</b>	699383	<b>Ref. No.</b>	LA63140080 LAR63140080
<b>description</b>	gasket suitable for LAINOX Qty 1m ED ø 126mm ID ø 90mm graphite thickness 3mm hole distance 42mm hole ø 7mm		



1

<b>Part No.</b>	699247	<b>Ref. No.</b>	LAR70045120
<b>description</b>	gasket set for combi-steamer		

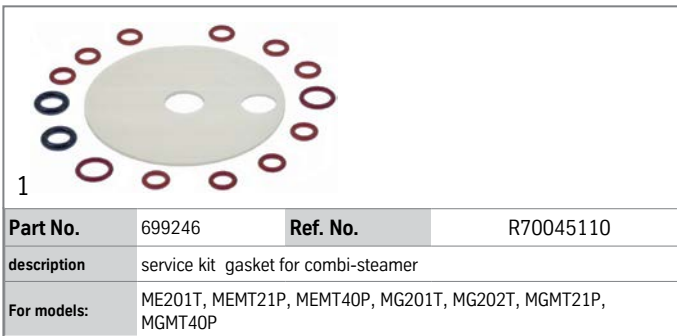
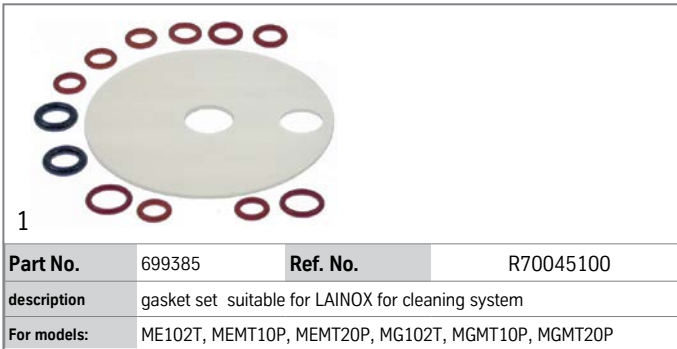

### miscellaneous



### springs

#### torsion springs

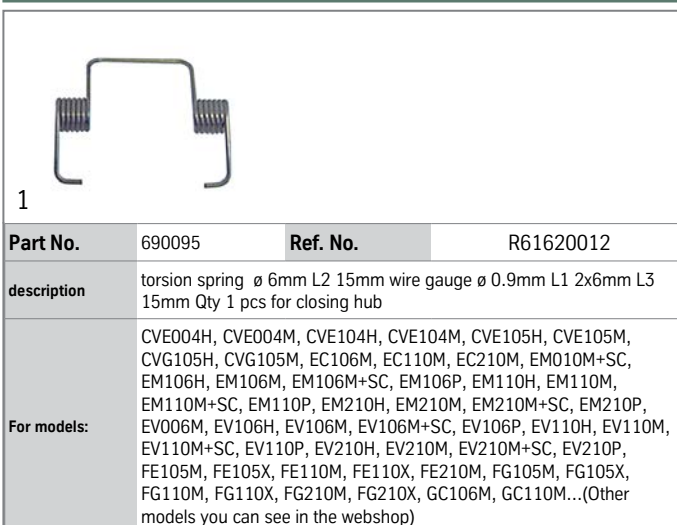

### compression springs

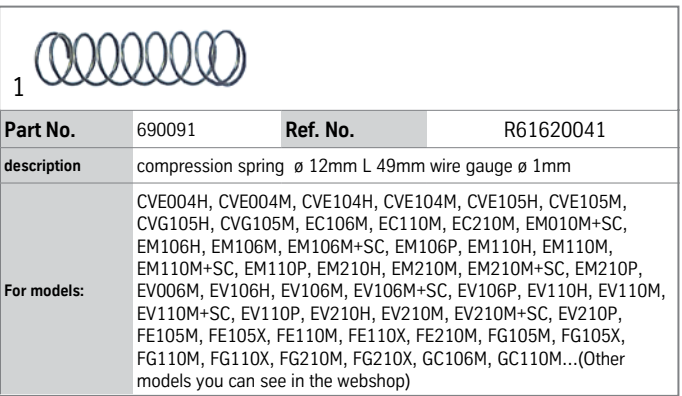

### miscellaneous



### hose reels and spray guns

#### spray guns

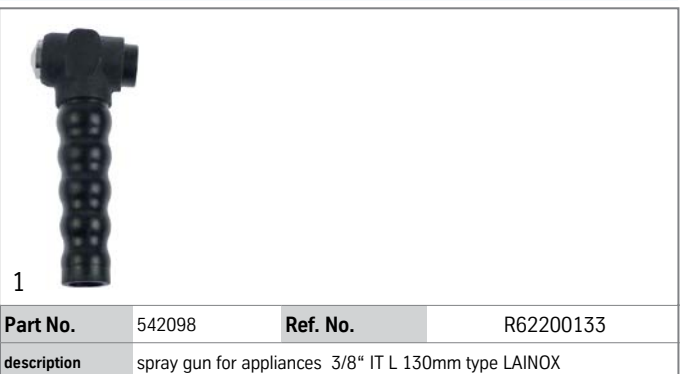



hose reels

appliance hose reels



1

<b>Part No.</b>	542099	<b>Ref. No.</b>	R62200131
<b>description</b>	hose reel complete with spray gun hose length 1.6m connection John Guest 10mm hose ø 6x12mm		
<b>For models:</b>	ME061P, ME061T, ME101P, ME101T, ME102P, ME201P, ME201T, ME202P, ME202T, MG061P, MG061T, MG101P, MG101T, MG102P, MG102T, MG201P, MG201T, MG202P, MG202T		
<b>accessories for</b>	542099		
	<b>Part No.</b>	542098	<b>Ref. No.</b> R62200133
	spray gun for appliances 3/8" IT L 130mm type LAINOX		

dosing pumps

membrane dosing pumps



self-priming

LANG

accessories



1

<b>Part No.</b>	101286	<b>Ref. No.</b>	961500 LA62070023 LAR62070023
<b>description</b>	olive ID ø 6mm Qty 1 pcs		
<b>accessories for</b>	101286		
	<b>Part No.</b>	100909	<b>Ref. No.</b> LA62060223 LAR62060223
	union screw thread M10x1 for pipe ø 6mm Qty 1 pcs		
	<b>Part No.</b>	101464	<b>Ref. No.</b> —
	union nut thread M12x1 for pipe ø 6mm		

accessories

container filters with non-return valve



1

<b>Part No.</b>	361058	<b>Ref. No.</b>	LA65110650 LAR65110650
<b>description</b>	container filter with non-return valve SS hose ø 4x6mm ø 20mm L 56mm		
<b>For models:</b>	ME061T, ME101T, ME102T, ME201T, MEMT06P, MEMT10P, MEMT20P, MEMT21P, MEMT40P, MG102T, MG201T, MG202T, MGMT06P, MGMT10P, MGMT20P, MGMT21P, MGMT40P		

hoses

industrial hoses

Niplaflex hoses



1

<b>Part No.</b>	530561	<b>Ref. No.</b>	200122
<b>description</b>	pressure hose ID ø 10mm ED ø 17mm L 5m thickness 3.5mm operating p. 10bar burst p. 30bar t.max. 110°C		

PE hoses



1

<b>Part No.</b>	520973	<b>Ref. No.</b>	LA80150000 LAR80150000 R70070040 R70070050
<b>description</b>	hose John Guest thickness 1.5mm LLDPE blue ID ø 7mm ED ø 10mm		
<b>For models:</b>	GMT06D, GMT20D, GVT06D, ME061P, ME061T, ME101D, ME101M, ME101P, ME101T, ME102D, ME102M, ME102P, ME102T, ME201D, ME201M, ME201P, ME201T, ME202D, ME202M, ME202P, ME202T, MEMT06P, MEMT10D, MEMT10P, MEMT20D, MEMT20P, MEMT21D, MEMT21P, MEMT40D, MEMT40P, MEVT06P, MEVT10D, MEVT10P, MEVT21D, MEVT21P, MEVT40D, MEVT40P, MG061D, MG061M, MG061P, MG061T, MG101D, MG101M, MG101P, MG101T, MG102D, MG102M, MG102P, MG102T, MG201D...(Other models you can see in the webshop)		
<b>accessories for</b>	520973		
	<b>Part No.</b>	440564	<b>Ref. No.</b> —
	push-in fitting John Guest straight thread 1/4" BSP pipe connection ø10mm		
	<b>Part No.</b>	440565	<b>Ref. No.</b> —
	push-in fitting John Guest straight thread 3/8" BSP pipe connection ø10mm		
	<b>Part No.</b>	440608	<b>Ref. No.</b> —
	push-in fitting John Guest straight thread 1/2" BSP stub ø 10mm		
	<b>Part No.</b>	440639	<b>Ref. No.</b> —
	push-in fitting John Guest angled thread 1/4" BSP pipe connection ø10mm		
	<b>Part No.</b>	520359	<b>Ref. No.</b> LA62090528 LAR62090528 R62090528
	push-in fitting John Guest angled pipe connection ø10mm grommet ø 10mm		
	<b>Part No.</b>	520363	<b>Ref. No.</b> R62090468
	push-in fitting John Guest T-piece pipe connection ø10mm - ø10mm - ø10mm		
	<b>Part No.</b>	520494	<b>Ref. No.</b> LA62090478 LAR62090478 R62090478
	push-in fitting John Guest angled pipe connection ø10mm - ø10mm		



PU hoses



1

<b>Part No.</b>	512505	<b>Ref. No.</b>	LA80150020 LAR80150020
<b>description</b>	PU hose ID ø 5mm ED ø 8mm L 1m thickness 1.5mm t.max. -40 up to +60°C polyurethane transparent/colourless		

PVC hoses

PVC hoses without fabric



1

<b>Part No.</b>	520278	<b>Ref. No.</b>	R70070100
<b>description</b>	PVC hose ID ø 6mm ED ø 8mm L 2m thickness 1mm t.max. 60°C transparent		
<b>For models:</b>	ME061T, ME101T, ME102T, ME201T, MEMT06P, MEMT10P, MEMT20P, MEMT21P, MEMT40P, MG102T, MG201T, MG202T, MGMT06P, MGMT10P, MGMT20P, MGMT21P, MGMT40P		

silicone hoses

without fabric



1

<b>Part No.</b>	530899	<b>Ref. No.</b>	LAR70060080
<b>description</b>	silicone hose ID ø 13mm ED ø 18mm L 0.08m thickness 2.5mm red for combi-steamer		
<b>For models:</b>	EM010M+SC, EM106H, EM106M, EM106M+SC, EM106P, EM110H, EM110M, EM110M+SC, EM110P, EM210H, EM210M, EM210M+SC, EM210P, EV006M, EV106H, EV106M, EV106M+SC, EV106P, EV110H, EV110M, EV110M+SC, EV110P, EV210H, EV210M, EV210M+SC, EV210P, GM106H, GM106M, GM106M+SC, GM106P, GM110H, GM110M, GM110M+SC, GM110P, GM210H, GM210M, GM210M+SC, GM210P, GMT06D, GMT20D, GV106H, GV106M, GV106M+SC, GV106P, GV110H, GV110M, GV110M+SC, GV110P, GV210H, GV210M...(Other models you can see in the webshop)		



1

<b>Part No.</b>	530884	<b>Ref. No.</b>	R70060060 R70060070
<b>description</b>	silicone hose ID ø 15mm ED ø 19mm L 0.08m thickness 3mm red for combi-steamer		
<b>For models:</b>	CVE004H, CVE004M, CVE104H, CVE104M, CVE105H, CVE105M, CVG105H, CVG105M, EM010M+SC, EM106H, EM106M, EM106M+SC, EM106P, EM110H, EM110M, EM110M+SC, EM110P, EM210H, EM210M, EM210M+SC, EM210P, GM106H, GM106M, GM106M+SC, GM106P, GM110H, GM110M, GM110M+SC, GM110P, GM210H, GM210M, GM210M+SC, GM210P, ME106M, ME106P, ME106X, ME110M, ME110P, ME110X, ME120M, ME120P, ME120X, ME210M, ME210P, ME210X, ME220M, ME220P, ME220X, MEC24H, MEC40M...(Other models you can see in the webshop)		



1

<b>Part No.</b>	570157	<b>Ref. No.</b>	LA80120060 LAR80120060
<b>description</b>	silicone hose ID ø 7mm ED ø 12mm L 1m thickness 2.5mm transparent for combi-steamer		

formed hoses

straight



1

<b>Part No.</b>	520534	<b>Ref. No.</b>	LA70060040 LAR70060040
<b>description</b>	hose ID ø 50mm ED ø 58mm L 50mm silicone Qty 1 for combi-steamer thickness 4mm		
<b>For models:</b>	FE105M, FE105X, FE110M, FE110X, FG105M, FG105X, FG110M, FG110X, GMT20D, ME061P, ME061T, ME101M, ME101P, ME101T, ME102M, ME102P, ME102T, ME106M, ME106P, ME106X, ME110M, ME110P, ME110X, ME120M, ME120P, ME120X, ME201D, ME201M, ME201P, ME201T, ME202D, ME202M, ME202P, ME202T, ME210M, ME210P, ME210X, ME220M, ME220P, ME220X, MEC24H, MEC40M, MEMT21D, MEMT21P, MEMT40D, MEMT40P, MEVT21D, MEVT21P, MEVT40D, MEVT40P...(Other models you can see in the webshop)		



1

<b>Part No.</b>	530901	<b>Ref. No.</b>	LA70060050 R70060050
<b>description</b>	hose ID ø 54mm ED ø 60mm L 50mm for combi-steamer		
<b>For models:</b>	FE210M, FG210M, FG210X, ME102P, ME102T, ME202D, ME202M, ME202P, ME202T, MEMT40D, MEMT40P, MEVT40D, MEVT40P, MG102P, MG102T, MG202D, MG202M, MG202P, MG202T, MGMT40D, MGMT40P, MGVT40D, MGVT40P		



1

<b>Part No.</b>	694499	<b>Ref. No.</b>	R70070060
<b>description</b>	hose ID ø 7mm L 2000mm LLDPE for beverage technology ED ø 10mm John Guest		
<b>For models:</b>	GVT20D, MACE07M, MACE10M, MACE20M, MACG07M, MACG10M, MACG20M, ME061D, MEMT06D, MEVT06D, MEVT20D, MEVT20P, MGVT20D, MGVT20P		



			
1			
<b>Part No.</b>	592327	<b>Ref. No.</b>	LA80150060 LAR80150060
<b>description</b>	water hose ID ø 7mm ext. ø 10 L 1000mm operating p. 3bar temp.-resist. 92°C for combi-steamer		

			
1			
<b>Part No.</b>	362011	<b>Ref. No.</b>	R62090538
<b>description</b>	hose connector plastic straight thread 1/4" hose ø 8x6mm Qty 1 pcs		
<b>For models:</b>	ME061T, ME101T, ME102T, ME201T, MEMT06P, MEMT10P, MEMT20P, MEMT21P, MEMT40P, MG102T, MG201T, MG202T, MGMT06P, MGMT10P, MGMT20P, MGMT21P, MGMT40P		

## fittings, hose and pipe connectors

### fittings

#### double nipples

			
1			
<b>Part No.</b>	521182	<b>Ref. No.</b>	LA62020118 LAR62020118
<b>description</b>	double nipple plastic thread 1/4" - 1/4" Qty 1 pcs		

#### screw pipe fittings

#### angle pieces

			
1			
<b>Part No.</b>	699452	<b>Ref. No.</b>	LA62090633 LAR62090633
<b>description</b>	angle piece thread M14x1 tube ø 10mm brass		

### hose connectors

#### plastic

			
1			
<b>Part No.</b>	362015	<b>Ref. No.</b>	LAR62090638
<b>description</b>	hose connector plastic straight IT 1/4" hose ø 8mm		

			
1			
<b>Part No.</b>	362010	<b>Ref. No.</b>	R62090492
<b>description</b>	hose connector plastic straight thread 1/4" hose ø 8mm Qty 1 pcs		
<b>For models:</b>	ME061T, ME101T, ME102T, ME201T, MEMT06P, MEMT10P, MEMT20P, MEMT21P, MEMT40P, MG102T, MG201T, MG202T, MGMT06P, MGMT10P, MGMT20P, MGMT21P, MGMT40P		

#### stainless steel

			
1			
<b>Part No.</b>	542385	<b>Ref. No.</b>	LA62090663 LAR62090663
<b>description</b>	hose connector SS angled thread 1/4" hose ø 10mm Qty 1 pcs		

#### producer-specific

			
1			
<b>Part No.</b>	440027	<b>Ref. No.</b>	LA62090482 LAR62090482
<b>description</b>	connecting piece for hose ID 6mm WS 15 total length 79mm plastic John Guest		
<b>For models:</b>	ME061T, ME101T, ME102T, ME201T, MEMT06P, MEMT10P, MEMT20P, MEMT21P, MEMT40P, MG102T, MG201T, MG202T, MGMT06P, MGMT10P, MGMT20P, MGMT21P, MGMT40P		

			
1			
<b>Part No.</b>	520339	<b>Ref. No.</b>	LA62090518 LAR62090518
<b>description</b>	hose connector thread 1/4" straight grommet ø 10mm grommet length 20mm WS 20 total length 37mm thread L 11mm plastic		
<b>For models:</b>	ME061T, ME101T, ME102T, ME201T, MEMT06P, MEMT10P, MEMT20P, MEMT21P, MEMT40P, MG102T, MG201T, MG202T, MGMT06P, MGMT10P, MGMT20P, MGMT21P, MGMT40P		

			
1			
<b>Part No.</b>	520360	<b>Ref. No.</b>	LAR62090508
<b>description</b>	hose connector thread 1/4" with coupling straight plastic		
<b>For models:</b>	GVT06D, GVT20D, ME061T, ME101T, ME102T, ME201T, MEMT06P, MEMT10P, MEMT20P, MEMT21P, MEMT40P, MEVT06D, MEVT06P, MEVT10D, MEVT10P, MEVT20D, MEVT20P, MEVT21D, MEVT21P, MEVT40D, MEVT40P, MG102T, MG201T, MG202T, MGMT06P, MGMT10P, MGMT20P, MGMT21P, MGMT40P, MGVT06D, MGVT06P, MGVT10D, MGVT10P, MGVT20D, MGVT20P, MGVT21D, MGVT21P, MGVT40D, MVE042P, MVE051P, MVG051P		







push-in fittings

JOHN GUEST



<b>Part No.</b>	440019	<b>Ref. No.</b>	R62090548
<b>description</b>	push-in fitting John Guest straight pipe connection ø6mm grommet ø 10mm		
<b>For models:</b>	ME061T, ME101T, ME102T, ME201T, MEMT06P, MEMT10P, MEMT20P, MEMT21P, MEMT40P, MG102T, MG201T, MG202T, MGMT06P, MGMT10P, MGMT20P, MGMT21P, MGMT40P, MGMT40P		
<b>accessories for</b>	440019		
	<b>Part No.</b>	520971	<b>Ref. No.</b> —
hose thickness 1mm LLDPE blue ID ø 4mm ED ø 6mm operating pressure at 20°C 16bar			



<b>Part No.</b>	520359	<b>Ref. No.</b>	LA62090528 LAR62090528
<b>description</b>	push-in fitting John Guest angled pipe connection ø10mm grommet ø 10mm		
<b>For models:</b>	ME061T, ME101T, ME102T, ME201T, MEMT06P, MEMT10P, MEMT20P, MEMT21P, MEMT40P, MG102T, MG201T, MG202T, MGMT06P, MGMT10P, MGMT20P, MGMT21P, MGMT40P, MGMT40P		
<b>accessories for</b>	520359		
	<b>Part No.</b>	520973	<b>Ref. No.</b> LA80150000 LAR80150000 R70070040 R70070050
hose John Guest thickness 1.5mm LLDPE blue ID ø 7mm ED ø 10mm			



<b>Part No.</b>	440671	<b>Ref. No.</b>	LA62090678 LAR62090678
<b>description</b>	push-in fitting John Guest angled pipe connection ø8mm grommet ø 8mm		
<b>accessories for</b>	440671		
	<b>Part No.</b>	520972	<b>Ref. No.</b> —
hose John Guest thickness 1mm LLDPE blue ID ø 6mm ED ø 8mm			



<b>Part No.</b>	520493	<b>Ref. No.</b>	R62090618
<b>description</b>	hose connector John Guest straight pipe connection ø8mm - ø10mm L 41mm PM201008E NSF, SK		
<b>For models:</b>	ME061T, ME101T, ME102T, MEMT06P, MEMT10P, MEMT20P, MEMT21P, MG102T, MG202D, MG202M, MG202P, MG202T, MGMT06P, MGMT10P, MGMT20P, MGMT21P, MGMT40D, MGMT40P, MGMT40P		



<b>Part No.</b>	520492	<b>Ref. No.</b>	LA62090458 LAR62090458
<b>description</b>	push-in fitting John Guest straight pipe connection ø10mm - ø10mm		
<b>For models:</b>	GMT06D, GMT20D, GVT06D, GVT20D, MACE04M, MACE05M, MACE05M, MACE06M, MACE07M, MACE10M, MACE10M, MACE10M, ME061D, ME061T, ME101D, ME101M, ME101P, ME101T, ME102D, ME102M, ME102P, ME102T, ME201D, ME201M, ME201P, ME201T, ME202D, ME202M, MEMT06D, MEMT06P, MEMT10D, MEMT10P, MEMT20D, MEMT20P, MEMT21D, MEMT21P, MEMT40D, MEMT40P, MEVT06D, MEVT06P, MEVT10D, MEVT10P, MEVT20D, MEVT20P, MEVT21D, MEVT21P, MEVT40D, MEVT40P, MG061D, MG061M, MG101D, MG101M, MG101P, MG101T, MG102D...(Other models you can see in the webshop)		





<b>Part No.</b>	520494	<b>Ref. No.</b>	LA62090478 LAR62090478
<b>description</b>	push-in fitting John Guest angled pipe connection ø10mm - ø10mm		
<b>For models:</b>	GMT20D, GVT06D, GVT20D, MACE04M, MACE05M, MACE07M, MACE10M, MACE20M, MACE05M, MACE07M, MACE10M, MACE20M, ME061D, ME061P, ME061T, ME101D, ME101M, ME101P, ME101T, ME102D, ME102M, ME102P, ME102T, ME201D, ME201M, ME201P, ME201T, ME202D, ME202M, ME202P, ME202T, MEMT06D, MEMT06P, MEMT10D, MEMT10P, MEMT20D, MEMT20P, MEMT21D, MEMT21P, MEMT40D, MEMT40P, MEVT06D, MEVT06P, MEVT10D, MEVT10P, MEVT20D, MEVT20P, MEVT21D, MEVT21P, MEVT40D...(Other models you can see in the webshop)		
<b>accessories for</b>	520494		
	<b>Part No.</b>	520973	<b>Ref. No.</b> LA80150000 LAR80150000 R70070040 R70070050
hose John Guest thickness 1.5mm LLDPE blue ID ø 7mm ED ø 10mm			



<b>Part No.</b>	520363	<b>Ref. No.</b>	R62090468
<b>description</b>	push-in fitting John Guest T-piece pipe connection ø10mm - ø10mm - ø10mm		
<b>For models:</b>	ME061P, ME061T, ME101M, ME101P, ME101T, ME102M, ME102P, ME102T, ME201D, ME201M, ME201P, ME201T, ME202D, ME202M, ME202P, ME202T, MEMT06P, MEMT10P, MEMT20P, MEMT21D, MEMT21P, MEMT40D, MEMT40P, MEVT21D, MEVT21P, MEVT40D, MEVT40P, MG061M, MG061P, MG061T, MG101M, MG101P, MG101T, MG102M, MG102P, MG102T, MG201D, MG201M, MG201P, MG201T, MG202D, MG202M, MG202P, MG202T, MGMT06P, MGMT10P, MGMT20P, MGMT21D, MGMT21P, MGMT40D...(Other models you can see in the webshop)		
<b>accessories for</b>	520363		
	<b>Part No.</b>	520973	<b>Ref. No.</b> LA80150000 LAR80150000 R70070040 R70070050
hose John Guest thickness 1.5mm LLDPE blue ID ø 7mm ED ø 10mm			



 <p>1</p>			
<b>Part No.</b>	520495	<b>Ref. No.</b>	LA62090608 LAR62090608
<b>description</b>	push-in fitting John Guest straight thread 1/8" BSP stub ø 8mm		
<b>For models:</b>	ME061T, ME101T, ME102T, ME201T, MEMT06P, MEMT10P, MEMT20P, MEMT21P, MEMT40P, MG102T, MG201T, MG202D, MG202M, MG202P, MG202T, MGMT06P, MGMT10P, MGMT20P, MGMT21P, MGMT40D, MGMT40P, MGMT40P		
<b>accessories for</b>	520495		
	<b>Part No.</b>	520971	<b>Ref. No.</b> —
	 hose thickness 1mm LLDPE blue ID ø 4mm ED ø 6mm operating pressure at 20°C 16bar		

 <p>1</p>			
<b>Part No.</b>	440031	<b>Ref. No.</b>	LA62090688 LAR62090688
<b>description</b>	push-in fitting John Guest straight thread 1/2" pipe connection ø8mm - ø8mm bulkhead connector		

## valves and tank inlets

### ball valves

#### universal

#### ball valves with butterfly handle

 <p>1</p>			
<b>Part No.</b>	540658	<b>Ref. No.</b>	1450500 MA1450500
<b>description</b>	ball valve connection 3/4" IT - 3/4" IT DN20 total length 69mm		
<b>For models:</b>	CP704E, CP704G, CP92E, CP92E2, CP92G, CP94E, CP94E2, CP94G, CP9SB2E, CP9SB2E2, CP9SB2G, CP9SB4E, CP9SB4E2, CP9SB4G, CPE40, CPE402, CPE60, CPE602, CPE60DB, F74E10, F74E6, F76E10, F94E10, F94E6, F96E10, FR74E, FR74E10, FR74E10L, FR74E10L2, FR74G, FR77E, FR77E10, FR77E10L, FR77E10L2, FR77G, FR92E10, FR92E10L, FR92E10L2, FR92E13, FR92E22, FR92G22, FR94E10, FR94E10L, FR94E10L2, FR94E13, FR94E22, FR94G23, FR9P2E10, FR9P4E10, NF74E10...(Other models you can see in the webshop)		

### ball valves electric

 <p>1</p>			
<b>Part No.</b>	403026 <sup>1</sup>	<b>Ref. No.</b>	R65110540
<b>description</b>	ball valve inlet 1/2" IT outlet 1/2" IT 230V L 90mm 50/60Hz off-current open mode of operation electric W 60mm H 100mm connection cable 450mm IT 1/2"		
<b>For models:</b>	EM010M+SC, EM106H, EM106M, EM106M+SC, EM106P, EM110H, EM110M, EM110M+SC, EM110P, EM210H, EM210M, EM210M+SC, EM210P, GM106H, GM106M, GM106M+SC, GM106P, GM110H, GM110M, GM110M+SC, GM110P, GM210H, GM210M, GM210M+SC, GM210P, ME106M, ME106P, ME106X, ME110M, ME110P, ME110X, ME120M, ME120P, ME120X, ME210M, ME210P, ME210X, ME220M, ME220P, ME220X, MEC24H, MEC40M, MG106M, MG106P, MG106X, MG110M, MG110P, MG110X, MG120M, MG120P...(Other models you can see in the webshop)		

<sup>1</sup>off-current open

 <p>1</p>			
<b>Part No.</b>	401190	<b>Ref. No.</b>	R65110560
<b>description</b>	ball valve inlet 3/4" IT outlet 3/4" IT IP42 230V L 68mm 50/60Hz closed off-current mode of operation electric connection cable 300mm 3.5W duty cycle 50%		

## beverage technology

### valves

#### non-return valves

 <p>1</p>			
<b>Part No.</b>	440026	<b>Ref. No.</b>	R62300018
<b>description</b>	non-return valve kit John Guest pipe connection ø10x10mm operating pressure at 20°C 10bar opening pressure 0.02bar POM		
<b>For models:</b>	ME061T, ME101T, ME102T, ME201T, MG102T, MG201T, MG202T		



## ancillary products

### clamps

#### hose clamps

##### DIN 3017 - W2



1

**Part No.** 520111 **Ref. No.** 450102

**description** hose clamp ø 10-16mm width 9mm Qty 10 pcs DIN 3017



1

**Part No.** 520112 **Ref. No.** 450103  
LAR61630011

**description** hose clamp ø 12-20mm width 9mm Qty 10 pcs DIN 3017

**For models:** CVE004H, CVE004M, CVE104H, CVE104M, CVE105H, CVE105M, CVG105H, CVG105M, EC106M, EC110M, EC210M, EM010M+SC, EM106H, EM106M, EM106M+SC, EM106P, EM110H, EM110M, EM110M+SC, EM110P, EM210H, EM210M, EM210M+SC, EM210P, EV006M, EV106H, EV106M, EV106M+SC, EV106P, EV110H, EV110M, EV110M+SC, EV110P, EV210H, EV210M, EV210M+SC, EV210P, GC106M, GC110M, GC210M, GM106H, GM106M, GM106M+SC, GM106P, GM110H, GM110M, GM110M+SC, GM110P, GM210H, GM210M...(Other models you can see in the webshop)



1

**Part No.** 520115 **Ref. No.** 450105

**description** hose clamp ø 25-40mm width 9mm Qty 10 pcs DIN 3017



1

**Part No.** 520116 **Ref. No.** 450107

**description** hose clamp ø 32-50mm width 9mm Qty 5 pcs DIN 3017



1

**Part No.** 520119 **Ref. No.** 450119

**description** hose clamp ø 60-80mm width 9mm Qty 5 pcs DIN 3017



1

**Part No.** 520117 **Ref. No.** 450135

**description** hose clamp stainless steel ø 40-60mm width 9mm Qty 5 pcs DIN 3017

## measuring equipment

### thermometers

#### built-in thermometers

##### ø52mm



1

**Part No.** 541582 **Ref. No.** 2715000  
2772700  
27727000

**description** thermometer mounting ø 52mm t.max. 350°C +50 up to +350°C probe ø 6mm probe L 17mm capillary pipe 1700mm



1

**Part No.** 541077 **Ref. No.** 65340050  
LA65340050  
LAR65340050  
MA65340050

**description** thermometer mounting ø 52mm t.max. 350°C +50 up to +350°C probe ø 6mm probe L 30mm capillary pipe 1000mm built-in depth 28mm

**For models:** EC106M, EC110M, EC210M, EM010M+SC, EM106M, EM106M+SC, EM110M, EM110M+SC, EM210M, EM210M+SC, EV006M, EV106M, EV106M+SC, EV110M, EV110M+SC, EV210M, EV210M+SC, FE105M, FE105X, FE110M, FE110X, FE210M, FG105M, FG105X, FG110M, FG110X, FG210M, FG210X, GC106M, GC110M, GC210M, GM106M, GM106M+SC, GM110M, GM110M+SC, GM210M, GM210M+SC, GV106M, GV106M+SC, GV110M, GV110M+SC, GV210M, GV210M+SC, MEC40M, MGC20X, PE040M, PE040X, PE080M, PE080X, PG040M... (Other models you can see in the webshop)



## fastening material

### screws

#### flat-headed bolts

 <p>1</p>			
<b>Part No.</b>	511004	<b>Ref. No.</b>	260226
<b>description</b>	flat-headed bolt thread M4 thread L 12mm SS DIN 84/ISO 1207 Qty 1 pcs intake slotted L 14.5mm		

#### raised countersunk head screws

 <p>1</p>			
<b>Part No.</b>	560541	<b>Ref. No.</b>	R61040272
<b>description</b>	raised countersunk head screw thread M6 thread L 13mm SS DIN 966/ISO 7047 Qty 1 pcs intake slotted head ø 11mm head thickness 5mm		
<b>For models:</b>	ME201D, ME201M, ME201P, ME201T, ME202D, ME202M, ME202P, ME202T, MEC24H, MEC40M, MEMT21D, MEMT21P, MEMT40D, MEMT40P, MEVT21D, MEVT21P, MEVT40D, MEVT40P, MG201D, MG201M, MG201P, MG201T, MG202D, MG202M, MG202P, MG202T, MGC20X, MGC24H, MGC40H, MGMT21D, MGMT21P, MGMT40D, MGMT40P, MGVT21D, MGVT21P, MGVT40D, MGVT40P		

#### hexagonal screws

 <p>1</p>			
<b>Part No.</b>	560087	<b>Ref. No.</b>	260104
<b>description</b>	hexagonal screw thread M6 thread L 16mm SS WS 10 Qty 20 pcs DIN 933 / ISO 4017		

 <p>1</p>			
<b>Part No.</b>	510990	<b>Ref. No.</b>	260113
<b>description</b>	hexagonal screw thread M8 thread L 20mm SS WS 13 Qty 1 pcs DIN 933 / ISO 4017		

 <p>1</p>			
<b>Part No.</b>	560594	<b>Ref. No.</b>	LA61020562 LAR61020562
<b>description</b>	hexagonal screw thread M6 thread L 20mm WS 10 total length 59mm		
<b>For models:</b>	EC110M, EC210M, EM010M+SC, EM110H, EM110M, EM110M+SC, EM110P, EM210H, EM210M, EM210M+SC, EM210P, EV110H, EV110M, EV110M+SC, EV110P, EV210H, EV210M, EV210M+SC, EV210P, FE110M, FE110X, FE210M, FG110M, FG110X, FG210M, FG210X, GC110M, GC210M, GM110H, GM110M, GM110M+SC, GM110P, GM210H, GM210M, GM210M+SC, GM210P, GMT20D, GV110H, GV110M, GV-110M+SC, GV110P, GV210H, GV210M, GV210M+SC, GV210P, GVT20D, MACE10M, MACE20M, MACG10M, MACG20M...(Other models you can see in the webshop)		

### cylinder head bolts

#### DIN 912/ISO 4762

 <p>1</p>			
<b>Part No.</b>	520455	<b>Ref. No.</b>	R61030601
<b>description</b>	screw thread M8 thread L 20mm WS 6 SS Qty 1 pcs DIN 912/ISO 4762		
<b>For models:</b>	ME201D, ME201M, ME201P, ME201T, ME202D, ME202M, ME202P, ME202T, MEMT21D, MEMT21P, MEMT40D, MEMT40P, MEVT21D, MEVT21P, MEVT40D, MEVT40P, MG201D, MG201M, MG201P, MG201T, MG202D, MG202M, MG202P, MG202T, MGMT21D, MGMT21P, MGMT40D, MGMT40P, MGVT21D, MGVT21P, MGVT40D, MGVT40P		

### side bolts

 <p>1</p>			
<b>Part No.</b>	560052	<b>Ref. No.</b>	260223
<b>description</b>	side bolts thread M5 L 10mm SS Qty 20 pcs intake slotted head ø 12.5mm		

### grub screws

#### DIN 913/ISO 4026

 <p>1</p>			
<b>Part No.</b>	560024	<b>Ref. No.</b>	LA61090052 LAR61090052
<b>description</b>	grub screw thread M6 L 16mm SS DIN 913/ISO 4026 intake internal hexagon WS 3 Qty 20 pcs		
<b>For models:</b>	ME120M, ME120P, ME120X, ME201D, ME201M, ME201P, ME201T, ME202D, ME202M, ME202P, ME202T, ME220M, ME220P, ME220X, MEC24H, MEC40M, MEMT21D, MEMT21P, MEMT40D, MEMT40P, MEVT21D, MEVT21P, MEVT40D, MEVT40P, MG120M, MG120P, MG120X, MG201D, MG201M, MG201P, MG201T, MG202D, MG202M, MG202P, MG202T, MG220M, MG220P, MG220X, MGC20X, MGC24H, MGC40H, MGMT21D, MGMT21P, MGMT40D, MGMT40P, MGVT21D, MGVT21P, MGVT40D, MGVT40P, VE120M...(Other models you can see in the webshop)		

### miscellaneous

 <p>1</p>			
<b>Part No.</b>	690594	<b>Ref. No.</b>	LA58002560 LAR58002560
<b>description</b>	pressure screw for door hinge		
<b>For models:</b>	ME120M, ME120P, ME120X, ME201D, ME201M, ME201P, ME201T, ME202D, ME202M, ME202P, ME202T, ME220M, ME220P, ME220X, MEC24H, MEC40M, MEMT21D, MEMT21P, MEMT40D, MEMT40P, MEVT21D, MEVT21P, MEVT40D, MEVT40P, MG120M, MG120P, MG120X, MG201D, MG201M, MG201P, MG201T, MG202D, MG202M, MG202P, MG202T, MG220M, MG220P, MG220X, MGC20X, MGC24H, MGC40H, MGMT21D, MGMT21P, MGMT40D, MGMT40P, MGVT21D, MGVT21P, MGVT40D, MGVT40P, VE120M...(Other models you can see in the webshop)		

5 tools, fastening materials, consumables





			
1			
<b>Part No.</b>	694991	<b>Ref. No.</b>	R58006400
<b>description</b>	screw thread M6 L 16mm for air baffle combi-steamer		
<b>For models:</b>	CVE004H, CVE004M, CVE104H, CVE104M, CVE105H, CVE105M, CVG105H, CVG105M, EC106M, EC110M, EC210M, EM010M+SC, EM106H, EM106M, EM106M+SC, EM106P, EM110H, EM110M, EM110M+SC, EM110P, EM210H, EM210M, EM210M+SC, EM210P, EV006M, EV106H, EV106M, EV106M+SC, EV106P, EV110H, EV110M, EV110M+SC, EV110P, EV210H, EV210M, EV210M+SC, EV210P, GC106M, GC110M, GC210M, GM106H, GM106M, GM106M+SC, GM106P, GM110H, GM110M, GM110M+SC, GM110P, GM210H, GM210M...(Other models you can see in the webshop)		

## nuts

### hexagonal nuts

<b>DIN 934 / ISO 4032/8673</b>			
			
1			
<b>Part No.</b>	560133	<b>Ref. No.</b>	260404
<b>description</b>	hexagonal nut thread M6 H 5mm WS 10 SS DIN/ISO DIN 934 / ISO 4032/8673 Qty 20 pcs		

			
1			
<b>Part No.</b>	560197	<b>Ref. No.</b>	260407
<b>description</b>	nut thread M10 H 8mm WS 17 SS DIN/ISO DIN 934 / ISO 4032/8673 Qty 1 pcs		

			
1			
<b>Part No.</b>	506166	<b>Ref. No.</b>	260408
<b>description</b>	nut thread M12 H 10mm WS 19 SS DIN/ISO DIN 934 / ISO 4032/8673 Qty 1 pcs		

<b>ISO 4033 / UNI5587</b>			
			
1			
<b>Part No.</b>	550866	<b>Ref. No.</b>	R58004020
<b>description</b>	nut thread M10x1.5 H 10mm SS WS 17 Qty 1 pcs DIN/ISO DIN 934 / ISO 4032/8673 left-hand thread		
<b>For models:</b>	CVE105H, CVE105M, CVG105H, CVG105M, EC106M, EM106H, EM106M, EM106M+SC, EM106P, EV006M, EV106H, EV106M, EV106M+SC, EV106P, FE105M, FE105X, FG105M, FG105X, GC106M, GM106H, GM106M, GM106M+SC, GM106P, GMT06D, GV106H, GV106M, GV106M+SC, GV106P, GVT06D, MACE07M, MACG07M, ME061D, ME061M, ME061P, ME061T, ME106M, ME106P, ME106X, MEMT06D, MEMT06P, MEVT06D, MEVT06P, MGO61D, MGO61M, MGO61P, MGO61T, MG106M, MG106P, MG106X, MGMT06D...(Other models you can see in the webshop)		

<b>DIN 985</b>			
			
1			
<b>Part No.</b>	560227	<b>Ref. No.</b>	15774399 MA15774399
<b>description</b>	hexagonal nut thread M3 H 4mm SS WS 5.5 Qty 1 pcs self-locking		
<b>For models:</b>	SER15, SER15A, SER18, SER18A, SER21		

			
1			
<b>Part No.</b>	560140	<b>Ref. No.</b>	260402
<b>description</b>	hexagonal nut thread M4 H 4.8mm SS WS 7 Qty 20 pcs DIN/ISO DIN 985 self-locking		

<b>hexagonal nuts metric (without norm)</b>			
			
1			
<b>Part No.</b>	550681	<b>Ref. No.</b>	LA58004050 LAR58004050
<b>description</b>	nut thread M12x1.25 H 5mm WS 17 brass Qty 1 pcs		
<b>For models:</b>	EC106M, EC110M, EC210M, EM010M+SC, EM106H, EM106M, EM106M+SC, EM106P, EM110H, EM110M, EM110M+SC, EM110P, EM210H, EM210M, EM210M+SC, EM210P, EV006M, EV106H, EV106M, EV106M+SC, EV106P, EV110H, EV110M, EV110M+SC, EV110P, EV210H, EV210M, EV210M+SC, EV210P, GC106M, GC110M, GC210M, GM106H, GM106M, GM106M+SC, GM106P, GM110H, GM110M, GM110M+SC, GM110P, GM210H, GM210M, GM210M+SC, GM210P, GMT06D, GMT20D, GV106H, GV106M, GV106M+SC, GV106P...(Other models you can see in the webshop)		

			
1			
<b>Part No.</b>	691289	<b>Ref. No.</b>	R58004830
<b>description</b>	nut thread M18x1 H 5mm WS 22 brass Qty 1 pcs for door handle		
<b>For models:</b>	CVE004H, CVE004M, CVE104H, CVE104M, CVE105H, CVE105M, CVG105H, CVG105M, EC106M, EC110M, EC210M, EM010M+SC, EM106H, EM106M, EM106M+SC, EM106P, EM110H, EM110M, EM110M+SC, EM110P, EM210H, EM210M, EM210M+SC, EM210P, EV006M, EV106H, EV106M, EV106M+SC, EV106P, EV110H, EV110M, EV110M+SC, EV110P, EV210H, EV210M, EV210M+SC, EV210P, FE105M, FE105X, FE110M, FE110X, FE210M, FG105M, FG105X, FG110M, FG110X, FG210M, FG210X, GC106M, GC110M...(Other models you can see in the webshop)		





			
1			
<b>Part No.</b>	102067	<b>Ref. No.</b>	6A012300 939300 BN6A012300 MA939300
<b>description</b>	nut thread M8x1 H 3mm brass Qty 1 pcs type SEF 1		
<b>For models:</b>	702BMG, 704S, 706, 706S, C7011G, C7011GFE, C7011GFG, C704G, C707G, C707GFE, C707GFG, C9F4GS, C9F6G, C9F6GS, C9F8GS, C9SB-4GS, C9V2GS, C9V4GS, C9V6GS, C9V8GS, CFG101, CFG101D, CFG101L, CFG101P, CFG120, CFG70, CFG70D, CFG70L, CFG70M, CFG70P, EC74GVG, EC78GVG, EC7FG8G, OCFG101, OCFG120, OCFG70, T7011GFG, T707GFG, T9F6GS, TPF706, TPF706S		

washers

spring washers

			
1			
<b>Part No.</b>	697933	<b>Ref. No.</b>	R61420021
<b>description</b>	spring washer ID ø 13mm ED ø 24mm Qty 1 pcs		
<b>For models:</b>	ME120M, ME120P, ME120X, ME201D, ME201M, ME201P, ME201T, ME202D, ME202M, ME202P, ME202T, ME220M, ME220P, ME220X, MEC24H, MEC40M, MEMT21D, MEMT21P, MEMT40D, MEMT40P, MEVT21D, MEVT21P, MEVT40D, MEVT40P, MG120M, MG120P, MG120X, MG201D, MG201M, MG201P, MG201T, MG202D, MG202M, MG202P, MG202T, MG220M, MG220P, MG220X, MGC20X, MGC24H, MGC40H, MGMT21D, MGMT21P, MGMT40D, MGMT40P, MGVT21D, MGVT21P, MGVT40D, MGVT40P, VE120M...(Other models you can see in the webshop)		

			
1			
<b>Part No.</b>	696397	<b>Ref. No.</b>	LAR61620091
<b>description</b>	spring washer ID ø 6.3mm ED ø 14mm Qty 1 pcs		
<b>For models:</b>	ME120M, ME120P, ME120X, ME201D, ME201M, ME201P, ME201T, ME202D, ME202M, ME202P, ME202T, ME220M, ME220P, ME220X, MEC24H, MEC40M, MEMT21D, MEMT21P, MEMT40D, MEMT40P, MEVT21D, MEVT21P, MEVT40D, MEVT40P, MG120M, MG120P, MG120X, MG201D, MG201M, MG201P, MG201T, MG202D, MG202M, MG202P, MG202T, MG220M, MG220P, MG220X, MGC20X, MGC24H, MGC40H, MGMT21D, MGMT21P, MGMT40D, MGMT40P, MGVT21D, MGVT21P, MGVT40D, MGVT40P, VE120M...(Other models you can see in the webshop)		

washers

DIN 125A

			
1			
<b>Part No.</b>	560112	<b>Ref. No.</b>	15830499 MA15830499
<b>description</b>	plain washer ID ø 5.3mm ED ø 10mm thickness 1mm SS Qty 20 pcs DIN 125A for thread M5		
<b>For models:</b>	BR707E, BR707EI, BR707G, BR707GI, BR94E, BR94EI, BR94G, BR94GI, BR96E, BR96EI, BR96G, BR96GI, BR9M4E, BR9M4EI, BR9M4G, BR9M4GI, BR9M6E, BR9M6EI, BR9M6G, BR9M6GI, BR9SB4E, BR9SB4EI, BR9SB4G, BR9SB4GI, EPC74E, EPC74G, PC12C4E, PC12C4G, PC12C9E, PC12C9G, PC74E, PC74G, PC76E, PC76G, PC78E, PC78G, PC94E, PC94G, PC96E, PC96G, PC98E, PC98G, PD707G, PI707E, PI707G, SER15, SER15A, SER18, SER18A, SER21		

miscellaneous

			
1			
<b>Part No.</b>	691296	<b>Ref. No.</b>	R61400052
<b>description</b>	plain washer ID ø 10.5mm ED ø 21mm thickness 2mm SS Qty 1 pcs for fan wheel		
<b>For models:</b>	CVE105H, CVE105M, CVG105H, CVG105M, EC106M, EM106H, EM106M, EM106M+SC, EM106P, EV006M, EV106H, EV106M, EV106M+SC, EV106P, FE105M, FE105X, FG105M, FG105X, GC106M, GM106H, GM106M, GM106M+SC, GM106P, GMT06D, GV106H, GV106M, GV106M+SC, GV106P, GVT06D, MACE07M, MACE07M, ME061D, ME061M, ME061P, ME061T, ME106M, ME106P, ME106X, MEMT06D, MEMT06P, MEVT06D, MEVT06P, MG061D, MG061M, MG061P, MG061T, MG106M, MG106P, MG106X, MGMT06D...(Other models you can see in the webshop)		

			
1			
<b>Part No.</b>	691292	<b>Ref. No.</b>	R10401710
<b>description</b>	plain washer ID ø 12mm ED ø 17.5mm thickness 1mm SS Qty 1 pcs		
<b>For models:</b>	GMT06D, GMT20D, GVT06D, GVT20D, MACE07M, MACE10M, MACE20M, MACEG07M, MACEG10M, MACEG20M, ME061D, ME061M, ME061P, ME061T, ME101D, ME101M, ME101P, ME101T, ME102D, ME102M, ME102P, ME102T, ME106M, ME106P, ME106X, ME110M, ME110P, ME110X, ME210M, ME210P, ME210X, MEMT06D, MEMT06P, MEMT10D, MEMT10P, MEMT20D, MEMT20P, MEVT06D, MEVT06P, MEVT10D, MEVT10P, MEVT20D, MEVT20P, MG061D, MG061M, MG061P, MG061T, MG101D, MG101M, MG101P...(Other models you can see in the webshop)		

tools, fastening materials, consumables



 1			
<b>Part No.</b>	690593	<b>Ref. No.</b>	LA58002570 LAR58002570
<b>description</b>	plain washer ID $\varnothing$ 15mm ED $\varnothing$ 30mm thickness 3mm Qty 1 pcs for door hinge		
<b>For models:</b>	ME120M, ME120P, ME120X, ME201D, ME201M, ME201P, ME201T, ME202D, ME202M, ME202P, ME202T, ME220M, ME220P, ME220X, MEC24H, MEC40M, MEMT21D, MEMT21P, MEMT40D, MEMT40P, MEVT21D, MEVT21P, MEVT40D, MEVT40P, MG120M, MG120P, MG120X, MG201D, MG201M, MG201P, MG201T, MG202D, MG202M, MG202P, MG202T, MG220M, MG220P, MG220X, MGC20X, MGC24H, MGC40H, MGMT21D, MGMT21P, MGMT40D, MGMT40P, MGVT21D, MGVT21P, MGVT40D, MGVT40P, VE120M...(Other models you can see in the webshop)		

 2			
<b>Part No.</b>	524117	<b>Ref. No.</b>	15800499
<b>description</b>	plain washer ID $\varnothing$ 6.4mm ED $\varnothing$ 12mm thickness 1.6mm SS Qty 1 pcs		

 1			
<b>Part No.</b>	551434	<b>Ref. No.</b>	LA58004010 LAR58004010
<b>description</b>	plain washer $\varnothing$ 30mm thickness 3mm hole $\varnothing$ 12.5mm for fan wheel combi-steamer		
<b>For models:</b>	EC110M, EC210M, EM010M+SC, EM110H, EM110M, EM110M+SC, EM110P, EM210H, EM210M, EM210M+SC, EM210P, EV110H, EV110M, EV110M+SC, EV110P, EV210H, EV210M, EV210M+SC, EV210P, FE110M, FE110X, FE210M, FG110M, FG110X, FG210M, FG210X, GC110M, GC210M, GM110H, GM110M, GM110M+SC, GM110P, GM210H, GM210M, GM210M+SC, GM210P, GMT20D, GV110H, GV110M, GV-110M+SC, GV110P, GV210H, GV210M, GV210M+SC, GV210P, GVT20D, MACE10M, MACE20M, MACG10M, MACG20M...(Other models you can see in the webshop)		

## tooth lock washers

## DIN 6798A

 1			
<b>Part No.</b>	560193	<b>Ref. No.</b>	15812699 MA15812699
<b>description</b>	tooth lock washer ID $\varnothing$ 10.4mm ED $\varnothing$ 18mm zinc-coated steel DIN/ISO DIN 6798A Qty 1 pcs for thread M10		
<b>For models:</b>	CPE60, CPE602, CPE60DB, OCPE6, OCPE60		

## fasteners

## clamps

## hose clamps

## DIN 3017 - W2

 1			
<b>Part No.</b>	520111	<b>Ref. No.</b>	450102
<b>description</b>	hose clamp $\varnothing$ 10-16mm width 9mm Qty 10 pcs DIN 3017		

 1			
<b>Part No.</b>	520112	<b>Ref. No.</b>	450103 LAR61630011
<b>description</b>	hose clamp $\varnothing$ 12-20mm width 9mm Qty 10 pcs DIN 3017		
<b>For models:</b>	CVE004H, CVE004M, CVE104H, CVE104M, CVE105H, CVE105M, CVG105H, CVG105M, EC106M, EC110M, EC210M, EM010M+SC, EM106H, EM106M, EM106M+SC, EM106P, EM110H, EM110M, EM110M+SC, EM110P, EM210H, EM210M, EM210M+SC, EM210P, EV006M, EV106H, EV106M, EV106M+SC, EV106P, EV110H, EV110M, EV110M+SC, EV110P, EV210H, EV210M, EV210M+SC, EV210P, GC106M, GC110M, GC210M, GM106H, GM106M, GM106M+SC, GM106P, GM110H, GM110M, GM110M+SC, GM110P, GM210H, GM210M...(Other models you can see in the webshop)		

 1			
<b>Part No.</b>	520115	<b>Ref. No.</b>	450105
<b>description</b>	hose clamp $\varnothing$ 25-40mm width 9mm Qty 10 pcs DIN 3017		

 1			
<b>Part No.</b>	520116	<b>Ref. No.</b>	450107
<b>description</b>	hose clamp $\varnothing$ 32-50mm width 9mm Qty 5 pcs DIN 3017		

 1			
<b>Part No.</b>	520119	<b>Ref. No.</b>	450119
<b>description</b>	hose clamp $\varnothing$ 60-80mm width 9mm Qty 5 pcs DIN 3017		





			
1			
<b>Part No.</b>	520117	<b>Ref. No.</b>	450135
<b>description</b>	hose clamp stainless steel ø 40-60mm width 9mm Qty 5 pcs DIN 3017		

## consumables

### fuses

#### fine fuses

			
1			
<b>Part No.</b>	358532	<b>Ref. No.</b>	R65200200
<b>description</b>	fine fuse size ø5x20mm 2A fast-acting rated 250V Qty 10 pcs		
<b>For models:</b>	CVE004H, CVE004M, CVE104H, CVE104M, CVE105H, CVE105M, CVG105H, CVG105M, EC106M, EC110M, EC210M, EM010M+SC, EM106H, EM106M, EM106M+SC, EM106P, EM110H, EM110M, EM110M+SC, EM110P, EM210H, EM210M, EM210M+SC, EM210P, EV006M, EV106H, EV106M, EV106M+SC, EV106P, EV110H, EV110M, EV110M+SC, EV110P, EV210H, EV210M, EV210M+SC, EV210P, FE105M, FE105X, FE110M, FE110X, FE210M, FG105M, FG105X, FG110M, FG110X, FG210M, FG210X, GC106M, GC110M...(Other models you can see in the webshop)		

			
1			
<b>Part No.</b>	358593	<b>Ref. No.</b>	R65200086
<b>description</b>	fine fuse size ø5x20mm 0.125A slow-acting rated 250V Qty 10 pcs		
<b>For models:</b>	CVE004H, CVE104H, CVE105H, CVG105H, EM010M+SC, EM106H, EM106M+SC, EM106P, EM110M+SC, EM110P, EM210M+SC, EM210P, EV106H, EV106M+SC, EV106P, EV110M+SC, EV110P, EV210M+SC, EV210P, GM106H, GM106M+SC, GM106P, GM110M+SC, GM110P, GM210M+SC, GM210P, GV106H, GV106M+SC, GV106P, GV110M+SC, GV110P, GV210M+SC, GV210P, ME061P, ME061T, ME101P, ME101T, ME102P, ME102T, ME106M, ME106P, ME106X, ME110M, ME110P, ME110X, ME120M, ME120P, ME120X, ME201P, ME201T...(Other models you can see in the webshop)		

			
1			
<b>Part No.</b>	358592	<b>Ref. No.</b>	R65200140
<b>description</b>	fine fuse size ø5x20mm 0.1A slow-acting rated 250V Qty 10 pcs		
<b>For models:</b>	GMT20D, MG061M, MG101D, MG101M, MG102D, MG102M, MG201D, MG201M, MGMT20D		

			
1			
<b>Part No.</b>	358595	<b>Ref. No.</b>	R65200320
<b>description</b>	fine fuse size ø5x20mm 0.2A slow-acting rated 250V Qty 10 pcs		
<b>For models:</b>	EC106M, EM106H, EM106M, EM106M+SC, EM106P, EM110H, EM110P, EM210H, EM210P, EV006M, EV106H, EV106M, EV106M+SC, EV106P, EV110H, EV110P, EV210H, EV210P, FG105X, GC106M, GM106H, GM106M, GM106M+SC, GM106P, GM110H, GM210H, GV106H, GV106M, GV106M+SC, GV106P, GV110H, GV210H, MACE10M, MACE20M, ME061P, ME061T, ME101D, ME101M, ME102D, ME102M, ME106P, ME106X, ME110P, ME120P, ME201D, ME201M, ME210P, ME220P, MEC24H, MEMT10D...(Other models you can see in the webshop)		

			
1			
<b>Part No.</b>	358703	<b>Ref. No.</b>	R65200350
<b>description</b>	fine fuse size ø5x20mm 0.4A slow-acting rated 250V Qty 10 pcs		
<b>For models:</b>	EC110M, EC210M, EM010M+SC, EM110H, EM110M, EM110M+SC, EM110P, EM210H, EM210M, EM210M+SC, EM210P, EV110H, EV110M, EV110M+SC, EV110P, EV210H, EV210M, EV210M+SC, EV210P, FE105X, FG110X, FG210X, GC110M, GC210M, GM110H, GM110M, GM110M+SC, GM110P, GM210H, GM210M, GM210M+SC, GM210P, GV110H, GV110M, GV110M+SC, GV110P, GV210H, GV210M, GV210M+SC, GV210P, ME110P, ME110X, ME120P, ME120X, ME210P, ME210X, ME220P, ME220X, MEC24H, MEC40M...(Other models you can see in the webshop)		

5 tools, fastening materials, consumables

**GASTROPARTS.COM**



© 2020 Gastroparts Sp. J. All rights reserved.