



GASTROPARTS

Lincat

[EN] Cooking

[DE] Kochtechnik

[ES] Cocción

[FR] Cuisson

[IT] Cottura

[PL] Obróbka termiczna

[RU] Термическая обработка

✉ gastroparts@gastroparts.com

☎ tel. +48 56 657 00 66

📘 fb.com/gastroparts.global

GASTROPARTS.COM





heating elements

immersion heating elements

special flanges



1

Part No.	420519	Ref. No.	OEL32
description	heating element 18000W 230/400V heating circuits 1 L 188mm W 66mm flange length 123mm flange width 102mm connection cable included cable length 850mm boiler		

miscellaneous



1

Part No.	418370	Ref. No.	OEL18
description	heating element 18000W 230V heating circuits 6 L 194mm W 87mm H 68mm hole distance 50mm hole \varnothing 8mm number of thermostat sleeves 2 thermostat sleeves \varnothing 6/2mm length thermostat sleeves 142/105mm thermostat sleeve clinging cable length 730mm immersion heater 10 hole flange		
accessories for	418370		
	Part No.	379078	Ref. No. —
	temperature probe thermocouple K (NiCr-Ni) cable silicone probe -50 up to 1150°C cable -50 up to +180°C connection 2-wire thread probe \varnothing 1.5x100mm cable length 1.8m		
	Part No.	550894	Ref. No. OGA14
	gasket L 122mm W 101mm thickness 4mm for heating element suitable for RATIONAL equiv. no. 4400279		



1

Part No.	418369	Ref. No.	OEL17
description	heating element 9000W 230V heating circuits 3 L 192mm W 39mm H 68mm hole distance 90mm hole \varnothing 8mm thermostat sleeves \varnothing 2.5/6.5mm length thermostat sleeves 155mm number of thermostat sleeves 2 thermostat sleeve eccentric, clinging flange length 82mm flange width 82mm tube \varnothing 6.5mm cable length 200mm immersion heater 5 hole flange		
accessories for	418369		
	Part No.	379078	Ref. No. —
	temperature probe thermocouple K (NiCr-Ni) cable silicone probe -50 up to 1150°C cable -50 up to +180°C connection 2-wire thread probe \varnothing 1.5x100mm cable length 1.8m		
	Part No.	550893	Ref. No. OGA15
	gasket L 81mm W 81mm hole distance 65mm thickness 4mm for heating element suitable for RATIONAL equiv. no. 4400280		



1

Part No.	415550	Ref. No.	OEL02
description	heating element 9000W 230V heating circuits 3 L 205mm W 38mm H 70mm number of thermostat sleeves 1 thermostat sleeves \varnothing 2.5mm length thermostat sleeves 120mm thermostat sleeve eccentric, clinging tube \varnothing 6.3mm hole distance 64mm hole \varnothing 8mm connection male faston 6.3mm 4 hole flange immersion heater flange width 82mm flange length 82mm		
accessories for	415550		
	Part No.	379078	Ref. No. —
	temperature probe thermocouple K (NiCr-Ni) cable silicone probe -50 up to 1150°C cable -50 up to +180°C connection 2-wire thread probe \varnothing 1.5x100mm cable length 1.8m		
	Part No.	510565	Ref. No. —
	gasket rubber L 82mm W 82mm thickness 4mm hole \varnothing 9mm hole distance 64mm for heating element suitable for RATIONAL 4 holes		



1

Part No.	417646	Ref. No.	OEL10 OEL34
description	heating element 9000W 400V L 195mm W 40mm H 80mm number of thermostat sleeves 1 thermostat sleeves \varnothing 6mm length thermostat sleeves 132mm tube \varnothing 6mm hole distance 61mm hole \varnothing 7.5mm cable length 60mm combi-steamer flange width 82mm flange length 82mm with gasket with thermowell		

heating elements for convection



1

Part No.	418376	Ref. No.	OEL23
description	heating element 18000W 230V heating circuits 3 ID \varnothing 410mm ED \varnothing 477mm L 477mm H 110mm W1 110mm H1 20mm H2 90mm flange length 140mm flange width 62mm hole distance 64mm connection cable connection length 70mm tube \varnothing 6.3mm convection heating element		
accessories for	418376		
	Part No.	550696	Ref. No. OGA36
	gasket L 140mm W 62mm hole \varnothing 5mm hole distance 56mm 6 holes thickness 2mm for heating element suitable for RATIONAL equiv. no. 4000332		





1

Part No.	418382	Ref. No.	OEL24
description	heating element 18000W 230V heating circuits 6 ID ø 407mm ED ø 485mm L 485mm H 106mm W1 111mm H1 11mm H2 85mm flange length 140mm flange width 72mm hole distance 128mm connection cable connection length 98mm tube ø 6.6mm cable length 600mm convection heating element hole ø 5mm rectangular flange L1 485mm		



1

Part No.	418385	Ref. No.	OEL25
description	heating element 30000W 230V heating circuits 6 ID ø 573mm ED ø 630mm L 655mm H 120mm W1 135mm H1 15mm H2 110mm flange length 160mm flange width 75mm hole distance 74mm connection cable connection length 95mm tube ø 8.5mm cable length 600mm convection heating element hole ø 6mm rectangular flange L1 8mm		
accessories for	418385		
	Part No.	560611	Ref. No. —
	gasket L 160mm W 75mm for heating element thickness 2mm hole distance 74mm SCC Linie 102/202		



1

Part No.	418995	Ref. No.	EL141
description	heating element 3000W 230V heating circuits 1 ID ø 193mm ED ø 205mm L 225mm H 35mm L1 15mm W1 30mm H1 8mm H2 28mm flange length 70mm flange width 22.5mm hole distance 56mm connection male faston 6.3mm vertical tube ø 6.3mm		
For models:	ECO9, OE7008		



1

Part No.	419255	Ref. No.	EL103
description	heating element 3000W 240V heating circuits 1 ID ø 330mm ED ø 365mm L 390mm H 90mm L1 22mm H1 60mm H2 40mm flange length 75mm flange width 30mm hole distance connection male faston 6.3mm tube ø 8.5mm		
For models:	ECO7, V6, V6D, V6F, V7		



1

Part No.	418377	Ref. No.	OEL35
description	heating element 6000W 230V heating circuits 3 ID ø 404mm ED ø 420mm L 440mm H 107mm W1 112mm H1 20mm H2 84mm flange length 140mm flange width 61mm hole distance 65mm connection cable tube ø 6.5mm cable length 300mm convection heating element hole ø 5.5mm rectangular flange L1 7mm		

accessories

flange gaskets



1

Part No.	550696	Ref. No.	OGA36
description	gasket L 140mm W 62mm hole ø 5mm hole distance 56mm 6 holes thickness 2mm for heating element suitable for RATIONAL equiv. no. 4000332		



1

Part No.	550894	Ref. No.	OGA14
description	gasket L 122mm W 101mm thickness 4mm for heating element suitable for RATIONAL equiv. no. 4400279		



1

Part No.	550893	Ref. No.	OGA15
description	gasket L 81mm W 81mm hole distance 65mm thickness 4mm for heating element suitable for RATIONAL equiv. no. 4400280		

counterflanges



1

Part No.	693547	Ref. No.	OGA35
description	flange L 140mm suitable for convection heating element mounting pos. outer		



energy regulators

EGO

1-circuit



Part No.	380019	Ref. No.	EN10
description	energy regulator 240V 13A single-circuit turn direction right shaft \varnothing 6x4.6mm shaft L 23mm mounting thread M4 power release 6-100% no. 50.57071.010		
For models:	BM3, BM4, BM6, BM7, BS3, BS4, BS7, CS4, CS4G, CS6, CT1, ECG6, LBM, LBM2, LBM2W, LBM3, LBMW, LCS, LGT, LPB, LPC, LRB, LRB2W, LRB3, LRBW, LSC, OE7303, OE7304		

thermostats

control and safety thermostats

EGO

control thermostats

55.13_ series



Part No.	375086	Ref. No.	OTH09
description	thermostat t.max. 180°C temperature range 60-180°C 1-pole 1CO 16A probe \varnothing 6mm probe L 90mm capillary pipe 2400mm capillary pipe isolated 2300mm gland nut shaft \varnothing 6x4.6mm shaft L 25mm shaft position upper rotation 270° probe material SS		



Part No.	375484	Ref. No.	TH46
description	thermostat t.max. 260°C temperature range 48-260°C 1-pole NO 16A probe \varnothing 3mm probe L 160mm capillary pipe 1580mm capillary pipe isolatedmm gland nut shaft \varnothing 6x4.6mm shaft L 23mm shaft position upper rotation 270°		
For models:	ECO76, LCG, LCO, LPG, LRG, OE7008, OE7010, UMO50, UMS050, UMS050D		

55.17_ series

E-G-O



Part No.	391011	Ref. No.	TH106 TH106 + GL66
description	thermostat t.max. 103°C temperature range 30-103°C 1-pole 1NO 16A probe \varnothing 6mm probe L 70mm capillary pipe 1450mm capillary pipe isolatedmm gland nut shaft \varnothing 6x4.6mm shaft L 23mm shaft position left		

E-G-O



Part No.	391024	Ref. No.	TH107
description	thermostat t.max. 320°C temperature range 50-320°C 1-pole 1NO 16A probe \varnothing 3.1mm probe L 163mm capillary pipe 880mm capillary pipe isolatedmm gland nut shaft \varnothing 6x4.6mm shaft L 23mm shaft position lower probe material SS		

55.18_ series

E-G-O



Part No.	375483	Ref. No.	TH12
description	thermostat t.max. 320°C temperature range 50-320°C 1-pole NO 16A probe \varnothing 3mm probe L 158mm capillary pipe 870mm capillary pipe isolatedmm gland nut shaft \varnothing 6x4.6mm shaft L 23mm shaft position upper rotation 270°		
For models:	ECO76, ECO8, ECO9, ESLR9, GG1, GS6T, GS6TE, LGR, LGR2, LPO, OE7206, OE7209		



safety thermostats

55.32_ series



Part No.	375684	Ref. No.	TH63
description	safety thermostat switch-off temp. 360°C 1-pole 20A probe ø 11mm probe L 16mm capillary pipe 900mm capillary pipe isolated 900mm gland nut probe screw-in probe probe thread M14x1		
For models:	ECO9, ESLR9, OE7008, OE7010		



Part No.	375774	Ref. No.	OTH08
description	safety thermostat switch-off temp. 365°C 1-pole 16A probe ø 4mm probe L 96mm capillary pipe 1160mm capillary pipe isolated 1100mm gland nut probe SS with special screwing screw connection M10x1		

accessories

gland nut accessories

ducts



Part No.	550148	Ref. No.	GL66
description	gland duct ET M12x0.75 IT M9x1 probe ø max. 6.5mm WS 17 silicone		

switches and momentary switches

rocker/momentary rocker switches

26.5x22mm



Part No.	301252	Ref. No.	SW66
description	rocker switch mounting measurements 26.5x22mm green 2NO 250V 16A illuminated 0-I connection male faston 6.3mm ambient temperature max. 125°C protection IP40		
For models:	ECO76, ECO8, HC3, HC4, HC6, HC7, HCL3, HCL4, HCL6, HCL7, HCL9, L3, L4		

30x22mm



Part No.	301001	Ref. No.	NE14
description	rocker switch mounting measurements 30x22mm red 2NO 250V 16A illuminated 0-I connection male faston 6.3mm ambient temperature max. 125/55°C protection IP65		
For models:	OE7503		
accessories for	301001		



Part No.	301036	Ref. No.	—
description	protective cover internal size 30x22mm for rocker switch mounting measurementsmm		

55.33_ series





Part No.	375487	Ref. No.	TH61
description	safety thermostat switch-off temp. 230°C 3-pole NC 20A probe ø 6mm probe L 103mm capillary pipe 1170mm capillary pipe isolatedmm gland nut starting temperature 116°C probe		
For models:	DF33, DF36, DF39, DF46, DF49, DF618, DF66, DF66ST, J12, J18, J6, J9, OE7105		

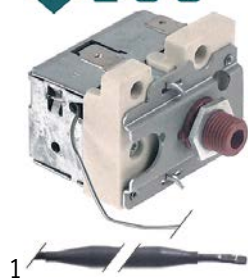

56_ series



Part No.	375862	Ref. No.	OTH07
description	safety thermostat switch-off temp. 183°C 1-pole 16A probe ø 6mm probe L 61mm capillary pipe 1460mm capillary pipe isolated 1400mm gland nut probe SS		



			
1			
Part No.	346978	Ref. No.	SW35
description	momentary rocker switch mounting measurements 30x22mm black 2CO 250V 16A connection male faston 6.3mm ambient temperature max. 125/55°C protection IP40		
For models:	EC076, EC08, EC09		
accessories for	346978		
	Part No.	301036	Ref. No. —
	protective cover internal size 30x22mm for rocker switch mounting measurementsmm		

			
1			
Part No.	301004	Ref. No.	SW23 SW34
description	rocker switch mounting measurements 30x22mm black 2CO 250V 16A connection male faston 6.3mm ambient temperature max. 125/55°C protection IP40		
For models:	EC076, EC08, EC09		
accessories for	301004		
	Part No.	301036	Ref. No. —
	protective cover internal size 30x22mm for rocker switch mounting measurementsmm		

push/momentary push switches

19x13mm

			
1			
Part No.	345690	Ref. No.	SW88
description	momentary push switch mounting measurements 19x13mm black 1NO 250V 16A connection male faston 4.8mm ambient temperature max. 105°C protection IP40		

microswitches

roller-lever actuated

microswitches

			
1			
Part No.	347949	Ref. No.	OSW11
description	microswitch with handle with a switch 250V 0.1A 1NC connection male faston 6.3mm L 21mm L1 12mm mounting distance 24mm white		

cam switches

on/off

			
1			
Part No.	301115	Ref. No.	SW58
description	cam switch 2 operating positions 2NO sequence 0-1 16A shaft ø 6x4.6mm shaft L 23mm connection male faston 6.3mm		
For models:	ESLR9, OE7008, OE7010		

magnetic switches

32x15mm

			
1			
Part No.	346510	Ref. No.	OSW09
description	magnetic switch		

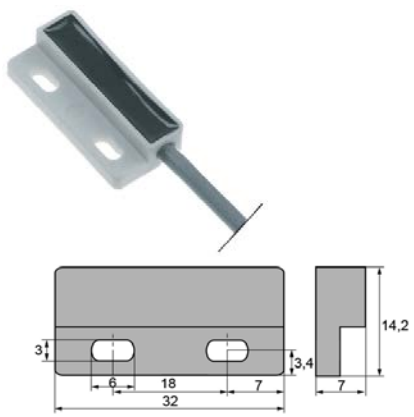
			
1			
Part No.	346515 ¹	Ref. No.	OD017
description	magnetic switch L 32mm W 15mm 1NO 250V 0.5A P max. 50W connection coded plug cable length 1750mm		

¹with coded connector



accessories

magnets

 <p>1</p>			
Part No.	346514	Ref. No.	ODO18
description	magnet ø 10mm L 40mm Hmm Wmm		

 <p>1</p>			
Part No.	345110	Ref. No.	ODO15
description	magnet ømm L 25mm H 9mm W 15mm		

magnetic holders

 <p>1</p>			
Part No.	541986	Ref. No.	ODO21
description	magnet holder with magnet ø 13mm		

encoders and potentiometers

 <p>1</p>			
Part No.	300198	Ref. No.	OGE02
description	encoder		

 <p>1</p>			
Part No.	300197	Ref. No.	OPO02
description	potentiometer 4.7KOhm rotation 360° shaft ø 5.9mm with switch shaft L 22mm		

 <p>1</p>			
Part No.	400106	Ref. No.	OGE01
description	pulsor KOhm rotation 360° shaft ø 6mm type CPC		

lamps

indicator lights

indicator lights (complete)

ø10mm

with plug-in socket

 <p>1</p>			
Part No.	359139	Ref. No.	NE43
description	indicator light ø 10mm green 230V connection male faston 6.3mm Qty 1 pcs		
For models:	BM3, BM3W, BM4, BM4W, BM6, BM6W, BM7, BM7W, BS3, BS3W, BS4, BS4W, BS7, BS7W, CS4, CS4G, CS6, DF33, DF36, DF39, DF46, DF49, DF612, DF618, DF66, DF66ST, ECG6, ECO76, ECO8, ECO9, ESLR9, GG1, GS3, GS4, GS4E, GS6, GS6T, GS6TE, GS7, GS7E, GS9, HT3, HT6, HT7, J12, J18, J6, J9, LBM, LBM2...(Other models you can see in the webshop)		

 <p>1</p>			
Part No.	359140	Ref. No.	NE42
description	indicator light ø 10mm yellow 230V connection male faston 6.3mm Qty 1 pcs		
For models:	DF33, DF36, DF39, DF46, DF49, DF612, DF618, DF66, DF66ST, ECO76, ECO8, ECO9, ESLR9, GG1, GS3, GS4, GS4E, GS6, GS6T, GS6TE, GS7, GS7E, GS9, J12, J18, J6, J9, LCG, LCG2, LCO, LDF, LDF2, LFF, LGR, LGR2, LPG, LPG2, LPO, LRG, LRG2, LSC, PB33, PB66, UM50, UM50D, UMO50, UMS50, UMS50D, UMSO50, UMSO50D		

ø13mm

with plug-in socket

 <p>1</p>			
Part No.	359142	Ref. No.	NE38
description	indicator light ø 13mm green 230V connection male faston 6.3mm temp.-resist. 120°C Qty 1 pcs		
For models:	FWD, FWDG, G1A, GBM2, GBM3, KFCWD		

ø19mm

 <p>1</p>			
Part No.	359564	Ref. No.	NE40
description	indicator light ø 19mm 230V orange connection male faston 6.3mm		
For models:	OE7008, OE7010, OE7104, OE7105, OE7112, OE7113, OE7206, OE7209, OE7210, OE7503		



miscellaneous



1

Part No.	359066	Ref. No.	ONE02
description	indicator light mounting measurements 30x21mm green 230V		

screw-on/push-on fit

light bulbs

for ovens



1

Part No.	357153	Ref. No.	LA08
description	light bulb t.max. 300°C socket E14 25W 230V ø 25mm L 55mm lens L 30mm for oven type		



1

Part No.	359611	Ref. No.	LA)\$ LA94
description	light bulb t.max. 300°C socket E14 40W 230V ø 45mm L 75mm lens L 50mm for oven lamp IMPORT		
For models:	ECO76		

halogen lamp

for socket G4 / G6.35 / G9



1

Part No.	359596	Ref. No.	OBU02
description	halogen lamp socket G4 12V 10W temp.-resist. 500°C		





oven lamps

universal oven lamps

mounting diameter 65.5mm



1





Part No.	359712	Ref. No.	LA87	
description	oven lamp mounting ø 65.5mm 230V 40W socket E14 temp.-resist. 300°C connection male faston 6.3mm hard glas			
For models:	ECO76			
spare parts for	359712			
	Part No.	359022	Ref. No.	—
	lamp socket socket E14 mounting ø 65.5mm connection male faston 6.3mm			
	Part No.	359611	Ref. No.	LA)\$ LA94
	light bulb t.max. 300°C socket E14 40W 230V ø 45mm L 75mm lens L 50mm for oven lamp IMPORT			
	Part No.	359722	Ref. No.	—
	gasket silicone ID ø 57.5mm ED ø 68mm thickness 2mm			
	Part No.	359724	Ref. No.	—
	oven lamp glass thread ø 62mm H 46mm ø 74mm hard glas temp.-resist. 350°C			

producer-specific oven lamps

LINCAT





1

Part No.	359876	Ref. No.	OBU07	
description	frame SS for lamp lenses W 90mm L 113mm C-Line, CPC, SCC 61-202			
accessories for	359876			
	Part No.	359877	Ref. No.	OBU03
	lamp glass L 95mm W 72mm thickness 4mm C-Line, CPC, SCC 61-202			
	Part No.	359879	Ref. No.	OBU05
	gasket L 99mm W 75mm C-Line, CPC, SCC 61-202			
	Part No.	359880	Ref. No.	OBU04
	gasket L 95mm W 72mm C-Line, CPC, SCC 61-202			
	Part No.	560448	Ref. No.	—
	hexagonal screw thread M5 thread L 8mm SS WS 8 Qty 1 pcs head thickness 4mm DIN 933 / ISO 4017			









			
1			
Part No.	359882	Ref. No.	OBU09
description	gasket L 81mm W 65mm		

			
1			
Part No.	359881	Ref. No.	OBU10
description	gasket L 85mm W 70mm		

			
1			
Part No.	359880	Ref. No.	OBU04
description	gasket L 95mm W 72mm C-Line, CPC, SCC 61-202		

			
1			
Part No.	359879	Ref. No.	OBU05
description	gasket L 99mm W 75mm C-Line, CPC, SCC 61-202		

			
1			
Part No.	359878	Ref. No.	OBU11
description	lamp glass L 80mm W 65mm thickness 4mm		

			
1			
Part No.	359873	Ref. No.	OBU06
description	lamp socket socket G4 for halogen lamp		
accessories for	359873		
	Part No.	359876	Ref. No. OBU07
	frame SS for lamp lenses W 90mm L 113mm C-Line, CPC, SCC 61-202		
	Part No.	359877	Ref. No. OBU03
	lamp glass L 95mm W 72mm thickness 4mm C-Line, CPC, SCC 61-202		
	Part No.	359879	Ref. No. OBU05
	gasket L 99mm W 75mm C-Line, CPC, SCC 61-202		
	Part No.	359880	Ref. No. OBU04
	gasket L 95mm W 72mm C-Line, CPC, SCC 61-202		
	Part No.	360724	Ref. No. —
	lamp glass L 113mm W 90mm C-Line, CPC, SCC 61-202		

			
1			
Part No.	359874	Ref. No.	OBU13
description	lamp socket socket G4 for halogen lamp		

			
1			
Part No.	360716	Ref. No.	LA14
description	oven lamp mounting measurements 55x70mm 250V 25W socket E14 rectangular temp.-resist. 300°C connection F6.3		
For models:	ECO8, ECO9, L3, L4, LPW, LPW-LR		

			
1			
Part No.	359875	Ref. No.	OBU08
description	press frame with gasket		

lamps

light bulbs

			
1			
Part No.	357153	Ref. No.	LA08
description	light bulb t.max. 300°C socket E14 25W 230V ø 25mm L 55mm lens L 30mm for oven type		

			
1			
Part No.	359611	Ref. No.	LA)\$ LA94
description	light bulb t.max. 300°C socket E14 40W 230V ø 45mm L 75mm lens L 50mm for oven lamp IMPORT		
For models:	ECO76		

halogen lamps

for socket G4 / G6.35 / G9

			
1			
Part No.	359596	Ref. No.	OBU02
description	halogen lamp socket G4 12V 10W temp.-resist. 500°C		



alarm devices

buzzers



1

Part No.	350136	Ref. No.	OBU01
description	buzzer 12VAC connection cable 200mm screw mounting 63dB		

contactors

BENEDIKT & JÄGER

power contactors



1

Part No.	380772	Ref. No.	OCA30
description	power contactor resistive load 25A 230VAC (AC3/400V) 10A/4kW main contacts 3NO auxiliary contacts 1NO connection screw connection type K3-10A10230		



1





Part No.	381173	Ref. No.	OCO29
description	power contactor resistive load 50A 230VAC (AC3/400V) 24A/11kW main contacts 3NO auxiliary contacts 1NO connection torx type K3-24B00 50/60Hz		

GENERAL ELECTRIC (AEG)

power contactors



1

Part No.	380267	Ref. No.	OCO24	
description	power contactor resistive load 110A 230VAC (AC3/400V) 65A/30kW main contacts 3NO auxiliary contacts connection screw connection type AEG LS30K 00A type GE CL07A 300			
accessories for	380267			
	Part No.	380268	Ref. No.	—
	auxiliary contact contacts 1NO for contactors CL+LS_K connection screw AC-12 10A type AEG HS07K 10 type GE BCLF 10			
	Part No.	380269	Ref. No.	—
	auxiliary contact contacts 1NC AC15 6A for contactors CL+LS_K connection screw AC-12 10A type AEG HS07K 01 type GE BCLF 01			
	Part No.	380270	Ref. No.	—
	auxiliary contact contacts 1NO/1NC for contactors CL+LS_K connection screw AC-12 10A type AEG HS08K 11 type GE BCLL 11			
	Part No.	380271	Ref. No.	—
	auxiliary contact contacts 2NO for contactors CL+LS_K connection screw AC-12 10A type AEG HS08K 20 type GE BCLL 20			



1

Part No.	380498	Ref. No.	C0111 OCO19
description	power contactor resistive load 20A 230VAC (AC3/400V) 9A/4kW main contacts 4NO auxiliary contacts connection male faston 6.3mm type MC1A 400A type AEG LS05 01 FA type GE MC1A 400A		
For models:	DF36, DF39, DF46, DF49, DF612, DF618, DF66ST, EB4F, EB6, EB6T, ECG6, ECO76, ESLR9, J12, J18, J6, J9, OE7008, OE7010, OE7104, OE7206, OE7209		

1

Part No.	380244	Ref. No.	OC004
description	power contactor resistive load 25A 230VAC (AC3/400V) 9A/4kW main contacts 3NO auxiliary contacts 1NO connection screw connection type AEG LS4K 10A type GE CL00A 310		



1

Part No.	380261	Ref. No.	OC005
description	power contactor resistive load 32A 230VAC (AC3/400V) 17A/7.5kW main contacts 3NO auxiliary contacts 1NO connection screw connection type AEG LS7K 10A type GE CL02A 310		

MOELLER/EATON

power contactors



1

Part No.	380167	Ref. No.	OC020
description	power contactor resistive load 66A 230VAC (AC3/400V) 50A/22kW main contacts 3NO auxiliary contacts 1NO connection screw connection type DILM 50		

SIEMENS

power contactors



1

Part No.	380614	Ref. No.	CO215
description	power contactor resistive load 22A 230VAC (AC3/400V) 9A/4kW main contacts 3NO auxiliary contacts 1NO connection elastic terminals type 3RT2016-2AP01		

TELEMECANIQUE (Schneider Electric)

power contactors



1

Part No.	380967	Ref. No.	CO112
description	power contactor resistive load 20A 230VAC (AC3/400V) 9A/4kW main contacts 3NO auxiliary contacts 1NO connection screw connection type LC1K0910M7		
For models:	AS4, EB3, EB4, ECO9, OE7105, OE7112, OE7113, OE7206, OE7209, OE7503		

solid state relays

CELDUC



1

Part No.	400105	Ref. No.	ORO01	
description	solid state relay CELDUC 2 phase 65A 400V 24VDC L 58mm W 45mm plug-in connection screw type 40.00.453			
accessories for	400105			
	Part No.	401794	Ref. No.	—
	connecting cable L 1440mm 4-pole suitable for RATIONAL			



transformers

encapsulated transformers

with plug connection



1

Part No.	401472	Ref. No.	OTR06
description	transformer 1/20/50VA secondaryA H 70mm L 76mm W 104mm connection plug 50/60Hz type 110170 with fuse secondary 2.1/11.5/12VAC primary 230VAC		
spare parts for	401472		
	Part No.	358602	Ref. No. —
	fine fuse size ø5x20mm 1.6A slow-acting rated 250V Qty 10 pcs		



1

Part No.	401473	Ref. No.	OTR09
description	transformer 21.6VA H 70mm L 94mm W 71mm connection plug 50-60Hz type 40.00.592 moulded secondary 12VDC primary 200-250VAC		

probes

producer-specific probes

probes



1

Part No.	379430	Ref. No.	OTC14
description	core temperature probe thermocouple K (NiCr-Ni) cable silicone probe -50 up to 1150°C cable -50 up to +180°C connection coded plug thread probe ø1.5x140mm cable length 1.65m		



1

Part No.	378351	Ref. No.	OTC09
description	temperature probe thermocouple K (NiCr-Ni) cable silicone probe -50 up to 1150°C cable -50 up to +180°C connection coded plug thread M8 probe ø2x135mm cable length 1.3m		



1

Part No.	379864	Ref. No.	OTC07
description	temperature probe thermocouple K (NiCr-Ni) cable silicone probe -50 up to 1150°C cable -50 up to +180°C connection coded plug thread M8 probe ø2x50mm cable length 1.2m		



1

Part No.	379873	Ref. No.	OTC05
description	temperature probe thermocouple K (NiCr-Ni) cable silicone probe -50 up to 1150°C cable -50 up to +180°C connection coded plug thread probe ø1.5x180mm cable length 1.6m		



1

Part No.	379441	Ref. No.	OTC10
description	temperature probe thermocouple K (NiCr-Ni) cable silicone probe -50 up to 1150°C cable -50 up to +180°C connection coded plug thread probe ø2x125mm cable length 1.5m		



1

Part No.	379869	Ref. No.	OTC06
description	temperature probe thermocouple K (NiCr-Ni) cable silicone probe -50 up to 1150°C cable -50 up to +180°C connection coded plug thread probe ø2x70mm cable length 2.5m		



1

Part No.	379442	Ref. No.	OTC13
description	temperature probe thermocouple K (NiCr-Ni) cable silicone probe -50 up to 1150°C cable -50 up to +180°C connection coded plug thread probe ø2x90mm cable length 1.5m		



1

Part No.	379870	Ref. No.	OTC12 OTC15
description	temperature probe thermocouple K (NiCr-Ni) cable silicone probe -50 up to 1150°C cable -50 up to +180°C connection coded plug thread probe ø4.2mm cable length 1.7m		



core probes



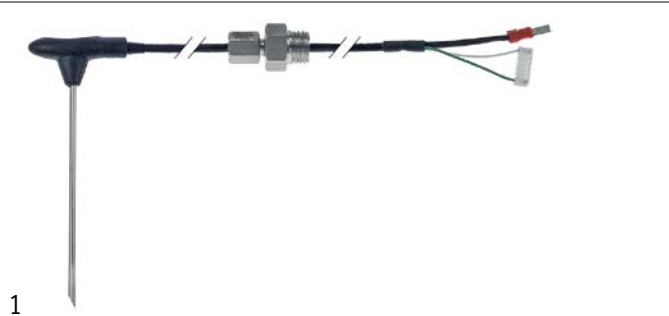

Part No.	379867	Ref. No.	OPR10
description	conversion kit thermocouple K (NiCr-Ni) cable PTFE probe -40 up to +250°C cable -40 up to +250°C connection plug probe ø3x100mm thread M16 cable length 2.2m handle ø 10mm handle length 40mm		



Part No.	381443	Ref. No.	OPR18
description	core temperature probe CM_P 61-102 cable PTFE insulated probe -40 up to +250°C probe ø3x100mm cable length 2.45m handle ø 12mm handle length 44mm		



Part No.	379792 ¹	Ref. No.	OPR07
description	core temperature probe thermocouple K (NiCr-Ni) cable PTFE probe -40 up to +250°C cable -40 up to +250°C connection grip connection probe ø3.2x100mm thread M16x2 cable length 1.9m handle ø 10mm handle length 40mm		
accessories for	379792		
	Part No.	510179	Ref. No. —
	flat gasket fibre ED ø 18mm ID ø 13mm thickness 1.5mm Qty 1 pcs		
	Part No.	560519	Ref. No. —
	nut thread M12x1 H 5mm WS 17 SS Qty 1 pcs		

¹ multipoint probe



Part No.	379868 ¹	Ref. No.	OPR09
description	core temperature probe thermocouple K (NiCr-Ni) cable PTFE probe -40 up to +250°C cable -40 up to +250°C connection plug probe ø3x100mm thread M16 cable length 2.2m handle ø 10mm handle length 40mm		

¹ multipoint probe

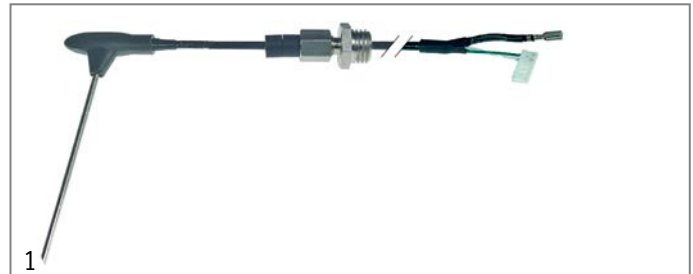

Part No.	379865	Ref. No.	OPR15
description	core temperature probe thermocouple K (NiCr-Ni) cable PTFE probe -40 up to +250°C cable -40 up to +250°C connection plug probe ø3x100mm thread M16 cable length 2.3m handle ømm handle length 50mm		

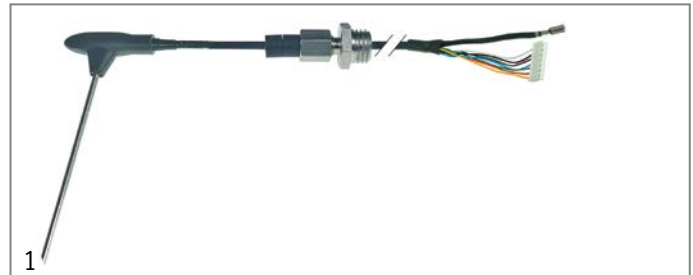

Part No.	379866 ¹	Ref. No.	OPR14
description	core temperature probe thermocouple K (NiCr-Ni) cable PTFE probe -40 up to +250°C cable -40 up to +250°C connection plug probe ø3x100mm thread M16 cable length 2.3m handle ømm handle length 50mm		

¹ multipoint probe

electronics

PCBs



Part No.	402827	Ref. No.	OPR13
description	control PCB combi-steamer CM101 L 372mm W 120mm type RAL115ET		



Part No.	401475	Ref. No.	OPR11
description	control PCB combi-steamer SCC Line		
accessories for	401475		
	Part No.	358791	Ref. No. OFU01
	fine fuse size ø6.3x32mm 6.3A slow-acting rated 250V Qty 10 pcs		



1			
Part No.	403797	Ref. No.	OPR23
description	control PCB for combi-steamer SCC_WE, CM_P 61-202 model Sicotronic		

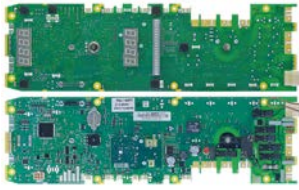

1			
Part No.	403796	Ref. No.	OPR20
description	control PCB for combi-steamer suitable for RATIONAL model Sicotronic		



1			
Part No.	403889	Ref. No.	OSC09
description	display for combi-steamer SCC_WE 61-202 complete incl. control		



1			
Part No.	401662	Ref. No.	OPR12
description	PCB combi-steamer CM101 conversion kit		



1			
Part No.	401629	Ref. No.	ORE03
description	relay shroud I/O-Board SCC Line		
accessories for	401629		



Part No.	358786	Ref. No.	—
fine fuse size ø6.3x32mm 2A slow-acting rated 250V Qty 10 pcs			

solenoid valves

solenoid valves (water)

ROBERTSHAW/INVENSYS

medium temperature:	90°C	90°C	60°C
ambient temperature:	60°C	25°C	60°C
duty cycle:	40%	100%	100%



1			
Part No.	374097	Ref. No.	SO22
description	solenoid valve single straight 230VAC inlet 1/2" outlet 1/2" DN10 t.max. 90°C flow regulating valve outlet orange		
For models:	OE7503, OG7502		

solenoid valves with reducers

single



1			
Part No.	370652	Ref. No.	OS009
description	solenoid valve single straight 230VAC inlet 3/4" outlet 11.5mm input 10l/min 10 EATON (INVENSYS) flow regulating valve inlet white		

3-fold



1			
Part No.	370672	Ref. No.	OS007
description	solenoid valve triple straight 230VAC inlet 3/4" outlet 11.5mm 10 EATON (INVENSYS) plastic output C 5l/min flow regulating valve outlet C black		

with coded terminal



1			
Part No.	370266	Ref. No.	OS003
description	solenoid valve double straight 230VAC inlet 3/4" outlet 11.5mm DN10 EATON (INVENSYS)		

1

Part No.	370267	Ref. No.	OS004
description	solenoid valve single straight 230VAC inlet 3/4" outlet 11.5mm DN10 EATON (INVENSYS)		



1

Part No.	370268	Ref. No.	OS006
description	solenoid valve single straight 230VAC inlet 3/4" outlet 11.5mm DN10 EATON (INVENSYS)		



1

Part No.	370270	Ref. No.	OS005
description	solenoid valve single straight 230VAC inlet 3/8" outlet 3/8" DN10 Invensys		

various





1

Part No.	370548	Ref. No.	SO1
description	solenoid valve single 240VAC inlet 3/4"		
For models:	ECO8, ECO9		

drain valves



1

Part No.	401889	Ref. No.	ODR10
description	drain valve 12V single inlet 40mm outlet 40mm for combi-steamer		
accessories for	401889		
	Part No.	Ref. No.	OGA38
	O-ring silicone thickness 3.5mm ID ø 26mm Qty 5 pcs for model SCC, CM		
	Part No.	Ref. No.	OGA37
	O-ring silicone thickness 3.5mm ID ø 46mm Qty 5 pcs for model SCC, CM		

pressure switches

for combi-steamers



1

Part No.	345709	Ref. No.	OSW10
description	pressure control ø 84mm pressure range 0-3mbar for humidity measuring connection 6mm p max 0.025bar pressure connection 6mm		



1

Part No.	541329	Ref. No.	OSW03
description	pressure control pressure range 350/150mbar connection 8mm pressure connection 8mm		

electrodes



1

Part No.	403298	Ref. No.	OEL29 OEL33
description	level electrode M15x1.5 total length 110mm probe L 85mm insulated probe length 75mm with extension connection coded plug ø 2mm suitable for RATIONAL		



1

Part No.	403297	Ref. No.	OEL21
description	level electrode M15x1.5 total length 190mm probe L 165mm insulated probe length 153mm with extension connection coded plug ø 2mm suitable for RATIONAL		







1

Part No.	400163	Ref. No.	OEL03
description	level electrode PG9 total length 100mm probe L 72/43/22mm insulated probe length 70/62/52mm with 3 probes connection grip connection		



			
1			
Part No.	400021	Ref. No.	OEL05
description	level electrode PG9 total length 110mm probe L 70/47/24mm insulated probe length 62/38/16mm with 3 probes connection grip connection		

			
1			
Part No.	400022	Ref. No.	OEL04
description	level electrode PG9 total length 135mm probe L 89/59/28mm insulated probe length 80mm with 3 probes connection grip connection		
accessories for	400022		
	Part No.	379729	Ref. No. OCA21
	connection cable L 1230mm 4-pole for level electrode plug type coded		
	Part No.	550574	Ref. No. —
	nut thread PG9 H 3mm WS 28 nickel-plated brass Qty 1 pcs mounting ømm cable ømm		

			
1			
Part No.	403804	Ref. No.	OEL28
description	level electrode with cable M15x1.5 probe L 12mm total length 325mm insulated probe length 114mm straight connection plug-in connection ø 1.5mm EPDM		

flow meters and flow sensors

flow sensors

			
1			
Part No.	403301	Ref. No.	OLE05
description	flow sensor inlet ø 10mm outlet ø 10mm L 104mm connection coded plug cable length 1300mm flow rate 1-25l/min		

			
1			
Part No.	402256	Ref. No.	OLE03
description	flow sensor inlet ø 10mm outlet ø 10mm L 110mm flow rate 1-25l/min		

			
1			
Part No.	403302	Ref. No.	OSE15
description	flow sensor inlet ø 3/4" ET outlet ø 3/4" IT L 78mm connection coded plug cable length 1300mm flow rate 1-25l/min		

fans

axial fans

ebm-papst

			
1			
Part No.	601309 ¹	Ref. No.	OFA16
description	axial fan L 127mm W 127mm H 38mm 12VDC 21W bearing ball bearing manuf. no. DV5212N metal connection cable ebm-papst suitable for RATIONAL fan wheel ø 120mm temp.-resist. 65°C		

¹with ball bearings

			
1			
Part No.	601752 ¹	Ref. No.	OFA18
description	axial fan L 127mm W 127mm H 38mm 12VDC 21W bearing ball bearing manuf. no. DV5212N plastic/metal connection cable 310mm ebm-papst fan wheel ø 120mm temp.-resist. 65°C SCC Line since 05/2008		

¹with ball bearings



import



Part No.	698721 ¹	Ref. No.	S/R0079
description	axial fan L 119mm W 119mm H 38mm 230VAC 50/60Hz 17/15W bearing ball bearing manuf. no. connection cable cable length 3000mm COMMONWEALTH fan wheel ø 110mm temp.-resist. 70°C input current 0.1A airflow 130m³/h 2600rpm		
For models:	CT1, ECO9		

¹with ball bearings

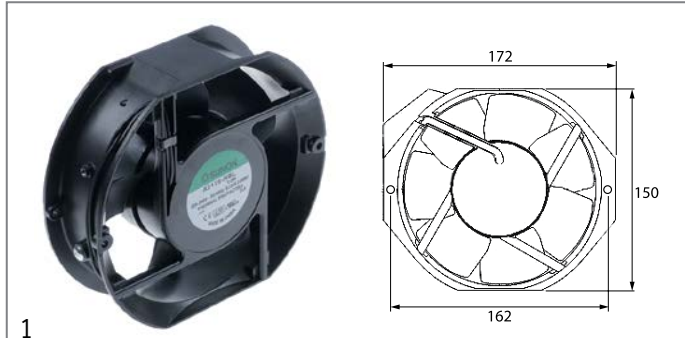

Part No.	601654 ¹	Ref. No.	FA62
description	axial fan L 172mm W 150mm H 51mm 230VAC 50/60Hz 28/24W bearing ball bearing manuf. no. A2175-HBL T.GN connection cable cable length 280mm metal SUNON fan wheel ø 142mm temp.-resist. -10 up to +80°C mounting distance 162mm		
For models:	SCR1085, SCR785		

¹with ball bearings

accessories

fan guards



Part No.	602141	Ref. No.	OFI02
description	guard with filter for axial flow fan L 126mm W 126mm H 13.5mm mounting distance 115mm suitable for ebm-papst		

converters



Part No.	381451	Ref. No.	OCO07
description	converter ebm-papst type AC 4400HT 100-240V for combi-steamer SCC_WE, CM_P		

hot air motors



Part No.	601301	Ref. No.	OFA12
description	fan motor 100-240V 1 phase 50/60Hz 0.45kW 2000rpm speeds 1 L1 160mm L2mm L3mm L4mm M8R IT fan wheel ø 130mm type M3G084-FA22-16		



accessories for	601301		
	Part No.	511685	Ref. No. OGA29
	shaft seal kit ID ø 15mm ED ø 27mm shaft seal flange mounting gauge with mountign material		
	Part No.	601327	Ref. No. —
	fan wheel D1 ø 340mm H1 135mm blades 9 D2 ø 13mm D3 ø 16mm H2 38mm		



Part No.	602128	Ref. No.	OMO14
description	fan motor 100-240V 50/60Hz 0.55kW 1800rpm L1 162mm L2 52mm L3 14mm with engine shaft gasket type SCC_WE, CM_P 61-202		

spare parts for	602128		
	Part No.	551347	Ref. No. —
	gasket set SCC_WE, CM_P 61-202		
	Part No.	551348	Ref. No. —
	insulation SCC_WE, CM_P 61-202 L 248mm bore ø 30mm W 193mm H 15mm		



			
1			
Part No.	602126	Ref. No.	OFA21
description	fan motor 200-240V 50/60Hz 0.75kW 1820rpm L1 160mm L2 49mm L3 16mm 3.75A for fan wheel ø 15mm		
spare parts for	602126		
	Part No.	551347	Ref. No. —
	gasket set SCC_WE, CM_P 61-202		
	Part No.	551348	Ref. No. —
	insulation SCC_WE, CM_P 61-202 L 248mm bore ø 30mm W 193mm H 15mm		

			
1			
Part No.	602121	Ref. No.	FA102
description	fan wheel blades 12 D1 ø 160mm D2 ø 5x6mm H1 27mm		
For models:	ECO76, ECO9, ESLR9, OE7008, OE7010		

			
1			
Part No.	511682	Ref. No.	OGA09
description	shaft seal kit ID ø 17mm ED ø 29mm shaft seal flange mounting gauge with mountign material		

hot air fans

ebm-papst

			
1			
Part No.	601249	Ref. No.	FA12
description	hot air fan 230V 32W 0.27A L1 60mm L2 20mm L3 20mm L4 157mm fan wheel ø 150mm ebm-papst type R2K150-AC01-15		
For models:	ECO7, ECO76, ECO9, ESLR9, OE7008, OE7010, V6, V6D, V6F, V7		

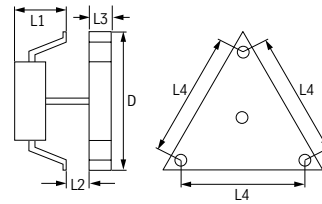

miscellaneous

			
1			
Part No.	601681	Ref. No.	FA106
description	hot air fan 230V 50Hz L1 59mm L2 13mm L3 21mm L4 86mm fan wheel ø 152mm Emmevi type 260130X		
For models:	ECO8, LCO		

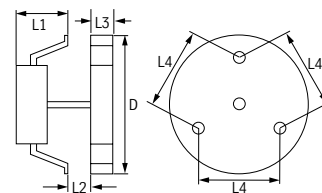



radial fans

1

Part No.	601296	Ref. No.	OMO11
description	radial fan 230V voltage AC 50Hz 140W H1 190mm L1 190mm D1 ø 50mm W1 133mm W2 28mm H2 55mm W3 83mm H3 83mm		

1

Part No.	601295	Ref. No.	OMO12
description	radial fan 230V voltage AC 50Hz 50W H1 180mm L1 180mm D1 ø 43mm W1 105mm W2 33mm H2 59mm W3 66mm H3 83mm		

1

Part No.	602116	Ref. No.	FA112
description	radial fan 230V voltage AC 50Hz 60W H1 165mm L1 175mm D1 ø 127mm W1 110mm W2 50mm H2 50mm W3 83mm H3 35mm		

motors

gear motors

for ovens

for flues

1

Part No.	500873	Ref. No.	OMO10
description	ventilation valve CROUZET type G70C10AFTEG 12V voltage DC shaft ø 6mm L 95mm W 63mm H 136mm for combi-steamer ø 50mm		

pumps

wash and rinse pumps

HANNING

pumps

1

Part No.	500579	Ref. No.	OPU03
description	pump inlet ø 24mm outlet ø 24mm type UP30-275 230V 50/60Hz 1 phase 0.09kW 0.12HP L 145mm rotation direction left capacitor 2.5µF HANNING		
spare parts for	500579		
	Part No.	501345	Ref. No. —
	O-ring EPDM thickness 3mm ID ø 58mm Qty 1 pcs		





1

Part No.	499168	Ref. No.	OPU02
description	pump inlet ø 24mm type UP30-890 200-240V 50/60Hz 1 phase 0.1kW L 145mm rotation direction left capacitor 2.5µF HANNING		

drain pumps

HANNING



1

Part No.	500573	Ref. No.	ODR06
description	drain pump 30W 4-piece 230V inlet ø 24/30mm outlet ø 24mm 50Hz HANNING type DPS25-032 1x pump, 3x pump cover		



1

Part No.	499354	Ref. No.	OPU07
description	drain pump 60/62W 200-240V inlet ø 24mm outlet ø 24mm 50/60Hz type DPS35 HANNING mode of operation S2 kit		



1

Part No.	499215	Ref. No.	OPU05
description	drain pump 60/62W 200-240V inlet ø 24mm outlet ø 24mm 50/60Hz type DPS35 HANNING mode of operation S2 max. 15min kit		

service kits



1

Part No.	500573	Ref. No.	ODR06
description	drain pump 30W 4-piece 230V inlet ø 24/30mm outlet ø 24mm 50Hz HANNING type DPS25-032 1x pump, 3x pump cover		

condensators & interference suppression filters

filters

interference suppression filters



1

Part No.	365216	Ref. No.	OFl10
description	interference suppression filter capacity 3x0.27µFX1+3x0.47µFX1µF 400V for combi-steamer SCC, CM 61-202/E		

fuses

fine fuses

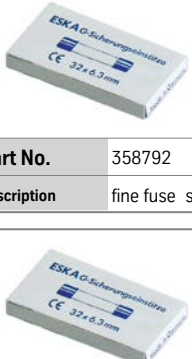

1

Part No.	358792	Ref. No.	OFU02
description	fine fuse size ø6.3x32mm 10A slow-acting rated 250V Qty 10 pcs		

1

Part No.	358791	Ref. No.	OFU01
description	fine fuse size ø6.3x32mm 6.3A slow-acting rated 250V Qty 10 pcs		



electric accessories

cables

power supply cables



1			
Part No.	551441	Ref. No.	PL202
description	power lead BS1363 angled 3-pole contacts P+N+E max. 13A max 250V with fuse thermoplastic countries GB		
For models:	C6A-100, C6A-75, C6H-100, C6H-75, C6R-105L, C6R-105R, C6R-130L, C6R-130R, CT1, D3H-75, D3R-100, D5H-100, D5H-75, D5R-100, D5R-125, EB3F, ECO8, GG1, HB2, HB3, HB4, HT3, LCG, LCG2, LCO, LD2, LD3, LD4, LDF, LDF2, LGR, LGR2, LGT, LPB, LPG, LPG2, LPO, LRG, LRG2, SCH1085, SCH785, SCR1085, SCR785, UM50, UM50D, UM050, UMS50, UMS50D, UMSO50, UMSO50D		

connection cables



1			
Part No.	379729	Ref. No.	OCA21
description	connection cable L 1230mm 4-pole for level electrode plug type coded		
accessories for	379729		
	Part No.	Ref. No.	OEL04
	level electrode PG9 total length 135mm probe L 89/59/28mm insulated probe length 80mm with 3 probes connection grip connection		



1			
Part No.	579001	Ref. No.	OCA12
description	data cable L 1300mm 8-pole suitable for RATIONAL plug type RJ45		



1			
Part No.	579002	Ref. No.	OCA19
description	data cable L 800mm 8-pole for combi-steamer suitable for SCC Line plug type RJ45		

terminals

terminal blocks



1			
Part No.	550232	Ref. No.	TE10
description	lustre terminal 12-pole cross section 2.5mm ² max. 32A max 450V temp.-resist. 150°C		
For models:	AS3, AS4		

gas valves and ignition boxes

gas control valves

DUNGS



1			
Part No.	106050	Ref. No.	OVA04
description	gas valve 230V 50/60Hz gas inlet 1/2" gas outlet 1/2" DUNGS type GB 055 243 443		



1			
Part No.	106051	Ref. No.	OVA03
description	gas valve 230V 50/60Hz gas inlet 1/2" gas outlet 1/2" DUNGS type GB-WND 055 243 442		

HONEYWELL



1			
Part No.	106012	Ref. No.	VA57
description	gas valve type VK4115V 220-240V 50/60Hz gas inlet flange 32x32mm gas outlet flange 32x32mm thermocouple connection pilot connection pressure range 15-60mbar max 60mbar operator type HONEYWELL flange 32x32mm		
accessories for	106012		
	Part No.	Ref. No.	—
	gas connection angled 1/2" flange 32x32mm hole distance 24x24mm Tandem		
	Part No.	Ref. No.	—
	gas connection straight 1/2" flange 32x32mm hole distance 24x24mm suitable for Tandem		



SIT

NOVASIT



1

Part No.	107239	Ref. No.	VA20
description	gas valve SIT series Novasit 820 0.17VHz gas inlet 1/2" gas outlet 1/2" thermocouple connection M9x1 pilot connection M10x1 ignition pressure 3-5mbar pressure range 3-30mbar pressure regulator connection blind equiv. no. 0820303 supply Operator millivolt		
For models:	DF4, DF7, J10, J5, OG7106, OG7502		
spare parts for	107239		
	Part No.	Ref. No.	PI08
	pilot burner SIT type 190 series 3 flames nozzle ømm gas connectionmm		
	Part No.	Ref. No.	—
	magnet unit with cable L 44mm D1 ø 30mm D2 ø 20mm suitable for NOVASIT		
	Part No.	Ref. No.	—
	gas connection straight 1/2" flange 45x45mm ELETTROSIT/V4400/4600/4605 suitable for SIT/HONEYWELL hole distance 36x36mm		
	Part No.	Ref. No.	—
	gas connection angled flange 45x45mm hole distance 36x36mm 1/2" ELETTROSIT/V4400/4600/4605 screw with O-ring suitable for SIT/HONEYWELL		
	Part No.	Ref. No.	—
	gas connection straight flange 45x45mm hole distance 36x36mm 3/4" ELETTROSIT/V4400/4600/4605 screw with O-ring suitable for SIT/HONEYWELL		
	Part No.	Ref. No.	—
	gas connection angled flange 45x45mm hole distance 36x36mm 3/4" ELETTROSIT/V4400/4600/4605 screw with O-ring suitable for SIT/HONEYWELL		
	Part No.	Ref. No.	—
	microswitch		
	Part No.	Ref. No.	—
	knob adapter shaft ø 10x8mm shaft L 18mm catch lower suitable for ZANUSSI shaft flat upper		
	Part No.	Ref. No.	TC41
	thermopile ROBERTSHAW L 900mm probe ø 9mm probe L 57mm 250-750mV screw connection 7/16"		

accessories















1

Part No.	100006	Ref. No.	IG19
description	piezoelectric igniter suitable for ELETTROSIT body plastic blowing connection ø2.4mm ø 14mm		
For models:	J10, J5		



1

Part No.	100110	Ref. No.	PI08
description	pilot burner SIT type 190 series 3 flames nozzle ømm gas connectionmm		
For models:	DF4, DF7, OG7502		
accessories for	100110		
	Part No.	Ref. No.	—
	pilot burner nozzle natural gas code 41 Qty 1 pcs nozzle ø 0.41mm		
	Part No.	Ref. No.	—
	pilot burner nozzle LPG code 25 Qty 1 pcs nozzle ø 0.25mm		
	Part No.	Ref. No.	IIG08
	ignition electrode connection M4 Qty 1 pcs		
	Part No.	Ref. No.	—
	screw connection thread M10x1 for ignition electrode brass Qty 1 pcs WS 10		
	Part No.	Ref. No.	—
	screw connection thread M10x1 Qty 1 pcs type SEF 1 ømm for thermocouple		
	Part No.	Ref. No.	—
	union screw thread M10x1 for pipe ø 4mm Qty 1 pcs		
	Part No.	Ref. No.	—
	union screw thread M10x1 for pipe ø 6mm Qty 1 pcs		
	Part No.	Ref. No.	—
	olive for pipe ø 4mm L 7.4mm Qty 1 pcs		
	Part No.	Ref. No.	—
	olive for pipe ø 6mm Qty 1 pcs		
	Part No.	Ref. No.	—
	pilot tube copper pipe ø 4mm thickness 1mm L 3000mm		
	Part No.	Ref. No.	—
	pilot tube copper pipe ø 6mm thickness 1mm L 3000mm		
	Part No.	Ref. No.	JE56
	pilot burner nozzle SIT LPG code 30 Qty 1 pcs		





ignition boxes

miscellaneous



1

Part No.	107679	Ref. No.	OIG13
description	ignition box type		
spare parts for	107679		
	Part No.	579004	Ref. No.
	data cable L 1800mm 6-pole for combi-steamer plug type RJ45/YY SCC, CM		



1

Part No.	107191 ¹	Ref. No.	OIG05
description	ignition box type with connection cable		
accessories for	107191		
	Part No.	579004	Ref. No.
	data cable L 1800mm 6-pole for combi-steamer plug type RJ45/YY SCC, CM		

¹with connection cable

ignition parts

pilot burners

SIT

190 series



1

Part No.	100110	Ref. No.	PI08
description	pilot burner SIT type 190 series 3 flames nozzle ømm gas connectionmm		
For models:	DF4, DF7, OG7502		
accessories for	100110		
	Part No.	100202	Ref. No.
	pilot burner nozzle natural gas code 41 Qty 1 pcs nozzle ø 0.41mm		
	Part No.	100203	Ref. No.
	pilot burner nozzle LPG code 25 Qty 1 pcs nozzle ø 0.25mm		
	Part No.	100701	Ref. No.
	ignition electrode connection M4 Qty 1 pcs		
	Part No.	100906	Ref. No.
	screw connection thread M10x1 for ignition electrode brass Qty 1 pcs WS 10		

accessories for	100110		
	Part No.	100907	Ref. No.
	screw connection thread M10x1 Qty 1 pcs type SEF 1 ømm for thermocouple		
	Part No.	100908	Ref. No.
	union screw thread M10x1 for pipe ø 4mm Qty 1 pcs		
	Part No.	100909	Ref. No.
	union screw thread M10x1 for pipe ø 6mm Qty 1 pcs		
	Part No.	101282	Ref. No.
	olive for pipe ø 4mm L 7.4mm Qty 1 pcs		
	Part No.	101287	Ref. No.
	olive for pipe ø 6mm Qty 1 pcs		
	Part No.	102110	Ref. No.
	pilot tube copper pipe ø 4mm thickness 1mm L 3000mm		
	Part No.	102111	Ref. No.
	pilot tube copper pipe ø 6mm thickness 1mm L 3000mm		
	Part No.	107650	Ref. No.
	pilot burner nozzle SIT LPG code 30 Qty 1 pcs		

electrodes



1

Part No.	106829	Ref. No.	OGA26
description	gasket for ignition electrode ID ø 10mm hole ø 4.5mm L 27mm W 17mm		



1

Part No.	550897	Ref. No.	OGA23
description	gasket ignition electrode graphite thickness 2.5mm hole distance 27mm		



1

Part No.	100701	Ref. No.	IIG08
description	ignition electrode connection M4 Qty 1 pcs		
accessories for	100701		
	Part No.	100906	Ref. No.
	screw connection thread M10x1 for ignition electrode brass Qty 1 pcs WS 10		

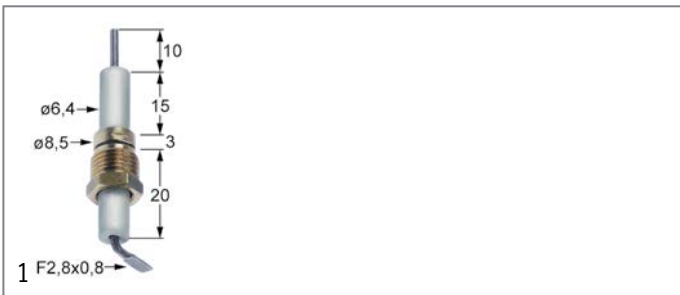

Part No.	107281	Ref. No.	IG15
description	ignition electrode D1 ϕ 6.4mm D2 ϕ 8.5mm L1 10mm BL1 15mm BL2 3mm BL3 20mm connection male faston 2.8mm M10x1		
For models:	DF4, DF7		

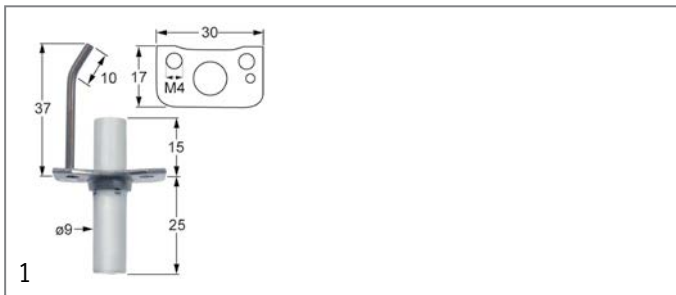

Part No.	103333	Ref. No.	OIG09
description	ignition electrode flange length 30mm flange width 17mm D1 ϕ 9mm L1 9mm L2 10mm BL1 15mm BL2 25mm fixing dimensions M4mm with flange with earthing contact		

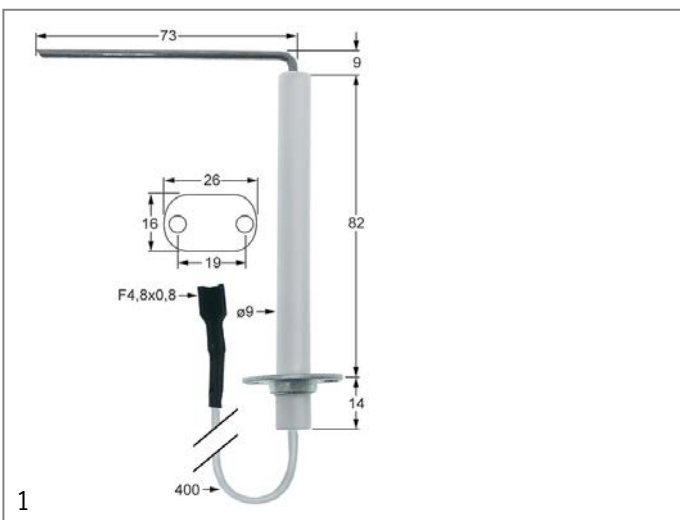

Part No.	102879	Ref. No.	OIG08
description	ignition electrode flange length 26mm flange width 16mm D1 ϕ 9mm L1 9mm L2 73mm BL1 82mm BL2 14mm connection F 4.8x0.8mm cable length 400mm mounting distance 19mm with flange		

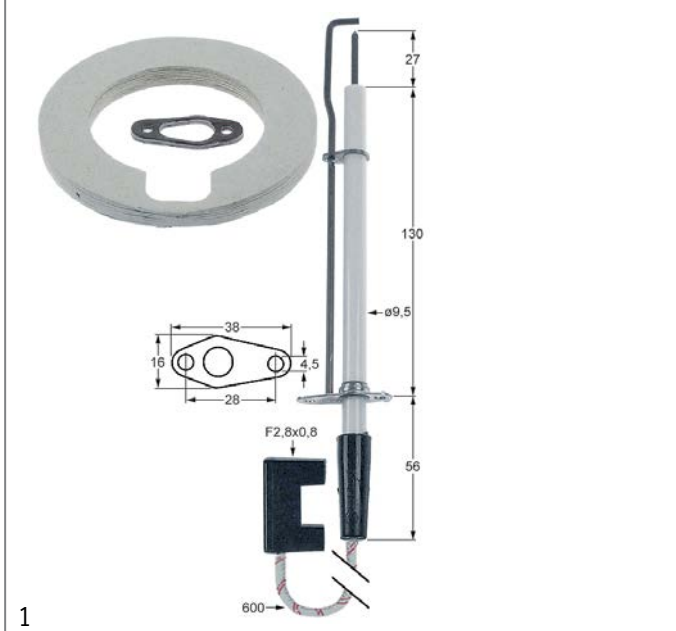

Part No.	102884	Ref. No.	OIG06
description	ignition electrode flange length 38mm flange width 16mm D1 ϕ 9.5mm L1 27mm BL1 130mm BL2 56mm connection F 2.8x0.8mm cable length 600mm fixing dimensions ϕ 4.5mm mounting distance 28mm with flange with earthing contact		



Part No.	103326	Ref. No.	OEL31
description	ignition electrode flange length 30mm flange width 17.5mm D1 ϕ 9mm L1 60mm L2 18mm BL1 27mm BL2 29mm fixing dimensions M4mm flange SCC_WE, CM_P 61-101/201G		

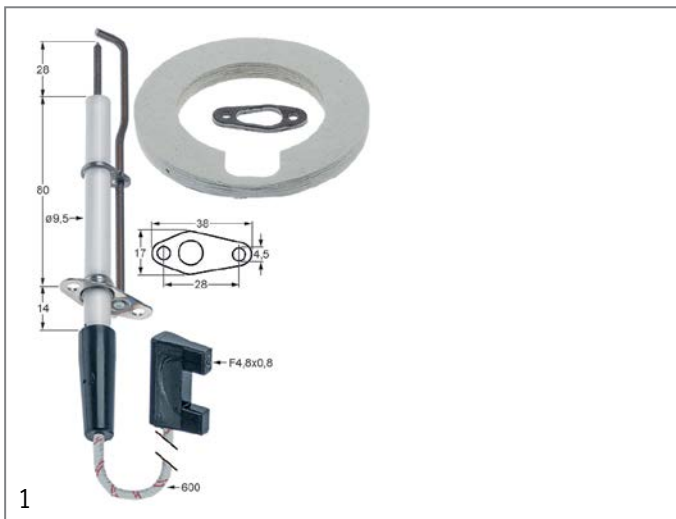

Part No.	102883	Ref. No.	OIG07
description	ignition electrode flange length 38mm flange width 17mm D1 ϕ 9.5mm L1 28mm BL1 80mm BL2 14mm connection F 4.8x0.8mm cable length 600mm fixing dimensions ϕ 4.5mm mounting distance 28mm with flange with earthing contact		

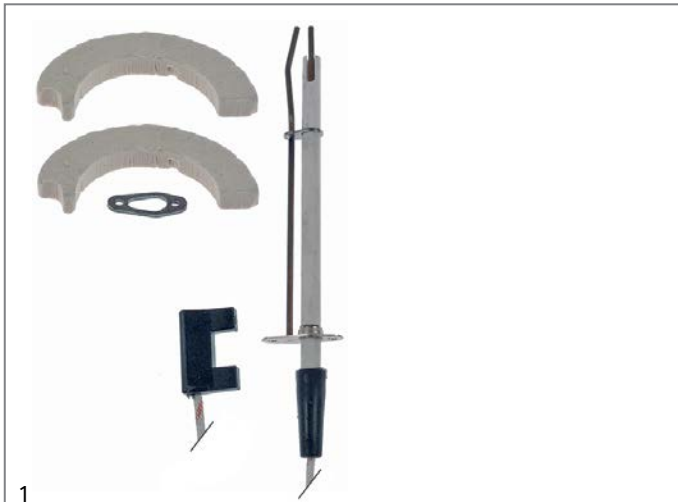

1	Part No.	103304	Ref. No.	OIG12
description ignition electrode with accessories flange length 38mm flange width 16mm D1 ø 9mm BL1 54mm BL2 144mm cable length 575mm				

ignition cables

pre-assembled cables



1	Part No.	100190	Ref. No.	IG18
description ignition cable cable length 1200mm connection F2.8mm / F2.8mm				
For models: SLR6, SLR9				

piezoelectric igniters

mounting diameter 22mm

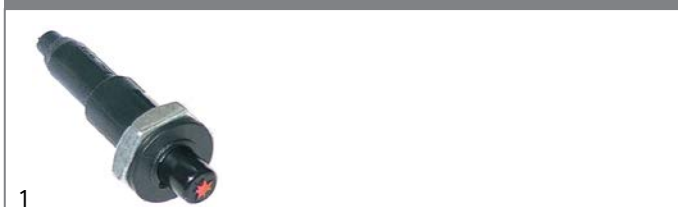

1	Part No.	100013	Ref. No.	IG35
description piezoelectric igniter body plastic blowing mounting ø 22mm connection ø2.4mm cable lengthmm				
For models: OG7106				

accessories for	100013			
	Part No.	100023	Ref. No.	—
female bullet size 2.3mm 0.5-1.5mm ² CuZn t.max. 125°C Qty 20 pcs				

miscellaneous



1	Part No.	100006	Ref. No.	IG19
description piezoelectric igniter suitable for ELETTROSIT body plastic blowing connection ø2.4mm ø 14mm				
For models: J10, J5				

thermocouples

plug-in thermocouples

plug-in thermocouples standard

with barrel socket ø6(6.5)mm

thermocouples SIT

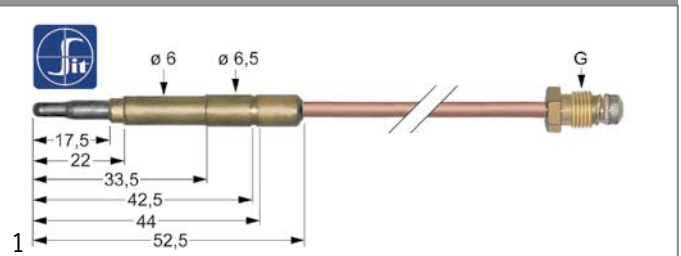

1	Part No.	107614	Ref. No.	TC23
description thermocouple SIT M9x1 L 1500mm plug connection ø6.0(6.5)mm				

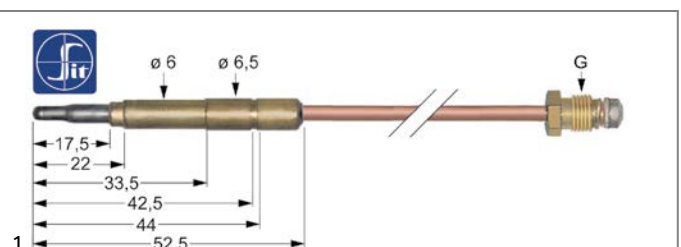

1	Part No.	107609	Ref. No.	TC13
description thermocouple SIT M9x1 L 600mm plug connection ø6.0(6.5)mm				
For models: CS4N, CS4P				

threaded thermocouples (miscellaneous)



1	Part No.	102634	Ref. No.	TC40
description thermocouple M9x1 L 400mm plug connection ø6.0mm				
For models: OG7106, OG7502				



thermopiles

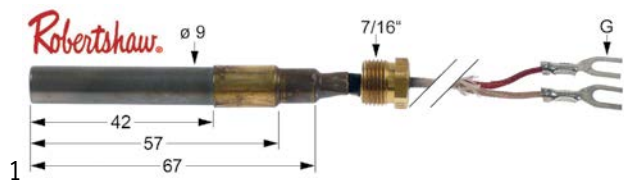

Part No.	102116	Ref. No.	TC41
description	thermopile ROBERTSHAW L 900mm probe \varnothing 9mm probe L 57mm 250-750mV screw connection 7/16"		
For models:	OG7502		

accessories

interrupters



Part No.	101265	Ref. No.	IN08
description	interrupter thread M9x1		
For models:	OG7106		

gas burners

bar burners

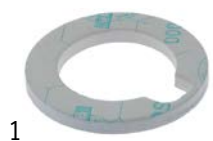

Part No.	109184	Ref. No.	OGA20
description	insulation for burner \varnothing 97.5mm ID \varnothing 62.5mm thickness 9.5mm		

forced air burners



Part No.	108152	Ref. No.	OBL01
description	blower for burner combi-steamer SCC_WE, CM_P 61-202 230V 110W hole distance 50mm NRG118/0800-3612-030203		

accessories

gaskets

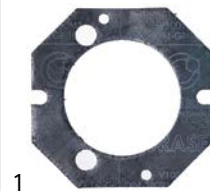

Part No.	104283	Ref. No.	OGA32
description	gasket L 100mm W 100mm hole \varnothing 64mm		

gas nozzles

pilot burner nozzles

pilot burner nozzles SIT

160 series



Part No.	107650	Ref. No.	JE56
description	pilot burner nozzle SIT LPG code 30 Qty 1 pcs		
For models:	OG7502		

gas ball valves

with DIN-DVGW approval



Part No.	520286	Ref. No.	TA29
description	ball valve straight lever handle inlet 1/2" IT outlet 1/2" IT DN15 L 61mm approval DVGW gas technology operating p. 1bar		
For models:	J10, OG7502		



for pressure steamers

valves and tank inlets



Part No.	699187	Ref. No.	FL29
description	inlet tap L 370mm 1/2"		

spare parts and accessories



Part No.	108152	Ref. No.	OBL01
description	blower for burner combi-steamer SCC_WE, CM_P 61-202 230V 110W hole distance 50mm NRG118/0800-3612-030203		



Part No.	694998	Ref. No.	ODR18
description	container L 160mm W 135mm H 66mm suitable for combi-steamer SCC Linie 61-202		



Part No.	694996	Ref. No.	OCO28 OPI14
description	sleeve with clip ø 61/73mm suitable for combi-steamer SCC_WE, CM_P 61/62/101		

housing and bezels



Part No.	699801	Ref. No.	OPU08
description	cover for drain assembly L 325mm W 162mm H 92mm		

glass panels



Part No.	692856	Ref. No.	OGL03
description	door glass for combi-steamer SCC/CM202 L 1340mm mounting pos. inner W 680mm thickness 6mm		



Part No.	694937	Ref. No.	ODO28
description	glass panel for door inside combi-steamer CPC-Linie 61 L 573mm W 495mm thickness 7mm		



Part No.	694492	Ref. No.	OGL02
description	glass panel L 485mm W 508mm thickness 6mm mounting pos. inner for combi-steamer		



cleaning system

pumps

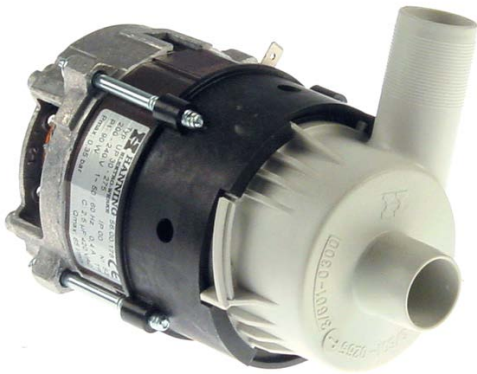

1

Part No.	500579	Ref. No.	OPU03
description	pump inlet ø 24mm outlet ø 24mm type UP30-275 230V 50/60Hz 1 phase 0.09kW 0.12HP L 145mm rotation direction left capacitor 2.5µF HANNING		
spare parts for	500579		
	Part No.	501345	Ref. No. —
	O-ring EPDM thickness 3mm ID ø 58mm Qty 1 pcs		

cleaning arms



1

Part No.	541433	Ref. No.	OCL02
description	cleaning arm CleanJet suitable for RATIONAL _101- _202		



1

Part No.	541432	Ref. No.	OCL03
description	cleaning arm CleanJet suitable for RATIONAL _61		

hoses



1

Part No.	694491	Ref. No.	OHA21
description	supply tube for hose reel		

hoses



1

Part No.	530793	Ref. No.	OHO13
description	formed hose ID ø 22mm ED ø 28mm L 640mm for combi-steamer SCC, CM201/202 since 04/2004		



1

Part No.	692102	Ref. No.	OHO07
description	hose ID ø 50mm ED ø 60mm L 50mm		

service kits



1

Part No.	699811	Ref. No.	OBU14
description	service kit for bulb socket RATIONAL		

drip water trays



1

Part No.	699800	Ref. No.	ODR08
description	drip tray plastic L 745mm W 47mm H 20mm		



door mechanics

miscellaneous



1

Part No.	694934	Ref. No.	ODO26
description	cover for door latch suitable for combi-steamer CPC-Linie 201/202 aluminium L 96.5mm W 65.5mm		

miscellaneous



1

Part No.	694433	Ref. No.	OVA05
description	air valve for combi-steamer bore \varnothing 2mm L 18mm plastic \varnothing 20mm		
accessories for	694433		



Part No.	694402	Ref. No.	—
description	valve body for air valve hose \varnothing 10mm		



1

Part No.	699809	Ref. No.	OHA20
description	clamp for spray gun L 24mm		



1

Part No.	694786	Ref. No.	OHO21 OHO22 OPI12
description	conversion kit for ventilation for combi-steamer		



1

Part No.	694650	Ref. No.	ODR17
description	drain pipe for combi-steamer L 555mm plastic		



1

Part No.	694391	Ref. No.	ODR14
description	drain pipe with sleeve for drip pan L 560mm PE		



1

Part No.	524459	Ref. No.	ODR07
description	drip rail L 540mm plastic W 63mm		

accessories for 524459



Part No.	697931	Ref. No.	ODR11
description	mounting clip plastic W 20mm Qty 5 pcs		



1

Part No.	694651	Ref. No.	OSI03
description	filter for combi-steamer \varnothing 97mm hole \varnothing 6mm H 17.5mm		



1

Part No.	520917	Ref. No.	OGA34
description	gasket for heat exchanger D1 \varnothing 104mm D2 \varnothing 132mm		

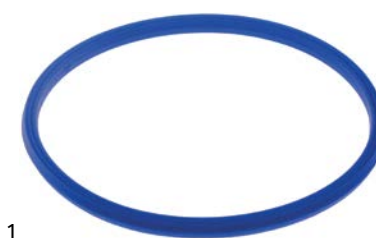

1

Part No.	694320	Ref. No.	OGA03
description	gasket for lid \varnothing 145mm		



1

Part No.	512184	Ref. No.	OCO10
description	hose connector plastic thread 3/4" Qty 1 pcs connection distance 60mm T-shape		



1

Part No.	697931	Ref. No.	ODR11
description	mounting clip plastic W 20mm Qty 5 pcs		



1

Part No.	694322	Ref. No.	ODR12
description	sleeve for drip pan D1 ø 15mm D2 ø 20mm L 62mm		



1

Part No.	694657	Ref. No.	OSI04
description	thread bolt straight L 44mm SS thread M6 ø 6mm		

knobs

producer-specific knobs

LINCAT



1

Part No.	111649	Ref. No.	OKN06
description	knob ø 69mm shaft ø 5mm silver		

handles and hand wheels

bracket handles



1

Part No.	701557	Ref. No.	HA68
description	pull handle L 200mm H 45mm mounting distance 132.5mm thread M8		
For models:	ECO76		

locks

handle latches

producer-specific

LINCAT



1

Part No.	693578	Ref. No.	ODO22
description	bracket for door catch L 66mm W 23.5mm H 19mm mounting distance 46mm		

accessories for 693578



Part No.	693579	Ref. No.	OCA11
-----------------	--------	-----------------	-------

door catch H 10.5mm L 42mm W 13mm M5



1

Part No.	693576	Ref. No.	ODO14
description	catch L 83mm ø 41mm clamp length 43mm BL 45mm		

spare parts for 693576



Part No.	693577	Ref. No.	ODO11
-----------------	--------	-----------------	-------

D-lock W 29mm H 17mm spring length 50mm spring thickness 3mm





1

Part No.	693580	Ref. No.	OL002
description	cover for catch		



			
1			
Part No.	693582	Ref. No.	OD024
description	cover for door latch L 97mm W 10.5mm mounting distance 71mm H 65mm		

			
1			
Part No.	693577	Ref. No.	OD011
description	D-lock W 29mm H 17mm spring length 50mm spring thickness 3mm		

			
1			
Part No.	693579	Ref. No.	OCA11
description	door catch H 10.5mm L 42mm W 13mm M5		

hinges

door bearing

			
1			
Part No.	693587	Ref. No.	OD032
description	hinge mounting pos. bottom right		

filters

device filters

			
1			
Part No.	698609	Ref. No.	OFI09
description	filter insert L 180mm W 140mm H 22mm plastic suitable for RATIONAL		

equipment feet and end caps

equipment feet

with screw mounting

universal

			
1			
Part No.	700867	Ref. No.	LE42
description	equipment foot tube ø 64mm thread M12 thread L 23mm H 135-215mm SS size 2 1/2" Qty 1 pcs		
For models:	OE7010, OE7503, OG7502		

screw-in feet

			
1			
Part No.	699190	Ref. No.	FE10
description	equipment foot thread M8 thread L 24mm ø 28.5mm H 16mm		
For models:	CC3, CC4, CC6, CC7, CN3, CN4, CN6, CN7, CT1, ECO76, ECO8, ECO9, G1A, GG1, HB2, HB3, HB4, HC3, HC4, HC6, HC7, J12, J18, J6, J9, LD2, LD3, LPO, LPW, LPW-LR, UMO50, UMSO50, UMSO50D		

gaskets

gaskets for heated units

door seals

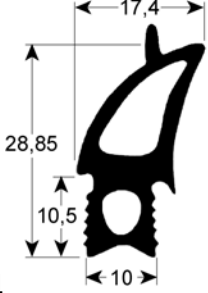
			
1			
Part No.	900290	Ref. No.	OSE06
description	door seal profile 2730 W 465mm L 520mm external size Qty 1		



Part No.	900262	Ref. No.	OSE10
description	door seal profile 2730 W 470mm L 1475mm outer plug size Qty 1		

Part No.	900292	Ref. No.	OSE03
description	door seal profile 2730 W 685mm L 780mm outer plug size		

Part No.	900291	Ref. No.	OSE02
description	door seal profile 2730 W 470mm L 785mm outer plug size Qty 1		

Part No.	901403	Ref. No.	OSE08
description	door seal profile 2731 W 470mm L 500mm outer plug size Qty 1		

Part No.	900574	Ref. No.	OSE13
description	door seal profile 2730 W 675mm L 1475mm outer plug size		

Part No.	901405	Ref. No.	OSE09
description	door seal profile 2731 W 470mm L 760mm outer plug size		

Part No.	900573	Ref. No.	OSE12
description	door seal profile 2730 W 675mm L 760mm outer plug size		

Part No.	901438	Ref. No.	OSE04
description	door seal profile 2732 W 485mm L 1495mm external size Qty 1		



Part No.	901439	Ref. No.	OSE05
description	door seal profile 2732 W 680mm L 1495mm outer plug size		

door seals with fixing hook

Part No.	902317	Ref. No.	SE05
description	door seal L 470mm W 430mm 4-sided with mounting clip		
For models:	EC09		

Part No.	902320	Ref. No.	SE23
description	door seal L 475mm W 9mm with mounting clip		

Part No.	902318	Ref. No.	SE27
description	door seal L 510mm W 10mm with mounting clip		

Part No.	902316	Ref. No.	SE76
description	door seal L 560mm W 400mm 4-sided with mounting clip		
For models:	EC08		

gaskets for tray rack trolleys

Part No.	900566	Ref. No.	OGA25
description	tray rack trolley gasket profile 4095 L 575mm Qty 1		

Part No.	900255	Ref. No.	OGA30
description	tray rack trolley gasket profile 4095 L 780mm Qty 1		

O-rings
silicone
ø3.53mm

Part No.	532727	Ref. No.	OGA38
description	O-ring silicone thickness 3.5mm ID ø 26mm Qty 5 pcs for model SCC, CM		

Part No.	532728	Ref. No.	OGA37
description	O-ring silicone thickness 3.5mm ID ø 46mm Qty 5 pcs for model SCC, CM		

shaft gaskets

miscellaneous

Part No.	511685	Ref. No.	OGA29
description	shaft seal kit ID ø 15mm ED ø 27mm shaft seal flange mounting gauge with mountign material		

mechanical components, equipment accessories



1

Part No.	511682	Ref. No.	OGA09
description	shaft seal kit ID ø 17mm ED ø 29mm shaft seal flange mounting gauge with mountign material		

special gaskets

for combi-steamers



1

Part No.	560599	Ref. No.	OGA16
description	gasket ED ø 132mm ID ø 105mm thickness 2mm CPC-Linie CM 61-202/G		



1

Part No.	560597	Ref. No.	OGA40
description	gasket ED ø 140mm ID ø 128mm SCC Line		



1

Part No.	560596	Ref. No.	OGA39
description	gasket ED ø 60mm ID ø 50mm SCC, SCC_WE, CM,CM_P since 04/2004		



1

Part No.	699803	Ref. No.	OGA24
description	gasket L 139mm W 130mm silicone thickness 4mm		



1

Part No.	560613	Ref. No.	OGA33
description	gasket L 43mm W 67mm thickness 4mm SCC, CM61-202 since 06/2007 for combi-steamer		

miscellaneous



1

Part No.	550895	Ref. No.	OGA07
description	gasket suitable for RATIONAL equiv. no. 51101308 L 179mm W 90mm electrode thickness 3mm		

springs

compression springs



1

Part No.	693591	Ref. No.	OSP04
description	compression spring ø 14mm L 27mm wire gauge ø 1.5mm		

hose reels and spray guns

spray guns



1

Part No.	540302	Ref. No.	OHA01	
description	spray gun for appliances 1/2" ET L 135mm type RATIONAL			
spare parts for	540302			
	Part No.	517056	Ref. No.	—
	O-ring EPDM thickness 2mm ID ø 6.5mm Qty 1 pcs			
	Part No.	532535	Ref. No.	—
	O-ring EPDM thickness 5mm ID ø 10mm Qty 1 pcs			
	Part No.	548016	Ref. No.	—
	compression spring ø 10mm L 17mm wire gauge ø 0.9mm for hand spray			

Table continues overleaf



spare parts for 540302			
	Part No.	548017	Ref. No. —
pressure bolt for hand spray			

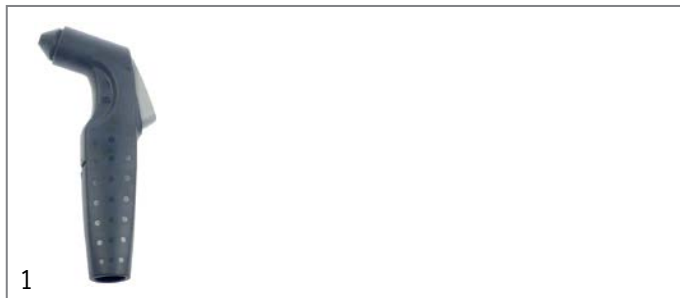

Part No.	540664	Ref. No.	OHA10
description	spray gun for appliances 1/2" (12.83mm) L 165mm		
spare parts for 540664			
	Part No.	699809	Ref. No. OHA20
clamp for spray gun L 24mm			





hose reels

appliance hose reels



Part No.	541444	Ref. No.	OHA13
description	hose reel without spray gun hose length 1.5m		



Part No.	540661	Ref. No.	OHA12
description	hose reel without spray gun hose length 1m		
accessories for 540661			
	Part No.	540664	Ref. No. OHA10
spray gun for appliances 1/2" (12.83mm) L 165mm			
	Part No.	560630	Ref. No. —
clamping washer nominal-ø 4mm ED ø 11.5mm SS thickness 0.2mm			
	Part No.	694491	Ref. No. OHA21
supply tube for hose reel			
	Part No.	699802	Ref. No. —
cover for spray gun D1 ø 90/145mm L 145mm H 68mm			





Part No.	540483	Ref. No.	OHA02
description	hose reel without spray gun hose length 2.1m		

hoses

supply hoses

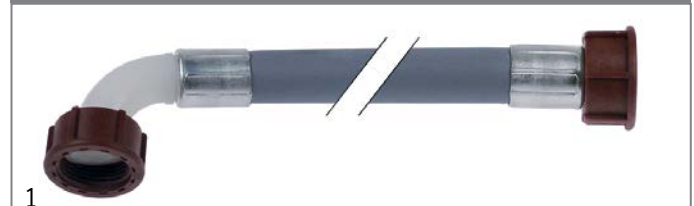
PVC supply hoses



Part No.	520010	Ref. No.	PI12
description	supply hose PVC straight-curved DN13 connections 3/4" L 1500mm operating p. 10bar burst p. 32bar t.max. 90°C blue approval VDE flat seal		
For models:	EC076		
accessories for 520010			
	Part No.	520053	Ref. No. —
screen connection 3/4" D1 ø 26mm D2 ø 15mm Qty 10 pcs rubber thickness 8mm			
	Part No.	520054	Ref. No. —
flat gasket rubber ED ø 23.5mm ID ø 14mm thickness 2.3mm Qty 10 pcs			

formed hoses

form L



Part No.	530716	Ref. No.	OHO18
description	formed hose ID ø 18/23mm ED ø 25/28mm L 170mm Qty 1 L-shape for combi-steamer ø ø22(19)mm thickness 3mm		





1

Part No.	530717	Ref. No.	OHO12
description	formed hose ID \varnothing 19/22mm ED \varnothing 25/28mm L 225mm L-shape for combi-steamer thickness 3.5mm		



1

Part No.	530793	Ref. No.	OHO13
description	formed hose ID \varnothing 22mm ED \varnothing 28mm L 640mm for combi-steamer SCC, CM201/202 since 04/2004		



1

Part No.	694323	Ref. No.	ODR16
description	formed hose ID \varnothing 23mm ED \varnothing 28mm L 480mm combi-steamer for drain		



1

Part No.	694324	Ref. No.	OHO08
description	formed hose ID \varnothing 23mm ED \varnothing 28mm L 480mm for combi-steamer		

form U



1

Part No.	530715	Ref. No.	OHO11
description	formed hose L 450mm ID \varnothing 22mm ED \varnothing 29mm for combi-steamer U-shape		

miscellaneous



1

Part No.	524453	Ref. No.	OHO16
description	formed hose ext. \varnothing 29 D1 \varnothing 23mm D2 \varnothing 23mm L 340mm white Qty 1		



1

Part No.	530066	Ref. No.	OHO06
description	formed hose ID \varnothing 24mm ED \varnothing 30mm L 380mm		

fittings, hose and pipe connectors

hose connectors

producer-specific



1

Part No.	512183	Ref. No.	OHA22
description	hose connector for hose reel T-shape plastic \varnothing 20/12mm 3/4"		

valves and tank inlets

ball valves

universal

mini ball valves



1

Part No.	520956	Ref. No.	DV02
description	ball valve DN8 total length 54mm chrome-plated brass		
For models:	EB3F, EB4F, EB6, EB6T		



consumables

fuses

fine fuses

ø6.3x32mm 250V



1

Part No.	358792	Ref. No.	OFU02
description	fine fuse size ø6.3x32mm 10A slow-acting rated 250V Qty 10 pcs		



1

Part No.	358791	Ref. No.	OFU01
description	fine fuse size ø6.3x32mm 6.3A slow-acting rated 250V Qty 10 pcs		

GASTROPARTS.COM



© 2020 Gastroparts Sp. J. All rights reserved.