



GASTROPARTS

Küppersbusch Ovens

[EN] Cooking

[DE] Kochtechnik

[ES] Cocción

[FR] Cuisson

[IT] Cottura

[PL] Obróbka termiczna

[RU] Термическая обработка

✉ gastroparts@gastroparts.com

☎ tel. +48 56 657 00 66

📘 fb.com/gastroparts.global

GASTROPARTS.COM







heating elements

pilot heating elements



1

Part No.	415607	Ref. No.	181729 182311
description	heating element 500W 230V heating circuits 1 thread 3/4" L 295mm W 20mm H 19mm length thermostat sleeves 235mm thermostat sleeves ø 6mm number of thermostat sleeves 1 thermostat sleeve clinging tube ø 6.5mm immersion heater flange with thread connection length 50mm pilot heating element		
For models:	CBE106-VAR091, CBE110-VAR091, CBE120-VAR091, CBE220-VAR091, CCE106, CCE110, CCE120, CCE220, CED106, CED110, CED120, CED220, CEF106, CEF110, CEF120, CEF220, CEM110, CEM120, CPE106, CPE110, CPE120, CPE220, EES060, EES080, FED080, FED150, FED250, FED300, FEK040, FEK060, FEK080, FEK100, FEK150, FER080, FER150, FER250, FER300, FER400, FES040, FES060, FES080, FES100, FES150, LES060, NED080, NED150, NED250, NED300, NEK040, NEK060...(Other models you can see in the webshop)		
spare parts for	415607		
	Part No.	510403	Ref. No. —
	flat gasket fibre ED ø 36.5mm ID ø 27mm thickness 2mm Qty 1 pcs		
accessories for	415607		
	Part No.	510421	Ref. No. —
	gasket copper ED ø 31.8mm ID ø 26.4mm thickness 2.2mm for thread 3/4"		
	Part No.	520234	Ref. No. 166103
	nut thread 3/4" H 5mm brass WS 30 Qty 1 pcs		

immersion heating elements

with expansion flange 70 x 18mm



1

Part No.	415465	Ref. No.	407264
description	heating element 3000W 230V heating circuits 2 flange 70x18mm L 365mm W 65mm connection male faston 6.3mm tube ø 8.5mm immersion heater expansion flange		
For models:	ECD106, ECD220		
accessories for	415465		
	Part No.	379078	Ref. No. —
	temperature probe thermocouple K (NiCr-Ni) cable silicone probe -50 up to 1150°C cable -50 up to +180°C connection 2-wire thread probe ø1.5x100mm cable length 1.8m		









1

Part No.	415466	Ref. No.	407263
description	heating element 6000W 230V heating circuits 2 flange 70x18mm L 365mm W 65mm connection male faston 6.3mm tube ø 8.5mm immersion heater expansion flange connection length 32mm		
For models:	ECD106, ECD110, ECD120, ECD220		
accessories for	415466		
	Part No.	379078	Ref. No. —
	temperature probe thermocouple K (NiCr-Ni) cable silicone probe -50 up to 1150°C cable -50 up to +180°C connection 2-wire thread probe ø1.5x100mm cable length 1.8m		

with round flange ø47.5mm



1

Part No.	415888	Ref. No.	181737 182674 182684
description	heating element 12000W 230V heating circuits 3 mounting ø 47.5mm L 510mm W 34mm H 33mm round flange connection male faston 6.3mm immersion heater tube ø 8.5mm connection length 25mm		
For models:	CBE120-VAR091, CBE220-VAR091, CCE120, CCE220, CED120, CED220, CEF120, CEF220, CEM120, CPE120, CPE220		
spare parts for	415888		
	Part No.	510408	Ref. No. 060842
	O-ring EPDM thickness 5.34mm ID ø 47mm Qty 1 pcs		
accessories for	415888		
	Part No.	510562	Ref. No. —
	O-ring silicone thickness 5.34mm ID ø 47mm Qty 1 pcs		
	Part No.	520235	Ref. No. 732204000 817526000
	3 hole flange hole distance 70.5mm perforation ø 6.5mm ID ø 53.5mm		
	Part No.	520236	Ref. No. —
	flange for heating element ID ø 50mm ED ø 90mm hole ø 6.5mm 3 holes		
	Part No.	550002	Ref. No. 144280
	tension strap H 10mm L 21mm W 10mm hole ø 6.5mm for heating element		
	Part No.	550362	Ref. No. —
	blind flange ø 64mm mounting ø 47.5mm		



1













Part No.	415875	Ref. No.	181736 182680
description	heating element 9000W 230V heating circuits 3 mounting ø 47.5mm L 518mm W 34mm H 37mm round flange connection male faston 6.3mm immersion heater tube ø 8.5mm		
For models:	CBE106-VAR091, CBE110-VAR091, CCE106, CCE110, CED106, CED110, CEF106, CEF110, CEM110, CPE106, CPE110		
accessories for	415875		
	Part No.	510408	Ref. No. 060842
	O-ring EPDM thickness 5.34mm ID ø 47mm Qty 1 pcs		







Table continues overleaf









accessories for	415875		
	Part No.	510562	Ref. No. —
	O-ring silicone thickness 5.34mm ID ø 47mm Qty 1 pcs		
	Part No.	520235	Ref. No. 732204000 817526000
	3 hole flange hole distance 70.5mm perforation ø 6.5mm ID ø 53.5mm		
	Part No.	520236	Ref. No. —
	flange for heating element ID ø 50mm ED ø 90mm hole ø 6.5mm 3 holes		
	Part No.	550002	Ref. No. 144280
	tension strap H 10mm L 21mm W 10mm hole ø 6.5mm for heating element		
	Part No.	550362	Ref. No. —
	blind flange ø 64mm mounting ø 47.5mm		

heating elements for convection

	1		
Part No.	415911	Ref. No.	407449
description	heating element 9000W 230V heating circuits 4 ID ø 310mm ED ø 333mm L 410mm H 115mm L1 77mm W1 75mm H1 15mm H2 100mm thread M14x1.5 8 hole fixing connection male faston 6.3mm tube ø 8.5mm convection heating element		
For models:	ECD106		
accessories for	415911		
	Part No.	510417	Ref. No. —
	flat gasket fibre ED ø 20mm ID ø 14mm thickness 2mm Qty 1 pcs		
	Part No.	520228	Ref. No. 40156998
	tooth lock washer ID ø 15.3mm ED ø 24mm steel Qty 1 pcs for thread M14		
	Part No.	520230	Ref. No. 407298
	nut thread M14x1.5 H 5mm WS 19 zinc-coated steel Qty 1 pcs		
	Part No.	521101	Ref. No. —
	nut thread M14x1.5 H 5mm WS 19 SS Qty 1 pcs		
	Part No.	550262	Ref. No. —
	flat gasket copper ED ø 20mm ID ø 14mm thickness 2mm		

	1		
Part No.	415469	Ref. No.	407299
description	heating element 2000W 220V heating circuits 1 L 95mm W 520mm connection length 24mm connection male faston 6.3mm tube ø 6.3mm thread M14x1.5 2 hole fixing convection heating element mounting distance 514mm		
For models:	ECD110, ECD120		
accessories for	415469		
	Part No.	510417	Ref. No. —
	flat gasket fibre ED ø 20mm ID ø 14mm thickness 2mm Qty 1 pcs		
	Part No.	520228	Ref. No. 40156998
	tooth lock washer ID ø 15.3mm ED ø 24mm steel Qty 1 pcs for thread M14		
	Part No.	520230	Ref. No. 407298
	nut thread M14x1.5 H 5mm WS 19 zinc-coated steel Qty 1 pcs		
	Part No.	521101	Ref. No. —
	nut thread M14x1.5 H 5mm WS 19 SS Qty 1 pcs		
	Part No.	550262	Ref. No. —
	flat gasket copper ED ø 20mm ID ø 14mm thickness 2mm		

	1		
Part No.	415554	Ref. No.	407496
description	heating element 2500W 230V heating circuits 1 L 148mm W 534mm connection male faston 6.3mm tube ø 6.3mm thread M14x1.5 2 hole fixing convection heating element mounting distance 528mm		
For models:	ECD220		
spare parts for	415554		
	Part No.	510420	Ref. No. 407297
	gasket copper ED ø 19.9mm ID ø 14.3mm thickness 2mm Qty 1 pcs		
accessories for	415554		
	Part No.	510417	Ref. No. —
	flat gasket fibre ED ø 20mm ID ø 14mm thickness 2mm Qty 1 pcs		
	Part No.	520228	Ref. No. 40156998
	tooth lock washer ID ø 15.3mm ED ø 24mm steel Qty 1 pcs for thread M14		
	Part No.	520230	Ref. No. 407298
	nut thread M14x1.5 H 5mm WS 19 zinc-coated steel Qty 1 pcs		
	Part No.	521101	Ref. No. —
	nut thread M14x1.5 H 5mm WS 19 SS Qty 1 pcs		
	Part No.	550262	Ref. No. —
	flat gasket copper ED ø 20mm ID ø 14mm thickness 2mm		

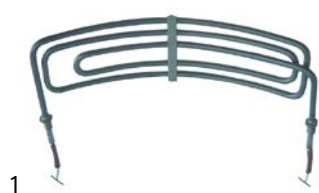

			
Part No.	415571	Ref. No.	181740 182682
description	heating element 3000W 230V heating circuits 1 L 360mm W 120mm tube ø 6.3mm thread M12x1 cable length 1000mm 2 hole fixing convection heating element		
For models:	CBE106, CBE106-VAR091, CBE110, CBE110-VAR091, CCE106, CCE110, CEC106, CEC110, CED106, CED110, CEF106, CEF110, CEM110, CPE106, CPE110		

			
Part No.	415560	Ref. No.	181741 182683
description	heating element 4000W 230V heating circuits 1 L 353mm W 80mm tube ø 9mm thread M12x1 cable length 500mm W1 353mm 2 hole fixing convection heating element mounting distance 340mm		
For models:	CBE120, CBE120-VAR091, CBE220, CBE220-VAR091, CCE120, CCE220, CEC120, CEC220, CED120, CED220, CEF120, CEF220, CEM120, CPE120, CPE220		

accessories

hexagonal nuts

			
Part No.	520230	Ref. No.	407298
description	nut thread M14x1.5 H 5mm WS 19 zinc-coated steel Qty 1 pcs		
For models:	ECD106, ECD110, ECD120, ECD220		

tooth lock washers

			
Part No.	560192	Ref. No.	407551
description	tooth lock washer ID ø 10.4mm ED ø 18mm SS DIN/ISO DIN 6798A Qty 1 pcs for thread M10		
For models:	ECD106, ECD110, ECD120, ECD220		

			
Part No.	520228	Ref. No.	40156998
description	tooth lock washer ID ø 15.3mm ED ø 24mm steel Qty 1 pcs for thread M14		

sealing washers

O-rings

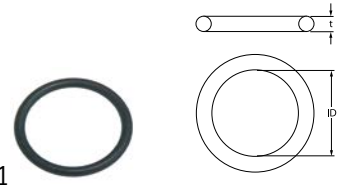
			
Part No.	510408	Ref. No.	060842
description	O-ring EPDM thickness 5.34mm ID ø 47mm Qty 1 pcs		
For models:	CBE120-VAR091, CBE220-VAR091, CCE120, CCE220, CED120, CED220, CEF120, CEF220, CEM120, CPE120, CPE220, FED080, FED150, FED250, FED300, FEK040, FEK060, FEK080, FEK100, FEK150, FER080, FER150, FER250, FER300, FER400, FES040, FES060, FES080, FES100, FES150, NER080, NER150, NER250, NER300, NER400, NES040, NES060, NES080, NES100, NES150, PEK048, PEK068, PEK088, PEK108, PEK158, PER088, PER158, PER258, PER308, PES048...(Other models you can see in the webshop)		

energy regulators

EGO

1-circuit

			
Part No.	380015	Ref. No.	183111 183149 183150 183236 540548
description	energy regulator 230V 13A single-circuit turn direction right shaft ø 6x4.6mm shaft L 23mm mounting thread M4 power release 6-100% no. 50.57021.010		
For models:	EEF040, EEH210, EEH300, EEH410, EEH413, EEH500, EEH503, EEH610, EEH613, EEH700, EEH703, EES060, EES080, FEF040, FEH500, FEH503, FEH505, FEH510, FEH513, FEH515, FEH700, FEH705, FEH710, FEH715, LEB231, LEB431, LEB631, LEF040, LEH500, LEH503, LEH505, LEH700, LEH703, LEH705, NEB431, NEB631, NEB831, NEF040, NEH500, NEH505, NEH700, NEH705, NEK040, NEK060, NEK080, NEK100, NEK150, NEM100, NER080, NER150...(Other models you can see in the webshop)		



thermostats

control and safety thermostats

EGO

control thermostats

55.10/19_ series

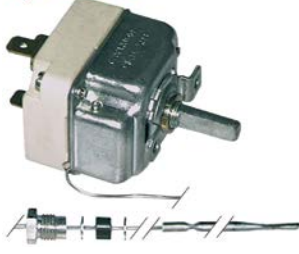

Part No.	375070	Ref. No.	540522
description	thermostat t.max. 250°C temperature range 55-250°C 1-pole 1CO 16A probe ø 3.1mm probe L 226mm capillary pipe 1170mm capillary pipe isolated 1100mm gland nut M9x1 shaft L 23mm shaft position upper rotation 270°		
For models:	EEW250, EEW450, EEW452		

55.13_ series



Part No.	375008	Ref. No.	174690
description	thermostat t.max. 110°C temperature range 30-110°C 1-pole 1CO 16A probe ø 3.1mm probe L 197mm capillary pipe 3150mm capillary pipe isolated 300mm gland nut shaft L 23mm shaft position° shaft position rotation 270°		



Part No.	375086	Ref. No.	407340
description	thermostat t.max. 180°C temperature range 60-180°C 1-pole 1CO 16A probe ø 6mm probe L 90mm capillary pipe 2400mm capillary pipe isolated 2300mm gland nut shaft ø 6x4.6mm shaft L 25mm shaft position upper rotation 270° probe material SS		
For models:	ECD110, ECD120, ECD220		



Part No.	375087	Ref. No.	407276
description	thermostat t.max. 300°C temperature range 50-300°C 1-pole 1CO 16A probe ø 3.03mm probe L 160mm capillary pipe 1130mm capillary pipe isolated 1103mm gland nut shaft L 23mm shaft position upper rotation 270°		
For models:	ECD106, ECD110, ECD120, ECD220		



Part No.	375088	Ref. No.	407266
description	thermostat t.max. 300°C temperature range 60-300°C 1-pole 1NO 16A probe ø 4mm probe L 100mm capillary pipe 830mm capillary pipe isolated 800mm gland nut shaft L 15mm shaft position upper rotation 270°		
For models:	ECD106, ECD110, ECD120, ECD220		



Part No.	375505	Ref. No.	174681
description	thermostat t.max. 320°C temperature range 50-320°C 1-pole 1NO 16A probe ø 3mm probe L 160mm capillary pipe 870mm capillary pipe isolatedmm gland nut shaft ø 6x4.6mm shaft L 23mm shaft position upper rotation 270°		
For models:	ECL484		



Part No.	375085	Ref. No.	407279
description	thermostat t.max. 90°C temperature range 0-90°C 1-pole 1CO 16A probe ø 3.1mm probe L 247mm capillary pipe 1430mm capillary pipe isolated 1400mm gland nut shaft ø 6x4.6mm shaft L 18mm shaft position upper probe material SS		
For models:	ECD106, ECD110, ECD120, ECD220		

safety thermostats

51._ series



Part No.	375090	Ref. No.	407275
description	safety thermostat switch-off temp. 365°C 2-pole 16A probe ø 4mm probe L 120mm capillary pipe 1170mm capillary pipe isolated 1100mm gland nut probe SS		
For models:	ECD106, ECD110, ECD120, ECD220		

55.32_ series

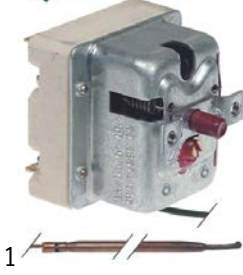

Part No.	375706	Ref. No.	540406
description	safety thermostat switch-off temp. 400°C 3-pole 3NC 20A probe ø 3.9mm probe L 228mm capillary pipe 1190mm capillary pipe isolatedmm gland nut probe SS		

56._ series

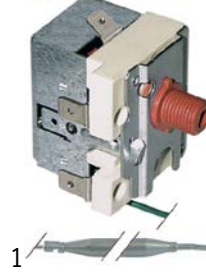

Part No.	375591	Ref. No.	152433
description	safety thermostat switch-off temp. 147°C 1-pole 16A probe ø 6mm probe L 77mm capillary pipe 1860mm capillary pipe isolated 1350mm gland nut probe		
For models:	CBE106-VAR091, CBE110-VAR091, CBE120-VAR091, CBE220-VAR091, CCE106, CCE110, CCE120, CCE220, CPE106, CPE110, CPE120, CPE220, FES040, FES060, FES080, FES100, FES150, FGS040, FGS060, FGS080, FGS100, FGS150, PES048, PES068, PES088, PES108, PES158, PGS048, PGS068, PGS088		



Part No.	375531	Ref. No.	152432 176592
description	safety thermostat switch-off temp. 340°C 1-pole 16A probe ø 4mm probe L 100mm capillary pipe 1860mm capillary pipe isolated 1710mm gland nut		
For models:	CBE106, CBE106-VAR091, CBE110, CBE110-VAR091, CBE120, CBE120-VAR091, CBE220, CBE220-VAR091, CBG110, CBG120, CCE106, CCE110, CCE120, CCE220, CPE106, CPE110, CPE120, CPE220		

switches and momentary switches

push/momentary push switches

2 hole fixing



Part No.	345136	Ref. No.	407319
description	switch combination triple green 240V 16A connection male faston 6.3mm ambient temperature max. 125°C protection IP44		
For models:	ECD106, ECD110, ECD120, ECD220		



microswitches

universal



1

Part No.	345042	Ref. No.	183197
description	microswitch with plunger 250V 16A 1CO connection male faston 6.3mm L 28mm ambient temperature max. 125°C mounting distance 22mm type EF83161.3 actuating force: 75g blue/black		
For models:	ECL484		
accessories for	345042		
	Part No.	345043	Ref. No. —
	lever set 5-piece		

lever actuated



1

Part No.	345254	Ref. No.	540575
description	microswitch with lever 250V 16A 1CO connection male faston 6.3mm ambient temperature max. 120°C mounting distance 22mm actuating force: 60g lever length 58mm		
For models:	EEF124, EEF224		



1

Part No.	345107	Ref. No.	183426
description	microswitch with lever 250V 16A 1CO connection male faston 6.3mm L 98mm ambient temperature max. 125°C mounting distance 22mm actuating force: 30g lever length 90mm		
For models:	EGP500, FEK040, FEK060, FEK080, FEK100, FEK150, FNK040, FNK060, FNK080, FNK100, FNK150, NEK040, NEK060, NEK080, NEK100, NEK150, NEP060, NEP203, NEP303, NEP400, NEP600, NEP900, NGP900, NNK040, NNK060, NNK080, NNK100, NNK150, NTE182, PEK048, PEK068, PEK088, PEK108, PEK158, PNK048, PNK068, PNK088, PNK108, PNK158		

pin-plunger actuated



1

Part No.	345062	Ref. No.	177168
description	microswitch with plunger 250V 16A 1NO/1NC connection male faston 6.3mm ambient temperature max. 85°C mounting distance 22mm type BS1012 actuating force: 350g red stroke 8mm		
For models:	FEF124, FEF144, FEF144e, FEF224, FEF224e, PEF128, PEF148, PEF228, TEF124, TEF144, TEF224		



1

Part No.	345042	Ref. No.	183197
description	microswitch with plunger 250V 16A 1CO connection male faston 6.3mm L 28mm ambient temperature max. 125°C mounting distance 22mm type EF83161.3 actuating force: 75g blue/black		
For models:	ECL484		
accessories for	345042		
	Part No.	345043	Ref. No. —
	lever set 5-piece		

M12



1

Part No.	345138	Ref. No.	177160
description	microswitch with plunger mounting distance 25mm thread M12x1 thread L 12mm 250V 20A 1CO connection screw stroke 7mm L1 13mm ambient temperature max. 85°C type Z15G1307 actuating force: 250g		
For models:	CBE106, CBE106-VAR091, CBE110, CBE110-VAR091, CBE120, CBE120-VAR091, CBE220, CBE220-VAR091, CBG110, CBG120, CEC106, CEC110, CEC120, CEC220, CED106, CED110, CED120, CED220, CEF106, CEF110, CEF120, CEF220, CEM110, CEM120, CGD110, CGD120, EAB051, EDC106, FEP230, FEP330, NEP203, NEP303, PEP238, PEP338		

M16



1

Part No.	345047	Ref. No.	407268
description	microswitch with plunger thread M16x1 thread L 27mm 250V 5A 1NO connection cable stroke 5mm ambient temperature max. 85°C with cable type 837333 actuating force: 400g		
For models:	ECD106, ECD110, ECD120, ECD220		
accessories for	345047		
	Part No.	698490	Ref. No. —
	cover ED ø 17mm suitable for 345047		



cam switches

on/off

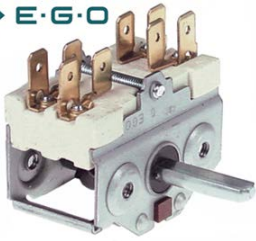



1

Part No.	300074	Ref. No.	540856
description	cam switch 4 operating positions 2NO sequence 0-1-0-1 16A shaft ø 6x4.6mm shaft L 23mm connection male faston 6.3mm ceramic		



1

Part No.	300020	Ref. No.	182861
description	cam switch 4 operating positions 2NO sequence 0-1-0-1 16A shaft ø 6x4.6mm shaft L 23mm connection screw ceramic		
For models:	EGS060, EHN601, EHP601, EWB101, EWB201, EWN401-mit-beheizterm-Schrankraum, NDD080, NDD150, NDD250, NDD300, NHD080, NHD150, NHD250, NHD300, NTE182		
accessories for	300020		
	Part No.	110135	Ref. No. —
	rosette knob up to ø 52mm		
	Part No.	110231	Ref. No. —
	knob switch 0-1-0-1 t.max.°C ø 50mm shaft ø 6x4.6mm shaft flat upper black		

4-position



1

Part No.	300103	Ref. No.	182752 183105
description	cam switch 4 operating positions 1NO/2CO sequence 0-1-2-3 32A shaft ø 6x4.6mm shaft L 23mm connection screw ceramic		



1

Part No.	300104	Ref. No.	540431
description	cam switch 4 operating positions 3NO/1CO sequence 0-1-2-3 32A shaft ø 6x4.6mm shaft L 23mm connection screw ceramic		

7-position



1

Part No.	300106	Ref. No.	183104
description	cam switch 7 operating positions 1NO/2CO sequence 0-1-2-3-4-5-6 32A shaft ø 6x4.6mm shaft L 23mm connection screw 7-position shaft flat upper		
For models:	EH0101, EH0111		

operation switches



1

Part No.	300080	Ref. No.	183110
description	cam switch 2 operating positions 4NO 16A sequence 0-1 shaft ø 6x4.6mm shaft L 23mm connection screw operation switch ceramic ambient temperature max. 150°C		
For models:	NEF144		
accessories for	300080		
	Part No.	551456	Ref. No. —
	gasket for switch ED ø 14mm ID ø 2.5mm thickness 3.5mm white		





1

Part No.	300200	Ref. No.	540461
description	operation switch 2 operating positions 2NO 16A sequence 0-1 shaft \varnothing 6x4.6mm shaft L 23mm connection male faston 6.3mm operation switch ceramic		

magnetic switches

miscellaneous



1



Part No.	347812	Ref. No.	164891
description	magnetic switch 100VDC 0.1A P max. 5W cable length 2000mm 1NC connection cable L 48mm 5W L1 12mm L2 11mm white mounting distance 16-18mm nominal 0.2A		
For models:	CCE106, CCE110, CCE120, CCE220, CPE106, CPE110, CPE120, CPE220		

control equipment

lamps



1

Part No.	359606	Ref. No.	183914
description	neon light bulb socket Ba9s 220V 2W clear \varnothing 10mm L 28mm		
For models:	PGP608, PGP908		
accessories for	359606		
	Part No.	359832	Ref. No. —
	lamp socket mounting measurements \varnothing 16.2mm socket Ba9s connection male faston 6.3mm		
	Part No.	359853	Ref. No. —
	lamp socket mounting measurements \varnothing 18.2mm socket Ba9s connection male faston 6.3mm		

encoders and potentiometers



1

Part No.	300196	Ref. No.	407325
description	potentiometer 0-150		
For models:	ECD110, ECD120, ECD220		

lamps

indicator lights

indicator lights 3-piece (housing, lens and bulb)

lamps

light bulbs





1

Part No.	359608	Ref. No.	407265
description	light bulb socket E14 10/15W 230V \varnothing 16mm L 51mm lens L 31mm Qty 1 pcs		
For models:	ECD106, ECD110, ECD120, ECD220		

neon light bulbs



1

Part No.	359606	Ref. No.	183914
description	neon light bulb socket Ba9s 220V 2W clear \varnothing 10mm L 28mm		
For models:	PGP608, PGP908		
accessories for	359606		
	Part No.	359832	Ref. No. —
	lamp socket mounting measurements \varnothing 16.2mm socket Ba9s connection male faston 6.3mm		
	Part No.	359853	Ref. No. —
	lamp socket mounting measurements \varnothing 18.2mm socket Ba9s connection male faston 6.3mm		



1







Part No.	359600	Ref. No.	407269
description	neon light bulb socket E10 220V 0.35W clear \varnothing 10mm L 28mm		
For models:	ECD106, ECD110, ECD120, ECD220		
accessories for	359600		
	Part No.	359060	Ref. No. —
	lamp socket mounting measurements \varnothing 16.2mm socket E10 connection screw		

Table continues overleaf



accessories for	359600		
	Part No.	359063	Ref. No. —
	lamp socket mounting measurements ø19.2mm socket E14 connection screw		
	Part No.	359064	Ref. No. —
	lamp socket mounting measurements ø22.3mm socket E14 connection screw 250/380V ambient temperature at 1W 100°C ambient temperature at 2W 85°C		
	Part No.	359685	Ref. No. —
	lamp socket mounting measurements ø16.2mm socket E10		
	Part No.	359832	Ref. No. —
	lamp socket mounting measurements ø16.2mm socket Ba9s connection male faston 6.3mm		
	Part No.	359853	Ref. No. —
	lamp socket mounting measurements ø18.2mm socket Ba9s connection male faston 6.3mm		
	Part No.	359988	Ref. No. —
	lamp socket mounting measurements ø30.5mm 250V connection F6.3 temp.-resist. 55°C E14		

indicator lights (complete)

ø10mm

with plug-in socket



1

Part No.	359139	Ref. No.	184186
description	indicator light ø 10mm green 230V connection male faston 6.3mm Qty 1 pcs		
For models:	ECL484		

ø12mm

with screw socket



1

Part No.	359027	Ref. No.	540412
description	indicator light ø 12mm 250V green connection male faston 6.3mm		

miscellaneous



1



Part No.	359887	Ref. No.	407321
description	lamp socket socket E10 mounting measurements ø21mm		
For models:	ECD106, ECD110, ECD120, ECD220		

screw-on/push-on fit

neon light bulbs



1

Part No.	359606	Ref. No.	183914
description	neon light bulb socket Ba9s 220V 2W clear ø 10mm L 28mm		
For models:	PGP608, PGP908		
accessories for	359606		
	Part No.	359832	Ref. No. —
	lamp socket mounting measurements ø16.2mm socket Ba9s connection male faston 6.3mm		
	Part No.	359853	Ref. No. —
	lamp socket mounting measurements ø18.2mm socket Ba9s connection male faston 6.3mm		



1

Part No.	359600	Ref. No.	407269
description	neon light bulb socket E10 220V 0.35W clear ø 10mm L 28mm		
For models:	ECD106, ECD110, ECD120, ECD220		
accessories for	359600		
	Part No.	359060	Ref. No. —
	lamp socket mounting measurements ø16.2mm socket E10 connection screw		
	Part No.	359063	Ref. No. —
	lamp socket mounting measurements ø19.2mm socket E14 connection screw		
	Part No.	359064	Ref. No. —
	lamp socket mounting measurements ø22.3mm socket E14 connection screw 250/380V ambient temperature at 1W 100°C ambient temperature at 2W 85°C		
	Part No.	359685	Ref. No. —
	lamp socket mounting measurements ø16.2mm socket E10		
	Part No.	359832	Ref. No. —
	lamp socket mounting measurements ø16.2mm socket Ba9s connection male faston 6.3mm		
	Part No.	359853	Ref. No. —
	lamp socket mounting measurements ø18.2mm socket Ba9s connection male faston 6.3mm		
	Part No.	359988	Ref. No. —
	lamp socket mounting measurements ø30.5mm 250V connection F6.3 temp.-resist. 55°C E14		



light bulbs

for ovens



1			
Part No.	359610	Ref. No.	184001 407288
description	light bulb t.max. 300°C socket E14 15W 230V ø 22mm L 47mm lens L 20mm for oven lamp type Philips		
For models:	ECD106, ECD110, ECD120, ECD220, ECL484, EHP601		



1			
Part No.	357153	Ref. No.	184018
description	light bulb t.max. 300°C socket E14 25W 230V ø 25mm L 55mm lens L 30mm for oven type		



1			
Part No.	359611	Ref. No.	183926
description	light bulb t.max. 300°C socket E14 40W 230V ø 45mm L 75mm lens L 50mm for oven lamp IMPORT		
For models:	CEC106, CEC110, CEC120, CEC220, CED106, CED110, CED120, CED220		

for indicator lights



1			
Part No.	359608	Ref. No.	407265
description	light bulb socket E14 10/15W 230V ø 16mm L 51mm lens L 31mm Qty 1 pcs		
For models:	ECD106, ECD110, ECD120, ECD220		

halogen lamp

for socket G4 / G6.35 / G9



1			
Part No.	359599	Ref. No.	163000
description	halogen lamp socket G4 12V 20W temp.-resist. 500°C		
For models:	CBE106, CBE106-VAR091, CBE110, CBE110-VAR091, CBE120, CBE120-VAR091, CBE220, CBE220-VAR091, CBG110, CBG120, CCE106, CCE110, CCE120, CCE220, CEC106, CEC110, CEC120, CEC220, CED106, CED110, CED120, CED220, CEF106, CEF110, CEF120, CEF220, CEM110, CEM120, CGD110, CGD120, CPE106, CPE110, CPE120, CPE220		

linear lamps

infrared lamps

with base type R7s



1			
Part No.	359628	Ref. No.	163018
description	infrared lamp socket R7s L 117.6mm 240V 300W IMPORT unjacketed		

oven lamps

universal oven lamps

mounting diameter 35.5mm



1			
Part No.	359701	Ref. No.	407284
description	lamp socket socket E14 220-230V mounting ø 35.5mm connection male faston 6.3mm 15W		
For models:	ECD106, ECD110, ECD120, ECD220		

accessories for	359701			
	Part No.	359705	Ref. No.	407390
	oven lamp glass thr. ø 33.5mm ø 52mm hard glas temp.-resist. 350°C			
	Part No.	359709	Ref. No.	—
	oven lamp glass thr. ø 33.5mm ø 42mm hard glas temp.-resist. 350°C			
	Part No.	359721	Ref. No.	407286
	gasket silicone ED ø 48mm ID ø 39.5mm thickness 5mm Qty 1 pcs			
	Part No.	359942	Ref. No.	—
	oven lamp glass thr. ø 33.5mm ø 41mm hard glas temp.-resist. 350°C			





1			
Part No.	359705	Ref. No.	407390
description	oven lamp glass thr. ø 33.5mm ø 52mm hard glas temp.-resist. 350°C		
For models:	ECD106, ECD110, ECD120, ECD220		

accessories for	359705			
	Part No.	359610	Ref. No.	184001 407288
	light bulb t.max. 300°C socket E14 15W 230V ø 22mm L 47mm lens L 20mm for oven lamp type Philips			
	Part No.	359700	Ref. No.	—
	gasket for pizza oven fibre glass ID ø 32.5mm ED ø 55mm thickness 5mm			
	Part No.	359721	Ref. No.	407286
	gasket silicone ED ø 48mm ID ø 39.5mm thickness 5mm Qty 1 pcs			

Table continues overleaf



accessories for	359705		
	Part No.	359837	Ref. No. —
	gasket ID ø 33mm ED ø 46mm thickness 1mm graphite		
	Part No.	359838	Ref. No. —
	gasket ID ø 33mm ED ø 45mm		



	1		
Part No.	359721	Ref. No.	407286
description	gasket silicone ED ø 48mm ID ø 39.5mm thickness 5mm Qty 1 pcs		
For models:	ECD106, ECD110, ECD120, ECD220		

mounting diameter 65.5mm

	1		
Part No.	359712	Ref. No.	183927
description	oven lamp mounting ø 65.5mm 230V 40W socket E14 temp.-resist. 300°C connection male faston 6.3mm hard glas		
For models:	CEC106, CEC110, CEC120, CEC220, CED106, CED110, CED120, CED220		
spare parts for	359712		
	Part No.	359022	Ref. No. —
	lamp socket socket E14 mounting ø 65.5mm connection male faston 6.3mm		
	Part No.	359611	Ref. No. 183926
	light bulb t.max. 300°C socket E14 40W 230V ø 45mm L 75mm lens L 50mm for oven lamp IMPORT		
	Part No.	359722	Ref. No. 062339 062539
	gasket silicone ID ø 57.5mm ED ø 68mm thickness 2mm		
	Part No.	359724	Ref. No. 407680
	oven lamp glass thread ø 62mm H 46mm ø 74mm hard glas temp.-resist. 350°C		

	1		
Part No.	359724	Ref. No.	407680
description	oven lamp glass thread ø 62mm H 46mm ø 74mm hard glas temp.-resist. 350°C		
For models:	CEC106, CEC110, CEC120, CEC220, CED106, CED110, CED120, CED220		

55x70mm

	1		
Part No.	359297	Ref. No.	131111
description	frame L 95mm W 81mm mounting distance 68/83mm thickness 6mm		
For models:	CBE106, CBE106-VAR091, CBE110, CBE110-VAR091, CBE120, CBE120-VAR091, CBE220, CBE220-VAR091, CBG110, CBG120, CCE106, CCE110, CCE120, CCE220, CEC106, CEC110, CEC120, CEC220, CED106, CED110, CED120, CED220, CEF106, CEF110, CEF120, CEF220, CEM110, CEM120, CGD110, CGD120, CPE106, CPE110, CPE120, CPE220		
accessories for	359297		
	Part No.	359299	Ref. No. 060323
	gasket L 91mm W 77mm hole ø 3mm for oven lamp		

	1		
Part No.	359299	Ref. No.	060323
description	gasket L 91mm W 77mm hole ø 3mm for oven lamp		
For models:	CBE106, CBE106-VAR091, CBE110, CBE110-VAR091, CBE120, CBE120-VAR091, CBE220, CBE220-VAR091, CBG110, CBG120, CCE106, CCE110, CCE120, CCE220, CEC106, CEC110, CEC120, CEC220, CED106, CED110, CED120, CED220, CEF106, CEF110, CEF120, CEF220, CEM110, CEM120, CGD110, CGD120, CPE106, CPE110, CPE120, CPE220		

	1		
Part No.	359296	Ref. No.	103702
description	lamp glass L 74mm W 58mm thickness 3mm		
For models:	CBE106, CBE106-VAR091, CBE110, CBE110-VAR091, CBE120, CBE120-VAR091, CBE220, CBE220-VAR091, CBG110, CBG120, CCE106, CCE110, CCE120, CCE220, CEC106, CEC110, CEC120, CEC220, CED106, CED110, CED120, CED220, CEF106, CEF110, CEF120, CEF220, CEM110, CEM120, CGD110, CGD120, CPE106, CPE110, CPE120, CPE220		

lamps

light bulbs

	1		
Part No.	359610	Ref. No.	184001 407288
description	light bulb t.max. 300°C socket E14 15W 230V ø 22mm L 47mm lens L 20mm for oven lamp type Philips		
For models:	ECD106, ECD110, ECD120, ECD220, ECL484, EHP601		



 <p>1</p>			
Part No.	357153	Ref. No.	184018
description	light bulb t.max. 300°C socket E14 25W 230V ø 25mm L 55mm lens L 30mm for oven type		

 <p>1</p>			
Part No.	359611	Ref. No.	183926
description	light bulb t.max. 300°C socket E14 40W 230V ø 45mm L 75mm lens L 50mm for oven lamp IMPORT		
For models:	CEC106, CEC110, CEC120, CEC220, CED106, CED110, CED120, CED220		

with time spread			
 <p>1</p>			
Part No.	350074	Ref. No.	174883
description	timer MS65 operation time 120min time spread 30min 1CO/2NO/1NC at 250V 16A permanent position yes impulse electric shaft ø 6x4.6mm shaft L 22mm mounting distance 28mm connection lateral Invensys 4-pole shaft position lower°		
For models:	CEC106, CEC110, CEC120, CEC220, CED106, CED110, CED120, CED220		

halogen lamps			
for socket G4 / G6.35 / G9			
 <p>1 500°C</p>			
Part No.	359599	Ref. No.	163000
description	halogen lamp socket G4 12V 20W temp.-resist. 500°C		
For models:	CBE106, CBE106-VAR091, CBE110, CBE110-VAR091, CBE120, CBE120-VAR091, CBE220, CBE220-VAR091, CBG110, CBG120, CCE106, CCE110, CCE120, CCE220, CEC106, CEC110, CEC120, CEC220, CED106, CED110, CED120, CED220, CEF106, CEF110, CEF120, CEF220, CEM110, CEM120, CGD110, CGD120, CPE106, CPE110, CPE120, CPE220		

alarm devices

buzzers			
 <p>1</p>			
Part No.	350050	Ref. No.	355612 407333
description	buzzer 230VAC connection male faston 6.3mm screw mounting thread M4 60dB		
For models:	CEC106, CEC110, CEC120, CEC220, CED106, CED110, CED120, CED220, ECL484, EDC106, NEP060, NEP203, NEP303, NTE182		

timers

electric timers

 <p>1</p>			
Part No.	350001	Ref. No.	174878 174946 355690 407267
description	timer 2CO at 250V 16A permanent position yes impulse electric shaft ø 6x4.6mm shaft L 22mm mounting distance 28mm connection rear 2-pole operation time 120min		
For models:	EAB051, EAB081, EAB101, EAB102, EAB112, ECD106, ECD110, ECD120, ECD220, ECL484		

contactors

ABB

power contactors			
 <p>1</p>			
Part No.	380092	Ref. No.	163519
description	power contactor resistive load 20A 230VAC (AC3/400V) 12A/5.5kW main contacts 4NO auxiliary contacts connection screw connection type B7-40-00		



GENERAL ELECTRIC (AEG)

power contactors



1

Part No.	380231	Ref. No.	185850
description	power contactor resistive load 16A 230VAC (AC3/400V) 6A/3kW main contacts 3NO auxiliary contacts 1NC connection screw connection type AEG LS0701A		
For models:	CED106, CED110, EAB051, EDC106, NEP060, NEP600, NEP900		



1

Part No.	380337	Ref. No.	163500 185890
description	power contactor resistive load 20A 230VAC (AC3/400V) 8.4A/4kW main contacts 4NO auxiliary contacts connection screw connection type AEG LS05 400A type GE MC1A 400A		
For models:	CBE106, CBE106-VAR091, CBE110, CBE110-VAR091, CBE120, CBE120-VAR091, CCE106, CEC106, CEC110, CEC120, CEC220, CED106, CED110, CED120, CED220, CEF106, CEF110, CEF120, CEM110, CEM120, CPE106, ECL484, EES060, FEB430, FEB630, FED080, FED150, FED250, FEF124, FEF170, FEF180, FEF224, FEF224e, FEH415, FEH500, FEH503, FEH505, FEH510, FEH513, FEH515, FEH615, FEH700, FEH705, FEH710, FEH715, FEK040, FEK060, FEK080, FEK100, FEK150...(Other models you can see in the webshop)		



1

Part No.	380262	Ref. No.	185775 185783
description	power contactor resistive load 32A 230VAC (AC3/400V) 17A/7.5kW main contacts 3NO auxiliary contacts 1NC connection screw connection type AEG LS7K01A type GE CLO2A 301 H 85mm		
For models:	CBE110, CBE110-VAR091, CCE110, CEC106, CEC110, CED106, CED110, CEF110, CEM110, CPE110, EES080, FED080, FED250, FED300, FEF144, FEF144e, FEK080, FEK100, FEK150, FEP230, FER300, FER400, FES080, FES100, FES150, NEK040, NEK060, NEK080, NEK100, NEK150, NEP203, NEP303, NEP600, NEP900, NEP901, NER080, NER150, NER250, NER300, NER400, NER500, NES040, NES060, NES080, NES100, NES150, NTE182, PED088, PED258, PED308...(Other models you can see in the webshop)		



1

Part No.	380264	Ref. No.	185776 185796
description	power contactor resistive load 45A 230VAC (AC3/400V) 25A/11kW main contacts 3NO auxiliary contacts connection screw connection type AEG LS11K 00A type GE CL25A 300		
For models:	CBE120, CBE120-VAR091, CBE220, CBE220-VAR091, CEC120, CEC220, CED120, CED220, CEF120, CEF220, CEM120, FED150, FEK150, FEP330, FER150, FES150, NER150, NER300, NER400, NES150, PED158, PEK158, PEP338, PER158, PES158		



1

Part No.	380265	Ref. No.	163531 185777 185797
description	power contactor resistive load 60A 230VAC (AC3/400V) 32A/16kW main contacts 3NO auxiliary contacts 1NO connection screw connection type AEG LS15K 00A type GE CLO4A 310 H 98mm L 87mm W 55mm		
For models:	CCE120, CEC110, CED110, CPE120, FED250, FED300, FER250, NER250, PED258, PED308, PER258, PER308		

auxiliary contactors



1

Part No.	380277	Ref. No.	185778 185845
description	auxiliary contactor 230V		
For models:	CEC106, CEC110, CEC120, CEC220, CED120, CED220, EDC106, NEP060, NTE182		



ISKRA (FANAL)

power contactors



1

Part No.	380212	Ref. No.	120461
description	power contactor resistive load 20A 230VAC (AC3/400V) 8.5A/5.5kW main contacts 3NO auxiliary contacts 1NC connection screw connection type Fanal K07M 01 type ISKRA DSL7 01		

MOELLER/EATON

power contactors



1

Part No.	380497	Ref. No.	185774 185798 185844 540428
description	power contactor resistive load 20A 230VAC (AC3/400V) 9A/4kW main contacts 4NO auxiliary contacts connection screw connection type DILEM 4		
For models:	CBE106, CBE106-VAR091, CBE110, CBE110-VAR091, CBE120, CBE120-VAR091, CBE220, CBE220-VAR091, CBG110, CBG120, CEC106, CEC110, CEC120, CEC220, CED106, CED110, CED120, CED220, CEF106, CEF110, CEF120, CEF220, CEM110, CEM120, CGD110, CGD120, ECL484, FEF124, FEF144, FEF144e, FEF170, FEF180, FEF224, PEF128, PEF148, PEF178, PEF188, PEF228		



1

Part No.	380167	Ref. No.	407331
description	power contactor resistive load 66A 230VAC (AC3/400V) 50A/22kW main contacts 3NO auxiliary contacts 1NO connection screw connection type DILM 50		

RC circuits



1

Part No.	380177	Ref. No.	407290
description	RC circuit type 20002 110/220V 50/60/DChz conductor 2 connection cable 230mm L 29mm ømm H 15mm W 20mm adhesive tape plastic Qty 1 pcs		
For models:	ECD106, ECD110, ECD120, ECD220		

ABL SURSUM

motor protection circuit breakers



1

Part No.	380300	Ref. No.	407528
description	motor protection circuit breaker type Mbs25-016 setting range 1-1.6A (AC3/400V) 0.55kW		
For models:	ECD106, ECD110		
accessories for	380300		
	Part No.	380305	Ref. No. 407529
	auxiliary contact contacts 1NO/1NC HMS11		



1

Part No.	380301	Ref. No.	407617
description	motor protection circuit breaker type Mbs25-025 setting range 1.6-2.5A (AC3/400V) 1.1kW		
For models:	ECD120, ECD220		



accessories



1

Part No.	380305	Ref. No.	407529
description	auxiliary contact contacts 1NO/1NC HMS11		
For models:	ECD106, ECD110, ECD120, ECD220		

solid state relays

CELDUC





1

Part No.	401462	Ref. No.	164889
description	solid state relay CELDUC 1 phase 5A 600V 5-30VDC L 90mm W 12mm for top-hat rail screw type SKA20460		
For models:	CCE106, CCE110, CCE120, CCE220, CPE106, CPE110, CPE120, CPE220		



1

Part No.	401459	Ref. No.	164888
description	solid state relay CELDUC 2 phase 50A 24-600V 6-16VDC L 59mm W 46mm screw type SOB965160		
For models:	CCE106, CCE110, CCE120, CCE220, CPE106, CPE110, CPE120, CPE220		
spare parts for	401459		
	Part No.	401676	Ref. No. —
	heat-conducting foil L 57mm W 45mm		
accessories for	401459		
	Part No.	550802	Ref. No. —
	PCB terminal block 4-pole raster size 5mm		

relays

time relays

time relays



1

Part No.	381217	Ref. No.	407270
description	time relay DOLD MK7850N.82/210/61 time range 0.02s-300h 12-240V AC/DC 5A mounting measurements 35mm multi-functional connection screw clamp ambient temperature max. 60°C with jumper wire X2-X3		



1

Part No.	380280	Ref. No.	407271
description	time relay WIELAND NGZ11 time range 1.5-30s 24-240V AC/DC 5A connection grip connection		
For models:	ECD106, ECD110, ECD120, ECD220		

transformers

encapsulated transformers

PMA



1

Part No.	379054	Ref. No.	407157
description	transformer primary 230VAC secondary 12VAC 3VA secondary 0.25A H 40mm L 45mm W 50mm connection screw 50/60Hz type 153/M		
For models:	NEF176, NEP203, NEP303		



electronic controllers

SHANGFANG

accessories



1			
Part No.	379054	Ref. No.	407157
description	transformer primary 230VAC secondary 12VAC 3VA secondary 0.25A H 40mm L 45mm W 50mm connection screw 50/60Hz type 153/M		
For models:	NEF176, NEP203, NEP303		

miscellaneous

universal controllers



1			
Part No.	379020	Ref. No.	407338
description	electronic controller Pt100 steam control		
For models:	ECD106, ECD110, ECD120, ECD220		

probes

producer-specific probes

probes

1			
Part No.	379911	Ref. No.	161615
description	temperature probe Pt100 cable glass fibre probe -100 up to 450°C cable -50 up to +350°C connection 2-wire thread probe ø4.6x13mm cable length 0.5m		
For models:	FEF170, FEF180, NEP203, NEP303, NEP601, NEP901, PEF178, PEF188		

1			
Part No.	379913	Ref. No.	995935002
description	temperature probe Pt100 cable glass fibre probe -100 up to 450°C cable -50 up to +350°C connection 2-wire thread probe ø4.6x13mm cable length 0.5m		
For models:	FEP230, FEP330, FEP610, FEP910, PEP238, PEP338, PEP618, PEP918		

1			
Part No.	379168	Ref. No.	161608
description	temperature probe Pt100 cable PTFE probe -100 up to 450°C cable -40 up to +250°C connection 2-wire thread M5 probe ø5x30mm cable length 2m		
For models:	CBE106, CBE106-VAR091, CBE110, CBE110-VAR091, CBE120, CBE120-VAR091, CBE220, CBE220-VAR091, CBG110, CBG120, CCE120, CCE220, CEC106, CEC110, CEC120, CEC220, CED106, CED110, CED120, CED220, CEF106, CEF110, CEF120, CEF220, CEM110, CEM120, CGD110, CGD120, CPE120, CPE220		

1			
Part No.	379070	Ref. No.	407334 407339
description	temperature probe Pt100 cable silicone probe -50 up to +250°C cable -50 up to +180°C connection 2-wire thread probe ø4x75mm cable length 1.7m		
For models:	ECD106, ECD110, ECD120, ECD220		

1			
Part No.	379999	Ref. No.	161633
description	temperature probe Pt1000 cable PTFE probe -70 up to +500°C cable -40 up to +250°C connection male faston 2.8mm thread M5x1 probe ø5x30mm cable length 0.1m		
For models:	CCE106, CCE110, CCE120, CCE220, CPE106, CPE110, CPE120, CPE220		

core probes

1			
Part No.	379112	Ref. No.	407610
description	core temperature probe Pt100 cable PTFE probe -40 up to +250°C cable -40 up to +250°C connection 2-wire probe ø3.2x100mm thread M12 cable length 2.8m handle ø 10mm handle length 80mm		

1			
Part No.	379898	Ref. No.	161628
description	core temperature probe Pt100 cable PTFE probe -40 up to +250°C cable -40 up to +250°C connection 2-wire probe ø4x100mm thread M9x1 cable length 2m handle ø 9mm handle length 45mm		
For models:	CBE106, CBE106-VAR091, CBE110, CBE110-VAR091, CBE120, CBE120-VAR091, CBE220, CBE220-VAR091, CBG110, CBG120		

1			
Part No.	379899	Ref. No.	161634 161642
description	core temperature probe Pt1000 cable thermoplastic probe -40 up to +250°C cable -40 up to +110°C connection 2-wire probe ø4x100mm thread M9x1 cable length 2m handle ø 9mm handle length 65mm		
For models:	CCE106, CCE110, CCE120, CCE220, CPE106, CPE110, CPE120, CPE220		



electronics

PCBs



1

Part No.	401461	Ref. No.	161603 161630
description	control PCB combi-steamer CBE 106		
For models:	CBE106, CBE106-VAR091, CBE110, CBE110-VAR091, CBE120, CBE120-VAR091, CBE220, CBE220-VAR091, CBG110, CBG120, CEC106, CEC110, CEC120, CEC220, CED106, CED110, CED120, CED220, CGD110, CGD120		



2

Part No.	401468	Ref. No.	164885
description	display PCB combi-steamer CBE 106		
For models:	CCE106, CCE110, CCE120, CCE220		

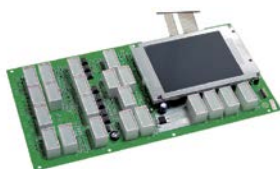

1

Part No.	401481	Ref. No.	164884 165279
description	PCB		
For models:	CPE106, CPE110, CPE120, CPE220		

solenoid valves











solenoid valves (water)

MÜLLER











medium temperature: 90°C
duty cycle: 100%













1

Part No.	370004	Ref. No.	173121
description	solenoid valve double straight 230VAC inlet 3/4" outlet 14.5mm DN10 t.max. 90°C duty cycle 100% MÜLLER		
For models:	CBE120, CBE120-VAR091, CBE220, CBE220-VAR091, CBG110, CBG120, CCE120, CCE220, CEC120, CEC220, CED120, CED220, CEF120, CEF220, CEM120, CGD110, CGD120, CPE120, CPE220, NTE182		
spare parts for	370004		
	Part No.	370129	Ref. No. —
	solenoid valve body double straight inlet 3/4" outlet 14.5mm DN10 t.max. 90°C duty cycle 100% MÜLLER 230V		
	Part No.	371002	Ref. No. —
	solenoid valve holder MÜLLER flange support		
	Part No.	371009	Ref. No. —
	compression spring for solenoid coil		
	Part No.	371011	Ref. No. —
	spare parts kit membrane with long star star high 8mm MÜLLER		
	Part No.	371017	Ref. No. —
	solenoid coil MÜLLER 230VAC connection male faston 6.3mm		
	Part No.	371122	Ref. No. —
	solenoid valve filter ø 19mm H 10mm suitable for MÜLLER		
	Part No.	501161	Ref. No. —
	tap head for solenoid valve holder for solenoid coils		
accessories for	370004		
	Part No.	371010	Ref. No. 407350
	solenoid coil 230VAC connection with cable cable length 2000mm		
	Part No.	371037	Ref. No. —
	solenoid coil 24VAC 50/60Hz connection male faston 6.3mm		
	Part No.	371038	Ref. No. —
	solenoid coil 230VAC connection appliance plug		



 <p>1</p>			
Part No.	370117	Ref. No.	407352
description	solenoid valve single straight 230VAC inlet 3/4" outlet 11.5mm DN10 t.max. 90°C duty cycle 100% MÜLLER		
spare parts for	370117		
	Part No.	370133	Ref. No. 407597
	solenoid valve body single straight inlet 3/4" outlet 11.5mm DN10 t.max. 90°C duty cycle 100% MÜLLER 230V		
	Part No.	371002	Ref. No. —
	solenoid valve holder MÜLLER flange support		
	Part No.	371009	Ref. No. —
	compression spring for solenoid coil		
	Part No.	371011	Ref. No. —
	spare parts kit membrane with long star star hight 8mm MÜLLER		
	Part No.	371017	Ref. No. —
	solenoid coil MÜLLER 230VAC connection male faston 6.3mm		
	Part No.	371122	Ref. No. —
	solenoid valve filter ø 19mm H 10mm suitable for MÜLLER		
	Part No.	501161	Ref. No. —
	tap head for solenoid valve holder for solenoid coils		
accessories for	370117		
	Part No.	371010	Ref. No. 407350
	solenoid coil 230VAC connection with cable cable length 2000mm		
	Part No.	371037	Ref. No. —
	solenoid coil 24VAC 50/60Hz connection male faston 6.3mm		
	Part No.	371038	Ref. No. —
	solenoid coil 230VAC connection appliance plug		

 <p>1</p>			
Part No.	370002	Ref. No.	355635
description	solenoid valve single straight 230VAC inlet 3/4" outlet 14.5mm DN10 t.max. 90°C duty cycle 100% MÜLLER		
For models:	CBE120, CBE120-VAR091, CBE220, CBE220-VAR091, CBG120, CCE120, CCE220, CEC120, CEC220, CED120, CED220, CEF120, CEF220, CEM120, CGD120, CPE120, CPE220, EAB051, EAB081, EAB101, EAB102, EAB112, EDC106, NDD080, NDD150, NDD250, NDD300, NED080, NED150, NED250, NED300, NHD080, NHD150, NHD250, NHD300		
spare parts for	370002		
	Part No.	370127	Ref. No. —
	solenoid valve body single straight inlet 3/4" outlet 14.5mm DN10 t.max. 90°C duty cycle 100% MÜLLER 230V		

spare parts for	370002		
	Part No.	371002	Ref. No. —
	solenoid valve holder MÜLLER flange support		
	Part No.	371009	Ref. No. —
	compression spring for solenoid coil		
	Part No.	371011	Ref. No. —
	spare parts kit membrane with long star star hight 8mm MÜLLER		
	Part No.	371017	Ref. No. —
	solenoid coil MÜLLER 230VAC connection male faston 6.3mm		
	Part No.	371122	Ref. No. —
	solenoid valve filter ø 19mm H 10mm suitable for MÜLLER		
	Part No.	501161	Ref. No. —
	tap head for solenoid valve holder for solenoid coils		
accessories for	370002		
	Part No.	371010	Ref. No. 407350
	solenoid coil 230VAC connection with cable cable length 2000mm		
	Part No.	371037	Ref. No. —
	solenoid coil 24VAC 50/60Hz connection male faston 6.3mm		
	Part No.	371038	Ref. No. —
	solenoid coil 230VAC connection appliance plug		

spare parts and accessories

valve bodies

 <p>1</p>			
Part No.	370133	Ref. No.	407597
description	solenoid valve body single straight inlet 3/4" outlet 11.5mm DN10 t.max. 90°C duty cycle 100% MÜLLER 230V		
For models:	ECD106, ECD110, ECD120, ECD220		

solenoid coils

 <p>1</p>			
Part No.	371010	Ref. No.	407350
description	solenoid coil 230VAC connection with cable cable length 2000mm		
For models:	ECD106, ECD110, ECD120, ECD220		



ROBERTSHAW/INVENSYS

medium temperature: 90°C 90°C 60°C
 ambient temperature: 60°C 25°C 60°C
 duty cycle: 40% 100% 100%



Part No.	370371	Ref. No.	407280
description	solenoid valve double straight 230VAC inlet 3/4" outlet 11.5mm DN10 EATON (INVENSYS) cable length 2000mm		
For models:	ECD106, ECD110, ECD120, ECD220		

metal

LUCIFER

2-way

121Z series



Part No.	370071	Ref. No.	173133
description	solenoid valve 2-ways 230VAC connection 1/8" DN 2.5mm slide-on receptacle DIN -20° up to 130°C LUCIFER-PARKER type series 121Z coil type DZ06S6 membranes FKM (water) p max 10bar		
For models:	CEC106, CEC110, CED106, CED110, FED080, FED150, FED250, FED300, PED088, PED158, PED258, PED308		

spare parts for 370071

	Part No.	371031	Ref. No.	—
		solenoid coil LUCIFER-PARKER 230VAC 9VA coil type DZ06S6 seat ø 15mm		

accessories for 370071

	Part No.	371090	Ref. No.	—
		power socket plug type DIN 43650A screw		

ball valves electric



Part No.	401190	Ref. No.	120110 151006 164011 994595006 994898006 994899006
description	ball valve inlet 3/4" IT outlet 3/4" IT IP42 230V L 68mm 50/60Hz closed off-current mode of operation electric connection cable 300mm 3.5W duty cycle 50%		
For models:	CBE106-VAR091, CBE110-VAR091, CBE120-VAR091, CBE220-VAR091, CCE106, CCE110, CCE120, CCE220, CED106, CED110, CED120, CED220, CEF106, CEF110, CEF120, CEF220, CEM110, CEM120, CPE106, CPE110, CPE120, CPE220		

electrodes



Part No.	400072	Ref. No.	146440 983811002 988107006
description	level electrode push-in total length 100mm probe L 90mm insulated probe length 78mm connection F6.3 ø 6mm		
For models:	CBE106-VAR091, CCE106, CED106, CEF106, CPE106, FED080, FED150, FED250, FED300, FGR150, FGR250, FGR300, FGR400, NGR150, NGR250, NGR300, NGR400, PED088, PED158, PED258, PED308		



Part No.	400071	Ref. No.	984708002 988108006
description	level electrode push-in total length 170mm probe L 155mm insulated probe length 140mm connection F6.3 ø 5mm		
For models:	CBE110-VAR091, CBE120-VAR091, CBE220-VAR091, CCE110, CCE120, CCE220, CED110, CED120, CED220, CEF110, CEF120, CEF220, CEM110, CEM120, CPE110, CPE120, CPE220		





1 electric components





fans

hot air motors

1 			
Part No.	510533	Ref. No.	146361 755770000
description	clamping ring for L9		
For models:	CEC110, CEC120, CEC220, CED110, CED120, CED220		

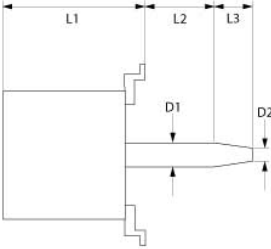
1 			
Part No.	693495	Ref. No.	146769
description	counterflange for fan motor ED ϕ 60mm int. ϕ 1 35mm int. ϕ 2 26mm thickness 7mm brass		
For models:	CBE110, CBE110-VAR091, CBE120, CBE120-VAR091, CBE220, CBE220-VAR091, CBG110, CBG120, CCE110, CCE120, CCE220, CEC110, CEC120, CEC220, CED110, CED120, CED220, CEF110, CEF120, CEF220, CEM110, CEM120, CGD110, CGD120, CPE110, CPE120, CPE220		
accessories for	693495		
1 			
Part No.	510533	Ref. No.	146361 755770000
description	clamping ring for L9		
1 			
Part No.	510540	Ref. No.	146360 755769000
description	gasket brass for fan motor ID ϕ 23mm ED ϕ 29.6mm		
1 			
Part No.	510542	Ref. No.	062131
description	gasket for fan motor ID ϕ 42mm ED ϕ 61mm thickness 1mm		

1 			
1 			
Part No.	500109	Ref. No.	115980 115989 120122
description	fan motor 220-240/380-415V 3 phase 50Hz 0.85kW 1360rpm speeds 1 L1 220mm L2 35mm L3 29mm M14L IT 4.3/2.5A power input 1170W Cos(fi) 0.71 at 50Hz 1360rpm type L9FG4D-160 no. X1 D1 ϕ 23mm D2 ϕ 20mm		
For models:	CBE220, CCE220, CEC220, CED220, CPE220		

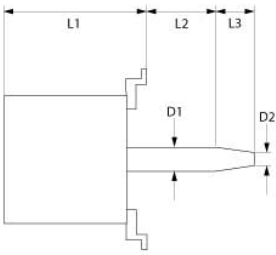
1 			
1 			
Part No.	500905	Ref. No.	120105
description	fan motor 380-415V 3 phase 50Hz 0.12/0.4kW 700/1350rpm speeds 2 L1 180mm L2 49mm L3 30mm M14R IT 0.55/1.0A power input 40/250W at 50Hz 700/1350rpm type L9Rw84b-285 D1 ϕ 23mm D2 ϕ 20mm		
For models:	CBE110-VAR091, CBE120-VAR091, CED110, CED120, CEF110, CEF120, CEM110, CEM120		

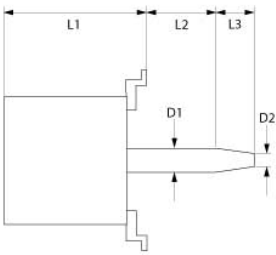
1 			
1 			
Part No.	500906	Ref. No.	120103
description	fan motor 380-415V 3 phase 50Hz 0.12/0.9kW 700/1380rpm speeds 2 L1 217mm L2 45mm L3 30mm M14R IT 0.9/2.1A power input 240/1200W at 50Hz 700/1380rpm Y/YY type L9zw84D-286 no. V1 D1 ϕ 23mm D2 ϕ 20mm		
For models:	CBE220-VAR091, CED220, CEF220		

1 			
Part No.	601298	Ref. No.	174256
description	fan wheel D1 ϕ 280mm H1 115mm blades 42		
For models:	CBE106, CBE106-VAR091, CCE106, CEC106, CED106, CEF106, CPE106		



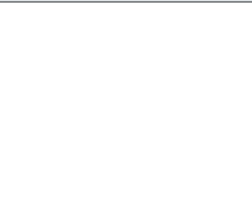

			
1			
Part No.	601049	Ref. No.	407448
description	fan wheel D1 ø 280mm H1 125mm blades 12 D2 ø 11mm D3 ø 16mm H2 37mm		
For models:	ECD106		

			
1			
Part No.	601303	Ref. No.	174257
description	fan wheel D1 ø 355mm H1 127mm blades 42 D2 ø 20mm D3 ø 22mm H2 48mm		
For models:	CBE110, CBE110-VAR091, CBE120, CBE120-VAR091, CBG110, CBG120, CCE110, CCE120, CEC110, CEC120, CED110, CED120, CEF110, CEF120, CEM110, CEM120, CGD110, CGD120, CPE110, CPE120		

			
1			
Part No.	601304	Ref. No.	174265
description	fan wheel D1 ø 400mm H1 127mm		
For models:	CBE220, CBE220-VAR091, CCE220, CEC220, CED220, CEF220, CPE220		

			
1			
Part No.	510539	Ref. No.	146193 754860000
description	flange for fan motor ED ø 60mm int. ø 130mm int. ø 220mm thickness 3mm brass		
For models:	CBE106, CBE106-VAR091, CCE106, CEC106, CED106, CEF106, CPE106		

			
1			
Part No.	510541	Ref. No.	146195 784863000
description	gasket brass for fan motor ID ø 17.3mm ED ø 25mm		
For models:	CBE106, CBE106-VAR091, CCE106, CEC106, CED106, CEF106, CPE106		

			
1			
Part No.	510537	Ref. No.	146194
description	gasket brass for fan motor ID ø 20mm ED ø 29.5mm		
For models:	CBE106, CBE106-VAR091, CCE106, CEC106, CED106, CEF106, CPE106		

			
1			
Part No.	510540	Ref. No.	146360 755769000
description	gasket brass for fan motor ID ø 23mm ED ø 29.6mm		
For models:	CBE110, CBE110-VAR091, CBE120, CBE120-VAR091, CBE220, CBE220-VAR091, CBG110, CBG120, CCE110, CCE120, CCE220, CEC110, CEC120, CEC220, CED110, CED120, CED220, CEF110, CEF120, CEF220, CEM110, CEM120, CGD110, CGD120, CPE110, CPE120, CPE220		

			
1			
Part No.	510542	Ref. No.	062131
description	gasket for fan motor ID ø 42mm ED ø 61mm thickness 1mm		
For models:	CBE106, CBE106-VAR091, CBE110, CBE110-VAR091, CBE120, CBE120-VAR091, CBE220, CBE220-VAR091, CBG110, CBG120, CCE106, CCE110, CCE120, CCE220, CEC106, CEC110, CEC120, CEC220, CED106, CED110, CED120, CED220, CEF106, CEF110, CEF120, CEF220, CEM110, CEM120, CGD110, CGD120, CPE106, CPE110, CPE120, CPE220		

condensators & interference suppression filters

filters

RC circuits

			
1			
Part No.	380177	Ref. No.	407290
description	RC circuit type 20002 110/220V 50/60/DChz conductor 2 connection cable 230mm L 29mm ømm H 15mm W 20mm adhesive tape plastic Qty 1 pcs		
For models:	ECD106, ECD110, ECD120, ECD220		

fuses

fine fuses

			
1			
Part No.	358598	Ref. No.	407274
description	fine fuse size ø5x20mm 0.63A slow-acting rated 250V Qty 10 pcs		
For models:	ECD106, ECD110, ECD120, ECD220		





			
1			
Part No.	358608	Ref. No.	216327
description	fine fuse size ø5x20mm 10A slow-acting rated 250V Qty 10 pcs		
For models:	CEC106, CEC110, CEC120, CEC220, CED120, CED220		

			
1			
Part No.	358607	Ref. No.	407273
description	fine fuse size ø5x20mm 6.3A slow-acting rated 250V Qty 10 pcs		
For models:	ECD106, ECD110, ECD120, ECD220		

screw locks

D0-system (NEOZED)

			
1			
Part No.	358045	Ref. No.	407502
description	fuse size D02 35A rated 250/400V E18 ø 15mm L 36mm Qty 10 pcs		
For models:	ECD220		

			
1			
Part No.	358046	Ref. No.	407503
description	fuse size D02 50A rated 250/400V E18 ø 15mm L 36mm Qty 10 pcs		
For models:	ECD220		

gauge pieces (NEOZED)

			
1			
Part No.	358067	Ref. No.	407650
description	gauge piece size D02 suitable for 35A		
For models:	ECD220		

			
1			
Part No.	358068	Ref. No.	407649
description	gauge piece size D02 suitable for 50A		
For models:	ECD220		

fuse holders

			
1			
Part No.	358060	Ref. No.	407500
description	fuse holder suitable fuse D02 3-pole-pole 63A rated 400V		
For models:	ECD220		

			
1			
Part No.	358061	Ref. No.	407501
description	fuse holder suitable fuse D02 ø 25mm mounting ø 18mm rated 400V L 30mm		
For models:	ECD220		

electric accessories

terminals

rail-mounted terminals

WIELAND

rail-mounted terminals type 9700A

			
1			
Part No.	550374	Ref. No.	407450 407456
description	rail-mounted terminal WIELAND type 9700A/10 S35 1.5-16mm² top-hat rail 35mm blue W 10mm L 49mm		
For models:	ECD106, ECD110		

			
1			
Part No.	550373	Ref. No.	407345
description	rail-mounted terminal WIELAND type 9700A/10 S35 1.5-16mm² top-hat rail 35mm grey W 10mm L 49mm		
For models:	ECD106, ECD110, ECD220		



			
1			
Part No.	550375	Ref. No.	407346
description	rail-mounted terminal WIELAND type 9700A/10 SL2 S35 1.5-16mm ² top-hat rail 35mm yellow/green W 10mm L 53mm		
For models:	ECD106, ECD110		

			
1			
Part No.	550377	Ref. No.	407485
description	rail-mounted terminal WIELAND type 9700A/16 S35 2.5-35mm ² top-hat rail 35mm blue W 16mm L 59mm		
For models:	ECD120		

			
1			
Part No.	550376	Ref. No.	407484
description	rail-mounted terminal WIELAND type 9700A/16 S35 2.5-35mm ² top-hat rail 35mm grey W 16mm L 59mm		
For models:	ECD120		

			
1			
Part No.	550378	Ref. No.	407486
description	rail-mounted terminal WIELAND type 9700A/16 SL2 S35 2.5-35mm ² top-hat rail 35mm yellow/green W 16mm L 53mm		
For models:	ECD120		

accessories

			
1			
Part No.	550337	Ref. No.	407618
description	end barrier for fuse terminal clampsmm ²		
For models:	ECD120, ECD220		

			
1			
Part No.	550370	Ref. No.	407533
description	terminal block end bracket clampsmm ²		
For models:	ECD106, ECD110, ECD120, ECD220		

electronic magnets

			
1			
Part No.	401463	Ref. No.	162200
description	lifting magnet		
For models:	CBE106, CBE106-VAR091, CBE110, CBE110-VAR091, CBE120, CBE120-VAR091, CBE220, CBE220-VAR091, CBG110, CBG120, CCE106, CCE110, CCE120, CCE220, CEC106, CEC110, CEC120, CEC220, CED106, CED110, CED120, CED220, CEF106, CEF110, CEF120, CEF220, CEM110, CEM120, CGD110, CGD120, CPE106, CPE110, CPE120, CPE220		

gas taps

alternatives to EGA

GPEL21 series

with nozzle outlet



















				
1				
Part No.	101634	Ref. No.	170883 406929 406948	
description	gas tap alternatives to EGA type GPEL21D with nozzle outlet (with nozzle) gas inlet M15x1 (tube \varnothing 10mm) external nozzle \varnothing 1.85mm internal nozzle \varnothing 1.05mm bypass nozzle \varnothing 0.5mm mixing pipe connection M17x1 thermocouple connection M8x1 pilot connection M10x1 shaft \varnothing 6x4.6mm shaft L 31/23mm shaft flat left			
For models:	NGH200, NGH202, NGH400, NGH403, NGH405, NGH407, NGH600, NGH603, NGH605, NGH607, NGH720, NGH723, NGH725, NGH727			
spare parts for	101634			
	Part No.	100302	Ref. No.	—
	gas injector thread M12x1 WS 14 bore \varnothing 1.85mm			
	Part No.	100312	Ref. No.	—
	internal nozzle bore \varnothing 1.05mm suitable for EGA26400/26440			
	Part No.	100526	Ref. No.	—
	bypass nozzle type PEL20/21 bore \varnothing 0.5mm thread M5x0.5			
	Part No.	100927	Ref. No.	—
	torsion spring L 2.8-8.0mm for internal nozzle \varnothing 3mm bore \varnothing mm			

Table continues overleaf



spare parts for		101634	
	Part No.	101060	Ref. No. 407088
	magnet unit standard L 39mm D1 ø 15.4mm D2 ø 11mm suitable for PEL20-21/JUNKERS/EGA		
	Part No.	101230	Ref. No. —
	thermocouple nut T1: M8x1 T2: M18x1 aluminium		
	Part No.	101526	Ref. No. —
	O-ring Viton thickness 1.78mm ID ø 4.48mm Qty 1 pcs		
	Part No.	101593	Ref. No. —
	adjusting screw for internal nozzle thread M8x0.75		
	Part No.	101802	Ref. No. —
	gas tap front part shaft ø 6x4.6mm shaft L 30/23mm shaft flat right/left suitable for PEL21		
accessories for		101634	
	Part No.	100908	Ref. No. —
	union screw thread M10x1 for pipe ø 4mm Qty 1 pcs		
	Part No.	100909	Ref. No. —
	union screw thread M10x1 for pipe ø 6mm Qty 1 pcs		
	Part No.	100926	Ref. No. —
	centring piece thread M17x1		
	Part No.	100942	Ref. No. —
	union nut thread M15x1 for pipe ø 10mm		
	Part No.	101246	Ref. No. —
	olive for pipe ø 4mm Qty 1 pcs		
	Part No.	101278	Ref. No. 114101
	olive for pipe ø 10mm Qty 1 pcs		
	Part No.	101286	Ref. No. —
	olive ID ø 6mm Qty 1 pcs		
	Part No.	110078	Ref. No. —
	knob without symbol ø 70mm shaft ø 6x4.6mm shaft flat universal		
	Part No.	112206	Ref. No. —
	knob dial plate silver gas tap PEL21/22/23 t.max.°C ED ø 63mm ID ø 45.5mm		



gas valves and ignition boxes

gas control valves

HONEYWELL



1

Part No.	102320	Ref. No.	151605
description	gas valve type VK4105Q 220-240V 50/60Hz gas inlet flange 32x32mm gas outlet flange 32x32mm thermocouple connection pilot connection pressure range 15-60mbar max 60mbar operator type HONEYWELL coil type 220/240V (V4336A 2212 1) flange 32x32mm		
For models:	PGP608, PGP618, PGP908, PGP918		
accessories for	102320		
	Part No.	102845	Ref. No. —
	gas connection angled 1/2" flange 32x32mm hole distance 24x24mm Tandem		
	Part No.	102846	Ref. No. —
	gas connection straight 1/2" flange 32x32mm hole distance 24x24mm suitable for Tandem		

SIT

ELETTROSIT



1







Part No.	101518	Ref. No.	173243
description	gas valve SIT type ELETTROSIT 230V gas inlet 3/4" gas outlet 3/4" thermocouple connection ASA 11/32 pilot connection M10x1 lateral equiv. no. 0.810.200		
For models:	CBG110, CBG120, CGD110, CGD120, NGR150, NGR250, NGR300, NGR400, NGS040, NGS060, NGS080, NGS100, NGS150		
spare parts for	101518		
	Part No.	100006	Ref. No. —
	piezoelectric igniter suitable for ELETTROSIT body plastic blowing connection ø2.4mm ø 14mm		
	Part No.	101312	Ref. No. —
	microswitch		
	Part No.	101352	Ref. No. —
	solenoid coil 230V 50Hz suitable for ELETTROSIT		

Table continues overleaf



accessories for 101518			
	Part No.	100905	Ref. No. —
locking screw M10x1 for pipe ø 6mm Qty 1 pcs			
	Part No.	101301	Ref. No. —
gas connection thread 1/2" straight ELETTROSIT screw with O-ring			
	Part No.	101303	Ref. No. —
gas connection straight thread 3/4" ELETTROSIT			
	Part No.	101309	Ref. No. —
extension			

ignition boxes

HONEYWELL

			
1			
Part No.	101166	Ref. No.	540409
description ignition box HONEYWELL type S4560B 1006 electrodes 1 waiting time 0s safety time 10s 220-240V 10VA 50Hz			

			
1			
Part No.	102318	Ref. No.	164844
description ignition box HONEYWELL type S4565AF 1007V01 electrodes 2 waiting times safety time 10s 220-240V 4VA 50/60Hz			
For models: PGP608, PGP618, PGP908, PGP918			

ignition parts

pilot burners

JUNKERS

CB 502 series







pilot burners





1			
Part No.	100085	Ref. No.	161134 161149 161234
description pilot burner JUNKERS type CB502031 natural gas nozzle no.6 gas connection 6mm with primary air			
For models: CBG110, CBG120, CGD110, CGD120, EGB230, EGB430, EGF124, EGF224, EGS060, FGH500, FGH507, FGW250, GPN402, GPP202, GWN101, GWN201, GWN202, LGB430, LGF124, LGF224, LGG420, LGP400, LGS060, NGB430, NGF224, NGG420, NGH500, NGH503, NGH505, NGH507, NGH720, NGH723, NGH725, NGH727, NGH730, NGH733, NGH737, NGP400, NGP600, NGP900, NGS040, NGS060, NGS080, NGS100, NGS150, NGW250, NGW450, PGB438, PGF148, PGF228...(Other models you can see in the webshop)			
spare parts for 100085			
	Part No.	100227	Ref. No. —
pilot burner nozzle natural gas gas pressure 25mbar code 6 Qty 1 pcs suitable for JUNKERS CB50203_			
	Part No.	100704	Ref. No. 407123
ignition electrode D1 ø 9mm connection M4 D2 ø 11mm L1 17mm L2 17mm BL1 13mm BL2 4mm BL3 22mm			
	Part No.	100909	Ref. No. —
union screw thread M10x1 for pipe ø 6mm Qty 1 pcs			
	Part No.	101287	Ref. No. —
olive for pipe ø 6mm Qty 1 pcs			
	Part No.	101292	Ref. No. —
union screw for igniter suitable for CB 502/505 Qty 1 pcs			
	Part No.	101295	Ref. No. —
clamping collet for thermocouple suitable for CB 502/505 Qty 1 pcs			
accessories for 100085			
	Part No.	100220	Ref. No. 161141
pilot burner nozzle LPG gas pressure 50mbar code 2 Qty 1 pcs suitable for JUNKERS CB503_			
	Part No.	100221	Ref. No. —
pilot burner nozzle LPG gas pressure 30mbar code 29 Qty 1 pcs suitable for JUNKERS CB50203_			
	Part No.	100222	Ref. No. 161149
pilot burner nozzle LPG gas pressure 50mbar code 5 Qty 1 pcs suitable for JUNKERS CB50203_			
	Part No.	100223	Ref. No. 161140
pilot burner nozzle natural gas gas pressure 20mbar code 3 Qty 1 pcs suitable for JUNKERS CB503_			

Table continues overleaf



accessories for		100085	
	Part No.	100224	Ref. No. —
pilot burner nozzle natural gas gas pressure 25mbar code 26 Qty 1 pcs suitable for JUNKERS CB503_			
	Part No.	100225	Ref. No. —
pilot burner nozzle LPG gas pressure 30mbar code 39 Qty 1 pcs suitable for JUNKERS CB503_			
	Part No.	100226	Ref. No. —
pilot burner nozzle LPG gas pressure 50mbar code 15 suitable for JUNKERS			
	Part No.	100228	Ref. No. —
pilot burner nozzle town gas gas pressure 8mbar code 4 Qty 1 pcs suitable for JUNKERS CB50203_			
	Part No.	101281	Ref. No. —
olive for pipe \varnothing 4mm L 8.7mm Qty 1 pcs suitable for CB 502/503			
	Part No.	101283	Ref. No. —
union screw thread M10x1 for pipe \varnothing 4mm Qty 1 pcs			

	Part No.	102202	Ref. No.	161111 162111 174409 504113 506112
description thermocouple M8x1 L 320mm plug connection \varnothing 5.0mm				
For models: EGB230, EGB430, EGH210, EGH410, EGH413, EGH417, EGH610, EGH613, EGH617, FGH210, FGH410, FGH413, FGH415, FGH417, FGH500, FGH507, FGH610, FGH613, FGH615, FGH617, GHN201, GHN202, GHN401, GHN402, GHN601, GHN602, GHN801, GHN802, GHP601, GPP202, GWN202, LGB430, LGF124, LGF224, LGG420, LGH405, LGH407, LGH605, LGH607, NGB430, NGG420, NGH200, NGH202, NGH400, NGH403, NGH405, NGH407, NGH500, NGH503, NGH505...(Other models you can see in the webshop)				
accessories for		102202		
	Part No.	101260	Ref. No.	—
thermocouple fitting thread M8x1 Qty 1 pcs				

ignition cables

pre-assembled cables

	Part No.	100025	Ref. No.	784231002
description ignition cable cable length 600mm connection \varnothing 4mm / F6.3mm				

ignition units

	Part No.	101016	Ref. No.	185310
description ignition unit outputs 2 230VAC inlet F6.3x0.8 outlet F2.8x0.8 1.7VA 50Hz mounting \varnothing 42mm				
For models: CBG110, CBG120, CGD110, CGD120, NGR150, NGR250, NGR300, NGR400, NGS040, NGS060, NGS080, NGS100, NGS150				

thermocouples

plug-in thermocouples

plug-in thermocouples standard

with barrel socket \varnothing 5mm - type Junkers with aluminised tip

	Part No.	102211	Ref. No.	174410
description thermocouple M10x1 L 320mm plug connection \varnothing 5.0mm				
For models: GPN402				

with barrel socket \varnothing 6mm

type Junkers with aluminised tip

	Part No.	102218	Ref. No.	162132 162139 356251
description thermocouple M8x1 L 320mm plug connection \varnothing 6.0mm				
For models: GHN401, GHN402, GHN601, GHN602, GHN801, GHN802, GHO101				

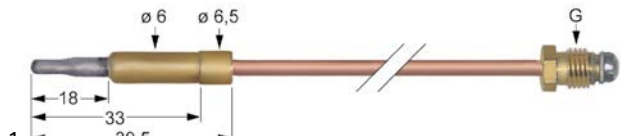
	Part No.	102220	Ref. No.	162112 162140
description thermocouple M8x1 L 600mm plug connection \varnothing 6.0mm				
For models: GPN402, GWN101, GWN201				

with barrel socket \varnothing 6(6.5)mm

thermocouples with aluminised tip

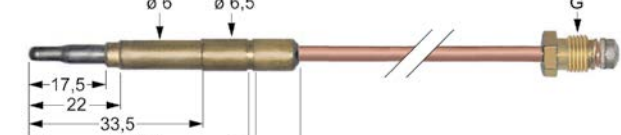
	Part No.	102037	Ref. No.	162152
description thermocouple M8x1 L 1200mm plug connection \varnothing 6.0(6.5)mm				



threaded thermocouples

threaded thermocouples standard

with socket with thread M8x1

SIT

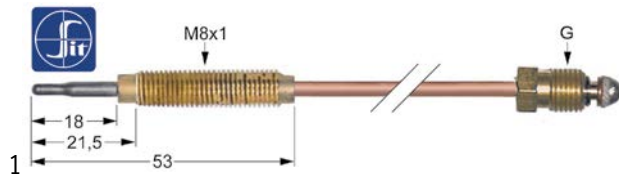

Part No.	107628	Ref. No.	151900
-----------------	--------	-----------------	--------

description thermocouple SIT M8x1 L 320mm M8x1

accessories for 107628



Part No.	102067	Ref. No.	—
-----------------	--------	-----------------	---

nut thread M8x1 H 3mm brass Qty 1 pcs type SEF 1

type Junkers with aluminised tip

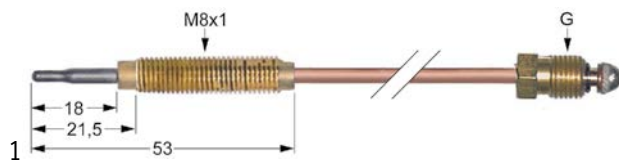

Part No.	102057	Ref. No.	151901
-----------------	--------	-----------------	--------

description thermocouple M8x1 L 850mm M8x1

accessories for 102057



Part No.	102067	Ref. No.	—
-----------------	--------	-----------------	---

nut thread M8x1 H 3mm brass Qty 1 pcs type SEF 1

accessories

interrupters



Part No.	101258	Ref. No.	164833
-----------------	--------	-----------------	--------

description interrupter thread M10x1

For models: NPG600, NPG900



Part No.	101264	Ref. No.	164815
-----------------	--------	-----------------	--------

description interrupter thread M8x1

For models: EGB230, EGB430, EGF124, EGF224, EGH417, EGH617, FGH417, FGH507, FGH617, FGW250, PGB438, PGF148, PGF228, PGW458



1

Part No.	101265	Ref. No.	183235
-----------------	--------	-----------------	--------

description interrupter thread M9x1

For models: CBG110, CBG120, CGD110, CGD120, NGR150, NGR250, NGR300, NGR400, NGS040, NGS060, NGS080, NGS100, NGS150

gas nozzles

pilot burner nozzles

pilot burner nozzles SIT

160 series



1

Part No.	107174	Ref. No.	540729
-----------------	--------	-----------------	--------

description pilot burner nozzle SIT natural gas code 41 Qty 1 pcs

screw connections

olives



1

Part No.	101278	Ref. No.	114101
-----------------	--------	-----------------	--------

description olive for pipe ø 10mm Qty 1 pcs

For models: EGB230, EGB430, EGF124, EGF224, EGH210, EGH410, EGH413, EGH417, EGH610, EGH613, EGH617, EGP500, FGH210, FGH410, FGH413, FGH415, FGH417, FGH610, FGH613, FGH615, FGH617, KGD131, KGE066, KGE081, KGE131, LGB430, LGF124, LGF224, LGG420, NGB430, NGF144, NGF224, NGG420, NGH200, NGH202, NGH400, NGH403, NGH405, NGH407, NGH507, NGH600, NGH603, NGH605, NGH607, NGH720, NGH723, NGH725, NGH727, NGH730, NGH733... (Other models you can see in the webshop)

accessories for 101278



Part No.	100943	Ref. No.	—
-----------------	--------	-----------------	---

union nut thread M17x1 tube ø 10mm



Part No.	101300	Ref. No.	—
-----------------	--------	-----------------	---

union nut thread M16x1.5 tube ø 10mm



Part No.	101478	Ref. No.	—
-----------------	--------	-----------------	---

union nut thread 3/8" for pipe ø 10mm



union screws



1

Part No.	100904	Ref. No.	178462
description	locking screw M10x1 for pipe ø 4mm Qty 1 pcs		

knobs

producer-specific knobs

KÜPPERSBUSCH



1

Part No.	110189	Ref. No.	100136 189005 189009
description	knob without symbol ø 62mm shaft ø 6x4.6mm shaft flat upper black		

For models:	CBE106, CBE106-VAR091, CBE110, CBE110-VAR091, CBE120, CBE120-VAR091, CBE220, CBE220-VAR091, CBG110, CBG120, CEC106, CEC110, CEC120, CEC220, CED106, CED110, CED120, CED220, CGD110, CGD120, EAB051, ECD106, ECD110, ECD120, ECD220, ECL484, EDC106, EEB230, EEB430, EEF040, EEF124, EEF224, EEH210, EEH300, EEH410, EEH413, EEH500, EEH503, EEH610, EEH613, EEH700, EEH703, EEP500, EES060, EES080, EEW250, EEW400, EEW450, EEW452, EGB230...(Other models you can see in the webshop)		
--------------------	--	--	--

spare parts for	110189		
	Part No.	111776	Ref. No.
	knob spring L 13.2mm W 7.4mm thickness 0.4mm Qty 10 pcs		



1

Part No.	110547	Ref. No.	141110
description	knob dial plate red gas thermostat EGA 1-8 t.max.°C ED ø 59mm ID ø 45.5mm		
For models:	EGH417, EGH617, LGH407, LGH607, NGH407, NGH417, NGH507, NGH607, NGH617, NGH727, NGH737		

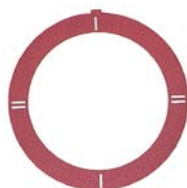

1

Part No.	110548	Ref. No.	141108
description	knob dial plate red switch 1-2-1-2 t.max.°C ED ø 59mm ID ø 45.5mm		
For models:	FEH415, FEH505, FEH515, FEH615, FEH705, FEH715, FGH415, FGH615, LEH405, LEH505, LEH605, LEH705, LGH405, LGH605, NEH415, NEH505, NEH615, NEH705, NGH405, NGH415, NGH505, NGH605, NGH615, NGH725		



1

Part No.	110533	Ref. No.	144766
description	knob dial plate red thermostat t.max. 100°C 0-100°C rotation 270° ED ø 59mm ID ø 45.5mm		
For models:	CED106, CED110, CED120, CED220		

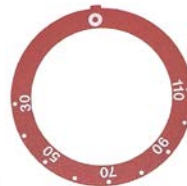

1

Part No.	110546	Ref. No.	141109
description	knob dial plate red thermostat t.max. 110°C 30-110°C rotation 270° ED ø 59mm ID ø 45.5mm		
For models:	FEH613, FEH615, FEH705, FEH715, FEW252, FGH613, FGH615, LEH605, LEH703, LEH705, LEW452, LGH605, LGH607, NEA182, NEH212, NEH613, NEH615, NEH705, NEW182, NEW252, NEW452, NGH202, NGH603, NGH605, NGH607, NGH613, NGH615, NGH617, NGH723, NGH725, NGH727, NGH733, NGH737		



1

Part No.	110532	Ref. No.	144767
description	knob dial plate red thermostat t.max. 300°C 0-300°C rotation 270° ED ø 59mm ID ø 45.5mm		
For models:	CED106, CED110, CED120, CED220		



1

Part No.	110549	Ref. No.	141106
description	knob dial plate red thermostat t.max. 300°C 50-300°C rotation 270° ED ø 59mm ID ø 45.5mm		
For models:	EEH413, EEH503, EEH613, EEH703, EGH413, EGH613, FEH413, FEH415, FEH503, FEH505, FEH513, FEH515, FEH613, FEH615, FEH705, FEH715, FGH413, FGH415, FGH613, FGH615, LEH405, LEH503, LEH505, LEH605, LEH703, LEH705, LGH405, LGH605, NEH413, NEH415, NEH505, NEH613, NEH615, NEH705, NGH403, NGH405, NGH413, NGH415, NGH503, NGH505, NGH603, NGH605, NGH613, NGH615, NGH723, NGH725, NGH730, NGH733		

1

Part No.	110558	Ref. No.	100329 141096
description	knob dial plate silver gas tap PEL21/22/23 t.max. °C ED ø 59mm ID ø 45.5mm PEL		



1

Part No.	110550	Ref. No.	141104
description	knob dial plate silver gas tap with ignition flame EGA26440 t.max. °C ED ø 59mm ID ø 45.5mm		
For models:	EGH210, EGH410, EGH413, EGH417, EGH610, EGH613, EGH617, LGB430, LGG420, NGB430, NGG420, NGH200, NGH202, NGH210, NGH400, NGH403, NGH405, NGH407, NGH410, NGH413, NGH415, NGH417, NGH600, NGH603, NGH605, NGH607, NGH610, NGH613, NGH615, NGH617, NGH720, NGH723, NGH725, NGH727, NGH737, PGH218, PGH418, PGH618		



1

Part No.	110543	Ref. No.	141099 141124
description	knob dial plate silver gas thermostat EGA 1-8 t.max. °C ED ø 59mm ID ø 45.5mm		
For models:	EGB230, EGB430, EGF124, EGF224, LGF124, LGF224, NGF224		



1

Part No.	110553	Ref. No.	141070
description	knob dial plate silver switch 4-position t.max. °C ED ø 59mm ID ø 45.5mm		
For models:	FEH210, FEH410, FEH413, FEH415, FEH610, FEH613, FEH615, NEH210, NEH212, NEH410, NEH413, NEH415, NEH610, NEH613, NEH615, NEP060, PEH218, PEH418, PEH618		



1

Part No.	110552	Ref. No.	141061 141069
description	knob dial plate silver switch 7-position t.max. °C ED ø 59mm ID ø 45.5mm		
For models:	EHO101, EHO111, FEH210, FEH410, FEH413, FEH415, FEH610, FEH613, FEH615, LEH405, LEH605, NEH210, NEH212, NEH410, NEH413, NEH415, NEH610, NEH613, NEH615, PEH218, PEH418, PEH618, SEH200		



1

Part No.	110545	Ref. No.	141091
description	knob dial plate silver thermostat t.max. 110°C 30-110°C rotation 310° ED ø 59mm ID ø 45.5mm		
For models:	FEW250, FEW252, LEW450, LEW452, NEA182, NEW180, NEW182, NEW250, NEW252, NEW450, NEW452, PEW458, PEW658, SEW250, SEW400, SEW450, TEW250, TEW400, TEW450		



1

Part No.	110536	Ref. No.	141092
description	knob dial plate silver thermostat t.max. 195°C 100-195°C rotation 270° ED ø 59mm ID ø 45.5mm		
For models:	LEF124, LEF224, NEF124, NEF144, NEF176, NEF224, NEF244, SEF124, SEF144, SEF224, TEF124, TEF144, TEF224		



1

Part No.	110530	Ref. No.	141077 144707
description	knob dial plate silver thermostat t.max. 300°C 60-300°C rotation 270° ED ø 59mm ID ø 45.5mm		
For models:	ECD106, ECD110, ECD120, ECD220, EEB230, EEB430, EEP500, EGP500, FEB430, FEB630, FEP600, FEP900, LEB430, LEG420, LEP400, NEB430, NEB630, NEG420, NEP060, NEP203, NEP303, NEP400, NEP600, NEP900, PEB438, PEB638, PEP608, PEP908, PGP608, PGP908, SEB230, SEB430, SEB630, SEG220, SEG420, SEG620		





locks

turning lever locks

universal

RAHRBACH





Part No.	700098	Ref. No.	407376
description	door catch mounting pos. right off-set 38mm L 110mm H 74mm W 33mm mounting distance 68/68mm series 1750		
For models:	ECD120, ECD220		
spare parts for	700098		
	Part No.	690136	Ref. No. 407377 707377
description	sliding plate mounting pos. right L 28mm H 3mm W 21mm H2 12.5mm		
accessories for	700098		
	Part No.	514281	Ref. No. —
description	base plate L 110mm W 35mm for door catch thickness 10mm		



Part No.	690136	Ref. No.	407377 707377
description	sliding plate mounting pos. right L 28mm H 3mm W 21mm H2 12.5mm		
For models:	ECD120, ECD220		

STUV



Part No.	700098	Ref. No.	407376
description	door catch mounting pos. right off-set 38mm L 110mm H 74mm W 33mm mounting distance 68/68mm series 1750		
For models:	ECD120, ECD220		
spare parts for	700098		
	Part No.	690136	Ref. No. 407377 707377
description	sliding plate mounting pos. right L 28mm H 3mm W 21mm H2 12.5mm		
accessories for	700098		
	Part No.	514281	Ref. No. —
description	base plate L 110mm W 35mm for door catch thickness 10mm		





edgmount latches

push button latches

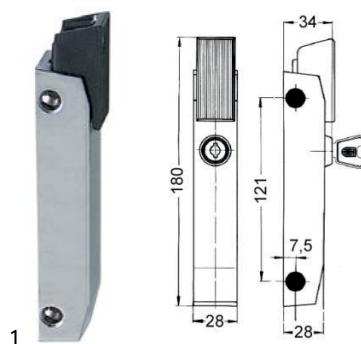
RAHRBACH

6186 PRESTO series





Part No.	700045	Ref. No.	356468
description	push button latch L 180mm mounting distance 121mm non lockable refrigeration units 6186 H 34mm W 28mm type PRESTO		
For models:	EDC106		
spare parts for	700045		
	Part No.	700046	Ref. No. —
description	handle H 26.5mm L 55mm W 23.5mm plastic with spring spring length 14mm mounting thread M4 spring thickness 0.5mm		
accessories for	700045		
	Part No.	690108	Ref. No. —
description	base plate H 5mm L 47.5mm W 21mm for swinging strike hole distance 31mm type PRESTO no. 6186		
	Part No.	690109	Ref. No. —
description	base plate H 1mm L 47.5mm W 21mm plastic hole distance 31mm type PRESTO no. 6186		
	Part No.	700050	Ref. No. 162357
description	door catch H 5mm L 47mm W 21mm hole distance 31mm with spigot refrigeration units type PRESTO no. 6186		
	Part No.	700051	Ref. No. 162357
description	door catch H 5mm L 48mm W 21mm adjustable hole distance 31mm with spigot type PRESTO no. 6186		

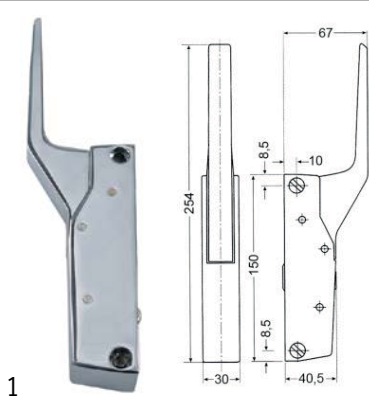

handle latches

CAFF/FERMOD



Part No.	700060	Ref. No.	133199
description	handle latch L 150mm mounting distance 133mm non lockable heated units G 791		
For models:	CBE106, CBE106-VAR091, CBE110, CBE110-VAR091, CBG110, CCE106, CCE110, CEC106, CEC110, CED106, CED110, CEF106, CEF110, CEM110, CGD110, CPE106, CPE110		
accessories for	700060		
	Part No.	700061	Ref. No. 133200
	door catch L 58mm W 20mm H 35mm mounting distance 42mm chrome-plated brass for headed units		
	Part No.	700062	Ref. No. —
	handle protection heated units		

producer-specific

KÜPPERSBUSCH



Part No.	694474	Ref. No.	133030
description	catch L 174mm mounting distance 124/133mm non lockable 6200 black W 32mm total length 250mm		

STUV

3.30.016x.x series

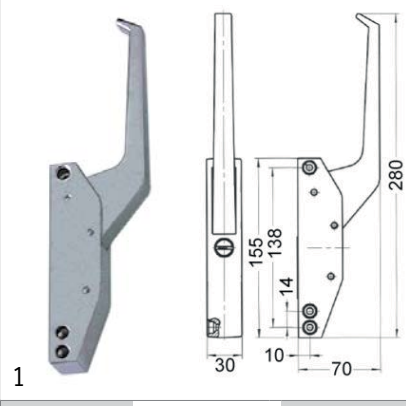

Part No.	700063	Ref. No.	407282
description	handle latch L 155mm mounting distance 124/138mm non lockable refrigeration units 3.30.0164		
For models:	ECD106, ECD110		
accessories for	700063		
	Part No.	700064	Ref. No. 407364
	door catch H 40mm L 28mm W 22mm		

door catches





Part No.	700064	Ref. No.	407364
description	door catch H 40mm L 28mm W 22mm		
For models:	ECD106, ECD110		



Part No.	690123	Ref. No.	133032
description	door catch H 69mm D 37mm W 20mm mounting distance 43mm with roller		

mechanical components, equipment accessories



			
1			
Part No.	700061	Ref. No.	133200
description	door catch L 58mm W 20mm H 35mm mounting distance 42mm chrome-plated brass for headed units		
For models:	CBE106, CBE106-VAR091, CBE110, CBE110-VAR091, CBG110, CCE106, CCE110, CEC106, CEC110, CED106, CED110, CEF106, CEF110, CEM110, CGD110, CPE106, CPE110		
accessories for	700061		
		Part No. 690414 Ref. No. —	
	handle latch L 150mm mounting distance 133mm non lockable refrigeration units G 791		

walk-in fridge catches

STUV

3.31.015x.x series

			
1			
Part No.	700072	Ref. No.	407380
description	door catch H 17mm L 84mm W 53mm mounting distance 68mm zinc die cast with wedge heated units		
For models:	ECD120, ECD220		

snap locks

producer-specific

KÜPPERSBUSCH

			
1			
Part No.	700072	Ref. No.	407380
description	door catch H 17mm L 84mm W 53mm mounting distance 68mm zinc die cast with wedge heated units		
For models:	ECD120, ECD220		

			
1			
Part No.	690101	Ref. No.	407379
description	snap lock L 85mm W 40mm mounting distance 68mm heated units H 63mm type 1750 series		
For models:	ECD120, ECD220		

espagnolette locks

universal

			
1			
Part No.	690041	Ref. No.	133195
description	cam L 148mm mounting distance 32mm		
For models:	CBE120, CBE120-VAR091, CBE220, CBE220-VAR091, CBG120, CCE120, CCE220, CEC120, CEC220, CED120, CED220, CEF120, CEF220, CEM120, CGD120, CPE120, CPE220		

			
1			
Part No.	690040	Ref. No.	133196
description	door catch with roller H 42mm L 40mm W 40mm zinc die cast mounting distance 26mm type 0751 series		
For models:	CBE120, CBE120-VAR091, CBE220, CBE220-VAR091, CBG120, CCE120, CCE220, CEC120, CEC220, CED120, CED220, CEF120, CEF220, CEM120, CGD120, CPE120, CPE220		

producer-specific

KÜPPERSBUSCH

			
1			
Part No.	693527	Ref. No.	756156000
description	bar for door lock L 441mm ø 10mm		
For models:	CBE120, CBE120-VAR091, CBE220, CBE220-VAR091, CBG120, CCE120, CCE220, CEC120, CEC220, CED120, CED220, CEF120, CEF220, CEM120, CGD120, CPE120, CPE220		

			
1			
Part No.	690041	Ref. No.	133195
description	cam L 148mm mounting distance 32mm		
For models:	CBE120, CBE120-VAR091, CBE220, CBE220-VAR091, CBG120, CCE120, CCE220, CEC120, CEC220, CED120, CED220, CEF120, CEF220, CEM120, CGD120, CPE120, CPE220		

			
1			
Part No.	690040	Ref. No.	133196
description	door catch with roller H 42mm L 40mm W 40mm zinc die cast mounting distance 26mm type 0751 series		
For models:	CBE120, CBE120-VAR091, CBE220, CBE220-VAR091, CBG120, CCE120, CCE220, CEC120, CEC220, CED120, CED220, CEF120, CEF220, CEM120, CGD120, CPE120, CPE220		



1

Part No.	693516	Ref. No.	133193
description	door handle metal		
For models:	CBE120, CBE120-VAR091, CBE220, CBE220-VAR091, CBG120, CCE120, CCE220, CEC120, CEC220, CED120, CED220, CEF120, CEF220, CEM120, CGD120, CPE120, CPE220		



1

Part No.	690042	Ref. No.	133194
description	latch gear opening to the right shaft intake \varnothing 8x8mm L 170mm W 40mm H 40mm		
For models:	CBE120, CBE120-VAR091, CBE220, CBE220-VAR091, CBG120, CCE120, CCE220, CEC120, CEC220, CED120, CED220, CEF120, CEF220, CEM120, CGD120, CPE120, CPE220		
accessories for	690042		
	Part No.	690040	Ref. No. 133196
	door catch with roller H 42mm L 40mm W 40mm zinc die cast mounting distance 26mm type 0751 series		
	Part No.	690041	Ref. No. 133195
	cam L 148mm mounting distance 32mm		
	Part No.	691050	Ref. No. —
	bar \varnothing 10mm for door latch L 113.5mm		



1

Part No.	692013	Ref. No.	156938
description	roll pin \varnothing 3mm L 16mm		
For models:	CBE120, CBE120-VAR091, CBE220, CBE220-VAR091, CBG120, CCE120, CCE220, CEC120, CEC220, CED120, CED220, CEF120, CEF220, CEM120, CGD120, CPE120, CPE220, NGP600, NGP900		

hinges

oven hinges

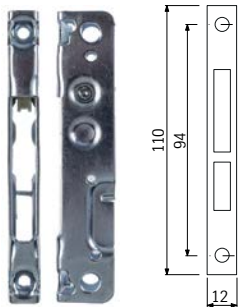

1

Part No.	693045	Ref. No.	131603 131604 131612 131618 133715 133777
description	opposite support L 110mm W 12mm mounting distance 94mm		
For models:	ECL484		

door bearing



1

Part No.	693510	Ref. No.	146757 146795 756627000
description	bolt mounting pos. upper/lower for door hinge		
For models:	CBE106, CBE106-VAR091, CBE110, CBE110-VAR091, CBE120, CBE120-VAR091, CBE220, CBE220-VAR091, CBG110, CBG120, CCE106, CCE110, CCE120, CCE220, CEC106, CEC110, CEC120, CEC220, CED106, CED110, CED120, CED220, CEF106, CEF110, CEF120, CEF220, CEM110, CEM120, CGD110, CGD120, CPE106, CPE110, CPE120, CPE220		



1

Part No.	693514	Ref. No.	133545 133548
description	bush for hinge		
For models:	CBE106, CBE106-VAR091, CBE110, CBE110-VAR091, CBE120, CBE120-VAR091, CBE220, CBE220-VAR091, CBG110, CBG120, CCE106, CCE110, CCE120, CCE220, CEC106, CEC110, CEC120, CEC220, CED106, CED110, CED120, CED220, CEF106, CEF110, CEF120, CEF220, CEM110, CEM120, CGD110, CGD120, CPE106, CPE110, CPE120, CPE220		

accessories

miscellaneous



1

Part No.	693513	Ref. No.	134382
description	door bumper		
For models:	CBE106, CBE106-VAR091, CBE110, CBE110-VAR091, CBE120, CBE120-VAR091, CBE220, CBE220-VAR091, CBG110, CBG120, CCE106, CCE110, CCE120, CCE220, CEC106, CEC110, CEC120, CEC220, CED106, CED110, CED120, CED220, CEF106, CEF110, CEF120, CEF220, CEM110, CEM120, CGD110, CGD120, CPE106, CPE110, CPE120, CPE220		



pullouts

rollers

rollers

accessories



1

Part No.	560133	Ref. No.	154896
description	hexagonal nut thread M6 H 5mm WS 10 SS DIN/ISO DIN 934 / ISO 4032/8673 Qty 20 pcs		
For models:	CEC106, CEC110, CEC120, CEC220, CGD110, CGD120, ECD106, ECD110, ECD120, ECD220, EEF040, EEF124, EEF224, EEW250, EEW400, EEW450, EEW452, FEF180, PEF188		

DERBY RUOTE

spare parts and accessories

miscellaneous



1

Part No.	560192	Ref. No.	407551
description	tooth lock washer ID ø 10.4mm ED ø 18mm SS DIN/ISO DIN 6798A Qty 1 pcs for thread M10		
For models:	ECD106, ECD110, ECD120, ECD220		

gaskets

gaskets for heated units

window seals

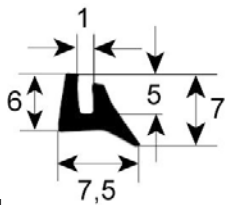

1

Part No.	900056	Ref. No.	062292 407363
description	window gasket profile 1570 Qty supplied by meter		
For models:	ECD106, ECD110, ECD120, ECD220		

door seals

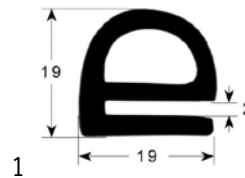

1

Part No.	900054	Ref. No.	062329 407518
description	door seal profile 2210 Qty supplied by meter temp.-resist. -40 up to +250°C		
For models:	CBE106, CBE106-VAR091, CBE110, CBE110-VAR091, CBE120, CBE120-VAR091, CBE220, CBE220-VAR091, CBG110, CBG120, CCE106, CCE110, CCE120, CCE220, CEC106, CEC110, CEC120, CEC220, CED106, CED110, CED120, CED220, CEF106, CEF110, CEF120, CEF220, CEM110, CEM120, CGD110, CGD120, CPE106, CPE110, CPE120, CPE220		

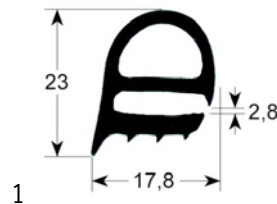

1

Part No.	900052	Ref. No.	407459
description	door seal profile 2230 W 470mm L 485mm external size Qty 1		

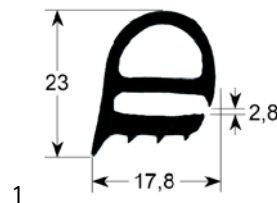

1

Part No.	900053	Ref. No.	407476
description	door seal profile 2230 W 480mm L 725mm external size Qty 1		
For models:	ECD110		

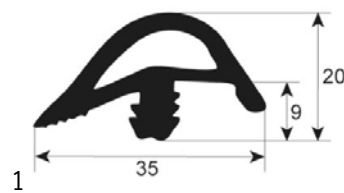

1

Part No.	900349	Ref. No.	060664
description	door seal profile 2790 W 495mm L 530mm external size Qty 1 insertion size 455x487mm		

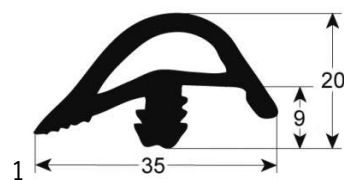

1

Part No.	900346	Ref. No.	060644 060665
description	door seal profile 2790 W 530mm L 730mm external size Qty 1 insertion size 505x705mm		



gaskets for tray rack trolleys

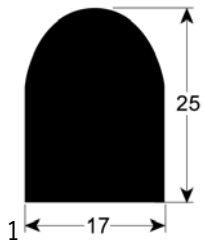

Part No.	900055	Ref. No.	062293 062392 407392 407636
description	tray rack trolley gasket profile 4020 Qty supplied by meter silicone foam		
For models:	CBE120, CBE120-VAR091, CBE220, CBE220-VAR091, CBG120, CCE120, CCE220, CEC120, CEC220, CED120, CED220, CEF120, CEF220, CEM120, CGD120, CPE120, CPE220, ECD120, ECD220		

O-rings

EPDM

ø5.34mm



Part No.	510408	Ref. No.	060842
description	O-ring EPDM thickness 5.34mm ID ø 47mm Qty 1 pcs		
For models:	CBE120-VAR091, CBE220-VAR091, CCE120, CCE220, CED120, CED220, CEF120, CEF220, CEM120, CPE120, CPE220, FED080, FED150, FED250, FED300, FEK040, FEK060, FEK080, FEK100, FEK150, FER080, FER150, FER250, FER300, FER400, FES040, FES060, FES080, FES100, FES150, NER080, NER150, NER250, NER300, NER400, NES040, NES060, NES080, NES100, NES150, PEK048, PEK068, PEK088, PEK108, PEK158, PER088, PER158, PER258, PER308, PES048...(Other models you can see in the webshop)		

sealing washers

copper gaskets

DIN-7603-C



Part No.	510420	Ref. No.	407297
description	gasket copper ED ø 19.9mm ID ø 14.3mm thickness 2mm Qty 1 pcs		
For models:	ECD106, ECD110, ECD120, ECD220		

silicone gaskets



Part No.	359721	Ref. No.	407286
description	gasket silicone ED ø 48mm ID ø 39.5mm thickness 5mm Qty 1 pcs		
For models:	ECD106, ECD110, ECD120, ECD220		

sealing cords

round







Part No.	510572	Ref. No.	407293
description	sealing cord ø 10mm greased L 0.2m Qty 1		
For models:	ECD106, ECD110, ECD120, ECD220		

hose reels and spray guns

cleaning guns



Part No.	540553 ¹	Ref. No.	172855
description	cleaning spray gun connection coupling DN13 brass controllable		
For models:	CCE106, CCE110, CCE120, CCE220, CED106, CED110, CED120, CED220, CEF106, CEF110, CEF120, CEF220, CEM110, CEM120, CGD110, CGD120, CPE106, CPE110, CPE120, CPE220		

accessories for	540553		
	Part No.	540485	Ref. No. —
	description	coupling bush type DN13 chrome-plated brass connection 1/2" (ø13mm)	
	Part No.	540516	Ref. No. —
	description	coupling bush type DN13 chrome-plated brass connection 1/2" IT	
	Part No.	540640	Ref. No. —
	description	coupling bush type DN13 chrome-plated brass connection 3/4" IT	
	Part No.	540641	Ref. No. —
	description	coupling bush type DN13 chrome-plated brass connection 1/2" ET	
	Part No.	540642	Ref. No. —
	description	coupling bush type DN13 chrome-plated brass connection 3/4" ET	
	Part No.	540643	Ref. No. —
	description	coupling bush type DN13 chrome-plated brass connection 3/4" (ø19mm)	

¹controllable



hoses

supply hoses

stainless steel flexi hoses

universal hoses

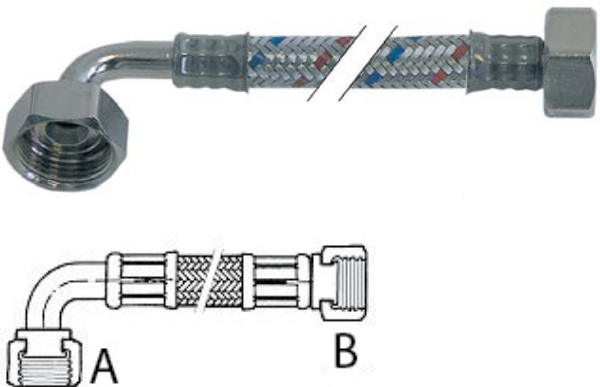

1

Part No.	520006	Ref. No.	071267
description	flex hose SS braid straight-curved DN10 connection 1: 3/4" connection 2: 3/4" L 2500mm approval DVGW operating p. 10bar test pressure 32bar burst p. 95bar		

PVC supply hoses



1

Part No.	520017	Ref. No.	20670300
description	supply hose ID ø 13mm ED ø 20mm L 5m operating p. 20bar burst p. 60bar t.max. 95°C grey Qty 5m		

industrial hoses

rubber hoses - Goldschlange®



1

Part No.	530540	Ref. No.	407411-425
description	pressure hose ID ø 13mm ED ø 21mm L 5m operating p. 30bar burst p. 90bar t.max. 100°C Qty 5m		

silicone hoses

without fabric



1

Part No.	530531	Ref. No.	061002
description	silicone hose ID ø 50mm ED ø 56mm L 1m thickness 3mm t.max. 200°C		

formed hoses

straight



1

Part No.	530531	Ref. No.	061002
description	silicone hose ID ø 50mm ED ø 56mm L 1m thickness 3mm t.max. 200°C		

valves and tank inlets

ball valves

ball valves electric



1

Part No.	401190	Ref. No.	120110 151006 164011 994595006 994898006 994899006
description	ball valve inlet 3/4" IT outlet 3/4" IT IP42 230V L 68mm 50/60Hz closed off-current mode of operation electric connection cable 300mm 3.5W duty cycle 50%		
For models:	CBE106-VAR091, CBE110-VAR091, CBE120-VAR091, CBE220-VAR091, CCE106, CCE110, CCE120, CCE220, CED106, CED110, CED120, CED220, CEF106, CEF110, CEF120, CEF220, CEM110, CEM120, CPE106, CPE110, CPE120, CPE220		



connection fittings

screw pipe fittings

	
1	
Part No.	543275
Ref. No.	166558
description	screw-in nipple thread 3/8" tube ø 10mm chrome-plated brass
For models:	CBE106-VAR091, CBE110-VAR091, CBE120-VAR091, CBE220-VAR091, CCE106, CCE110, CCE120, CCE220, CEC106, CEC110, CEC120, CEC220, CED106, CED110, CED120, CED220, CEF106, CEF110, CEF120, CEF220, CEM110, CEM120, CGD110, CGD120, CPE106, CPE110, CPE120, CPE220, FED080, FED150, FED250, FED300, FGR150, FGR250, FGR300, FGR400, NGR150, NGR250, NGR300, NGR400, PED088, PED158, PED258, PED308

ancillary products

clamps

hose clamps

DIN 3017 - W2

	
1	
Part No.	520112
Ref. No.	407427-437
description	hose clamp ø 12-20mm width 9mm Qty 10 pcs DIN 3017

	
1	
Part No.	520114
Ref. No.	407357
description	hose clamp ø 20-32mm width 9mm Qty 10 pcs DIN 3017
For models:	ECD106, ECD110, ECD120, ECD220

	
1	
Part No.	520115
Ref. No.	407571
description	hose clamp ø 25-40mm width 9mm Qty 10 pcs DIN 3017
For models:	ECD106, ECD110, ECD120, ECD220

	
1	
Part No.	520118
Ref. No.	260261
description	hose clamp ø 50-70mm width 9mm Qty 5 pcs DIN 3017
For models:	CED220, KGD020, KGD021, KGD030, KGD040, KGE021, KGE051, KGE052, KGE065, KGH020, KGH030, KGH040, KGS020, KGS021, KGS030, KGU020, KGU021, KGU030

	
1	
Part No.	520117
Ref. No.	260259 407307
description	hose clamp stainless steel ø 40-60mm width 9mm Qty 5 pcs DIN 3017
For models:	ECD106, ECD110, ECD120, ECD220

fastening material

screws

hexagonal screws

	
1	
Part No.	560309
Ref. No.	356961
description	hexagonal screw thread M10 thread L 16mm SS WS 17 Qty 1 pcs DIN 933 / ISO 4017
For models:	CEC106, CED106, ECD106, ECD110, ECD120, ECD220

	
1	
Part No.	560308
Ref. No.	151184
description	hexagonal screw thread M16 thread L 20mm SS WS 24 Qty 1 pcs DIN 933 / ISO 4017
For models:	CBE106, CBE106-VAR091, CBE110, CBE110-VAR091, CBE120, CBE120-VAR091, CBE220, CBE220-VAR091, CBG110, CBG120, CCE106, CCE110, CCE120, CCE220, CED106, CED110, CED120, CED220, CEF106, CEF110, CEF120, CEF220, CEM110, CEM120, CPE106, CPE110, CPE120, CPE220



			
1			
Part No.	560084	Ref. No.	153475 153479
description	hexagonal screw thread M5 thread L 16mm SS WS 8 Qty 20 pcs DIN 933 / ISO 4017		
For models:	FEH210, FEH410, FEH413, FEH415, FEH610, FEH613, FEH615, LEP400, LES060, LGP400, LGS060, NEF176, NEH210, NEH212, NEH410, NEH413, NEH415, NEH610, NEH613, NEH615, NEP400, NEP600, NEP601, NEP900, NEP901, NGH200, NGH202, NGH400, NGH403, NGH405, NGH407, NGH600, NGH603, NGH605, NGH607, NGP400, NGP600, NGP900, SEB230, SEB430, SEB630, SEF124, SEF144, SEF224, SEF400, SEG220, SEG420, SEG620, SEH200, SER400...(Other models you can see in the webshop)		

nuts

hexagonal nuts

DIN 934 / ISO 4032/8673

			
1			
Part No.	560133	Ref. No.	154896
description	hexagonal nut thread M6 H 5mm WS 10 SS DIN/ISO DIN 934 / ISO 4032/8673 Qty 20 pcs		
For models:	CEC106, CEC110, CEC120, CEC220, CGD110, CGD120, ECD106, ECD110, ECD120, ECD220, EEF040, EEF124, EEF224, EEW250, EEW400, EEW450, EEW452, FEF180, PEF188		

hexagonal nuts metric (without norm)

			
1			
Part No.	520230	Ref. No.	407298
description	nut thread M14x1.5 H 5mm WS 19 zinc-coated steel Qty 1 pcs		
For models:	ECD106, ECD110, ECD120, ECD220		

washers

washers

DIN 125A

			
1			
Part No.	560312	Ref. No.	407550
description	plain washer ID ø 10.5mm ED ø 20mm thickness 2mm SS Qty 1 pcs DIN 125A for thread M10		
For models:	ECD106, ECD110, ECD120, ECD220		

DIN 9021

			
1			
Part No.	560117	Ref. No.	407575
description	plain washer ID ø 6.4mm ED ø 18mm thickness 1.5mm SS Qty 20 pcs DIN 9021 for thread M6		
For models:	ECD106, ECD110, ECD120, ECD220		

tooth lock washers

DIN 6798A

			
1			
Part No.	560192	Ref. No.	407551
description	tooth lock washer ID ø 10.4mm ED ø 18mm SS DIN/ISO DIN 6798A Qty 1 pcs for thread M10		
For models:	ECD106, ECD110, ECD120, ECD220		

miscellaneous

			
1			
Part No.	520228	Ref. No.	40156998
description	tooth lock washer ID ø 15.3mm ED ø 24mm steel Qty 1 pcs for thread M14		

fasteners

clamps

hose clamps

DIN 3017 - W2

			
1			
Part No.	520112	Ref. No.	407427-437
description	hose clamp ø 12-20mm width 9mm Qty 10 pcs DIN 3017		

			
1			
Part No.	520114	Ref. No.	407357
description	hose clamp ø 20-32mm width 9mm Qty 10 pcs DIN 3017		
For models:	ECD106, ECD110, ECD120, ECD220		



			
1			
Part No.	520115	Ref. No.	407571
description	hose clamp ø 25-40mm width 9mm Qty 10 pcs DIN 3017		
For models:	ECD106, ECD110, ECD120, ECD220		

			
1			
Part No.	520118	Ref. No.	260261
description	hose clamp ø 50-70mm width 9mm Qty 5 pcs DIN 3017		
For models:	CED220, KGD020, KGD021, KGD030, KGD040, KGE021, KGE051, KGE052, KGE065, KGH020, KGH030, KGH040, KGS020, KGS021, KGS030, KGU020, KGU021, KGU030		

			
1			
Part No.	520117	Ref. No.	260259 407307
description	hose clamp stainless steel ø 40-60mm width 9mm Qty 5 pcs DIN 3017		
For models:	ECD106, ECD110, ECD120, ECD220		

roll pins

			
1			
Part No.	692013	Ref. No.	156938
description	roll pin ø 3mm L 16mm		
For models:	CBE120, CBE120-VAR091, CBE220, CBE220-VAR091, CBG120, CCE120, CCE220, CEC120, CEC220, CED120, CED220, CEF120, CEF220, CEM120, CGD120, CPE120, CPE220, NGP600, NGP900		

consumables

fuses

fine fuses

			
1			
Part No.	358598	Ref. No.	407274
description	fine fuse size ø5x20mm 0.63A slow-acting rated 250V Qty 10 pcs		
For models:	ECD106, ECD110, ECD120, ECD220		

			
1			
Part No.	358608	Ref. No.	216327
description	fine fuse size ø5x20mm 10A slow-acting rated 250V Qty 10 pcs		
For models:	CEC106, CEC110, CEC120, CEC220, CED120, CED220		

			
1			
Part No.	358607	Ref. No.	407273
description	fine fuse size ø5x20mm 6.3A slow-acting rated 250V Qty 10 pcs		
For models:	ECD106, ECD110, ECD120, ECD220		

screw locks

D0-system (NEOZED)

			
1			
Part No.	358045	Ref. No.	407502
description	fuse size D02 35A rated 250/400V E18 ø 15mm L 36mm Qty 10 pcs		
For models:	ECD220		

			
1			
Part No.	358046	Ref. No.	407503
description	fuse size D02 50A rated 250/400V E18 ø 15mm L 36mm Qty 10 pcs		
For models:	ECD220		



gauge pieces (NEOZED)

			
1			
Part No.	358067	Ref. No.	407650
description	gauge piece size D02 suitable for 35A		
For models:	ECD220		

			
1			
Part No.	358068	Ref. No.	407649
description	gauge piece size D02 suitable for 50A		
For models:	ECD220		

GASTROPARTS.COM



© 2020 Gastroparts Sp. J. All rights reserved.