



**GASTROPARTS**

# Inoxtrend

**[EN]** Cooking

**[DE]** Kochtechnik

**[ES]** Cocción

**[FR]** Cuisson

**[IT]** Cottura

**[PL]** Obróbka termiczna

**[RU]** Термическая обработка

✉ [gastroparts@gastroparts.com](mailto:gastroparts@gastroparts.com)

☎ tel. +48 56 657 00 66

📘 [fb.com/gastroparts.global](https://fb.com/gastroparts.global)

**GASTROPARTS.COM**





## heating elements

## contact heaters



1

<b>Part No.</b>	419036	<b>Ref. No.</b>	C2063-00
<b>description</b>	contact heater 1100W 230V heating circuits 1 L 137mm W 120mm H 10mm for combi-steamer connection distance 44mm hole ø 7.5mm		



1

<b>Part No.</b>	418024	<b>Ref. No.</b>	C5451-00 RRC5451-00
<b>description</b>	hot plate 2200W 230V heating circuits 2 L 194mm H 27mm ø 170mm steam generator dry heating element		

## heating elements for convection



1

<b>Part No.</b>	418021	<b>Ref. No.</b>	C2431-00 C2538-00 RRC2431-00 RRC2538-00
<b>description</b>	heating element 11000W 230V heating circuits 3 ID ø 298mm ED ø 314mm L 355mm H 105mm L1 34mm W1 104mm H1 28mm H2 87mm flange length 142mm flange width 25mm hole distance 64mm connection M4 tube ø 8.5mm convection heating element hole ø 6mm rectangular flange		



1

<b>Part No.</b>	418023	<b>Ref. No.</b>	C7172-00 RRC7172-00
<b>description</b>	heating element 12000W 230V heating circuits 3 ID ø 408mm ED ø 425mm L 451mm H 134mm L1 18mm W1 105mm H1 46mm H2 88mm flange length 142mm flange width 25mm hole distance 63mm connection M4 tube ø 8.5mm convection heating element hole ø 6mm flange 142 x 25mm		



1

<b>Part No.</b>	418022	<b>Ref. No.</b>	C7170-00 RRC7170-00
<b>description</b>	heating element 14000W 230V heating circuits 3 ID ø 368mm ED ø 388mm L 420mm H 128mm L1 35mm W1 105mm H1 38mm H2 90mm flange length 142mm flange width 25mm hole distance 126mm connection M4 connection length 80mm tube ø 6.3mm dry heating element hole ø 6mm rectangular flange		

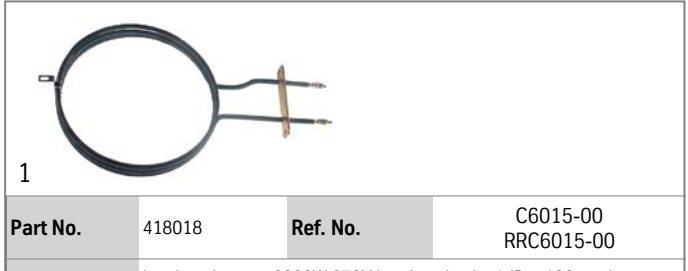

1

<b>Part No.</b>	418018	<b>Ref. No.</b>	C6015-00 RRC6015-00
<b>description</b>	heating element 2800W 230V heating circuits 1 ID ø 192mm L 290mm H 37mm L1 85mm W1 59mm flange length 100mm flange width 22mm hole distance 86mm ED ø 210mm connection M4 connection length 22mm tube ø 6.3mm convection heating element hole ø 5mm rectangular flange		

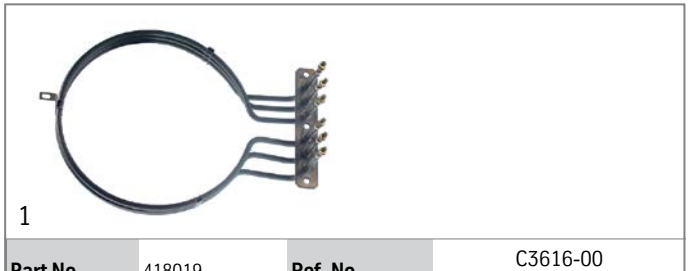

1

<b>Part No.</b>	418019	<b>Ref. No.</b>	C3616-00 RRC3616-00
<b>description</b>	heating element 3900W 230V heating circuits 3 ID ø 206mm ED ø 218mm L 275mm H 40mm L1 48mm W1 104mm H1 10mm H2 24mm flange length 142mm flange width 25mm hole distance 62.5mm connection M4 connection length 62mm tube ø 6mm convection heating element hole ø 6.5mm rectangular flange		
<b>For models:</b>	CS-5		



1

<b>Part No.</b>	418020	<b>Ref. No.</b>	C2036-00 C3090-00 LC-001 RRC2036-00 RRC3090-00
<b>description</b>	heating element 7800W 230V heating circuits 3 ID ø 264mm ED ø 277mm L 315mm H 100mm L1 35mm W1 101mm H1 29mm H2 67mm flange length 142mm flange width 23mm hole distance 63mm connection M4 connection length 75mm tube ø 6.3mm convection heating element mounting thread M4 rectangular flange		
<b>For models:</b>	CVE-10 +KTE		



1			
<b>Part No.</b>	418905	<b>Ref. No.</b>	C9013-00 LC-002 LC-002-22 RRC9013-00 RRLC-002
<b>description</b>	heating element 8000W 230V heating circuits 3 ID ø 302mm ED ø 319mm L 370mm H 60mm L1 54mm W1 104mm H1 22mm H2 38mm flange length 142mm flange width 25mm hole distance 63mm connection M4 connection length 58mm tube ø 8.5mm convection heating element		

## energy regulators

### EGO

#### 1-circuit

1			
<b>Part No.</b>	380015	<b>Ref. No.</b>	C2192-00 RRC2192-00
<b>description</b>	energy regulator 230V 13A single-circuit turn direction right shaft ø 6x4.6mm shaft L 23mm mounting thread M4 power release 6-100% no. 50.57021.010		

## thermostats

### bi-metal thermostats

#### bi-metal thermostats

1			
<b>Part No.</b>	375611	<b>Ref. No.</b>	C2065-00 RRC2065-00
<b>description</b>	bi-metal thermostat hole distance 34mm switch-off temp. 180°C 2NC 2-pole 16A connection F6.3 2 hole fixing		

### control and safety thermostats

#### EGO

#### control thermostats

#### 55.10/19\_ series

1			
<b>Part No.</b>	375608	<b>Ref. No.</b>	C2190-00 RRC2190-00
<b>description</b>	thermostat t.max. 265°C temperature range 50-265°C 1-pole 1NO 16A probe ø 3mm probe L 219mm capillary pipe 900mm capillary pipe isolated 800mm gland nut M9x1 shaft ø 6x4.6mm shaft L 23mm shaft position upper rotation 270°		

1			
<b>Part No.</b>	390815	<b>Ref. No.</b>	LC352
<b>description</b>	thermostat t.max. 273°C temperature range 57-273°C 1-pole 1NO 16A probe ø 3.1mm probe L 226mm capillary pipe 1470mm capillary pipe isolated 1250mm gland nut M9x1 shaft ø 6x4.6mm shaft L 23mm shaft position upper rotation 270°		

1			
<b>Part No.</b>	375231	<b>Ref. No.</b>	FX0187-00
<b>description</b>	thermostat t.max. 90°C temperature range 30-90°C 1-pole 1NO 16A probe ø 6mm probe L 130mm capillary pipe 900mm capillary pipe isolated 600mm gland nut M9x1 shaft L 18mm shaft position upper rotation 270°		



## 55.13\_ series



1

<b>Part No.</b>	375954	<b>Ref. No.</b>	C2218-00 RRC2218-00
<b>description</b>	thermostat t.max. 109°C 1-pole 1CO 16A probe ø 3.03mm probe L 198mm capillary pipe 900mm capillary pipe isolated 610mm gland nut M9x1 shaft ømm shaft Lmm shaft position° shaft position rotation°		

## safety thermostats

## 55.14\_ series



1

<b>Part No.</b>	375610	<b>Ref. No.</b>	C2198-00 RRC2198-00
<b>description</b>	safety thermostat switch-off temp. 340°C 1-pole 16A probe ø 3.03mm probe L 144mm capillary pipe 880mm capillary pipe isolated 750mm gland nut M9x1 probe		
<b>For models:</b>	CVE 10-R, MDP-6G		

## 55.32\_ series

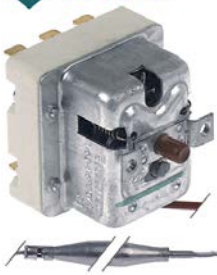

1

<b>Part No.</b>	375649	<b>Ref. No.</b>	LC-351 RRLC-351
<b>description</b>	safety thermostat switch-off temp. 160°C 3-pole 20A probe ø 6mm probe L 87mm capillary pipe 890mm capillary pipe isolated 880mm gland nut probe SS		

## CAEM

## control thermostats



1

<b>Part No.</b>	375609	<b>Ref. No.</b>	C2185-00 RRC2185-00
<b>description</b>	thermostat t.max. 90°C temperature range 30-90°C 1-pole 1CO 16A probe ø 6mm probe L 95mm capillary pipe 1600mm capillary pipe isolated 1550mm shaft ø ø6x4.6mm rotation 270°		
<b>For models:</b>	MDP-6G		

## switches and momentary switches

## rocker/momentary rocker switches

## 30x11mm



1

<b>Part No.</b>	301013	<b>Ref. No.</b>	C2206-00 RRC2206-00
<b>description</b>	rocker switch mounting measurements 30x11mm black 1CO 250V 16A connection male faston 6.3mm ambient temperature max. 85/125°C protection IP40		

## push/momentary push switches

## ø16mm



1

<b>Part No.</b>	346320	<b>Ref. No.</b>	C5420-00 RRC5420-00
<b>description</b>	momentary push switch mounting ø 16mm red 1NO/indicator light 250V 3A ignition connection male faston 6.3mm ambient temperature max. 85°C protection IP40		
<b>For models:</b>	MDP-6G		

## ø25mm



1

<b>Part No.</b>	346094	<b>Ref. No.</b>	AZ129-00 C8252-00 RRC8252-00
<b>description</b>	push switch mounting ø 25mm orange 2NO/indicator light 250V 16A with rubber collar connection male faston 6.3mm ambient temperature max. 85°C protection IP65		



microswitches

pin-plunger actuated

M10



<b>Part No.</b>	345032	<b>Ref. No.</b>	C2207-00 C6018-00 RRC2207-00 RRC6018-00
<b>description</b>	microswitch with plunger thread M10x1 thread L 12mm 250V 16A 1CO connection male faston 6.3mm stroke 7mm mounting distance 22mm L 28mm ambient temperature max. 125°C type SP9603 actuating force: 180g		
<b>For models:</b>	MDP-6G		

M12



<b>Part No.</b>	345360	<b>Ref. No.</b>	C2911-00 RRC2911-00
<b>description</b>	microswitch with plunger mounting distance 25.4mm thread M12x1 thread L 15mm 250V 10A 1CO connection screw stroke 5mm ambient temperature max. 125°C type Highly D5000 actuating force: 200g		

cam switches

on/off

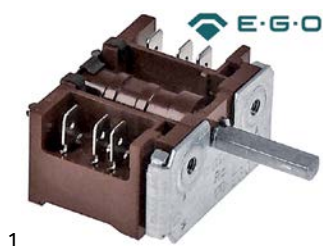

<b>Part No.</b>	301115	<b>Ref. No.</b>	FX0189-12
<b>description</b>	cam switch 2 operating positions 2NO sequence 0-1 16A shaft ø 6x4.6mm shaft L 23mm connection male faston 6.3mm		

4 operating positions



<b>Part No.</b>	300010	<b>Ref. No.</b>	C2214-00 RRC2214-00
<b>description</b>	cam switch 4 operating positions 2NO/2CO sequence 0-1-2-3 16A shaft ø 6x4.6mm shaft L 23mm connection male faston 6.3mm ceramic		

5 operating positions



<b>Part No.</b>	301297	<b>Ref. No.</b>	C8160-00 RRC8160-00
<b>description</b>	cam switch 5 operating positions 1-0-2-3-4 sequence 8NO 16A shaft ø 6x4.6mm shaft L 23mm connection male faston 6.3mm plastic		

rotary switches

TECNOMATIC



<b>Part No.</b>	346304	<b>Ref. No.</b>	C6074-00 RRC6074-00
<b>description</b>	rotary switch 2 0-1 momentary sets of contacts 1 type HD1201RR000 600V 12A shaft ø 6x6mm shaft L 23mm shaft round momentary connection male faston 6.3mm		



<b>Part No.</b>	347369	<b>Ref. No.</b>	C6070-12 RRC6070-12
<b>description</b>	rotary switch 3 0-1-2 sets of contacts 4 type HD16X148R000 600V 16A shaft ø 6mm shaft L 22mm shaft round connection male faston 6.3mm		



<b>Part No.</b>	346305	<b>Ref. No.</b>	C2241-00 RRC2241-00
<b>description</b>	rotary switch 3 1-0-1 sets of contacts 2 type HD1241ER000 600V 12A shaft ø 6x5mm shaft L 22mm shaft square connection screw		



<b>Part No.</b>	347610	<b>Ref. No.</b>	C5500-12
<b>description</b>	rotary switch 4 0-1-2-3 sets of contacts 6 type HD16X143AR000 600V 16A shaft ø 6mm shaft L 22mm shaft round connection male faston 6.3mm		



1

<b>Part No.</b>	347993	<b>Ref. No.</b>	C3652-12 RRC3652-12
<b>description</b>	rotary switch 5 0-1-2-3-4 sets of contacts 6 type HD12X167R000 600V 12A shaft $\varnothing$ 6x4.6mm shaft L 21mm connection male faston 6.3mm 5 operating positions		



1

<b>Part No.</b>	346307	<b>Ref. No.</b>	C5390-00 C5390-12 RRC5390-00
<b>description</b>	rotary switch 5 0-1-2-3-4 sets of contacts 8 type HD12X152R000 600V 12A shaft $\varnothing$ 6mm shaft L 22mm shaft round connection male faston 6.3mm		



1

<b>Part No.</b>	347598	<b>Ref. No.</b>	C6200-12
<b>description</b>	rotary switch 5 8 groups sets of contacts 8 type HD16X167AR000 600V 16A shaft $\varnothing$ 6mm shaft L 22mm shaft round connection male faston 6.3mm		



1

<b>Part No.</b>	346308	<b>Ref. No.</b>	C5395-00 C5395-01 C5395A-00 RRC5395-00
<b>description</b>	rotary switch 6 1-0-1-2-3-4 sets of contacts 16 type HD16X173R000 600V 16A shaft $\varnothing$ 6mm shaft L 21mm shaft square connection male faston 6.3mm		



1

<b>Part No.</b>	346102	<b>Ref. No.</b>	C8162-00 RRC8162-00
<b>description</b>	rotary switch 6 2-1-0-3-4-5 sets of contacts 10 type HD12X303R000 600V 12A shaft $\varnothing$ 6mm shaft L 22mm shaft round connection male faston 6.3mm		

## magnetic switches

37x16mm



1

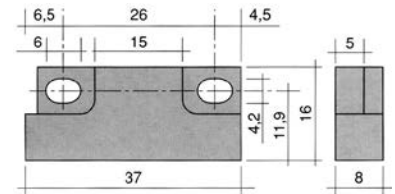

<b>Part No.</b>	345600	<b>Ref. No.</b>	C8310-00
<b>description</b>	magnetic switch L 37mm W 16mm 1NO 250V 0.2A P max. 50W connection cable cable length 960mm		
<b>accessories for</b>	345600		
	<b>Part No.</b>	519049	<b>Ref. No.</b> —
	magnet $\varnothing$ mm L 63mm H 10.7mm W 18.8mm hole distance 52mm M2 hole $\varnothing$ 2mm		

## lamps

## indicator lights

## indicator lights (complete)

 $\varnothing$  9mm

1

<b>Part No.</b>	359136	<b>Ref. No.</b>	C5410-00 RRC5410-00
<b>description</b>	indicator light $\varnothing$ 9mm 230V green connection male faston 6.3mm temp.-resist. 120°C		



1

<b>Part No.</b>	359137	<b>Ref. No.</b>	C5411-00 RRC5411-00
<b>description</b>	indicator light $\varnothing$ 9mm 230V yellow connection male faston 6.3mm temp.-resist. 120°C with lens		

 $\varnothing$  12mm

with screw socket



1

<b>Part No.</b>	359048	<b>Ref. No.</b>	C2189-00 RRC2189-00
<b>description</b>	indicator light $\varnothing$ 12mm 230V yellow connection male faston 6.3mm		







			
1			
<b>Part No.</b>	359027	<b>Ref. No.</b>	C2205-00 RRC2205-00
<b>description</b>	indicator light ø 12mm 250V green connection male faston 6.3mm		

## screw-on/push-on fit

## light bulbs

## for ovens

			
1			
<b>Part No.</b>	359610	<b>Ref. No.</b>	C6085-05 RRC6085-05
<b>description</b>	light bulb t.max. 300°C socket E14 15W 230V ø 22mm L 47mm lens L 20mm for oven lamp type Philips		

			
1			
<b>Part No.</b>	359612	<b>Ref. No.</b>	C2104-03 C6073E-00 RRC2104-03 RRC6073E-00
<b>description</b>	light bulb t.max. 300°C socket E14 25W 230V ø 25mm L 56mm lens L 30mm for oven lamp type Philips		

## halogen lamp

## for socket G4 / G6.35 / G9





			
1 <b>500°C</b>			
<b>Part No.</b>	359074	<b>Ref. No.</b>	C5252-00 RRC5252-00
<b>description</b>	halogen lamp socket G6.35 12V 35W temp.-resist. 500°C		

			
1			
<b>Part No.</b>	359946	<b>Ref. No.</b>	LC-051
<b>description</b>	halogen lamp socket G9 230V 40W temp.-resist. 300°C		





## oven lamps

## universal oven lamps



## mounting diameter 35.5mm

			
1			
<b>Part No.</b>	359701	<b>Ref. No.</b>	C6085-01 RRC6085-01
<b>description</b>	lamp socket socket E14 220-230V mounting ø 35.5mm connection male faston 6.3mm 15W		
<b>accessories for</b>	359701		
	<b>Part No.</b>	359705	<b>Ref. No.</b> —
	oven lamp glass thr.ø 33.5mm ø 52mm hard glas temp.-resist. 350°C		
	<b>Part No.</b>	359709	<b>Ref. No.</b> —
	oven lamp glass thr.ø 33.5mm ø 42mm hard glas temp.-resist. 350°C		
	<b>Part No.</b>	359721	<b>Ref. No.</b> —
	gasket silicone ED ø 48mm ID ø 39.5mm thickness 5mm Qty 1 pcs		
	<b>Part No.</b>	359942	<b>Ref. No.</b> —
	oven lamp glass thr.ø 33.5mm ø 41mm hard glas temp.-resist. 350°C		

## 55x70mm





			
1			
<b>Part No.</b>	357105	<b>Ref. No.</b>	LC-050
<b>description</b>	lamp socket socket G9 250V mounting measurements 55x70mm connection male faston 6.3mm H 32mm		
<b>accessories for</b>	357105		
	<b>Part No.</b>	359297	<b>Ref. No.</b> C6073D-00
	frame L 95mm W 81mm mounting distance 68/83mm thickness 6mm		
	<b>Part No.</b>	359299	<b>Ref. No.</b> C6073F-00 RRC6073F-00
	gasket L 91mm W 77mm hole ø 3mm for oven lamp		
	<b>Part No.</b>	359937	<b>Ref. No.</b> —
	lamp glass L 80mm W 65mm mounting measurements 52x67mm		
	<b>Part No.</b>	359945	<b>Ref. No.</b> —
	halogen lamp socket G9 230V 25W temp.-resist. 300°C		













			
1			
<b>Part No.</b>	359297	<b>Ref. No.</b>	C6073D-00
<b>description</b>	frame L 95mm W 81mm mounting distance 68/83mm thickness 6mm		
<b>accessories for</b>	359297		
	<b>Part No.</b>	359299	<b>Ref. No.</b> C6073F-00 RRC6073F-00
	gasket L 91mm W 77mm hole ø 3mm for oven lamp		

			
1			
<b>Part No.</b>	359299	<b>Ref. No.</b>	C6073F-00 RRC6073F-00
<b>description</b>	gasket L 91mm W 77mm hole ø 3mm for oven lamp		

			
1			
<b>Part No.</b>	359296	<b>Ref. No.</b>	C6073C-00 RRC6073C-00
<b>description</b>	lamp glass L 74mm W 58mm thickness 3mm		

			
1			
<b>Part No.</b>	357105	<b>Ref. No.</b>	LC-050
<b>description</b>	lamp socket socket G9 250V mounting measurements 55x70mm connection male faston 6.3mm H 32mm		
<b>accessories for</b>	357105		
	<b>Part No.</b>	359297	<b>Ref. No.</b> C6073D-00
	frame L 95mm W 81mm mounting distance 68/83mm thickness 6mm		
	<b>Part No.</b>	359299	<b>Ref. No.</b> C6073F-00 RRC6073F-00
	gasket L 91mm W 77mm hole ø 3mm for oven lamp		
	<b>Part No.</b>	359937	<b>Ref. No.</b> —
	lamp glass L 80mm W 65mm mounting measurements 52x67mm		
	<b>Part No.</b>	359945	<b>Ref. No.</b> —
	halogen lamp socket G9 230V 25W temp.-resist. 300°C		

55x100mm			
			
1			
<b>Part No.</b>	359698	<b>Ref. No.</b>	C2272-01 RRC2272-01
<b>description</b>	lamp socket L 100mm W 55mm socket E14 connection male faston 6.3mm		
<b>spare parts for</b>	359698		
	<b>Part No.</b>	358119	<b>Ref. No.</b> —
	frame L 118mm W 72mm mounting distance 143mm for bulb socket		
	<b>Part No.</b>	358122	<b>Ref. No.</b> —
	gasket L 112mm W 68mm silicone thickness 3mm for bulb socket		
	<b>Part No.</b>	358123	<b>Ref. No.</b> —
	lamp glass L 112mm W 68mm		
	<b>Part No.</b>	359612	<b>Ref. No.</b> C2104-03 C6073E-00 RRC2104-03 RRC6073E-00
	light bulb t.max. 300°C socket E14 25W 230V ø 25mm L 56mm lens L 30mm for oven lamp type Philips		
	<b>Part No.</b>	359714	<b>Ref. No.</b> C2104-32 RRC2104-32
	gasket silicone L 140mm W 75mm for bulb socket		
	<b>Part No.</b>	359715	<b>Ref. No.</b> C2104-22 RRC2104-22
	lamp glass L 110mm W 65mm thickness 5mm		
	<b>Part No.</b>	359716	<b>Ref. No.</b> C2104-12 RRC2104-12
	frame for bulb socket		
<b>accessories for</b>	359698		
	<b>Part No.</b>	359612	<b>Ref. No.</b> C2104-03 C6073E-00 RRC2104-03 RRC6073E-00
	light bulb t.max. 300°C socket E14 25W 230V ø 25mm L 56mm lens L 30mm for oven lamp type Philips		
	<b>Part No.</b>	359938	<b>Ref. No.</b> —
	borosilicate glass L 115mm W 69mm		

			
1			
<b>Part No.</b>	359716	<b>Ref. No.</b>	C2104-12 RRC2104-12
<b>description</b>	frame for bulb socket		





 <p>1</p>			
<b>Part No.</b>	359714	<b>Ref. No.</b>	C2104-32 RRC2104-32
<b>description</b>	gasket silicone L 140mm W 75mm for bulb socket		

 <p>1</p>			
<b>Part No.</b>	359715	<b>Ref. No.</b>	C2104-22 RRC2104-22
<b>description</b>	lamp glass L 110mm W 65mm thickness 5mm		

 <p>1</p>											
<b>Part No.</b>	359698	<b>Ref. No.</b>	C2272-01 RRC2272-01								
<b>description</b>	lamp socket L 100mm W 55mm socket E14 connection male faston 6.3mm										
<b>spare parts for</b>	359698										
 <table border="1"> <tr> <td><b>Part No.</b></td> <td>358119</td> <td><b>Ref. No.</b></td> <td>—</td> </tr> <tr> <td><b>description</b></td> <td colspan="3">frame L 118mm W 72mm mounting distance 143mm for bulb socket</td> </tr> </table>				<b>Part No.</b>	358119	<b>Ref. No.</b>	—	<b>description</b>	frame L 118mm W 72mm mounting distance 143mm for bulb socket		
<b>Part No.</b>	358119	<b>Ref. No.</b>	—								
<b>description</b>	frame L 118mm W 72mm mounting distance 143mm for bulb socket										
 <table border="1"> <tr> <td><b>Part No.</b></td> <td>358122</td> <td><b>Ref. No.</b></td> <td>—</td> </tr> <tr> <td><b>description</b></td> <td colspan="3">gasket L 112mm W 68mm silicone thickness 3mm for bulb socket</td> </tr> </table>				<b>Part No.</b>	358122	<b>Ref. No.</b>	—	<b>description</b>	gasket L 112mm W 68mm silicone thickness 3mm for bulb socket		
<b>Part No.</b>	358122	<b>Ref. No.</b>	—								
<b>description</b>	gasket L 112mm W 68mm silicone thickness 3mm for bulb socket										
 <table border="1"> <tr> <td><b>Part No.</b></td> <td>358123</td> <td><b>Ref. No.</b></td> <td>—</td> </tr> <tr> <td><b>description</b></td> <td colspan="3">lamp glass L 112mm W 68mm</td> </tr> </table>				<b>Part No.</b>	358123	<b>Ref. No.</b>	—	<b>description</b>	lamp glass L 112mm W 68mm		
<b>Part No.</b>	358123	<b>Ref. No.</b>	—								
<b>description</b>	lamp glass L 112mm W 68mm										
 <table border="1"> <tr> <td><b>Part No.</b></td> <td>359612</td> <td><b>Ref. No.</b></td> <td>C2104-03 C6073E-00 RRC2104-03 RRC6073E-00</td> </tr> <tr> <td><b>description</b></td> <td colspan="3">light bulb t.max. 300°C socket E14 25W 230V ø 25mm L 56mm lens L 30mm for oven lamp type Philips</td> </tr> </table>				<b>Part No.</b>	359612	<b>Ref. No.</b>	C2104-03 C6073E-00 RRC2104-03 RRC6073E-00	<b>description</b>	light bulb t.max. 300°C socket E14 25W 230V ø 25mm L 56mm lens L 30mm for oven lamp type Philips		
<b>Part No.</b>	359612	<b>Ref. No.</b>	C2104-03 C6073E-00 RRC2104-03 RRC6073E-00								
<b>description</b>	light bulb t.max. 300°C socket E14 25W 230V ø 25mm L 56mm lens L 30mm for oven lamp type Philips										
 <table border="1"> <tr> <td><b>Part No.</b></td> <td>359714</td> <td><b>Ref. No.</b></td> <td>C2104-32 RRC2104-32</td> </tr> <tr> <td><b>description</b></td> <td colspan="3">gasket silicone L 140mm W 75mm for bulb socket</td> </tr> </table>				<b>Part No.</b>	359714	<b>Ref. No.</b>	C2104-32 RRC2104-32	<b>description</b>	gasket silicone L 140mm W 75mm for bulb socket		
<b>Part No.</b>	359714	<b>Ref. No.</b>	C2104-32 RRC2104-32								
<b>description</b>	gasket silicone L 140mm W 75mm for bulb socket										
 <table border="1"> <tr> <td><b>Part No.</b></td> <td>359715</td> <td><b>Ref. No.</b></td> <td>C2104-22 RRC2104-22</td> </tr> <tr> <td><b>description</b></td> <td colspan="3">lamp glass L 110mm W 65mm thickness 5mm</td> </tr> </table>				<b>Part No.</b>	359715	<b>Ref. No.</b>	C2104-22 RRC2104-22	<b>description</b>	lamp glass L 110mm W 65mm thickness 5mm		
<b>Part No.</b>	359715	<b>Ref. No.</b>	C2104-22 RRC2104-22								
<b>description</b>	lamp glass L 110mm W 65mm thickness 5mm										
 <table border="1"> <tr> <td><b>Part No.</b></td> <td>359716</td> <td><b>Ref. No.</b></td> <td>C2104-12 RRC2104-12</td> </tr> <tr> <td><b>description</b></td> <td colspan="3">frame for bulb socket</td> </tr> </table>				<b>Part No.</b>	359716	<b>Ref. No.</b>	C2104-12 RRC2104-12	<b>description</b>	frame for bulb socket		
<b>Part No.</b>	359716	<b>Ref. No.</b>	C2104-12 RRC2104-12								
<b>description</b>	frame for bulb socket										
<b>accessories for</b>	359698										
 <table border="1"> <tr> <td><b>Part No.</b></td> <td>359612</td> <td><b>Ref. No.</b></td> <td>C2104-03 C6073E-00 RRC2104-03 RRC6073E-00</td> </tr> <tr> <td><b>description</b></td> <td colspan="3">light bulb t.max. 300°C socket E14 25W 230V ø 25mm L 56mm lens L 30mm for oven lamp type Philips</td> </tr> </table>				<b>Part No.</b>	359612	<b>Ref. No.</b>	C2104-03 C6073E-00 RRC2104-03 RRC6073E-00	<b>description</b>	light bulb t.max. 300°C socket E14 25W 230V ø 25mm L 56mm lens L 30mm for oven lamp type Philips		
<b>Part No.</b>	359612	<b>Ref. No.</b>	C2104-03 C6073E-00 RRC2104-03 RRC6073E-00								
<b>description</b>	light bulb t.max. 300°C socket E14 25W 230V ø 25mm L 56mm lens L 30mm for oven lamp type Philips										

<b>accessories for</b>	359698										
 <table border="1"> <tr> <td><b>Part No.</b></td> <td>359938</td> <td><b>Ref. No.</b></td> <td>—</td> </tr> <tr> <td><b>description</b></td> <td colspan="3">borosilicate glass L 115mm W 69mm</td> </tr> </table>				<b>Part No.</b>	359938	<b>Ref. No.</b>	—	<b>description</b>	borosilicate glass L 115mm W 69mm		
<b>Part No.</b>	359938	<b>Ref. No.</b>	—								
<b>description</b>	borosilicate glass L 115mm W 69mm										

## lamps

## light bulbs

 <p>1</p>			
<b>Part No.</b>	359610	<b>Ref. No.</b>	C6085-05 RRC6085-05
<b>description</b>	light bulb t.max. 300°C socket E14 15W 230V ø 22mm L 47mm lens L 20mm for oven lamp type Philips		

 <p>1</p>			
<b>Part No.</b>	359612	<b>Ref. No.</b>	C2104-03 C6073E-00 RRC2104-03 RRC6073E-00
<b>description</b>	light bulb t.max. 300°C socket E14 25W 230V ø 25mm L 56mm lens L 30mm for oven lamp type Philips		

## halogen lamps

## for socket G4 / G6.35 / G9

 <p>1</p>			
<b>Part No.</b>	359074	<b>Ref. No.</b>	C5252-00 RRC5252-00
<b>description</b>	halogen lamp socket G6.35 12V 35W temp.-resist. 500°C		

 <p>1</p>			
<b>Part No.</b>	359946	<b>Ref. No.</b>	LC-051
<b>description</b>	halogen lamp socket G9 230V 40W temp.-resist. 300°C		

## sockets

## G4 / G5,3 / G6,35

 <p>1</p>			
<b>Part No.</b>	359369	<b>Ref. No.</b>	C5251-00 C5259-00 C5259-00A RRC5251-00
<b>description</b>	lamp socket socket G4/G5.3/G6.35 24V ø 17mm H 10mm connection cable 120mm mounting distance 11.5mm for halogen lamp cable length 730mm		
<b>For models:</b>	MDP-6G		



## timers

## programme timers

			
1			
<b>Part No.</b>	360752	<b>Ref. No.</b>	C3056-00 RRC3056-00
<b>description</b>	timer CDC 4902F1 engines 1 chambers 2 operation time 8min 230V shaft ømm shaft Lmm		

## electric timers

## with time spread

			
1			
<b>Part No.</b>	350074	<b>Ref. No.</b>	C5365-00 RRC5365-00
<b>description</b>	timer MS65 operation time 120min time spread 30min 1CO/2NO/1NC at 250V 16A permanent position yes impulse electric shaft ø 6x4.6mm shaft L 22mm mounting distance 28mm connection lateral Invensys 4-pole shaft position lower°		

## mechanical timers

			
1			
<b>Part No.</b>	350040	<b>Ref. No.</b>	C2191-00 RRC2191-00
<b>description</b>	timer M2 with bell 2-pole operation time 60min impulse mechanical 2NO at 250V 16A permanent position yes shaft ø 6x4.6mm shaft 6x4.6mm shaft L 23mm mounting distance 28mm connection lateral		
<b>accessories for</b>	350040		
	<b>Part No.</b>	110366	<b>Ref. No.</b> —
	knob switch zero mark t.max. °C ø 44mm shaft ø 6x4.6mm shaft flat upper black		
	<b>Part No.</b>	111202	<b>Ref. No.</b> —
	dial plate graduation 60min permanent position yes rotation 0-300° ø 60mm timers knob ø 45mm with permanent position		

## alarm devices



## buzzer boards



			
1			
<b>Part No.</b>	401062	<b>Ref. No.</b>	C5366-00 RRC5366-00
<b>description</b>	buzzer board 230VAC L 48mm W 45mm connection Faston 6.3mm		

## contactors

## LOVATO

## power contactors

			
1			
<b>Part No.</b>	380705	<b>Ref. No.</b>	LC-310 RRLC-310
<b>description</b>	power contactor resistive load 20A 230VAC (AC3/400V) 9A/4kW main contacts 3NO auxiliary contacts 1NO connection screw connection type 11BG0910A230		
<b>accessories for</b>	380705		
	<b>Part No.</b>	380057	<b>Ref. No.</b> LC-315 RRLC-315
	auxiliary contact contacts 1NO/1NC AC1 10A for contactors BG series connection screw type BGX1011		

			
1			
<b>Part No.</b>	380855	<b>Ref. No.</b>	C2201-00 RRC2201-00
<b>description</b>	power contactor resistive load 25A 230VAC (AC3/400V) 4.2kW main contacts 3NO auxiliary contacts 1NO		
<b>For models:</b>	CVE 10-R		
<b>accessories for</b>	380855		
	<b>Part No.</b>	380055	<b>Ref. No.</b> LC-313 RRLC-313
	RC circuit voltage AC/DC suitable for BF09-32 rated 240V		
	<b>Part No.</b>	380118	<b>Ref. No.</b> C3618-00 RRC3618-00
	auxiliary contact contacts 1NO/1NC AC1 10A for contactors BF series connection screw type G480/11		



## auxiliary contacts



1

<b>Part No.</b>	380118	<b>Ref. No.</b>	C3618-00 RRC3618-00
<b>description</b>	auxiliary contact contacts 1NO/1NC AC1 10A for contactors BF series connection screw type G480/11		



1

<b>Part No.</b>	380057	<b>Ref. No.</b>	LC-315 RRLC-315
<b>description</b>	auxiliary contact contacts 1NO/1NC AC1 10A for contactors BG series connection screw type BGX1011		

## miscellaneous

## RC circuits



1

<b>Part No.</b>	380056	<b>Ref. No.</b>	MC-800 RRMC-800
<b>description</b>	RC circuit 250V		
<b>For models:</b>	MDP-6G		

## relays

## plug-in/print relays



1

<b>Part No.</b>	381153	<b>Ref. No.</b>	AZ019-00
<b>description</b>	print relay 230VAC 2CO at 250V 8A raster size 5mm with socket		
<b>spare parts for</b>	381153		
	<b>Part No.</b>	381168	<b>Ref. No.</b> —
	print relay 230VAC 2CO 2-pole at 250V 8A connection pins raster size 5mm SCHRACK manuf. no. RT424730 95.65/95.75		

## level relays

## GICAR



1

<b>Part No.</b>	400018	<b>Ref. No.</b>	HC-055 RRHC-055
<b>description</b>	level relay 230V voltage AC connection F6.3 type RL30/3ES/F/G		

## miscellaneous



1

<b>Part No.</b>	401138	<b>Ref. No.</b>	HC-050 RRHC-050
<b>description</b>	level relay		

## transformers

## open transformers

## with clamp terminal



1

<b>Part No.</b>	401128	<b>Ref. No.</b>	LC-434 RRLC-434
<b>description</b>	transformer primary 230V secondary 12V 100VA		



1

<b>Part No.</b>	401135	<b>Ref. No.</b>	LC-436 RRLC-436
<b>description</b>	transformer primary 230V secondary 12V 120VA secondary 10A ambient temperature max. 50°C		

1

<b>Part No.</b>	401065	<b>Ref. No.</b>	LC-449 RRLC-449
<b>description</b>	transformer primary 230V secondary 12V 120VA secondary 7.5A+2.5A connection screw 50/60Hz		



1

<b>Part No.</b>	401229	<b>Ref. No.</b>	LC-488
<b>description</b>	transformer primary 230V secondary 12V 63VA		
<b>For models:</b>	MDP-6G		



1

<b>Part No.</b>	403117	<b>Ref. No.</b>	LC-493
<b>description</b>	transformer primary 440V secondary 254V 1000VA connection screw clamp 50/60Hz		



1

<b>Part No.</b>	403118	<b>Ref. No.</b>	LC-494
<b>description</b>	transformer primary 440V secondary 254V 500VA connection screw clamp 50/60Hz		

encapsulated transformers

multiple connections



1

<b>Part No.</b>	401137	<b>Ref. No.</b>	C2563-00 LC-442 RRC2563-00 RRLC-442
<b>description</b>	transformer primary 230V secondary 12V 12VA		



1

<b>Part No.</b>	401136	<b>Ref. No.</b>	LC-444 RRLC-444
<b>description</b>	transformer primary 230V secondary 12V 60VA		



1

<b>Part No.</b>	401087	<b>Ref. No.</b>	LC-445 RRLC-445
<b>description</b>	transformer primary 230V secondary 24V 60VA secondary 2.5A connection male faston 6.3mm 50/60Hz		

PMA



1

<b>Part No.</b>	379054	<b>Ref. No.</b>	FX0149-00 RRFX149-00
<b>description</b>	transformer primary 230VAC secondary 12VAC 3VA secondary 0.25A H 40mm L 45mm W 50mm connection screw 50/60Hz type 153/M		



## electronic controllers

## EKTRON

## refrigeration controllers

## built-in version



1

<b>Part No.</b>	379397	<b>Ref. No.</b>	C2196-00 RRC2196-00
<b>description</b>	electronic controller EKTRON type DEK31-1000A mounting measurements 71x29mm 12V voltage AC/DC Pt100 relay outputs 2 CO-8A(4) NO-8A(4) Pt100 built-in depth 71mm -99 to +999°C display 3½ digits		

## SHANGFANG

## accessories



1

<b>Part No.</b>	379054	<b>Ref. No.</b>	FX0149-00 RREFX149-00
<b>description</b>	transformer primary 230VAC secondary 12VAC 3VA secondary 0.25A H 40mm L 45mm W 50mm connection screw 50/60Hz type 153/M		

## probes

## producer-specific probes

## probes



1

<b>Part No.</b>	378047	<b>Ref. No.</b>	C8248-00 C8248-12 RRC8248-00
<b>description</b>	temperature probe NTC 100kOhm cable TPE probe -40 up to +110°C cable -40 up to +110°C connection male faston thread probe ø5x-20mm cable length 0.9m		



1

<b>Part No.</b>	379596	<b>Ref. No.</b>	C2471-00 RRC2471-00
<b>description</b>	temperature probe Pt100 cable PTFE probe -100 up to 450°C cable -40 up to +250°C connection 2-wire thread probe ø4x60mm cable length 0.6m		
<b>For models:</b>	MDP-6G		

## core probes



1

<b>Part No.</b>	379597	<b>Ref. No.</b>	C2209-00 C2209-22 RRC2209-00
<b>description</b>	core temperature probe Pt100 cable PTFE probe -40 up to +250°C cable -40 up to +250°C connection 2-wire probe ø4x100mm thread cable length 1.7m handle ø 10mm handle length 80mm		
<b>For models:</b>	MDP-6G		



1

<b>Part No.</b>	379505	<b>Ref. No.</b>	C8250-22
<b>description</b>	core temperature probe Pt1000 cable PTFE probe -40 up to +250°C cable -40 up to +250°C connection 2-wire probe ø4x100mm thread cable length 1.7m handle ø 10mm handle length 80mm		

## electronics

## EPROMS



1

<b>Part No.</b>	401107	<b>Ref. No.</b>	C2474-00 RRC2474-00
<b>description</b>	micro processor		
<b>For models:</b>	MDP-6G		

## PCBs



1

<b>Part No.</b>	401063	<b>Ref. No.</b>	C8165-00 RRC8165-00
<b>description</b>	keypad PCB		

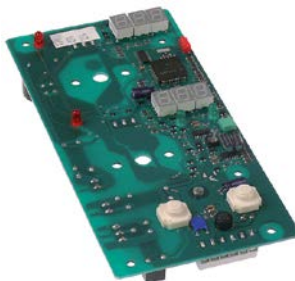



1

<b>Part No.</b>	401103	<b>Ref. No.</b>	C2561-00 RRC2561-00
<b>description</b>	keypad PCB		







			
1			
<b>Part No.</b>	401104	<b>Ref. No.</b>	C2467-00 RRC2467-00
<b>description</b>	keypad PCB		
<b>For models:</b>	MDP-6G		

			
1			
<b>Part No.</b>	401101	<b>Ref. No.</b>	C2560-00 RRC2560-00
<b>description</b>	keypad PCB L 200mm W 95mm		

			
1			
<b>Part No.</b>	403597	<b>Ref. No.</b>	C8164-00 RRC8164-00
<b>description</b>	keypad PCB L 310mm W 105mm		

			
1			
<b>Part No.</b>	401064	<b>Ref. No.</b>	C8166-00 RRC8166-00
<b>description</b>	keypad PCB programmable key pad F-Series encoder		

			
1			
<b>Part No.</b>	401105	<b>Ref. No.</b>	C2468-00 RRC2468-00
<b>description</b>	keypad PCB with display		
<b>For models:</b>	MDP-6G		

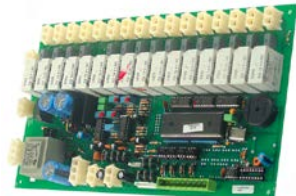
			
1			
<b>Part No.</b>	401106	<b>Ref. No.</b>	MC-865 RRMC-865
<b>description</b>	keypad PCB with display		

			
1			
<b>Part No.</b>	401061	<b>Ref. No.</b>	C5956-00 RRC5956-00
<b>description</b>	PCB for fan		

			
1			
<b>Part No.</b>	401058	<b>Ref. No.</b>	C8167-00 RRC8167-00
<b>description</b>	PCB suitable for programmable key pad F-Series controller		

## keypads

### front foils

			
1			
<b>Part No.</b>	401097	<b>Ref. No.</b>	C6054-00/BI RRC6054-00/BI
<b>description</b>	front foil		

			
1			
<b>Part No.</b>	401098	<b>Ref. No.</b>	C6057-00/BI RRC6057-00/BI
<b>description</b>	front foil		



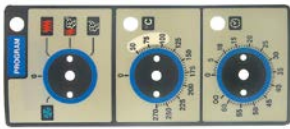

1 

<b>Part No.</b>	401099	<b>Ref. No.</b>	C3654-00/B RRC3654-00/B
<b>description</b>	front foil		

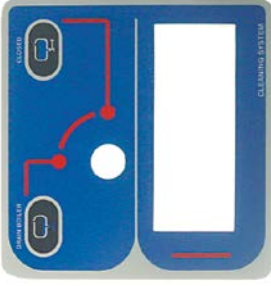
1 

<b>Part No.</b>	401112	<b>Ref. No.</b>	C5521-00/B RRC5521-00/B
<b>description</b>	front foil		

1 

<b>Part No.</b>	401113	<b>Ref. No.</b>	C5506-00/B RRC5506-00/B
<b>description</b>	front foil		

1 

<b>Part No.</b>	401114	<b>Ref. No.</b>	C5508-00/B RRC5508-00/B
<b>description</b>	front foil		

1 

<b>Part No.</b>	401116	<b>Ref. No.</b>	C5298-00/B RRC5298-00/B
<b>description</b>	front foil		

1 

<b>Part No.</b>	401124	<b>Ref. No.</b>	C5704-00/R RRC5704-00/R
<b>description</b>	front foil		

1 

<b>Part No.</b>	401125	<b>Ref. No.</b>	C5706-00/R RRC5706-00/R
<b>description</b>	front foil		

1 

<b>Part No.</b>	403826	<b>Ref. No.</b>	C2245-00 RRC2245-00
<b>description</b>	front foil		

1 

<b>Part No.</b>	403019	<b>Ref. No.</b>	C5278-00/B
<b>description</b>	front foil blue suitable for INOXTREND L 496mm W 115mm		

1 

<b>Part No.</b>	401100	<b>Ref. No.</b>	C3655-00/B RRC3655-00/B
<b>description</b>	keypad foil		

1 

<b>Part No.</b>	401117	<b>Ref. No.</b>	C5510-00/B RRC5510-00/B
<b>description</b>	keypad foil		

1 

<b>Part No.</b>	401118	<b>Ref. No.</b>	C5512-00/B RRC5512-00/B
<b>description</b>	keypad foil		

1 

<b>Part No.</b>	401119	<b>Ref. No.</b>	C5273-00/B RRC5273-00/B
<b>description</b>	keypad foil		



			
1			
<b>Part No.</b>	401120	<b>Ref. No.</b>	C5293-00/B RRC5293-00/B
<b>description</b>	keypad foil		

			
1			
<b>Part No.</b>	401121	<b>Ref. No.</b>	C5272-00/B RRC5272-00/B
<b>description</b>	keypad foil		
<b>For models:</b>	MDP-6G		

			
1			
<b>Part No.</b>	401122	<b>Ref. No.</b>	C5527-00/B RRC5527-00/B
<b>description</b>	keypad foil		

			
1			
<b>Part No.</b>	401123	<b>Ref. No.</b>	C5292-00/A C5292-00/B RRC5292-00/A RRC5292-00/B
<b>description</b>	keypad foil		

			
1			
<b>Part No.</b>	401126	<b>Ref. No.</b>	C5700-00/R RRC5700-00/R
<b>description</b>	keypad foil		

			
1			
<b>Part No.</b>	401127	<b>Ref. No.</b>	C5702-00/R RRC5702-00/R
<b>description</b>	keypad foil		

## keypad units



			
1			
<b>Part No.</b>	401110	<b>Ref. No.</b>	MC-852 RRCM-852
<b>description</b>	keypad unit		

## solenoid valves

## solenoid valves (water)

## ROBERTSHAW/INVENSYS

medium temperature:	90°C	90°C	60°C
ambient temperature:	60°C	25°C	60°C
duty cycle:	40%	100%	100%

			
1			
<b>Part No.</b>	372025	<b>Ref. No.</b>	C2088-00 RRC2088-00
<b>description</b>	solenoid valve triple straight 230VAC inlet 3/4" outlet 11.5mm DN10 EATON (INVENSYS)		
<b>For models:</b>	MDP-6G		
<b>accessories for</b>	372025		
	<b>Part No.</b>	371250	<b>Ref. No.</b>
			C1707-00
	reducer type EATON (INVENSYS) flow rate 0.25l/min pressure range 0 up to 10bar tolerance ±15/25% white		

## spare parts and accessories

## reducers

## outlet side

			
1			
<b>Part No.</b>	371250	<b>Ref. No.</b>	C1707-00
<b>description</b>	reducer type EATON (INVENSYS) flow rate 0.25l/min pressure range 0 up to 10bar tolerance ±15/25% white		

## RPE

			
1			
<b>Part No.</b>	374021	<b>Ref. No.</b>	C2087-00 RRC2087-00
<b>description</b>	solenoid valve double straight 230VAC inlet 3/4" outlet 10mm DN10 RPE		



 <p>1</p>			
<b>Part No.</b>	374017	<b>Ref. No.</b>	C3057-00 RRC3057-00
<b>description</b>	solenoid valve single straight 230VAC inlet 3/4" outlet 10mm input 6l/min DN10 RPE polyamide flow regulating valve inlet white membranes NBR pressure range 0.2-10bar		







 <p>1</p>			
<b>Part No.</b>	374027	<b>Ref. No.</b>	C2089-00 RRC2089-00
<b>description</b>	solenoid valve 4-fold angled 230VAC inlet 3/4" outlet 10mm DN10 RPE		















**solenoid valves with reducers**

**2-fold**

 <p>1</p>			
<b>Part No.</b>	374035	<b>Ref. No.</b>	C2082-00 RRC2082-00
<b>description</b>	solenoid valve double straight 230VAC inlet 3/4" outlet 11.5mm input 10-12l/min t.max. 60°C duty cycle 100% plastic		

**TP**

  <p>1</p>			
<b>Part No.</b>	370017	<b>Ref. No.</b>	AZ005-00
<b>description</b>	solenoid valve single straight 230VAC inlet 3/4" outlet 11.5mm DN10 TP p max 10bar		
<b>spare parts for</b>	370017		
 <p>Part No. 371013 Ref. No. — solenoid coil TP 230VAC 50/60Hz</p>			
<b>accessories for</b>	370017		
 <p>Part No. 371220 Ref. No. — reducer TP flow rate 3l/min red tolerance ±15%</p>			
 <p>Part No. 371221 Ref. No. — reducer TP flow rate 5.5l/min yellow tolerance ±15%</p>			
 <p>Part No. 371222 Ref. No. — reducer TP flow rate 6l/min grey tolerance ±15%</p>			

<b>accessories for</b>	370017		
 <p>Part No. 371223 Ref. No. — reducer TP flow rate 10l/min white tolerance ±15%</p>			
 <p>Part No. 371224 Ref. No. — reducer TP flow rate 12l/min bronze tolerance ±15%</p>			
 <p>Part No. 371225 Ref. No. — reducer TP flow rate 16l/min light brown tolerance ±15%</p>			
 <p>Part No. 371226 Ref. No. — reducer TP flow rate 20l/min red tolerance ±15%</p>			
 <p>Part No. 371230 Ref. No. — reducer TP flow rate 0.25l/min red tolerance ±25%</p>			
 <p>Part No. 371231 Ref. No. — reducer TP flow rate 0.35l/min violet tolerance ±25%</p>			
 <p>Part No. 371232 Ref. No. — reducer TP flow rate 0.5l/min orange tolerance ±25%</p>			
 <p>Part No. 371233 Ref. No. — reducer TP flow rate 0.8l/min white tolerance ±25%</p>			
 <p>Part No. 371234 Ref. No. — reducer TP flow rate 1l/min light blue tolerance ±25%</p>			
 <p>Part No. 371235 Ref. No. — reducer TP flow rate 1.2l/min brown tolerance ±25%</p>			
 <p>Part No. 371236 Ref. No. — reducer TP flow rate 1.5l/min light brown tolerance ±25%</p>			
 <p>Part No. 371237 Ref. No. — reducer TP flow rate 2.5l/min yellow tolerance ±25%</p>			
 <p>Part No. 371238 Ref. No. — reducer TP flow rate 3.4l/min dark green tolerance ±25%</p>			
 <p>Part No. 371239 Ref. No. — reducer TP flow rate 5l/min black tolerance ±25%</p>			
 <p>Part No. 371240 Ref. No. — reducer TP flow rate 8l/min blue tolerance ±20%</p>			

metal

solenoid valves (various)



1			
<b>Part No.</b>	370338	<b>Ref. No.</b>	C2072-00 RRC2072-00
<b>description</b>	solenoid valve 2-ways 230VAC connection 1/8" DN 6mm		



1			
<b>Part No.</b>	370319	<b>Ref. No.</b>	LC-455 RRLC-455
<b>description</b>	solenoid valve 2-ways 230VAC inlet 1/4" outlet 1/4" p max 13bar p min 0.1bar 50Hz 230V brass		
<b>spare parts for</b>	370319		
	<b>Part No.</b>	371188	<b>Ref. No.</b> —
	solenoid coil 50Hz 230V H 35mm seat $\varnothing$ 13mm type H 17VA series 688		

## ball valves electric



1			
<b>Part No.</b>	401085	<b>Ref. No.</b>	LC-500 RRLC-500
<b>description</b>	ball valve inlet 1/2" IT outlet 1/2" IT 230V L 60mm 50/60Hz closed off-current mode of operation electric connection cable 400mm cable 3-pole		

## pressure switches

for coffee machines

$\varnothing$  38mm



1			
<b>Part No.</b>	541340	<b>Ref. No.</b>	C2074-00 RRC2074-00
<b>description</b>	pressure control $\varnothing$ 38mm pressure range 0.5-1.2bar pressure connection vertical preset at 0.9bar coffee machine parts connection male faston 6.3mm pressure connection 1/8"		



1			
<b>Part No.</b>	541341	<b>Ref. No.</b>	C2076-00 RRC2076-00
<b>description</b>	pressure control $\varnothing$ 38mm pressure range 1.5-4bar pressure connection vertical preset at 3bar 16A 250V coffee machine parts connection 1/8" pressure connection 1/8"		

for steam control



1			
<b>Part No.</b>	541581	<b>Ref. No.</b>	C2075-00 RRC2075-00
<b>description</b>	pressure control $\varnothing$ 38mm pressure range fixed 1.6bar connection 1/8" 1CO 16A preset at 1.6bar pressure connection 1/8" ET		

## electrodes



1			
<b>Part No.</b>	401086	<b>Ref. No.</b>	HC-054 RRHC-054
<b>description</b>	level electrode 1/4" total length 70mm probe L 44mm insulated probe length 39mm PTFE insulated connection male faston 6.3mm stainless steel $\varnothing$ 2.5mm		







## fans

## axial fans

## import



1

<b>Part No.</b>	601080 <sup>1</sup>	<b>Ref. No.</b>	FX0068-00 RRFX0068-00
<b>description</b>	axial fan L 119mm W 119mm H 38mm 230VAC 50/60Hz 23/20W bearing ball connection male faston 2.8mm metal ADDA fan wheel ø 110mm temp.-resist. 70°C		
<b>For models:</b>	MDP-6G		
<b>accessories for</b>	601080		
	<b>Part No.</b>	550898	<b>Ref. No.</b> —
	connecting cable cable length 2000mm connection F 2.8 connection distance 7.9mm for axial flow fan		
	<b>Part No.</b>	692519	<b>Ref. No.</b> —
	guard L 120mm W 120mm plastic		

<sup>1</sup>with ball bearings

## hot air motors



1

<b>Part No.</b>	550049	<b>Ref. No.</b>	C2029-00 RRC2029-00
<b>description</b>	counterflange for fan motor ED ø 60mm int. ø 1 27.3mm int. ø 2 18.5mm thickness 5.8mm brass		



1

<b>Part No.</b>	511585	<b>Ref. No.</b>	C2027-00 RRC2027-00
<b>description</b>	engine shaft gasket ID ø 17mm ED ø 21.5mm thickness 3.5mm conical		
<b>For models:</b>	MDP-6G		

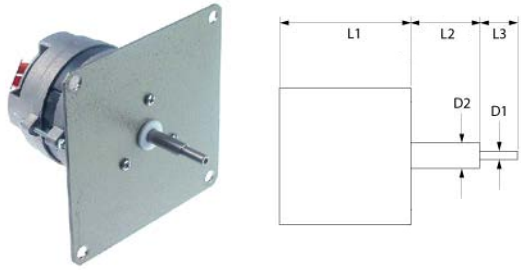
	<b>Part No.</b>	500629	<b>Ref. No.</b>	C3610-00 RRC3610-00
<b>description</b>	fan motor 220-240V 1 phase 50/60Hz 0.045/0.0765kW 2800/3400rpm speeds 1 L1 95mm L2 33mm L3 19mm D1 ø 8mm D2 ø 10mm 0.35A suitable capacitor 2.5µF/400V type 1048			

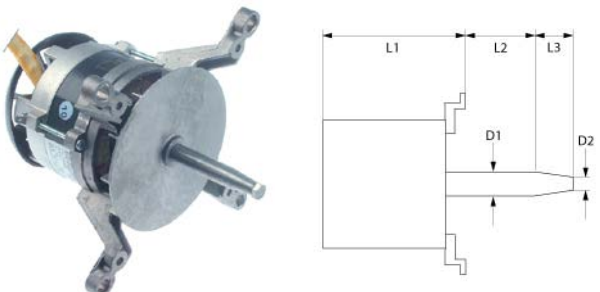
	<b>Part No.</b>	500630	<b>Ref. No.</b>	C2015-00 C2901-00 RRC2901-00
<b>description</b>	fan motor 230/400V 3 phase 50Hz 0.37kW 2600rpm speeds 1 L1 175mm L2 50mm L3 28mm D1 ø 17mm D2 ø 12mm M8R IT 1.1/1.9A Cos(fi) 0.75 at 50Hz 2600rpm type 1020.5450			
<b>For models:</b>	CVE-10E			

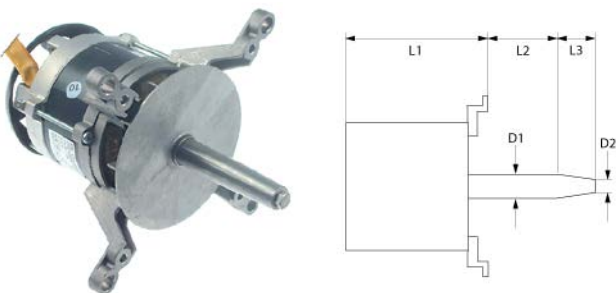
	<b>Part No.</b>	500631	<b>Ref. No.</b>	C7160-00 C7161-00 RRC7160-00
<b>description</b>	fan motor 230/400V 3 phase 50Hz 0.55kW 2800rpm speeds 1 L1 185mm L2 45mm L3 47mm D1 ø 24mm D2 ø 20mm M8L IT 2.6/1.5A Cos(fi) 0.8 at 50Hz 2800rpm type 3011B4050			

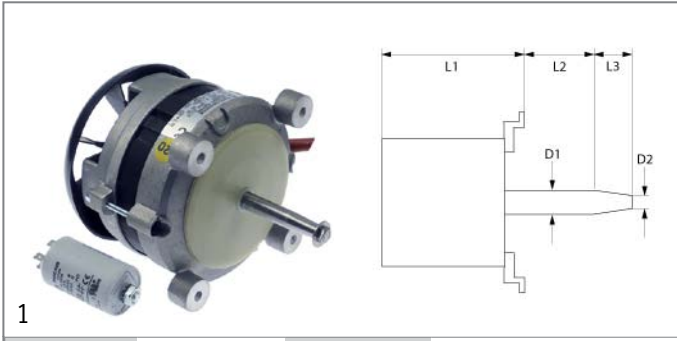
1

<b>Part No.</b>	601816	<b>Ref. No.</b>	C9011-00 C9011-12 RRC9011-00
<b>description</b>	fan motor 230V 1 phase 50Hz 0.25kW 2600rpm speeds 1 L1 90mm L2 38mm L3 24mm D1 ø 12mm D2 ø 10mm M6 1.5A Cos(fi) 0.98 suitable capacitor 10µF/450V		

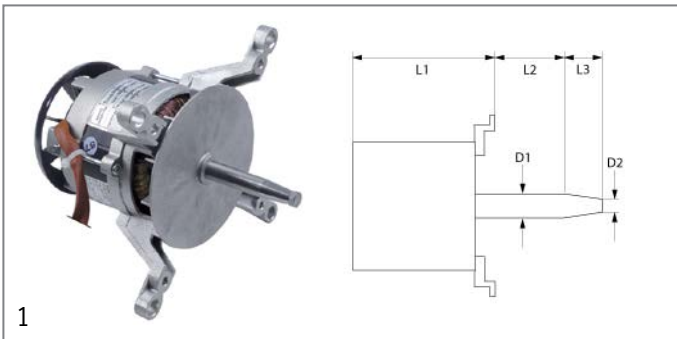

1

<b>Part No.</b>	601721	<b>Ref. No.</b>	C2900-00
<b>description</b>	fan motor 230V 1 phase 50Hz 0.37kW 2800rpm L1 172mm L2 53mm L3 33mm D1 ø 17mm D2 ø 12mm M8x1.25 2.5A suitable capacitor 10 Cos(fi) 0.95 type 1020.2350		



1

<b>Part No.</b>	514257	<b>Ref. No.</b>	C3612-00 RRC3612-00
<b>description</b>	fan wheel D1 ø 164mm H1 38mm blades 36 D2 ø 8mm D3 ø 8mm H2 28mm		



1

<b>Part No.</b>	514261	<b>Ref. No.</b>	C2030-00 C2037-00 RRC2030-00
<b>description</b>	fan wheel D1 ø 210mm H1 100mm blades 20 D2 ø 11mm D3 ø 16mm H2 30mm		
<b>For models:</b>	MDP-6G		



1

<b>Part No.</b>	514265	<b>Ref. No.</b>	C3067-00 C3068-00 RRC3068-00
<b>description</b>	fan wheel D1 ø 210mm H1 100mm blades 20 D2 ø 11mm D3 ø 16mm H2 30mm		



1

<b>Part No.</b>	601817	<b>Ref. No.</b>	C7535-00 C7535-00K
<b>description</b>	fan wheel D1 ø 240mm H1 43mm blades 55 D2 ø 9mm D3 ø 11mm H2 23mm		



1

<b>Part No.</b>	541580	<b>Ref. No.</b>	C2430-11 RRC2430-11
<b>description</b>	fan wheel D1 ø 250mm H1 120mm blades 26 D2 ø 11.5mm D3 ø 16.5mm H2 29mm		



1

<b>Part No.</b>	514262	<b>Ref. No.</b>	C2430-00 C2430-11K RRC2430-00
<b>description</b>	fan wheel D1 ø 250mm H1 120mm blades 26 D2 ø 11mm D3 ø 16mm H2 30mm		



1

<b>Part No.</b>	514264	<b>Ref. No.</b>	C7167-00 RRC7167-00
<b>description</b>	fan wheel D1 ø 270mm H1 120mm blades 24 D2 ø 19.5mm D3 ø 23mm H2 46mm		



1

<b>Part No.</b>	514263	<b>Ref. No.</b>	C7165-00 C7168-00 RRC7165-00
<b>description</b>	fan wheel D1 ø 300mm H1 120mm blades 24 D2 ø 19.5mm D3 ø 23.5mm H2 46mm		

## pumps

### vibration pumps



1

<b>Part No.</b>	500564	<b>Ref. No.</b>	C5770-00 RRC5770-00
<b>description</b>	vibration pump type EP 5 230V 48W 50Hz inlet ø 6 outlet ø 1/8" IT ULKA L 123mm		



1

<b>Part No.</b>	500563	<b>Ref. No.</b>	C6115-00 C6175-00 RRC6115-00 RRC6175-00
<b>description</b>	vibration pump type NME Typ2 230V 16W 50Hz inlet ø 4 outlet ø 6 ULKA L 76mm 110cc/min		

## condensators & interference suppression filters

### filters

#### interference suppression filters



1

<b>Part No.</b>	365090	<b>Ref. No.</b>	C2470-00 LC-317 RRC2470-00
<b>description</b>	interference suppression filter 250V 50/60Hz capacity 0.47µF(X2)+2X0.027µF(Y2)+2x1mH+0.68MµF		
<b>For models:</b>	MDP-6G		

#### RC circuits



1

<b>Part No.</b>	380056	<b>Ref. No.</b>	MC-800 RRMC-800
<b>description</b>	RC circuit 250V		
<b>For models:</b>	MDP-6G		



1

<b>Part No.</b>	380738	<b>Ref. No.</b>	LC-312 RRLC-312
<b>description</b>	RC circuit type 11BGX79240 suitable for BG series rated 125-240VACV		



1

<b>Part No.</b>	380055	<b>Ref. No.</b>	LC-313 RRLC-313
<b>description</b>	RC circuit voltage AC/DC suitable for BF09-32 rated 240V		



## fuses

## fine fuses

			
1			
<b>Part No.</b>	358532	<b>Ref. No.</b>	LC-422
<b>description</b>	fine fuse size ø5x20mm 2A fast-acting rated 250V Qty 10 pcs		

			
1			
<b>Part No.</b>	358594	<b>Ref. No.</b>	LC-426
<b>description</b>	fine fuse size ø5x20mm 0.16A slow-acting rated 250V Qty 10 pcs		

## electric accessories

## cables

## ribbon cables

## group 1

			
1			
<b>Part No.</b>	401111	<b>Ref. No.</b>	MC-853 RRMC-853
<b>description</b>	ribbon cable 16-pole L 600mm plug type FC-16P raster size 2.54mm		

## terminals

## connection terminals with screw/faston connections

			
1			
<b>Part No.</b>	550411	<b>Ref. No.</b>	FX0144-00
<b>description</b>	power terminal block 6-pole max. 40A max 450V connection ø6mm <sup>2</sup> / F6.3 temp.-resist. 150°C cross section 6mm <sup>2</sup>		

## electronic magnets

			
1			
<b>Part No.</b>	691625	<b>Ref. No.</b>	LC-370 RRLC-370
<b>description</b>	electronic magnet 230V 50Hz duty cycle 100% L 57mm W 46mm H 32mm		

## electronic components



## miscellaneous

			
1			
<b>Part No.</b>	401109	<b>Ref. No.</b>	MC-851 RRMC-851
<b>description</b>	control box		













## gas valves and ignition boxes

## gas control valves

## HONEYWELL







				
1				
<b>Part No.</b>	106012	<b>Ref. No.</b>	C5960-00 RRC5960-00	
<b>description</b>	gas valve type VK4115V 220-240V 50/60Hz gas inlet flange 32x32mm gas outlet flange 32x32mm thermocouple connection pilot connection pressure range 15-60mbar max 60mbar operator type HONEYWELL flange 32x32mm			
<b>accessories for</b>	106012			
	<b>Part No.</b>	102845	<b>Ref. No.</b>	—
	gas connection angled 1/2" flange 32x32mm hole distance 24x24mm Tandem			
	<b>Part No.</b>	102846	<b>Ref. No.</b>	—
	gas connection straight 1/2" flange 32x32mm hole distance 24x24mm suitable for Tandem			



SIT			
NOVASIT			
			
			
1			
<b>Part No.</b>	101162	<b>Ref. No.</b>	C2225-00 RRC2225-00
<b>description</b>	gas valve SIT series Novasit 820 230V 50Hz gas inlet 1/2" gas outlet 1/2" thermocouple connection M9x1 pilot connection M10x1 ignition pressure 3-5mbar pressure range 3-30mbar pressure regulator connection blind equiv. no. 0.820.010		
<b>spare parts for</b>	101162		
	<b>Part No.</b>	101065	<b>Ref. No.</b> —
	magnet unit with cable L 44mm D1 ø 30mm D2 ø 20mm suitable for NOVASIT		
	<b>Part No.</b>	101313	<b>Ref. No.</b> —
	solenoid coil 230V 50Hz		
<b>accessories for</b>	101162		
	<b>Part No.</b>	100006	<b>Ref. No.</b> —
	piezoelectric igniter suitable for ELETTROSIT body plastic blowing connection ø2.4mm ø 14mm		
	<b>Part No.</b>	101305	<b>Ref. No.</b> —
	gas connection straight 1/2" flange 45x45mm ELETTROSIT/V4400/4600/4605 suitable for SIT/HONEYWELL hole distance 36x36mm		
	<b>Part No.</b>	101306	<b>Ref. No.</b> —
	gas connection angled flange 45x45mm hole distance 36x36mm 1/2" ELETTROSIT/V4400/4600/4605 screw with O-ring suitable for SIT/HONEYWELL		
	<b>Part No.</b>	101307	<b>Ref. No.</b> —
	gas connection straight flange 45x45mm hole distance 36x36mm 3/4" ELETTROSIT/V4400/4600/4605 screw with O-ring suitable for SIT/HONEYWELL		
	<b>Part No.</b>	101308	<b>Ref. No.</b> —
	gas connection angled flange 45x45mm hole distance 36x36mm 3/4" ELETTROSIT/V4400/4600/4605 screw with O-ring suitable for SIT/HONEYWELL		
	<b>Part No.</b>	101312	<b>Ref. No.</b> —
	microswitch		
	<b>Part No.</b>	101314	<b>Ref. No.</b> —
	solenoid coil 24V 50Hz		
	<b>Part No.</b>	101317	<b>Ref. No.</b> —
	plug with cable L 1000mm suitable for NOVASIT		
	<b>Part No.</b>	101318	<b>Ref. No.</b> —
	cover cap for solenoid coil suitable for NOVASIT		

			
1			
<b>Part No.</b>	101967	<b>Ref. No.</b>	C5350-00 RRC5350-00
<b>description</b>	gas valve SIT series Novasit 822 230V 50Hz gas inlet 1/2" gas outlet 1/2" thermocouple connection pilot connection M10x1 ignition pressure 3-5mbar pressure range 3-30mbar pressure regulator connection perforated equiv. no. 0.822.110		
<b>spare parts for</b>	101967		
	<b>Part No.</b>	101313	<b>Ref. No.</b> —
	solenoid coil 230V 50Hz		
	<b>Part No.</b>	101542	<b>Ref. No.</b> —
	solenoid coil 50Hz NOVA 822/826/827 suitable for NOVASIT 230V		
<b>accessories for</b>	101967		
	<b>Part No.</b>	100904	<b>Ref. No.</b> —
	locking screw M10x1 for pipe ø 4mm Qty 1 pcs		
	<b>Part No.</b>	100905	<b>Ref. No.</b> —
	locking screw M10x1 for pipe ø 6mm Qty 1 pcs		
	<b>Part No.</b>	101305	<b>Ref. No.</b> —
	gas connection straight 1/2" flange 45x45mm ELETTROSIT/V4400/4600/4605 suitable for SIT/HONEYWELL hole distance 36x36mm		
	<b>Part No.</b>	101306	<b>Ref. No.</b> —
	gas connection angled flange 45x45mm hole distance 36x36mm 1/2" ELETTROSIT/V4400/4600/4605 screw with O-ring suitable for SIT/HONEYWELL		
	<b>Part No.</b>	101307	<b>Ref. No.</b> —
	gas connection straight flange 45x45mm hole distance 36x36mm 3/4" ELETTROSIT/V4400/4600/4605 screw with O-ring suitable for SIT/HONEYWELL		
	<b>Part No.</b>	101308	<b>Ref. No.</b> —
	gas connection angled flange 45x45mm hole distance 36x36mm 3/4" ELETTROSIT/V4400/4600/4605 screw with O-ring suitable for SIT/HONEYWELL		
	<b>Part No.</b>	101503	<b>Ref. No.</b> —
	O-ring EPDM thickness 2mm ID ø 32mm Qty 1 pcs		
	<b>Part No.</b>	101924	<b>Ref. No.</b> —
	plug with cable L 1090mm suitable for NOVA 822/826/827		



<b>Part No.</b>	106001	<b>Ref. No.</b>	C2226-00 RRC2226-00
<b>description</b>	gas valve SIT series Novasit 826 230V 50Hz gas inlet 1/2" gas outlet 1/2" thermocouple connection pilot connection closed ignition pressure 3-5mbar pressure range 2-50mbar pressure regulator connection standard equiv. no. 0.826.011 power supply for modulator 230VAC rectified		
<b>For models:</b>	MDP-6G		
<b>spare parts for</b>	106001		
	<b>Part No.</b>	101542	<b>Ref. No.</b> —
	solenoid coil 50Hz NOVA 822/826/827 suitable for NOVASIT 230V		
<b>accessories for</b>	106001		
	<b>Part No.</b>	101305	<b>Ref. No.</b> —
	gas connection straight 1/2" flange 45x45mm ELETTROSIT/V4400/4600/4605 suitable for SIT/HONEYWELL hole distance 36x36mm		
	<b>Part No.</b>	101306	<b>Ref. No.</b> —
	gas connection angled flange 45x45mm hole distance 36x36mm 1/2" ELETTROSIT/V4400/4600/4605 screw with O-ring suitable for SIT/HONEYWELL		
	<b>Part No.</b>	101307	<b>Ref. No.</b> —
	gas connection straight flange 45x45mm hole distance 36x36mm 3/4" ELETTROSIT/V4400/4600/4605 screw with O-ring suitable for SIT/HONEYWELL		
	<b>Part No.</b>	101308	<b>Ref. No.</b> —
	gas connection angled flange 45x45mm hole distance 36x36mm 3/4" ELETTROSIT/V4400/4600/4605 screw with O-ring suitable for SIT/HONEYWELL		
	<b>Part No.</b>	101859	<b>Ref. No.</b> C2226-01 RRC2226-01
	panel-mounted inlet with cable L 1000mm for rectifier suitable for NOVASIT		

accessories

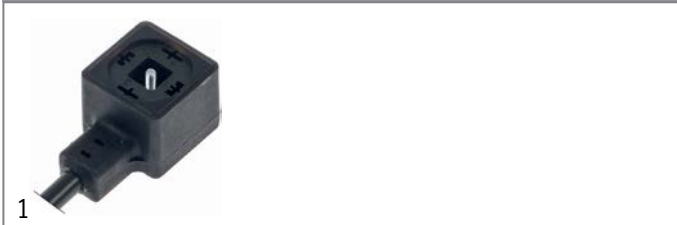

<b>Part No.</b>	101859	<b>Ref. No.</b>	C2226-01 RRC2226-01
<b>description</b>	panel-mounted inlet with cable L 1000mm for rectifier suitable for NOVASIT		
<b>For models:</b>	MDP-6G		

ignition boxes

HONEYWELL



<b>Part No.</b>	102367	<b>Ref. No.</b>	C5965-00 C5965-12 RRC5965-00
<b>description</b>	ignition box HONEYWELL type S4565A 2092 1 electrodes 3 waiting times safety time 10s 220-240V 4VA 50/60Hz		

ignition parts

electrodes

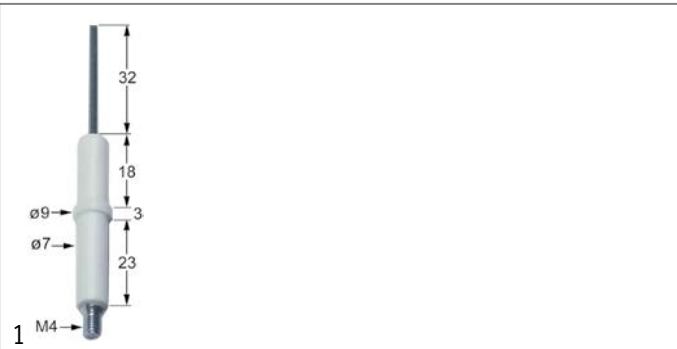

<b>Part No.</b>	100701	<b>Ref. No.</b>	C2235-00
<b>description</b>	ignition electrode connection M4 Qty 1 pcs		
<b>accessories for</b>	100701		
	<b>Part No.</b>	100906	<b>Ref. No.</b> —
	screw connection thread M10x1 for ignition electrode brass Qty 1 pcs WS 10		



1

<b>Part No.</b>	102315	<b>Ref. No.</b>	C2497-00 RRC2497-00
<b>description</b>	ignition electrode flange length 23mm flange width 15mm D1 ø 7mm L1 5mm BL1 30mm BL2 23mm connection F 2.8x0.8mm fixing dimensions ø5x4mm with flange		
<b>For models:</b>	MDP-6G		

1

<b>Part No.</b>	102293	<b>Ref. No.</b>	C5907-00 RRC5907-00
<b>description</b>	ignition electrode flange length 51mm flange width 23mm cable length 440mm		

1

<b>Part No.</b>	102316	<b>Ref. No.</b>	C2494-00 RRC2494-00
<b>description</b>	ignition electrode flange length 23mm flange width 15mm D1 ø 7mm L1 5mm BL1 30mm BL2 24mm connection F 6.3 cable length 800mm fixing dimensions ø5x4mm with flange		
<b>For models:</b>	MDP-6G		

1

<b>Part No.</b>	107657	<b>Ref. No.</b>	C9309-13 C9309-32 RRC9309-13
<b>description</b>	ignition electrode flange length 56mm flange width 22mm D1 ø 9.4mm L1 45mm L2 38/25mm L3 45/30mm BL1 57mm BL2 33mm connection male faston 4.8mm/6.3mm cable length 650mm screw		





## gas burners

## bar burners

## bar burners



<b>Part No.</b>	105663	<b>Ref. No.</b>	C2297-00 RRC2297-00
<b>description</b>	bar burner ø 40mm Wmm Hmm L 458mm flange width 43mm flange length 43mm combi-steamer		
<b>For models:</b>	MDP-6G		



<b>Part No.</b>	105664	<b>Ref. No.</b>	C2480-00 RRC2480-00
<b>description</b>	bar burner ø 50mm Wmm Hmm L 548mm flange width 57mm flange length 57mm combi-steamer		



<b>Part No.</b>	105665	<b>Ref. No.</b>	C7188-00 RRC7188-00
<b>description</b>	bar burner ø 60mm Wmm Hmm L 548mm flange width 67mm flange length 67mm combi-steamer		

## gas nozzles

## main nozzles

## gas nozzles M10x1



<b>Part No.</b>	100639	<b>Ref. No.</b>	C1866-00
<b>description</b>	gas injector thread M10x1 WS 11 bore ø 1.25mm inner peaked		



<b>Part No.</b>	106291	<b>Ref. No.</b>	C1770-00 RRC1770-00
<b>description</b>	gas injector thread M10x1 WS 11 bore ø 1.95mm inner peaked		

## pilot burner nozzles

## pilot burner nozzles SIT

## 140/150 series



<b>Part No.</b>	100205	<b>Ref. No.</b>	C2231-00
<b>description</b>	pilot burner nozzle SIT LPG code 19 bore ø 0.23/0.26mm Qty 1 pcs suitable for SIT 150 series		



<b>Part No.</b>	100206	<b>Ref. No.</b>	C2232-00
<b>description</b>	pilot burner nozzle SIT natural gas code 36 bore ø 0.60/0.55mm Qty 1 pcs suitable for SIT 150 series		

## steam generators

## steam generators



<b>Part No.</b>	693319	<b>Ref. No.</b>	C5450-90 RRC5450-00
<b>description</b>	steam generator complete ø 215mm 2200W 240V		

## injection nozzles



<b>Part No.</b>	691627	<b>Ref. No.</b>	C1715-00 C1715-13 RRC1715-00
<b>description</b>	injection nozzle bore ø 0.4mm D1 ø 6mm D2 ø 11.5mm L 35mm WS 14 brass		





1			
<b>Part No.</b>	691628	<b>Ref. No.</b>	C1717-00 C1717-12 RRC1717-00
<b>description</b>	injection nozzle bore $\varnothing$ 0.5mm D1 $\varnothing$ 6mm D2 $\varnothing$ 10.5mm L 35mm WS 14 brass		

1			
<b>Part No.</b>	691629	<b>Ref. No.</b>	C1418-00 C1418-12 C1418-21 RRC1418-00 RRC1418-12
<b>description</b>	injection nozzle bore $\varnothing$ 0.7mm D1 $\varnothing$ 6mm D2 $\varnothing$ 11.5mm L 38mm WS 14 brass thread 1/8"		

## cleaning system

### nozzles

1			
<b>Part No.</b>	510000	<b>Ref. No.</b>	C7285-00 RRC7285-00
<b>description</b>	nozzle $\varnothing$ 1.5/2.8mm H 13mm thread 1/8" ET WS 13		

## for dishwashers

### washing and rinsing systems

1			
<b>Part No.</b>	510000	<b>Ref. No.</b>	C7285-00 RRC7285-00
<b>description</b>	nozzle $\varnothing$ 1.5/2.8mm H 13mm thread 1/8" ET WS 13		

## knobs

### producer-specific knobs

#### INOXTREND

1			
<b>Part No.</b>	111000	<b>Ref. No.</b>	C5779B-00 RRC5779B-00
<b>description</b>	knob $\varnothing$ 60mm shaft $\varnothing$ 18.5x18.5mm for safety valve		

1			
<b>Part No.</b>	111683	<b>Ref. No.</b>	C5385-00 RRC5385-00
<b>description</b>	knob switch zero mark $\varnothing$ 40mm shaft $\varnothing$ 6x4.6mm shaft flat upper black		

1			
<b>Part No.</b>	111072	<b>Ref. No.</b>	C8119-00 C8119-22 RRC8119-00
<b>description</b>	knob switch zero mark $\varnothing$ 55mm shaft $\varnothing$ 6x4.6mm shaft flat upper silver		

1			
<b>Part No.</b>	111003 <sup>1</sup>	<b>Ref. No.</b>	C8124-00 RRC8124-00
<b>description</b>	knob switch zero mark $\varnothing$ 55mm shaft $\varnothing$ 6x4.6mm shaft flat upper silver depend shaft intake		

<sup>1</sup>depend shaft intake



## handles and hand wheels

## bracket handles



1

<b>Part No.</b>	691626	<b>Ref. No.</b>	C2417-00 RRC2417-00
<b>description</b>	pull handle L 140mm H 73mm handle M5		

## locks

## edgmount latches

## handle latches

## CAFF/FERMOD

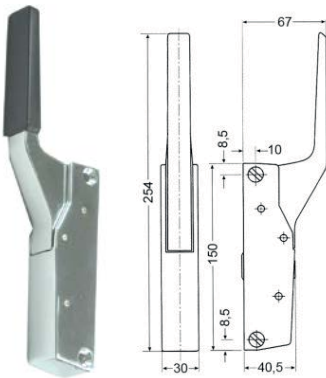

1

<b>Part No.</b>	690488	<b>Ref. No.</b>	C2210-01 RRC2210-01
<b>description</b>	catch		

## producer-specific

## INOXTREND





1

<b>Part No.</b>	690536	<b>Ref. No.</b>	C8118-00 C8118-00CR RRC8118-00
<b>description</b>	catch L 172mm mounting distance 133mm non lockable chrome-plated 6200 total length 248mm		
<b>accessories for</b>	690536		
	<b>Part No.</b>	690123	<b>Ref. No.</b> —
	door catch H 69mm D 37mm W 20mm mounting distance 43mm with roller		





1

<b>Part No.</b>	690146	<b>Ref. No.</b>	C2211-01 RRC2211-01
<b>description</b>	handle latch L 172mm mounting distance 134mm non lockable heated units 6200 H 65mm type DUPLO total length 248mm		
<b>For models:</b>	MDP-6G		
<b>accessories for</b>	690146		
	<b>Part No.</b>	690123	<b>Ref. No.</b> —
	door catch H 69mm D 37mm W 20mm mounting distance 43mm with roller		
	<b>Part No.</b>	693777	<b>Ref. No.</b> —
	gasket H 6.6mm L 105mm W 45mm L1 78mm W1 25mm for handle		
	<b>Part No.</b>	693778	<b>Ref. No.</b> —
	door catch		

## MODULAR



1





<b>Part No.</b>	690146	<b>Ref. No.</b>	C2211-01 RRC2211-01
<b>description</b>	handle latch L 172mm mounting distance 134mm non lockable heated units 6200 H 65mm type DUPLO total length 248mm		
<b>For models:</b>	MDP-6G		
<b>accessories for</b>	690146		
	<b>Part No.</b>	690123	<b>Ref. No.</b> —
	door catch H 69mm D 37mm W 20mm mounting distance 43mm with roller		
	<b>Part No.</b>	693777	<b>Ref. No.</b> —
	gasket H 6.6mm L 105mm W 45mm L1 78mm W1 25mm for handle		
	<b>Part No.</b>	693778	<b>Ref. No.</b> —
	door catch		

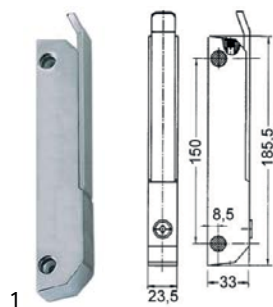

## RAHRBACH

### 6188 ERGO series



<b>Part No.</b>	700081	<b>Ref. No.</b>	C8050-00 RRC8050-00
<b>description</b>	handle latch L 185mm mounting distance 150mm chrome-plated non lockable refrigeration units 6188		
<b>accessories for</b>	700081		
	<b>Part No.</b>	690110	<b>Ref. No.</b> —
	base plate H 1mm L 38mm W 11mm mounting distance 26mm plastic		
	<b>Part No.</b>	690111	<b>Ref. No.</b> —
	base plate H 2mm L 38mm W 11mm mounting distance 26mm plastic		
	<b>Part No.</b>	690114	<b>Ref. No.</b> —
	base plate H 3.5mm L 185mm W 30mm mounting distance 150mm with inclination thread M5		
	<b>Part No.</b>	700082	<b>Ref. No.</b> C1447-00
	door catch L 38mm W 18mm mounting distance 26mm		

### door catches



<b>Part No.</b>	690487	<b>Ref. No.</b>	C2211-02 RRC2211-02
<b>description</b>	door catch H 41mm L 70mm W 21mm mounting distance 40mm nickel-plated brass with roller rollerø 8mm		
<b>For models:</b>	MDP-6G		



<b>Part No.</b>	700082	<b>Ref. No.</b>	C1447-00
<b>description</b>	door catch L 38mm W 18mm mounting distance 26mm		



<b>Part No.</b>	700061	<b>Ref. No.</b>	C2210-02 RRC2210-02
<b>description</b>	door catch L 58mm W 20mm H 35mm mounting distance 42mm chrome-plated brass for headed units		
<b>accessories for</b>	700061		
	<b>Part No.</b>	690414	<b>Ref. No.</b> —
	handle latch L 150mm mounting distance 133mm non lockable refrigeration units G 791		

## snap locks

### universal



<b>Part No.</b>	700428	<b>Ref. No.</b>	C4038-00 RRC4038-00
<b>description</b>	snap lock L 60mm W 14mm H 30mm mounting distance 47/25mm spring thickness 1mm complete with door catch zamak		



<b>Part No.</b>	690903	<b>Ref. No.</b>	C8110-00
<b>description</b>	snap lock L 69mm W 13mm H 20mm mounting distance 57mm complete with door catch nickel-plated brass		

## espagnolette locks

### universal



<b>Part No.</b>	690041	<b>Ref. No.</b>	HC-027
<b>description</b>	cam L 148mm mounting distance 32mm		



<b>Part No.</b>	690040	<b>Ref. No.</b>	HC-029 RRHC-029
<b>description</b>	door catch with roller H 42mm L 40mm W 40mm zinc die cast mounting distance 26mm type 0751 series		



## pullouts

### rollers

#### rollers



1

<b>Part No.</b>	690692	<b>Ref. No.</b>	C2418-00 RRC2418-00
<b>description</b>	roller rollerø 55mm B1 10mm overall width 14mm A 55mm B 10mm C 14mm SS bore ø 12mm		

## equipment feet and end caps

### equipment feet

#### with screw mounting



1

<b>Part No.</b>	701092	<b>Ref. No.</b>	C2407-00
<b>description</b>	equipment foot tube ø 50mm thread M10 thread L 23mm H 113/160mm SS Qty 1 pcs		

### bullet feet

#### plastic



1

<b>Part No.</b>	700108	<b>Ref. No.</b>	C1446-00 RRC1446-00
<b>description</b>	equipment foot pipe type 40x40 thickness 1-1.2mm H 17-55mm plastic Qty 1 pcs		
<b>spare parts for</b>	700108		
	<b>Part No.</b>	511512	<b>Ref. No.</b> —
	O-ring EPDM thickness 2.62mm ID ø 18.72mm Qty 10 pcs		

## gaskets

### gaskets for heated units

#### window seals

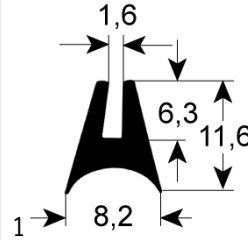

<b>Part No.</b>	901315	<b>Ref. No.</b>	C7572-00
<b>description</b>	window gasket profile 1577 L 1420mm Qty 1		

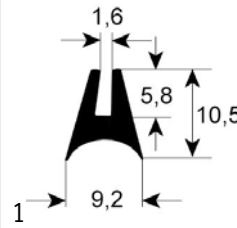

<b>Part No.</b>	900416	<b>Ref. No.</b>	C5214-00 C5218-00 C5223-00 RRC5214-00 RRC5218-00 RRC5223-00
<b>description</b>	window gasket profile 1580 L 1800mm Qty 1 mounting pos. inner		
<b>For models:</b>	MDP-6G		

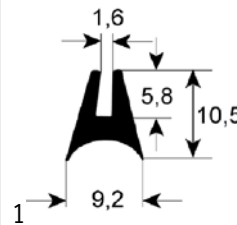

<b>Part No.</b>	900419	<b>Ref. No.</b>	C5219-00 RRC5219-00
<b>description</b>	window gasket profile 1580 L 2500mm Qty 1 mounting pos. inner		

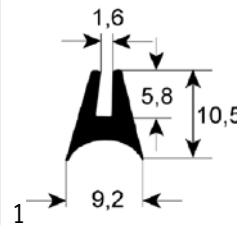

<b>Part No.</b>	900427	<b>Ref. No.</b>	C6515-00 RRC6515-00
<b>description</b>	window gasket profile 1580 L 2900mm Qty 1 mounting pos. inner		



<b>Part No.</b>	900797	<b>Ref. No.</b>	C5216-00 C5227-00 RRC5216-00 RRC5227-00
<b>description</b>	window gasket profile 1580 L 450mm Qty 1		
<b>For models:</b>	MDP-6G		

<b>Part No.</b>	900827	<b>Ref. No.</b>	C5247-00 RRC5247-00
<b>description</b>	window gasket profile 1580 L 990mm Qty 1		

<b>Part No.</b>	900426	<b>Ref. No.</b>	C6513-00 RRC6513-00
<b>description</b>	window gasket profile 1885 L 2300mm Qty 1		

<b>Part No.</b>	900828	<b>Ref. No.</b>	C5572-00 RRC5572-00
<b>description</b>	window gasket profile 1885 L 2430mm Qty 1		

<b>Part No.</b>	900430	<b>Ref. No.</b>	C7117-00 RRC7117-00
<b>description</b>	window gasket profile 1885 L 3250mm Qty 1		

<b>Part No.</b>	900826	<b>Ref. No.</b>	C6516-00 RRC6516-00
<b>description</b>	window gasket profile 1886 L 600mm Qty 1 external size mounting pos. horizontal		

<b>Part No.</b>	900825	<b>Ref. No.</b>	C6517-00 RRC6517-00
<b>description</b>	window gasket profile 1886 L 800mm Qty 1 external size mounting pos. vertical		

<b>Part No.</b>	900425	<b>Ref. No.</b>	C6512-00 RRC6512-00
<b>description</b>	window gasket profile 1890 L 2370mm Qty 1 mounting pos. outer		

<b>Part No.</b>	900429	<b>Ref. No.</b>	C7121-01 RRC7121-01
<b>description</b>	window gasket profile 1890 L 3500mm Qty 1 mounting pos. outer		

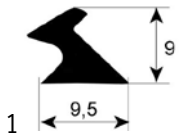

<b>Part No.</b>	900415	<b>Ref. No.</b>	C5209-00 RRC5209-00
<b>description</b>	window gasket profile 1895 L 3000mm Qty 1 mounting pos. outer		

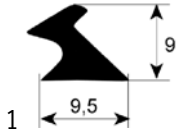

<b>Part No.</b>	900421	<b>Ref. No.</b>	C5735-00 RRC5735-00
<b>description</b>	window gasket profile 1895 L 3000mm Qty 1 mounting pos. outer		

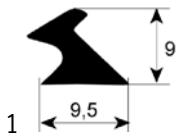

<b>Part No.</b>	900423	<b>Ref. No.</b>	C5736-00 RRC5736-00
<b>description</b>	window gasket profile 1895 L 3500mm Qty 1 mounting pos. outer		

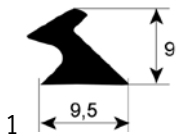

<b>Part No.</b>	900824	<b>Ref. No.</b>	C5211-00 RRC5211-00
<b>description</b>	window gasket profile 1895 L 3570mm Qty 1 mounting pos. inner		

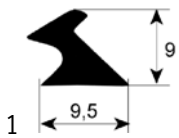

<b>Part No.</b>	900418	<b>Ref. No.</b>	C5217-00 RRC5217-00
<b>description</b>	window gasket profile 1895 L 3700mm Qty 1 mounting pos. outer		

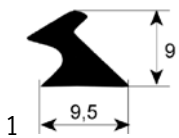

<b>Part No.</b>	900431	<b>Ref. No.</b>	C7116-00 RRC7116-00
<b>description</b>	window gasket profile 1895 L 4600mm Qty 1 mounting pos. inner		

## door seals

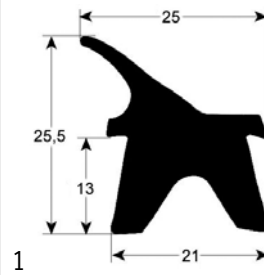

<b>Part No.</b>	900348	<b>Ref. No.</b>	C2215-03
<b>description</b>	door seal profile 2402 Qty supplied by meter		

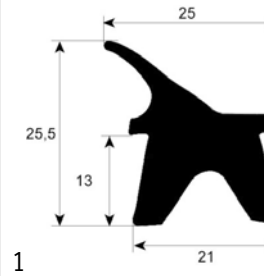

<b>Part No.</b>	900414	<b>Ref. No.</b>	C2215-06 RRC2215-06
<b>description</b>	door seal profile 2402 W 385mm L 425mm external size Qty 1		

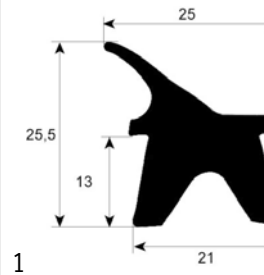

<b>Part No.</b>	901541	<b>Ref. No.</b>	C2215-04
<b>description</b>	door seal profile 2402 W 430mm L 665mm external size Qty 1 suitable for INOXTREND 4-piece		

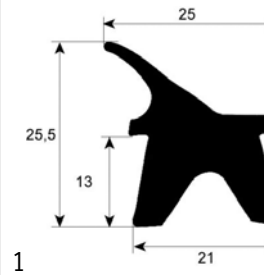

<b>Part No.</b>	901311	<b>Ref. No.</b>	C2215-01 RRC2215-01
<b>description</b>	door seal profile 2402 W 555mm L 395mm plug size Qty 1 4-piece		
<b>For models:</b>	CVE 6-E		

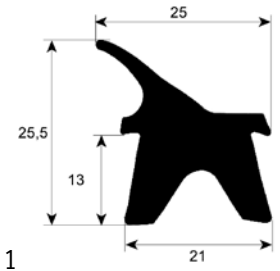

<b>Part No.</b>	901129	<b>Ref. No.</b>	C2215-02 RRC2215-02
<b>description</b>	door seal profile 2402 W 580mm L 765mm Qty 1 4-piece		

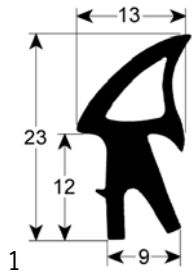

<b>Part No.</b>	901540	<b>Ref. No.</b>	C7625-00
<b>description</b>	door seal profile 2458 L 2225mm Qty 1 suitable for INOXTREND		

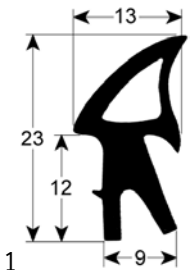

<b>Part No.</b>	900412	<b>Ref. No.</b>	C6013-00 RRC6013-00
<b>description</b>	door seal profile 2458 L 1400mm Qty 1		

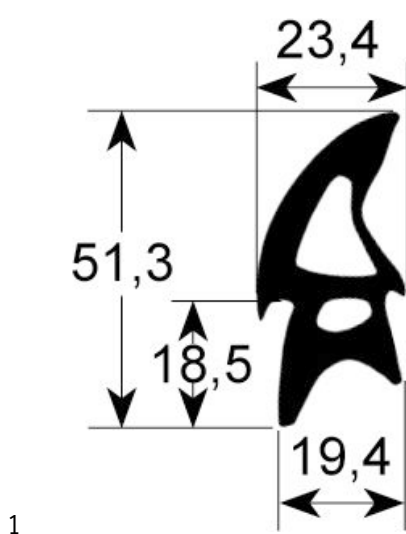

<b>Part No.</b>	900432	<b>Ref. No.</b>	C7115-00 RRC7115-00
<b>description</b>	door seal profile 2460 L 4560mm Qty 1		

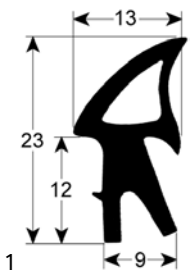

<b>Part No.</b>	900413	<b>Ref. No.</b>	C6090-00 RRC6090-00
<b>description</b>	door seal profile 2458 L 1400mm Qty 1		

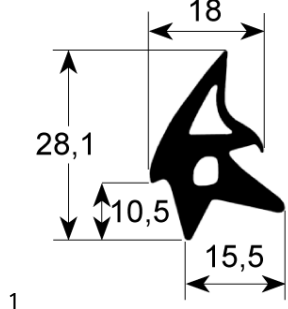

<b>Part No.</b>	901384	<b>Ref. No.</b>	C9031-00 RRC9031-00
<b>description</b>	door seal profile 2470 L 2100mm Qty 1		

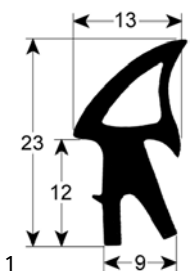

<b>Part No.</b>	901449	<b>Ref. No.</b>	C7562-00 RRC7562-00
<b>description</b>	door seal profile 2458 L 1600mm		

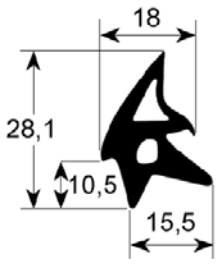

1

<b>Part No.</b>	900417	<b>Ref. No.</b>	C5220-00 RRC5220-00
<b>description</b>	door seal profile 2470 L 2300mm Qty 1		
<b>For models:</b>	MDP-6G		

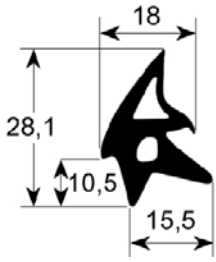

1

<b>Part No.</b>	900422	<b>Ref. No.</b>	C5737-00 RRC5737-00
<b>description</b>	door seal profile 2470 L 2630mm Qty 1		

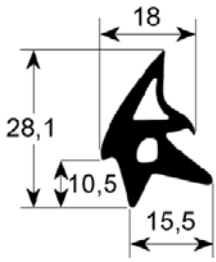

1

<b>Part No.</b>	900420	<b>Ref. No.</b>	C5221-00 RRC5221-00
<b>description</b>	door seal profile 2470 L 2850mm Qty 1		

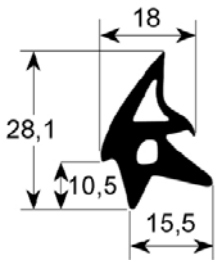

1

<b>Part No.</b>	900424	<b>Ref. No.</b>	C5738-00 RRC5738-00
<b>description</b>	door seal profile 2470 L 3250mm Qty 1		

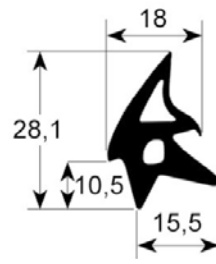

1

<b>Part No.</b>	900428	<b>Ref. No.</b>	C6510-00 RRC6510-00
<b>description</b>	door seal profile 2470 L 3600mm Qty 1		

door seals with fixing hook

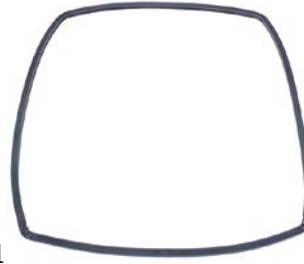

1

<b>Part No.</b>	901310	<b>Ref. No.</b>	C1608 -00
<b>description</b>	door seal L 330mm W 450mm with 4 mounting clips external size		

special gaskets

sealing discs



1

<b>Part No.</b>	901539	<b>Ref. No.</b>	C9032-00
<b>description</b>	gasket ø 16mm thickness 2.7mm rubber Qty 1 pcs		

hose reels and spray guns

spray guns



1

<b>Part No.</b>	549332	<b>Ref. No.</b>	C2380-00
<b>description</b>	spray gun for appliances 1/2" IT L 215mm type ZANUSSI		
<b>accessories for</b>	549332		



<b>Part No.</b>	520168	<b>Ref. No.</b>	—
<b>description</b>	double nipple nickel-plated brass thread 1/2" - 1/2" Qty 1 pcs		



## hoses

### for dishwashers

#### miscellaneous



<b>Part No.</b>	511467	<b>Ref. No.</b>	C2181-00
<b>description</b>	pressure hose L 1000mm		

## fittings, hose and pipe connectors

### fittings

#### T-pieces

#### nickel-plated brass



<b>Part No.</b>	520812	<b>Ref. No.</b>	HR-040
<b>description</b>	T-piece thread 1/8" ET - 1/8" IT - 1/8" IT nickel-plated brass L 37mm		

### hose connectors

#### producer-specific



<b>Part No.</b>	520336	<b>Ref. No.</b>	HR-598 RRHR-598
<b>description</b>	hose connector thread 1/4" grommet ø 12mm ID ø 8mm grommet length 19mm WS 14 total length 35mm thread L 10mm		



<b>Part No.</b>	520337	<b>Ref. No.</b>	HR-595 RRHR-595
<b>description</b>	hose connector thread 1/4" grommet ø 7mm ID ø 4.5mm grommet length 19mm WS 14 total length 35mm thread L 10mm		

## valves and tank inlets

### ball valves

#### ball valves electric



<b>Part No.</b>	401085	<b>Ref. No.</b>	LC-500 RRLC-500
<b>description</b>	ball valve inlet 1/2" IT outlet 1/2" IT 230V L 60mm 50/60Hz closed off-current mode of operation electric connection cable 400mm cable 3-pole		

## water cycle components

### pressure reduction valves

#### pressure reduction valves

#### producer-specific



<b>Part No.</b>	520329	<b>Ref. No.</b>	C2090-00 RRC2090-00
<b>description</b>	pressure reduction valve connection 1/2" brass		
<b>For models:</b>	MDP-6G		

## measuring equipment

### thermometers

#### built-in thermometers

#### ø60mm



<b>Part No.</b>	379855	<b>Ref. No.</b>	C2186-00 RRC2186-00
<b>description</b>	thermometer mounting ø 60mm t.max. 350°C +50 up to +350°C probe ø 6mm probe L 20mm capillary pipe 1030mm		
<b>For models:</b>	CE 5, CE10, CE20, CG 5, CG10, CG20, CVE 5, CVE10, CVE20, CVG 5, CVG10, CVG20		



## fastening material

## screws

## hexagonal screws



1

<b>Part No.</b>	550682	<b>Ref. No.</b>	C3069-00 RRC3069-00
<b>description</b>	hexagonal screw thread M8 thread L 20mm SS WS 13 Qty 1 pcs DIN 933 / ISO 4017		
<b>For models:</b>	MDP-6G		

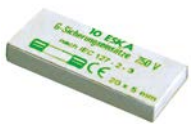
			
1			
<b>Part No.</b>	358594	<b>Ref. No.</b>	LC-426
<b>description</b>	fine fuse size ø5x20mm 0.16A slow-acting rated 250V Qty 10 pcs		

## consumables

## fuses

## fine fuses



1

<b>Part No.</b>	358532	<b>Ref. No.</b>	LC-422
<b>description</b>	fine fuse size ø5x20mm 2A fast-acting rated 250V Qty 10 pcs		

**GASTROPARTS.COM**



© 2020 Gastroparts Sp. J. All rights reserved.