



GASTROPARTS

Hobart

[EN] Cooking

[DE] Kochtechnik

[ES] Cocción

[FR] Cuisson

[IT] Cottura

[PL] Obróbka termiczna

[RU] Термическая обработка

✉ gastroparts@gastroparts.com

☎ tel. +48 56 657 00 66

📘 fb.com/gastroparts.global

GASTROPARTS.COM





heating elements

immersion heating elements


3 hole flange ø57.5mm



Part No.	418140	Ref. No.	1235430
description	heating element 7500W 230V mounting ø 57.5mm heating circuits 3 L 295mm W 34mm H 45mm number of thermostat sleeves 1 thermostat sleeves ø 7mm length thermostat sleeves 275mm thermostat sleeve not clinging hole distance 72mm hole ø 8mm connection M4 3 hole flange immersion heater		




miscellaneous






Part No.	416502	Ref. No.	322158 322158-04 322158-4 845370-01 845370-1
description	heating element 8000W 240V heating circuits 3 L 305mm W 40mm Hmm number of thermostat sleeves thermostat sleeves ømm length thermostat sleevesmm tube ø 6.3mm hole distance 44.9mm hole ø 10mm connection length 23mm connection male faston 6.3mm 4 hole flange immersion heater flange width 63.5mm flange length 63.5mm ø 40mm		
For models:	CO-0611E, CO-1011E, CO-2011E, CS-0611E, CS-0612E, CS-0612E-A, CS-1011E, CS-1012E, CS-1012E-A, CS-1022E, CS-1022E-A, CS-2011E, CS-2012E, CS-2012E-A, CS-2022E, CS-2022E-A, CSD-0611E, CSD-0612E, CSD-0612E-A, CSD-1011E, CSD-1012E, CSD-1012E-A, CSD-1022E, CSD-1022E-A, CSD-2011E, CSD-2012E, CSD-2012E-A, CSD-2022E, CSD-2022E-A		
accessories for	416502		
	Part No.	505180	Ref. No. 00-233982-001 00-276903-021 233982-1 276903-21
O-ring EPDM thickness 3.53mm ID ø 47.22mm Qty 1 pcs			


heating elements for convection






Part No.	418916	Ref. No.	845265-02 845265-1
description	heating element 12000W 240V heating circuits 3 ID ø 390mm ED ø 410mm L 410mm H 100mm H1 25mm H2 75mm thread M12x1 6 hole fixing connection male faston 6.3mm tube ø 8.5mm convection heating element		
For models:	CSL-10E, CSM-1011IE, CSM-1011N, CSM-1021IE, CSM-1021N, CSM-2021IE, CSM-2021N		
accessories for	418916		
	Part No.	101566	Ref. No. —
nut thread M12x1 H 10mm WS 19 SS Qty 1 pcs			
	Part No.	506046	Ref. No. —
flat gasket FIBER ED ø 19.5mm ID ø 13mm thickness 2mm Qty 1 pcs			
	Part No.	528622	Ref. No. —
spring ø 15.3mm L 25mm wire gauge ø 1.25mm for water filling			




Part No.	418929	Ref. No.	845265-05
description	heating element 6000W 240V heating circuits 3 ID ø 395mm ED ø 415mm L 415mm H 100mm H1 15mm H2 85mm thread M12x1 6 hole fixing connection male faston 6.3mm tube ø 8.5mm convection oven convection heating element		
For models:	CSM-2011IE, CSM-2011N		
accessories for	418929		
	Part No.	101566	Ref. No. —
nut thread M12x1 H 10mm WS 19 SS Qty 1 pcs			
	Part No.	506046	Ref. No. —
flat gasket FIBER ED ø 19.5mm ID ø 13mm thickness 2mm Qty 1 pcs			
	Part No.	528662	Ref. No. —
flat gasket copper ED ø 16mm ID ø 12mm thickness 1.5mm			


1

Part No.	418930	Ref. No.	845265-04
description	heating element 6000W 240V heating circuits 3 ID ø 430mm ED ø 450mm L 470mm H 115mm H1 43mm H2 72mm thread M12x1 6 hole fixing connection male faston 6.3mm tube ø 8.5mm convection oven convection heating element		
For models:	CSM-2011IE, CSM-2011N		
accessories for	418930		
	Part No.	101566	Ref. No. —
	nut thread M12x1 H 10mm WS 19 SS Qty 1 pcs		
	Part No.	506046	Ref. No. —
	flat gasket FIBER ED ø 19.5mm ID ø 13mm thickness 2mm Qty 1 pcs		
	Part No.	528662	Ref. No. —
	flat gasket copper ED ø 16mm ID ø 12mm thickness 1.5mm		




1

Part No.	418926	Ref. No.	845265-03
description	heating element 8000W 240V heating circuits 3 ID ø 301mm ED ø 317mm L 328mm H 95mm L1 11mm H1 12mm H2 83mm thread M12x1 6 hole fixing connection male faston 6.3mm tube ø 8.5mm convection oven convection heating element		
For models:	CSL-06E, CSM-0611IE, CSM-0611N		



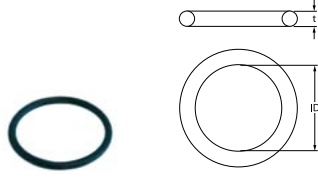
1

Part No.	418925	Ref. No.	233848-2
description	heating element 1500W 230V heating circuits 1 L 293mm W 106mm L1 32mm L2 261mm W2 83mm flange length 50mm flange width 26mm connection length 63mm connection male faston 6.3mm tube ø 8.5mm hole ø 6.2mm W1 23mm convection heating element convection oven INCOLOY windings 2		
For models:	CO-0611E, CO-1011E, CO-2011E, CS-0611E, CS-1011E, CS-2011E, CSD-0611E, CSD-1011E, CSD-2011E		
accessories for	418925		
	Part No.	520588	Ref. No. —
	gasket L 46mm W 22mm hole distance 24.5mm silicone for heating element		

accessories

sealing washers

O-rings




1

Part No.	510409	Ref. No.	00-276903-053 00-67500-016 00-67500-118 276903-53 670500-118 67500-16
description	O-ring EPDM thickness 5.34mm ID ø 56.52mm Qty 1 pcs		
For models:	CR-F, CX, ECW, EWB-S, FTN, FTT, FTX, FUX, ML-104674, ML-104683, ML-104686, UW-135, UW-135H, UWX, UX-60, UX-60B, UX-60E, UX-60EB, UX-60EH, UX-60EHB, UX-60H, UX-60HB, UXT, UXTH, UXTHL, UXTHLS, UXTHS, UXTL, UXTLH, UXTLHS, UXTLS, UXTS, V1401		

energy regulators

EGO

1-circuit




1

Part No.	380015	Ref. No.	301200 T301200
description	energy regulator 230V 13A single-circuit turn direction right shaft ø 6x4.6mm shaft L 23mm mounting thread M4 power release 6-100% no. 50.57021.010		

thermostats

bi-metal thermostats

bi-metal thermostats



1

Part No.	390504	Ref. No.	236052 E236052
description	bi-metal thermostat hole distance 23.8mm switch-off temp. 90°C 1NO 1-pole 16A 250V connection F6.3 2 hole fixing probe ø 16mm		



control and safety thermostats

EGO

safety thermostats

55.32_ series



Part No.	375984	Ref. No.	301061 T301061
description	safety thermostat switch-off temp. 225°C 3-pole 3NC 20A probe ø 6mm probe L 94mm capillary pipe 900mm capillary pipe isolated 670mm gland nut M10x1 probe SS		

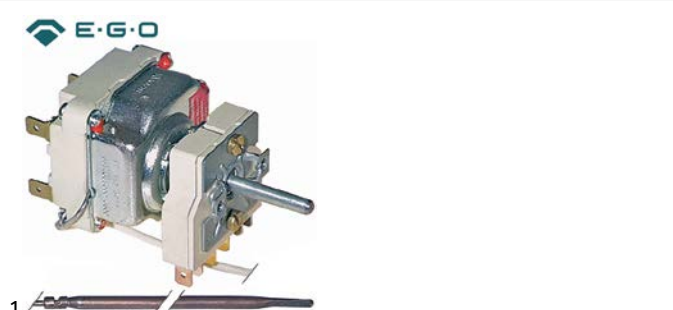
56._ series



Part No.	375442	Ref. No.	301066
description	safety thermostat capillary pipe 1760mm probe ø 4mm 1-pole probe L 100mm 16A capillary pipe isolated 1600mm gland nut switch-off temp. 320°C probe M10x1		
accessories for	375442		
	Part No.	101860	Ref. No. —
	nut thread M10x1 H 4mm WS 14 chrome-plated brass Qty 1 pcs		

control thermostats with operation switch

55.34_ series



Part No.	375246	Ref. No.	301034 T301034
description	thermostat t.max. 645°C temperature range 100-615/645°C 2-pole 2NO 16A probe ø 4mm probe L 230mm capillary pipe 1100mm capillary pipe isolated 600mm gland nut shaft ø 6x4.6mm shaft L 25mm shaft position lower rotation 270° outer switch 2NO probe material copper		

IMIT / TEMPOMATIC / ARATHERMO

control thermostats



Part No.	375847	Ref. No.	E929044
description	thermostat t.max. 90°C temperature range 0-90°C 1-pole 1CO 15A probe ø 6.5mm probe L 100mm capillary pipe 1500mm capillary pipe isolatedmm gland nut shaft ø 6x4.6mm shaft L 18mm shaft position +135° rotation 270° 250V		

COTHERM



Part No.	390440	Ref. No.	154344 492105
description	safety thermostat t.max. 220°C temperature range°C 1-pole 1NC 25A probe ø 3mm probe L 130mm capillary pipe 1720mm capillary pipe isolatedmm gland nut switch-off temp. 220°C probe SS		
For models:	CS-0612E-A, CSD-0612E-A, CSD-0612ET, CSD-0612-UC, CSD-1012ET, CSD-1012-UC, CSD-1013G, CSD-1022-UC, CSD-2012ET, CSD-2012-UC, CSD-2013G, CSD-2022-UC, CSL-0423E, CSL-0423EK, CSL-0523E, CSL-0523EK, CSL-06E, CSL-10E, CSL-423E, CSL-423K, CSM-0611IE, CSM-0611N, CSM-1011IE, CSM-1011N, CSM-1021IE, CSM-1021N, CSM-2011IE, CSM-2011N, CSM-2021IE, CSM-2021N		

accessories

connecting bows



Part No.	550060	Ref. No.	300177 T300177
description	connecting bow long for thermostat Qty 1 pcs		




switches and momentary switches

rocker/momentary rocker switches

30x22mm



1

Part No.	301003	Ref. No.	15243565 F15243565
description	rocker switch mounting measurements 30x22mm green 2NO 250V 16A illuminated 0-I connection male faston 6.3mm ambient temperature max. 125/55°C protection IP65		
accessories for	301003		
	Part No.	301036	Ref. No. —
	protective cover internal size 30x22mm for rocker switch mounting measurementsmm		

system switches (ROLD)



1


Part No.	345606	Ref. No.	139321-455 E226071
description	momentary switch unit 2CO 250V 16A connection male faston 6.3mm		
For models:	CLG-25		

cam switches

operation switches



1

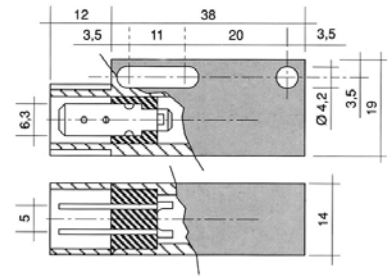
Part No.	300080	Ref. No.	491175
description	cam switch 2 operating positions 4NO 16A sequence 0-1 shaft ϕ 6x4.6mm shaft L 23mm connection screw operation switch ceramic ambient temperature max. 150°C		
accessories for	300080		
	Part No.	551456	Ref. No. —
	gasket for switch ED ϕ 14mm ID ϕ 2.5mm thickness 3.5mm white		


magnetic switches

50x19mm



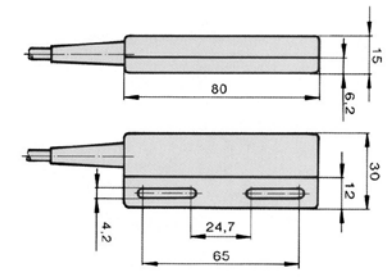
1



Part No.	345821	Ref. No.	775491-1
description	magnetic switch L 50mm W 19mm 1NO 250V 1A P max. 50W connection male faston 6.3mm		
For models:	AM-700, AM900, AMS900, AMX, AMX-900, AMX-E, AMX-ER, AMX-R, AMXR-900, AMXS-900, AMXX-1300, AMXXR-1300, AMXXS-1300, AMXXT, AUX, AUX-E, AUX-ER, AUX-R, AUXX-1300, AUXXL, AUXXR-1300, AUXXS-1300, AUXXT, CNA, CNR, ECOMAX-650, ECOMAX-700, FX, GX, UX-30, UX-30B, UX-30E, UX-30EB, UX-30EH, UX-30ES, UX-30ESB, UX-30ESH, UX-30H, UX-30-McDonalds, UX-30S, UX-30SB, UX-30SH, UXD-30		
accessories for	345821		
	Part No.	519049	Ref. No. —
	magnet ϕ mm L 63mm H 10.7mm W 18.8mm hole distance 52mm M2 hole ϕ 2mm		

80x30mm

1



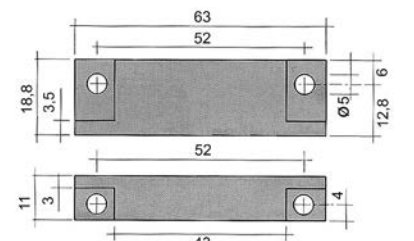
Part No.	345919	Ref. No.	297980-3
description	magnetic switch L 80mm W 30mm connection cable		
For models:	HX, HX-30E, HX-30ES, HX-40E, HX-40ES, HX-E, HX-ES, HX-S		

accessories

magnets



1



Part No.	345336	Ref. No.	E926014
description	magnet ϕ 4.8mm L 63mm H 11mm W 18.8mm hole distance 51mm M4		



lamps

indicator lights

indicator lights 2-piece (lens and indicator lamp)

indicator light lenses

ø12mm (type SDY-3)



1

Part No.	359262	Ref. No.	E926114
description	indicator light housings mounting measurements ø12mm green round Qty 1 pcs		

indicator lamps for socket type SRZ / SDK / SDY / SFK



1

Part No.	359130	Ref. No.	216006 E216006
description	indicator lamp 230V clear connection male faston 6.3mm ø 8mm		

screw-on/push-on fit

halogen lamp

for socket G4 / G6.35 / G9



1

Part No.	357193	Ref. No.	1235342
description	halogen lamp socket G4 12V 20W temp.-resist. 300°C OSRAM HALOSTAR OVEN		



1

Part No.	359599	Ref. No.	01-235542 844952
description	halogen lamp socket G4 12V 20W temp.-resist. 500°C		

fluorescent lamps

fluorescent lamps

G23



1

Part No.	359933	Ref. No.	371120-399 491761-001 491761-1
description	fluorescent lamp socket G23 L 237mm 11W 230V		

oven lamps

lamps

halogen lamps

for socket G4 / G6.35 / G9



1

Part No.	357193	Ref. No.	1235342
description	halogen lamp socket G4 12V 20W temp.-resist. 300°C OSRAM HALOSTAR OVEN		



1

Part No.	359599	Ref. No.	01-235542 844952
description	halogen lamp socket G4 12V 20W temp.-resist. 500°C		

alarm devices

buzzers



1

Part No.	350050	Ref. No.	173864
description	buzzer 230VAC connection male faston 6.3mm screw mounting thread M4 60dB		
For models:	CO-0611E, CO-0612E, CO-1011E, CO-1012E, CO-2011E, CS-0423E, CS-0423EK, CS-0523E, CS-0523EK, CS-0611E, CS-0612E, CS-1011E, CS-1012E, CS-2011E, CS-2012E, CS-2022E, CS-423E, CS-423K, CSD-0611E, CSD-0612E, CSD-1011E, CSD-1012E, CSD-2011E, CSD-2012E, CSD-2022E, CSL-06E, CSL-10E, CSM-0611E, CSM-0611N, CSM-1011E, CSM-1011N, CSM-1021E, CSM-1021N, CSM-2011E, CSM-2011N, CSM-2021E, CSM-2021N		

contactors

GENERAL ELECTRIC (AEG)

power contactors



1

Part No.	380239	Ref. No.	00-695507-001
description	power contactor resistive load 20A 230VAC (AC3/400V) 8.4A/4kW main contacts 3NO auxiliary contacts 1NC connection screw connection type LS05 01A type AEG LS05 01A type GE MC1A 301A		



SIEMENS

power contactors



1

Part No.	380389	Ref. No.	E229037
description	power contactor resistive load 22A 230VAC (AC3/400V) 9A/4kW main contacts 3NO auxiliary contacts 1NO connection screw connection type 3RT10-16-1AP01		



1

Part No.	380957	Ref. No.	E927160
description	power contactor resistive load 22A 24VAC (AC3/400V) 12A/5.5kW main contacts 3NO auxiliary contacts 1NO connection screw connection type 3RT10-17-1AB01 50/60Hz		

TELEMECANIQUE (Schneider Electric)

power contactors



1

Part No.	380820	Ref. No.	00-695527-002
description	power contactor resistive load 25A 230VAC (AC3/400V) 9A/4kW main contacts 3NO auxiliary contacts 1NO/1NC connection screw connection type LC1D0900M7		



1

Part No.	380976	Ref. No.	296926-2
description	power contactor resistive load 32A 230VAC (AC3/400V) 18A/7.5kW main contacts 3NO auxiliary contacts 1NO/1NC connection screw connection		

relays

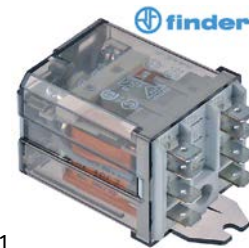
power relays

with bracket mounting



1

Part No.	380312	Ref. No.	00-139321-354 229023
description	power relays FINDER 230VAC 10A 3CO connection male faston 4.8mm bracket mounting dimensions 52x32.2x36.5mm manuf. no. 60.63.8.230.0000		



1

Part No.	380139	Ref. No.	929115
description	power relays FINDER 230VAC 16A 2CO connection F6.3 bracket mounting dimensions 68x38.2x35.8mm manuf. no. 62.82.8.230.0000		



1

Part No.	380403	Ref. No.	900073
description	power relays FINDER 230VAC 16A 3CO connection F6.3 bracket mounting manuf. no. 62.83.8.230.0500		



1

Part No.	380702	Ref. No.	139321-528
description	power relays FINDER 230VAC 16A 3NO connection male faston 6.3mm flange dimensions 36x38x68mm manuf. no. 62.83.8.230.0300 230V		



1

Part No.	380185	Ref. No.	139321-686 371450-010
description	power relays Italiana Relè 230VAC 30A 1NO connection F6.3 bracket mounting dimensions 36.5x32.2x51.8mm manuf. no. A10-230AC-FA		
For models:	CHH-50, CHH-60D, EH-60		


electronic controllers

LOREME

analogue



1

Part No.	379745	Ref. No.	480978 845246 845379-1
description	electronic controller kit LOREME type Dsl 94 mounting measurements 66x32mm 230V voltage AC TC/J 0-250°C display without display relay outputs 2 front measurements 70x34mm built-in depth 95mm cable length 2530mm probe L 20mm probe ø 4mm with probe and fastening material		
For models:	CSL-06E, CSL-10E, CSM-0611IE, CSM-0611N, CSM-1011IE, CSM-1011N, CSM-1021IE, CSM-1021N, CSM-2011IE, CSM-2011N, CSM-2021IE, CSM-2021N		
spare parts for	379745		
	Part No.	379744	Ref. No. 480974
description	electronic controller LOREME type Dsl 94 mounting measurements 66x32mm 230V voltage AC TC/J 0-250°C display without display relay outputs 2 front measurements 70x34mm built-in depth 95mm		

electronics

PCBs



1

Part No.	403041	Ref. No.	00-895401-016 895401-16
description	PCB cable length 220mm with relay		
For models:	CSD-0612-UC, CSD-1012-UC, CSD-1022-UC, CSD-2012-UC, CSD-2022-UC		

solenoïd valves


solenoïd valves (water)

ELBI

straight



1

Part No.	373017	Ref. No.	371450-021
description	solenoid valve single straight 230VAC inlet 3/4" outlet 11.5mm DN10 ELBI		
spare parts for	373017		
	Part No.	370467	Ref. No. —
description	solenoid valve filter suitable for ELBI		

spare parts and accessories

reducers

outlet side














1










Part No.	371260	Ref. No.	E133009
description	reducer type ELBI flow rate 0.5l/min pressure range 0 up to 10bar tolerance ±15/25% red		



MÜLLER

medium temperature: 90°C
duty cycle: 100%

			
1			
Part No.	370003	Ref. No.	324208-4
description	solenoid valve double angled 230VAC inlet 3/4" outlet 14.5mm DN10 t.max. 90°C duty cycle 100% MÜLLER		
For models:	FX		
spare parts for	370003		
	Part No.	370128	Ref. No. —
	solenoid valve body double angled inlet 3/4" outlet 14.5mm DN10 t.max. 90°C duty cycle 100% MÜLLER 230V double-ways		
	Part No.	371002	Ref. No. —
	solenoid valve holder MÜLLER flange support		
	Part No.	371009	Ref. No. —
	compression spring for solenoid coil		
	Part No.	371011	Ref. No. —
	spare parts kit membrane with long star star hight 8mm MÜLLER		
	Part No.	371017	Ref. No. —
	solenoid coil MÜLLER 230VAC connection male faston 6.3mm		
	Part No.	371122	Ref. No. —
	solenoid valve filter ø 19mm H 10mm suitable for MÜLLER		
	Part No.	501161	Ref. No. —
	tap head for solenoid valve holder for solenoid coils		
accessories for	370003		
	Part No.	371010	Ref. No. —
	solenoid coil 230VAC connection with cable cable length 2000mm		
	Part No.	371037	Ref. No. —
	solenoid coil 24VAC 50/60Hz connection male faston 6.3mm		
	Part No.	371038	Ref. No. —
	solenoid coil 230VAC connection appliance plug		

			
1			
Part No.	370001	Ref. No.	324207-1
description	solenoid valve single angled 230VAC inlet 3/4" outlet 14.5mm DN10 t.max. 90°C duty cycle 100% MÜLLER		
For models:	AM3, AMX, AMX-E, AMX-ER, AMX-R, AUX, AUX_, AUX-E, AUX-ER, AUX-R, FE, FX, GX, HE, HE-P, HX, HX-30, HX-30E, HX-40, HX-40E, HX-60-EHL, HX-E, HX-ES, HX-S, UX-30, UX-30B, UX-30E, UX-30EB, UX-30EH, UX-30H, UX-30-McDonalds, UX-60, UX-60B, UX-60E, UX-60EB, UX-60EH, UX-60EHB, UX-60H, UX-60HB, UXD-30		
spare parts for	370001		
	Part No.	370126	Ref. No. —
	solenoid valve body single angled inlet 3/4" outlet 14.5mm DN10 t.max. 90°C duty cycle 100% MÜLLER plastic		
	Part No.	371002	Ref. No. —
	solenoid valve holder MÜLLER flange support		
	Part No.	371009	Ref. No. —
	compression spring for solenoid coil		
	Part No.	371011	Ref. No. —
	spare parts kit membrane with long star star hight 8mm MÜLLER		
	Part No.	371017	Ref. No. —
	solenoid coil MÜLLER 230VAC connection male faston 6.3mm		
	Part No.	371122	Ref. No. —
	solenoid valve filter ø 19mm H 10mm suitable for MÜLLER		
accessories for	370001		
	Part No.	371010	Ref. No. —
	solenoid coil 230VAC connection with cable cable length 2000mm		
	Part No.	371037	Ref. No. —
	solenoid coil 24VAC 50/60Hz connection male faston 6.3mm		
	Part No.	371038	Ref. No. —
	solenoid coil 230VAC connection appliance plug		

TP



			
1			
Part No.	370111	Ref. No.	E927001
description	solenoid valve double straight 24VAC inlet 3/4" outlet 11.5mm DN10 TP		
spare parts for	370111		
	Part No.	371035	Ref. No. —
	solenoid coil 24VAC		

Table continues overleaf



accessories for		370111		
Part No.		371220	Ref. No.	—
	reducer TP flow rate 3l/min red tolerance ±15%			
	reducer TP flow rate 5.5l/min yellow tolerance ±15%			
	reducer TP flow rate 6l/min grey tolerance ±15%			
	reducer TP flow rate 10l/min white tolerance ±15%			
	reducer TP flow rate 12l/min bronze tolerance ±15%			
	reducer TP flow rate 16l/min light brown tolerance ±15%			
	reducer TP flow rate 20l/min red tolerance ±15%			
	reducer TP flow rate 0.25l/min red tolerance ±25%			
	reducer TP flow rate 0.35l/min violet tolerance ±25%			
	reducer TP flow rate 0.5l/min orange tolerance ±25%			
	reducer TP flow rate 0.8l/min white tolerance ±25%			
	reducer TP flow rate 1l/min light blue tolerance ±25%			
	reducer TP flow rate 1.2l/min brown tolerance ±25%			
	reducer TP flow rate 1.5l/min light brown tolerance ±25%			
	reducer TP flow rate 2.5l/min yellow tolerance ±25%			
	reducer TP flow rate 3.4l/min dark green tolerance ±25%			
	reducer TP flow rate 5l/min black tolerance ±25%			
	reducer TP flow rate 8l/min blue tolerance ±20%			

solenoid valves with reducers



1	Part No.	370628	Ref. No.	00-139321-65
	description	solenoid valve double straight 230VAC inlet 3/4" input 16l/min DN10 TP plastic outlet 11.5mm		



1	Part No.	370245	Ref. No.	E927242
	description	solenoid valve single straight 24VAC inlet 3/4" outlet 11.5mm input 16l/min t.max. 90°C TP plastic flow regulating valve inlet light brown		

metal

ASCO

spare parts and accessories

kits




1	Part No.	371110	Ref. No.	173863-11
	description	valve insert type A size 1/2" service kit		
	For models:	2226, 2227, AM-12E, AM-12EC, AM-12EF, AM-12ER, AM-600, AM-600C, AM-600CR, AM-600R		

fans

axial fans

import




1	Part No.	601080 ¹	Ref. No.	00-230324-001	
	description	axial fan L 119mm W 119mm H 38mm 230VAC 50/60Hz 23/20W bearing ball bearing connection male faston 2.8mm metal ADDA fan wheel ø 110mm temp.-resist. 70°C			
	accessories for	601080			
		Part No.	550898	Ref. No.	—
		connecting cable cable length 2000mm connection F 2.8 connection distance 7.9mm for axial flow fan			


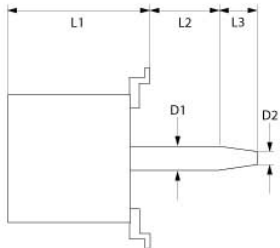
¹with ball bearings


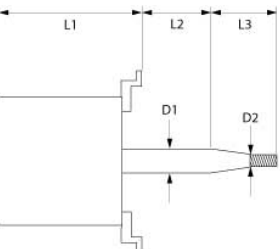

Table continues overleaf



accessories for	601080		
	Part No.	692519	Ref. No.
			—
	guard L 120mm W 120mm plastic		


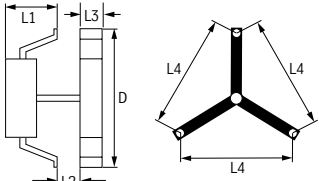

hot air motors

			
1			
Part No.	500812	Ref. No.	150443-54 233800-04
description	fan motor 220-240/380-415V 3 phase 50Hz 0.26kW 1440rpm speeds 1 D1 ø 17mm D2 ø 13.5mm		
For models:	CO-0612E, CO-1012E, CS-0612E, CS-1012E		

			
1			
Part No.	601805	Ref. No.	07426 844955-01
description	fan motor 230V 1 phase 50/60Hz 0.185kW 1400/1680rpm speeds 2 L1 130mm L2 27mm L3 37mm D1 ø 17mm D2 ø 13.5mm 1A suitable capacitor 5µF/450V Cos(fi) 0.93 type 1079GA2350		
For models:	CS-0612E, CS-1012E, CS-1022E, CS-2012E, CS-2022E, CSD-0612E, CSD-1012E, CSD-1013G, CSD-1022E, CSD-2012E, CSD-2013G, CSD-2022E, CSL-06E, CSL-10E, CSM-0611E, CSM-0611N, CSM-1011E, CSM-1011N, CSM-1021E, CSM-1021N, CSM-2011E, CSM-2011N, CSM-2021E, CSM-2021N		
accessories for	601805		
	Part No.	511605	Ref. No.
			322190-1
	shaft seal		

hot air fans

ebm-papst

	1		
			
Part No.	601807	Ref. No.	494069
description	hot air fan kit 230V 50W L1 69mm L4 87mm fan wheel ø 151mm type RRL152/0020A92-3030LH-197 ebm-papst		
For models:	CS-0423E, CS-0423EK, CS-0523E, CS-0523EK, CS-423E, CS-423K, CSL-0423E, CSL-0423EK, CSL-0523E, CSL-0523EK, CSL-423E, CSL-423K		
spare parts for	601807		
	Part No.	601808	Ref. No.
			—
	hot air fan 230/240V 50W L1 69mm L2mm L3mm L4 87mm fan wheel ø 150mm type RRL152/0020A92-3030LH-197 ebm-papst		

pumps

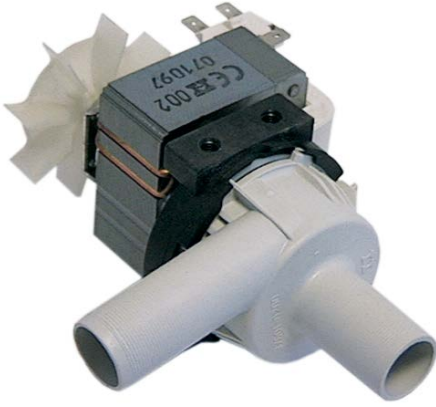
drain pumps

ASKOLL


	1		
Part No.	500346	Ref. No.	130105
description	drain pump inlet ø 30mm outlet ø 22mm 230V 40W 50Hz ASKOLL type M231 XP with holder		



HANNING



1

Part No.	500042	Ref. No.	165653-1 old version
description	drain pump 80W 230V inlet ø 24mm outlet ø 24mm 50Hz type KD22B3-679 HANNING		
spare parts for	500042		
	Part No.	510168	Ref. No. —
	fan wheel shaft intake ø 5mm ø 62mm H 14mm		

booster pumps II

accessories



1

Part No.	365017	Ref. No.	00-226568-009 01-235398 01-235399 139321-941 226568-9
description	operating capacitor capacity 5µF 450V tolerance 5% 50/60Hz ambient temperature max. -25 to +85°C ø 28mm L 54mm M8 plastic connection male faston 6.3mm 16.10.08 protection		
For models:	AMX, AMX-900, AMX-E, AMX-ER, AMX-R, AMXR-900, AMXS-900, AMXX-1300, AMXXR-1300, AMXXS-1300, AMXXT, AUX, AUX_, AUX-E, AUX-ER, AUX-R, AUXX-1300, AUXXL, AUXXR-1300, AUXXS-1300, AUXXT, CHH-70D, ECOMAX-402, ECOMAX-650, ECOMAX-700, EH-70, FE, FE-W, FX, GX, HX-30, HX-30E, HX-30ES, HX-30S, HX-40, HX-40E, HX-40ES, HX-40S, UX, UX-30, UX-30B, UX-30E, UX-30EB, UX-30EH, UX-30ES, UX-30ESB, UX-30H, UX-30-McDonalds, UX-30S, UX-30SB... (Other models you can see in the webshop)		



1

Part No.	365012	Ref. No.	206009
description	operating capacitor capacity 6.3µF 450V tolerance 5% 50Hz ambient temperature max. -25 to +85°C ø 30mm L 61mm M8 plastic connection male faston 6.3mm protection		

condensators & interference suppression filters

operating capacitors

plastic



1


Part No.	365165	Ref. No.	226568-008 226568-8
description	capacitor capacity 12.5µF 450V tolerance 5% 50Hz ambient temperature max. -25 to +85°C ø 35mm L 60mm M8 plastic connection male faston 6.3mm protection		
For models:	FE, FE-W, FX, GX, HE, HE600-HL, HE-P, HX, HX-30, HX-30E, HX-30ES, HX-30S, HX-40, HX-40E, HX-40ES, HX-40S, HX-60-EHL, HX-E, HX-ES, HX-S		




1


Part No.	365167	Ref. No.	226568-3
description	capacitor capacity 6µF 450V tolerance 5% 50Hz ambient temperature max. -25 to +85°C ø 30mm L 58mm M8 plastic connection male faston 6.3mm		
For models:	FE, G10R, G5R, HE-P, HX, HX-60-EHL, HX-E, HX-ES, HX-S, UX-30, UX-30B, UX-30E, UX-30EB, UX-30EH, UX-30ES, UX-30ESB, UX-30ESH, UX-30H, UX-30-McDonalds, UX-30S, UX-30SB, UX-30SH, UX-60, UX-60B, UX-60E, UX-60EB, UX-60EH, UX-60EHB, UX-60H, UX-60HB		




 <p>1</p>			
Part No.	365021	Ref. No.	00-226568-013 139321-448 139321-884 226568-13
description	operating capacitor capacity 16µF 425V tolerance 5% 50/60Hz ambient temperature max. -25 to +85°C ø 35mm L 73mm single M8 plastic connection male faston 6.3mm 416.10.99 protection		
For models:	AM-700, AM900, AM900-10N, AM900-90, AMS900, AMS900-10N, AMX, AMX-10HL, AMX-90, AMX-900, AMXR, AMXR-900, AMXS, AMXS-900, AMXT, AMXTS, CHF45, ECOMAX-600, ECOMAX-612-10, ECOMAX-612S-10, ECOMAX-650, EF-40		


 <p>1</p>			
Part No.	365013	Ref. No.	00-226568-014 00-226568-017 226568-14 226568-17
description	operating capacitor capacity 8µF 400V tolerance 5%Hz ambient temperature max. -25 to +85°C ø 31.5mm L 55mm M8 plastic connection male faston 6.3mm protection		
For models:	FP, FX, FX-McDonalds, GP, GX		


 <p>2</p>			
Part No.	365017	Ref. No.	00-226568-009 01-235398 01-235399 139321-941 226568-9
description	operating capacitor capacity 5µF 450V tolerance 5% 50/60Hz ambient temperature max. -25 to +85°C ø 28mm L 54mm M8 plastic connection male faston 6.3mm 16.10.08 protection		
For models:	AMX, AMX-900, AMX-E, AMX-ER, AMX-R, AMXR-900, AMXS-900, AMXX-1300, AMXXR-1300, AMXXS-1300, AMXXT, AUX, AUX_, AUX-E, AUX-ER, AUX-R, AUXX-1300, AUXXL, AUXXR-1300, AUXXS-1300, AUXXT, CHH-70D, ECOMAX-402, ECOMAX-650, ECOMAX-700, EH-70, FE, FE-W, FX, GX, HX-30, HX-30E, HX-30ES, HX-30S, HX-40, HX-40E, HX-40ES, HX-40S, UX, UX-30, UX-30B, UX-30E, UX-30EB, UX-30EH, UX-30ES, UX-30ESB, UX-30H, UX-30-McDonalds, UX-30S, UX-30SB... (Other models you can see in the webshop)		

<p>metal</p>  <p>1</p>			
Part No.	365139	Ref. No.	206002
description	operating capacitor capacity 10µF 450V tolerance 5% 60Hz ambient temperature max. -25 up to +70°C ø 40mm L 83mm M8 aluminium connection male faston 6.3mm C.87.8BF2 MKP protection		


<p>filters</p>			
<p>interference suppression filters</p>			
 <p>1</p>			
Part No.	365044	Ref. No.	926144 E926144
description	interference suppression filter type FC701Y2F 250V 50-60Hz conductor 2 with E connection cable 200mm L 42mm ø 23mm Hmm Wmm plastic Qty 1 pcs		


 <p>1</p>			
Part No.	365012	Ref. No.	206009
description	operating capacitor capacity 6.3µF 450V tolerance 5% 50Hz ambient temperature max. -25 to +85°C ø 30mm L 61mm M8 plastic connection male faston 6.3mm protection		


<p>fuses</p>			
<p>fine fuses</p>			
 <p>1</p>			
Part No.	358666	Ref. No.	926283 E926283
description	fine fuse size ø5x20mm 0.315A fast-acting rated 250V Qty 10 pcs		


 <p>1</p>			
Part No.	358530	Ref. No.	139321-902
description	fine fuse size ø5x20mm 0.8A fast-acting rated 250V Qty 10 pcs		
For models:	CHH-50, CHH-60D, EH-60		



			
1			
Part No.	358677	Ref. No.	139321-690 E228004
description	fine fuse size ø5x20mm 4A fast-acting rated 250V Qty 10 pcs		
For models:	CHH-50, CHH-60D, CHH-70D, EH-60, EH-70		

			
1			
Part No.	358594	Ref. No.	228012
description	fine fuse size ø5x20mm 0.16A slow-acting rated 250V Qty 10 pcs		


			
1			
Part No.	358606	Ref. No.	228010 E228010
description	fine fuse size ø5x20mm 4A slow-acting rated 250V Qty 10 pcs		

			
1			
Part No.	358752	Ref. No.	3090506
description	fine fuse size ø6.3x32mm 10A fast-acting rated 500V Qty 10 pcs		

electric accessories

terminals

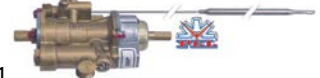













connection terminals with screw/faston connections

			
1			
Part No.	550411	Ref. No.	139321-582 774055-1
description	power terminal block 6-pole max. 40A max 450V connection ø6mm ² / F6.3 temp.-resist. 150°C cross section 6mm ²		
For models:	AMX-900, AMXS-900, AMXX-1300, AMXXT, AUXX-1300, AUXXT, CHF45, CHH-50, CHH-60D, CHH-70D, ECOMAX-650, EF-40, EH-60, EH-70, FE, FE-W, FX, GC, GC11, GC12, GC31, GC32, GC41, GC42, GX, HE, HE600-HL, HE-P, UX, UXL, UXLS, UXS, UXT, UXTH, UXTHL, UXTHLS, UXTHS, UXTL, UXTLS, UXTS		

gas thermostats

PEL


25ST series

				
1				
Part No.	101172	Ref. No.	310137 T310137	
description	gas thermostat PEL type 25ST 100-300°C gas inlet M16x1.5 (tube ø 10mm) bypass nozzle ø 0.35mm gas outlet M16x1.5 (tube ø 10/8mm) thermocouple connection M9x1 pilot connection M10x1 capillary pipe 1200mm probe ø 6mm probe L 100mm shaft ø 8x6.5mm shaft L 21/15mm shaft flat upper			
spare parts for	101172			
	Part No.	100259	Ref. No.	—
bypass nozzle type PEL22 bore ø 0.35mm thread M6x0.5				
	Part No.	101060	Ref. No.	—
magnet unit standard L 39mm D1 ø 15.4mm D2 ø 11mm suitable for PEL20-21/JUNKERS/EGA				
	Part No.	106200	Ref. No.	—
nut thread M9x1 suitable for PEL 24/25S				
accessories for	101172			
	Part No.	100908	Ref. No.	—
union screw thread M10x1 for pipe ø 4mm Qty 1 pcs				
	Part No.	100909	Ref. No.	—
union screw thread M10x1 for pipe ø 6mm Qty 1 pcs				
	Part No.	101246	Ref. No.	—
olive for pipe ø 4mm Qty 1 pcs				
	Part No.	101278	Ref. No.	—
olive for pipe ø 10mm Qty 1 pcs				
	Part No.	101286	Ref. No.	—
olive ID ø 6mm Qty 1 pcs				
	Part No.	101300	Ref. No.	—
union nut thread M16x1.5 tube ø 10mm				
	Part No.	101450	Ref. No.	—
olive for pipe ø 8mm L 12.7mm Qty 1 pcs ED ø 10mm				
	Part No.	101451	Ref. No.	—
union nut thread M16x1.5 tube ø 8mm				
	Part No.	110079	Ref. No.	—
knob dial plate gas thermostat 1-8 silver				
	Part No.	110081	Ref. No.	—
knob ø 70mm shaft ø 8x6.5mm shaft flat universal				




ignition parts

electrodes



			
1			
Part No.	100906	Ref. No.	317980 T317980
description	screw connection thread M10x1 for ignition electrode brass Qty 1 pcs WS 10		


ignition units

			
1			
Part No.	102388	Ref. No.	308488 T308488
description	ignition unit outputs 4 230VAC dimensions 111x23x34mm mounting distance 100mm inlet F6.3x0.8 outlet F2.8x0.8 type WAC-T4 0.6VA 50/60Hz		


screw connections

olives

			
1			
Part No.	100898	Ref. No.	MRTCU800183
description	olive for pipe ø 6mm Qty 1 pcs for pilot burner		
accessories for	100898		
		Part No.	100909
		Ref. No.	—
	union screw thread M10x1 for pipe ø 6mm Qty 1 pcs		

			
1			
Part No.	101857	Ref. No.	310275 T310275
description	olive for pipe ø 6mm Qty 1 pcs suitable for 160 series for pilot burner		


union screws

			
1			
Part No.	100906	Ref. No.	317980 T317980
description	screw connection thread M10x1 for ignition electrode brass Qty 1 pcs WS 10		


brewing units

filter holder gaskets

O-rings

			
1			
Part No.	510409	Ref. No.	00-276903-053 00-67500-016 00-67500-118 276903-53 670500-118 67500-16
description	O-ring EPDM thickness 5.34mm ID ø 56.52mm Qty 1 pcs		
For models:	CR-F, CX, ECW, EWB-S, FTN, FTT, FTX, FUX, ML-104674, ML-104683, ML-104686, UW-135, UW-135H, UWX, UX-60, UX-60B, UX-60E, UX-60EB, UX-60EH, UX-60EHB, UX-60H, UX-60HB, UXT, UXTH, UXTHL, UXTHLS, UXTHS, UXTL, UXTLH, UXTLHS, UXTLS, UXTS, V1401		

miscellaneous

			
1			
Part No.	698316	Ref. No.	491760
description	duct for glass plate D1 ø 10mm D2 ø 8mm rubber		
For models:	CO-0612E, CO-1012E, CS-0612E, CS-0612E-A, CS-1012E, CS-1012E-A, CS-1012G, CS-1022E, CS-1022E-A, CS-2012E, CS-2012E-A, CS-2012G, CS-2022E, CS-2022E-A, CSD-0612E, CSD-0612E-A, CSD-0612ET, CSD-0612-UC, CSD-1012E, CSD-1012E-A, CSD-1012ET, CSD-1012-UC, CSD-1013G, CSD-1022E, CSD-1022E-A, CSD-1022-UC, CSD-2012E, CSD-2012E-A, CSD-2012ET, CSD-2012-UC, CSD-2013G, CSD-2022E, CSD-2022E-A, CSD-2022-UC, CSL-0423E, CSL-0423EK, CSL-0523E, CSL-0523EK, CSL-06E, CSL-10E, CSL-423E, CSL-423K, CSM-0611IE, CSM-0611N, CSM-1011IE, CSM-1011N, CSM-1021IE, CSM-1021N, CSM-2011IE, CSM-2011N...(Other models you can see in the webshop)		

gas components



for dishwashers

drain and intake components

HOBART

drain /intake bodies



Part No.	511677	Ref. No.	00-324053-000 00-886639-000
description	flange with gasket ED ø 107mm ID ø 70mm for pump		
For models:	CN-Protronic, CN-Smartronic, CP-Protronic, CR-F, CS-Easytronic, ECOMAX-402, ECOMAX-502, FE-W, FX, GC, GC11, GC12, GC31, GC32, GC41, GC42, GX, HX, HX-30, HX-30E, HX-30ES, HX-30S, HX-40, HX-40E, HX-40ES, HX-40S, HX-60-EHL, HX-E, HX-ES, HX-S		

overflow pipes



Part No.	510409	Ref. No.	00-276903-053 00-67500-016 00-67500-118 276903-53 670500-118 67500-16
description	O-ring EPDM thickness 5.34mm ID ø 56.52mm Qty 1 pcs		
For models:	CR-F, CX, ECW, EWB-S, FTN, FTT, FTX, FUX, ML-104674, ML-104683, ML-104686, UW-135, UW-135H, UWX, UX-60, UX-60B, UX-60E, UX-60EB, UX-60EH, UX-60EHB, UX-60H, UX-60HB, UXT, UXTH, UXTHL, UXTHLS, UXTHS, UXTL, UXTLH, UXTLHS, UXTLS, UXTS, V1401		

housing and bezels

miscellaneous




Part No.	513048	Ref. No.	00-886756-001 886756-1
description	duct ID ø 41mm ED ø 50mm		
For models:	AM-10, AM-11, AM-141, AM-700, AM900, AM900-10N, AM900-90, AMS900, AMS900-10N, AMX, AMX-10HL, AMX-90, AMX-900, AMX-E, AMX-ER, AMXR, AMX-R, AMXR-900, AMXS, AMXS-900, AMXT, AMXTS, AMXX, AMXX-1300, AMXXR, AMXXR-1300, AMXXS, AMXXS-1300, AMXXT, AUP, AUP-90, AUPS, AUX, AUX-E, AUX-ER, AUX-R, AUXX, AUXX-1300, AUXXL, AUXXL-11N, AUXXLS-11N, AUXXR, AUXXR-1300, AUXXS, AUXXS-1300, AUXXT, AUXXTS, CN-Protronic, CN-Smartronic, CS-Easytronic...(Other models you can see in the webshop)		

locks

miscellaneous

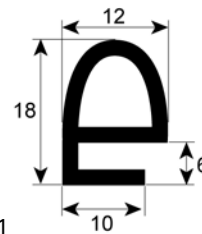


Part No.	696420	Ref. No.	03811C
description	door catch with microswitch L 80mm W 46mm mounting distance 60mm		
spare parts for	696420		
	Part No.	347567	Ref. No. —
	momentary push switch mounting ø 12mm white 1NO 250V 4A connection male faston 6.3mm ambient temperature max. 85°C protection IP40		

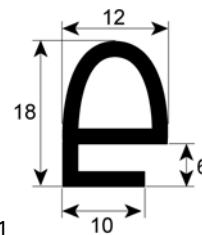
gaskets

gaskets for heated units

door seals



Part No.	901417	Ref. No.	492439 845052
description	door seal profile 2215 L 2010mm suitable for HOBART Qty 1		
For models:	CO-0612E, CS-0612E, CS-0612E-A, CSD-0612E, CSD-0612E-A, CSD-0612-UC, CSL-06E, CSM-0611IE, CSM-0611N		



Part No.	901366	Ref. No.	492466
description	door seal profile 2215 L 2530mm Qty 1 suitable for HOBART		
For models:	CO-1012E, CS-1012E, CS-1012E-A, CS-1012G, CS-1022E, CS-1022E-A, CSD-1012E, CSD-1012E-A, CSD-1012-UC, CSD-1013G, CSD-1022E, CSD-1022E-A, CSD-1022-UC, CSL-10E, CSM-1011IE, CSM-1011N, CSM-1021IE, CSM-1021N		



Part No.	902444	Ref. No.	01-235313 1235313 162007
description	door seal profile 2510 W 670mm L 775mm external size		

Part No.	518126	Ref. No.	492455
description	door seal profile 2980 L 2820mm		
For models:	CO-1012E, CS-1012E, CS-1012E-A, CS-1022E, CS-1022E-A, CSD-1012E, CSD-1012E-A, CSD-1013G, CSD-1022E, CSD-1022E-A, CSL-10E, CSM-1011E, CSM-1011N, CSM-1021E, CSM-1021N		

O-rings

EPDM

ø3.00mm

Part No.	510419	Ref. No.	00-276903-019 276903-19
description	O-ring EPDM thickness 3mm ID ø 150mm Qty 1 pcs		
For models:	FE-W, FX, GX, HX, HX-30, HX-30E, HX-30ES, HX-30S, HX-40, HX-40E, HX-40ES, HX-40S, HX-60-EHL, HX-E, HX-ES, HX-S		

ø5.34mm

Part No.	510409	Ref. No.	00-276903-053 00-67500-016 00-67500-118 276903-53 670500-118 67500-16
description	O-ring EPDM thickness 5.34mm ID ø 56.52mm Qty 1 pcs		
For models:	CR-F, CX, ECW, EWB-S, FTN, FTT, FTX, FUX, ML-104674, ML-104683, ML-104686, UW-135, UW-135H, UWX, UX-60, UX-60B, UX-60E, UX-60EB, UX-60EH, UX-60EHB, UX-60H, UX-60HB, UXT, UXTH, UXTHL, UXTHLS, UXTHS, UXTL, UXTLH, UXTLHS, UXTLS, UXTS, V1401		

shaft gaskets

miscellaneous

Part No.	511605	Ref. No.	322190-1
description	shaft seal		
For models:	CO-0611E, CO-1011E, CO-2011E, CS-0611E, CS-0612E-A, CS-1011E, CS-1012E-A, CS-1022E-A, CS-2011E, CS-2012E-A, CS-2022E-A, CSD-0611E, CSD-0612E-A, CSD-0612ET, CSD-1011E, CSD-1012E-A, CSD-1012ET, CSD-1022E-A, CSD-2011E, CSD-2012E-A, CSD-2012ET, CSD-2022E-A		

special gaskets

miscellaneous

Part No.	511600	Ref. No.	844617
description	gasket ED ø 80mm		
For models:			

transmission technology and ball bearings

ball bearings

deep-groove ball bearings 2RS

Part No.	523511	Ref. No.	603273 BB-20-18
description	deep-groove ball bearing type 6203-2RS shaft ø 17mm ED ø 40mm W 12mm with sealing discs deep-groove ball bearing DIN 625-1		





hoses

supply hoses

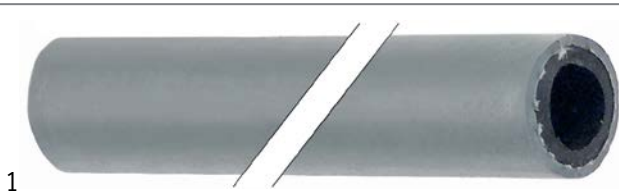
PVC supply hoses




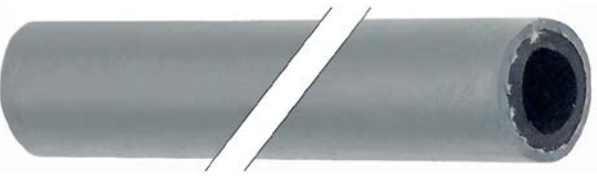
Part No.	520010	Ref. No.	E143170
description	supply hose PVC straight-curved DN13 connections 3/4" L 1500mm operating p. 10bar burst p. 32bar t.max. 90°C blue approval VDE flat seal		
accessories for	520010		
	Part No.	520053	Ref. No. —
	screen connection 3/4" D1 ø 26mm D2 ø 15mm Qty 10 pcs rubber thickness 8mm		
	Part No.	520054	Ref. No. —
	flat gasket rubber ED ø 23.5mm ID ø 14mm thickness 2.3mm Qty 10 pcs		



Part No.	520011	Ref. No.	139321-1030 139321-1034
description	supply hose PVC straight-curved DN13 connections 3/4" L 2000mm operating p. 10bar burst p. 32bar t.max. 90°C approval VDE flat seal		



Part No.	520015	Ref. No.	00-775559-007 00-775559-008 00-775559-013 00-775559-016 139321-125 139321-611 775559-13 775559-16 775559-7 775559-8
description	supply hose ID ø 10mm ED ø 17mm L 5m operating p. 20bar burst p. 60bar t.max. 95°C grey Qty 5m		
For models:	AM-10, AM-11, AM-141, AM-700, AM900, AM900-10N, AM900-90, AMS900, AMS900-10N, AMX, AMX-10HL, AMX-90, AMX-900, AMXR, AMXR-900, AMXS, AMXS-900, AMXT, AMXTS, AMXX, AMXX-1300, AMXXR, AMXXR-1300, AMXXS, AMXXS-1300, AMXXT, AUP, AUP-90, AUPS, AUXX, AUXX-1300, AUXXL, AUXXL-11N, AUXXLS-11N, AUXXR, AUXXR-1300, AUXXS, AUXXS-1300, AUXXT, AUXXTS, CHF45, CHH-70D, ECOMAX-600, ECOMAX-602-10, ECOMAX-602-11, ECOMAX-602S-11, ECOMAX-612-10, ECOMAX-612S-10, EF-40, EH-70...(Other models you can see in the webshop)		
accessories for	520015		
	Part No.	504377	Ref. No. 01-240159-001 01-240159-1
	hose connector grommet ø 23mm grommet length 25mm total length 55mm for water filling		

	Part No.	520016	Ref. No.	143010
description	supply hose ID ø 13mm ED ø 20mm L 40m operating p. 20bar burst p. 60bar t.max. 95°C grey Qty 40m			

industrial hoses

PVC hoses

PVC hoses without fabric



Part No.	520029	Ref. No.	00-165168-001
description	PVC hose ID ø 6mm ED ø 9mm L 10m thickness 1.5mm t.max. 60°C transparent		

water cycle components

supply filters



Part No.	520261	Ref. No.	E927078
description	supply filter thread 1/2" IT - 1/2" IT total length 58mm red brass mesh opening 0.4mm		

ancillary products

clamps

hose clamps

DIN 3017 - W2



Part No.	520114	Ref. No.	423008
description	hose clamp ø 20-32mm width 9mm Qty 10 pcs DIN 3017		



fastening material

screws

hexagonal screws



1

Part No.	550528	Ref. No.	00-609782-000
description	safety screw thread M5 WS 8 Qty 10 pcs L 8mm head ø 11mm		
For models:	AM-10, AM-11, AM-141, AM900-10N, AM900-90, AMS900-10N, AMX, AMX-10HL, AMX-90, AMXR, AMXS, AMXT, AMXTS, AMXX, AMXXR, AMXXS, AUP, AUP-90, AUPS, AUXX, AUXXL-11N, AUXXLS-11N, AUXXR, AUXXS, AUXXT, AUXXTS, ECOMAX-602-10, ECOMAX-602-11, ECOMAX-602S-11, ECOMAX-612-10, ECOMAX-612S-10		

grub screws

DIN 913/ISO 4026



1

Part No.	504733	Ref. No.	VA-261-1
description	grub screw thread M4 L 5mm stainless steel DIN 913 intake internal hexagon WS 2 Qty 1 pcs		

washers

washers

miscellaneous



1

Part No.	524117	Ref. No.	602286
description	plain washer ID ø 6.4mm ED ø 12mm thickness 1.6mm SS Qty 1 pcs		

fasteners

clamps

hose clamps

DIN 3017 - W2



1

Part No.	520114	Ref. No.	423008
description	hose clamp ø 20-32mm width 9mm Qty 10 pcs DIN 3017		

consumables

fuses

fine fuses



1

Part No.	358666	Ref. No.	926283 E926283
description	fine fuse size ø5x20mm 0.315A fast-acting rated 250V Qty 10 pcs		



1

Part No.	358530	Ref. No.	139321-902
description	fine fuse size ø5x20mm 0.8A fast-acting rated 250V Qty 10 pcs		
For models:	CHH-50, CHH-60D, EH-60		



1

Part No.	358677	Ref. No.	139321-690 E228004
description	fine fuse size ø5x20mm 4A fast-acting rated 250V Qty 10 pcs		
For models:	CHH-50, CHH-60D, CHH-70D, EH-60, EH-70		



1

Part No.	358594	Ref. No.	228012
description	fine fuse size ø5x20mm 0.16A slow-acting rated 250V Qty 10 pcs		



1

Part No.	358606	Ref. No.	228010 E228010
description	fine fuse size ø5x20mm 4A slow-acting rated 250V Qty 10 pcs		

ø6.3x32mm 500V



1

Part No.	358752	Ref. No.	3090506
description	fine fuse size ø6.3x32mm 10A fast-acting rated 500V Qty 10 pcs		

GASTROPARTS.COM



© 2020 Gastroparts Sp. J. All rights reserved.