



**GASTROPARTS**

# Garbin

**[EN]** Cooking

**[DE]** Kochtechnik

**[ES]** Cocción

**[FR]** Cuisson

**[IT]** Cottura

**[PL]** Obróbka termiczna

**[RU]** Термическая обработка

✉ [gastroparts@gastroparts.com](mailto:gastroparts@gastroparts.com)

☎ tel. +48 56 657 00 66

📘 [fb.com/gastroparts.global](https://fb.com/gastroparts.global)

**GASTROPARTS.COM**





## heating elements

## heating elements for ovens

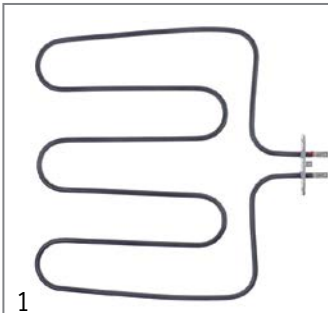

<b>Part No.</b>	418792	<b>Ref. No.</b>	RES155
<b>description</b>	heating element 1400W 230V heating circuits 1 L 315mm W 320mm L1 55mm L2 260mm W1 150mm W2 30mm flange length 70mm flange width 22mm hole distance 56mm hole $\varnothing$ 4.2mm tube $\varnothing$ 6.3mm connection male faston 6.3mm rectangular flange		

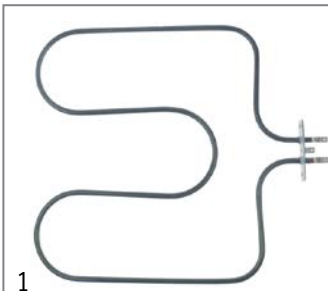

<b>Part No.</b>	420276	<b>Ref. No.</b>	RES009 RES041 RES043 RESINF RESINF838443MX23
<b>description</b>	heating element 1500W 230V heating circuits 1 L 313mm W 300mm L1 48mm L2 305mm W1 135mm W2 30mm flange length 70mm flange width 22mm hole distance 56mm hole $\varnothing$ 5mm tube $\varnothing$ 6.5mm connection male faston 6.3mm windings 2 oven heating element		

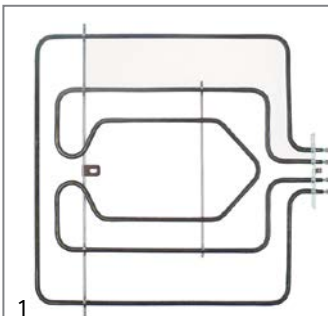



<b>Part No.</b>	420275	<b>Ref. No.</b>	RES008 RES039 RES054 RESSUP2343MX
<b>description</b>	heating element 2400W 230V heating circuits 2 L 335mm W 350mm L1 30mm L2 305mm W1 145mm W2 60mm flange length 100mm flange width 22mm hole distance 86mm hole $\varnothing$ 5mm tube $\varnothing$ 6.5mm connection male faston 6.3mm oven heating element		

## heating elements for convection



<b>Part No.</b>	420534	<b>Ref. No.</b>	RES015
<b>description</b>	heating element 2000W 240V heating circuits 2 ID $\varnothing$ 220mm ED $\varnothing$ 233mm L 270mm H 44mm L1 16mm W1 58mm H1 14mm H2 30mm flange length 100mm flange width 22mm connection F6.3 tube $\varnothing$ 6.5mm threaded		





<b>Part No.</b>	415966	<b>Ref. No.</b>	RES006 RES036
<b>description</b>	heating element 2500W 230V heating circuits 1 ID $\varnothing$ 176mm ED $\varnothing$ 188mm L 210mm H 28mm L1 22mm W1 30mm H1 3mm H2 25mm flange length 70mm flange width 22mm hole distance 56mm connection male faston 6.3mm tube $\varnothing$ 6.3mm convection heating element hole $\varnothing$ 5mm rectangular flange		
<b>spare parts for</b>	415966		
	<b>Part No.</b>	510368	<b>Ref. No.</b> —
	gasket L 70mm W 23.5mm hole $\varnothing$ 5mm hole distance 56mm FIBER thickness 2mm for heating element		
<b>accessories for</b>	415966		
	<b>Part No.</b>	510368	<b>Ref. No.</b> —
	gasket L 70mm W 23.5mm hole $\varnothing$ 5mm hole distance 56mm FIBER thickness 2mm for heating element		





<b>Part No.</b>	420535	<b>Ref. No.</b>	RES029 RES029-UL
<b>description</b>	heating element 2500W 240V heating circuits 1 ID $\varnothing$ 185mm ED $\varnothing$ 293mm L 245mm H 30mm L1 32mm W1 30mm H1 8mm H2 22mm flange length 70mm flange width 22mm hole distance 57mm connection F6.3 tube $\varnothing$ 6.5mm hole $\varnothing$ 5mm threaded		



 <p>1</p>			
<b>Part No.</b>	417607	<b>Ref. No.</b>	RES000 RES36 RES4000
<b>description</b>	heating element 2x2000W 230V heating circuits 2 ID ø 185mm ED ø 200mm L 240mm H 50mm L1 40mm W1 63mm H1 15mm H2 35mm flange length 100mm flange width 22mm hole distance 85mm connection male faston 6.3mm tube ø 6.4mm hot air hole ø 4.9mm		
<b>accessories for</b>	417607		
	<b>Part No.</b>	550986	<b>Ref. No.</b> —
<b>description</b>	gasket L 100mm W 22mm 7 holes graphite thickness 1mm for heating element		

 <p>1</p>			
<b>Part No.</b>	420536	<b>Ref. No.</b>	RES017
<b>description</b>	heating element 3300W 230V heating circuits 1 ID ø 225mm ED ø 238mm L 270mm H 34mm L1 20mm W1 30mm H1 10mm H2 24mm flange length 70mm flange width 22mm hole distance 56mm connection F6.3 tube ø 6.25mm hole ø 5mm threaded		

 <p>1</p>			
<b>Part No.</b>	420295	<b>Ref. No.</b>	RES013 RES013-UL
<b>description</b>	heating element 3300W 240V heating circuits 1 ID ø 186mm ED ø 202mm L 250mm H 38mm L1 36mm W1 32mm H1 8mm H2 32mm flange length 70mm flange width 22mm hole distance 56mm connection male faston 6.3mm tube ø 8.5mm convection heating element hole ø 5mm flange for combi-steamer		

 <p>1</p>			
<b>Part No.</b>	417606	<b>Ref. No.</b>	RES026
<b>description</b>	heating element 4500W 230V heating circuits 3 ID ø 220mm ED ø 240mm L 280mm H 50mm L1mm W1 96mm H1 15mm H2 35mm flange length 140mm flange width 25mm hole distance 63mm connection male faston 6.3mm connection length 41.5mm tube ø 8.4mm hot air hole ø 7mm		

## energy regulators

### EGO

#### 1-circuit

 <p>1</p>			
<b>Part No.</b>	380019	<b>Ref. No.</b>	REG001 REG100
<b>description</b>	energy regulator 240V 13A single-circuit turn direction right shaft ø 6x4.6mm shaft L 23mm mounting thread M4 power release 6-100% no. 50.57071.010		

## thermostats

### control and safety thermostats

#### EGO

#### control thermostats

#### 55.17\_ series

 <p>1</p>			
<b>Part No.</b>	390853	<b>Ref. No.</b>	TER005 TER034
<b>description</b>	thermostat t.max. 287°C temperature range 57-287°C 1-pole 1NO 16A probe ø 3.1mm probe L 122mm capillary pipe 1100mm capillary pipe isolated 1050mm gland nut shaft ø 6x4.6mm shaft L 23.5mm shaft position right rotation 270°		

#### CAEM

#### control thermostats

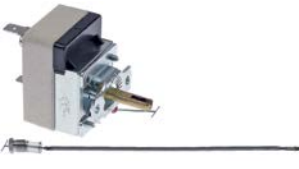
 <p>1</p>			
<b>Part No.</b>	375999	<b>Ref. No.</b>	TER001 TER007 TER290
<b>description</b>	thermostat t.max. 280°C temperature range 50-280°C 1-pole 1NO 16A probe ø 3mm probe L 180mm capillary pipe 1450mm capillary pipe isolated 20mm gland nut M10x1 shaft ø 6x4.6mm shaft L 18mm shaft position upper rotation 270° probe material SS		



safety thermostats



<b>Part No.</b>	376029	<b>Ref. No.</b>	TER008
<b>description</b>	safety thermostat switch-off temp. 320°C temperature range°C 1-pole 1NC 20A probe ø 3mm probe L 165mm capillary pipe 1280mm capillary pipe isolated 1080mm gland nut shaft ømm probe SS 250V		



<b>Part No.</b>	375990	<b>Ref. No.</b>	TER002 TER008 old TER325
<b>description</b>	safety thermostat switch-off temp. 335°C 1-pole 16A probe ø 3mm probe L 180mm capillary pipe 1400mm capillary pipe isolatedmm gland nut M10x1 probe SS		

TECASA

control thermostats



<b>Part No.</b>	376028	<b>Ref. No.</b>	TER020
<b>description</b>	thermostat t.max. 280°C temperature range 50-280°C 1-pole 1NO 16A probe ø 3mm probe L 175mm capillary pipe 1450mm capillary pipe isolatedmm gland nut M10x1 shaft ø 6x4.6mm shaft L 18mm shaft position upper rotation 270° probe material SS		

safety thermostats



<b>Part No.</b>	390964	<b>Ref. No.</b>	TER021
<b>description</b>	safety thermostat switch-off temp. 335°C temperature range°C 1-pole 1CO 16A probe ø 3mm probe L 120mm capillary pipe 1500mm capillary pipe isolatedmm gland nut M9x1 probe SS		

CAMPINI

control thermostats



<b>Part No.</b>	391009	<b>Ref. No.</b>	TER031
<b>description</b>	thermostat switch-off temp. 318°C temperature range°C 1-pole 1NO 16A probe ø 3mm probe L 137mm capillary pipe 1440mm capillary pipe isolatedmm gland nut M9x1 probe SS		

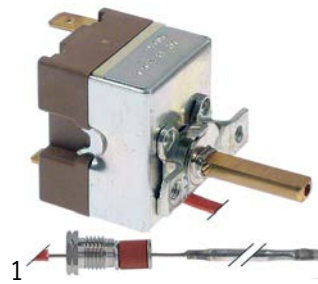

<b>Part No.</b>	376064	<b>Ref. No.</b>	TER030
<b>description</b>	thermostat t.max. 280°C temperature range 50-280°C 1-pole 1NO 16A probe ø 3mm probe L 175mm capillary pipe 1450mm capillary pipe isolatedmm gland nut M10x1 shaft ø 6x4.6mm shaft L 18mm shaft position upper rotation 270° probe material SS		

switches and momentary switches

push/momentary push switches

ø25mm



<b>Part No.</b>	347771	<b>Ref. No.</b>	PUL002 PUL245
<b>description</b>	momentary push switch mounting ø 25mm white 1NO/indicator light 250V 16A steam connection male faston 6.3mm ambient temperature max. 85°C protection IP40		

microswitches

pin-plunger actuated

M10



<b>Part No.</b>	348199	<b>Ref. No.</b>	MIC001 MIC002 MIC253
<b>description</b>	microswitch thread L 17mm 250V 16A 1CO connection F6.3 stroke 7mm actuating force: 500g		



cam switches

10 operating positions

 <p>1</p>			
<b>Part No.</b>	347770	<b>Ref. No.</b>	COM000 COM002 COM037
<b>description</b>	cam switch 10 operating positions 8NO sequence 0-1-2-3-4-5-6-7-8-9 18A shaft ø 6x4.6mm shaft L 23mm connection male faston 6.3mm plastic		

lamps

indicator lights

indicator lights (complete)

ø10mm

with plug-in socket

 <p>1</p>			
<b>Part No.</b>	359138	<b>Ref. No.</b>	SEG000 SP036 SP037
<b>description</b>	indicator light ø 10mm red 230V connection male faston 6.3mm Qty 1 pcs		

screw-on/push-on fit

light bulbs

for ovens

 <p>1</p>			
<b>Part No.</b>	359740	<b>Ref. No.</b>	LAM002
<b>description</b>	light bulb t.max. 300°C socket E14 15W 230V ø 22mm L 48mm lens L 20mm for oven lamp IMPORT		

 <p>1</p>			
<b>Part No.</b>	357153	<b>Ref. No.</b>	LAM001
<b>description</b>	light bulb t.max. 300°C socket E14 25W 230V ø 25mm L 55mm lens L 30mm for oven type		

halogen lamp

for socket G4 / G6.35 / G9



 <p>1</p>			
<b>Part No.</b>	359945	<b>Ref. No.</b>	LAM008
<b>description</b>	halogen lamp socket G9 230V 25W temp.-resist. 300°C		





 <p>1</p>			
<b>Part No.</b>	359946	<b>Ref. No.</b>	LAM003
<b>description</b>	halogen lamp socket G9 230V 40W temp.-resist. 300°C		

oven lamps

universal oven lamps

mounting diameter 35.5mm

 <p>1</p>			
<b>Part No.</b>	359718	<b>Ref. No.</b>	LAM006 Portlam 290
<b>description</b>	oven lamp mounting ø 35.5mm 230V 15W socket E14 temp.-resist. 300°C connection male faston 6.3mm hard glas		
<b>spare parts for</b>	359718		
	<b>Part No.</b>	359701	<b>Ref. No.</b> POR021
	lamp socket socket E14 220-230V mounting ø 35.5mm connection male faston 6.3mm 15W		
	<b>Part No.</b>	359740	<b>Ref. No.</b> LAM002
	light bulb t.max. 300°C socket E14 15W 230V ø 22mm L 48mm lens L 20mm for oven lamp IMPORT		



 <p>1</p>			
<b>Part No.</b>	359701	<b>Ref. No.</b>	POR021
<b>description</b>	lamp socket socket E14 220-230V mounting ø 35.5mm connection male faston 6.3mm 15W		
<b>accessories for</b>	359701		
	<b>Part No.</b>	359705	<b>Ref. No.</b> —
	oven lamp glass thr.ø 33.5mm ø 52mm hard glas temp.-resist. 350°C		
	<b>Part No.</b>	359709	<b>Ref. No.</b> VET001 VET002
	oven lamp glass thr.ø 33.5mm ø 42mm hard glas temp.-resist. 350°C		
	<b>Part No.</b>	359721	<b>Ref. No.</b> —
	gasket silicone ED ø 48mm ID ø 39.5mm thickness 5mm Qty 1 pcs		
	<b>Part No.</b>	359942	<b>Ref. No.</b> —
	oven lamp glass thr.ø 33.5mm ø 41mm hard glas temp.-resist. 350°C		



			
1			
<b>Part No.</b>	359709	<b>Ref. No.</b>	VET001 VET002
<b>description</b>	oven lamp glass thr.Ø 33.5mm Ø 42mm hard glas temp.-resist. 350°C		

			
1			
<b>Part No.</b>	358128	<b>Ref. No.</b>	GUA001 GUA019
<b>description</b>	gasket for oven lamp silicone ID Ø 30mm ED Ø 38mm thickness 2mm		

55x70mm			
			
1			
<b>Part No.</b>	357159	<b>Ref. No.</b>	POR020
<b>description</b>	lamp socket socket E14 mounting measurements 55x70mm connection male faston 6.3mm Qty 1 pcs		

				
1				
<b>Part No.</b>	359297	<b>Ref. No.</b>	COR000	
<b>description</b>	frame L 95mm W 81mm mounting distance 68/83mm thickness 6mm			
<b>accessories for</b>	359297			
	<b>Part No.</b>	359299	<b>Ref. No.</b>	GHI000
	gasket L 91mm W 77mm hole Ø 3mm for oven lamp			

			
1			
<b>Part No.</b>	359299	<b>Ref. No.</b>	GHI000
<b>description</b>	gasket L 91mm W 77mm hole Ø 3mm for oven lamp		

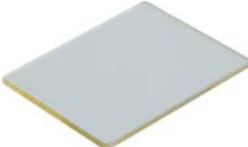
			
1			
<b>Part No.</b>	359296	<b>Ref. No.</b>	VET000
<b>description</b>	lamp glass L 74mm W 58mm thickness 3mm		

			
1			
<b>Part No.</b>	357159	<b>Ref. No.</b>	POR020
<b>description</b>	lamp socket socket E14 mounting measurements 55x70mm connection male faston 6.3mm Qty 1 pcs		

**lamps**

## light bulbs

			
1			
<b>Part No.</b>	359740	<b>Ref. No.</b>	LAM002
<b>description</b>	light bulb t.max. 300°C socket E14 15W 230V Ø 22mm L 48mm lens L 20mm for oven lamp IMPORT		

			
1			
<b>Part No.</b>	357153	<b>Ref. No.</b>	LAM001
<b>description</b>	light bulb t.max. 300°C socket E14 25W 230V Ø 25mm L 55mm lens L 30mm for oven type		

## halogen lamps

## for socket G4 / G6.35 / G9

			
1			
<b>Part No.</b>	359945	<b>Ref. No.</b>	LAM008
<b>description</b>	halogen lamp socket G9 230V 25W temp.-resist. 300°C		

			
1			
<b>Part No.</b>	359946	<b>Ref. No.</b>	LAM003
<b>description</b>	halogen lamp socket G9 230V 40W temp.-resist. 300°C		





sockets

G4 / G5,3 / G6,35



1

<b>Part No.</b>	359304	<b>Ref. No.</b>	POR076
<b>description</b>	lamp socket socket G4 24V ø 17mm H 9mm connection cable 120mm mounting distance 12mm with 2 hole fixing mounting thread M3 cable length 120mm Qty 1 pcs		

timers

programme timers

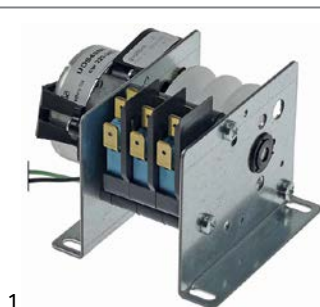

1

<b>Part No.</b>	360726	<b>Ref. No.</b>	INV013 INV030 INVER230 INVERV
<b>description</b>	programme timer Guaitani R3/3 engines 1 chambers 3 operation time 6min 220/240V 50/60Hz shaft ø 6x6mm shaft L 44mm manuf. no. R3/3 motor type UDS40NE1RNZ165		
<b>spare parts for</b>	360726		
	<b>Part No.</b>	360673	<b>Ref. No.</b> —
	motor kit pinion ø 6.8mm teeth 15 230V voltage AC 50/60Hz turn direction clockwise motor ø 48mm H 18.5mm motor type UDS-40NE1RNZ165 cable length 150mm with holder		

electric timers

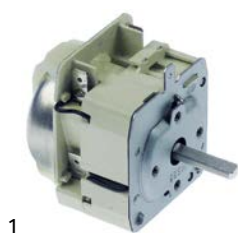

1

<b>Part No.</b>	350194	<b>Ref. No.</b>	TIM000 TIM060
<b>description</b>	timer MS65 with bell operation time 60min time spreadmin 2NO at 250V 16A permanent position yes impulse electric shaft ø 6x4.6mm shaft L 23mm mounting distance 29mm mounting thread M4 connection male faston 6.3mm Invensys 230V voltage AC 2-pole		

mechanical timers



1

<b>Part No.</b>	350187	<b>Ref. No.</b>	TIM001
<b>description</b>	timer M2 2-pole operation time 60min impulse mechanical 2CO at 250V 16A permanent position yes shaft ø 6x4.6mm shaft 6x4.6mm shaft L 23mm mounting distance 28mm		

alarm devices

buzzer boards



1

<b>Part No.</b>	401062	<b>Ref. No.</b>	BUZ000
<b>description</b>	buzzer board 230VAC L 48mm W 45mm connection Faston 6.3mm		



contactors

miscellaneous

power contactors



1

<b>Part No.</b>	381172	<b>Ref. No.</b>	CON000 CON030
<b>description</b>	power contactor resistive load 20A 230VAC (AC3/400V) 9A/4.2kW main contacts 3NO auxiliary contacts 1NC connection screw connection type NC1-0901		
<b>spare parts for</b>	381172		
	<b>Part No.</b>	110235	<b>Ref. No.</b> —
	knob energy regulator 1-3 t.max.°C ø 50mm shaft ø 6x4.6mm shaft flat upper black		
	<b>Part No.</b>	380013	<b>Ref. No.</b> —
	energy regulator 400V 7A single-circuit turn direction right shaft ø 6x4.6mm mounting thread M4 no. 50.57031.010		



## probes

### producer-specific probes

#### probes



<b>Part No.</b>	379887	<b>Ref. No.</b>	SON001 SON006 SON011
<b>description</b>	temperature probe Pt100 cable high temperatur film probe -50 up to +200°C cable -50 up to +200°C connection 2-wire thread M10x1.5 probe ø5x42mm cable length 1.9m		

#### core probes



<b>Part No.</b>	379886	<b>Ref. No.</b>	SON000 SON102
<b>description</b>	core temperature probe Pt100 cable PTFE probe -40 up to +250°C cable -40 up to +250°C connection 2-wire probe ø4x100mm thread M10x1.5 cable length 3m handle ø 15mm handle length 90mm		

## electronics

### PCBs



<b>Part No.</b>	361951	<b>Ref. No.</b>	SCH094
<b>description</b>	PCB L 183mm W 103mm		

## solenoid valves

### solenoid valves (water)

#### ROBERTSHAW/INVENSYS

medium temperature: 90°C 90°C 60°C  
 ambient temperature: 60°C 25°C 60°C  
 duty cycle: 40% 100% 100%

#### solenoid valves with reducers

##### 3-fold



<b>Part No.</b>	374104	<b>Ref. No.</b>	ELE002 ELE012
<b>description</b>	solenoid valve triple straight 230VAC inlet 3/4" outlet 11.5mm input/ min output 2.5l/min output A 2.5l/min output B 2.5l/min output C 2.5l/min flow regulating valve outlet A brown flow regulating valve outlet B brown flow regulating valve outlet C brown		

#### RPE

#### solenoid valves with reducers

##### single



<b>Part No.</b>	374012	<b>Ref. No.</b>	ELE000 ELE1V
<b>description</b>	solenoid valve single straight 220-240VAC inlet 3/4" outlet JG 8 input 10-12l/min t.max. 60°C duty cycle 100% RPE plastic flow regulating valve outlet brown flow regulating valve inlet white output A 0.07-0.14l/min 2-ways medium temp max. 25°C male faston 6.3mm		

##### 2-fold



<b>Part No.</b>	374103	<b>Ref. No.</b>	ELE001 VAL236
<b>description</b>	solenoid valve double straight 220-240VAC inlet 3/4" outlet JG 8 input 4-4.5l/min output 0.07-0.14l/min flow regulating valve inlet yellow output A brownl/min output B brownl/min		

#### TP

#### solenoid valves with reducers



<b>Part No.</b>	370628	<b>Ref. No.</b>	ELE2V
<b>description</b>	solenoid valve double straight 230VAC inlet 3/4" input 16l/min DN10 TP plastic outlet 11.5mm		





# fans

## cross flow fans

### COPREL

with standard coil



1

<b>Part No.</b>	601453	<b>Ref. No.</b>	MOT43SE
<b>description</b>	cross flow fan TFR 180 roller ø 60mm roller length 180mm laminated core thickness 16mm motor position right 230V/50-60Hz 17W universal bearing silicone connection male faston 6.3mm airflow 100m³/h -30 up to +100°C 230V 50Hz		
<b>accessories for</b>	601453		
	<b>Part No.</b>	415114	<b>Ref. No.</b> —
	heater battery mounting distance 185mm W 40mm H 35mm 2000W 230V temperature restriction 105°C heating circuits 2 connection cable cable length 150mm L 192mm for cross flow fan		

## hot air motors



1

<b>Part No.</b>	601854	<b>Ref. No.</b>	MOT002 MOT013+CON025
<b>description</b>	fan motor 230V 1 phase 50/60Hz 0.26/0.40kW 2800/3200rpm speeds 1 L1 96mm L2 68mm D1 ø 6/8mm M5x0.8 1.1/1.7A suitable capacitor 5µF/450V Cos(φ) 3217 type MFC80		



1

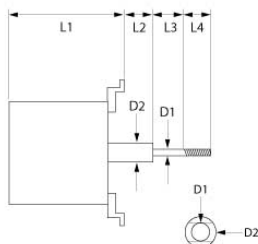

<b>Part No.</b>	601856	<b>Ref. No.</b>	MOT200 MOTCOND44
<b>description</b>	fan motor 230V 1 phase 50Hz 0.075kW 2650rpm speeds 1 L1 85mm L2 30mm L3 23mm L4 12mm D1 ø 8x6mm D2 ø 8mm 0.6A suitable capacitor 5µF/400V		
<b>accessories for</b>	601856		
	<b>Part No.</b>	365017	<b>Ref. No.</b> CON003
	operating capacitor capacity 5µF 450V tolerance 5% 50/60Hz ambient temperature max. -25 to +85°C ø 28mm L 54mm M8 plastic connection male faston 6.3mm 16.10.08 protection		



1

<b>Part No.</b>	601993	<b>Ref. No.</b>	MOT001 MOT013 MOT017 MOT017+CON003 MOT201
<b>description</b>	fan motor 230V 1 phase 50Hz 0.18/0.12kW 2800rpm speeds 1 L1 85mm L2 65mm L3 23mm D1 ø 8mm D2 ø 6mm M5x0.8 0.8A suitable capacitor 5µF/450V		
<b>accessories for</b>	601993		
	<b>Part No.</b>	365017	<b>Ref. No.</b> CON003
	operating capacitor capacity 5µF 450V tolerance 5% 50/60Hz ambient temperature max. -25 to +85°C ø 28mm L 54mm M8 plastic connection male faston 6.3mm 16.10.08 protection		



1

<b>Part No.</b>	602012	<b>Ref. No.</b>	KIT030
<b>description</b>	fan motor 230V 50Hz 0.11/0.05kW 2800rpm L1 130mm L2 50mm D1 ø 8mm M5x0.8 suitable capacitor 4µF/450V type MFT63 H25		



1

<b>Part No.</b>	601801	<b>Ref. No.</b>	VEN001
<b>description</b>	fan wheel D1 ø 160mm H1 43mm blades 36 D2 ø 8mm D3 ø 8mm H2 24mm		





## hot air fans

## miscellaneous

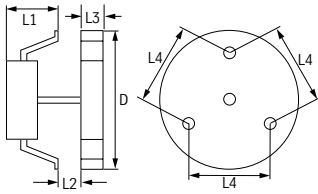

1



<b>Part No.</b>	500902	<b>Ref. No.</b>	MOT019
<b>description</b>	fan motor 220V 55W 50/60Hz L1 68mm FIME type L25R without fan wheel		
<b>accessories for</b>	500902		
	<b>Part No.</b>	550879	<b>Ref. No.</b> —
	insulation $\varnothing$ 130mm thickness 3mm hole $\varnothing$ 18mm for hot air fan		



1

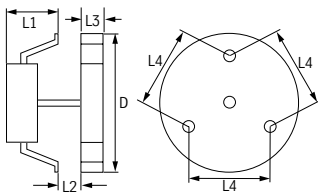

<b>Part No.</b>	601825	<b>Ref. No.</b>	MOT+VEN046 MOT+VEN43 MOT005 MOT019+GUA061+VEN020
<b>description</b>	hot air fan 230-240V 55W 50/60Hz L1 65mm L2 8mm L3 29mm L4 87mm fan wheel $\varnothing$ 155mm PLASET type 9637.62683		

## accessories

## fan wheels for hot air fans



1

<b>Part No.</b>	601979	<b>Ref. No.</b>	VEN010
<b>description</b>	fan wheel $\varnothing$ 159mm W 29mm shaft intake $\varnothing$ 6x5mm SS blades 12 Qty 1 pcs		

## motors

## gear motors

## for ovens



1

<b>Part No.</b>	500811	<b>Ref. No.</b>	MOT018
<b>description</b>	gear motor AUTOM type ASR/30/FR 230V 50Hz shaft $\varnothing$ 8mm L 150mm W 65mm H 90mm		

## pumps

## booster pumps II

## accessories



1

<b>Part No.</b>	365017	<b>Ref. No.</b>	CON003
<b>description</b>	operating capacitor capacity 5 $\mu$ F 450V tolerance 5% 50/60Hz ambient temperature max. -25 to +85°C $\varnothing$ 28mm L 54mm M8 plastic connection male faston 6.3mm 16.10.08 protection		



## condensators & interference suppression filters

### operating capacitors

plastic



1

<b>Part No.</b>	365017	<b>Ref. No.</b>	CON003
<b>description</b>	operating capacitor capacity 5µF 450V tolerance 5% 50/60Hz ambient temperature max. -25 to +85°C ø 28mm L 54mm M8 plastic connection male faston 6.3mm 16.10.08 protection		

## electric accessories

### terminals

connection terminals with screw/faston connections



1

<b>Part No.</b>	550534 <sup>1</sup>	<b>Ref. No.</b>	MOR000 MOR057
<b>description</b>	power terminal block 3-pole max. 40A max 450V connection ø6mm <sup>2</sup> / F6.3 temp.-resist. 150°C cross section 6mm <sup>2</sup> mounting distance 67mm with ground lug		

<sup>1</sup>with ground lug

## gas valves and ignition boxes

### gas control valves

HONEYWELL



1

<b>Part No.</b>	101186	<b>Ref. No.</b>	VAL000
<b>description</b>	gas valve type VK4105C 220-240V 50/60Hz gas inlet flange 32x32mm gas outlet flange 32x32mm thermocouple connection pilot connection pressure range 15-60mbar max 60mbar operator type pressure controller type V5360E 1226 1 HONEYWELL flange 32x32mm		
<b>accessories for</b>	101186		
	<b>Part No.</b>	102845	<b>Ref. No.</b> —
	gas connection angled 1/2" flange 32x32mm hole distance 24x24mm Tandem		

<b>accessories for</b>	101186		
	<b>Part No.</b>	102846	<b>Ref. No.</b> —
	gas connection straight 1/2" flange 32x32mm hole distance 24x24mm suitable for Tandem		

### ignition boxes

HONEYWELL



1

<b>Part No.</b>	102367	<b>Ref. No.</b>	CEN000
<b>description</b>	ignition box HONEYWELL type S4565A 2092 1 electrodes 3 waiting times safety time 10s 220-240V 4VA 50/60Hz		

## gas nozzles

### main nozzles

gas nozzles M13x1



1

<b>Part No.</b>	103200	<b>Ref. No.</b>	UGE003
<b>description</b>	gas injector thread M13x1 bore ø 3.3mm WS 13		



1

<b>Part No.</b>	699272	<b>Ref. No.</b>	BOC004
<b>description</b>	bush ID ø 9mm ED ø 21mm L 5mm		



## knobs

### producer-specific knobs

#### GARBIN



1

<b>Part No.</b>	112697	<b>Ref. No.</b>	MAN000
<b>description</b>	knob zero mark ø 43mm shaft ø 6x4.6mm shaft flat upper silver		



1

<b>Part No.</b>	112796	<b>Ref. No.</b>	MAN014 MAN038 MAN100
<b>description</b>	knob zero mark ø 49mm shaft ø 6x4.6mm shaft flat upper silver		



1

<b>Part No.</b>	112698	<b>Ref. No.</b>	MAN041
<b>description</b>	knob zero mark ø 50mm shaft ø 6x4.6mm shaft flat upper grey		

### accessories

#### fascias



1

<b>Part No.</b>	112699	<b>Ref. No.</b>	DIS006 DIS65
<b>description</b>	bezel thermostat 0-270°C ø 65mm		

#### gaskets



1

<b>Part No.</b>	112700	<b>Ref. No.</b>	DIS003 DIS09
<b>description</b>	gasket for knob shaft ø 9mm ED ø 65mm Qty 1 pcs nylon		

## locks

### handle latches

#### universal

#### inside fixing

#### locks



1

<b>Part No.</b>	694054	<b>Ref. No.</b>	MAN011
<b>description</b>	door handle for headed units L 145mm W 40mm H 62mm spring length 33mm inner black		

<b>spare parts for</b>	694054		
------------------------	--------	--	--



<b>Part No.</b>	514390	<b>Ref. No.</b>	—
<b>description</b>	spring for door handle ø 6mm L 54mm W 27.5mm		



<b>Part No.</b>	694675	<b>Ref. No.</b>	—
<b>description</b>	door catch L 88mm W 40mm H 37mm spring length 33mm mounting distance 60mm		



<b>Part No.</b>	694734	<b>Ref. No.</b>	—
<b>description</b>	door handle L 165mm W 40mm H 25mm black		



<b>Part No.</b>	694735	<b>Ref. No.</b>	—
<b>description</b>	cap ø 32mm black		

<b>accessories for</b>	694054		
------------------------	--------	--	--



<b>Part No.</b>	691123	<b>Ref. No.</b>	—
<b>description</b>	duct for door opener		



<b>Part No.</b>	694055	<b>Ref. No.</b>	—
<b>description</b>	door catch L 25mm W 14mm total length 54mm thread M8 thread L 29mm		



<b>Part No.</b>	694066	<b>Ref. No.</b>	—
<b>description</b>	door catch with spigot 2-stage L 28mm W 14mm H 15mm H1 16mm total length 51mm thread M8 thread L 23mm stainless steel		



<b>Part No.</b>	694067	<b>Ref. No.</b>	NAS000
<b>description</b>	door catch with spigot 1-stage L 26mm total length 51mm thread M8		

### producer-specific







#### GARBIN



1

<b>Part No.</b>	694067	<b>Ref. No.</b>	NAS000
<b>description</b>	door catch with spigot 1-stage L 26mm total length 51mm thread M8		





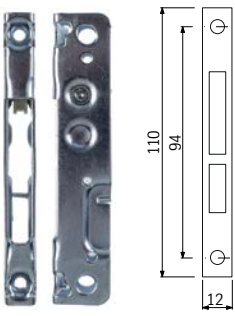

			
1			
<b>Part No.</b>	694054	<b>Ref. No.</b>	MAN011
<b>description</b>	door handle for headed units L 145mm W 40mm H 62mm spring length 33mm inner black		
<b>spare parts for</b>	694054		
	<b>Part No.</b>	514390	<b>Ref. No.</b> —
	spring for door handle ø 6mm L 54mm W 27.5mm		
	<b>Part No.</b>	694675	<b>Ref. No.</b> —
	door catch L 88mm W 40mm H 37mm spring length 33mm mounting distance 60mm		
	<b>Part No.</b>	694734	<b>Ref. No.</b> —
	door handle L 165mm W 40mm H 25mm black		
	<b>Part No.</b>	694735	<b>Ref. No.</b> —
	cap ø 32mm black		
<b>accessories for</b>	694054		
	<b>Part No.</b>	691123	<b>Ref. No.</b> —
	duct for door opener		
	<b>Part No.</b>	694055	<b>Ref. No.</b> —
	door catch L 25mm W 14mm total length 54mm thread M8 thread L 29mm		
	<b>Part No.</b>	694066	<b>Ref. No.</b> —
	door catch with spigot 2-stage L 28mm W 14mm H 15mm H1 16mm total length 51mm thread M8 thread L 23mm stainless steel		
	<b>Part No.</b>	694067	<b>Ref. No.</b> NAS000
	door catch with spigot 1-stage L 26mm total length 51mm thread M8		

## hinges

### oven hinges

			
1			
<b>Part No.</b>	693045	<b>Ref. No.</b>	POR025
<b>description</b>	opposite support L 110mm W 12mm mounting distance 94mm		

			
1			
<b>Part No.</b>	692563	<b>Ref. No.</b>	CER004 CERDX43
<b>description</b>	oven hinge mounting distance 123mm lug mounting 11mm lever length 124mm groove distance 11mm spring thickness 3.5mm mounting ear position left spring length 56mm L 148mm mounting pos. right W 20mm		
<b>accessories for</b>	692563		
	<b>Part No.</b>	692564	<b>Ref. No.</b> CER003 CERSX43
	oven hinge mounting distance 123mm lug mounting 11mm lever length 124mm groove distance 11mm spring thickness 3.5mm mounting ear position right spring length 56mm L 148mm mounting pos. left W 20mm		

			
1			
<b>Part No.</b>	692564	<b>Ref. No.</b>	CER003 CERSX43
<b>description</b>	oven hinge mounting distance 123mm lug mounting 11mm lever length 124mm groove distance 11mm spring thickness 3.5mm mounting ear position right spring length 56mm L 148mm mounting pos. left W 20mm		
<b>accessories for</b>	692564		
	<b>Part No.</b>	692563	<b>Ref. No.</b> CER004 CERDX43
	oven hinge mounting distance 123mm lug mounting 11mm lever length 124mm groove distance 11mm spring thickness 3.5mm mounting ear position left spring length 56mm L 148mm mounting pos. right W 20mm		



			
1			
<b>Part No.</b>	701217	<b>Ref. No.</b>	CER001 CER036 CER36 CER3623
<b>description</b>	oven hinge mounting distance 142mm lever length 118mm groove distance 10mm spring thickness 3.5mm spring length 57mm L 155mm mounting pos. left/right W 21mm		

			
2			
<b>Part No.</b>	701184	<b>Ref. No.</b>	CER002 CER44
<b>description</b>	oven hinge mounting distance 142mm mounting distance 2mm lug mountingmm lever length 118mm groove distance 12mm spring thickness 4.5mm mounting ear position spring length 57mm mounting pos. left/right W 23mm C 10mm		

			
1			
<b>Part No.</b>	901604	<b>Ref. No.</b>	GUA006 GUA222 GUA44
<b>description</b>	door seal W 660mm with 8 mounting clips H 360mm		

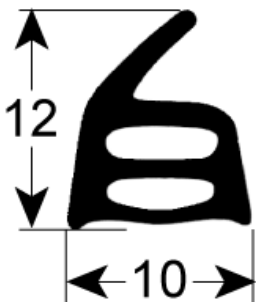
			
1			
<b>Part No.</b>	902326	<b>Ref. No.</b>	GUA003 GUA43
<b>description</b>	oven gasket external size L 460mm W 370mm with 6 mounting clips		

			
1			
<b>Part No.</b>	902404	<b>Ref. No.</b>	GUA007
<b>description</b>	oven gasket L 680mm W 280mm 4-sided with 8 mounting clips		

## gaskets

### gaskets for heated units

#### door seals with fixing hook

			
1			
<b>Part No.</b>	901605	<b>Ref. No.</b>	GUA010 GUA023
<b>description</b>	door seal W 320mm with 4 mounting clips H 350mm		

### sealing washers

#### rubber gaskets

			
1			
<b>Part No.</b>	506367	<b>Ref. No.</b>	GUA078 GUACIRC
<b>description</b>	flat gasket rubber ED ø 40mm ID ø 28mm thickness 1.8mm Qty 1 pcs		



**GASTROPARTS.COM**



© 2020 Gastroparts Sp. J. All rights reserved.