



**GASTROPARTS**

# Emmepi

**[EN]** Cooking

**[DE]** Kochtechnik

**[ES]** Cocción

**[FR]** Cuisson

**[IT]** Cottura

**[PL]** Obróbka termiczna

**[RU]** Термическая обработка

✉ [gastroparts@gastroparts.com](mailto:gastroparts@gastroparts.com)

☎ tel. +48 56 657 00 66

📘 [fb.com/gastroparts.global](https://fb.com/gastroparts.global)

**GASTROPARTS.COM**









## heating elements

## immersion heating elements



## 3 hole flange ø47.5mm

			
Part No.	418136	Ref. No.	808674
description	heating element 4360W 240V mounting ø 47.5mm heating circuits 3 L 310mm W 31mm H 35mm number of thermostat sleeves 1 thermostat sleeves ø 7mm length thermostat sleeves 200mm thermostat sleeve clinging tube ø 6.3mm hole distance 62mm hole ø 8mm connection M4 3 hole flange immersion heater		
spare parts for	418136		
	Part No.	510408	Ref. No.
	O-ring EPDM thickness 5.34mm ID ø 47mm Qty 1 pcs		
accessories for	418136		
	Part No.	510408	Ref. No.
	O-ring EPDM thickness 5.34mm ID ø 47mm Qty 1 pcs		
	Part No.	510562	Ref. No.
	O-ring silicone thickness 5.34mm ID ø 47mm Qty 1 pcs		

## 3 hole flange ø57.5mm

			
Part No.	418084	Ref. No.	807858
description	heating element 7599W 230V mounting ø 57.5mm heating circuits 3 L 340mm W 36mm H 42mm number of thermostat sleeves 1 thermostat sleeves ø 7mm length thermostat sleeves 270mm thermostat sleeve clinging tube ø 8.5mm hole distance 72mm hole ø 8mm connection M4 3 hole flange immersion heater		

## miscellaneous

			
Part No.	415550	Ref. No.	809556
description	heating element 9000W 230V heating circuits 3 L 205mm W 38mm H 70mm number of thermostat sleeves 1 thermostat sleeves ø 2.5mm length thermostat sleeves 120mm thermostat sleeve eccentric, clinging tube ø 6.3mm hole distance 64mm hole ø 8mm connection male faston 6.3mm 4 hole flange immersion heater flange width 82mm flange length 82mm		
accessories for	415550		
	Part No.	379078	Ref. No.
	temperature probe thermocouple K (NiCr-Ni) cable silicone probe -50 up to 1150°C cable -50 up to +180°C connection 2-wire thread probe ø1.5x100mm cable length 1.8m		

accessories for	415550		
	Part No.	510565	Ref. No.
	gasket rubber L 82mm W 82mm thickness 4mm hole ø 9mm hole distance 64mm for heating element suitable for RATIONAL 4 holes		

## heating elements for convection

			
Part No.	415914	Ref. No.	809571
description	heating element 15000W 230V heating circuits 6 ID ø 505mm ED ø 520mm L 615mm H 180mm L1 50mm W1 156mm H1 35mm H2 145mm flange length 210mm flange width 24mm hole distance 30mm connection male faston 6.3mm connection length 80mm tube ø 6.5mm convection heating element hole ø 8mm mounting pos. inner rectangular flange		
accessories for	415914		
	Part No.	521127	Ref. No.
	gasket L 210mm W 24mm thickness 2mm for heating element		
	Part No.	693548	Ref. No.
	flange suitable for convection heating element W 23mm mounting pos. outer length 210		

			
Part No.	415915	Ref. No.	809570
description	heating element 15000W 230V heating circuits 6 ID ø 635mm ED ø 650mm L 696mm H 200mm L1 23mm W1 156mm H1 35mm H2 165mm flange length 210mm flange width 24mm hole distance 31mm connection male faston 6.3mm connection length 80mm tube ø 6.3mm convection heating element hole ø 7mm mounting pos. outer rectangular flange		
accessories for	415915		
	Part No.	521127	Ref. No.
	gasket L 210mm W 24mm thickness 2mm for heating element		
	Part No.	693548	Ref. No.
	flange suitable for convection heating element W 23mm mounting pos. outer length 210		

1

Part No.	415119	Ref. No.	132110020
description	heating element 1600W 230V heating circuits 1 ID ø 179mm ED ø 197mm L 254mm H 30mm L1 51mm W1 31mm H1 9mm H2 21mm flange length 70mm flange width 22mm hole distance 56mm connection male faston 6.3mm connection length 41mm tube ø 6.3mm convection heating element hole ø 4mm rectangular flange		
accessories for	415119		
	Part No.	510368	Ref. No. 8C0286
	gasket L 70mm W 23.5mm hole ø 5mm hole distance 56mm FIBER thickness 2mm for heating element		



1

Part No.	418131	Ref. No.	808781
description	heating element 6000W 230V heating circuits 3 ID ø 217mm ED ø 231mm L 271mm H 90mm L1 41mm W1 103mm H1 24mm H2 66mm flange length 140mm flange width 22mm hole distance 63mm tube ø 6.3mm convection heating element hole ø 5mm rectangular flange		



1

Part No.	418986	Ref. No.	9629911
description	heating element 3000W 240V heating circuits 1 ID ø 180mm ED ø 186mm L 210mm H 31mm L1 11mm W1 60mm H1 7mm H2 24.5mm flange length 100mm flange width 22mm hole distance 86mm connection male faston 6.3mm connection length 34.5mm tube ø 6.25mm convection heating element hole ø 5mm rectangular flange		



1

Part No.	418858	Ref. No.	806187
description	heating element 7350W 230V heating circuits 3 ID ø 215mm ED ø 230mm L 267mm H 85mm L1 38mm W1 102mm H1 5mm H2 80mm flange length 142mm flange width 25mm hole distance 63mm cable length 1000mm convection heating element hole ø 6mm		





1

Part No.	415845	Ref. No.	142110001
description	heating element 3150W 230V heating circuits 3 ID ø 201mm ED ø 215mm L 272mm H 35mm L1 57mm W1 60mm H1 8mm H2 27mm flange length 95mm flange width 22mm hole distance 77mm connection male faston 6.3mm connection length 20mm tube ø 6.5mm convection heating element hole ø 6mm rectangular flange		



1

Part No.	415912	Ref. No.	809555
description	heating element 9000W 230V heating circuits 3 ID ø 445mm ED ø 458mm L 474mm H 130mm W1 156mm H1 33mm H2 97mm flange length 210mm flange width 24mm hole distance 31mm connection male faston 6.3mm connection length 80mm tube ø 6.5mm dry heating element hole ø 7.5mm mounting pos. inner rectangular flange L1 16mm		
accessories for	415912		
	Part No.	521127	Ref. No. —
	gasket L 210mm W 24mm thickness 2mm for heating element		
	Part No.	693548	Ref. No. —
	flange suitable for convection heating element W 23mm mounting pos. outer length 210		



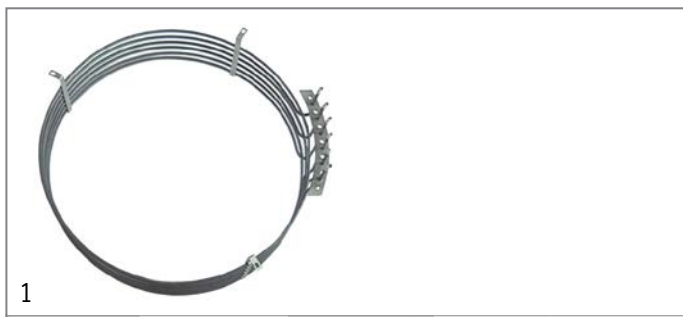

1

Part No.	418134	Ref. No.	808778
description	heating element 3300W 240V heating circuits 1 ID ø 185mm ED ø 200mm L 215mm H 30mm W1 60mm H1 5mm H2 25mm flange length 100mm flange width 22mm hole distance 85mm connection male faston 6.3mm connection length 22mm tube ø 6.5mm convection heating element hole ø 5mm rectangular flange		







1

Part No.	415913	Ref. No.	809554
description	heating element 9000W 230V heating circuits 3 ID $\varnothing$ 504mm ED $\varnothing$ 516mm L 535mm H 130mm W1 156mm H1 35mm H2 95mm flange length 210mm flange width 25mm hole distance 31mm connection male faston 6.3mm connection length 80mm tube $\varnothing$ 6.5mm dry heating element hole $\varnothing$ 7.5mm mounting pos. outer rectangular flange L1 19mm		
accessories for	415913		
	Part No.	521127	Ref. No.
			—
	gasket L 210mm W 24mm thickness 2mm for heating element		
	Part No.	693548	Ref. No.
			—
	flange suitable for convection heating element W 23mm mounting pos. outer length 210		



1

Part No.	418135	Ref. No.	808779
description	heating element 920W 230V heating circuits 1 ID $\varnothing$ 200mm ED $\varnothing$ 215mm L 255mm H 40mm thread 1/4" connection male faston 6.3mm 2 hole fixing mounting distance 24mm tube $\varnothing$ 8.5mm convection heating element		
accessories for	418135		
	Part No.	361182	Ref. No.
			—
	nut thread 1/4" H 5mm nickel-plated brass WS 17 Qty 1 pcs		
	Part No.	510417	Ref. No.
			—
	flat gasket fibre ED $\varnothing$ 20mm ID $\varnothing$ 14mm thickness 2mm Qty 1 pcs		
	Part No.	520228	Ref. No.
			—
	tooth lock washer ID $\varnothing$ 15.3mm ED $\varnothing$ 24mm steel Qty 1 pcs for thread M14		
	Part No.	550262	Ref. No.
			—
	flat gasket copper ED $\varnothing$ 20mm ID $\varnothing$ 14mm thickness 2mm		

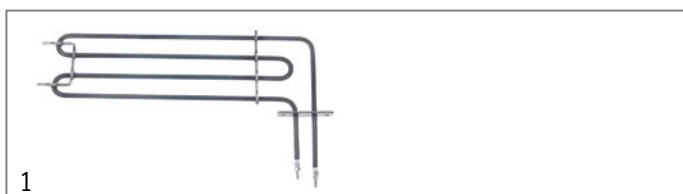

1

Part No.	419140	Ref. No.	8C0256 J03RST1B50
description	heating element 1500W 230V heating circuits 1 L 340mm W 105mm L1 30mm L2 310mm W2 90mm flange length 70mm flange width 22mm hole distance 56mm connection M4 tube $\varnothing$ 6.3mm W1 15mm windings 2		

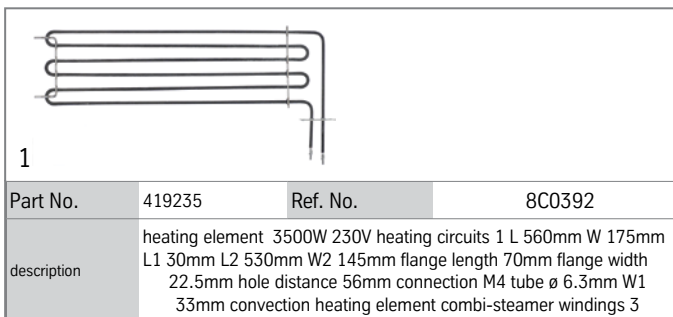

1

Part No.	419235	Ref. No.	8C0392
description	heating element 3500W 230V heating circuits 1 L 560mm W 175mm L1 30mm L2 530mm W2 145mm flange length 70mm flange width 22.5mm hole distance 56mm connection M4 tube $\varnothing$ 6.3mm W1 33mm convection heating element combi-steamer windings 3		

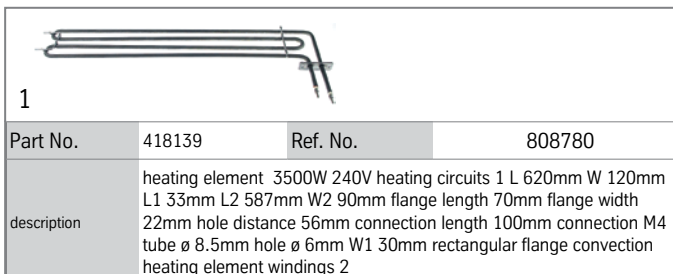

1

Part No.	418139	Ref. No.	808780
description	heating element 3500W 240V heating circuits 1 L 620mm W 120mm L1 33mm L2 587mm W2 90mm flange length 70mm flange width 22mm hole distance 56mm connection length 100mm connection M4 tube $\varnothing$ 8.5mm hole $\varnothing$ 6mm W1 30mm rectangular flange convection heating element windings 2		

## accessories

## sealing washers

## fibre gaskets

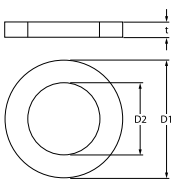
			
1			
Part No.	510405	Ref. No.	903300
description	flat gasket fibre ED $\varnothing$ 56mm ID $\varnothing$ 42mm thickness 2mm for thread 1 1/4" Qty 1 pcs		

## O-rings

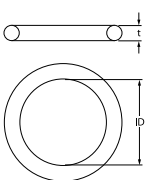
			
1			
Part No.	510245	Ref. No.	808054
description	O-ring Viton thickness 3.53mm ID $\varnothing$ 50.8mm Qty 1 pcs		

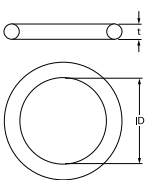
			
1			
Part No.	510243	Ref. No.	808055
description	O-ring Viton thickness 3.53mm ID $\varnothing$ 55.56mm Qty 1 pcs		



## flange gaskets



1

Part No.	510368	Ref. No.	8C0286
description	gasket L 70mm W 23.5mm hole $\varnothing$ 5mm hole distance 56mm FIBER thickness 2mm for heating element		

## energy regulators

## EGO

## 1-circuit



1

Part No.	380015	Ref. No.	809397
description	energy regulator 230V 13A single-circuit turn direction right shaft $\varnothing$ 6x4.6mm shaft L 23mm mounting thread M4 power release 6-100% no. 50.57021.010		



1

Part No.	380019	Ref. No.	806287
description	energy regulator 240V 13A single-circuit turn direction right shaft $\varnothing$ 6x4.6mm shaft L 23mm mounting thread M4 power release 6-100% no. 50.57071.010		

## thermostats

## bi-metal thermostats

## bi-metal thermostats



1

Part No.	375160	Ref. No.	809559
description	bi-metal thermostat hole distance mm switch-off temp. 110°C 1NC 1-pole 16A connection F6.3 M4		

## control and safety thermostats

## EGO

## control thermostats

## 55.10/19\_ series

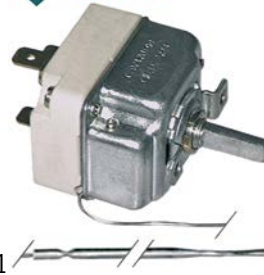

1

Part No.	375216	Ref. No.	808672
description	thermostat t.max. 280°C temperature range 50-280°C 1-pole 1NO 16A probe $\varnothing$ 3mm probe L 228mm capillary pipe 1300mm capillary pipe isolated 1150mm gland nut shaft L 23mm shaft position upper rotation 318°		



1

Part No.	375860	Ref. No.	8C0888 8C1605
description	thermostat t.max. 289°C temperature range 57-289°C 1-pole 1NO 16A probe $\varnothing$ 3.1mm probe L 226mm capillary pipe 1780mm capillary pipe isolated 1770mm gland nut shaft $\varnothing$ 6x4.6mm shaft L 23mm shaft position upper rotation 270° probe material SS		



1

Part No.	375800	Ref. No.	132110016
description	thermostat t.max. 308°C temperature range 65-308°C 1-pole 1NO 16A probe $\varnothing$ 3.03mm probe L 120mm capillary pipe 600mm capillary pipe isolated mm gland nut shaft $\varnothing$ 6x4.6mm shaft L 23mm shaft position upper rotation 270° with 2 probes		



E-G-O



Part No.	375594	Ref. No.	132110015
description	thermostat t.max. 318°C temperature range 60-318°C 1-pole 1NO 16A probe ø 3.03mm probe L 139mm capillary pipe 870mm capillary pipe isolated gland nut shaft ø 6x4.6mm shaft L 23mm shaft position upper rotation 270°		

E-G-O



Part No.	375002	Ref. No.	908326 C00563
description	thermostat t.max. 320°C temperature range 55-320°C 1-pole 1NO 16A probe ø 3.1mm probe L 226mm capillary pipe 870mm capillary pipe isolated 850mm gland nut shaft L 23mm shaft position upper rotation 270°		

E-G-O



Part No.	375253	Ref. No.	8C0363
description	thermostat t.max. 455°C temperature range 85-455°C 1-pole 1NO 16A probe ø 3.9mm probe L 228mm capillary pipe 870mm capillary pipe isolated 660mm gland nut shaft ø 6x4.6mm shaft L 23mm shaft position upper rotation 270°		

E-G-O



Part No.	375247	Ref. No.	808542
description	thermostat t.max. 500°C temperature range 75-500°C 1-pole 1NO 16A probe ø 4mm probe L 228mm capillary pipe 900mm capillary pipe isolated gland nut shaft ø 6x4.6mm shaft L 23mm shaft position upper rotation 270°		

## 55.40\_ series

E-G-O





Part No.	375185	Ref. No.	806189
description	thermostat t.max. 320°C temperature range 53-320°C 4-pole 4NO 16A probe ø 3.9mm probe L 228mm capillary pipe 880mm capillary pipe isolated gland nut shaft ø 6x4.6mm shaft L 23mm shaft position upper rotation 270°		

## safety thermostats

## 55.10/19\_ series

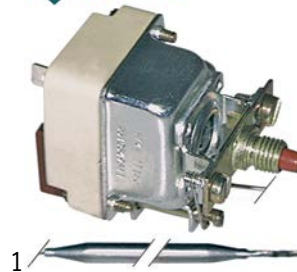
E-G-O



Part No.	375250	Ref. No.	808671	
description	safety thermostat capillary pipe 870mm probe ø 6mm 1-pole probe L 129mm 16A capillary pipe isolated gland nut switch-off temp. 130°C probe SS			
spare parts for	375250			
	Part No.	551083	Ref. No.	—
cap for safety thermostat thread M8x1				

## 55.32\_ series

E-G-O

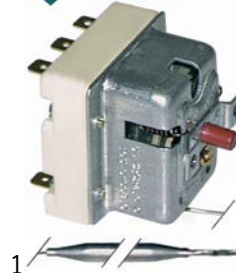

Part No.	375277	Ref. No.	808057
description	safety thermostat switch-off temp. 150°C 3-pole 3NC 20A probe ø 6mm probe L 79mm capillary pipe 900mm capillary pipe isolated 700mm gland nut probe		





**E-G-O**

1

Part No.	375628	Ref. No.	808718
description	safety thermostat switch-off temp. 350°C 3-pole 20A probe ø 4mm probe L 120mm capillary pipe 900mm capillary pipe isolated 670mm gland nut M10x1 probe SS		

**E-G-O**

1

Part No.	390141	Ref. No.	513130206
description	safety thermostat switch-off temp. 350°C 3-pole 3NC 20A probe ø 6mm probe L 77mm capillary pipe 1490mm capillary pipe isolated 800mm gland nut probe SS		

**E-G-O**

1

Part No.	390142	Ref. No.	807790
description	safety thermostat switch-off temp. 360°C 3-pole 20A probe ø 3.1mm probe L 188mm capillary pipe 1490mm capillary pipe isolated 800mm gland nut probe SS		

## 56.\_ series

**E-G-O**

1

Part No.	390797	Ref. No.	809505
description	safety thermostat switch-off temp. 157°C 1-pole 16A probe ø 6mm probe L 62mm capillary pipe 1520mm capillary pipe isolated 1380mm gland nut probe		

**E-G-O**

1

Part No.	375159	Ref. No.	809504
description	safety thermostat switch-off temp. 365°C 1-pole 16A probe ø 4mm probe L 96mm capillary pipe 1160mm capillary pipe isolated 1100mm gland nut probe with special screwing screw connection M14x1		

## CAEM

## safety thermostats

1

Part No.	375456	Ref. No.	809891
description	safety thermostat switch-off temp. 335°C 2-pole 20A probe ø 3mm probe L 200mm capillary pipe 1050mm capillary pipe isolated 650mm gland nut probe SS at 250V 20A at 400V 10A		

## accessories

## connecting bows

1

Part No.	550060	Ref. No.	C00218
description	connecting bow long for thermostat Qty 1 pcs		



## switches and momentary switches

## rocker/momentary rocker switches

## 30x22mm



1

Part No.	301003	Ref. No.	712110000 818181
description	rocker switch mounting measurements 30x22mm green 2NO 250V 16A illuminated 0-I connection male faston 6.3mm ambient temperature max. 125/55°C protection IP65		
accessories for	301003		
	Part No.	301036	Ref. No.
	protective cover internal size 30x22mm for rocker switch mounting measurementsmm		



1

Part No.	301001	Ref. No.	E61110003
description	rocker switch mounting measurements 30x22mm red 2NO 250V 16A illuminated 0-I connection male faston 6.3mm ambient temperature max. 125/55°C protection IP65		
accessories for	301001		
	Part No.	301036	Ref. No.
	protective cover internal size 30x22mm for rocker switch mounting measurementsmm		

## labelled



1

Part No.	301164	Ref. No.	23327
description	rocker switch mounting measurements 30x22mm green 2NO 250V 16A illuminated connection male faston 6.3mm ambient temperature max. 85°C protection IP65 with cover cap		
accessories for	301164		
	Part No.	301036	Ref. No.
	protective cover internal size 30x22mm for rocker switch mounting measurementsmm		

## push/momentary push switches

## 19x13mm



1

Part No.	347605	Ref. No.	809883
description	push switch mounting measurements 19x13mm yellow 2NO 250V 16A illuminated connection male faston 6.3mm ambient temperature max. 105°C protection IP40		
accessories for	347605		
	Part No.	346541	Ref. No.
	protective cover for rocker switch external size 23.4x17.4mm internal size 19x13mm H 9.5mm mounting measurementsmm		

## ø16mm



1

Part No.	346287	Ref. No.	809886
description	momentary push switch mounting ø 16mm red 1NO 250V 3A illuminated connection male faston 2.8mm ambient temperature max. 125/55°C protection IP65 with cover cap		

illuminated



1

Part No.	346346	Ref. No.	809600
description	momentary push switch mounting ø 16mm red 1NO/indicator light 250V 3A connection male faston 2.8mm ambient temperature max. 125/55°C protection IP40		

## ø25mm



1

Part No.	345162	Ref. No.	8C0427
description	push switch mounting ø 25mm yellow 2NO 250V 16A illuminated connection male faston 6.3mm ambient temperature max. 85°C protection IP40		

illuminated



1

Part No.	348211	Ref. No.	244230001
description	momentary push switch mounting ø 25mm red 1NO/indicator light 250V 16A illuminated connection male faston 6.3mm ambient temperature max. 85°C protection IP65 with cover		



1

Part No.	346094	Ref. No.	03-INT-B03
description	push switch mounting ø 25mm orange 2NO/indicator light 250V 16A with rubber collar connection male faston 6.3mm ambient temperature max. 85°C protection IP65		





## microswitches

## universal



1

Part No.	345042	Ref. No.	809481
description	microswitch with plunger 250V 16A 1CO connection male faston 6.3mm L 28mm ambient temperature max. 125°C mounting distance 22mm type EF83161.3 actuating force: 75g blue/black		
accessories for	345042		
	Part No.	345043	Ref. No.
			—
	lever set 5-piece		

## lever actuated



1

Part No.	345254	Ref. No.	E00010041
description	microswitch with lever 250V 16A 1CO connection male faston 6.3mm ambient temperature max. 120°C mounting distance 22mm actuating force: 60g lever length 58mm		

1

Part No.	300128	Ref. No.	807999 808053
description	microswitch with lever 250V 16A 1CO connection male faston 6.3mm ambient temperature max. 85°C lever length 63mm		

1

Part No.	346314	Ref. No.	132110023
description	microswitch with lever 250V 16A 1CO connection male faston 6.3mm L 56mm ambient temperature max. 125°C mounting distance 22mm type VRSR01DA1 actuating force: 50g		

1

Part No.	345125	Ref. No.	809568
description	microswitch with lever 250V 16A 1CO connection male faston 6.3mm ambient temperature max. 85°C mounting distance 25mm type C99ZP3 actuating force: 25g lever length 63.5mm		

## roller-lever actuated

## microswitches

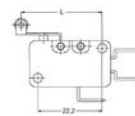

1

Part No.	345041	Ref. No.	808879 8C2018 E61110082
description	microswitch with handle with a switch 250V 16A 1CO connection male faston 6.3mm ambient temperature max. 85°C black lever length 20.5mm		

## pin-plunger actuated



1

Part No.	345042	Ref. No.	809481
description	microswitch with plunger 250V 16A 1CO connection male faston 6.3mm L 28mm ambient temperature max. 125°C mounting distance 22mm type EF83161.3 actuating force: 75g blue/black		
accessories for	345042		
	Part No.	345043	Ref. No.
			—
	lever set 5-piece		

## M10



1

Part No.	347216	Ref. No.	807351 E61110053
description	microswitch with plunger thread M10x0.75 thread L 14mm 250V 10A 1CO connection male faston 6.3mm stroke 7.5mm mounting distance 22mm L 28mm ambient temperature max. 125°C type NR6K5 actuating force: 260g		

1

Part No.	345032	Ref. No.	61110053
description	microswitch with plunger thread M10x1 thread L 12mm 250V 16A 1CO connection male faston 6.3mm stroke 7mm mounting distance 22mm L 28mm ambient temperature max. 125°C type SP9603 actuating force: 180g		





			
1			
Part No.	345156	Ref. No.	809173 809885
description	microswitch with plunger thread M10x1 thread L 13mm 250V 16A 1CO connection male faston 6.3mm stroke 6mm mounting distance 25mm L 46mm L1 13mm ambient temperature max. 85°C type C4AZN3 actuating force: 340g		

## system switches (ROLD)

			
1			
Part No.	345131	Ref. No.	808948
description	element holder mounting measurements 28.5x28.5mm grey single element holder		

			
1			
Part No.	345536	Ref. No.	03-PLS-011
description	element holder mounting ø 16mm flat black		

			
1			
Part No.	345606	Ref. No.	809021
description	momentary switch unit 2CO 250V 16A connection male faston 6.3mm		

			
1			
Part No.	345538	Ref. No.	03-PLS-012
description	push button ø 11.9mm black		

			
1			
Part No.	346211	Ref. No.	808950
description	push button ø 23mm grey with lens		

			
1			
Part No.	346364	Ref. No.	808949
description	rotary disc red/white disc ø 20.6mm		

			
1			
Part No.	345605	Ref. No.	808807
description	switch 2CO 250V 16A connection male faston 6.3mm		

## cam switches

on/off

			
1			
Part No.	300129	Ref. No.	808145
description	cam switch 2 operating positions 2NO sequence 0-1 16A shaft ø 6x4.6mm shaft L 23mm connection male faston 6.3mm ceramic		

			
1			
Part No.	300088	Ref. No.	808687 C00685
description	cam switch 2 operating positions 4NO sequence 0-1 16A shaft ø 6x4.6mm shaft L 23mm connection male faston 6.3mm ceramic		



			
1			
Part No.	300074	Ref. No.	806286
description	cam switch 4 operating positions 2NO sequence 0-1-0-1 16A shaft ø 6x4.6mm shaft L 23mm connection male faston 6.3mm ceramic		



7-position



1

Part No.	300025	Ref. No.	C00213
description	cam switch 7 operating positions 1NO/2CO sequence 0-1-2-3-4-5-6 16A shaft ø 6x4.6mm shaft L 23mm connection screw 7-position ceramic		
accessories for	300025		
	Part No.	112172	Ref. No. —
	knob universal ø 70mm black without adaptor/dial plate		
	Part No.	112213	Ref. No. —
	knob dial plate silver switch 7-position t.max.°C°C ED ø 63mm ID ø 45.5mm		
	Part No.	112311	Ref. No. —
	knob adapter shaft ø 6x4.6mm L 0mm with spring		

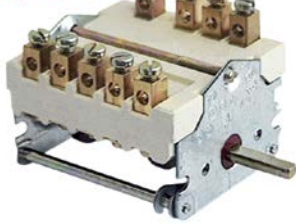

1

Part No.	300106	Ref. No.	806160 C00214
description	cam switch 7 operating positions 1NO/2CO sequence 0-1-2-3-4-5-6 32A shaft ø 6x4.6mm shaft L 23mm connection screw 7-position shaft flat upper		

4 operating positions

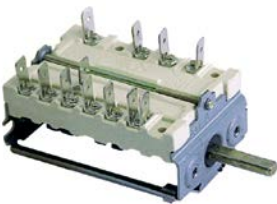

1

Part No.	300010	Ref. No.	807290 808806
description	cam switch 4 operating positions 2NO/2CO sequence 0-1-2-3 16A shaft ø 6x4.6mm shaft L 23mm connection male faston 6.3mm ceramic		

5 operating positions

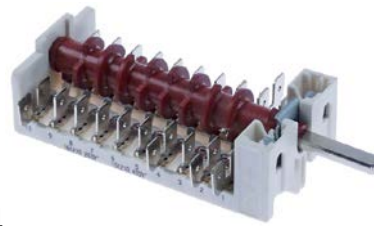

1

Part No.	347652	Ref. No.	808962
description	cam switch 5 operating positions 5NO/2CO sequence 0-1-2-3-4 16A shaft ø 6x4.6mm shaft L 23mm connection male faston 6.3mm plastic		

operation switches



1

Part No.	300002	Ref. No.	808052 C00690
description	cam switch 2 operating positions 4NO 16A sequence 0-1 shaft ø 6x4.6mm shaft L 23mm connection male faston 6.3mm ceramic		

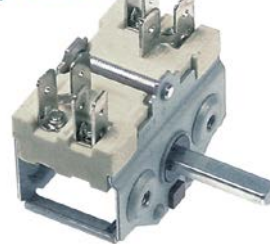

1

Part No.	300200	Ref. No.	C00217
description	operation switch 2 operating positions 2NO 16A sequence 0-1 shaft ø 6x4.6mm shaft L 23mm connection male faston 6.3mm operation switch ceramic		



## magnetic switches

## 32x15mm



1

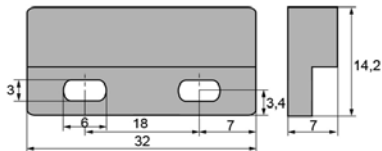



Part No.	345109	Ref. No.	809557
description	magnetic switch L 32mm W 15mm 1NO 250V 1A P max. 40W connection cable cable length 2000mm		

## 36x13mm

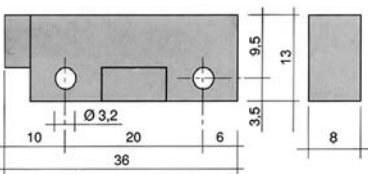

1





Part No.	345335	Ref. No.	25110113 8C0129
description	magnetic switch L 36mm W 13mm 1NO 250V 0.04A P max. 10W connection cable cable length 960mm		
accessories for	345335		
	Part No.	519049	Ref. No. 903651 TR0220
	magnet ømm L 63mm H 10.7mm W 18.8mm hole distance 52mm M2 hole ø 2mm		

## 37x16mm

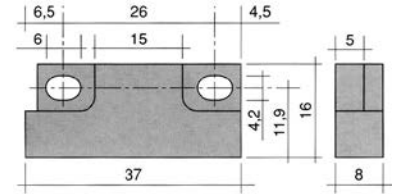

1





Part No.	345600	Ref. No.	TR0666
description	magnetic switch L 37mm W 16mm 1NO 250V 0.2A P max. 50W connection cable cable length 960mm		
accessories for	345600		
	Part No.	519049	Ref. No. 903651 TR0220
	magnet ømm L 63mm H 10.7mm W 18.8mm hole distance 52mm M2 hole ø 2mm		

## M10x0.75

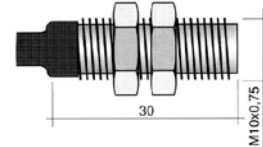

1



Part No.	345632	Ref. No.	TR0309
description	magnetic switch thread M10x0.75 1NO 250V 0.5A P max. 50W connection cable cable length 2000mm type 102		
accessories for	345632		
	Part No.	100779	Ref. No. —
	nut thread M10x0.75 H 3mm WS 14 SS Qty 2 pcs		

## accessories



## magnets



1

Part No.	691178	Ref. No.	8C2146
description	magnet ø 22mm Lmm H 7mm Wmm ED ø 22mm M5		

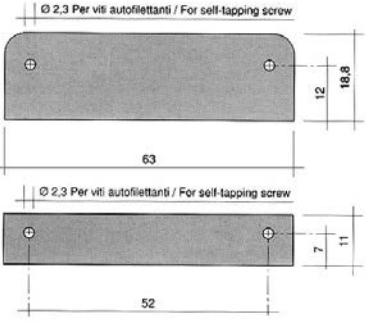

			
	1		
Part No.	519049	Ref. No.	903651 TR0220
description	magnet ømm L 63mm H 10.7mm W 18.8mm hole distance 52mm M2 hole ø 2mm		
accessories for	519049		
	Part No.	560095	Ref. No.
	sheet metal screws ø 2.9mm L 9.5mm SS Qty 20 pcs DIN 7981/ ISO 7049 head ø 5.6mm oval head		

## control equipment

## TELEMECANIQUE (EFA)

## XB2 series

	1			
	Part No.	345412	Ref. No.	C00279
description	contact block with holder 1N0			
spare parts for	345412			
	Part No.	345220	Ref. No.	—
	contact block EFA ZB2BE101 1N0 max 230V 10(6)A black			
	Part No.	345221	Ref. No.	—
	contact block EFA ZB2BE102 1NC max 230V 10(6)A black			
	Part No.	347526	Ref. No.	—
	contact block holder for XB2			

## lamps

## indicator lights

## indicator lights 2-piece (lens and indicator lamp)

## indicator light lenses

## ø13mm (type SFK-3)

	1		
	Part No.	359126	Ref. No.
description	indicator light housings mounting measurements ø13mm green Qty 1 pcs		

	1		
	Part No.	359127	Ref. No.
description	indicator light housings mounting measurements ø13mm yellow Qty 1 pcs		

## indicator lamps for socket type SRZ / SDK / SDY / SFK

	1		
	Part No.	359130	Ref. No.
description	indicator lamp 230V clear connection male faston 6.3mm ø 8mm		

	1		
	Part No.	359132	Ref. No.
description	indicator lamp green 250V connection male faston 6.3mm protection IP54 ambient temperature max. 85°C		

## indicator lights (complete)

## ø 6mm

	1		
	Part No.	359031	Ref. No.
description	indicator light ø 6mm 230V green		

## ø10mm

## with plug-in socket

	1		
	Part No.	359139	Ref. No.
description	indicator light ø 10mm green 230V connection male faston 6.3mm Qty 1 pcs		

	1		
	Part No.	359138	Ref. No.
description	indicator light ø 10mm red 230V connection male faston 6.3mm Qty 1 pcs		

	1		
	Part No.	359140	Ref. No.
description	indicator light ø 10mm yellow 230V connection male faston 6.3mm Qty 1 pcs		





ø13mm

with plug-in socket



1

Part No.	359142	Ref. No.	807773
description	indicator light ø 13mm green 230V connection male faston 6.3mm temp.-resist. 120°C Qty 1 pcs		



1

Part No.	359143	Ref. No.	806128
description	indicator light ø 13mm yellow 230V connection male faston 6.3mm temp.-resist. 120°C Qty 1 pcs		

30x22mm



1

Part No.	359157	Ref. No.	806080	
description	indicator light mounting measurements 30x22mm 230V green connection male faston 6.3mm temp.-resist. 125/55°C type RL2			
accessories for	359157			
	Part No.	301036	Ref. No.	—
	protective cover internal size 30x22mm for rocker switch mounting measurementsmm			

screw-on/push-on fit

light bulbs

for ovens



1

Part No.	359610	Ref. No.	818281
description	light bulb t.max. 300°C socket E14 15W 230V ø 22mm L 47mm lens L 20mm for oven lamp type Philips		



1

Part No.	357153	Ref. No.	03-LMP-25W 809884
description	light bulb t.max. 300°C socket E14 25W 230V ø 25mm L 55mm lens L 30mm for oven type 120 1000		

halogen lamp

for socket G4 / G6.35 / G9



1

Part No.	359599	Ref. No.	03-LMP-20W
description	halogen lamp socket G4 12V 20W temp.-resist. 500°C 250 2000		



oven lamps

universal oven lamps

mounting diameter 35.5mm







1

Part No.	359718	Ref. No.	809935	
description	oven lamp mounting ø 35.5mm 230V 15W socket E14 temp.-resist. 300°C connection male faston 6.3mm hard glas			
spare parts for	359718			
	Part No.	359701	Ref. No.	03-PLM-001 809715 8C0278
	lamp socket socket E14 220-230V mounting ø 35.5mm connection male faston 6.3mm 15W			
	Part No.	359740	Ref. No.	—
	light bulb t.max. 300°C socket E14 15W 230V ø 22mm L 48mm lens L 20mm for oven lamp IMPORT 70 1000			





1

Part No.	359701	Ref. No.	03-PLM-001 809715 8C0278	
description	lamp socket socket E14 220-230V mounting ø 35.5mm connection male faston 6.3mm 15W			
accessories for	359701			
	Part No.	359705	Ref. No.	—
	oven lamp glass thr.ø 33.5mm ø 52mm hard glas temp.-resist. 350°C			
	Part No.	359709	Ref. No.	—
	oven lamp glass thr.ø 33.5mm ø 42mm hard glas temp.-resist. 350°C			
	Part No.	359721	Ref. No.	—
	gasket silicone ED ø 48mm ID ø 39.5mm thickness 5mm Qty 1 pcs			
	Part No.	359942	Ref. No.	—
	oven lamp glass thr.ø 33.5mm H 39mm ø 40mm hard glas temp.-resist. 350°C			





 <p>1</p>			
Part No.	359661	Ref. No.	808808
description	oven lamp glass thread 32.1 ø 58mm hard glas temp.-resist. 350°C		
accessories for	359661		
	Part No.	359700	Ref. No. —
gasket for pizza oven fibre glass ID ø 32.5mm ED ø 55mm thickness 5mm			
	Part No.	360782	Ref. No. —
gasket for bulb socket fibre glass ID ø 35mm ED ø 45mm thickness 5mm			



mounting diameter 47.8mm

 <p>1</p>			
Part No.	525313	Ref. No.	808709
description	O-ring Viton ID ø 60.33mm thickness 3.53mm Qty 1 pcs		

 <p>1</p>			
Part No.	532649	Ref. No.	808710
description	O-ring Viton ID ø 63.17mm thickness 2.62mm Qty 1 pcs		



mounting diameter 65.5mm

 <p>1</p>			
Part No.	359712	Ref. No.	808850
description	oven lamp mounting ø 65.5mm 230V 40W socket E14 temp.-resist. 300°C connection male faston 6.3mm hard glas		
spare parts for	359712		
	Part No.	359022	Ref. No. —
lamp socket socket E14 mounting ø 65.5mm connection male faston 6.3mm			
	Part No.	359611	Ref. No. —
light bulb t.max. 300°C socket E14 40W 230V ø 45mm L 75mm lens L 50mm for oven lamp IMPORT			

spare parts for	359712		
	Part No.	359722	Ref. No. —
gasket silicone ID ø 57.5mm ED ø 68mm thickness 2mm			
	Part No.	359724	Ref. No. 808851
oven lamp glass thread ø 62mm H 46mm ø 74mm hard glas temp.-resist. 350°C			

 <p>1</p>			
Part No.	359724	Ref. No.	808851
description	oven lamp glass thread ø 62mm H 46mm ø 74mm hard glas temp.-resist. 350°C		

55x70mm

 <p>1</p>			
Part No.	359297	Ref. No.	131110027
description	frame L 95mm W 81mm mounting distance 68/83mm thickness 6mm		
accessories for	359297		
	Part No.	359299	Ref. No. —
gasket L 91mm W 77mm hole ø 3mm for oven lamp			

55x100mm







 <p>1</p>			
Part No.	359698	Ref. No.	808979
description	lamp socket L 100mm W 55mm socket E14 connection male faston 6.3mm		
spare parts for	359698		
	Part No.	358119	Ref. No. —
frame L 118mm W 72mm mounting distance 143mm for bulb socket			
	Part No.	358122	Ref. No. —
gasket L 112mm W 68mm silicone thickness 3mm for bulb socket			
	Part No.	358123	Ref. No. —
lamp glass L 112mm W 68mm			
	Part No.	359612	Ref. No. —
light bulb t.max. 300°C socket E14 25W 230V ø 25mm L 56mm lens L 30mm for oven lamp type Philips			

Table continues overleaf





spare parts for	359698			
	Part No.	359714	Ref. No.	808977 809341
gasket silicone L 140mm W 75mm for bulb socket				
	Part No.	359715	Ref. No.	808976
lamp glass L 110mm W 65mm thickness 5mm				
	Part No.	359716	Ref. No.	808975
frame for bulb socket				
accessories for	359698			
	Part No.	359612	Ref. No.	—
light bulb t.max. 300°C socket E14 25W 230V ø 25mm L 56mm lens L 30mm for oven lamp type Philips				
	Part No.	359938	Ref. No.	—
borosilicate glass L 115mm W 69mm				

				
1				
Part No.	359716	Ref. No.	808975	
description	frame for bulb socket			

				
1				
Part No.	359714	Ref. No.	808977 809341	
description	gasket silicone L 140mm W 75mm for bulb socket			

				
1				
Part No.	359715	Ref. No.	808976	
description	lamp glass L 110mm W 65mm thickness 5mm			

				
1				
Part No.	359698	Ref. No.	808979	
description	lamp socket L 100mm W 55mm socket E14 connection male faston 6.3mm			
spare parts for	359698			
	Part No.	358119	Ref. No.	—
frame L 118mm W 72mm mounting distance 143mm for bulb socket				
	Part No.	358122	Ref. No.	—
gasket L 112mm W 68mm silicone thickness 3mm for bulb socket				

spare parts for	359698			
	Part No.	358123	Ref. No.	—
lamp glass L 112mm W 68mm				
	Part No.	359612	Ref. No.	—
light bulb t.max. 300°C socket E14 25W 230V ø 25mm L 56mm lens L 30mm for oven lamp type Philips				
	Part No.	359714	Ref. No.	808977 809341
gasket silicone L 140mm W 75mm for bulb socket				
	Part No.	359715	Ref. No.	808976
lamp glass L 110mm W 65mm thickness 5mm				
	Part No.	359716	Ref. No.	808975
frame for bulb socket				
accessories for	359698			
	Part No.	359612	Ref. No.	—
light bulb t.max. 300°C socket E14 25W 230V ø 25mm L 56mm lens L 30mm for oven lamp type Philips				
	Part No.	359938	Ref. No.	—
borosilicate glass L 115mm W 69mm				

				
1				
Part No.	101372	Ref. No.	808569	
description	oven lamp complete L 100mm W 55mm 230V 25W socket E14 rectangular temp.-resist. 300°C connection male faston 6.3mm			
spare parts for	101372			
	Part No.	359612	Ref. No.	—
light bulb t.max. 300°C socket E14 25W 230V ø 25mm L 56mm lens L 30mm for oven lamp type Philips				
	Part No.	359698	Ref. No.	808979
lamp socket L 100mm W 55mm socket E14 connection male faston 6.3mm				
	Part No.	359714	Ref. No.	808977 809341
gasket silicone L 140mm W 75mm for bulb socket				
	Part No.	359715	Ref. No.	808976
lamp glass L 110mm W 65mm thickness 5mm				
	Part No.	359716	Ref. No.	808975
frame for bulb socket				



**lamps**

**light bulbs**



Part No.	359610	Ref. No.	818281
description	light bulb t.max. 300°C socket E14 15W 230V ø 22mm L 47mm lens L 20mm for oven lamp type Philips		



Part No.	357153	Ref. No.	03-LMP-25W 809884
description	light bulb t.max. 300°C socket E14 25W 230V ø 25mm L 55mm lens L 30mm for oven type 120 1000		

**halogen lamps**

**for socket G4 / G6.35 / G9**



Part No.	359599	Ref. No.	03-LMP-20W
description	halogen lamp socket G4 12V 20W temp.-resist. 500°C 250 2000		

**timers**

**electric timers**

**with time spread**



Part No.	350074	Ref. No.	809442
description	timer MS65 operation time 120min time spread 30min 1CO/2NO/1NC at 250V 16A permanent position yes impulse electric shaft ø 6x4.6mm shaft L 22mm mounting distance 28mm connection lateral Invensys 4-pole shaft position lower°		



Part No.	350073	Ref. No.	8C1391
description	timer MS65 with buzzer board operation time 120min time spread 30min 1CO/1NC/2NO at 250V 16A permanent position yes impulse electric shaft ø 6x4.6mm shaft L 20mm with bell mounting distance 28mm connection lateral 3-pole		

**mechanical timers**



Part No.	350159	Ref. No.	132110014
description	timer M2 2-pole operation time 120min impulse mechanical 2CO at 250V 16A permanent position yes shaft ø 6x4.6mm shaft 6x4.6mm shaft L 22mm mounting distance 28mm mounting thread M4 connection male faston 6.3mm ambient temperature max. 125°C with buzzer		
spare parts for	350159		
Part No.	350076	Ref. No.	—
description	buzzer board 12V connection male faston 6.3mm		
Part No.	350186	Ref. No.	—
description	timer M2 2-pole operation time 120min impulse mechanical 2CO at 250V 16A permanent position yes shaft ø 6x4.6mm shaft 6x4.6mm shaft L 23mm mounting distance 28mm		



Part No.	350030	Ref. No.	8C2008
description	timer M2 2-pole operation time 120min impulse mechanical 2NO at 250V 16A permanent position no shaft ø 6x4.6mm shaft 6x4.6mm shaft L 23mm mounting distance 28mm connection lateral		
accessories for	350030		
Part No.	110366	Ref. No.	—
description	knob switch zero mark t.max.°C ø 44mm shaft ø 6x4.6mm shaft flat upper black		
Part No.	111199	Ref. No.	—
description	dial plate graduation 120min permanent position no rotation 0-330° ø 60mm timers knob ø 45mm		



Part No.	350003	Ref. No.	813170
description	timer M2 with bell 2-pole operation time 120min impulse mechanical 2NO at 250V 16A permanent position no shaft ø 6x4.6mm shaft 6x4.6mm shaft L 23mm mounting distance 28mm connection lateral		
accessories for	350003		
Part No.	110366	Ref. No.	—
description	knob switch zero mark t.max.°C ø 44mm shaft ø 6x4.6mm shaft flat upper black		
Part No.	111199	Ref. No.	—
description	dial plate graduation 120min permanent position no rotation 0-330° ø 60mm timers knob ø 45mm		



1

Part No.	350008	Ref. No.	809674
description	timer M2 with bell 2-pole operation time 120min impulse mechanical 2NO at 250V 16A permanent position yes shaft $\varnothing$ 6x4.6mm shaft 6x4.6mm shaft L 24mm mounting distance 28mm connection lateral		

## alarm devices

## buzzers



1

Part No.	350136	Ref. No.	809553
description	buzzer 12VAC connection cable 200mm screw mounting 63dB		

## contactors

## GENERAL ELECTRIC (AEG)

## power contactors



1

Part No.	380239	Ref. No.	03-CNT-25230
description	power contactor resistive load 20A 230VAC (AC3/400V) 8.4A/4kW main contacts 3NO auxiliary contacts 1NC connection screw connection type LS05 01A type AEG LS05 01A type GE MC1A 301A		



1

Part No.	380244	Ref. No.	00006280 807553 8C0148
description	power contactor resistive load 25A 230VAC (AC3/400V) 9A/4kW main contacts 3NO auxiliary contacts 1NO connection screw connection type AEG LS4K 10A type GE CL00A 310		



1

Part No.	380262	Ref. No.	00006220
description	power contactor resistive load 32A 230VAC (AC3/400V) 17A/7.5kW main contacts 3NO auxiliary contacts 1NC connection screw connection type AEG LS7K01A type GE CL02A 301 H 85mm		



1

Part No.	380261	Ref. No.	C00571
description	power contactor resistive load 32A 230VAC (AC3/400V) 17A/7.5kW main contacts 3NO auxiliary contacts 1NO connection screw connection type AEG LS7K 10A type GE CL02A 310		

## LOVATO

## power contactors



1

Part No.	380705	Ref. No.	907041 907190 C00287
description	power contactor resistive load 20A 230VAC (AC3/400V) 9A/4kW main contacts 3NO auxiliary contacts 1NO connection screw connection type 11BG0910A230		

accessories for	380705			
	Part No.	380057	Ref. No.	—
	auxiliary contact contacts 1NO/1NC AC1 10A for contactors BG series connection screw type BGX1011			



SIEMENS

power contactors



1

Part No.	380645	Ref. No.	809820
description	power contactor 230VAC with auxiliary contacts		



1

Part No.	380646	Ref. No.	3229250
description	power contactor resistive load 40A 230VAC (AC3/400V) 17A/7.5kW main contacts 3NO auxiliary contacts connection screw connection type 3RT10-25-1AL20		

overload switches



1

Part No.	381002	Ref. No.	808952
description	overload switch setting range 1.8-2.5A		

TELEMECANIQUE (Schneider Electric)

power contactors



1

Part No.	380617	Ref. No.	00060670
description	power contactor resistive load 25A 24VAC (AC3/400V) 9A/4kW main contacts 3NO auxiliary contacts 1NO/1NC connection screw connection type LC1D09B7		

OMRON

power contactors



1

Part No.	380882	Ref. No.	8C0216
description	power contactor resistive load 25A 230VAC AC3 10A main contacts 3NO auxiliary contacts 1NO connection screw connection type J7KN-10D-10 OMRON		

solid state relays

CELDUC



1

Part No.	400105	Ref. No.	809558
description	solid state relay CELDUC 2 phase 65A 400V 24VDC L 58mm W 45mm plug-in connection screw type 40.00.453		
accessories for	400105		
	Part No.	401794	Ref. No. —
	connecting cable L 1440mm 4-pole suitable for RATIONAL		





## relays

## power relays

## with bracket mounting



1

Part No.	380626	Ref. No.	25130102
description	power relays FINDER 230VAC 10A 2CO connection male faston 4.8mm bracket mounting manuf. no. 62.62.8.230.0000		



1

Part No.	380312	Ref. No.	23190
description	power relays FINDER 230VAC 10A 3CO connection male faston 4.8mm bracket mounting dimensions 52x32.2x36.5mm manuf. no. 60.63.8.230.0000		



1

Part No.	380139	Ref. No.	25130100 809863
description	power relays FINDER 230VAC 16A 2CO connection F6.3 bracket mounting dimensions 68x38.2x35.8mm manuf. no. 62.82.8.230.0000		



1

Part No.	380403	Ref. No.	905475
description	power relays FINDER 230VAC 16A 3CO connection F6.3 bracket mounting manuf. no. 62.83.8.230.0500		



1

Part No.	380808	Ref. No.	905476
description	power relays FINDER 230VAC 16A 3CO connection male faston 6.3mm bracket mounting manuf. no. 62.83.8.230.0000		

## with male contacts

## female contact 2.0mm



1

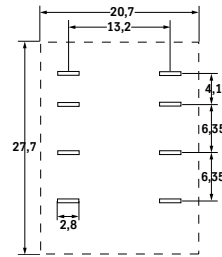

Part No.	380129	Ref. No.	809015
description	power relays 24VAC 12A 2CO connection F2 plug-in connection 94.92.3 250V connection 2mm		

accessories for	380129			
	Part No.	380341	Ref. No.	—
	relay socket 4-pole contacts 12 300V voltage AC 6A Italiana Relé manuf. no. ZMD4			
	Part No.	380378	Ref. No.	—
	relay socket 2-pole 55/85 dimensions 70.5x30x27mm 250V voltage AC 10A FINDER manuf. no. 94.72			
	Part No.	380384	Ref. No.	—
	relay socket 2-pole contacts male faston 2.8mm 250V voltage AC 10A W 23mm for			
	Part No.	380399	Ref. No.	—
	relay socket 4-pole dimensions 76.2x27x86.1mm 250V voltage AC 1A FINDER manuf. no. 94.94.3			

## plug-in/print relays



1

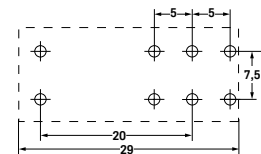



Part No.	380333	Ref. No.	J03REL001	
description	print relay 230VAC 2CO at 250V 8A connection pins raster size 5mm FINDER manuf. no. 40.52.8.230.0000 95.65/95.75			
accessories for	380333			
	Part No.	380340	Ref. No.	—
	relay socket dimensions 62x36x15mm 250V voltage AC 10A Italiana Relé manuf. no. ZMEM/5			

Table continues overleaf





accessories for	380333			
	Part No.	380505	Ref. No.	—
	relay socket 2CO 40.52 dimensions 81.9x15.5x75mm 250V voltage AC 10A FINDER manuf. no. 95.95.3			
	Part No.	381181	Ref. No.	—
	relay socket 2-pole 40.51/40.52/40.61 connection screw clamp dimensions 15.8x78.6mm 250V voltage AC 10A FINDER manuf. no. 95.75			

relay sockets

	1		
Part No.	380638	Ref. No.	809018
description	relay socket 8-pole dimensions 51x41x23mm 250V 10A FINDER manuf. no. 90.26		



level relays



GICAR

	1		
Part No.	401173	Ref. No.	807853
description	level relay 230V connection F6.3 type RL30/3ES/F		

time relays

time relays

	1			
Part No.	380639	Ref. No.	809016	
description	time relay TECNOLOGIC RTR12DS06S time range 6s 230VAC 5A mounting measurements 34x34mm 1CO connection plug-in connection round 8-pole			
accessories for	380639			
	Part No.	380638	Ref. No.	809018
	relay socket 8-pole dimensions 51x41x23mm 250V 10A FINDER manuf. no. 90.26			

	1			
Part No.	380640	Ref. No.	809019	
description	time relay TECNOLOGIC RTR12DS60S time range 60s 230VAC 5A 1CO connection plug-in connection round 8-pole			
accessories for	380640			
	Part No.	380638	Ref. No.	809018
	relay socket 8-pole dimensions 51x41x23mm 250V 10A FINDER manuf. no. 90.26			

transformers

encapsulated transformers

PMA

	1		
Part No.	379054	Ref. No.	22192006
description	transformer primary 230VAC secondary 12VAC 3VA secondary 0.25A H 40mm L 45mm W 50mm connection screw 50/60Hz type 153/M		

electronic controllers

ELIWELL





universal controllers

built-in version

	1			
Part No.	379605	Ref. No.	831131 8C0227	
description	electronic controller ELIWELL type ICPPlus915 model ICP22JI35000 mounting measurements 71x29mm 12V voltage AC/DC Pt100/TC (J,K) relay outputs 2 NO-8A(4) NO-8A(4) Pt100/TC (J,K) cooking front measurements 78x37mm built-in depth 59mm mode of operation cooking protection IPx0 accuracy 1% built-in version defr. funct. no dependend on probe°C display 3 1/2 digits			
accessories for	379605			
	Part No.	379050	Ref. No.	—
	temperature probe Pt100 cable Vetrotex probe -200 up to +600°C cable -50 up to +350°C probe ø6x100mm cable length 2.7m without screw connection 3-wire			

Table continues overleaf



accessories for	379605		
	Part No.	379054	Ref. No. 22192006
	transformer primary 230VAC secondary 12VAC 3VA secondary 0.25A H 40mm L 45mm W 50mm connection screw 50/60Hz type 153/M		
	Part No.	379785	Ref. No. —
	temperature probe Pt100 cable silicone probe -100 up to 450°C cable -50 up to +180°C probe ø6x100mm cable length 1.5m without screw connection 2-wire resistor 0.1kOhm		
	Part No.	379786	Ref. No. —
	temperature probe Pt100 cable silicone probe -100 up to 450°C cable -50 up to +180°C probe ø6x100mm cable length 3m without screw connection 2-wire resistor 0.1kOhm		
	Part No.	379787	Ref. No. —
	temperature probe Pt100 cable Vetrotex probe -200 up to +600°C cable -50 up to +350°C probe ø6x100mm cable length 1.4m without screw connection 2-wire resistor 0.1kOhm		





## EVCO - EVERY CONTROL

### universal controllers

#### built-in version



1

Part No.	378169	Ref. No.	807302 8C0173
description	electronic controller EVERY CONTROL EV7401 mounting measurements 66.5x66.5mm built-in depth 90mm 24/230V voltage AC NTC/ PTC/Pt100/ TC(J,K)/mA relay outputs 1 CO-8A(3) NTC/PTC/Pt100/TC(-J,K)/mA yes protection IP54 dependent on probe°C display 4 digits		
accessories for	378169		
	Part No.	379053	Ref. No. —
	temperature probe PTC 1kOhm cable PVC probe -50 up to +150°C cable -10 up to 100°C probe ø6x30mm cable length 3m without screw connection 2-wire		
	Part No.	379062	Ref. No. —
	temperature probe thermocouple J (Fe-CuNi) cable Vetrotex probe -50 up to +750°C cable -50 up to +350°C probe ø6x50mm cable length 3m without screw connection 2-wire		
	Part No.	379064	Ref. No. —
	temperature probe PTC 1kOhm cable silicone probe -50 up to +150°C cable -50 up to +180°C probe ø6x40mm cable length 3m without screw connection 2-wire		
	Part No.	379131	Ref. No. —
	temperature probe Pt100 cable Vetrotex probe -200 up to +600°C cable -50 up to +350°C probe ø6x85mm cable length 3m without screw connection 3-wire resistance at 0°C 1000hm		
	Part No.	379161	Ref. No. —
	temperature probe NTC 10kOhm cable thermoplastic probe -40 up to +110°C cable -40 up to +110°C probe ø6x14mm cable length 3m without screw connection 2-wire		

	1		
Part No.	378151	Ref. No.	809889 8C0258
description	electronic controller EVERY CONTROL EVK412 mounting measurements 71x29mm built-in depth 59mm 12/24V voltage AC/DC NTC/PTC/Pt100/Pt1000/TC(J,K)/mV/mA relay outputs 2 CO-16A(8) CO-8A(3) NTC/PTC/Pt100/Pt1000/TC(J,K)/mV/mA yes protection IP54 dependent on probe°C display 4 digits		

### timers



1

Part No.	379522	Ref. No.	809892
description	electronic timer EVERY CONTROL type EVK702D2VXS mounting measurements 71x29mm 12V voltage AC/DC time setting range 0.1s.-99h:59min display 4 digits relay outputs 2 8A 8A front measurements 75x33mm		

## SHANGFANG

### accessories



1

Part No.	379054	Ref. No.	22192006
description	transformer primary 230VAC secondary 12VAC 3VA secondary 0.25A H 40mm L 45mm W 50mm connection screw 50/60Hz type 153/M		

### probes

#### universal probes

#### temperature probes





Part No.	378699	Ref. No.	22192003
description	temperature probe PTC 1kOhm cable PVC probe -30 up to +80°C cable -30 jusqu'à +110°C probe ø6x40mm cable length 1.5m 2-wire		



1 

Part No.	379142	Ref. No.	E25110070
description	temperature probe PTC 1kOhm cable PVC probe -50 up to +150°C cable -10 up to 100°C probe ø6x30mm cable length 1.5m without screw connection 2-wire		

1 

Part No.	379051	Ref. No.	8C0221
description	temperature probe thermocouple J (Fe-CuNi) cable Vetrotex probe -50 up to +750°C cable -50 up to +350°C probe ø6x100mm cable length 3m without screw connection cable colours red/blue 2-wire		
accessories for	379051		
	Part No.	379877	Ref. No. —
description	electronic controller HONEYWELL type DC10N-400 mounting measurements 92x92mm 24/230V voltage AC TC (J) relay outputs 1 CO-10A(6) TC (J) universal built-in depth 55mm protection IP54 accuracy 1% built-in version defr. funct. no 0 up to +400°C display 3 digits		

producer-specific probes

probes

1 

Part No.	381430	Ref. No.	809525
description	temperature probe thermocouple K (NiCr-Ni) cable silicone probe -50 up to 1150°C cable -50 up to +180°C connection 2-wire thread probe ø2x100mm cable length 0.25m		

1 

Part No.	379124	Ref. No.	809564
description	temperature probe thermocouple K (NiCr-Ni) cable silicone probe -50 up to 1150°C cable -50 up to +180°C connection 2-wire thread probe ø2x100mm cable length 2.2m		

core probes

1 

Part No.	379946	Ref. No.	8C1187
description	core temperature probe Pt100 cable PTFE probe -40 up to +250°C cable -40 up to +250°C connection plug probe ø3.5x100mm thread cable length 0.7m handle ø 10mm handle length 80mm		

1 

Part No.	381426	Ref. No.	809658
description	core temperature probe thermocouple K (NiCr-Ni) cable PTFE probe -40 up to +250°C cable -40 up to +250°C connection 2-wire probe ø3.2x100mm thread M12 cable length 1.9m handle ø 10mm handle length 100mm		

electronics

PCBs

1 

Part No.	400098	Ref. No.	809736
description	control PCB combi-steamer CD 101/CM 101 without EPROM		



solenoid valves

solenoid valves (water)

ELBI

straight



1 

Part No.	373021	Ref. No.	23120001 808922
description	solenoid valve double straight 230VAC inlet 3/4" outlet 11.5mm output 1x 4.7l/min DN10 ELBI		
spare parts for	373021		
	Part No.	370467	Ref. No. —
description	solenoid valve filter suitable for ELBI		
	Part No.	371263	Ref. No. —
description	reducer ELBI flow rate 4.7l/min pressure range 0 up to 10bar tolerance ±15/25% grey		



1 

Part No.	373017	Ref. No.	23120021 809335 902390
description	solenoid valve single straight 230VAC inlet 3/4" outlet 11.5mm DN10 ELBI		
spare parts for	373017		
	Part No.	370467	Ref. No. —
description	solenoid valve filter suitable for ELBI		



			
1			
Part No.	373018	Ref. No.	809566
description	solenoid valve single straight 230VAC inlet 3/4" outlet 14mm DN10 ELBI		
spare parts for	373018		
	Part No.	370467	Ref. No. —
solenoid valve filter suitable for ELBI			

## angled

			
1			
Part No.	373015	Ref. No.	8C0206
description	solenoid valve single angled 230VAC inlet 3/4" outlet 11.5mm DN10 ELBI		
spare parts for	373015		
	Part No.	370467	Ref. No. —
solenoid valve filter suitable for ELBI			

## ROBERTSHAW/INVENSYS

medium temperature: 90°C 90°C 60°C  
 ambient temperature: 60°C 25°C 60°C  
 duty cycle: 40% 100% 100%

## with coded terminal

			
1			
Part No.	370269	Ref. No.	809565
description	solenoid valve double straight 230VAC inlet 3/4" outlet 11.5mm DN10 EATON (INVENSYS)		

## RPE

## reducers

## outlet side

			
1			
Part No.	371269	Ref. No.	8C0117
description	reducer flow rate 0.07-0.14l/min brown		

## TP



















			
1			
Part No.	370017	Ref. No.	809327
description	solenoid valve single straight 230VAC inlet 3/4" outlet 11.5mm DN10 TP p max 10bar		
spare parts for	370017		
	Part No.	371013	Ref. No. —
solenoid coil TP 230VAC 50/60Hz			
accessories for	370017		
	Part No.	371220	Ref. No. —
reducer TP flow rate 3l/min red tolerance ±15%			
	Part No.	371221	Ref. No. —
reducer TP flow rate 5.5l/min yellow tolerance ±15%			
	Part No.	371222	Ref. No. —
reducer TP flow rate 6l/min grey tolerance ±15%			
	Part No.	371223	Ref. No. —
reducer TP flow rate 10l/min white tolerance ±15%			
	Part No.	371224	Ref. No. —
reducer TP flow rate 12l/min bronze tolerance ±15%			
	Part No.	371225	Ref. No. —
reducer TP flow rate 16l/min light brown tolerance ±15%			
	Part No.	371226	Ref. No. —
reducer TP flow rate 20l/min red tolerance ±15%			
	Part No.	371230	Ref. No. —
reducer TP flow rate 0.25l/min red tolerance ±25%			
	Part No.	371231	Ref. No. —
reducer TP flow rate 0.35l/min violet tolerance ±25%			
	Part No.	371232	Ref. No. —
reducer TP flow rate 0.5l/min orange tolerance ±25%			
	Part No.	371233	Ref. No. —
reducer TP flow rate 0.8l/min white tolerance ±25%			
	Part No.	371234	Ref. No. —
reducer TP flow rate 1l/min light blue tolerance ±25%			
	Part No.	371235	Ref. No. —
reducer TP flow rate 1.2l/min brown tolerance ±25%			
	Part No.	371236	Ref. No. —
reducer TP flow rate 1.5l/min light brown tolerance ±25%			







Table continues overleaf





accessories for		370017		
Part No.		371237	Ref. No.	—
	reducer	TP flow rate 2.5l/min yellow tolerance ±25%		
	reducer	TP flow rate 3.4l/min dark green tolerance ±25%		
	reducer	TP flow rate 5l/min black tolerance ±25%		
	reducer	TP flow rate 8l/min blue tolerance ±20%		

				
				
1				
Part No.	370025	Ref. No.	23120003	
description	solenoid valve triple straight 230VAC inlet 3/4" outlet 11.5mm DN10 TP			
spare parts for	370025			
	Part No.	371013	Ref. No.	—
	solenoid coil TP 230VAC 50/60Hz			
accessories for	370025			
	Part No.	371220	Ref. No.	—
	reducer TP flow rate 3l/min red tolerance ±15%			
	Part No.	371221	Ref. No.	—
	reducer TP flow rate 5.5l/min yellow tolerance ±15%			
	Part No.	371222	Ref. No.	—
	reducer TP flow rate 6l/min grey tolerance ±15%			
	Part No.	371223	Ref. No.	—
	reducer TP flow rate 10l/min white tolerance ±15%			
	Part No.	371224	Ref. No.	—
	reducer TP flow rate 12l/min bronze tolerance ±15%			
	Part No.	371225	Ref. No.	—
	reducer TP flow rate 16l/min light brown tolerance ±15%			
	Part No.	371226	Ref. No.	—
	reducer TP flow rate 20l/min red tolerance ±15%			
	Part No.	371230	Ref. No.	—
	reducer TP flow rate 0.25l/min red tolerance ±25%			
	Part No.	371231	Ref. No.	—
	reducer TP flow rate 0.35l/min violet tolerance ±25%			
	Part No.	371232	Ref. No.	—
	reducer TP flow rate 0.5l/min orange tolerance ±25%			
	Part No.	371233	Ref. No.	—
	reducer TP flow rate 0.8l/min white tolerance ±25%			

accessories for		370025		
Part No.		371234	Ref. No.	—
	reducer	TP flow rate 1l/min light blue tolerance ±25%		
	reducer	TP flow rate 1.2l/min brown tolerance ±25%		
	reducer	TP flow rate 1.5l/min light brown tolerance ±25%		
	reducer	TP flow rate 2.5l/min yellow tolerance ±25%		
	reducer	TP flow rate 3.4l/min dark green tolerance ±25%		
	reducer	TP flow rate 5l/min black tolerance ±25%		
	reducer	TP flow rate 8l/min blue tolerance ±20%		











				
1				
Part No.	370026	Ref. No.	E00010011	
description	solenoid valve triple straight 230VAC inlet 3/4" outlet 14mm DN10 TP			
spare parts for	370026			
	Part No.	371013	Ref. No.	—
	solenoid coil TP 230VAC 50/60Hz			
accessories for	370026			
	Part No.	371220	Ref. No.	—
	reducer TP flow rate 3l/min red tolerance ±15%			
	Part No.	371221	Ref. No.	—
	reducer TP flow rate 5.5l/min yellow tolerance ±15%			
	Part No.	371222	Ref. No.	—
	reducer TP flow rate 6l/min grey tolerance ±15%			
	Part No.	371223	Ref. No.	—
	reducer TP flow rate 10l/min white tolerance ±15%			
	Part No.	371224	Ref. No.	—
	reducer TP flow rate 12l/min bronze tolerance ±15%			
	Part No.	371225	Ref. No.	—
	reducer TP flow rate 16l/min light brown tolerance ±15%			
	Part No.	371226	Ref. No.	—
	reducer TP flow rate 20l/min red tolerance ±15%			
	Part No.	371230	Ref. No.	—
	reducer TP flow rate 0.25l/min red tolerance ±25%			

Table continues overleaf



accessories for		370026		
Part No.		371231	Ref. No.	—
	reducer	TP flow rate 0.35l/min	violet tolerance ±25%	
Part No.		371232	Ref. No.	—
	reducer	TP flow rate 0.5l/min	orange tolerance ±25%	
Part No.		371233	Ref. No.	—
	reducer	TP flow rate 0.8l/min	white tolerance ±25%	
Part No.		371234	Ref. No.	—
	reducer	TP flow rate 1l/min	light blue tolerance ±25%	
Part No.		371235	Ref. No.	—
	reducer	TP flow rate 1.2l/min	brown tolerance ±25%	
Part No.		371236	Ref. No.	—
	reducer	TP flow rate 1.5l/min	light brown tolerance ±25%	
Part No.		371237	Ref. No.	—
	reducer	TP flow rate 2.5l/min	yellow tolerance ±25%	
Part No.		371238	Ref. No.	—
	reducer	TP flow rate 3.4l/min	dark green tolerance ±25%	
Part No.		371239	Ref. No.	—
	reducer	TP flow rate 5l/min	black tolerance ±25%	
Part No.		371240	Ref. No.	—
	reducer	TP flow rate 8l/min	blue tolerance ±20%	

1				
Part No.	370015	Ref. No.	051J00002	
description	solenoid valve single angled 230VAC inlet 3/4" outlet 11.5mm DN10 TP			
accessories for		370015		
Part No.		371220	Ref. No.	—
	reducer	TP flow rate 3l/min	red tolerance ±15%	
Part No.		371221	Ref. No.	—
	reducer	TP flow rate 5.5l/min	yellow tolerance ±15%	
Part No.		371222	Ref. No.	—
	reducer	TP flow rate 6l/min	grey tolerance ±15%	
Part No.		371223	Ref. No.	—
	reducer	TP flow rate 10l/min	white tolerance ±15%	
Part No.		371224	Ref. No.	—
	reducer	TP flow rate 12l/min	bronze tolerance ±15%	
Part No.		371225	Ref. No.	—
	reducer	TP flow rate 16l/min	light brown tolerance ±15%	

accessories for		370015		
Part No.		371226	Ref. No.	—
	reducer	TP flow rate 20l/min	red tolerance ±15%	
Part No.		371230	Ref. No.	—
	reducer	TP flow rate 0.25l/min	red tolerance ±25%	
Part No.		371231	Ref. No.	—
	reducer	TP flow rate 0.35l/min	violet tolerance ±25%	
Part No.		371232	Ref. No.	—
	reducer	TP flow rate 0.5l/min	orange tolerance ±25%	
Part No.		371233	Ref. No.	—
	reducer	TP flow rate 0.8l/min	white tolerance ±25%	
Part No.		371234	Ref. No.	—
	reducer	TP flow rate 1l/min	light blue tolerance ±25%	
Part No.		371235	Ref. No.	—
	reducer	TP flow rate 1.2l/min	brown tolerance ±25%	
Part No.		371236	Ref. No.	—
	reducer	TP flow rate 1.5l/min	light brown tolerance ±25%	
Part No.		371237	Ref. No.	—
	reducer	TP flow rate 2.5l/min	yellow tolerance ±25%	
Part No.		371238	Ref. No.	—
	reducer	TP flow rate 3.4l/min	dark green tolerance ±25%	
Part No.		371239	Ref. No.	—
	reducer	TP flow rate 5l/min	black tolerance ±25%	
Part No.		371240	Ref. No.	—
	reducer	TP flow rate 8l/min	blue tolerance ±20%	

## solenoid valves with reducers

1			
Part No.	370628	Ref. No.	8C0145
description	solenoid valve double straight 230VAC inlet 3/4" input 16l/min DN10 TP plastic outlet 11.5mm		







 <p>1</p>			
Part No.	370250	Ref. No.	902410
description	solenoid valve triple straight 230VAC inlet 3/4" outlet 11.5mm t.max. 90°C TP 22507P plastic output B 0.25l/min flow regulating valve outlet B red		

## pressure switches

### for steam control

 <p>1</p>			
Part No.	541074	Ref. No.	03-PRS-001 8C0444
description	pressure control ø 45mm triggering pressure 0.5bar reset pressure 0.35bar pressure connection vertical steam control pressure range 0.35/0.51bar connection 1/8" pressure connection 1/8"		



### for combi-steamers

 <p>1</p>			
Part No.	345218	Ref. No.	809509
description	pressure control pressure range 0-3mbar connection 6mm pressure connection 6mm		

 <p>1</p>			
Part No.	541329	Ref. No.	809754
description	pressure control pressure range 350/150mbar connection 8mm pressure connection 8mm		

## electrodes

 <p>1</p>			
Part No.	400021	Ref. No.	809561
description	level electrode PG9 total length 110mm probe L 70/47/24mm insulated probe length 62/38/16mm with 3 probes connection grip connection		

 <p>1</p>			
Part No.	400022	Ref. No.	809569
description	level electrode PG9 total length 135mm probe L 89/59/28mm insulated probe length 80mm with 3 probes connection grip connection		
accessories for	400022		
			
Part No.	379729	Ref. No.	—
description	connection cable L 1230mm 4-pole for level electrode plug type coded		
			
Part No.	550574	Ref. No.	—
description	nut thread PG9 H 3mm WS 28 nickel-plated brass Qty 1 pcs mounting ømm cable ømm		

## fans

### axial fans

#### ebm-papst

 <p>1</p>			
Part No.	601030	Ref. No.	809503 831100001
description	axial fan L 119mm W 119mm H 38mm 230VAC 50Hz 18W bearing ball bearing manuf. no. 4656Z metal connection male faston 2.8mm ebm-papst fan wheel ø 110mm temp.-resist. 75°C		
accessories for	601030		
			
Part No.	550898	Ref. No.	—
description	connecting cable cable length 2000mm connection F 2.8 connection distance 7.9mm for axial flow fan		
			
Part No.	692497	Ref. No.	—
description	guard ø 105mm mounting distance 150mm for axial fan ebm-papstmm		

with ball bearings



## import



1

Part No.	601080	Ref. No.	827851	
description	axial fan L 119mm W 119mm H 38mm 230VAC 50/60Hz 23/20W bearing ball bearing connection male faston 2.8mm metal ADDA fan wheel ø 110mm temp.-resist. 70°C			
accessories for	601080			
	Part No.	550898	Ref. No.	—
	connecting cable cable length 2000mm connection F 2.8 connection distance 7.9mm for axial flow fan			
	Part No.	692519	Ref. No.	—
	guard L 120mm W 120mm plastic			

with ball bearings



1

Part No.	601081 <sub>1</sub>	Ref. No.	827852	
description	axial fan L 80mm W 80mm H 38mm 230VAC 50/60Hz 14/13.5W bearing ball bearing connection male faston 2.8mm metal ADDA fan wheel ø 75mm temp.-resist. 70°C			
accessories for	601081			
	Part No.	691102	Ref. No.	—
	guard ø 75mm mounting distance 71mm for axial fan 80mm			

with ball bearings

## hot air motors



1

Part No.	550859	Ref. No.	809828
description	counterflange for fan motor ED ø 60mm int. ø 1 34mm int. ø 2 25mm thickness 6mm brass		



1

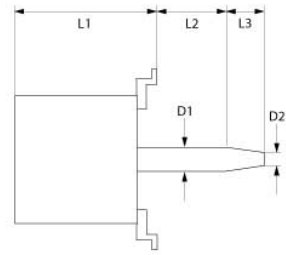

Part No.	601046	Ref. No.	807314 809406
description	fan motor 220/380V 3 phase 50/60Hz 0.75kW 1350/1650rpm speeds 1 L1 185mm L2 42mm L3 47mm D1 ø 24mm D2 ø 20mm M12L IT 1.9/3.3A Cos(φ) 0.83 at 50Hz 200-240/346-415V at 60Hz 200-277/346-480V at 50Hz 1350rpm at 60Hz 1650rpm type ST80/4 no. 661512		



1

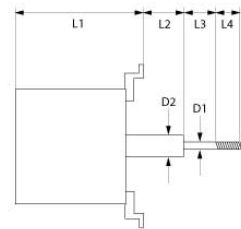

Part No.	601354	Ref. No.	131110021	
description	fan motor 220-240V 1 phase 50Hz 0.11kW 2760rpm speeds 1 L1 130mm L2 32mm L3 30mm L4 18mm D1 ø 7/8mm D2 ø 9mm M4R IT 0.9A at 50Hz 230V at 50Hz 2760rpm suitable capacitor 4µF type LM63 shaft flat length 17mm			
accessories for	601354			
	Part No.	365031	Ref. No.	—
	operating capacitor capacity 4µF 450V tolerance 5% 50/60Hz ambient temperature max. -25 to +85°C ø 31mm L 58mm M8 plastic connection male faston 6.3mm protection			
	Part No.	601061	Ref. No.	—
	fan wheel D1 ø 160mm H1 60mm blades 15 D2 ø 18mm D3 ø 18mm H2 35mm			



1

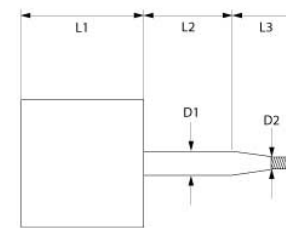

Part No.	601043	Ref. No.	808973	
description	fan motor 220-240V 1 phase 50Hz 0.37/0.07kW 0.1/0.5HP 1400/2700rpm speeds 2 L1 123mm L2 107mm L3 15mm D1 ø 15mm D2 ø 12mm M10L ET 2/0.7A suitable capacitor 20µF/250V at 50Hz 1400/2700rpm type 1057			
accessories for	601043			
	Part No.	365019	Ref. No.	—
	operating capacitor capacity 20µF 400V tolerance 5% 50/60Hz ambient temperature max. -25 to +85°C ø 39.5mm L 70mm M8 plastic connection male faston 6.3mm 16.10.25. protection			

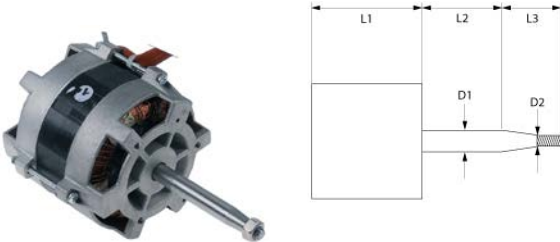
1

Part No.	601166	Ref. No.	131110010	
description	fan motor 220-240V 1 phase 50Hz 0.37kW 2700rpm speeds 1 L1 123mm L2 77mm L3 30mm D1 ø 15mm D2 ø 12mm M10L ET 2A suitable capacitor 12.5µF/450V at 50Hz 2700rpm type 1057.2157			
spare parts for	601166			
	Part No.	365014	Ref. No.	901740
	operating capacitor capacity 12.5µF 450V tolerance 5%Hz ambient temperature max. -25 to +85°C ø 35mm L 70mm M8 plastic connection male faston 6.3mm 45S.C3DS.12.5 protection			
accessories for	601166			
	Part No.	601165	Ref. No.	—
	fan wheel D1 ø 160mm H1 60mm blades 15 D2 ø 16mm D3 ø 16mm H2 29mm			

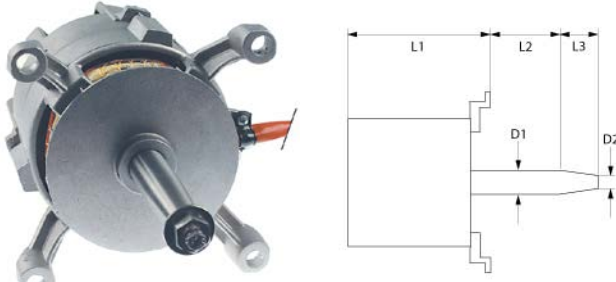

1

Part No.	500642	Ref. No.	813154
description	fan motor 380-415V 3 phase 50Hz 0.22/0.75kW 700/1400rpm speeds 2 L1 166mm L2 45mm L3 67mm D1 ø 24mm D2 ø 20mm M6R ITA at 50Hz 380-415V at 50Hz 700/1400rpm type FB80 4/8 no. 629764		

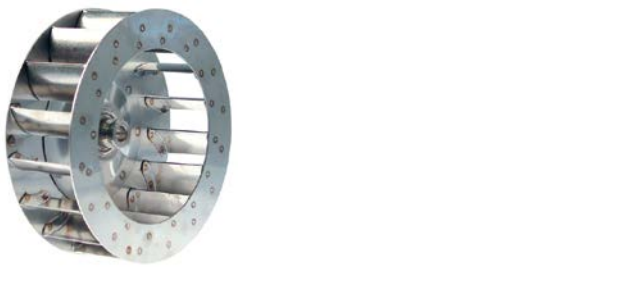

1

Part No.	601060	Ref. No.	807604 808961
description	fan wheel D1 ø 180mm H1 60mm blades 16 D2 ø 11mm D3 ø 16mm H2 30mm		



1

Part No.	601224	Ref. No.	809407
description	fan wheel D1 ø 300mm H1 100mm blades 24 D2 ø 19.5mm D3 ø 23mm H2 46mm		



1

Part No.	601063	Ref. No.	8C0003
description	fan wheel D1 ø 350mm H1 100mm blades 24 D2 ø 19.5mm D3 ø 23mm H2 46mm		



1

Part No.	511171	Ref. No.	809829
description	shaft seal ID ø 14.5mm ED ø 20mm thickness 3mm		

hot air fans

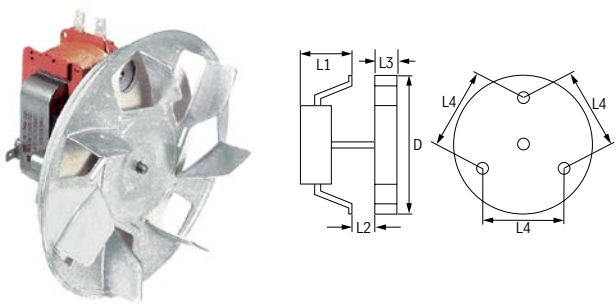

miscellaneous

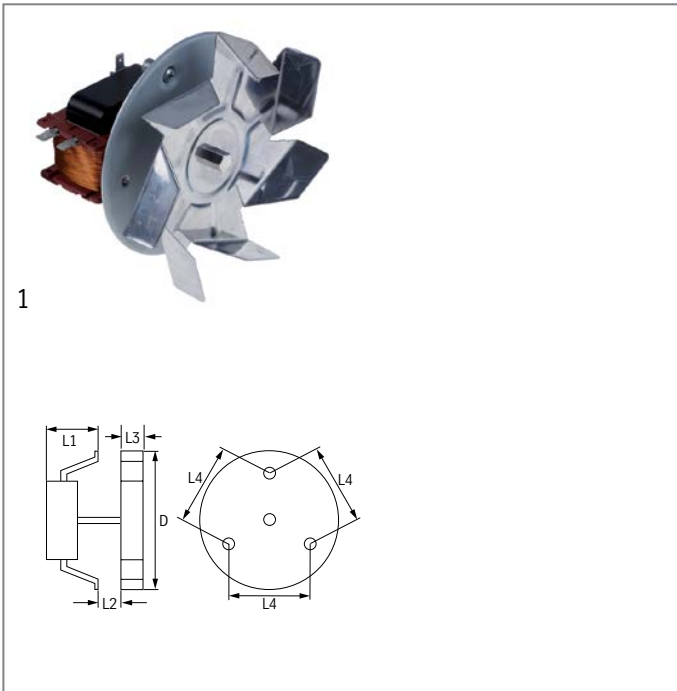

1

Part No.	601273	Ref. No.	8C0432
description	hot air fan 220-240V 32W 50/60Hz L1 60mm L2 10mm L3 25mm L4 87mm fan wheel ø 155mm FIME type C20X0E01/15CLH		



Part No.	601011	Ref. No.	8C0758
description	hot air fan 220-240V 40W 50/60Hz L1 65mm L2 15mm L3 25mm L4 87mm fan wheel ø 150mm FIME type C25R8023CLH		
accessories for	601011		
	Part No.	550879	Ref. No. —
	insulation ø 130mm thickness 3mm hole ø 18mm for hot air fan		
	Part No.	601260	Ref. No. —
	nut thread M6L IT for hot air fan		

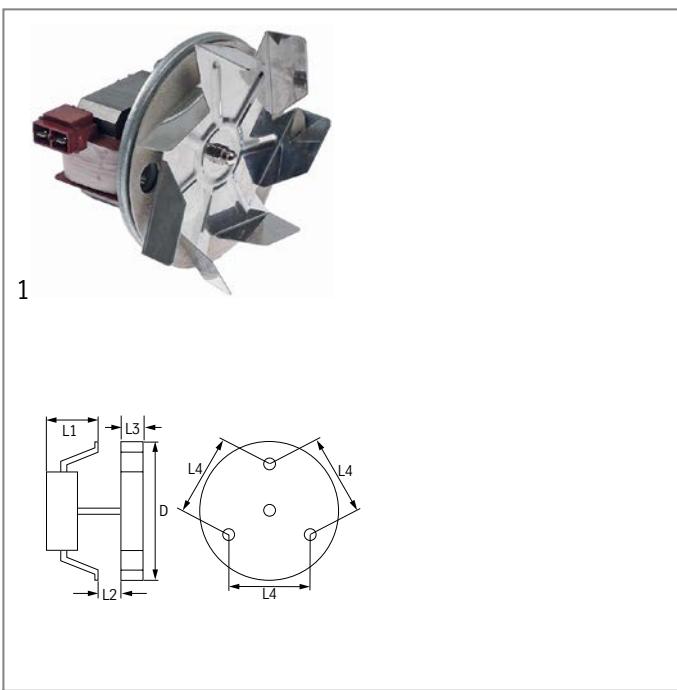

Part No.	601339	Ref. No.	807206 8C2135
description	hot air fan 230V 45W L1 78mm L2 13mm L3 25mm L4 87mm fan wheel ø 150mm Medys type 30.200.CLH		

motors

gear motors

for ovens

for flues



1			
Part No.	601138	Ref. No.	809507
description	gear motor CROUZET type G70C10AFTEG 12V voltage DCHz shaft ø 4mm L 66mm W 50mm H 61mm		

pumps

drain pumps

ASKOLL



1			
Part No.	500565	Ref. No.	808670
description	drain pump 30W		

HANNING



1			
Part No.	500042	Ref. No.	809563 809735
description	drain pump 80W 230V inlet ø 24mm outlet ø 24mm 50Hz type KD22B3-679 HANNING		
spare parts for	500042		
	Part No.	510168	Ref. No. —
	fan wheel shaft intake ø 5mm ø 62mm H 14mm		

condensators & interference  
suppression filters

## operating capacitors

## plastic



1

Part No.	365014	Ref. No.	901740
description	operating capacitor capacity 12.5 $\mu$ F 450V tolerance 5%Hz ambient temperature max. -25 to +85°C $\varnothing$ 35mm L 70mm M8 plastic connection male faston 6.3mm 45S.C3DS.12.5 protection		



1

Part No.	365021	Ref. No.	24100004
description	operating capacitor capacity 16 $\mu$ F 425V tolerance 5% 50/60Hz ambient temperature max. -25 to +85°C $\varnothing$ 35mm L 73mm single M8 plastic connection male faston 6.3mm 416.10.99 protection		



1

Part No.	365224	Ref. No.	24100003
description	operating capacitor capacity 25 $\mu$ F 420V tolerance 5% 50/60Hz $\varnothing$ 45mm L 75mm M8 plastic connection male faston 6.3mm		



1

Part No.	365012	Ref. No.	24100001 8C1588
description	operating capacitor capacity 6.3 $\mu$ F 450V tolerance 5% 50Hz ambient temperature max. -25 to +85°C $\varnothing$ 30mm L 61mm M8 plastic connection male faston 6.3mm protection		



1

Part No.	365013	Ref. No.	132110008
description	operating capacitor capacity 8 $\mu$ F 400V tolerance 5%Hz ambient temperature max. -25 to +85°C $\varnothing$ 31.5mm L 55mm M8 plastic connection male faston 6.3mm protection		

## filters

## interference suppression filters



1

Part No.	365044	Ref. No.	24100100
description	interference suppression filter type FC701Y2F 250V 50-60Hz conductor 2 with E connection cable 200mm L 42mm $\varnothing$ 23mm Hmm Wmm plastic Qty 1 pcs		

## electric accessories

## cables

## accessories

## cable glands

## threaded cable glands

## screw connections



1

Part No.	550971	Ref. No.	809010
description	cable gland thread PG16 cable $\varnothing$ 14mm mounting $\varnothing$ 22.5mm Qty 1 pcs plastic WS 27		

## terminals

connection terminals with screw/faston  
connections

1

Part No.	550411	Ref. No.	C00395
description	power terminal block 6-pole max. 40A max 450V connection $\varnothing$ 6mm <sup>2</sup> / F6.3 temp.-resist. 150°C cross section 6mm <sup>2</sup>		







			
1			
Part No.	550977	Ref. No.	904150
description	power terminal block 6-pole max. 40A max 450V connection $\phi 6\text{mm}^2$ / F6.3 temp.-resist. 150°C cross section 6mm <sup>2</sup> with ground lug		
with ground lug			

## gas valves and ignition boxes



## gas control valves

## HONEYWELL

			
1			
Part No.	101186	Ref. No.	809510
description	gas valve type VK4105C 220-240V 50/60Hz gas inlet flange 32x32mm gas outlet flange 32x32mm thermocouple connection pilot connection pressure range 15-60mbar max 60mbar operator type pressure controller type V5360E 1226 1 HONEYWELL hole distance 24mm flange 32x32mm		
accessories for	101186		
	Part No.	102845	Ref. No.
			—
	gas connection angled 1/2" flange 32x32mm hole distance 24x24mm Tandem		
	Part No.	102846	Ref. No.
			—
	gas connection straight 1/2" flange 32x32mm hole distance 24x24mm suitable for Tandem		

## SIT

## ELETTROSIT

			
1			
Part No.	101126	Ref. No.	C00302
description	gas valve SIT type ELETTROSIT 230V gas inlet 1/2" gas outlet 1/2" thermocouple connection M9x1 pilot connection M10x1 bottom equiv. no. 0.810.136		
accessories for	101126		
	Part No.	101312	Ref. No.
			C00309
	microswitch		

spare parts for 101126			
	Part No.	101352	Ref. No.
			—
	solenoid coil 230V 50Hz suitable for ELETTROSIT		
accessories for 101126			
	Part No.	100006	Ref. No.
			—
	piezoelectric igniter suitable for ELETTROSIT body plastic blowing connection $\phi 2.4\text{mm}$ $\phi 14\text{mm}$		
	Part No.	100904	Ref. No.
			—
	locking screw M10x1 for pipe $\phi 4\text{mm}$ Qty 1 pcs		
	Part No.	100905	Ref. No.
			8C0070
	locking screw M10x1 for pipe $\phi 6\text{mm}$ Qty 1 pcs		
	Part No.	101301	Ref. No.
			—
	gas connection thread 1/2" straight ELETTROSIT screw with O-ring		
	Part No.	101303	Ref. No.
			—
	gas connection straight thread 3/4" ELETTROSIT		
	Part No.	101309	Ref. No.
			—
	extension		



















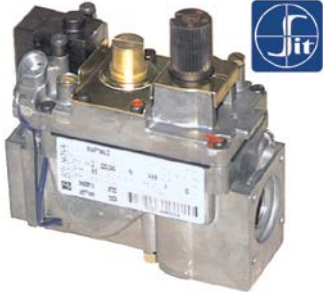

			
1			
Part No.	101127	Ref. No.	813416
description	gas valve SIT type ELETTROSIT 230V gas inlet 3/4" gas outlet 3/4" thermocouple connection M9x1 pilot connection M10x1 lateral equiv. no. 0.810.175		
spare parts for 101127			
	Part No.	101312	Ref. No.
			C00309
	microswitch		
	Part No.	101352	Ref. No.
			—
	solenoid coil 230V 50Hz suitable for ELETTROSIT		
accessories for 101127			
	Part No.	100006	Ref. No.
			—
	piezoelectric igniter suitable for ELETTROSIT body plastic blowing connection $\phi 2.4\text{mm}$ $\phi 14\text{mm}$		
	Part No.	100904	Ref. No.
			—
	locking screw M10x1 for pipe $\phi 4\text{mm}$ Qty 1 pcs		
	Part No.	100905	Ref. No.
			8C0070
	locking screw M10x1 for pipe $\phi 6\text{mm}$ Qty 1 pcs		
	Part No.	101301	Ref. No.
			—
	gas connection thread 1/2" straight ELETTROSIT screw with O-ring		

Table continues overleaf











accessories for	101127		
	Part No.	101303	Ref. No. —
gas connection straight thread 3/4" ELETTROSIT			
	Part No.	101309	Ref. No. —
extension			

NOVASIT

			
1			
Part No.	101162	Ref. No.	813436
description	gas valve SIT series Novasit 820 230V 50Hz gas inlet 1/2" gas outlet 1/2" thermocouple connection M9x1 pilot connection M10x1 ignition pressure 3-5mbar pressure range 3-30mbar pressure regulator connection blind equiv. no. 0.820.010		
spare parts for	101162		
	Part No.	101065	Ref. No. —
magnet unit with cable L 44mm D1 ø 30mm D2 ø 20mm suitable for NOVASIT			
	Part No.	101313	Ref. No. —
solenoid coil 230V 50Hz			
accessories for	101162		
	Part No.	100006	Ref. No. —
piezoelectric igniter suitable for ELETTROSIT body plastic blowing connection ø2.4mm ø 14mm			
	Part No.	101305	Ref. No. —
gas connection straight 1/2" flange 45x45mm ELETTROSIT/V4400/4600/4605 suitable for SIT/HONEYWELL hole distance 36x36mm			
	Part No.	101306	Ref. No. —
gas connection angled flange 45x45mm hole distance 36x36mm 1/2" ELETTROSIT/V4400/4600/4605 screw with O-ring suitable for SIT/HONEYWELL			
	Part No.	101307	Ref. No. —
gas connection straight flange 45x45mm hole distance 36x36mm 3/4" ELETTROSIT/V4400/4600/4605 screw with O-ring suitable for SIT/HONEYWELL			
	Part No.	101308	Ref. No. —
gas connection angled flange 45x45mm hole distance 36x36mm 3/4" ELETTROSIT/V4400/4600/4605 screw with O-ring suitable for SIT/HONEYWELL			
	Part No.	101312	Ref. No. C00309
microswitch			
	Part No.	101314	Ref. No. —
solenoid coil 24V 50Hz			
	Part No.	101317	Ref. No. 245120705 C00974
plug with cable L 1000mm suitable for NOVASIT			
	Part No.	101318	Ref. No. —
cover cap for solenoid coil suitable for NOVASIT			

			
1			
Part No.	101956	Ref. No.	C00946
description	gas valve SIT series Novasit 820 230V 50Hz gas inlet 1/2" gas outlet 1/2" thermocouple connection M9x1 pilot connection M10x1 ignition pressure 3-5mbar pressure range 3-30mbar pressure regulator connection blind equiv. no. 0.820.031		
spare parts for	101956		
	Part No.	101065	Ref. No. —
magnet unit with cable L 44mm D1 ø 30mm D2 ø 20mm suitable for NOVASIT			
	Part No.	101313	Ref. No. —
solenoid coil 230V 50Hz			
accessories for	101956		
	Part No.	100006	Ref. No. —
piezoelectric igniter suitable for ELETTROSIT body plastic blowing connection ø2.4mm ø 14mm			
	Part No.	101305	Ref. No. —
gas connection straight 1/2" flange 45x45mm ELETTROSIT/V4400/4600/4605 suitable for SIT/HONEYWELL hole distance 36x36mm			
	Part No.	101306	Ref. No. —
gas connection angled flange 45x45mm hole distance 36x36mm 1/2" ELETTROSIT/V4400/4600/4605 screw with O-ring suitable for SIT/HONEYWELL			
	Part No.	101307	Ref. No. —
gas connection straight flange 45x45mm hole distance 36x36mm 3/4" ELETTROSIT/V4400/4600/4605 screw with O-ring suitable for SIT/HONEYWELL			
	Part No.	101308	Ref. No. —
gas connection angled flange 45x45mm hole distance 36x36mm 3/4" ELETTROSIT/V4400/4600/4605 screw with O-ring suitable for SIT/HONEYWELL			
	Part No.	101312	Ref. No. C00309
microswitch			
	Part No.	101314	Ref. No. —
solenoid coil 24V 50Hz			
	Part No.	101317	Ref. No. 245120705 C00974
plug with cable L 1000mm suitable for NOVASIT			
	Part No.	101318	Ref. No. —
cover cap for solenoid coil suitable for NOVASIT			



1			
Part No.	101914	Ref. No.	808578
description	gas valve SIT series Novasit 822 230V 50Hz gas inlet 1/2" gas outlet 1/2" thermocouple connection pilot connection closed ignition pressure range 3-30mbar pressure regulator connection blind equiv. no. 0.822.144		
spare parts for	101914		
	Part No.	101313	Ref. No. —
	solenoid coil 230V 50Hz		
	Part No.	101542	Ref. No. —
	solenoid coil 50Hz NOVA 822/826/827 suitable for NOVASIT 230V		
accessories for	101914		
	Part No.	101305	Ref. No. —
	gas connection straight 1/2" flange 45x45mm ELETTROSIT/V4400/4600/4605 suitable for SIT/HONEYWELL hole distance 36x36mm		
	Part No.	101306	Ref. No. —
	gas connection angled flange 45x45mm hole distance 36x36mm 1/2" ELETTROSIT/V4400/4600/4605 screw with O-ring suitable for SIT/HONEYWELL		
	Part No.	101307	Ref. No. —
	gas connection straight flange 45x45mm hole distance 36x36mm 3/4" ELETTROSIT/V4400/4600/4605 screw with O-ring suitable for SIT/HONEYWELL		
	Part No.	101308	Ref. No. —
	gas connection angled flange 45x45mm hole distance 36x36mm 3/4" ELETTROSIT/V4400/4600/4605 screw with O-ring suitable for SIT/HONEYWELL		
	Part No.	101503	Ref. No. —
	O-ring EPDM thickness 2mm ID ø 32mm Qty 1 pcs		
	Part No.	101924	Ref. No. —
	plug with cable L 1090mm suitable for NOVA 822/826/827		

accessories

1			
			
Part No.	100905	Ref. No.	8C0070
description	locking screw M10x1 for pipe ø 6mm Qty 1 pcs		

1			
			
Part No.	101312	Ref. No.	C00309
description	microswitch		

1			
			
Part No.	101317	Ref. No.	245120705 C00974
description	plug with cable L 1000mm suitable for NOVASIT		

TANDEM



1			
Part No.	101984	Ref. No.	809326
description	gas valve 230V 50Hz gas inlet 1/2" gas outlet 1/2" pilot connection level slow ignition ignition times pressure range 2-50mbar power supply for modulator 230VAC rectified Tandem equiv. no. 0.836.010		
spare parts for	101984		
	Part No.	101379	Ref. No. —
	solenoid coil 230V 50Hz suitable for Tandem		
accessories for	101984		
	Part No.	101274	Ref. No. —
	olive for pipe ø 16mm Qty 1 pcs		
	Part No.	101275	Ref. No. —
	union screw thread 1/2" for pipe ø 16mm Qty 1 pcs		
	Part No.	101925	Ref. No. —
	plug with O-ring thread M10x1 for pilot burner suitable for NOVASIT		
	Part No.	102845	Ref. No. —
	gas connection angled 1/2" flange 32x32mm hole distance 24x24mm Tandem		
	Part No.	102846	Ref. No. —
	gas connection straight 1/2" flange 32x32mm hole distance 24x24mm suitable for Tandem		
	Part No.	102847	Ref. No. —
	O-ring		



1			
Part No.	101684	Ref. No.	809595 8C0068
description	gas valve 230V 50Hz gas inlet 1/2" gas outlet 1/2" pilot connection level slow ignition standard ignition time 3-7s pressure range 3-50mbar power supply for modulator type SIT equiv. no. 0.830.034		
spare parts for	101684		
	Part No.	101379	Ref. No. —
	solenoid coil 230V 50Hz suitable for Tandem		
accessories for	101684		
	Part No.	101274	Ref. No. —
	olive for pipe ø 16mm Qty 1 pcs		
	Part No.	101275	Ref. No. —
	union screw thread 1/2" for pipe ø 16mm Qty 1 pcs		
	Part No.	102845	Ref. No. —
	gas connection angled 1/2" flange 32x32mm hole distance 24x24mm Tandem		
	Part No.	102846	Ref. No. —
	gas connection straight 1/2" flange 32x32mm hole distance 24x24mm suitable for Tandem		
	Part No.	102847	Ref. No. —
	O-ring		

ignition boxes

BRAHMA

1			
Part No.	107471	Ref. No.	02-CNT-001 809878
description	ignition box BRAHMA type CM11 electrodes 2 waiting time 1.5s safety time 10s 230V 7VA 50-60Hz		

HONEYWELL

1			
Part No.	101165	Ref. No.	809751
description	ignition box HONEYWELL type S4560A 1008 equiv. no. S4560A 1008 electrodes 1 waiting time 0s safety time 10s 220-240V 10VA 50Hz		
spare parts for	101165		
	Part No.	358696	Ref. No. —
	fine fuse size ø5x20mm 4A medium lag rated 250V Qty 10 pcs		

1			
Part No.	101166	Ref. No.	808611
description	ignition box HONEYWELL type S4560B 1006 electrodes 1 waiting time 0s safety time 10s 220-240V 10VA 50Hz		

SIT

1			
Part No.	101685	Ref. No.	809602 8C0069
description	ignition box SIT type 503EFD electrodes 2 waiting time 1.5s safety time 10s 220/240V 7VA 50-60Hz protection IP40		

1			
Part No.	102309	Ref. No.	809752
description	ignition box SIT type 537ABC electrodes 3 waiting time 1.5s safety time 10s 230V 10VA 50-60Hz protection IP44		





miscellaneous



1			
Part No.	401171	Ref. No.	809099
description	ignition box		

ignition parts

pilot burners

SIT

100 series



1			
Part No.	107139	Ref. No.	C00391
description	pilot burner SIT type 100 series 1 flame nozzle ø 0.24mm gas connectionmm		
spare parts for	107139		
	Part No.	100854	Ref. No. —
	pilot burner bracket double		
	Part No.	100885	Ref. No. —
	air mixing sleeve for pilot burner Qty 1 pcs		
	Part No.	107160	Ref. No. —
	pilot burner cap SIT 1 flame Hmm Lmm Qty 1 pcs		
accessories for	107139		
	Part No.	100904	Ref. No. —
	locking screw M10x1 for pipe ø 4mm Qty 1 pcs		
	Part No.	100905	Ref. No. 8C0070
	locking screw M10x1 for pipe ø 6mm Qty 1 pcs		
	Part No.	100998	Ref. No. —
	pilot burner bottom part nozzle ø 0.21mm suitable for 100 series		
	Part No.	102110	Ref. No. —
	pilot tube copper pipe ø 4mm thickness 1mm L 3000mm		
	Part No.	102111	Ref. No. —
	pilot tube copper pipe ø 6mm thickness 1mm L 3000mm		





1			
Part No.	106906	Ref. No.	051E10007 808180 C00070 C00711
description	pilot burner SIT type 100 series 3 flames nozzle ø 0.2mm gas connection 6mm		
spare parts for	106906		
	Part No.	100245	Ref. No. 8C0030
	pilot burner nozzle LPG code 20 bore ø 0.2mm Qty 1 pcs thread M8x0.75		
	Part No.	100855	Ref. No. —
	pilot burner bracket triple		
	Part No.	100885	Ref. No. —
	air mixing sleeve for pilot burner Qty 1 pcs		
	Part No.	100916	Ref. No. —
	compression spring for pilot burner Qty 1 pcs		
	Part No.	100917	Ref. No. —
	gasket for pilot burner Qty 1 pcs aluminium ID ø 8.5mm ED ø 11mm thickness 1.2mm		
	Part No.	100918	Ref. No. —
	screw for pilot burner		
	Part No.	107162	Ref. No. —
	pilot burner cap SIT 3 flames Hmm Lmm Qty 1 pcs		
	Part No.	107701	Ref. No. —
	pilot burner bottom part SIT 100 series nozzle ø 0.2mm		
accessories for	106906		
	Part No.	100245	Ref. No. 8C0030
	pilot burner nozzle LPG code 20 bore ø 0.2mm Qty 1 pcs thread M8x0.75		
	Part No.	100246	Ref. No. 8C0031
	pilot burner nozzle natural gas bore ø 0.35mm Qty 1 pcs thread M8x0.75		
	Part No.	100904	Ref. No. —
	locking screw M10x1 for pipe ø 4mm Qty 1 pcs		
	Part No.	100905	Ref. No. 8C0070
	locking screw M10x1 for pipe ø 6mm Qty 1 pcs		
	Part No.	102110	Ref. No. —
	pilot tube copper pipe ø 4mm thickness 1mm L 3000mm		
	Part No.	102111	Ref. No. —
	pilot tube copper pipe ø 6mm thickness 1mm L 3000mm		
	Part No.	107171	Ref. No. —
	pilot burner nozzle SIT natural/liquid gas bore ø 0.25mm Qty 1 pcs		







Table continues overleaf





2 gas components



















accessories for	106906		
	Part No.	107700	Ref. No. —
	pilot burner bottom part SIT 100 series nozzle ø 0.25mm		
	Part No.	107702	Ref. No. —
	pilot burner bottom part SIT 100 series nozzle ø 0.35mm		

 <p>1</p>			
Part No.	107140	Ref. No.	C00392
description	pilot burner SIT type 100 series 3 flames nozzle ø 0.2mm gas connectionmm		
spare parts for	107140		
	Part No.	100855	Ref. No. —
	pilot burner bracket triple		
	Part No.	100885	Ref. No. —
	air mixing sleeve for pilot burner Qty 1 pcs		
	Part No.	100916	Ref. No. —
	compression spring for pilot burner Qty 1 pcs		
	Part No.	107162	Ref. No. —
	pilot burner cap SIT 3 flames Hmm Lmm Qty 1 pcs		
accessories for	107140		
	Part No.	100904	Ref. No. —
	locking screw M10x1 for pipe ø 4mm Qty 1 pcs		
	Part No.	100905	Ref. No. 8C0070
	locking screw M10x1 for pipe ø 6mm Qty 1 pcs		

 <p>1</p>			
Part No.	106907	Ref. No.	8C0638 C00166
description	pilot burner SIT type 100 series 3 flames nozzle ø 0.35mm gas connection 6mm		
spare parts for	106907		
	Part No.	100246	Ref. No. 8C0031
	pilot burner nozzle natural gas bore ø 0.35mm Qty 1 pcs thread M8x0.75		
	Part No.	100855	Ref. No. —
	pilot burner bracket triple		
	Part No.	100885	Ref. No. —
	air mixing sleeve for pilot burner Qty 1 pcs		
	Part No.	100916	Ref. No. —
	compression spring for pilot burner Qty 1 pcs		

spare parts for	106907		
	Part No.	100917	Ref. No. —
	gasket for pilot burner Qty 1 pcs aluminium ID ø 8.5mm ED ø 11mm thickness 1.2mm		
	Part No.	100918	Ref. No. —
	screw for pilot burner		
	Part No.	107162	Ref. No. —
	pilot burner cap SIT 3 flames Hmm Lmm Qty 1 pcs		
	Part No.	107702	Ref. No. —
	pilot burner bottom part SIT 100 series nozzle ø 0.35mm		
accessories for	106907		
	Part No.	100245	Ref. No. 8C0030
	pilot burner nozzle LPG code 20 bore ø 0.2mm Qty 1 pcs thread M8x0.75		
	Part No.	100904	Ref. No. —
	locking screw M10x1 for pipe ø 4mm Qty 1 pcs		
	Part No.	100905	Ref. No. 8C0070
	locking screw M10x1 for pipe ø 6mm Qty 1 pcs		
	Part No.	102110	Ref. No. —
	pilot tube copper pipe ø 4mm thickness 1mm L 3000mm		
	Part No.	102111	Ref. No. —
	pilot tube copper pipe ø 6mm thickness 1mm L 3000mm		
	Part No.	107171	Ref. No. —
	pilot burner nozzle SIT natural/liquid gas bore ø 0.25mm Qty 1 pcs		
	Part No.	107700	Ref. No. —
	pilot burner bottom part SIT 100 series nozzle ø 0.25mm		
	Part No.	107701	Ref. No. —
	pilot burner bottom part SIT 100 series nozzle ø 0.2mm		

accessories			
pilot burner nozzles			
 <p>1</p>			
Part No.	100245	Ref. No.	8C0030
description	pilot burner nozzle LPG code 20 bore ø 0.2mm Qty 1 pcs thread M8x0.75		
 <p>1</p>			
Part No.	100246	Ref. No.	8C0031
description	pilot burner nozzle natural gas bore ø 0.35mm Qty 1 pcs thread M8x0.75		



ignition electrodes			
Part No.	100706	Ref. No.	051H10002 808177 8C0637
description	ignition electrode connection M4 Qty 1 pcs		

Part No.	100707	Ref. No.	807741
description	ignition electrode D1 ø 7mm D2 ø 9mm connection ø2.4mm L1 14mm L2 6mm BL1 18mm BL2 3mm BL3 23mm to clip Qty 1 pcs		

140 - 145 -150 series				
Part No.	107133	Ref. No.	808353	
description	pilot burner SIT type 140 series 1 flame nozzle ømm gas connectionmm			
accessories for	107133			
	Part No.	100204	Ref. No.	8C0955
	pilot burner nozzle SIT LPG code 14 bore ø 0.18/0.20mm Qty 1 pcs suitable for 140 series			
	Part No.	100205	Ref. No.	809996
	pilot burner nozzle SIT LPG code 19 bore ø 0.23/0.26mm Qty 1 pcs suitable for SIT 150 series			
	Part No.	100206	Ref. No.	809994
	pilot burner nozzle SIT natural gas code 36 bore ø 0.60/0.55mm Qty 1 pcs suitable for SIT 150 series			
	Part No.	100207	Ref. No.	8C1497
	pilot burner nozzle SIT natural gas code 27 bore ø 0.40/0.38mm suitable for SIT 140 series			
	Part No.	100216	Ref. No.	—
	pilot burner nozzle SIT natural gas code 38 bore ø 0.45mm Qty 1 pcs suitable for SIT 150 series			
	Part No.	100701	Ref. No.	807905 809475 8C1498 C00173
	ignition electrode connection M4 Qty 1 pcs			

accessories for	107133			
	Part No.	100897	Ref. No.	—
	olive for pipe ø 4mm Qty 1 pcs for pilot burner			
	Part No.	100898	Ref. No.	—
	olive for pipe ø 6mm Qty 1 pcs for pilot burner			
	Part No.	100906	Ref. No.	—
	screw connection thread M10x1 for ignition electrode brass Qty 1 pcs WS 10			
	Part No.	100907	Ref. No.	—
	screw connection thread M10x1 Qty 1 pcs type SEF 1 ømm for thermocouple			
	Part No.	100908	Ref. No.	806019
	union screw thread M10x1 for pipe ø 4mm Qty 1 pcs			
	Part No.	100909	Ref. No.	—
	union screw thread M10x1 for pipe ø 6mm Qty 1 pcs			
	Part No.	102110	Ref. No.	—
	pilot tube copper pipe ø 4mm thickness 1mm L 3000mm			
	Part No.	102111	Ref. No.	—
	pilot tube copper pipe ø 6mm thickness 1mm L 3000mm			

Part No.	107114	Ref. No.	809474 8C1496	
description	pilot burner SIT type 140 series 2 flames nozzle ømm gas connectionmm			
spare parts for	107114			
	Part No.	100907	Ref. No.	—
	screw connection thread M10x1 Qty 1 pcs type SEF 1 ømm for thermocouple			
accessories for	107114			
	Part No.	100204	Ref. No.	8C0955
	pilot burner nozzle SIT LPG code 14 bore ø 0.18/0.20mm Qty 1 pcs suitable for 140 series			
	Part No.	100205	Ref. No.	809996
	pilot burner nozzle SIT LPG code 19 bore ø 0.23/0.26mm Qty 1 pcs suitable for SIT 150 series			
	Part No.	100206	Ref. No.	809994
	pilot burner nozzle SIT natural gas code 36 bore ø 0.60/0.55mm Qty 1 pcs suitable for SIT 150 series			
	Part No.	100207	Ref. No.	8C1497
	pilot burner nozzle SIT natural gas code 27 bore ø 0.40/0.38mm suitable for SIT 140 series			
	Part No.	100216	Ref. No.	—
	pilot burner nozzle SIT natural gas code 38 bore ø 0.45mm Qty 1 pcs suitable for SIT 150 series			
	Part No.	100701	Ref. No.	807905 809475 8C1498 C00173
	ignition electrode connection M4 Qty 1 pcs			

<sup>1</sup>incl. thermocouple fitting

Table continues overleaf



accessories for		107114	
Part No.	100801	Ref. No.	—
	gasket for pilot burner Qty 1 pcs		
Part No.	100897	Ref. No.	—
	olive for pipe ø 4mm Qty 1 pcs for pilot burner		
Part No.	100898	Ref. No.	—
	olive for pipe ø 6mm Qty 1 pcs for pilot burner		
Part No.	100906	Ref. No.	—
	screw connection thread M10x1 for ignition electrode brass Qty 1 pcs WS 10		
Part No.	100908	Ref. No.	806019
	union screw thread M10x1 for pipe ø 4mm Qty 1 pcs		
Part No.	100909	Ref. No.	—
	union screw thread M10x1 for pipe ø 6mm Qty 1 pcs		
Part No.	102110	Ref. No.	—
	pilot tube copper pipe ø 4mm thickness 1mm L 3000mm		
Part No.	102111	Ref. No.	—
	pilot tube copper pipe ø 6mm thickness 1mm L 3000mm		

accessories for		100052	
Part No.	100909	Ref. No.	—
	union screw thread M10x1 for pipe ø 6mm Qty 1 pcs		
Part No.	101282	Ref. No.	—
	olive for pipe ø 4mm L 7.4mm Qty 1 pcs		
Part No.	101287	Ref. No.	—
	olive for pipe ø 6mm Qty 1 pcs		
Part No.	102110	Ref. No.	—
	pilot tube copper pipe ø 4mm thickness 1mm L 3000mm		
Part No.	102111	Ref. No.	—
	pilot tube copper pipe ø 6mm thickness 1mm L 3000mm		
Part No.	107650	Ref. No.	808365
	pilot burner nozzle SIT LPG code 30 Qty 1 pcs		

160 series

	1		
Part No.	100052	Ref. No.	806153
description	pilot burner SIT type 160 series 2 flames nozzle ømm gas connectionmm		
spare parts for	100052		
Part No.	100907	Ref. No.	—
	screw connection thread M10x1 Qty 1 pcs type SEF 1 ømm for thermocouple		
accessories for	100052		
Part No.	100202	Ref. No.	—
	pilot burner nozzle natural gas code 41 Qty 1 pcs nozzle ø 0.41mm		
Part No.	100203	Ref. No.	—
	pilot burner nozzle LPG code 25 Qty 1 pcs nozzle ø 0.25mm		
Part No.	100701	Ref. No.	807905 809475 8C1498 C00173
	ignition electrode connection M4 Qty 1 pcs		
Part No.	100801	Ref. No.	—
	gasket for pilot burner Qty 1 pcs		
Part No.	100906	Ref. No.	—
	screw connection thread M10x1 for ignition electrode brass Qty 1 pcs WS 10		
Part No.	100908	Ref. No.	806019
	union screw thread M10x1 for pipe ø 4mm Qty 1 pcs		













POLIDORO

pilot burners

















	1		
Part No.	100051	Ref. No.	808039 808197 809197
description	pilot burner POLIDORO 3 flames code gas connectionmm		
spare parts for	100051		
Part No.	100907	Ref. No.	—
	screw connection thread M10x1 Qty 1 pcs type SEF 1 ømm for thermocouple		
accessories for	100051		
Part No.	100000	Ref. No.	—
	pilot burner nozzle POLIDORO LPG code 22 bore ø 0.22mm Qty 1 pcs		
Part No.	100208	Ref. No.	512120005 512120010 C00170
	pilot burner nozzle POLIDORO LPG code 20 bore ø 0.2mm Qty 1 pcs		
Part No.	100209	Ref. No.	—
	pilot burner nozzle POLIDORO natural gas code 40 bore ø 0.4mm Qty 1 pcs		
Part No.	100701	Ref. No.	807905 809475 8C1498 C00173
	ignition electrode connection M4 Qty 1 pcs		
Part No.	100906	Ref. No.	—
	screw connection thread M10x1 for ignition electrode brass Qty 1 pcs WS 10		
Part No.	100907	Ref. No.	—
	screw connection thread M10x1 Qty 1 pcs type SEF 1 ømm for thermocouple		
Part No.	100908	Ref. No.	806019
	union screw thread M10x1 for pipe ø 4mm Qty 1 pcs		

Table continues overleaf













accessories for		100051	
	Part No.	100909	Ref. No. —
	union screw thread M10x1 for pipe ø 6mm Qty 1 pcs		
	Part No.	102110	Ref. No. —
	pilot tube copper pipe ø 4mm thickness 1mm L 3000mm		
	Part No.	102111	Ref. No. —
	pilot tube copper pipe ø 6mm thickness 1mm L 3000mm		
	Part No.	102508	Ref. No. —
	union screw thread M10x1 for pipe ø 4mm Qty 5 pcs		
	Part No.	102509	Ref. No. —
	union screw thread M10x1 for pipe ø 6mm Qty 5 pcs		
	Part No.	102699	Ref. No. —
	pilot burner nozzle POLIDORO natural gas code 25.2 bore ø 2x0.25mm Qty 1 pcs 2 bores		
	Part No.	102795	Ref. No. —
	olive for pipe ø 4mm Qty 1 pcs		
	Part No.	102797	Ref. No. —
	olive for pipe ø 6mm Qty 1 pcs		
	Part No.	106703	Ref. No. 512120007 808033
	pilot burner nozzle POLIDORO natural gas code 27.2 bore ø 2x0.27mm Qty 1 pcs		
	Part No.	106704	Ref. No. —
	pilot burner nozzle POLIDORO LPG code 16.2 bore ø 2x0.16mm Qty 1 pcs		
	Part No.	106763	Ref. No. —
	pilot burner nozzle POLIDORO natural gas code 27.2A bore ø 2x 0.27mm Qty 1 pcs		
	Part No.	106859	Ref. No. —
	pilot burner nozzle POLIDORO LPG code 24 bore ø 0.24mm Qty 1 pcs		

			
1			
Part No.	100162	Ref. No.	809195
description	pilot burner POLIDORO 3 flames code gas connectionmm		
spare parts for	100162		
	Part No.	100907	Ref. No. —
	screw connection thread M10x1 Qty 1 pcs type SEF 1 ømm for thermocouple		
accessories for 100162			
	Part No.	100000	Ref. No. —
	pilot burner nozzle POLIDORO LPG code 22 bore ø 0.22mm Qty 1 pcs		
	Part No.	100208	Ref. No. 512120005 512120010 C00170
	pilot burner nozzle POLIDORO LPG code 20 bore ø 0.2mm Qty 1 pcs		
	Part No.	100209	Ref. No. —
	pilot burner nozzle POLIDORO natural gas code 40 bore ø 0.4mm Qty 1 pcs		



accessories for		100162	
	Part No.	100701	Ref. No. 807905 809475 8C1498 C00173
	ignition electrode connection M4 Qty 1 pcs		
	Part No.	100906	Ref. No. —
	screw connection thread M10x1 for ignition electrode brass Qty 1 pcs WS 10		
	Part No.	100907	Ref. No. —
	screw connection thread M10x1 Qty 1 pcs type SEF 1 ømm for thermocouple		
	Part No.	100908	Ref. No. 806019
	union screw thread M10x1 for pipe ø 4mm Qty 1 pcs		
	Part No.	100909	Ref. No. —
	union screw thread M10x1 for pipe ø 6mm Qty 1 pcs		
	Part No.	102110	Ref. No. —
	pilot tube copper pipe ø 4mm thickness 1mm L 3000mm		
	Part No.	102111	Ref. No. —
	pilot tube copper pipe ø 6mm thickness 1mm L 3000mm		
	Part No.	102508	Ref. No. —
	union screw thread M10x1 for pipe ø 4mm Qty 5 pcs		
	Part No.	102509	Ref. No. —
	union screw thread M10x1 for pipe ø 6mm Qty 5 pcs		
	Part No.	102699	Ref. No. —
	pilot burner nozzle POLIDORO natural gas code 25.2 bore ø 2x0.25mm Qty 1 pcs 2 bores		
	Part No.	102795	Ref. No. —
	olive for pipe ø 4mm Qty 1 pcs		
	Part No.	102797	Ref. No. —
	olive for pipe ø 6mm Qty 1 pcs		
	Part No.	106703	Ref. No. 512120007 808033
	pilot burner nozzle POLIDORO natural gas code 27.2 bore ø 2x0.27mm Qty 1 pcs		
	Part No.	106704	Ref. No. —
	pilot burner nozzle POLIDORO LPG code 16.2 bore ø 2x0.16mm Qty 1 pcs		
	Part No.	106763	Ref. No. —
	pilot burner nozzle POLIDORO natural gas code 27.2A bore ø 2x 0.27mm Qty 1 pcs		
	Part No.	106859	Ref. No. —
	pilot burner nozzle POLIDORO LPG code 24 bore ø 0.24mm Qty 1 pcs		



			
Part No.	100076	Ref. No.	806154 807835
description	pilot burner POLIDORO 3 flames natural gas code 29.2 gas connection 6mm		
spare parts for	100076		
	Part No.	100907	Ref. No. —
	screw connection thread M10x1 Qty 1 pcs type SEF 1 ømm for thermocouple		
accessories for 100076			
	Part No.	100000	Ref. No. —
	pilot burner nozzle POLIDORO LPG code 22 bore ø 0.22mm Qty 1 pcs		
	Part No.	100208	Ref. No. 512120005 512120010 C00170
	pilot burner nozzle POLIDORO LPG code 20 bore ø 0.2mm Qty 1 pcs		
	Part No.	100209	Ref. No. —
	pilot burner nozzle POLIDORO natural gas code 40 bore ø 0.4mm Qty 1 pcs		
	Part No.	100701	Ref. No. 807905 809475 8C1498 C00173
	ignition electrode connection M4 Qty 1 pcs		
	Part No.	100906	Ref. No. —
	screw connection thread M10x1 for ignition electrode brass Qty 1 pcs WS 10		
	Part No.	100907	Ref. No. —
	screw connection thread M10x1 Qty 1 pcs type SEF 1 ømm for thermocouple		
	Part No.	100908	Ref. No. 806019
	union screw thread M10x1 for pipe ø 4mm Qty 1 pcs		
	Part No.	100909	Ref. No. —
	union screw thread M10x1 for pipe ø 6mm Qty 1 pcs		
	Part No.	102110	Ref. No. —
	pilot tube copper pipe ø 4mm thickness 1mm L 3000mm		
	Part No.	102111	Ref. No. —
	pilot tube copper pipe ø 6mm thickness 1mm L 3000mm		
	Part No.	102508	Ref. No. —
	union screw thread M10x1 for pipe ø 4mm Qty 5 pcs		
	Part No.	102509	Ref. No. —
	union screw thread M10x1 for pipe ø 6mm Qty 5 pcs		
	Part No.	102699	Ref. No. —
	pilot burner nozzle POLIDORO natural gas code 25.2 bore ø 2x0.25mm Qty 1 pcs 2 bores		
	Part No.	102795	Ref. No. —
	olive for pipe ø 4mm Qty 1 pcs		
	Part No.	102797	Ref. No. —
	olive for pipe ø 6mm Qty 1 pcs		

accessories for	100076		
	Part No.	106703	Ref. No. 512120007 808033
	pilot burner nozzle POLIDORO natural gas code 27.2 bore ø 2x0.27mm Qty 1 pcs		
	Part No.	106704	Ref. No. —
	pilot burner nozzle POLIDORO LPG code 16.2 bore ø 2x0.16mm Qty 1 pcs		
	Part No.	106763	Ref. No. —
	pilot burner nozzle POLIDORO natural gas code 27.2A bore ø 2x 0.27mm Qty 1 pcs		
	Part No.	106859	Ref. No. —
	pilot burner nozzle POLIDORO LPG code 24 bore ø 0.24mm Qty 1 pcs		

## electrodes

			
Part No.	100701	Ref. No.	807905 809475 8C1498 C00173
description	ignition electrode connection M4 Qty 1 pcs		
accessories for	100701		
	Part No.	100906	Ref. No. —
	screw connection thread M10x1 for ignition electrode brass Qty 1 pcs WS 10		

			
Part No.	100706	Ref. No.	051H10002 808177 8C0637
description	ignition electrode connection M4 Qty 1 pcs		





Part No.	100707	Ref. No.	807741
description	ignition electrode D1 ø 7mm D2 ø 9mm connection ø2.4mm L1 14mm L2 6mm BL1 18mm BL2 3mm BL3 23mm to clip Qty 1 pcs		

Part No.	102342	Ref. No.	809281
description	ignition electrode flange length 24mm flange width 17mm D1 ø 9.5mm L1 48mm L2 13mm L3 15mm BL1 24mm BL2 35mm fixing dimensions ø4.5mm with flange connection ø 4mm		

### ignition cables

#### pre-assembled cables

Part No.	100026	Ref. No.	809430
description	ignition cable cable length 1000mm connection ø4mm / F6.3mm		

Part No.	100164	Ref. No.	C10259
description	ignition cable cable length 1200mm connection ø4mm / F2.8mm		

Part No.	102163	Ref. No.	808276
description	ignition cable cable length 1500mm connection F2.8mm / ø2.4mm		

Part No.	100014	Ref. No.	C00808
description	ignition cable cable length 300mm connection ø2.4mm / ø2.4mm		

Part No.	100197	Ref. No.	051E10008
description	ignition cable cable length 600mm connection F2.8mm / ø2.4mm		

Part No.	100018	Ref. No.	808230 C00171
description	ignition cable cable length 600mm connection ø2.4mm / ø4mm permanent temperature 200°C		

Part No.	100025	Ref. No.	809439 LF-3001017
description	ignition cable cable length 600mm connection ø4mm / F6.3mm		

Part No.	100019	Ref. No.	809389
description	ignition cable cable length 900mm connection ø2.4mm / ø4mm		

### ignition units

Part No.	101030	Ref. No.	C10167
description	ignition unit outputs 2 1.5 V/DC		

Part No.	101002	Ref. No.	813434 8C1700 C00507
description	ignition unit outputs 2 230VAC dimensions 88x23x34mm mounting distance 73mm inlet F6.3x0.8 outlet F2.8x0.8 0.6VA 50/60Hz		

Part No.	101031	Ref. No.	C10168
description	ignition unit outputs 4 1.5 V/DC dimensions 111x23x34mm mounting distance 100mm inlet F6.3x0.8 outlet F2.8x0.8 mounting ø 100mm		

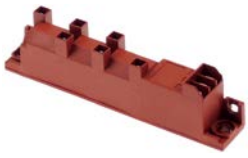
1

Part No.	102389	Ref. No.	LF-3181004
description	ignition unit outputs 6 230VAC dimensions 135x23x34mm mounting distance 123mm inlet F6.3x0.8 outlet F2.8x0.8 0.6VA 50/60Hz		

thermocouples

plug-in thermocouples

plug-in thermocouples standard

with barrel socket  $\varnothing 6(6.5)$ mm

thermocouples SIT

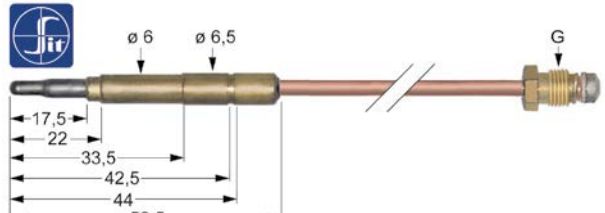

1

Part No.	107621	Ref. No.	808521
description	thermocouple SIT M10x1 L 1500mm plug connection $\varnothing 6.0(6.5)$ mm		

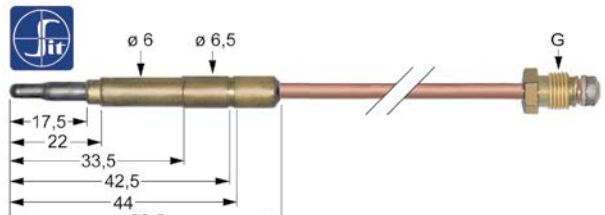

1

Part No.	107612	Ref. No.	806185
description	thermocouple SIT M9x1 L 1000mm plug connection $\varnothing 6.0(6.5)$ mm		

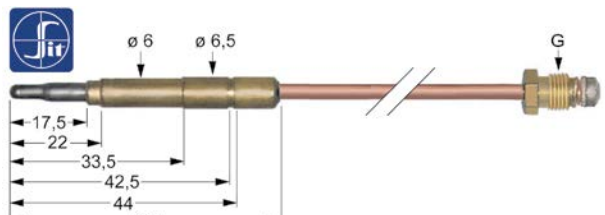

1

Part No.	107613	Ref. No.	806186 8C0639
description	thermocouple SIT M9x1 L 1200mm plug connection $\varnothing 6.0(6.5)$ mm		

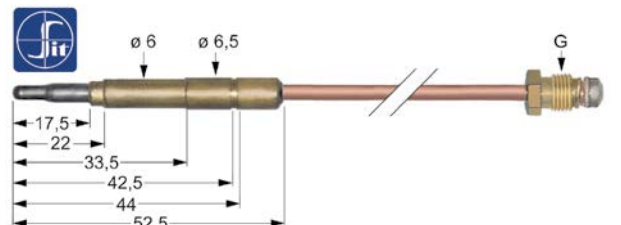

1

Part No.	107614	Ref. No.	814980 C10201
description	thermocouple SIT M9x1 L 1500mm plug connection $\varnothing 6.0(6.5)$ mm		

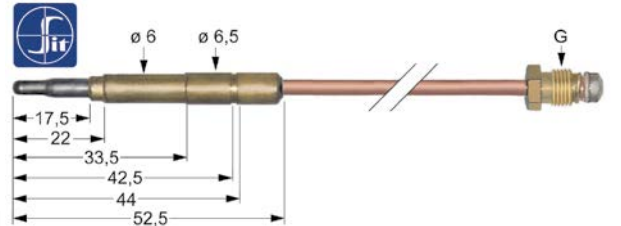

1

Part No.	107606	Ref. No.	C00072
description	thermocouple SIT M9x1 L 320mm plug connection $\varnothing 6.0(6.5)$ mm		

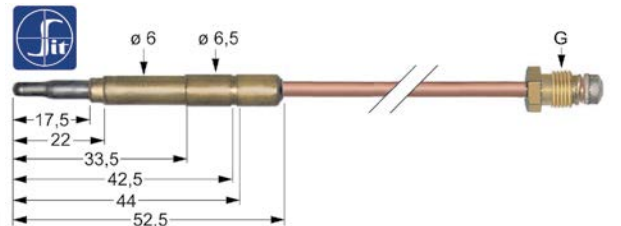

1

Part No.	107609	Ref. No.	806271 808178
description	thermocouple SIT M9x1 L 600mm plug connection $\varnothing 6.0(6.5)$ mm		

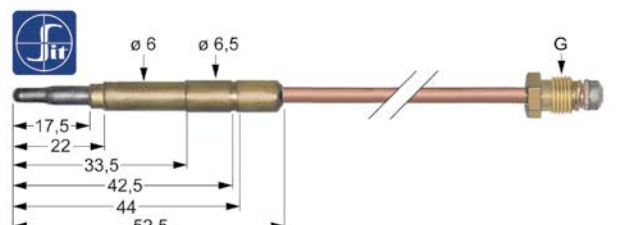

1

Part No.	107611	Ref. No.	806184 808138 C00377
description	thermocouple SIT M9x1 L 850mm plug connection $\varnothing 6.0(6.5)$ mm		

thermocouples with aluminised tip

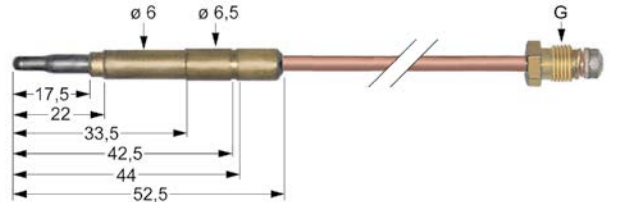

1

Part No.	102034	Ref. No.	808151
description	thermocouple M8x1 L 600mm plug connection $\varnothing 6.0(6.5)$ mm		



Part No.	102041	Ref. No.	806183
description	thermocouple M9x1 L 600mm plug connection ø6.0(6.5)mm		

plug-in thermocouples with interruption

Part No.	107164	Ref. No.	513120001
description	thermocouple SIT with interrupter M9x1 L 1000mm plug connection ø6.0(6.5)mm soldering connection		

accessories

interrupters

Part No.	101264	Ref. No.	8C1701
description	interrupter thread M8x1		

Part No.	101265	Ref. No.	807350 807842 C00169
description	interrupter thread M9x1		

gas burners

bar burners

bar burners

Part No.	105788	Ref. No.	809328
description	bar burner 1-row ø 50mm Wmm Hmm L 483mm flange width 71mm convection oven flange ø 75mm		

gas nozzles

main nozzles

gas nozzles M10x1

Part No.	100625	Ref. No.	809960
description	gas injector thread M10x1 WS 12 bore ø 1.15mm		

pilot burner nozzles

pilot burner nozzles POLIDORO

Part No.	100208	Ref. No.	512120005 512120010 C00170
description	pilot burner nozzle POLIDORO LPG code 20 bore ø 0.2mm Qty 1 pcs		

Part No.	106703	Ref. No.	512120007 808033
description	pilot burner nozzle POLIDORO natural gas code 27.2 bore ø 2x0.27mm Qty 1 pcs		

pilot burner nozzles SIT

100 series

Part No.	100245	Ref. No.	8C0030
description	pilot burner nozzle LPG code 20 bore ø 0.2mm Qty 1 pcs thread M8x0.75		

Part No.	100246	Ref. No.	8C0031
description	pilot burner nozzle natural gas bore ø 0.35mm Qty 1 pcs thread M8x0.75		

140/150 series

Part No.	100204	Ref. No.	8C0955
description	pilot burner nozzle SIT LPG code 14 bore ø 0.18/0.20mm Qty 1 pcs suitable for 140 series		





			
1			
Part No.	100205	Ref. No.	809996
description	pilot burner nozzle SIT LPG code 19 bore $\varnothing$ 0.23/0.26mm Qty 1 pcs suitable for SIT 150 series		

			
1			
Part No.	100207	Ref. No.	8C1497
description	pilot burner nozzle SIT natural gas code 27 bore $\varnothing$ 0.40/0.38mm suitable for SIT 140 series		

			
1			
Part No.	100206	Ref. No.	809994
description	pilot burner nozzle SIT natural gas code 36 bore $\varnothing$ 0.60/0.55mm Qty 1 pcs suitable for SIT 150 series		



160 series			
			
1			
Part No.	107650	Ref. No.	808365
description	pilot burner nozzle SIT LPG code 30 Qty 1 pcs		

			
1			
Part No.	107175	Ref. No.	808364
description	pilot burner nozzle SIT natural gas code 51 Qty 1 pcs suitable for 160 series		

screw connections			
olives			
			
1			
Part No.	101248	Ref. No.	8C0412
description	olive for pipe $\varnothing$ 12mm L 9.5mm brass Qty 1 pcs suitable for PEL		
accessories for	101248		
	Part No.	101251	Ref. No.
			—
	union nut thread M20x1.5 for pipe $\varnothing$ 12mm		

			
1			
Part No.	100870	Ref. No.	830885
description	olive for pipe $\varnothing$ 4mm Qty 1 pcs suitable for 160 series for pilot burner		

union screws			
			
1			
Part No.	100905	Ref. No.	8C0070
description	locking screw M10x1 for pipe $\varnothing$ 6mm Qty 1 pcs		

			
1			
Part No.	100908	Ref. No.	806019
description	union screw thread M10x1 for pipe $\varnothing$ 4mm Qty 1 pcs		
accessories for	100908		
	Part No.	100897	Ref. No.
			—
	olive for pipe $\varnothing$ 4mm Qty 1 pcs for pilot burner		
	Part No.	101246	Ref. No.
			—
	olive for pipe $\varnothing$ 4mm Qty 1 pcs		
	Part No.	101280	Ref. No.
			—
	olive for pipe $\varnothing$ 4mm Qty 1 pcs		
	Part No.	101282	Ref. No.
			—
	olive for pipe $\varnothing$ 4mm L 7.4mm Qty 1 pcs		

equipmentspecific units			
for convection ovens/combi-steamers			
glass panels			
			
1			
Part No.	694847	Ref. No.	00-AVP-002 8C1724
description	glass panel L 673mm W 510mm H 5mm		

gas components



## air filters



1

Part No.	692695	Ref. No.	809502
description	filter insert L 213mm W 60mm ømm H 90mm		

## miscellaneous



1

Part No.	512184	Ref. No.	809567
description	hose connector plastic thread 3/4" Qty 1 pcs connection distance 60mm T-shape		

## knobs

## accessories

## button springs



1

Part No.	550132	Ref. No.	C00196
description	knob spring ø 6x4.6mm Qty 10 pcs		

## locks

## edgemount latches

## handle latches

## CAFF/FERMOD

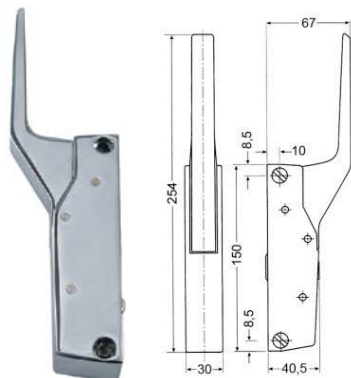

1

Part No.	700060	Ref. No.	9629921	
description	handle latch L 150mm mounting distance 133mm non lockable heated units G 791			
accessories for	700060			
	Part No.	700061	Ref. No.	8C0315
	door catch L 58mm W 20mm H 35mm mounting distance 42mm chrome-plated brass for headed units			

accessories for 700060



Part No.	700062	Ref. No.	—
handle protection heated units			

## door catches



1

Part No.	700061	Ref. No.	8C0315
description	door catch L 58mm W 20mm H 35mm mounting distance 42mm chrome-plated brass for headed units		

accessories for 700061



Part No.	690414	Ref. No.	—
handle latch L 150mm mounting distance 133mm non lockable refrigeration units G 791			



1

Part No.	700435	Ref. No.	809875
description	door catch L 58mm W 20mm H 35mm mounting distance 42mm zamak for refrigeration units		

## snap locks

## universal



1

Part No.	690596	Ref. No.	131110006 131110007 808747
description	snap lock L 60mm W 15mm H 36mm mounting distance 48/28mm spring thickness 1.5mm complete with door catch zamak		

## miscellaneous



1

Part No.	511482	Ref. No.	809708
description	pressure pin L 52mm thread M10x1.5		





hinges

oven hinges



1

Part No.	700434	Ref. No.	LF-5037262
description opposite support oven hinge			

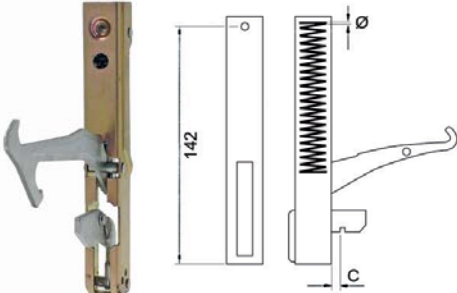

1

Part No.	700433	Ref. No.	132110006								
description oven hinge mounting distance 142mm mounting distance 2mm lug mountingmm lever length 100mm groove distance 14mm spring thickness 4mm mounting ear position spring length 55mm L 155mm mounting pos. left/right											
accessories for 700433											
<table border="1"> <tr> <td>Part No.</td> <td>700434</td> <td>Ref. No.</td> <td>LF-5037262</td> </tr> <tr> <td colspan="4">opposite support oven hinge</td> </tr> </table>				Part No.	700434	Ref. No.	LF-5037262	opposite support oven hinge			
Part No.	700434	Ref. No.	LF-5037262								
opposite support oven hinge											



1

Part No.	700006	Ref. No.	C00130								
description oven hinge mounting distance 173mm mounting distance 2 105mm lug mounting 14mm lever length 120mm groove distance 11mm spring thickness 3.5mm mounting ear position left spring length 112mm W 25mm											
accessories for 700006											
<table border="1"> <tr> <td>Part No.</td> <td>700001</td> <td>Ref. No.</td> <td>—</td> </tr> <tr> <td colspan="4">opposite support L 118mm W 17mm mounting distance 94mm</td> </tr> </table>				Part No.	700001	Ref. No.	—	opposite support L 118mm W 17mm mounting distance 94mm			
Part No.	700001	Ref. No.	—								
opposite support L 118mm W 17mm mounting distance 94mm											
<table border="1"> <tr> <td>Part No.</td> <td>700007</td> <td>Ref. No.</td> <td>—</td> </tr> <tr> <td colspan="4">oven hinge mounting distance 173mm mounting distance 2 105mm lug mounting 14mm lever length 120mm groove distance 11mm spring thickness 3.5mm mounting ear position right spring length 112mm W 25mm</td> </tr> </table>				Part No.	700007	Ref. No.	—	oven hinge mounting distance 173mm mounting distance 2 105mm lug mounting 14mm lever length 120mm groove distance 11mm spring thickness 3.5mm mounting ear position right spring length 112mm W 25mm			
Part No.	700007	Ref. No.	—								
oven hinge mounting distance 173mm mounting distance 2 105mm lug mounting 14mm lever length 120mm groove distance 11mm spring thickness 3.5mm mounting ear position right spring length 112mm W 25mm											

gaskets

gaskets for heated units

window seals

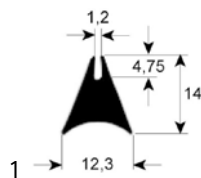

Part No.	900058	Ref. No.	807587-25MT 807587-6MT 808665 808666
description window gasket profile 1620 Qty supplied by meter			

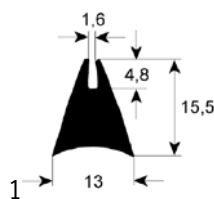

Part No.	900472	Ref. No.	807587
description window gasket profile 1650 L 1700mm Qty 1			

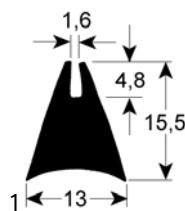

Part No.	900881	Ref. No.	809024
description window gasket profile 1650 Qty supplied by meter			

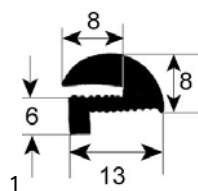

Part No.	900782	Ref. No.	9629920
description window gasket profile 1889 Qty supplied by meter			



door seals

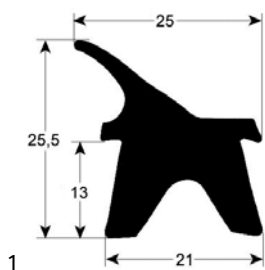

1

Part No.	900348	Ref. No.	807581 807581-15MT 807581-6MT 807582-15MT 807582-6MT 807583-25MT 807583-6MT 808226-15MT 808226-6MT 808668 808668-15MT 808668-6MT 809283 809283-15MT 809283-6MT 8C1193 8C1193-15MT 8C1193-6MT
description	door seal profile 2402 Qty supplied by meter		

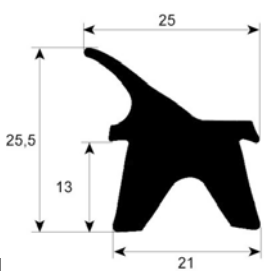

1

Part No.	901351	Ref. No.	809796
description	door seal profile 2402 W 490mm L 635mm external size		

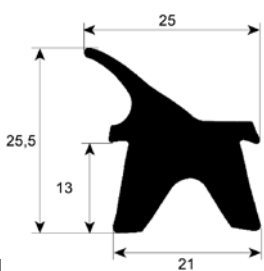

1

Part No.	901158	Ref. No.	8C0029
description	door seal profile 2402 W 640mm L 740mm		

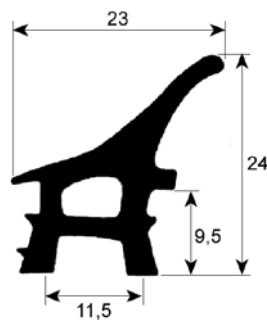

1

Part No.	900778	Ref. No.	9629918-15MT
description	door seal profile 2403 L 470mm Qty 1 mounting pos. vertical		

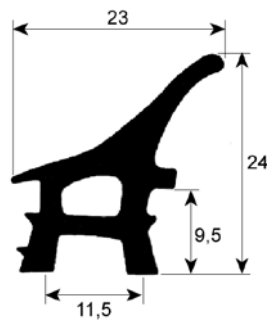

1

Part No.	900781	Ref. No.	9629918 9629918-3MT
description	door seal profile 2403 Qty supplied by meter		

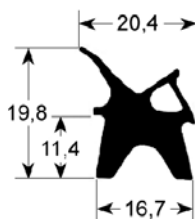

1

Part No.	900059	Ref. No.	807582 807583 808226
description	door seal profile 2410 Qty supplied by meter		

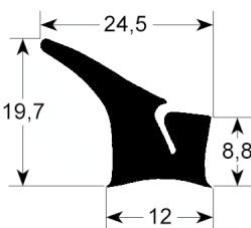

1

Part No.	900602	Ref. No.	809881
description	door seal profile 2430 Qty supplied by meter		

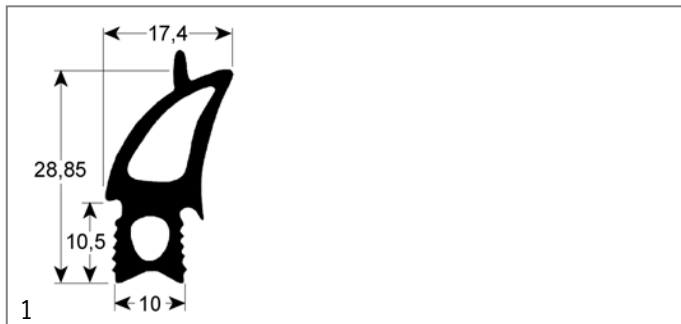

Part No.	900290	Ref. No.	809657
description door seal profile 2730 W 465mm L 520mm external size Qty 1			

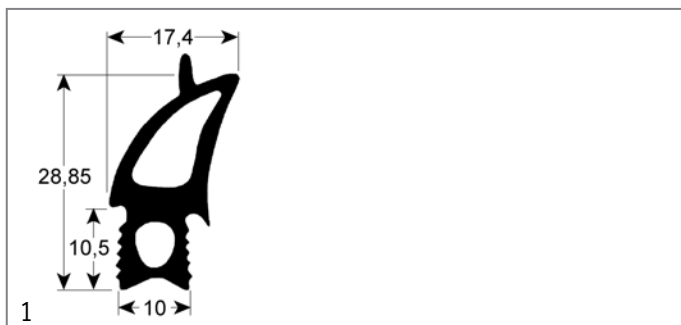

Part No.	902219	Ref. No.	902219
description door seal profile 2730 W 465mm L 520mm external size Qty 1			

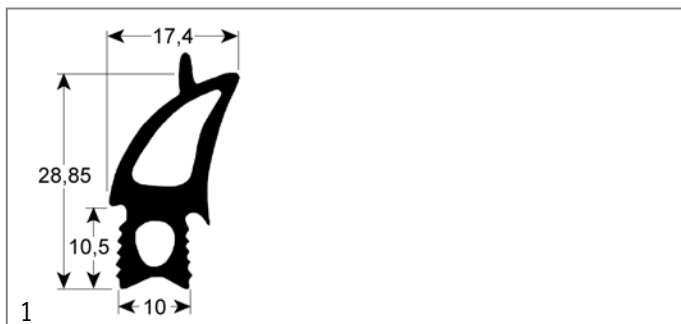

Part No.	902247	Ref. No.	809562
description door seal profile 2730 W 470mm L 785mm suitable for RATIONAL for model CPC 101 outer plug size Qty 1			

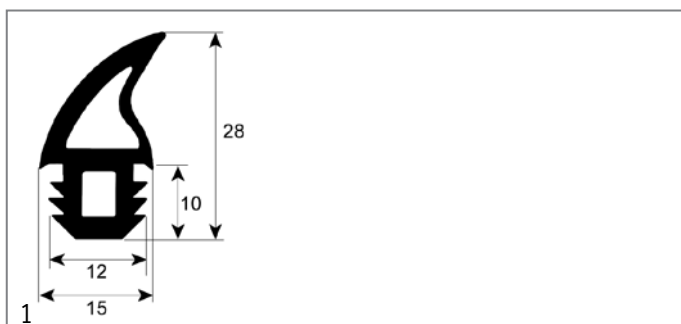

Part No.	901331	Ref. No.	8C0917
description door seal profile 2756 Qty supplied by meter			

door seals with fixing hook



Part No.	900394	Ref. No.	132110003
description door seal L 370mm W 640mm 6 hooks external size			

gaskets for tray rack trolleys

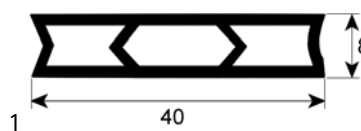

Part No.	901330	Ref. No.	141110016 J04GRN005
description tray rack trolley gasket profile 4065 silicone Qty supplied by meter			

O-rings

Viton

ø2.62mm

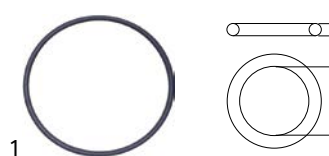

Part No.	532649	Ref. No.	808710
description O-ring Viton ID ø 63.17mm thickness 2.62mm Qty 1 pcs			

ø3.53mm

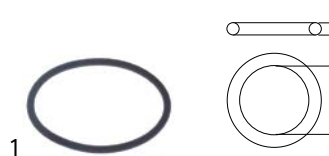

Part No.	525313	Ref. No.	808709
description O-ring Viton ID ø 60.33mm thickness 3.53mm Qty 1 pcs			



Part No.	510245	Ref. No.	808054
description O-ring Viton thickness 3.53mm ID ø 50.8mm Qty 1 pcs			

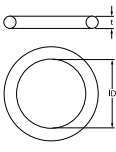



1

Part No.	510243	Ref. No.	808055
description	O-ring Viton thickness 3.53mm ID ø 55.56mm Qty 1 pcs		

### sealing washers

#### fibre gaskets



1

Part No.	510405	Ref. No.	903300
description	flat gasket fibre ED ø 56mm ID ø 42mm thickness 2mm for thread 1¼" Qty 1 pcs		

#### shaft gaskets

#### shaft gaskets



1

Part No.	511171	Ref. No.	809829
description	shaft seal ID ø 14.5mm ED ø 20mm thickness 3mm		

## transmission technology and ball bearings

#### ball bearings

#### deep-groove ball bearings 2RS



1

Part No.	523510	Ref. No.	EC1110002
description	deep-groove ball bearing type 6202-2RS shaft ø 15mm ED ø 35mm W 11mm with sealing discs deep-groove ball bearing DIN 625-1		



1

Part No.	523511	Ref. No.	809855
description	deep-groove ball bearing type 6203-2RS shaft ø 17mm ED ø 40mm W 12mm with sealing discs deep-groove ball bearing DIN 625-1		

## manometers



1

Part No.	541062	Ref. No.	808347	
description	manometer ø 63mm pressure range 0 up to 1bar connection marking adjustable kettle thread 1/4"			
spare parts for	541062			
	Part No.	541130	Ref. No.	—
	glass panel ø 58mm thickness 2mm			

## hose reels and spray guns

### cleaning guns



1

Part No.	541473	Ref. No.	8C2178	
description	cleaning spray gun connection with snap-on connection DN13 brass			
spare parts for	541473			
	Part No.	540516	Ref. No.	—
	coupling bush type DN13 chrome-plated brass connection 1/2" IT			
	Part No.	540535	Ref. No.	—
	nozzle connection snap-on connection short SS			
accessories for	541473			
	Part No.	540536	Ref. No.	—
	foam lance connection snap-on connection plastic total length 182mm			
	Part No.	541870	Ref. No.	—
	foam lance connection snap-on connection aluminium L 450mm			

mechanical components, equipment accessories





hoses

supply hoses

stainless steel flexi hoses

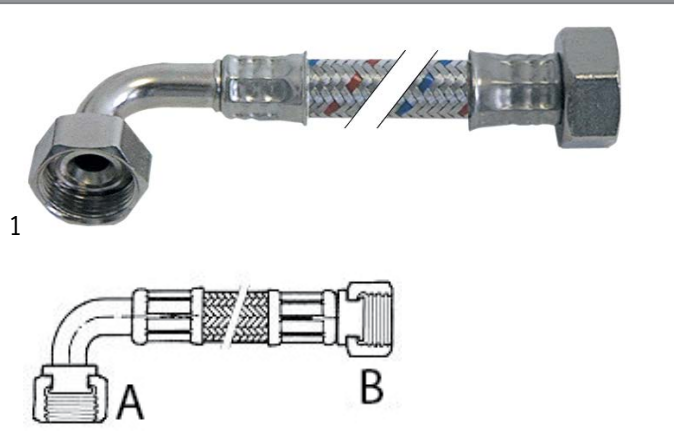
universal hoses



Part No.	521292	Ref. No.	00053060 00053120 00053130
description	flex hose SS braid straight-curved DN12 connection 1: 3/4" connection 2: 3/4" L 1500mm approval WRAS operating p. 10bar test pressure 32bar burst p. 95bar		
accessories for	521292		
	Part No.	520054	Ref. No. —
	flat gasket rubber ED ø 23.5mm ID ø 14mm thickness 2.3mm Qty 10 pcs		

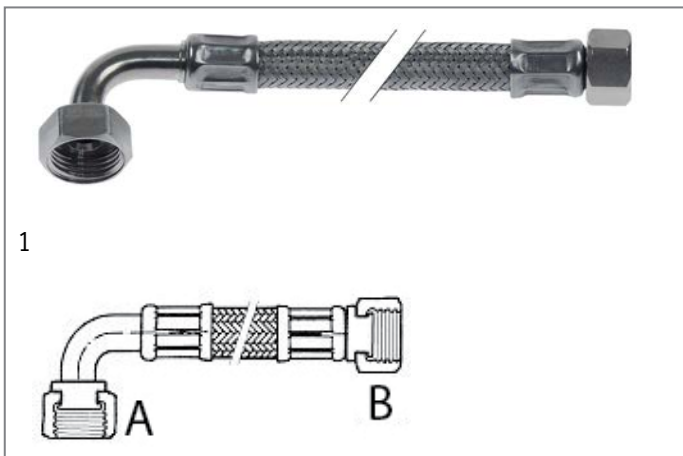

Part No.	521294	Ref. No.	12160007
description	supply hose SS braid straight-curved DN8 connection 1: 3/8" connection 2: 1/2" L 660mm incl. gasket approval operating p. 20bar t.max. 90°C		

PVC supply hoses

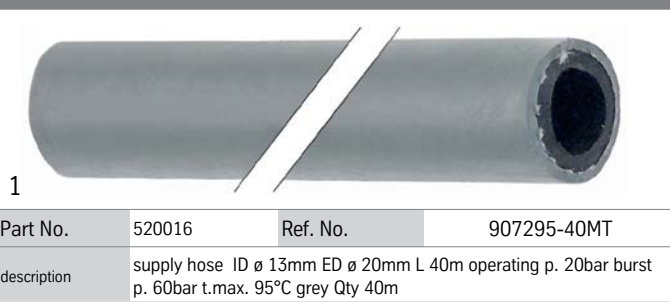

Part No.	520016	Ref. No.	907295-40MT
description	supply hose ID ø 13mm ED ø 20mm L 40m operating p. 20bar burst p. 60bar t.max. 95°C grey Qty 40m		

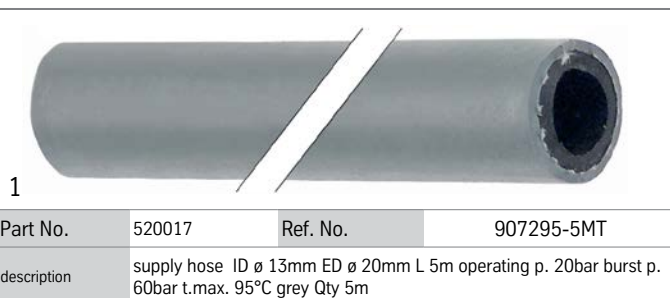

Part No.	520017	Ref. No.	907295-5MT
description	supply hose ID ø 13mm ED ø 20mm L 5m operating p. 20bar burst p. 60bar t.max. 95°C grey Qty 5m		

for dishwashers

miscellaneous



Part No.	511467	Ref. No.	907295
description	pressure hose L 1000mm		

valves and tank inlets

ball valves

universal

ball valves with lever handle



Part No.	520280	Ref. No.	827969
description	ball valve connection 1/2" IT - 1/2" IT DN15 total length 50mm with lever handle handle length 85mm		





ancillary products

clamps

hose clamps

DIN 3017 - W2



1

Part No.	520112	Ref. No.	902440
description	hose clamp ø 12-20mm width 9mm Qty 10 pcs DIN 3017		



1

Part No.	520119	Ref. No.	902490
description	hose clamp ø 60-80mm width 9mm Qty 5 pcs DIN 3017		



1

Part No.	520454	Ref. No.	05100008 E23110007
description	hose clamp ø 70-90mm width 9mm Qty 5 pcs DIN 3017		



1

Part No.	520117	Ref. No.	05100003
description	hose clamp stainless steel ø 40-60mm width 9mm Qty 5 pcs DIN 3017		

DIN 3017 - W4



1

Part No.	520120	Ref. No.	05100007
description	hose clamp SS W4 ø 12-20mm width 9mm Qty 1 pcs DIN 3017		

measuring equipment

thermometers

built-in thermometers

ø52mm



1

Part No.	541077	Ref. No.	808667
description	thermometer mounting ø 52mm t.max. 350°C +50 up to +350°C probe ø 6mm probe L 30mm capillary pipe 1000mm built-in depth 28mm		

fastening material

screws

countersunk screws



1

Part No.	560425	Ref. No.	01190002
description	countersunk screw thread M4 L 13mm stainless steel DIN 965/ISO 7046 Qty 1 pcs head ø 7.5mm		

nuts

cap nuts



1

Part No.	560137	Ref. No.	808998
description	cap nuts thread M6 WS 10 SS Qty 20 pcs DIN/ISO DIN 1587		

hexagonal nuts

DIN 934 / ISO 4032/8673



1

Part No.	511212	Ref. No.	03100006
description	hexagonal nut thread M6 H 5mm WS 10 SS DIN/ISO DIN 934 / ISO 4032/8673 Qty 1 pcs		



## washers

## washers

## DIN 125A



1

Part No.	560312	Ref. No.	02120010 8C0631
description	plain washer ID $\varnothing$ 10.5mm ED $\varnothing$ 20mm thickness 2mm SS Qty 1 pcs DIN 125A for thread M10		

## miscellaneous



1

Part No.	524117	Ref. No.	02120006 8C1731 E25110025
description	plain washer ID $\varnothing$ 6.4mm ED $\varnothing$ 12mm thickness 1.6mm SS Qty 1 pcs		

## fasteners

## clamps

## hose clamps

## DIN 3017 - W2



1

Part No.	520112	Ref. No.	902440
description	hose clamp $\varnothing$ 12-20mm width 9mm Qty 10 pcs DIN 3017		



1

Part No.	520119	Ref. No.	902490
description	hose clamp $\varnothing$ 60-80mm width 9mm Qty 5 pcs DIN 3017		



1

Part No.	520454	Ref. No.	05100008 E23110007
description	hose clamp $\varnothing$ 70-90mm width 9mm Qty 5 pcs DIN 3017		



1

Part No.	520117	Ref. No.	05100003
description	hose clamp stainless steel $\varnothing$ 40-60mm width 9mm Qty 5 pcs DIN 3017		

## DIN 3017 - W4



1

Part No.	520120	Ref. No.	05100007
description	hose clamp SS W4 $\varnothing$ 12-20mm width 9mm Qty 1 pcs DIN 3017		

## roll pins



1

Part No.	516242	Ref. No.	809053
description	roll pin $\varnothing$ 3mm L 26mm		

**GASTROPARTS.COM**



© 2020 Gastroparts Sp. J. All rights reserved.