



GASTROPARTS

Eloma

[EN] Cooking

[DE] Kochtechnik

[ES] Cocción

[FR] Cuisson

[IT] Cottura

[PL] Obróbka termiczna

[RU] Термическая обработка

✉ gastroparts@gastroparts.com

☎ tel. +48 56 657 00 66

📘 fb.com/gastroparts.global



GASTROPARTS.COM









heating elements

heating elements for convection





 <p>1</p>			
Part No.	418739	Ref. No.	318105 742414 EL0742414 ELE318105
description	heating element 10500W 230V heating circuits 3 ID ø 411mm ED ø 428mm L 480mm H 110mm L1 52mm W1 99mm H1 18mm H2 92mm flange length 130mm flange width 54mm hole distance 55mm connection M5 connection length 96mm tube ø 8.5mm convection heating element mounting thread M6 rectangular flange with thread bolt		
For models:	1011, 2011, 611, AUTOCLEAN, GENIUS, GENIUS6-11, MAKT, MB, MULTIMAXA, MULTIMAXB		
accessories for	418739		
	Part No.	551240	Ref. No.
			749451 E427064 EL0749451 ELE427064
gasket L 129mm W 87mm D1 ø 12mm D2 ø 7mm 12 holes graphite thickness 1mm			



 <p>1</p>			
Part No.	418897	Ref. No.	318004 576344 E318004 E318090 EL0576344 EL0581984 ELE318004 ELE318090 R0188
description	heating element 1600W 230V heating circuits 1 ID ø 220mm ED ø 240mm L 330mm L1 90mm thread M10x1 connection male faston 6.3mm tube ø 6.5mm convection heating element for combi-steamer		
For models:	ELH53, ELH5-3-McDonalds, MD523		

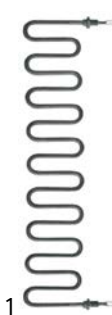

 <p>1</p>			
Part No.	418959	Ref. No.	742422 E318106 EL0742422 ELE318106
description	heating element 21600W 230V heating circuits 6 ID ø 414mm ED ø 466mm L 522mm H 121.5mm L1 88mm W1 97mm H1 30.5mm H2 91mm flange length 130mm flange width 88mm connection M5 connection length 70mm tube ø 6.5mm mounting thread M6 flange with bolt M6		
For models:	1011, 2011, 611, AUTOCLEAN, GENIUS, MAKT, MB, MULTIMAXA, MULTIMAXB		
accessories for	418959		
	Part No.	551240	Ref. No.
			749451 E427064 EL0749451 ELE427064
gasket L 129mm W 87mm D1 ø 12mm D2 ø 7mm 12 holes graphite thickness 1mm			







 <p>1</p>			
Part No.	415805	Ref. No.	693383 E318078 EL0693383 ELE318078
description	heating element 5700W 230V heating circuits 3 ID ø 206mm ED ø 245mm L 290mm H 42mm L1 45mm W1 97mm H1 2mm H2 40mm flange length 110mm flange width 20mm hole distance 35mm connection male faston 6.3mm connection length 58mm tube ø 6.3mm convection heating element hole ø 6.5mm rectangular flange		
For models:	EB30, JOKERB, JOKERC		



			
Part No.	415221	Ref. No.	332429 E318045 EL0332429 ELE318045 R0305
description	heating element 1430W 230V heating circuits 1 L 90mm W 390mm connection male faston 6.3mm tube ø 6.3mm thread M10x1 2 hole fixing dry heating element mounting distance 376mm		
For models:	MD611, MMD611		
accessories for	415221		
	Part No.	510893	Ref. No. —
	O-ring EPDM thickness 2.62mm ID ø 9.92mm Qty 1 pcs		
	Part No.	520231	Ref. No. —
	nut thread M10x1 H 6mm WS 14 zinc-coated steel Qty 1 pcs		
	Part No.	521129	Ref. No. —
	nut thread M10 H 6mm SS WS 17 Qty 1 pcs DIN/ISO DIN 439		
	Part No.	528433	Ref. No. 097071 217840 E427020 E427039 EL0097071 EL0217840 EL0571849 ELE427020 ELE427039 R0300
	flat gasket copper ED ø 14mm ID ø 10mm thickness 1mm		

			
Part No.	415222	Ref. No.	318018 576581 E318082 EL0576581 ELE318082
description	heating element 2300W 230V heating circuits 1 L 90mm W 395mm connection M4 tube ø 8.5mm thread M14x1.5 2 hole fixing dry heating element		
For models:	ELH101, MD1011, MD2011, MMC1011, MMC2011, MMD1011, MMD2011		
accessories for	415222		
	Part No.	521103	Ref. No. —
	nut thread M4 H 3mm WS 7 brass Qty 20 pcs		

accessories for	415222		
	Part No.	521104	Ref. No. —
	washer ID ø 4.3mm ED ø 8mm thickness 0.5mm brass Qty 20 pcs for thread M4		
	Part No.	560111	Ref. No. —
	plain washer ID ø 4.3mm ED ø 9mm thickness 0.8mm SS Qty 20 pcs DIN 125A for thread M4		
	Part No.	560131	Ref. No. —
	hexagonal nut thread M4 H 3.2mm WS 7 SS DIN/ISO DIN 934 / ISO 4032/8673 Qty 20 pcs		

			
Part No.	415542	Ref. No.	318047 E318084 ELE318047 ELE318084 R0321
description	heating element 2500W 230V heating circuits 1 L 131mm W 485mm connection length 20mm connection M4 tube ø 8.5mm thread M14x1.5 2 hole fixing convection heating element mounting distance 480mm		
For models:	MMC2021, MMD2021		
accessories for	415542		
	Part No.	510417	Ref. No. —
	flat gasket fibre ED ø 20mm ID ø 14mm thickness 2mm Qty 1 pcs		
	Part No.	520228	Ref. No. —
	tooth lock washer ID ø 15.3mm ED ø 24mm steel Qty 1 pcs for thread M14		
	Part No.	520230	Ref. No. —
	nut thread M14x1.5 H 5mm WS 19 zinc-coated steel Qty 1 pcs		
	Part No.	521101	Ref. No. —
	nut thread M14x1.5 H 5mm WS 19 SS Qty 1 pcs		
	Part No.	550262	Ref. No. —
	flat gasket copper ED ø 20mm ID ø 14mm thickness 2mm		



1

Part No.	415543	Ref. No.	E318083 ELE318083 R0320
description	heating element 4000W 230V heating circuits 1 L 131mm W 485mm connection M4 tube ø 8.5mm thread M14x1.5 2 hole fixing dry heating element		
For models:	MMD2021		

thermostats

control and safety thermostats

EGO

control thermostats

55.10/19_ series

E·G·O



1

Part No.	375070	Ref. No.	091634 E0268 E334007 EL0091634 ELE334007
description	thermostat t.max. 250°C temperature range 55-250°C 1-pole 1CO 16A probe ø 3.1mm probe L 226mm capillary pipe 1170mm capillary pipe isolated 1100mm gland nut M9x1 shaft L 23mm shaft position upper rotation 270°		
For models:	1011, 611, AUTOCLEAN, JOKERB, JOKERC, MD1011, MD2011, MD523, MD611, MMD1011, MMD2011, MMD2021, MMD611, MULTIMAXA, WU14		

safety thermostats

55.32_ series

E·G·O

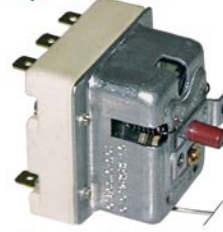

1

Part No.	375065	Ref. No.	E0234 E336005 ELE336005
description	safety thermostat switch-off temp. 500°C 3-pole 3NC 20A probe ø 4mm probe L 308mm capillary pipe 890mm capillary pipe isolatedmm gland nut probe SS		

55.33_ series

E·G·O



1

Part No.	375118	Ref. No.	580457 E336027 EL0580457 ELE336027
description	safety thermostat switch-off temp. 360°C 3-pole 20A probe ø 15mm probe L 8mm capillary pipe 1150mm capillary pipe isolated 1100mm gland nut probe with knob probe		



56._ series





1

Part No.	375889	Ref. No.	504602 E336029 EL0504602 ELE336029
description	safety thermostat switch-off temp. 360°C 1-pole 16A probe ø 15mm probe L 6.5mm capillary pipe 1140mm capillary pipe isolated 1100mm gland nut probe		
For models:	1011, 1221, 2011, 2021, 611, AUTOCLEAN, EB30, EB30XLDIGITAL, GENIUS, GENIUS6-11, GENIUS6-11GAS, GENIUSGAS, JOKERB, JOKERC, MAKT, MB, MULTIMAXA, MULTIMAXB, MULTIMAXB6-11AUTOCLEAN		
accessories for	375889		
	Part No.	518669	Ref. No. 0373079 ELO373079
gasket PTFE ED ø 21mm ID ø 15mm thickness 3.5mm			

switches and momentary switches

microswitches



universal

1

Part No.	345042	Ref. No.	570540 E320055 EL0570540 ELE320055
description	microswitch with plunger 250V 16A 1CO connection male faston 6.3mm L 28mm ambient temperature max. 125°C mounting distance 22mm type EF83161.3 actuating force: 75g blue/black		
For models:	EB30, EB30XLDIGITAL, JOKERB, JOKERC		
accessories for	345042		
	Part No.	345043	Ref. No. —
lever set 5-piece			

pin-plunger actuated

1

Part No.	345042	Ref. No.	570540 E320055 EL0570540 ELE320055
description	microswitch with plunger 250V 16A 1CO connection male faston 6.3mm L 28mm ambient temperature max. 125°C mounting distance 22mm type EF83161.3 actuating force: 75g blue/black		
For models:	EB30, EB30XLDIGITAL, JOKERB, JOKERC		
accessories for	345042		
	Part No.	345043	Ref. No. —
lever set 5-piece			

M16



1

Part No.	345046	Ref. No.	092444 E0290 E320036 EL0092444 ELE320036 V0600
description	microswitch with plunger thread M16x1 thread L 25mm 250V 5A 1NC/1NO connection male faston 6.3mm stroke 6mm ambient temperature max. 85°C actuating force: 400g		
For models:	MD1011, MD2011, MD523, MD611, MMD1011, MMD2011, MMD2021, MMD611		

cam switches

4-position



1

Part No.	300016	Ref. No.	E0185
description	cam switch 4 operating positions 1NO/2CO sequence 0-1-2-3 16A shaft ø 6x4.6mm shaft L 23mm connection male faston 6.3mm ceramic		



4 operating positions

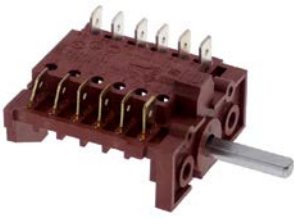

1

Part No.	300057	Ref. No.	292664 E0194 E320008 EL0292664 ELE320008
description	cam switch 4 operating positions 6NO sequence 0-1-2-3 16A shaft \varnothing 6x4.6mm shaft L 23mm connection male faston 6.3mm 6CH/141 plastic		
For models:	MD1011, MD523, MD611		

magnetic switches

 \varnothing 5.22mm

1

Part No.	347011	Ref. No.	581038 E320072 EL0581038 ELE320072
description	magnetic switch 250V 0.04A P max. 10W probe L 26mm 1NO cable length 1000mm		
For models:	1011, 1221, 2011, 2021, 611, AUTOCLEAN, GENIUS, GENIUS6-11, GENIUS6-11GAS, GENIUSGAS, MAKT, MB, MULTIMAXA, MULTIMAXB		

M12x1

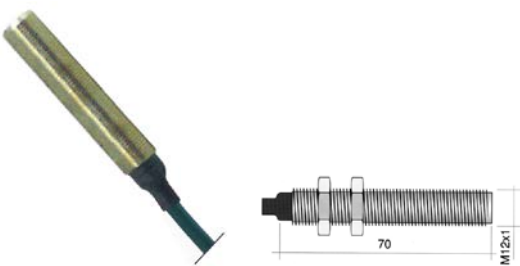

1

Part No.	345135	Ref. No.	372986 E1029 E320048 EL0372986 ELE320048
description	magnetic switch thread M12x1 1NO 250V 3A P max. 100W connection cable cable length 2000mm L 72mm type 122		
For models:	JOKERB, JOKERC		

control equipment

SCHLEGEL

switch blocks



1

Part No.	359756	Ref. No.	580384 E320070 EL0580384 ELE320070
description	contact block latching 1NO/1NC connection male faston 2.8mm illuminable socket T5.5K type BFL5		
accessories for	359756		
	Part No.	359593	Ref. No. —
	light bulb socket T5.5K 60V 0.02A		

lamps

indicator lights

indicator lights (complete)

 \varnothing 6mm

1

Part No.	359004	Ref. No.	332771 E0960 E314010 EL0332771 ELE314010
description	indicator light \varnothing 6mm 230V green cable length 400mm temp.-resist. 106°C		
For models:	MD1011, MD2011, MD523, MD611		



1

Part No.	359005	Ref. No.	332798 E0961 E314011 EL0332798 ELE314011
description	indicator light \varnothing 6mm 230V yellow cable length 400mm		
For models:	MD1011, MD2011, MD523, MD611		



screw-on/push-on fit

halogen lamp

for socket G4 / G6.35 / G9



Part No.	359596	Ref. No.	571954 E312023 EL0571954 ELE312023
description	halogen lamp socket G4 12V 10W temp.-resist. 500°C		
For models:	EB30		



Part No.	359599	Ref. No.	570478 E312021 EL0570478 ELE312021
description	halogen lamp socket G4 12V 20W temp.-resist. 500°C		
For models:	1011, 1221, 2011, 2021, 611, AUTOCLEAN, EB30XLDIGITAL, GENIUS, GENIUS6-11, GENIUS6-11GAS, GENIUSGAS, JOKERB, JOKERC, MAKT, MB, MULTIMAXA, MULTIMAXB		

oven lamps

universal oven lamps

mounting diameter 35.5mm



Part No.	359705	Ref. No.	092339 E0555 E460003 EL0092339 ELE460003
description	oven lamp glass thr.ø 33.5mm ø 52mm hard glas temp.-resist. 350°C		
accessories for	359705		

	Part No.	359610	Ref. No.	E0565 E312004 ELE312004
	light bulb t.max. 300°C socket E14 15W 230V ø 22mm L 47mm lens L 20mm for oven lamp type Philips			

	Part No.	359700	Ref. No.	—
	gasket for pizza oven fibre glass ID ø 32.5mm ED ø 55mm thickness 5mm			

	Part No.	359721	Ref. No.	693421 976024 E0556 E425005 E425132 EL0976024 ELE425005 ELE425132
	gasket silicone ED ø 48mm ID ø 39.5mm thickness 5mm Qty 1 pcs			

	Part No.	359837	Ref. No.	—
	gasket ID ø 33mm ED ø 46mm thickness 1mm graphite			

accessories for	359705			
	Part No.	359838	Ref. No.	—
	gasket ID ø 33mm ED ø 45mm			

lamps

halogen lamps

for socket G4 / G6.35 / G9



Part No.	359596	Ref. No.	571954 E312023 EL0571954 ELE312023
description	halogen lamp socket G4 12V 10W temp.-resist. 500°C		
For models:	EB30		



Part No.	359599	Ref. No.	570478 E312021 EL0570478 ELE312021
description	halogen lamp socket G4 12V 20W temp.-resist. 500°C		
For models:	1011, 1221, 2011, 2021, 611, AUTOCLEAN, EB30XLDIGITAL, GENIUS, GENIUS6-11, GENIUS6-11GAS, GENIUSGAS, JOKERB, JOKERC, MAKT, MB, MULTIMAXA, MULTIMAXB		

sockets

G4 / G5,3 / G6,35





Part No.	359646	Ref. No.	577294 E314031 EL0577294 ELE314031
description	lamp socket socket G4/G5.3/G6.35 24V ø 17mm H 15mm connection cable 130mm mounting distance 26mm for halogen lamp holder length 31mm cable length 130mm		
For models:	1011, 1221, 2011, 2021, 611, GENIUS, JOKERB, JOKERC, MAKT, MB		



solid state relays

CELDUC

			
1			
Part No.	402049	Ref. No.	752401 E324033 EL0752401 ELE324033
description	solid state relay CELDUC 1 phase 60A 24-600V 3-32VDC L 58mm W 45mm screw type SO965460		
For models:	1011, 2011, 611, AUTOCLEAN, GENIUS, GENIUS6-11, GENIUS6-11GAS, GENIUSGAS, MAKT, MB, MULTIMAXA, MULTIMAXB		
accessories for	402049		
	Part No.	401564	Ref. No. —
heat-conducting foil L 62mm W 45mm for solid state relay			

transformers

encapsulated transformers

multiple connections

			
1			
Part No.	402051	Ref. No.	742775 E310031 EL0742775 ELE310031
description	transformer primary 230VAC secondary 16.5VAC 2x15VA connection male faston 50/60Hz		
For models:	1011, 1221, 2011, 2021, 611, AUTOCLEAN, GENIUS, GENIUS6-11, GENIUS6-11GAS, GENIUSGAS, JOKERB, JOKERC, MD2011, MULTIMAXB, MULTIMAXB6-11AUTOCLEAN		

electronic controllers

miscellaneous

universal controllers

			
1			
Part No.	400206	Ref. No.	332143 E0432 E336010 EL0332143 ELE336010
description	electronic controller 230V TempIn1 thermocouple K (NiCr-Ni) temperature controller		
For models:	MD1011, MD2011, MD523, MD611, MMD2011, MMD2021		

probes

producer-specific probes

			
1			
Part No.	379087	Ref. No.	E0436 E316004 EL0570621 ELE316004 ELO570621
description	temperature probe thermocouple K (NiCr-Ni) cable silicone probe -50 up to 1150°C cable -50 up to +180°C connection male faston 2.8mm thread probe ø1x30mm cable length 1.6m		
For models:	1011, 1221, 2011, 2021, 611, AUTOCLEAN, GENIUS, GENIUS6-11, GENIUS6-11GAS, GENIUSGAS, JOKERB, JOKERC, MD2011, MMD2021, MULTIMAXA, MULTIMAXB, WU14		

core probes

			
1			
Part No.	378358	Ref. No.	747017 EL0747017
description	core temperature probe		



1 			
Part No.	379592 ¹	Ref. No.	752363 E316024 EL0752363 ELE316024
description	core temperature probe 3 point probe cable PTFE probe -40 up to +250°C cable -40 up to +250°C connection 5-wire probe ø4x100mm thread cable length 4.5m handle ø 12mm handle length 85mm		
For models:	1011, 1221, 2011, 2021, 611, AUTOCLEAN, GENIUS, GENIUS6-11, GENIUS6-11GAS, GENIUSGAS, MAKT, MB, MULTIMAXA, MULTIMAXB		

¹ multipoint probe

2 			
Part No.	379692	Ref. No.	783668 E316026 EL0783668 ELE316026
description	core temperature probe Pt100 cable PTFE probe -40 up to +250°C cable -40 up to +250°C connection 2-wire probe ø4x82mm thread 1/4" cable length 1.8m handle ø 12mm handle length 90mm		

electronics

PCBs

1 			
Part No.	402619	Ref. No.	742465 E340053 EL0742465 ELE340053
description	keypad PCB combi-steamer 1121/2021 L 350mm W 121mm with display		
For models:	1011, 1221, 2011, 2021, 611, AUTOCLEAN, GENIUS, MB, MULTIMAXB, MULTIMAXB6-11AUTOCLEAN		

solenoid valves

solenoid valves (water)

INTERELEKTRIK

medium temperature: 90°C 90°C 60°C
 ambient temperature: 60°C 25°C 60°C
 duty cycle: 40% 100% 100%

1 			
Part No.	370688	Ref. No.	754463 EL0754463
description	solenoid valve 220-240VAC inlet 3/4" outlet 13.5mm DN8 t.max. 90°C plastic		
For models:	1011, 1221, 2011, 2021, 611, GENIUS, MAKT, MB		

metal			
MÜLLER			
2-way			
1 			
Part No.	370069 ¹	Ref. No.	024775 374806 436004 436007 436033 436039 436040 754471 E0153 E0157 E436004 E436007 E436033 E436039 EL0024775 EL0374806 EL0436040 EL0754471 ELE436004 ELE436007 ELE436033 ELE436039
description	solenoid valve 2-ways 230VAC inlet 1/8" IT outlet 1/8" IT L 30mm water MÜLLER DN10		
For models:	1011, 1221, 2011, 2021, 611, AUTOCLEAN, EB30, EB30XLDIGITAL, EBM3e-McDonalds, EBM5, EDC6-11, ELH101, ELH51, ELH53, ELH61, GENIUS, GENIUSGAS, MAKT, MB, MD1011, MD2011, MD523, MD611, MMC1011, MMC1011G, MMC2011, MMC2021, MMC611, MMD1011, MMD1011G, MMD2011, MMD2021, MMD611, MULTIMAXB		

¹with adjusting screw

pressure switches

for combi-steamers

1 			
Part No.	541526	Ref. No.	772305 784028 E320083 EL0784028 ELE320083
description	pressure control p max 0.5bar pressure connection 1/8"		
For models:	1011, 1221, 2011, 2021, 611, AUTOCLEAN, GENIUS, GENIUS6-11, GENIUS6-11GAS, GENIUSGAS, MAKT, MB, MULTIMAXB		





fans

axial fans

import



1

Part No.	601080 ¹	Ref. No.	693456 E390024 EL0693456 ELE390024
description	axial fan L 119mm W 119mm H 38mm 230VAC 50/60Hz 23/20W bearing ball bearing connection male faston 2.8mm metal ADDA fan wheel ø 110mm temp.-resist. 70°C		
For models:	1011, 2011, 611, EB30, EB30XLDIGITAL, GENIUS, JOKERB, JOKERC, MAKT, MB		
accessories for	601080		
	Part No.	550898	Ref. No. —
	connecting cable cable length 2000mm connection F 2.8 connection distance 7.9mm for axial flow fan		
	Part No.	692519	Ref. No. —
	guard L 120mm W 120mm plastic		

¹with ball bearings

cross flow fans

COPREL

with standard coil



1

Part No.	601032	Ref. No.	573469 E390023 EL0573469 ELE390023
description	cross flow fan COPREL TFL(FN) roller ø 60mm roller length 180mm laminated core thickness 15mm motor position left 230V/50Hz 19W bearing rubber connection male faston 6.3mm coil type airflow 107m ³ /h -10 up to +60°C refrigeration		
For models:	1221, 2011, AUTOCLEAN, GENIUS, GENIUSGAS, MULTIMAXA, MULTIMAXB		

hot air motors

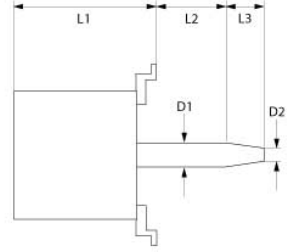

1

Part No.	500102	Ref. No.	332410 E390019 EL0332410 ELE390019 M0155
description	fan motor 230-240V 1 phase 50Hz 0.09kW 1390rpm speeds 1 L1 150mm L2 32mm L3 27mm ø 125mm M10R IT 1.1A suitable capacitor 4µF/400V power input 200W at 50Hz 1390rpm type L7yzw4B-207 no. X5 D1 ø 17mm D2 ø 14mm		
For models:	MD1011, MD611, MMD1011, MMD611		

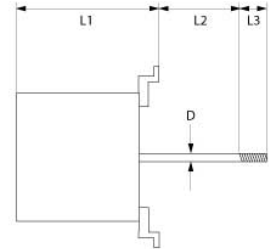

1

Part No.	601474	Ref. No.	693286 E390033 EL0693286 ELE390033
description	fan motor 230V 1 phase 50/60Hz 0.03kW 3600rpm speeds 1 L1 115mm L2 20mm L3 32mm ø 12mm shaft flat length 23mm 7.5/8 0.35/0.56A suitable capacitor 3µF400V power input 75/125W at 50Hz 3600rpm type L5ow2B-317 no. W9		
For models:	EB30, EB30XLDIGITAL, JOKERB, JOKERC		
accessories for	601474		
	Part No.	602166	Ref. No. 0693375 E392020 EL0693375 ELE392020
	fan wheel blades 9 D1 ø 175mm D2 ø 8mm D3 ø 8mm H1 30mm H2 28mm ED 6-23		

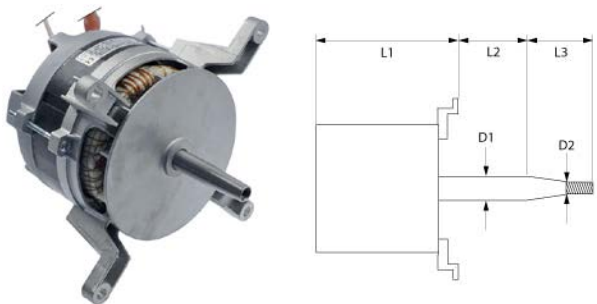

	
1	
Part No.	601864
Ref. No.	509846 ELO509846
description	fan motor 380-415V 3 phase 50Hz 0.21kW 700/1400rpm speeds 2 L1 160mm L2 25mm L3 40mm D1 ø 17mm D2 ø 13mm M10R IT at 50Hz 700/1400rpm type 3081DH4052

pumps

vibration pumps

	
1	
Part No.	499010
Ref. No.	501313 772550 E434022 ELO501313 ELO772550 ELE434022
description	vibration pump type E512/B46 230V 60W 50/60Hz inlet ø 7 outlet ø 1/8" IT CEME L 125mm
For models:	1011, 1221, 2011, 2021, 611, AUTOCLEAN, GENIUS, GENIUS6-11, GENIUS6-11GAS, GENIUSGAS, MB, MULTIMAXA, MULTIMAXB

fuses

fine fuses

	
1	
Part No.	358532
Ref. No.	190756 E0173 E375007 ELO190756 ELE375007
description	fine fuse size ø5x20mm 2A fast-acting rated 250V Qty 10 pcs
For models:	1011, 1221, 2011, 2021, 611, AUTOCLEAN, GENIUS, GENIUS6-11, GENIUS6-11GAS, GENIUSGAS, JOKERC, MAKT, MB, MD1011, MD2011, MD611, MMD1011, MMD2011, MMD2021, MMD611, MULTIMAXA, MULTIMAXB

	
1	
Part No.	358699
Ref. No.	572047 E0168 E375004 ELO572047 ELE375004
description	fine fuse size ø5x20mm 10A medium lag rated 250V Qty 10 pcs
For models:	JOKERC, MD2011, MMD1011, MMD2011, MMD2021, MMD611, WU14

	
1	
Part No.	358608
Ref. No.	EL0578975
description	fine fuse size ø5x20mm 10A slow-acting rated 250V Qty 10 pcs

screw locks

D0-system (NEOZED)

	
1	
Part No.	358045
Ref. No.	751863 E0970 E375013 ELO751863 ELE375013
description	fuse size D02 35A rated 250/400V E18 ø 15mm L 36mm Qty 10 pcs
For models:	2011, AUTOCLEAN, GENIUS, MAKT, MB, MD2011, MMD2011, MMD2021, MULTIMAXA, MULTIMAXB

electric accessories

terminals

rail-mounted terminals

WIELAND

accessories

	
1	
Part No.	550337
Ref. No.	327514 E0346 E371009 ELO327514 ELE371009
description	end barrier for fuse terminal clampsmm ²
For models:	1011, 1221, 2011, 2021, 611, AUTOCLEAN, EB30, EB30XLDIGITAL, GENIUS, GENIUS6-11, GENIUS6-11GAS, GENIUSGAS, JOKERC, JOKERB, MAKT, MB, MD1011, MD2011, MD611, MMD2011, MMD2021, MULTIMAXA, MULTIMAXB, MULTIMAXB6-11AUTOCLEAN, WU14





gas valves and ignition boxes

gas control valves

HONEYWELL



1

Part No.	106206	Ref. No.	744050 E434020 EL0744050 ELE434020
description	gas valve type VK4115V 220-240V 50/60Hz gas inlet flange 32x32mm gas outlet flange 32x32mm thermocouple connection pilot connection pressure range 15-60mbar max 60mbar operator type HONEYWELL flange 32x32mm		
For models:	1011, 1221, 2011, 2021, 611, AUTOCLEAN, GENIUS, GENIUS6-11GAS, GENIUSGAS		
accessories for	106206		
	Part No.	102845	Ref. No. —
	gas connection angled 1/2" flange 32x32mm hole distance 24x24mm Tandem		
	Part No.	102846	Ref. No. —
	gas connection straight 1/2" flange 32x32mm hole distance 24x24mm suitable for Tandem		

ignition parts

electrodes



1

Part No.	106996	Ref. No.	874787 EL0874787
description	ignition electrode flange length 60mm flange width 22mm D1 ø 9mm L1 17mm L2 45mm L3 6mm L4 34/10mm BL1 37mm BL2 32mm cable length 350mm connection ø 4mm		
For models:	1011, 2011, 611, GENIUS		
accessories for	106996		
	Part No.	699472	Ref. No. 0507495 0507997 0874833 EL0507495 EL0507997 EL0874833
	gasket ignition electrode ID ø 13mm hole ø 6mm L 60mm W 22mm suitable for ELOMA graphite		



1

Part No.	106997	Ref. No.	874906 EL0874906
description	monitoring electrode connection ø F6.3mm flange length 23mm flange width 16mm D1 ø 7mm L1 60mm L2 44mm L4 12mm L3 60mm BL1 35mm BL2 25mm connection F6.3x0.8 cable length 450mm fixing dimensions ø5mm		
For models:	1011, 2011, 611, GENIUS		



equipment-specific units

for convection ovens/combi-steamers

drip water trays

			
1			
Part No.	699270	Ref. No.	0781185 EL0781185
description	spring L 65mm W 32.5mm H 28mm		

door mechanics

locking mechanism

			
1			
Part No.	692716	Ref. No.	588504 980080 E380093 EL0588504 EL0980080 ELE380093
description	door catch with switch L 140mm W 25mm H 63mm hole distance 120mm ID ø 12mm		



vibration pumps



			
1			
Part No.	499010	Ref. No.	501313 772550 E434022 EL0501313 EL0772550 ELE434022
description	vibration pump type E512/B46 230V 60W 50/60Hz inlet ø 7 outlet ø 1/8" IT CEME L 125mm		
For models:	1011, 1221, 2011, 2021, 611, AUTOCLEAN, GENIUS, GENIUS6-11, GENIUS6-11GAS, GENIUSGAS, MAKT, MB, MULTIMAXA, MULTIMAXB		

knobs

producer-specific knobs

ELOMA

			
1			
Part No.	111498	Ref. No.	743690 E365086 EL0743690 ELE365086
description	knob t.max.°C ø 48mm shaft ø 6.5mm shaft flat blue		
For models:	1011, 1221, 2011, 2021, 611, AUTOCLEAN, GENIUS, MAKT, MB, MULTIMAXA, MULTIMAXB, MULTIMAXB6-11AUTOCLEAN		
accessories for	111498		
			
Part No.	111510	Ref. No.	748781 E365087 EL0748781 ELE365087
lid t.max.°C ø 37mm shaft ømm shaft flat silver for knob ELOMA			

			
1			
Part No.	111510	Ref. No.	748781 E365087 EL0748781 ELE365087
description	lid t.max.°C ø 37mm shaft ømm shaft flat silver for knob ELOMA		
For models:	1011, 1221, 2011, 2021, 611, AUTOCLEAN, GENIUS, GENIUS6-11, GENIUS6-11GAS, GENIUSGAS, MAKT, MB, MULTIMAXA, MULTIMAXB, MULTIMAXB6-11AUTOCLEAN		
accessories for	111510		
			
Part No.	111498	Ref. No.	743690 E365086 EL0743690 ELE365086
knob t.max.°C ø 48mm shaft ø 6.5mm shaft flat blue			



accessories

covers





Part No.	111510	Ref. No.	748781 E365087 EL0748781 ELE365087
description	lid t.max.°C°C ø 37mm shaft ømm shaft flat silver for knob ELOMA		
For models:	1011, 1221, 2011, 2021, 611, AUTOCLEAN, GENIUS, GENIUS6-11, GENIUS6-11GAS, GENIUSGAS, MAKT, MB, MULTIMAXA, MULTIMAXB, MULTIMAXB6-11AUTOCLEAN		
accessories for	111510		
	Part No.	111498	Ref. No. 743690 E365086 EL0743690 ELE365086
knob t.max.°C°C ø 48mm shaft ø 6.5mm shaft flat blue			

edgmount latches

handle latches

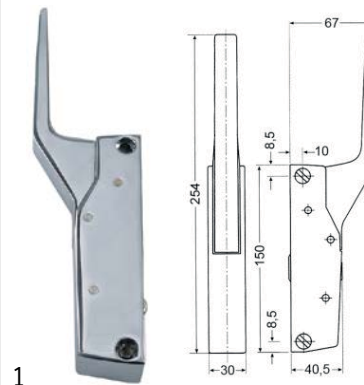
CAFF/FERMOD



Part No.	700060	Ref. No.	377732 E380010 EL0377732 ELE380010 H0195
description	handle latch L 150mm mounting distance 133mm non lockable heated units G 791		
For models:	MD1011, MD523, MD611, MMD1011, MMD611		
accessories for	700060		
	Part No.	700061	Ref. No. 382825 382833 E380011 E380012 E598001 EL0382825 ELE380012 ELE598001 H0196 H0197 V0603
door catch L 58mm W 20mm H 35mm mounting distance 42mm chrome-plated brass for headed units			
	Part No.	700062	Ref. No. 292532 E407029 EL0292532 ELE407029 K0443
handle protection heated units			



locks

handle latches

producer-specific

ELOMA



Part No.	691990	Ref. No.	748765 E365091 EL0748765 ELE365091
description	door handle hinged at right L 155mm W 60mm H 58mm spring length 53mm blue mounting distance 40mm mounting thread M4		
For models:	1011, 611, AUTOCLEAN, GENIUS, GENIUS6-11, GENIUS6-11GAS, GENIUSGAS, MAKT, MB, MULTIMAXA, MULTIMAXB		
spare parts for	691990		
	Part No.	514450	Ref. No. 791504 EL0791504
spring for door handle ø 6mm L 61mm W 27.5mm			
accessories for	691990		
	Part No.	111510	Ref. No. 748781 E365087 EL0748781 ELE365087
lid t.max.°C°C ø 37mm shaft ømm shaft flat silver for knob ELOMA			

DERBY RUOTE

spare parts and accessories

miscellaneous



Part No.	560193	Ref. No.	0349771 EL0349771
description	tooth lock washer ID ø 10.4mm ED ø 18mm zinc-coated steel DIN/ISO DIN 6798A Qty 1 pcs for thread M10		



gaskets

gaskets for heated units

window seals

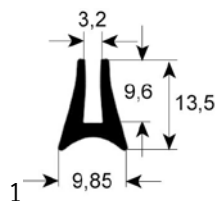

Part No.	900110	Ref. No.	215961 E425041 EL0215961 ELE425041 H0515
description	window gasket profile 1590 Qty supplied by meter		
For models:	MD1011, MD2011, MD611, MMD1011, MMD2011, MMD2021, MMD611		

door seals

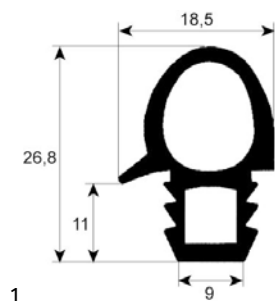

Part No.	900100	Ref. No.	384410 425030 E425030 EL0384410 ELE425030 H0497
description	door seal profile 2070 W 460mm L 645mm external size Qty 1 6 x 1/1		

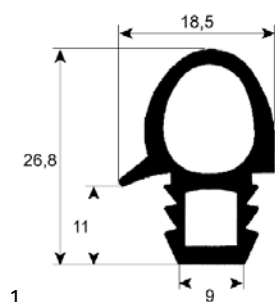

Part No.	900101	Ref. No.	382310 E425033 EL0382310 ELE425033 H0502
description	door seal profile 2070 W 645mm L 700mm external size Qty 1 10 x 1/1		

Part No.	900204	Ref. No.	E425056 ELE425056
description	door seal profile 2448 W 710mm L 1470mm external size Qty 1		

Part No.	900865	Ref. No.	742368 E425198 EL0742368 ELE425198
description	door seal profile 2449 W 490mm L 520mm Qty 1		
For models:	611, GENIUS, GENIUS6-11, GENIUS6-11GAS, MAKT, MB, MULTIMAXB6-11AUTOCLEAN		

Part No.	901483	Ref. No.	742384 E425200 EL0742384 EL2000214 ELE425200
description	door seal profile 2449 W 520mm L 1505mm Qty 1		
For models:	2011, GENIUS, MAKT, MB		

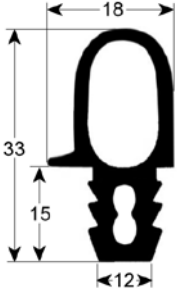

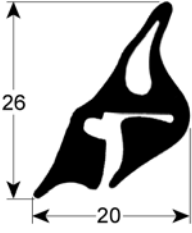

Part No.	900497	Ref. No.	742376 E425199 EL0742376 ELE425199
description	door seal profile 2449 W 520mm L 775mm Qty 1		
For models:	1011, GENIUS, MAKT, MB		

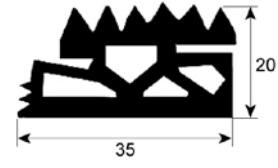

Part No.	900498	Ref. No.	425121 425166 693219 E425166 EL0693219 ELE425166
description	door seal profile 2515 perimeter 1670mm Qty 1		
For models:	EDB 6-23, JOKERB, JOKERC		

gaskets for tray rack trolleys



Part No.	900199	Ref. No.	549207 E425062 EL0549207 ELE425062
description	tray rack trolley gasket profile 4070 L 1000mm Qty 1		
For models:	1011, 1221, 2011, 2021, 611, GENIUS, MAKT, MB		

O-rings

Viton



Part No.	510579	Ref. No.	581410 E425066 EL0581410 ELE425066
description	O-ring Viton thickness 2.62mm ID ø 34.6mm Qty 1 pcs		
For models:	1011, 1221, 2011, 2021, 611, AUTOCLEAN, GENIUS, GENIUS6-11, GENIUS6-11GAS, GENIUSGAS, MAKT, MB, MULTIMAXA, MULTIMAXB		

springs

torsion springs



Part No.	692523	Ref. No.	897531 E416055 E416073 EL0897531 ELE416055 ELE416073
description	torsion spring ø 27.8mm ID ø 21.7mm L2 44mm wire gauge ø 3mm L1 13mm L3 44mm Qty 1 pcs		
For models:	1221, 2021, AUTOCLEAN, GENIUS, MB, MULTIMAXB		

hose reels and spray guns

spray guns



Part No.	540301	Ref. No.	587583 E250059 EL0587583 EL0783404 ELE250059
description	spray gun for appliances 1/2" ET L 128mm		
For models:	1011, 1221, 2011, 2021, 611, AUTOCLEAN, GENIUS, GENIUS6-11, GENIUS6-11GAS, GENIUSGAS, JOKERB, JOKERC, MAKT, MB, MULTIMAXA, MULTIMAXB, MULTIMAXB6-11AUTOCLEAN		



hoses

industrial hoses

nylon hoses



1			
Part No.	520252	Ref. No.	785857 EL0785857
description	nylon hose ID ø 6mm ED ø 8mm L 5m thickness 1mm operating p. 10bar burst p. 50bar t.max. 100°C white		
For models:	1011, 1221, 2011, 2021, 611, GENIUS, MAKT, MB		

silicone hoses

with fabric

with glass fibre sleeving

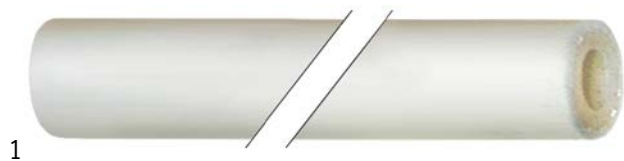

1			
Part No.	520024	Ref. No.	253847 593303 E444013 E444050 EL0253847 EL0593303 ELE444013 ELE444050 K0432
description	silicone hose with glass fibre sleeving ID ø 9.5mm ED ø 17mm L 5m thickness 3.75mm operating p. 4bar burst pressure at 95°C 26bar burst pressure 130°C 14bar t.max. 200°C white		
For models:	1011, 1221, 2011, 2021, 611, AUTOCLEAN, GENIUS, GENIUS6-11, GENIUS6-11GAS, GENIUSGAS, MAKT, MB, MD1011, MD2011, MD523, MD611, MMD1011, MMD2011, MMD2021, MMD611, MULTIMAXA, MULTIMAXB, WU14		

fastening material

screws

grub screws

DIN 916/ISO 4029



1			
Part No.	560173	Ref. No.	
description	grub screw thread M4 L 10mm SS DIN 916/ISO 4029 intake internal hexagon WS 2 Qty 20 pcs		
For models:	1011, 1221, 2011, 2021, 611, AUTOCLEAN, GENIUS, GENIUS6-11, GENIUS6-11GAS, GENIUSGAS, JOKERB, JOKERC, MAKT, MB, MD2011, MMD2011, MMD2021, MULTIMAXA, MULTIMAXB		

nuts

hexagonal nuts

DIN 934 / ISO 4032/8673



1			
Part No.	560340	Ref. No.	003905
description	hexagonal nut thread M4 H 3.2mm WS 7 SS DIN/ISO DIN 934 / ISO 4032/8673 Qty 1 pcs		
For models:	1011, 1221, 2011, 2021, 611, EB30, EB30XLDIGITAL, GENIUS, MAKT, MB		

washers

tooth lock washers

DIN 6798A



1			
Part No.	560193	Ref. No.	0349771 EL0349771
description	tooth lock washer ID ø 10.4mm ED ø 18mm zinc-coated steel DIN/ISO DIN 6798A Qty 1 pcs for thread M10		

consumables

fuses

fine fuses





1			
Part No.	358532	Ref. No.	190756 E0173 E375007 EL0190756 ELE375007
description	fine fuse size ø5x20mm 2A fast-acting rated 250V Qty 10 pcs		
For models:	1011, 1221, 2011, 2021, 611, AUTOCLEAN, GENIUS, GENIUS6-11, GENIUS6-11GAS, GENIUSGAS, JOKERC, MAKT, MB, MD1011, MD2011, MD611, MMD1011, MMD2011, MMD2021, MMD611, MULTIMAXA, MULTIMAXB		



1			
Part No.	358699	Ref. No.	572047 E0168 E375004 EL0572047 ELE375004
description	fine fuse size ø5x20mm 10A medium lag rated 250V Qty 10 pcs		
For models:	JOKERC, MD2011, MMD1011, MMD2011, MMD2021, MMD611, WU14		



			
1			
Part No.	358608	Ref. No.	EL0578975
description	fine fuse size ø5x20mm 10A slow-acting rated 250V Qty 10 pcs		

screw locks			
D0-system (NEOZED)			
			
1			
Part No.	358045	Ref. No.	751863 E0970 E375013 EL0751863 ELE375013
description	fuse size D02 35A rated 250/400V E18 ø 15mm L 36mm Qty 10 pcs		
For models:	2011, AUTOCLEAN, GENIUS, MAKT, MB, MD2011, MMD2011, MMD2021, MULTIMAXA, MULTIMAXB		

GASTROPARTS.COM



© 2020 Gastroparts Sp. J. All rights reserved.