



**GASTROPARTS**

# Coven

**[EN]** Cooking

**[DE]** Kochtechnik

**[ES]** Cocción

**[FR]** Cuisson

**[IT]** Cottura

**[PL]** Obróbka termiczna

**[RU]** Термическая обработка

✉ [gastroparts@gastroparts.com](mailto:gastroparts@gastroparts.com)

☎ tel. +48 56 657 00 66

📘 [fb.com/gastroparts.global](https://fb.com/gastroparts.global)

**GASTROPARTS.COM**





## heating elements

## heating elements for convection



1

<b>Part No.</b>	417288	<b>Ref. No.</b>	EMRSB160
<b>description</b>	heating element 1600W		



1

<b>Part No.</b>	418986	<b>Ref. No.</b>	EMRSB030
<b>description</b>	heating element 3000W 240V heating circuits 1 ID $\varnothing$ 180mm ED $\varnothing$ 186mm L 210mm H 31mm L1 11mm W1 60mm H1 7mm H2 24.5mm flange length 100mm flange width 22mm hole distance 86mm connection male faston 6.3mm connection length 34.5mm tube $\varnothing$ 6.25mm convection heating element hole $\varnothing$ 5mm rectangular flange		



1

<b>Part No.</b>	418972	<b>Ref. No.</b>	EMRSB033 EMRSB38333
<b>description</b>	heating element 3300W 240V heating circuits 1 ID $\varnothing$ 178mm ED $\varnothing$ 190mm L 205mm H 34mm L1 10mm W1 59mm H1 11mm H2 23mm flange length 100mm flange width 21mm hole distance 86mm connection male faston 6.3mm connection length 34mm tube $\varnothing$ 6.3mm convection heating element		

## energy regulators

## EGO

## 1-circuit



1

<b>Part No.</b>	380015	<b>Ref. No.</b>	EMPUAH00
<b>description</b>	energy regulator 230V 13A single-circuit turn direction right shaft $\varnothing$ 6x4.6mm shaft L 23mm mounting thread M4 power release 6-100% no. 50.57021.010		

## thermostats

## control and safety thermostats

## EGO

## control thermostats

## 55.10/19\_ series



1

<b>Part No.</b>	375860	<b>Ref. No.</b>	EMTS0300
<b>description</b>	thermostat t.max. 289°C temperature range 57-289°C 1-pole 1NO 16A probe $\varnothing$ 3.1mm probe L 226mm capillary pipe 1780mm capillary pipe isolated 1770mm gland nut shaft $\varnothing$ 6x4.6mm shaft L 23mm shaft position upper° rotation 270° probe material SS		



1

<b>Part No.</b>	375654	<b>Ref. No.</b>	EMTS55ME
<b>description</b>	thermostat t.max. 99°C temperature range fixed 99°C 1-pole 1CO 16A probe $\varnothing$ 6mm probe L 74mm capillary pipe 900mm capillary pipe isolated 900mm gland nut		



safety thermostats

55.10/19\_ series

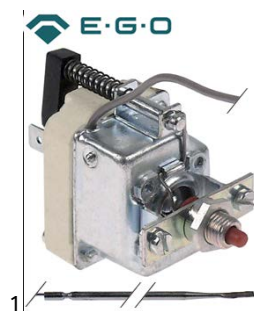

<b>Part No.</b>	375857	<b>Ref. No.</b>	EMTSS350
<b>description</b>	safety thermostat switch-off temp. 350°C 1-pole 16A probe ø 3.1mm probe L 201mm capillary pipe 870mm capillary pipe isolated 870mm gland nut probe SS		

switches and momentary switches

push/momentary push switches

miscellaneous



<b>Part No.</b>	347501	<b>Ref. No.</b>	EMDEVMOL
<b>description</b>	push switch black 2CO 250V 16A connection male faston 6.3mm ambient temperature max. 85°C protection IP40		

microswitches

pin-plunger actuated

M10



<b>Part No.</b>	346078	<b>Ref. No.</b>	EMMS1600
<b>description</b>	microswitch with plunger thread M10x0.75 250V 16A 1CO connection screw		

cam switches

on/off



<b>Part No.</b>	300129	<b>Ref. No.</b>	EMIG1600
<b>description</b>	cam switch 2 operating positions 2NO sequence 0-1 16A shaft ø 6x4.6mm shaft L 23mm connection male faston 6.3mm ceramic		

4 operating positions



<b>Part No.</b>	300236	<b>Ref. No.</b>	EMIGSLMX
<b>description</b>	cam switch 25/32A shaft ø 6x4.6mm shaft L 23mm 3-pole		

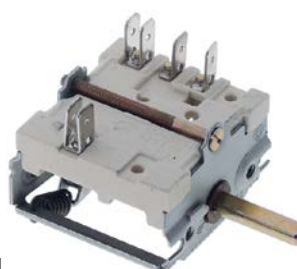

<b>Part No.</b>	347500	<b>Ref. No.</b>	EMIGSUMX
<b>description</b>	cam switch shaft ø 6x4.6mm shaft L 23mm connection male faston 6.3mm		

lamps

indicator lights

indicator lights (complete)

ø12mm

with screw socket



<b>Part No.</b>	359027	<b>Ref. No.</b>	EMLSAHRO
<b>description</b>	indicator light ø 12mm 250V green connection male faston 6.3mm		



## screw-on/push-on fit

## light bulbs

## for ovens



1

<b>Part No.</b>	359610	<b>Ref. No.</b>	EMPLLAHO
<b>description</b>	light bulb t.max. 300°C socket E14 15W 230V ø 22mm L 47mm lens L 20mm for oven lamp type Philips		



1

<b>Part No.</b>	359612	<b>Ref. No.</b>	EMPLLO25
<b>description</b>	light bulb t.max. 300°C socket E14 25W 230V ø 25mm L 56mm lens L 30mm for oven lamp type Philips		

## halogen lamp

## for socket G4 / G6.35 / G9



1

<b>Part No.</b>	359945	<b>Ref. No.</b>	EMPLAL25
<b>description</b>	halogen lamp socket G9 230V 25W temp.-resist. 300°C		

## oven lamps

## universal oven lamps

## mounting diameter 35.5mm



1

<b>Part No.</b>	357170	<b>Ref. No.</b>	EMPLP042
<b>description</b>	oven lamp mounting ø 35.5mm 230V 25W socket G9 temp.-resist. 300°C connection F6.3		



1

<b>Part No.</b>	359709	<b>Ref. No.</b>	EMPLG042
<b>description</b>	oven lamp glass thr.ø 33.5mm ø 42mm hard glas temp.-resist. 350°C		



1

<b>Part No.</b>	359705	<b>Ref. No.</b>	EMPLG800	
<b>description</b>	oven lamp glass thr.ø 33.5mm ø 52mm hard glas temp.-resist. 350°C			
<b>accessories for</b>	359705			
	<b>Part No.</b>	359610	<b>Ref. No.</b>	EMPLLAHO
	light bulb t.max. 300°C socket E14 15W 230V ø 22mm L 47mm lens L 20mm for oven lamp type Philips			
	<b>Part No.</b>	359700	<b>Ref. No.</b>	—
	gasket for pizza oven fibre glass ID ø 32.5mm ED ø 55mm thickness 5mm			
	<b>Part No.</b>	359721	<b>Ref. No.</b>	—
	gasket silicone ED ø 48mm ID ø 39.5mm thickness 5mm Qty 1 pcs			
	<b>Part No.</b>	359837	<b>Ref. No.</b>	—
	gasket ID ø 33mm ED ø 46mm thickness 1mm graphite			
	<b>Part No.</b>	359838	<b>Ref. No.</b>	—
	gasket ID ø 33mm ED ø 45mm			

## 55x70mm



1

<b>Part No.</b>	359297	<b>Ref. No.</b>	EMPLQU25B	
<b>description</b>	frame L 95mm W 81mm mounting distance 68/83mm thickness 6mm			
<b>accessories for</b>	359297			
	<b>Part No.</b>	359299	<b>Ref. No.</b>	—
	gasket L 91mm W 77mm hole ø 3mm for oven lamp			

## lamps

## light bulbs



1

<b>Part No.</b>	359610	<b>Ref. No.</b>	EMPLLAHO
<b>description</b>	light bulb t.max. 300°C socket E14 15W 230V ø 22mm L 47mm lens L 20mm for oven lamp type Philips		



<b>PHILIPS</b>			
			
1			
<b>Part No.</b>	359612	<b>Ref. No.</b>	EMPLL025
<b>description</b>	light bulb t.max. 300°C socket E14 25W 230V ø 25mm L 56mm lens L 30mm for oven lamp type Philips		

halogen lamps			
for socket G4 / G6.35 / G9			
			
1			
<b>Part No.</b>	359945	<b>Ref. No.</b>	EMPLAL25
<b>description</b>	halogen lamp socket G9 230V 25W temp.-resist. 300°C		

## timers

programme timers			
			
1			
<b>Part No.</b>	360492	<b>Ref. No.</b>	EMC6003 F33245 EMC6003 F3324S
<b>description</b>	timer CDC 6003F engines 1 chambers 3 operation time 324s 230V shaft ø 5mm shaft L 9mm motor type M48L ATS		

mechanical timers			
			
1			
<b>Part No.</b>	350022	<b>Ref. No.</b>	EMFTC120
<b>description</b>	timer M2 2-pole operation time 120min impulse mechanical 2CO at 250V 16A permanent position yes shaft ø 6x4.6mm shaft 6x4.6mm shaft L 23mm mounting distance 28mm connection lateral		
<b>accessories for</b>	350022		
	<b>Part No.</b>	110366	<b>Ref. No.</b> —
	knob switch zero mark t.max. °C ø 44mm shaft ø 6x4.6mm shaft flat top upper black		
	<b>Part No.</b>	110381	<b>Ref. No.</b> —
	dial plate graduation 120min permanent position yes rotation 0-300° ø 60mm timers knob ø 45mm with permanent position		

## alarm devices

buzzer boards			
			
1			
<b>Part No.</b>	350146	<b>Ref. No.</b>	EMFTES07
<b>description</b>	buzzer board connection male faston 4.8mm		

## contactors

SIEMENS			
power contactors			
			
1			
<b>Part No.</b>	380652	<b>Ref. No.</b>	EMCNAH25
<b>description</b>	power contactor resistive load 22A 230VAC (AC3/400V) 9A/4kW main contacts 3NO auxiliary contacts 1NC connection screw connection type 3RT10-16-1AP02		

			
1			
<b>Part No.</b>	380389	<b>Ref. No.</b>	EMCN1H25
<b>description</b>	power contactor resistive load 22A 230VAC (AC3/400V) 9A/4kW main contacts 3NO auxiliary contacts 1NO connection screw connection type 3RT10-16-1AP01		

auxiliary contacts			
			
1			
<b>Part No.</b>	380947	<b>Ref. No.</b>	EMCNAHA4 EMCNAHAU
<b>description</b>	auxiliary contact contacts 1NO/1NC AC15 3A for contactors 3RT102 3 RT103 connection screw connection type 3RH1921-1FA11		



1

<b>Part No.</b>	380533	<b>Ref. No.</b>	EMCNAAHUM
<b>description</b>	auxiliary contact contacts 3NO/1NC AC15 3A for contactors 3RT101 connection screw connection type 3RT1911-1FA31 resistive load 10A AC-12 10A		

## relays

## relay sockets



1

<b>Part No.</b>	380958	<b>Ref. No.</b>	EMRGLZX4
<b>description</b>	relay socket 8-pole connection plug-in connection round 8-pole 250V voltage AC 10A		



1

<b>Part No.</b>	380137	<b>Ref. No.</b>	EMRGLZX4
<b>description</b>	relay socket 8-pole connection plug-in connection round 8-pole dimensions 65x28x40mm 380V voltage AC 10A Italiana Relè manuf. no. ZVE8		
<b>accessories for</b>	380137		
	<b>Part No.</b>	380805	<b>Ref. No.</b> —
	support bracket		

## level relays

## miscellaneous



1

<b>Part No.</b>	402994	<b>Ref. No.</b>	EMRGLVX4
<b>description</b>	level controller 50/60Hz 8-pole 230V voltage AC 16A type RL30/1S/8		
<b>accessories for</b>	402994		
	<b>Part No.</b>	380958	<b>Ref. No.</b> EMRGLZX4
	relay socket 8-pole connection plug-in connection round 8-pole 250V voltage AC 10A		

## electronic controllers

## TECNOLOGIC

## universal controllers

## built-in version



1

<b>Part No.</b>	379486	<b>Ref. No.</b>	EMRESCO4
<b>description</b>	electronic controller TECNOLOGIC type TLK38FCR---- mounting measurements 71x29mm 12V voltage AC/DC Pt100/TC (J,K) relay outputs 1 CO-16A(8) Pt100/TC (J,K) built-in depth 64mm defr. funct. no dependent on probe°C display 4 digits		

## keypads

## front foils



1

<b>Part No.</b>	403015	<b>Ref. No.</b>	CFRPC10X
<b>description</b>	keypad foil L 167mm W 99mm		

## solenoid valves

## solenoid valves (water)

## ROBERTSHAW/INVENSYS

medium temperature:	90°C	90°C	60°C
ambient temperature:	60°C	25°C	60°C
duty cycle:	40%	100%	100%





1

<b>Part No.</b>	372015	<b>Ref. No.</b>	EMUAASRPE
<b>description</b>	solenoid valve single angled 230VAC inlet 3/4" outlet 11.5mm input 10l/min DN10 EATON (INVENSYS) flow regulating valve inlet white		





TP			
			
			
1			
<b>Part No.</b>	370025	<b>Ref. No.</b>	EMUA3C04
<b>description</b>	solenoid valve triple straight 230VAC inlet 3/4" outlet 11.5mm DN10 TP		
<b>spare parts for</b>	370025		
	<b>Part No.</b>	371013	<b>Ref. No.</b> —
	solenoid coil TP 230VAC 50/60Hz		
<b>accessories for</b>	370025		
	<b>Part No.</b>	371220	<b>Ref. No.</b> —
	reducer TP flow rate 3l/min red tolerance ±15%		
	<b>Part No.</b>	371221	<b>Ref. No.</b> —
	reducer TP flow rate 5.5l/min yellow tolerance ±15%		
	<b>Part No.</b>	371222	<b>Ref. No.</b> —
	reducer TP flow rate 6l/min grey tolerance ±15%		
	<b>Part No.</b>	371223	<b>Ref. No.</b> —
	reducer TP flow rate 10l/min white tolerance ±15%		
	<b>Part No.</b>	371224	<b>Ref. No.</b> —
	reducer TP flow rate 12l/min bronze tolerance ±15%		
	<b>Part No.</b>	371225	<b>Ref. No.</b> —
	reducer TP flow rate 16l/min light brown tolerance ±15%		
	<b>Part No.</b>	371226	<b>Ref. No.</b> —
	reducer TP flow rate 20l/min red tolerance ±15%		
	<b>Part No.</b>	371230	<b>Ref. No.</b> —
	reducer TP flow rate 0.25l/min red tolerance ±25%		
	<b>Part No.</b>	371231	<b>Ref. No.</b> —
	reducer TP flow rate 0.35l/min violet tolerance ±25%		
	<b>Part No.</b>	371232	<b>Ref. No.</b> —
	reducer TP flow rate 0.5l/min orange tolerance ±25%		
	<b>Part No.</b>	371233	<b>Ref. No.</b> —
	reducer TP flow rate 0.8l/min white tolerance ±25%		
	<b>Part No.</b>	371234	<b>Ref. No.</b> —
	reducer TP flow rate 1l/min light blue tolerance ±25%		
	<b>Part No.</b>	371235	<b>Ref. No.</b> —
	reducer TP flow rate 1.2l/min brown tolerance ±25%		
	<b>Part No.</b>	371236	<b>Ref. No.</b> —
	reducer TP flow rate 1.5l/min light brown tolerance ±25%		
	<b>Part No.</b>	371237	<b>Ref. No.</b> —
	reducer TP flow rate 2.5l/min yellow tolerance ±25%		

accessories for 370025			
	<b>Part No.</b>	371238	<b>Ref. No.</b> —
	reducer TP flow rate 3.4l/min dark green tolerance ±25%		
	<b>Part No.</b>	371239	<b>Ref. No.</b> —
	reducer TP flow rate 5l/min black tolerance ±25%		
	<b>Part No.</b>	371240	<b>Ref. No.</b> —
	reducer TP flow rate 8l/min blue tolerance ±20%		



solenoid valves with reducers			
			
1			
<b>Part No.</b>	370437	<b>Ref. No.</b>	EMUA2RPE
<b>description</b>	solenoid valve double angled 230VAC inlet 3/4" input 10l/min output 1.2/1.2l/min DN10 t.max. 90°C TP plastic flow regulating valve inlet white outlet 11.5mm output A 1.2l/min output B 1.2l/min flow regulating valve outlet A dark brown flow regulating valve outlet B dark brown		

			
1			
<b>Part No.</b>	370644	<b>Ref. No.</b>	EMUA2C180
<b>description</b>	solenoid valve double straight 220-240VAC inlet 3/4" input 10l/min DN10 TP flow regulating valve inlet white outlet 11.5mm output A 1.5l/min output B 1.5l/min flow regulating valve outlet A brown flow regulating valve outlet B brown		

## fans

### axial fans

#### import

			
1			
<b>Part No.</b>	601080 <sup>1</sup>	<b>Ref. No.</b>	EMMOAS10
<b>description</b>	axial fan L 119mm W 119mm H 38mm 230VAC 50/60Hz 23/20W bearing ball bearing connection male faston 2.8mm metal ADDA fan wheel ø 110mm temp.-resist. 70°C		
<b>accessories for</b>	601080		
	<b>Part No.</b>	550898	<b>Ref. No.</b> —
	connecting cable cable length 2000mm connection F 2.8 connection distance 7.9mm for axial flow fan		

<sup>1</sup>with ball bearings  
Table continues overleaf



accessories for	601080			
	Part No.	692519	Ref. No.	—
	guard L 120mm W 120mm plastic			





Part No.	601081 <sup>1</sup>	Ref. No.	EMMOAS6	
description	axial fan L 80mm W 80mm H 38mm 230VAC 50/60Hz 14/13.5W bearing ball bearing connection male faston 2.8mm metal ADDA fan wheel ø 75mm temp.-resist. 70°C			
accessories for	601081			
	Part No.	691102	Ref. No.	—
	guard ø 75mm mounting distance 71mm for axial fan 80mm			

<sup>1</sup>with ball bearings

## hot air fans

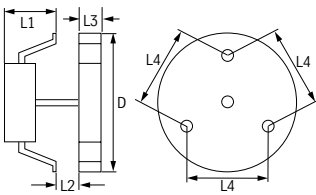
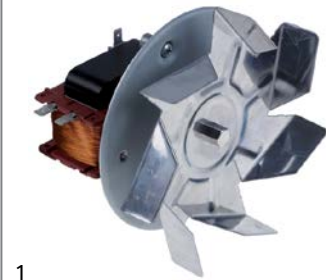
### miscellaneous



Part No.	601011	Ref. No.	EMMVR150	
description	hot air fan 220-240V 40W 50/60Hz L1 65mm L2 15mm L3 25mm L4 87mm fan wheel ø 150mm FIME type C25R8023CLH			
accessories for	601011			
	Part No.	550879	Ref. No.	—
	insulation ø 130mm thickness 3mm hole ø 18mm for hot air fan			
	Part No.	601260	Ref. No.	—
	nut thread M6L IT for hot air fan			

## pumps

### drain pumps

#### ASKOLL



Part No.	500346	Ref. No.	MCPOMPAMX
description	drain pump inlet ø 30mm outlet ø 22mm 230V 40W 50Hz ASKOLL type M231 XP with holder		

## electric accessories

### terminals

#### connection terminals with screw/faston connections



Part No.	550278	Ref. No.	EMMR1102
description	power terminal block 3-pole max. 40A max 400V connection ø6mm <sup>2</sup> / F6.3 temp.-resist. 150°C cross section 6mm <sup>2</sup>		



Part No.	550411	Ref. No.	EMMR1224
description	power terminal block 6-pole max. 40A max 450V connection ø6mm <sup>2</sup> / F6.3 temp.-resist. 150°C cross section 6mm <sup>2</sup>		





## gas valves and ignition boxes







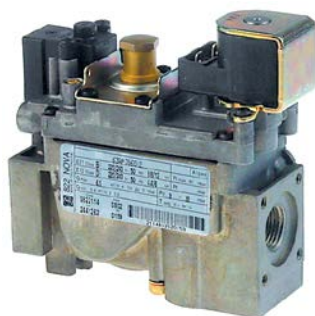

### gas control valves

SIT

NOVASIT



1

<b>Part No.</b>	101914	<b>Ref. No.</b>	EMSIT822N
<b>description</b>	gas valve SIT series Novasit 822 230V 50Hz gas inlet 1/2" gas outlet 1/2" thermocouple connection pilot connection closed ignition pressure range 3-30mbar pressure regulator connection blind equiv. no. 0.822.144		
<b>spare parts for</b>	101914		
	<b>Part No.</b>	101313	<b>Ref. No.</b> —
	solenoid coil 230V 50Hz		
	<b>Part No.</b>	101542	<b>Ref. No.</b> —
	solenoid coil 50Hz NOVA 822/826/827 suitable for NOVASIT 230V		
<b>accessories for</b>	101914		
	<b>Part No.</b>	101305	<b>Ref. No.</b> —
	gas connection straight 1/2" flange 45x45mm ELETROSIT/V4400/4600/4605 suitable for SIT/HONEYWELL hole distance 36x36mm		
	<b>Part No.</b>	101306	<b>Ref. No.</b> —
	gas connection angled flange 45x45mm hole distance 36x36mm 1/2" ELETROSIT/V4400/4600/4605 screw with O-ring suitable for SIT/HONEYWELL		
	<b>Part No.</b>	101307	<b>Ref. No.</b> —
	gas connection straight flange 45x45mm hole distance 36x36mm 3/4" ELETROSIT/V4400/4600/4605 screw with O-ring suitable for SIT/HONEYWELL		
	<b>Part No.</b>	101308	<b>Ref. No.</b> —
	gas connection angled flange 45x45mm hole distance 36x36mm 3/4" ELETROSIT/V4400/4600/4605 screw with O-ring suitable for SIT/HONEYWELL		
	<b>Part No.</b>	101503	<b>Ref. No.</b> —
	O-ring EPDM thickness 2mm ID ø 32mm Qty 1 pcs		
	<b>Part No.</b>	101924	<b>Ref. No.</b> —
	plug with cable L 1090mm suitable for NOVA 822/826/827		

## ignition boxes

BRAHMA



1

<b>Part No.</b>	107471	<b>Ref. No.</b>	EMCONFIN6G
<b>description</b>	ignition box BRAHMA type CM11 electrodes 2 waiting time 1.5s safety time 10s 230V 7VA 50-60Hz		

## ignition parts

### pilot burners

SIT

100 series



1











<b>Part No.</b>	106906	<b>Ref. No.</b>	EMSITBPO
<b>description</b>	pilot burner SIT type 100 series 3 flames nozzle ø 0.2mm gas connection 6mm		
<b>spare parts for</b>	106906		
	<b>Part No.</b>	100245	<b>Ref. No.</b> —
	pilot burner nozzle LPG code 20 bore ø 0.2mm Qty 1 pcs thread M8x0.75		
	<b>Part No.</b>	100855	<b>Ref. No.</b> —
	pilot burner bracket triple		
	<b>Part No.</b>	100885	<b>Ref. No.</b> —
	air mixing sleeve for pilot burner Qty 1 pcs		
	<b>Part No.</b>	100916	<b>Ref. No.</b> —
	compression spring for pilot burner Qty 1 pcs		
	<b>Part No.</b>	100917	<b>Ref. No.</b> —
	gasket for pilot burner Qty 1 pcs aluminium		
	<b>Part No.</b>	100918	<b>Ref. No.</b> —
	screw for pilot burner		
	<b>Part No.</b>	107162	<b>Ref. No.</b> —
	pilot burner cap SIT 3 flames Hmm Lmm Qty 1 pcs		
	<b>Part No.</b>	107701	<b>Ref. No.</b> —
	pilot burner bottom part SIT 100 series nozzle ø 0.2mm		
<b>accessories for</b>	106906		
	<b>Part No.</b>	100245	<b>Ref. No.</b> —
	pilot burner nozzle LPG code 20 bore ø 0.2mm Qty 1 pcs thread M8x0.75		

Table continues overleaf



accessories for 106906		Part No.	Ref. No.	
	pilot burner nozzle natural gas bore $\varnothing$ 0.35mm Qty 1 pcs thread M8x0.75	100246	—	—
	locking screw M10x1 for pipe $\varnothing$ 4mm Qty 1 pcs	100904	—	—
	locking screw M10x1 for pipe $\varnothing$ 6mm Qty 1 pcs	100905	—	—
	pilot tube copper pipe $\varnothing$ 4mm thickness 1mm L 3000mm	102110	—	—
	pilot tube copper pipe $\varnothing$ 6mm thickness 1mm L 3000mm	102111	—	—
	pilot burner nozzle SIT natural/liquid gas bore $\varnothing$ 0.25mm Qty 1 pcs	107171	—	—
	pilot burner bottom part SIT 100 series nozzle $\varnothing$ 0.25mm	107700	—	—
	pilot burner bottom part SIT 100 series nozzle $\varnothing$ 0.35mm	107702	—	—

accessories

ignition electrodes

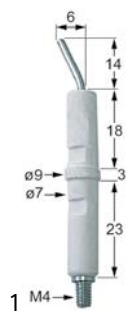

Part No.	Ref. No.	EMSITCA0
100706	—	—
description ignition electrode connection M4 Qty 1 pcs		

electrodes

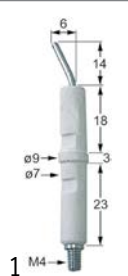

Part No.	Ref. No.	EMSITCA0
100706	—	—
description ignition electrode connection M4 Qty 1 pcs		

ignition units



Part No.	Ref. No.	EMACA000
102485	—	—
description ignition unit outputs 2 220-240VAC 0.6VA 50-60Hz		



Part No.	Ref. No.	EMACA000
101002	—	—
description ignition unit outputs 2 230VAC dimensions 88x23x34mm mounting distance 73mm inlet F6.3x0.8 outlet F2.8x0.8 0.6VA 50/60Hz		

thermocouples

plug-in thermocouples

plug-in thermocouples standard

with barrel socket  $\varnothing$ 6(6.5)mm

thermocouples SIT

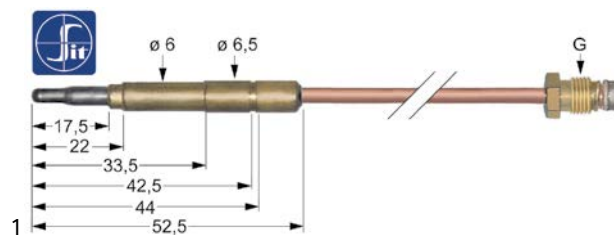

Part No.	Ref. No.	EMSITT150 EMSITT20
107614	—	—
description thermocouple SIT M9x1 L 1500mm plug connection $\varnothing$ 6.0(6.5)mm		

glass panels



Part No.	Ref. No.	MCVE0002
694560	—	—
description glass panel L 388mm W 310mm thickness 4mm Qty 1 pcs		



knobs

producer-specific knobs

COVEN



1

<b>Part No.</b>	111421	<b>Ref. No.</b>	MCMAOMOT
<b>description</b>	knob zero mark ø 48mm shaft ø 6x4.6mm shaft flat upper black		

locks

handle latches





universal

outside fixing

locks



1

<b>Part No.</b>	694065	<b>Ref. No.</b>	MCCHSAMX
<b>description</b>	door handle for headed units L 145mm W 40mm H 62mm spring length 33mm outer black		
<b>spare parts for</b>	694065		
	<b>Part No.</b>	514390	<b>Ref. No.</b> —
	spring for door handle ø 6mm L 54mm W 27.5mm		
	<b>Part No.</b>	694734	<b>Ref. No.</b> —
	door handle L 165mm W 40mm H 25mm black		
	<b>Part No.</b>	694735	<b>Ref. No.</b> —
	cap ø 32mm black		
<b>accessories for</b>	694065		
	<b>Part No.</b>	694066	<b>Ref. No.</b> —
	door catch with spigot 2-stage L 28mm W 14mm H 15mm H1 16mm total length 51mm thread M8 thread L 23mm stainless steel		
	<b>Part No.</b>	694067	<b>Ref. No.</b> MCCHAGMX
	door catch with spigot 1-stage L 26mm total length 51mm thread M8		

producer-specific

COVEN

group 1







1

<b>Part No.</b>	694850	<b>Ref. No.</b>	MCPR3AMX
<b>description</b>	door catch with spigot 2-stage L 28mm W 14mm H 15mm H1 16mm total length 52mm thread M8		



1

<b>Part No.</b>	694065	<b>Ref. No.</b>	MCCHSAMX
<b>description</b>	door handle for headed units L 145mm W 40mm H 62mm spring length 33mm outer black		
<b>spare parts for</b>	694065		
	<b>Part No.</b>	514390	<b>Ref. No.</b> —
	spring for door handle ø 6mm L 54mm W 27.5mm		
	<b>Part No.</b>	694734	<b>Ref. No.</b> —
	door handle L 165mm W 40mm H 25mm black		
	<b>Part No.</b>	694735	<b>Ref. No.</b> —
	cap ø 32mm black		
<b>accessories for</b>	694065		
	<b>Part No.</b>	694066	<b>Ref. No.</b> —
	door catch with spigot 2-stage L 28mm W 14mm H 15mm H1 16mm total length 51mm thread M8 thread L 23mm stainless steel		
	<b>Part No.</b>	694067	<b>Ref. No.</b> MCCHAGMX
	door catch with spigot 1-stage L 26mm total length 51mm thread M8		

group 2



1



<b>Part No.</b>	694480	<b>Ref. No.</b>	MCPR2AMX
<b>description</b>	door catch with spigot 2-stage type DL24 L 42mm W 12mm H 18mm total length 62mm thread M8x1.25 thread L 20mm chrome-plated		
<b>accessories for</b>	694480		
	<b>Part No.</b>	694475	<b>Ref. No.</b> MCCHSAMX/2
	door handle for headed units bright finish type 1625L L 160mm W 39mm H 65mm spring length 30mm inner black plastic mounting distance 25mm flange 42x76mm mounting thread M5		

Table continues overleaf





<b>accessories for</b>	694480		
	<b>Part No.</b>	694476	<b>Ref. No.</b> —
	door handle for headed units matt finish type 1625 L 160mm W 39mm H 65mm spring length 30mm inner black/chrome plastic mounting distance 25mm flange 42x76mm mounting thread M5		





<b>Part No.</b>	694475	<b>Ref. No.</b>	MCCHSAMX/2
<b>description</b>	door handle for headed units bright finish type 1625L L 160mm W 39mm H 65mm spring length 30mm inner black plastic mounting distance 25mm flange 42x76mm mounting thread M5		

**accessories for** 694475

	<b>Part No.</b>	694477	<b>Ref. No.</b> —
	door catch with spigot 1-stage type SL24 L 31.5mm W 12mm H 19.5mm total length 52mm thread M8x1.25 thread L 20.5mm chrome-plated		

	<b>Part No.</b>	694478	<b>Ref. No.</b> —
	door catch with spigot 1-stage type SL42 L 31.5mm W 12mm H 19.5mm total length 67.5mm thread M8x1.25 thread L 36mm chrome-plated		

	<b>Part No.</b>	694479	<b>Ref. No.</b> —
	door catch with spigot 1-stage type SL60 L 31.5mm W 12mm H 19.5mm total length 87mm thread M8x1.25 thread L 55.5mm chrome-plated		

	<b>Part No.</b>	694480	<b>Ref. No.</b> MCPR2AMX
	door catch with spigot 2-stage type DL24 L 42mm W 12mm H 18mm total length 62mm thread M8x1.25 thread L 20mm chrome-plated		

	<b>Part No.</b>	694481	<b>Ref. No.</b> —
	door catch with spigot 2-stage type DL42 L 42mm W 12mm H 18mm total length 78.5mm thread M8x1.25 thread L 36.5mm chrome-plated		

	<b>Part No.</b>	694482	<b>Ref. No.</b> —
	door catch with spigot 2-stage type DL60 L 42mm W 12mm H 18mm total length 98mm thread M8x1.25 thread L 56mm chrome-plated		

## edgemoount latches

### handle latches

#### CAFF/FERMOD

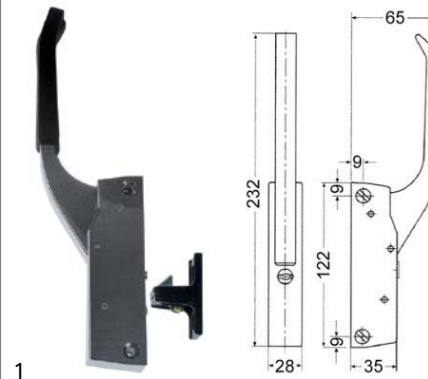

<b>Part No.</b>	700906	<b>Ref. No.</b>	MCCHIN04P
-----------------	--------	-----------------	-----------

**description** catch L 122mm mounting distance 104mm heated units

**spare parts for** 700906

	<b>Part No.</b>	690419	<b>Ref. No.</b> —
	door catch L 52mm W 20mm H 30mm mounting distance 26-37mm zamak for refrigeration units		

	<b>Part No.</b>	700062	<b>Ref. No.</b> —
	handle protection heated units		

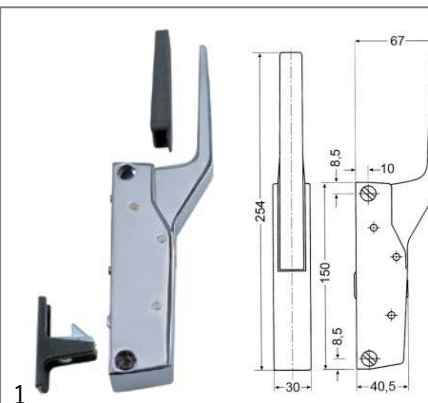

<b>Part No.</b>	701024	<b>Ref. No.</b>	MCCHIN04
-----------------	--------	-----------------	----------

**description** handle latch L 150mm mounting distance 133mm heated units type 790

**spare parts for** 701024

	<b>Part No.</b>	700061	<b>Ref. No.</b>	MCCHINA04 MCCHNA04
	door catch L 58mm W 20mm H 35mm mounting distance 42mm chrome-plated brass for headed units			

	<b>Part No.</b>	700062	<b>Ref. No.</b>	—
	handle protection heated units			



snap locks

universal



1

<b>Part No.</b>	690596	<b>Ref. No.</b>	MCCHPI00
<b>description</b>	snap lock L 60mm W 15mm H 36mm mounting distance 48/28mm spring thickness 1.5mm complete with door catch zamak		

espagnolette locks

universal



1

<b>Part No.</b>	690041	<b>Ref. No.</b>	MCCHME10
<b>description</b>	cam L 148mm mounting distance 32mm		

shelves and shelf rails

grid attachments



1

<b>Part No.</b>	689001	<b>Ref. No.</b>	MCPR0003
<b>description</b>	bearing rail L 325mm H 15mm mounting pos. cavity W 15mm stainless steel for COVEN delivery pair		

gaskets

gaskets for heated units

window seals

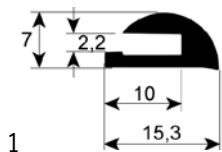

1

<b>Part No.</b>	901380	<b>Ref. No.</b>	MCGV0003
<b>description</b>	window gasket profile 1883 Qty supplied by meter		

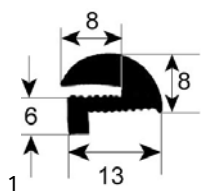

1

<b>Part No.</b>	900782	<b>Ref. No.</b>	MCGV0002
<b>description</b>	window gasket profile 1889 Qty supplied by meter		

door seals

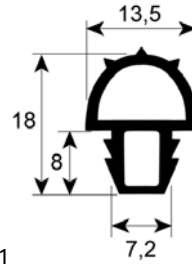

1

<b>Part No.</b>	901381	<b>Ref. No.</b>	MCGP3/4P
<b>description</b>	door seal profile 2045 Qty supplied by meter		

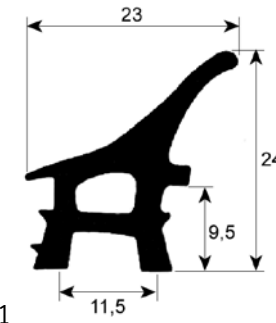

1

<b>Part No.</b>	900778	<b>Ref. No.</b>	MCGPN004 / 470mm
<b>description</b>	door seal profile 2403 L 470mm Qty 1 mounting pos. vertical		

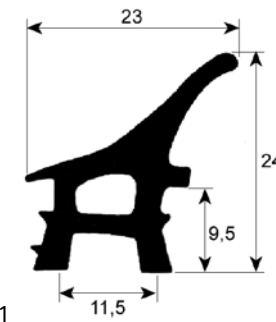

1

<b>Part No.</b>	901382	<b>Ref. No.</b>	MCGPN004 / 490mm
<b>description</b>	door seal profile 2403 L 490mm Qty 1 mounting pos. vertical		

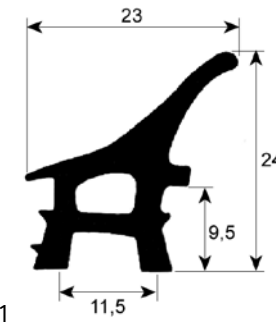

1

<b>Part No.</b>	900779	<b>Ref. No.</b>	MCGPN004 / 600mm
<b>description</b>	door seal profile 2403 L 600mm Qty 1 mounting pos. horizontal		

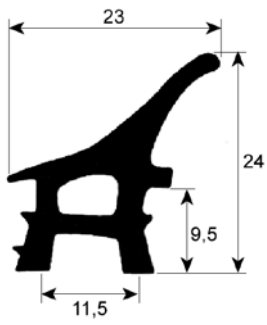

<b>Part No.</b>	901383	<b>Ref. No.</b>	MCGPN004 / 700mm
<b>description</b>	door seal profile 2403 L 700mm Qty 1 mounting pos. horizontal		

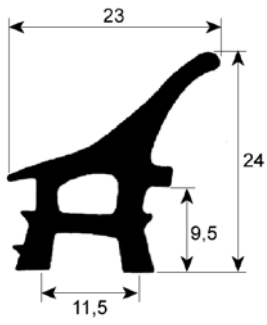

<b>Part No.</b>	900780	<b>Ref. No.</b>	MCGPN004 / 890mm
<b>description</b>	door seal profile 2403 L 890mm Qty 1		

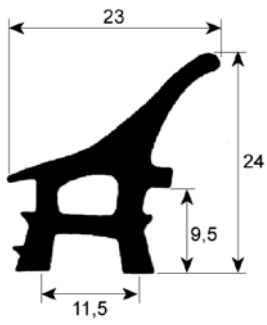

<b>Part No.</b>	900781	<b>Ref. No.</b>	MCGPN004
<b>description</b>	door seal profile 2403 Qty supplied by meter		

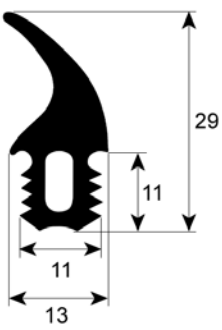

<b>Part No.</b>	901326	<b>Ref. No.</b>	GUARNIPORTA106 MCGFC06N
<b>description</b>	door seal profile 2785 Qty supplied by meter		

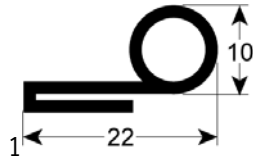

<b>Part No.</b>	901169	<b>Ref. No.</b>	MCGP0002
<b>description</b>	door seal profile 2948 Qty supplied by meter		

## consumables

### sealants and adhesives

#### high temperature silicone



<b>Part No.</b>	890266	<b>Ref. No.</b>	CSR60902
<b>description</b>	high temperature silicone COLLEX RED SILICONE t.max. -40 up to +250°C red tube 80ml		
<b>description</b>	COLLEX RED SILICONE - tube 80ml - red In-situ flat gaskets for transmissions, compressors, pumps, manifolds, etc. Sealing joints for lighting devices and caulking for electric passages. Good resistance to motor oils, water and coolants. Temperature range -40°C to +250°C.		



**GASTROPARTS.COM**



© 2020 Gastroparts Sp. J. All rights reserved.