



GASTROPARTS

Capic

[EN] Cooking

[DE] Kochtechnik

[ES] Cocción

[FR] Cuisson

[IT] Cottura

[PL] Obróbka termiczna

[RU] Термическая обработка

✉ gastroparts@gastroparts.com

☎ tel. +48 56 657 00 66

📘 fb.com/gastroparts.global

GASTROPARTS.COM





heating elements

heating elements for ovens



Part No.	418947	Ref. No.	E150596
description	heating element 1000W 230V heating circuits 1 L 400mm W 90mm thread M12x1 mounting distance 82mm tube ø 8mm connection M4 oven 2 hole fixing dry heating element		



Part No.	418847	Ref. No.	E150855
description	heating element 1500W 230V heating circuits 1 L 450mm W 60mm H 60mm connection distance 45mm tube ø 16mm dry heating element connection with screw connection length 28mm		



Part No.	418949	Ref. No.	E150846
description	heating element 1500W 230V heating circuits 1 L 580mm W 110mm thread M14x1.25 mounting distance 100mm tube ø 10mm connection M4 oven 2 hole fixing dry heating element		

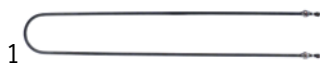

Part No.	418948	Ref. No.	E150852
description	heating element 1500W 230V heating circuits 1 L 730mm W 110mm thread M12x1 mounting distance 102mm tube ø 8mm connection M4 oven mounting pos. lower 2 hole fixing dry heating element		



Part No.	418952	Ref. No.	E150866
description	heating element 2000W 230V heating circuits 1 L 1300mm W 65mm thread M14x1 mounting distance 55mm tube ø 10mm connection M5 oven 2 hole fixing dry heating element		



Part No.	418950	Ref. No.	E150860
description	heating element 2000W 230V heating circuits 1 L 900mm W 115mm thread M14x1.25 mounting distance 105mm tube ø 10mm connection M4 oven 2 hole fixing dry heating element		



Part No.	418951	Ref. No.	E151107
description	heating element 2250W 230V heating circuits 1 L 700mm W 90mm thread M14x1.25 mounting distance 80mm tube ø 10mm connection M4 oven 2 hole fixing dry heating element		



Part No.	418953	Ref. No.	E151170
description	heating element 3000W 230V heating circuits 1 L 1295mm W 60mm thread M14x1.25 mounting distance 50mm tube ø 10mm connection M4 oven 2 hole fixing dry heating element		



Part No.	418954	Ref. No.	E151465
description	heating element 4000W 230V heating circuits 1 L 850mm W 105mm thread M14x1 mounting distance 95mm tube ø 10mm connection M4 oven 2 hole fixing dry heating element		



Part No.	418943	Ref. No.	E150515
description	heating element 500W 230V heating circuits 1 L 400mm W 110mm L1 45mm L2 355mm W1 31mm W2 40mm flange length 70mm flange width 22mm hole distance 56mm hole ø 6mm tube ø 6.5mm connection M4 connection length 26mm windings 2 rectangular flange dry heating element oven		



Part No.	418945	Ref. No.	E150514
description	heating element 500W 230V heating circuits 1 L 695mm thread M12x1 tube ø 8mm connection M4 oven 1 hole fixing dry heating element Wmm		

heating elements for heated cabinets



Part No.	418946	Ref. No.	E150532
description	heating element 700W 230V heating circuits 1 L 745mm W 110mm connection length 35mm connection M4 tube ø 8mm 2 hole fixing thread M12x1 dry heating element heated cabinet mounting distance 102mm		
For models:	W380648, W383045		

immersion heating elements

with round flange ø47.5mm



Part No.	418846	Ref. No.	E153010 E153010+E153011
description	heating element 4500W 230V heating circuits 3 L 395mm W 37mm H 30mm tube ø 6.5mm connection male faston 6.3mm connection length 25mm immersion heater round flange mounting ø 47.5mm		
For models:	W384111, W384112		
accessories for	418846		
	Part No.	510408	Ref. No. E153011
	O-ring EPDM thickness 5.34mm ID ø 47mm Qty 1 pcs		



heating elements for convection

Part No.	418956	Ref. No.	E151131
description	heating element 2700W 230V heating circuits 1 L 410mm W 130mm H 102mm H1 42mm H2 60mm thread M20x1.5 connection length 87mm connection M5 2 hole fixing tube ø 13.5mm convection heating element convection oven		

Part No.	418955	Ref. No.	E150824
description	heating element 1500W 230V heating circuits 1 L 393mm W 70mm connection length 28mm connection M4 tube ø 8mm thread M12x1 2 hole fixing convection heating element convection oven mounting distance 62mm		

accessories

sealing washers

O-rings

Part No.	510408	Ref. No.	E153011
description	O-ring EPDM thickness 5.34mm ID ø 47mm Qty 1 pcs		
For models:	W384111, W384112		

energy regulators

EGO

1-circuit

Part No.	380019	Ref. No.	E402540
description	energy regulator 240V 13A single-circuit turn direction right shaft ø 6x4.6mm shaft L 23mm mounting thread M4 power release 6-100% no. 50.57071.010		

thermostats

control and safety thermostats

EGO

control thermostats

55.10/19_ series

Part No.	375664	Ref. No.	E401082
description	thermostat t.max. 287°C temperature range 60-287°C 1-pole 1NO 16A probe ø 3.1mm probe L 226mm capillary pipe 1470mm capillary pipe isolated 350mm gland nut shaft ø 6x4.6mm shaft L 23mm shaft position upper rotation 270°		
For models:	W385013, W385015		

55.34_ series

Part No.	375143	Ref. No.	E401015
description	thermostat t.max. 110°C temperature range 32-110°C 3-pole 3NO 16A probe ø 6mm probe L 138mm capillary pipe 1480mm capillary pipe isolated 1100mm gland nut M9x1 shaft ø 6x4.6mm shaft L 23mm shaft position upper rotation 270°		
For models:	W380811, W380815, W380821, W380825, W380831, W380835, W381131, W381132		

safety thermostats

55.13_ series

Part No.	375830	Ref. No.	E401003
description	safety thermostat switch-off temp. 365°C 1-pole 1NC 16A probe ø 3mm probe L 160mm capillary pipe 1730mm capillary pipe isolated 1710mm gland nut probe		



55.32_ series



Part No.	375980	Ref. No.	E401008 E401012
description	safety thermostat switch-off temp. 130°C 3-pole 20A probe ø 6mm probe L 88mm capillary pipe 880mm capillary pipe isolatedmm gland nut probe		
For models:	W384111, W384112, W384121, W384122		

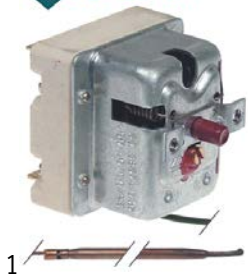

Part No.	375706	Ref. No.	E401090
description	safety thermostat switch-off temp. 400°C 3-pole 3NC 20A probe ø 3.9mm probe L 228mm capillary pipe 1190mm capillary pipe isolatedmm gland nut probe SS		
For models:	W380151, W380152, W380251, W380351, W380451, W380656, W382551, W382552, W382651, W382652, W383051, W385011, W385012, W385013, W385014, W385015		

control thermostats with operation switch

55.34_ series



Part No.	375246	Ref. No.	E401084
description	thermostat t.max. 645°C temperature range 100-615/645°C 2-pole 2NO 16A probe ø 4mm probe L 230mm capillary pipe 1100mm capillary pipe isolated 600mm gland nut shaft ø 6x4.6mm shaft L 25mm shaft position lower rotation 270° outer switch 2NO probe material copper		

accessories

gland nut accessories

ducts



Part No.	550148	Ref. No.	E401310
description	gland duct ET M12x0.75 IT M9x1 probe ø max. 6.5mm WS 17 silicone		

connecting bows



Part No.	550060	Ref. No.	E401320
description	connecting bow long for thermostat Qty 1 pcs		

switches and momentary switches

push/momentary push switches

ø12mm



Part No.	347567	Ref. No.	E053052
description	momentary push switch mounting ø 12mm white 1NO 250V 4A connection male faston 6.3mm ambient temperature max. 85°C protection IP40		
For models:	W381132		

microswitches

universal



Part No.	348043	Ref. No.	E053005
description	microswitch with plunger 250V 16A 1CO connection male faston 6.3mm Lmm L1 27.8mm ambient temperature max. 125°C mounting distance 22mm with lever set type MS1-16 actuating force: 100g white		



pin-plunger actuated

M12



Part No.	347586	Ref. No.	E053040
description	position switch with plunger mounting distance 81mm thread M12x1 thread L 66mm 400V 20A 1CO connection screw stroke 8mm L 50mm ambient temperature max. 85°C actuating force: 500g H 75mm W 18mm		

system switches (ROLD)



Part No.	345606	Ref. No.	L451243
description	momentary switch unit 2CO 250V 16A connection male faston 6.3mm		



Part No.	345651	Ref. No.	L451247
description	switch 2CO 250V 16A connection male faston 6.3mm		

cam switches

4-position



Part No.	300103	Ref. No.	E052520
description	cam switch 4 operating positions 1NO/2CO sequence 0-1-2-3 32A shaft \varnothing 6x4.6mm shaft L 23mm connection screw ceramic		
For models:	W380311, W380321, W380331, W380341, W380351, W380711, W380721, W380731, W380741, W380911, W380921, W380931, W380941		

5 operating positions

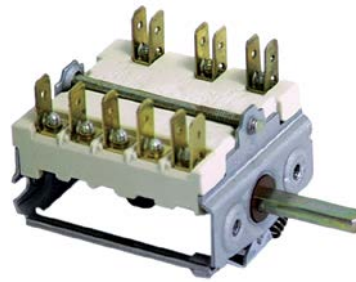

Part No.	301221	Ref. No.	E052535
description	cam switch 5 operating positions 2NO/1CO sequence 0-4-3-2-1 16A shaft \varnothing 6x4.6mm shaft L 23mm connection male faston 6.3mm ceramic		

operation switches



Part No.	300200	Ref. No.	E052584
description	operation switch 2 operating positions 2NO 16A sequence 0-1 shaft \varnothing 6x4.6mm shaft L 23mm connection male faston 6.3mm operation switch ceramic		

magnetic switches

accessories

magnets

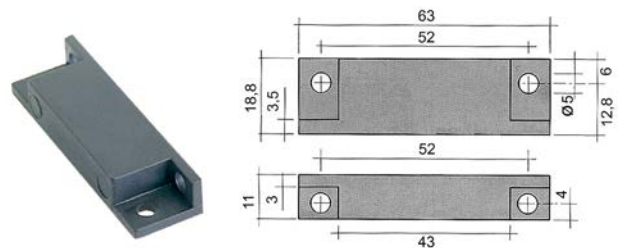

Part No.	345336	Ref. No.	L453222
description	magnet \varnothing 4.8mm L 63mm H 11mm W 18.8mm hole distance 51mm M4		



control equipment

SCHNEIDER ELECTRIC



1

Part No.	347808	Ref. No.	E052613 E052684
description	contact block TELEMECANIQUE ZB4BZ103 2NO max 600V 3A black with holder		
For models:	W380111, W380112, W380121, W380122, W380131, W380132, W380141, W380142, W380151, W380152, W380161, W380162, W380211, W380221, W380231, W380241, W380251, W380261, W380411, W380413, W380421, W380423, W380431, W380433, W380441, W380443, W380451, W380461, W380511, W380521, W380531, W380541, W380666, W380912, W380915, W380917, W380919, W380922, W380925, W380927, W380929, W380932, W380935, W380937, W380939, W380942, W380945, W380947, W380949, W381132...(Other models you can see in the webshop)		

TELEMECANIQUE (EFA)

XB2 series

signal element



1

Part No.	345397	Ref. No.	E202042
description	signal element mounting measurements ø22mm red		

lamps

indicator lights

indicator lights 2-piece (lens and indicator lamp)

indicator lamps for socket type SRZ / SDK / SDY / SFK



1

Part No.	359130	Ref. No.	L452515
description	indicator lamp 230V clear connection male faston 6.3mm ø 8mm		

indicator lights 3-piece (housing, lens and bulb)



lamps

neon light bulbs



1

Part No.	359600	Ref. No.	E201005	
description	neon light bulb socket E10 220V 0.35W clear ø 10mm L 28mm			
accessories for	359600			
	Part No.	359060	Ref. No.	—
	lamp socket mounting measurements ø16.2mm socket E10 connection screw			

accessories for	359600			
	Part No.	359063	Ref. No.	—
	lamp socket mounting measurements ø19.2mm socket E14 connection screw			
	Part No.	359064	Ref. No.	—
	lamp socket mounting measurements ø22.3mm socket E14 connection screw 250/380V ambient temperature at 1W 100°C ambient temperature at 2W 85°C			
	Part No.	359685	Ref. No.	—
	lamp socket mounting measurements ø16.2mm socket E10			
	Part No.	359832	Ref. No.	—
	lamp socket mounting measurements ø16.2mm socket Ba9s connection male faston 6.3mm			
	Part No.	359853	Ref. No.	—
	lamp socket mounting measurements ø18.2mm socket Ba9s connection male faston 6.3mm			
	Part No.	359988	Ref. No.	—
	lamp socket mounting measurements ø30.5mm 250V connection F6.3 temp.-resist. 55°C E14			

indicator lights (complete)

ø 6mm



1

Part No.	359038	Ref. No.	L452522
description	indicator light ø 6mm 230V red		

ø10mm

with plug-in socket



1

Part No.	359139	Ref. No.	E202025
description	indicator light ø 10mm green 230V connection male faston 6.3mm Qty 1 pcs		



1

Part No.	359140	Ref. No.	E202026
description	indicator light ø 10mm yellow 230V connection male faston 6.3mm Qty 1 pcs		

screw-on/push-on fit

neon light bulbs



1







Part No.	359600	Ref. No.	E201005	
description	neon light bulb socket E10 220V 0.35W clear ø 10mm L 28mm			
accessories for	359600			
	Part No.	359060	Ref. No.	—
	lamp socket mounting measurements ø16.2mm socket E10 connection screw			

Table continues overleaf



accessories for		359600	
	Part No.	359063	Ref. No. —
lamp socket mounting measurements ø19.2mm socket E14 connection screw			
	Part No.	359064	Ref. No. —
lamp socket mounting measurements ø22.3mm socket E14 connection screw 250/380V ambient temperature at 1W 100°C ambient temperature at 2W 85°C			
	Part No.	359685	Ref. No. —
lamp socket mounting measurements ø16.2mm socket E10			
	Part No.	359832	Ref. No. —
lamp socket mounting measurements ø16.2mm socket Ba9s connection male faston 6.3mm			
	Part No.	359853	Ref. No. —
lamp socket mounting measurements ø18.2mm socket Ba9s connection male faston 6.3mm			
	Part No.	359988	Ref. No. —
lamp socket mounting measurements ø30.5mm 250V connection F6.3 temp.-resist. 55°C E14			

light bulbs

for ovens

	PHILIPS		
1			
Part No.	359610	Ref. No.	359610
description	light bulb t.max. 300°C socket E14 15W 230V ø 22mm L 47mm lens L 20mm for oven lamp type Philips		



for indicator lights

			
1			
Part No.	360697	Ref. No.	E201001
description	light bulb t.max.°C socket E10 2W 28V ø 10mm L 28mm lens L 12mm Qty 1 pcs		

oven lamps

universal oven lamps





mounting diameter 35.5mm



			
1			
Part No.	359718	Ref. No.	E202055
description	oven lamp mounting ø 35.5mm 230V 15W socket E14 temp.-resist. 300°C connection male faston 6.3mm hard glas		
spare parts for	359718		
	Part No.	359701	Ref. No. —
lamp socket socket E14 220-230V mounting ø 35.5mm connection male faston 6.3mm 15W			

spare parts for		359718	
	Part No.	359740	Ref. No. —
light bulb t.max. 300°C socket E14 15W 230V ø 22mm L 48mm lens L 20mm for oven lamp IMPORT			

			
1			
Part No.	359709	Ref. No.	E202056
description	oven lamp glass thr.ø 33.5mm ø 42mm hard glas temp.-resist. 350°C		

55x70mm





			
1			
Part No.	357105	Ref. No.	E202046
description	lamp socket socket G9 250V mounting measurements 55x70mm connection male faston 6.3mm H 32mm		
accessories for	357105		
	Part No.	359297	Ref. No. E202049
frame L 95mm W 81mm mounting distance 68/83mm thickness 6mm			
	Part No.	359299	Ref. No. E202048
gasket L 91mm W 77mm hole ø 3mm for oven lamp			
	Part No.	359937	Ref. No. —
lamp glass L 80mm W 65mm mounting measurements 52x67mm			
	Part No.	359945	Ref. No. —
halogen lamp socket G9 230V 25W temp.-resist. 300°C			

			
1			
Part No.	359297	Ref. No.	E202049
description	frame L 95mm W 81mm mounting distance 68/83mm thickness 6mm		
accessories for	359297		
	Part No.	359299	Ref. No. E202048
gasket L 91mm W 77mm hole ø 3mm for oven lamp			

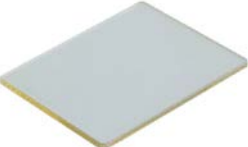

			
1			
Part No.	359299	Ref. No.	E202048
description	gasket L 91mm W 77mm hole ø 3mm for oven lamp		

			
1			
Part No.	359296	Ref. No.	E202047
description	lamp glass L 74mm W 58mm thickness 3mm		

			
1			
Part No.	357105	Ref. No.	E202046
description	lamp socket socket G9 250V mounting measurements 55x70mm connection male faston 6.3mm H 32mm		
accessories for	357105		
	Part No.	359297	Ref. No. E202049
	frame L 95mm W 81mm mounting distance 68/83mm thickness 6mm		
	Part No.	359299	Ref. No. E202048
	gasket L 91mm W 77mm hole ø 3mm for oven lamp		
	Part No.	359937	Ref. No. —
	lamp glass L 80mm W 65mm mounting measurements 52x67mm		
	Part No.	359945	Ref. No. —
	halogen lamp socket G9 230V 25W temp.-resist. 300°C		

lamps

light bulbs

			
1			
Part No.	359610	Ref. No.	359610
description	light bulb t.max. 300°C socket E14 15W 230V ø 22mm L 47mm lens L 20mm for oven lamp type Philips		

alarm devices

buzzers

			
1			
Part No.	350219	Ref. No.	E204042
description	buzzer 220VAC/DC connection male faston 6.3mm moulded built-in version thread M28x1dB mounting ø 42.5/32.5mm		

contactors

TELEMECANIQUE (Schneider Electric)

power contactors

			
1			
Part No.	380479	Ref. No.	E050903
description	power contactor resistive load 25A 230VAC (AC3/400V) 9A/4kW main contacts 3NO auxiliary contacts 1NO/1NC connection screw connection type LC1D09P7		
For models:	W381511, W381521, W381531, W381541, W381611, W381621, W381631, W381641, W381811, W381821, W381831, W385011, W385012		

			
1			
Part No.	380617	Ref. No.	E050901
description	power contactor resistive load 25A 24VAC (AC3/400V) 9A/4kW main contacts 3NO auxiliary contacts 1NO/1NC connection screw connection type LC1D09B7		

1

Part No.	381159	Ref. No.	E050904
description	power contactor resistive load 25A 400VAC (AC3/400V) 9A/4kW main contacts 3NO auxiliary contacts 1NO/1NC connection screw connection type LC1D09V7		
For models:	W380916, W380926, W380936, W380946, W381611, W381621, W381631, W381641		



1

Part No.	380976	Ref. No.	E050932
description	power contactor resistive load 32A 230VAC (AC3/400V) 18A/7.5kW main contacts 3NO auxiliary contacts 1NO/1NC connection screw connection		
For models:	W381031, W381131, W381132, W385013, W385014		



1

Part No.	380981	Ref. No.	E050869
description	power contactor resistive load 60A 230VAC (AC3/400V) 40A/18.5kW main contacts 3NO auxiliary contacts 1NO/1NC connection screw connection type LC1D40P7		

relays

power relays

with bracket mounting



1

Part No.	380139	Ref. No.	L451712
description	power relays FINDER 230VAC 16A 2CO connection F6.3 bracket mounting dimensions 68x38.2x35.8mm manuf. no. 62.82.8.230.0000		



1

Part No.	380808	Ref. No.	L451725
description	power relays FINDER 230VAC 16A 3CO connection male faston 6.3mm bracket mounting manuf. no. 62.83.8.230.0000		



1

Part No.	380185	Ref. No.	L451715
description	power relays Italiana Relè 230VAC 30A 1NO connection F6.3 bracket mounting dimensions 36.5x32.2x51.8mm manuf. no. A10-230AC-FA		

with male contacts

female contact 2.0mm

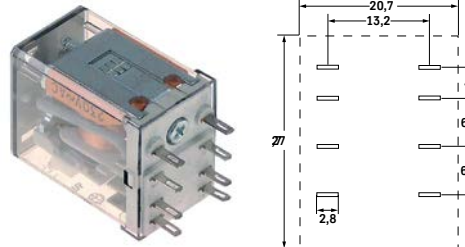

1





Part No.	380377	Ref. No.	E052347	
description	power relays FINDER 220-240VAC 10A 2CO connection F2 plug-in connection manuf. no. 55.32.8.230.0000 94.92.3 250V			
accessories for	380377			
	Part No.	380341	Ref. No.	—
		relay socket 4-pole contacts 12 300V voltage AC 6A Italiana Relè manuf. no. ZMD4		

Table continues overleaf



accessories for	380377			
	Part No.	380378	Ref. No.	—
	relay socket 2-pole 55/85 dimensions 70.5x30x27mm 250V voltage AC 10A FINDER manuf. no. 94.72			
	Part No.	380384	Ref. No.	—
	relay socket 2-pole contacts male faston 2.8mm 250V voltage AC 10A W 23mm for			
	Part No.	380399	Ref. No.	—
	relay socket 4-pole dimensions 76.2x27x86.1mm 250V voltage AC 1A FINDER manuf. no. 94.94.3			



electronic controllers

SERSA

	1		
Part No.	378545	Ref. No.	E403036
description	electronic controller type SSA 96 J2S D-270-24V mounting measurements 90x90mm 24V voltage AC Pt100 built-in depth 95mm up to +270°C display 3 digits		

probes

producer-specific probes

probes				
	1			
Part No.	381405	Ref. No.	E403525	
description	temperature probe Pt100 cable PTFE probe -200 up to +600°C connection 3-wire probe ø5x100mm cable length 2m			
	1			
Part No.	379635	Ref. No.	E403514	
description	temperature probe thermocouple J (Fe-CuNi) cable Vetrotex probe -50 up to +750°C cable -50 up to +350°C connection 2-wire thread probe ø5x100mm cable length 2m			
accessories for	379635			
	Part No.	379636	Ref. No.	G701005
	union screw set thread M8x1 probe ø 5mm			

electronics

PCBs

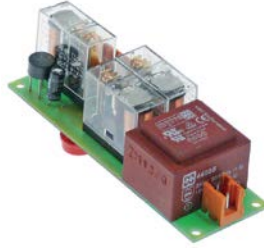
	1		
Part No.	403140	Ref. No.	E050561
description	keypad PCB combi-steamer AC 150- AC 220 L 104mm W 32mm buttons 3		

	1		
Part No.	403130	Ref. No.	E054059
description	PCB combi-steamer TVTS L 90mm W 70mm level control		
For models:	W384111, W384112, W384121, W384122		

solenoid valves

solenoid valves (water)























TP				
	1			
Part No.	370021	Ref. No.	L601005	
description	solenoid valve double straight 230VAC inlet 3/4" outlet 11.5mm DN10 TP flow regulating valve inlet white			
For models:	W381131, W381132			
spare parts for	370021			
	Part No.	371013	Ref. No.	—
	solenoid coil TP 230VAC 50/60Hz			
accessories for	370021			
	Part No.	371220	Ref. No.	—
	reducer TP flow rate 3l/min red tolerance ±15%			
	Part No.	371221	Ref. No.	—
	reducer TP flow rate 5.5l/min yellow tolerance ±15%			
	Part No.	371222	Ref. No.	—
	reducer TP flow rate 6l/min grey tolerance ±15%			

Table continues overleaf



accessories for		370021		
Part No.		371223	Ref. No.	—
	reducer	TP flow rate 10l/min	white tolerance ±15%	
	reducer	TP flow rate 12l/min	bronze tolerance ±15%	
	reducer	TP flow rate 16l/min	light brown tolerance ±15%	
	reducer	TP flow rate 20l/min	red tolerance ±15%	
	reducer	TP flow rate 0.25l/min	red tolerance ±25%	
	reducer	TP flow rate 0.35l/min	violet tolerance ±25%	
	reducer	TP flow rate 0.5l/min	orange tolerance ±25%	
	reducer	TP flow rate 0.8l/min	white tolerance ±25%	
	reducer	TP flow rate 1l/min	light blue tolerance ±25%	
	reducer	TP flow rate 1.2l/min	brown tolerance ±25%	
	reducer	TP flow rate 1.5l/min	light brown tolerance ±25%	
	reducer	TP flow rate 2.5l/min	yellow tolerance ±25%	
	reducer	TP flow rate 3.4l/min	dark green tolerance ±25%	
	reducer	TP flow rate 5l/min	black tolerance ±25%	
	reducer	TP flow rate 8l/min	blue tolerance ±20%	



accessories for		370017		
Part No.		371220	Ref. No.	—
	reducer	TP flow rate 3l/min	red tolerance ±15%	
	reducer	TP flow rate 5.5l/min	yellow tolerance ±15%	
	reducer	TP flow rate 6l/min	grey tolerance ±15%	
	reducer	TP flow rate 10l/min	white tolerance ±15%	
	reducer	TP flow rate 12l/min	bronze tolerance ±15%	
	reducer	TP flow rate 16l/min	light brown tolerance ±15%	
	reducer	TP flow rate 20l/min	red tolerance ±15%	
	reducer	TP flow rate 0.25l/min	red tolerance ±25%	
	reducer	TP flow rate 0.35l/min	violet tolerance ±25%	
	reducer	TP flow rate 0.5l/min	orange tolerance ±25%	
	reducer	TP flow rate 0.8l/min	white tolerance ±25%	
	reducer	TP flow rate 1l/min	light blue tolerance ±25%	
	reducer	TP flow rate 1.2l/min	brown tolerance ±25%	
	reducer	TP flow rate 1.5l/min	light brown tolerance ±25%	
	reducer	TP flow rate 2.5l/min	yellow tolerance ±25%	
	reducer	TP flow rate 3.4l/min	dark green tolerance ±25%	
	reducer	TP flow rate 5l/min	black tolerance ±25%	
	reducer	TP flow rate 8l/min	blue tolerance ±20%	

			
			
Part No.	370017	Ref. No.	L600505
description	solenoid valve single straight 230VAC inlet 3/4" outlet 11.5mm DN10 TP p max 10bar		
spare parts for	370017		
	Part No.	371013	Ref. No. —
	solenoid coil TP 230VAC 50/60Hz		



 			
Part No.	370025	Ref. No.	L601015
description	solenoid valve triple straight 230VAC inlet 3/4" outlet 11.5mm DN10 TP		
spare parts for	370025		
	Part No.	371013	Ref. No. —
	solenoid coil TP 230VAC 50/60Hz		
accessories for	370025		
	Part No.	371220	Ref. No. —
	reducer TP flow rate 3l/min red tolerance ±15%		
	Part No.	371221	Ref. No. —
	reducer TP flow rate 5.5l/min yellow tolerance ±15%		
	Part No.	371222	Ref. No. —
	reducer TP flow rate 6l/min grey tolerance ±15%		
	Part No.	371223	Ref. No. —
	reducer TP flow rate 10l/min white tolerance ±15%		
	Part No.	371224	Ref. No. —
	reducer TP flow rate 12l/min bronze tolerance ±15%		
	Part No.	371225	Ref. No. —
	reducer TP flow rate 16l/min light brown tolerance ±15%		
	Part No.	371226	Ref. No. —
	reducer TP flow rate 20l/min red tolerance ±15%		
	Part No.	371230	Ref. No. —
	reducer TP flow rate 0.25l/min red tolerance ±25%		
	Part No.	371231	Ref. No. —
	reducer TP flow rate 0.35l/min violet tolerance ±25%		
	Part No.	371232	Ref. No. —
	reducer TP flow rate 0.5l/min orange tolerance ±25%		
	Part No.	371233	Ref. No. —
	reducer TP flow rate 0.8l/min white tolerance ±25%		
	Part No.	371234	Ref. No. —
	reducer TP flow rate 1l/min light blue tolerance ±25%		
	Part No.	371235	Ref. No. —
	reducer TP flow rate 1.2l/min brown tolerance ±25%		
	Part No.	371236	Ref. No. —
	reducer TP flow rate 1.5l/min light brown tolerance ±25%		
	Part No.	371237	Ref. No. —
	reducer TP flow rate 2.5l/min yellow tolerance ±25%		

SOLENOID VALVES/ELECTRODES/FANS CAPIC

accessories for	370025		
	Part No.	371238	Ref. No. —
	reducer TP flow rate 3.4l/min dark green tolerance ±25%		
	Part No.	371239	Ref. No. —
	reducer TP flow rate 5l/min black tolerance ±25%		
	Part No.	371240	Ref. No. —
	reducer TP flow rate 8l/min blue tolerance ±20%		



electrodes

			
Part No.	403674	Ref. No.	E054062
description	level electrode threaded total length 120mm probe L 61mm insulated probe length 24mm ø 4mm		
For models:	W384111, W384112, W384121, W384122		

fans

axial fans

import

			
Part No.	601080 ¹	Ref. No.	E050571
description	axial fan L 119mm W 119mm H 38mm 230VAC 50/60Hz 23/20W bearing ball bearing connection male faston 2.8mm metal ADDA fan wheel ø 110mm temp.-resist. 70°C		
For models:	W381811, W381821, W381831		
accessories for	601080		
	Part No.	550898	Ref. No. —
	connecting cable cable length 2000mm connection F 2.8 connection distance 7.9mm for axial flow fan		
	Part No.	692519	Ref. No. —
	guard L 120mm W 120mm plastic		

¹with ball bearings



hot air motors



1

Part No.	601871	Ref. No.	13390026
description	fan motor 230V 1 phase 50Hz 85kW 2400rpm speeds 1 L1 85mm L2 40mm L3 33mm L4 133.5mm fan wheel ø 180mm at 50Hz 230V at 60Hz 230V at 50Hz 2600rpm at 60Hz 2850rpm type R2E180-AU01-09		

hot air fans

LEROY SOMER



1

Part No.	602081	Ref. No.	E254005
description	hot air fan 230/400V 250W 1.05/0.6A 2770rpm L1 115mm L2 95mm type 400870/003		

pumps

booster pumps II

accessories



1

Part No.	365017	Ref. No.	L452005
description	operating capacitor capacity 5µF 450V tolerance 5% 50/60Hz ambient temperature max. -25 to +85°C ø 28mm L 54mm M8 plastic connection male faston 6.3mm 16.10.08 protection		

condensators & interference suppression filters

operating capacitors

plastic



1

Part No.	365019	Ref. No.	L452027
description	operating capacitor capacity 20µF 400V tolerance 5% 50/60Hz ambient temperature max. -25 to +85°C ø 39.5mm L 70mm M8 plastic connection male faston 6.3mm 16.10.25. protection		



1

Part No.	365017	Ref. No.	L452005
description	operating capacitor capacity 5µF 450V tolerance 5% 50/60Hz ambient temperature max. -25 to +85°C ø 28mm L 54mm M8 plastic connection male faston 6.3mm 16.10.08 protection		

electric accessories

terminals

connection terminals with screw/faston connections



1

Part No.	550411	Ref. No.	L450310
description	power terminal block 6-pole max. 40A max 450V connection ø6mm ² / F6.3 temp.-resist. 150°C cross section 6mm ²		





gas thermostats

STN3R



1

Part No.	106209	Ref. No.	G652012
description	gas thermostat t.max. 300°C gas inlet 1/2" gas outlet 1/2" probe ø 6.5mm probe L 80mm capillary pipe 1200mm STN3R		
spare parts for	106209		
	Part No.	106211	Ref. No. G652220
	knob suitable for STN3R		
	Part No.	106212	Ref. No. G652221
	knob suitable for STN3R		

gas valves and ignition boxes





gas control valves





SIT

ELETTROSIT



1

Part No.	101127	Ref. No.	G652405
description	gas valve SIT type ELETTROSIT 230V gas inlet 3/4" gas outlet 3/4" thermocouple connection M9x1 pilot connection M10x1 lateral equiv. no. 0.810.175		
spare parts for	101127		
	Part No.	101312	Ref. No. —
	microswitch		
	Part No.	101352	Ref. No. —
	solenoid coil 230V 50Hz suitable for ELETTROSIT		
accessories for	101127		
	Part No.	100006	Ref. No. —
	piezoelectric igniter suitable for ELETTROSIT body plastic blowing connection ø2.4mm ø 14mm		
	Part No.	100904	Ref. No. —
	locking screw M10x1 for pipe ø 4mm Qty 1 pcs		

accessories for	101127		
	Part No.	100905	Ref. No. —
	locking screw M10x1 for pipe ø 6mm Qty 1 pcs		
	Part No.	101301	Ref. No. —
	gas connection thread 1/2" straight ELETTROSIT screw with O-ring		
	Part No.	101303	Ref. No. —
	gas connection straight thread 3/4" ELETTROSIT		
	Part No.	101309	Ref. No. —
	extension		

NOVASIT

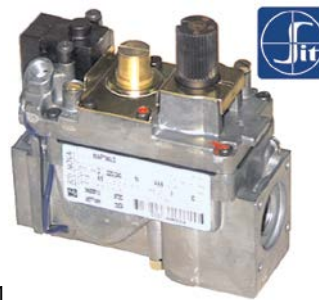

1



















Part No.	101162	Ref. No.	G653030
description	gas valve SIT series Novasit 820 230V 50Hz gas inlet 1/2" gas outlet 1/2" thermocouple connection M9x1 pilot connection M10x1 ignition pressure 3-5mbar pressure range 3-30mbar pressure regulator connection blind equiv. no. 0.820.010		
spare parts for	101162		
	Part No.	101065	Ref. No. —
	magnet unit with cable L 44mm D1 ø 30mm D2 ø 20mm suitable for NOVASIT		
	Part No.	101313	Ref. No. —
	solenoid coil 230V 50Hz		
accessories for	101162		
	Part No.	100006	Ref. No. —
	piezoelectric igniter suitable for ELETTROSIT body plastic blowing connection ø2.4mm ø 14mm		
	Part No.	101305	Ref. No. G653033
	gas connection straight 1/2" flange 45x45mm ELETTROSIT/V4400/4600/4605 suitable for SIT/HONEYWELL hole distance 36x36mm		
	Part No.	101306	Ref. No. G652031
	gas connection angled flange 45x45mm hole distance 36x36mm 1/2" ELETTROSIT/V4400/4600/4605 screw with O-ring suitable for SIT/HONEYWELL		
	Part No.	101307	Ref. No. —
	gas connection straight flange 45x45mm hole distance 36x36mm 3/4" ELETTROSIT/V4400/4600/4605 screw with O-ring suitable for SIT/HONEYWELL		
	Part No.	101308	Ref. No. G653032
	gas connection angled flange 45x45mm hole distance 36x36mm 3/4" ELETTROSIT/V4400/4600/4605 screw with O-ring suitable for SIT/HONEYWELL		
	Part No.	101312	Ref. No. —
	microswitch		



Table continues overleaf



accessories for		101162	
	Part No.	101314	Ref. No. —
	solenoid coil 24V 50Hz		
	Part No.	101317	Ref. No. G653035
	plug with cable L 1000mm suitable for NOVASIT		
	Part No.	101318	Ref. No. —
	cover cap for solenoid coil suitable for NOVASIT		



Part No.		Ref. No.	
1	101914	G653026	
description	gas valve SIT series Novasit 822 230V 50Hz gas inlet 1/2" gas outlet 1/2" thermocouple connection pilot connection closed ignition pressurebar pressure range 3-30mbar pressure regulator connection blind equiv. no. 0.822.144		
spare parts for	101914		
	Part No.	101313	Ref. No. —
	solenoid coil 230V 50Hz		
	Part No.	101542	Ref. No. —
	solenoid coil 50Hz NOVA 822/826/827 suitable for NOVASIT 230V		
accessories for	101914		
	Part No.	101305	Ref. No. G653033
	gas connection straight 1/2" flange 45x45mm ELETTROSIT/V4400/4600/4605 suitable for SIT/HONEYWELL hole distance 36x36mm		
	Part No.	101306	Ref. No. G652031
	gas connection angled flange 45x45mm hole distance 36x36mm 1/2" ELETTROSIT/V4400/4600/4605 screw with O-ring suitable for SIT/HONEYWELL		
	Part No.	101307	Ref. No. —
	gas connection straight flange 45x45mm hole distance 36x36mm 3/4" ELETTROSIT/V4400/4600/4605 screw with O-ring suitable for SIT/HONEYWELL		
	Part No.	101308	Ref. No. G653032
	gas connection angled flange 45x45mm hole distance 36x36mm 3/4" ELETTROSIT/V4400/4600/4605 screw with O-ring suitable for SIT/HONEYWELL		
	Part No.	101503	Ref. No. —
	O-ring EPDM thickness 2mm ID ø 32mm Qty 1 pcs		
	Part No.	101924	Ref. No. —
	plug with cable L 1090mm suitable for NOVA 822/826/827		

accessories			
	1		
Part No.	101306	Ref. No.	G652031
description	gas connection angled flange 45x45mm hole distance 36x36mm 1/2" ELETTROSIT/V4400/4600/4605 screw with O-ring suitable for SIT/HONEYWELL		
spare parts for	101306		
	Part No.	517104	Ref. No. —
	O-ring EPDM thickness 2.62mm ID ø 31.42mm Qty 1 pcs		

	1		
Part No.	101308	Ref. No.	G653032
description	gas connection angled flange 45x45mm hole distance 36x36mm 3/4" ELETTROSIT/V4400/4600/4605 screw with O-ring suitable for SIT/HONEYWELL		
For models:	W384121, W384122		

	1		
Part No.	101305	Ref. No.	G653033
description	gas connection straight 1/2" flange 45x45mm ELETTROSIT/V4400/4600/4605 suitable for SIT/HONEYWELL hole distance 36x36mm		
spare parts for	101305		
	Part No.	101503	Ref. No. —
	O-ring EPDM thickness 2mm ID ø 32mm Qty 1 pcs		

	1		
Part No.	101317	Ref. No.	G653035
description	plug with cable L 1000mm suitable for NOVASIT		
For models:	W381035, W384121, W384122, W385021, W385022, W385023, W385024, W385025		



ignition parts



pilot burners

SIT

100 series



Part No.	106906	Ref. No.	G207510
description	pilot burner SIT type 100 series 3 flames nozzle \varnothing 0.2mm gas connection 6mm		
spare parts for	106906		
	Part No.	100245	Ref. No. —
	pilot burner nozzle LPG code 20 bore \varnothing 0.2mm Qty 1 pcs thread M8x0.75		
	Part No.	100855	Ref. No. —
	pilot burner bracket triple		
	Part No.	100885	Ref. No. —
	air mixing sleeve for pilot burner Qty 1 pcs		
	Part No.	100916	Ref. No. —
	compression spring for pilot burner Qty 1 pcs		
	Part No.	100917	Ref. No. —
	gasket for pilot burner Qty 1 pcs aluminium		
	Part No.	100918	Ref. No. —
	screw for pilot burner		
	Part No.	107162	Ref. No. —
	pilot burner cap SIT 3 flames Hmm Lmm Qty 1 pcs		
	Part No.	107701	Ref. No. —
	pilot burner bottom part SIT 100 series nozzle \varnothing 0.2mm		
accessories for	106906		
	Part No.	100245	Ref. No. —
	pilot burner nozzle LPG code 20 bore \varnothing 0.2mm Qty 1 pcs thread M8x0.75		
	Part No.	100246	Ref. No. —
	pilot burner nozzle natural gas bore \varnothing 0.35mm Qty 1 pcs thread M8x0.75		
	Part No.	100904	Ref. No. —
	locking screw M10x1 for pipe \varnothing 4mm Qty 1 pcs		
	Part No.	100905	Ref. No. —
	locking screw M10x1 for pipe \varnothing 6mm Qty 1 pcs		
	Part No.	102110	Ref. No. —
	pilot tube copper pipe \varnothing 4mm thickness 1mm L 3000mm		
	Part No.	102111	Ref. No. B400106
	pilot tube copper pipe \varnothing 6mm thickness 1mm L 3000mm		

accessories for	106906		
	Part No.	107171	Ref. No. —
	pilot burner nozzle SIT natural/liquid gas bore \varnothing 0.25mm Qty 1 pcs		
	Part No.	107700	Ref. No. —
	pilot burner bottom part SIT 100 series nozzle \varnothing 0.25mm		
	Part No.	107702	Ref. No. —
	pilot burner bottom part SIT 100 series nozzle \varnothing 0.35mm		

accessories

ignition electrodes

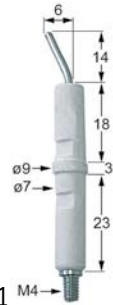

Part No.	100706	Ref. No.	G207511
description	ignition electrode connection M4 Qty 1 pcs		

electrodes

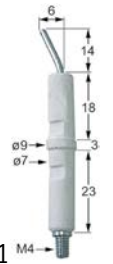

Part No.	100706	Ref. No.	G207511
description	ignition electrode connection M4 Qty 1 pcs		

ignition cables

cables







Part No.	100027	Ref. No.	E351610
description	ignition cable Qty 5m 0.34mm ² ED \varnothing 3mm insulation glass fibre t.max. 180°C		
accessories for	100027		
	Part No.	100021	Ref. No. —
	female faston size 2.8x0.8mm 0.5-1.0mm ² CuZn t.max. 125°C Qty 20 pcs		
	Part No.	100022	Ref. No. —
	female faston size 6.3x0.8mm 0.5-1.0mm ² CuZn t.max. 125°C Qty 20 pcs		
	Part No.	100023	Ref. No. —
	female bullet size 2.3mm 0.5-1.5mm ² CuZn t.max. 125°C Qty 20 pcs		

Table continues overleaf



accessories for	100027			
	Part No.	100024	Ref. No.	—
	female bullet size 4mm 0.25-1.5mm ² CuZn t.max. 125°C Qty 20 pcs			

ignition units



1

Part No.	102485	Ref. No.	E050505
description	ignition unit outputs 2 220-240VAC 0.6VA 50-60Hz		
For models:	W380161, W380162, W380261, W380413, W380423, W380433, W380443, W380461, W380511, W380521, W380531, W380541, W380666, W380912, W380915, W380917, W380919, W380922, W380925, W380927, W380929, W380932, W380935, W380937, W380939, W380942, W380945, W380947, W380949, W381035, W381515, W381525, W381535, W381545, W381815, W381825, W381835, W382561, W382562, W382661, W382662, W383061, W384022, W384121, W384122, W385021, W385022, W385023, W385024, W385025		



1

Part No.	102389	Ref. No.	E050506
description	ignition unit outputs 6 230VAC dimensions 135x23x34mm mounting distance 123mm inlet F6.3x0.8 outlet F2.8x0.8 0.6VA 50/60Hz		
For models:	W380111, W380112, W380121, W380122, W380131, W380132, W380141, W380142, W380151, W380152, W380161, W380162, W380211, W380221, W380231, W380241, W380251, W380261, W380411, W380421, W380431, W380441, W380451, W380461, W382511, W382551, W382552, W382561, W382562, W382611, W382651, W382652, W382661, W382662		

thermocouples

plug-in thermocouples

plug-in thermocouples standard

with barrel socket ø6(6.5)mm

thermocouples SIT

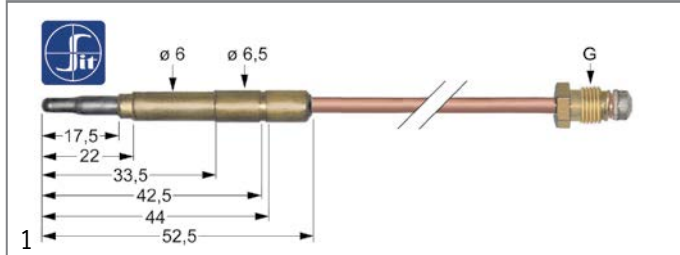

1

Part No.	107611	Ref. No.	G401030
description	thermocouple SIT M9x1 L 850mm plug connection ø6.0(6.5)mm		
For models:	W380111, W380112, W380121, W380122, W380131, W380132, W380141, W380142, W380151, W380152, W380161, W380162, W380211, W380221, W380231, W380241, W380251, W380261, W380511, W380521, W380531, W380541, W382511, W382551, W382552, W382561, W382562, W382611, W382651, W382652, W382661, W382662		

screw connections

olives







1

Part No.	101248	Ref. No.	G701026	
description	olive for pipe ø 12mm Qty 1 pcs suitable for PEL			
accessories for	101248			
	Part No.	101251	Ref. No.	—
	union nut thread M20x1.5 for pipe ø 12mm			

union screws



1

Part No.	100909	Ref. No.	G701010	
description	union screw thread M10x1 for pipe ø 6mm Qty 1 pcs			
accessories for	100909			
	Part No.	100898	Ref. No.	—
	olive for pipe ø 6mm Qty 1 pcs for pilot burner			
	Part No.	101286	Ref. No.	G701011
	olive ID ø 6mm Qty 1 pcs			
	Part No.	101287	Ref. No.	—
	olive for pipe ø 6mm Qty 1 pcs			
	Part No.	101288	Ref. No.	—
	olive for pipe ø 6mm L 6mm aluminium Qty 1 pcs ED ø 8.5mm			

gas lines

pilot tubes

universal



1

Part No.	102111	Ref. No.	B400106
description	pilot tube copper pipe ø 6mm thickness 1mm L 3000mm		



knobs

universal knobs



1

Part No.	110253	Ref. No.	E401205
description	knob switch zero mark t.max. °C ø 50mm shaft ø 6x4.6mm shaft flat upper black		
For models:	W380151, W380152, W380251, W380351, W380451, W380656, W382551, W382552, W382651, W382652, W383051		
accessories for	110253		
	Part No.	550965	Ref. No. —
knob spring ø 6x4.6mm Qty 1 pcs			



1

Part No.	110123	Ref. No.	E401280
description	knob thermostat t.max. 300°C ø 50mm shaft ø 6x4.6mm shaft flat upper black temperature range 50-300°C rotation 270°		
accessories for	110123		
	Part No.	110135	Ref. No. —
rosette knob up to ø 52mm			

producer-specific knobs

CAPIC



1

Part No.	110253	Ref. No.	E401205
description	knob switch zero mark t.max. °C ø 50mm shaft ø 6x4.6mm shaft flat upper black		
For models:	W380151, W380152, W380251, W380351, W380451, W380656, W382551, W382552, W382651, W382652, W383051		
accessories for	110253		
	Part No.	550965	Ref. No. —
knob spring ø 6x4.6mm Qty 1 pcs			



1

Part No.	110123	Ref. No.	E401280
description	knob thermostat t.max. 300°C ø 50mm shaft ø 6x4.6mm shaft flat upper black temperature range 50-300°C rotation 270°		
accessories for	110123		
	Part No.	110135	Ref. No. —
rosette knob up to ø 52mm			

locks



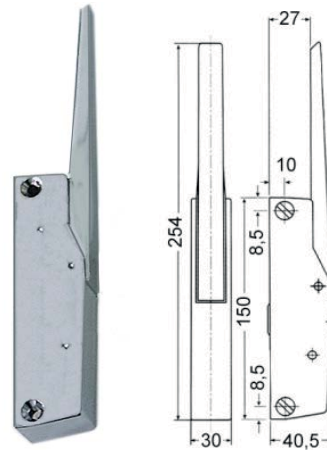

edgmount latches

handle latches

CAFF/FERMOD



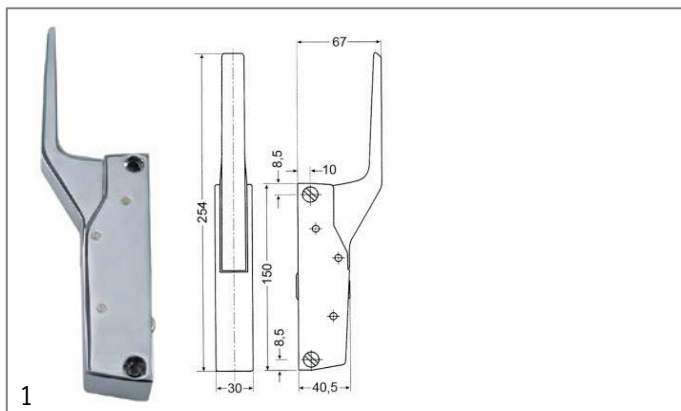

1

Part No.	690412	Ref. No.	Q105510
description	handle latch L 150mm mounting distance 133mm non lockable G 790 total length 254mm handle length 105mm		
accessories for	690412		
	Part No.	690418	Ref. No. —
door catch L 36mm W 19mm H 29mm mounting distance 12mm zinc-coated steel for refrigeration units			
	Part No.	690419	Ref. No. —
door catch L 52mm W 20mm H 30mm mounting distance 26-37mm zamak for refrigeration units			
	Part No.	700061	Ref. No. —
door catch L 58mm W 20mm H 35mm mounting distance 42mm chrome-plated brass for headed units			
	Part No.	700435	Ref. No. —
door catch L 58mm W 20mm H 35mm mounting distance 42mm zamak for refrigeration units			



1

Part No.	700060	Ref. No.	Q105512
description	handle latch L 150mm mounting distance 133mm non lockable heated units G 791		
accessories for	700060		
	Part No.	700061	Ref. No. —
	door catch L 58mm W 20mm H 35mm mounting distance 42mm chrome-plated brass for headed units		
	Part No.	700062	Ref. No. —
	handle protection heated units		

espagnolette locks

universal



1

Part No.	690041	Ref. No.	Q101009
description	cam L 148mm mounting distance 32mm		

shelves and shelf rails



grates

universal

without upstand





1

Part No.	970122	Ref. No.	A303005
description	grate W 325mm D 530mm GN 1/1 H 8mm stainless steel wire gauge frame 7mm lengthwise wires gauge 4mm crossing wires 1		
accessories for	970122		
	Part No.	690330	Ref. No. —
	rack L 1000mm W 22mm H 4mm aperture 3x8mm hole distance 12.5mm stainless steel		
	Part No.	694700	Ref. No. —
	shelf support L 31/28mm W 22mm H 18mm SS Qty 12 pcs		

accessories for	970122		
	Part No.	694701	Ref. No. —
	shelf support L 31/28mm W 22mm H 17mm SS with hook Qty 12 pcs		



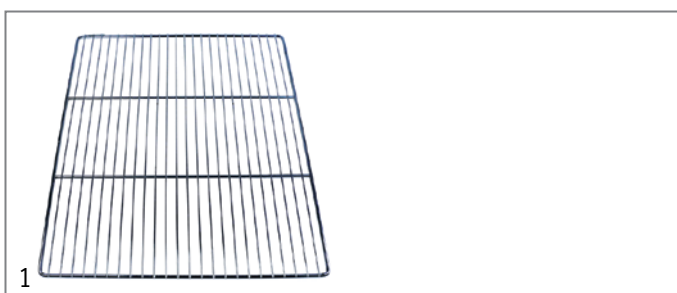

1

Part No.	970077	Ref. No.	A303015
description	grate W 400mm D 600mm SS crossing wires 1		
accessories for	970077		
	Part No.	690330	Ref. No. —
	rack L 1000mm W 22mm H 4mm aperture 3x8mm hole distance 12.5mm stainless steel		
	Part No.	694700	Ref. No. —
	shelf support L 31/28mm W 22mm H 18mm SS Qty 12 pcs		
	Part No.	694701	Ref. No. —
	shelf support L 31/28mm W 22mm H 17mm SS with hook Qty 12 pcs		



1

Part No.	970123	Ref. No.	A303020
description	grate W 650mm D 530mm GN 2/1 stainless steel wire gauge frame 7.8mm lengthwise wires gauge 3.8mm crossing wires 2 suitable for refrigerator		
accessories for	970123		
	Part No.	690330	Ref. No. —
	rack L 1000mm W 22mm H 4mm aperture 3x8mm hole distance 12.5mm stainless steel		
	Part No.	694700	Ref. No. —
	shelf support L 31/28mm W 22mm H 18mm SS Qty 12 pcs		
	Part No.	694701	Ref. No. —
	shelf support L 31/28mm W 22mm H 17mm SS with hook Qty 12 pcs		



gaskets

gaskets for heated units

window seals

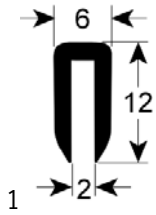

Part No.	901575	Ref. No.	I304004
description	window gasket profile 1503 suitable for CAPIC Qty supplied by meter		

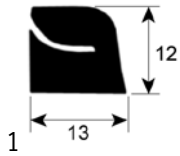

Part No.	900937	Ref. No.	I304026
description	window gasket profile 1893 Qty supplied by meter		

door seals

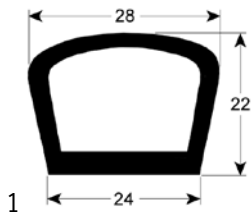

Part No.	901576	Ref. No.	I304016
description	door seal profile 2202 Qty supplied by meter suitable for CAPIC		

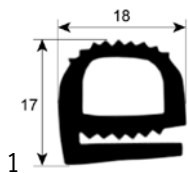

Part No.	900938	Ref. No.	I304002
description	door seal profile 2257 Qty supplied by meter dark blue silicone Shore 55° temp.-resist. -100 à +220°C		

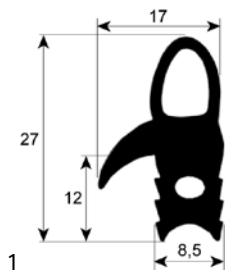

Part No.	900939	Ref. No.	I304024
description	door seal profile 2700 Qty supplied by meter light blue silicone Shore 55° temp.-resist. -100 à +220°C		

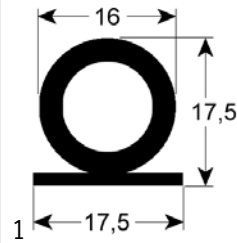

Part No.	901577	Ref. No.	I304006
description	door seal profile 2952 Qty supplied by meter suitable for CAPIC		



Part No.	901578	Ref. No.	I304008
description	door seal profile 2957 Qty supplied by meter suitable for CAPIC		

O-rings

EPDM

ø5.34mm



Part No.	510408	Ref. No.	E153011
description	O-ring EPDM thickness 5.34mm ID ø 47mm Qty 1 pcs		
For models:	W384111, W384112		

special gaskets

miscellaneous



Part No.	520942	Ref. No.	I101012
description	gasket L 75mm W 58mm silicone thickness 1mm		

hoses

supply hoses

PVC supply hoses

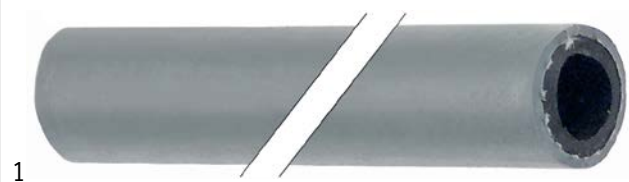

Part No.	520017	Ref. No.	L155025
description	supply hose ID ø 13mm ED ø 20mm L 5m operating p. 20bar burst p. 60bar t.max. 95°C grey Qty 5m		

GASTROPARTS.COM



© 2020 Gastroparts Sp. J. All rights reserved.