



GASTROPARTS

Bourgeois

[EN] Cooking

[DE] Kochtechnik

[ES] Cocción

[FR] Cuisson

[IT] Cottura

[PL] Obróbka termiczna

[RU] Термическая обработка

✉ gastroparts@gastroparts.com

☎ tel. +48 56 657 00 66

📘 fb.com/gastroparts.global

GASTROPARTS.COM





heating elements

immersion heating elements

with compression flange 50 x 26mm

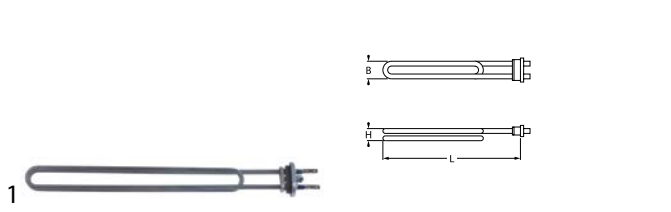

Part No.	418932	Ref. No.	RC553
description	heating element 2000W 240V heating circuits 1 flange 50x26mm L 350mm W 30mm Hmm compression flange connection male faston 6.3mm tube ø 6.3mm immersion heater		

miscellaneous



Part No.	420200	Ref. No.	RC2035
description	heating element 12000W 240V heating circuits 6 L 155mm W 78mm H 83mm tube ø 8.4mm hole distance 61mm hole ø 7mm connection male faston 6.3mm immersion heater flange connection		



Part No.	420203	Ref. No.	RC2029
description	heating element 12000W 240V heating circuits 6 L 165mm W 74mm H 83.5mm tube ø 8.4mm hole distance 61mm hole ø 7mm number of thermostat sleeves 1 thermostat sleeves ø 7.4mm length thermostat sleeves 73mm thermostat sleeve eccentric, clinging connection male faston 6.3mm immersion heater flange connection		

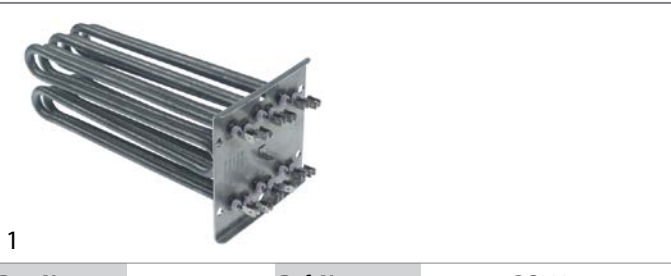

Part No.	420202	Ref. No.	RC2034
description	heating element 18000W 240V heating circuits 6 L 229mm W 78mm H 83mm tube ø 8.4mm hole distance 61mm hole ø 7mm connection male faston 6.3mm immersion heater flange connection		

Part No.	420199	Ref. No.	RC2032
description	heating element 18000W 240V heating circuits 6 L 235mm W 78mm H 83mm tube ø 8.4mm hole distance 61mm hole ø 7mm connection male faston 6.3mm immersion heater flange connection		

Part No.	416502	Ref. No.	RC231 RC802
description	heating element 8000W 240V heating circuits 3 L 305mm W 40mm Hmm number of thermostat sleeves thermostat sleeves ømm length thermostat sleevesmm tube ø 6.3mm hole distance 44.9mm hole ø 10mm connection length 23mm connection male faston 6.3mm 4 hole flange immersion heater flange width 63.5mm flange length 63.5mm ø 40mm		
accessories for	416502		
	Part No.	505180	Ref. No. JOIN261
	O-ring EPDM thickness 3.53mm ID ø 47.22mm Qty 1 pcs		



Part No.	420201	Ref. No.	RC2033
description	heating element 9000W 240V heating circuits 6 L 135mm W 78mm H 83.5mm tube ø 8.4mm hole distance 61mm hole ø 7mm connection male faston 6.3mm immersion heater flange connection		

heating elements for convection

Part No.	418916	Ref. No.	RC018 RC048 RC17
description	heating element 12000W 240V heating circuits 3 ID ø 390mm ED ø 410mm L 410mm H 100mm H1 25mm H2 75mm thread M12x1 6 hole fixing connection male faston 6.3mm tube ø 8.5mm convection heating element		
accessories for	418916		
	Part No.	101566	Ref. No. —
	nut thread M12x1 H 10mm WS 19 SS Qty 1 pcs		

Table continues overleaf



accessories for	418916		
	Part No.	506046	Ref. No. —
	flat gasket FIBER ED ø 19.5mm ID ø 13mm thickness 2mm Qty 1 pcs		
	Part No.	528622	Ref. No. —
	spring ø 15.3mm L 25mm wire gauge ø 1.25mm for water filling		

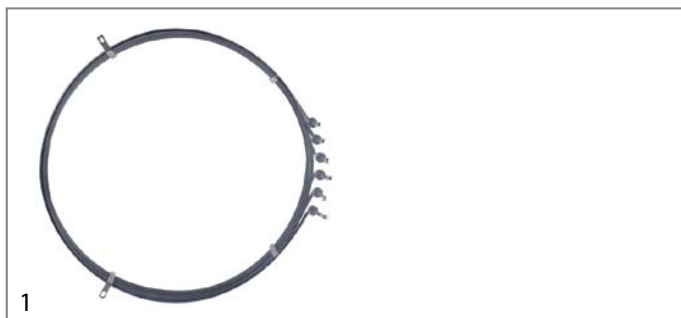



Part No.	418927	Ref. No.	RC081
description	heating element 12000W 240V heating circuits 3 ID ø 440mm ED ø 458mm L 472mm H 80mm L1 15mm H1 8mm H2 72mm thread M12x1 6 hole fixing connection male faston 6.3mm tube ø 6.3mm convection oven convection heating element		

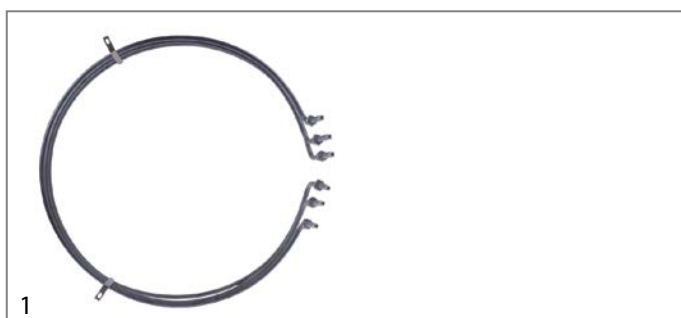

Part No.	418926	Ref. No.	RC019
description	heating element 8000W 240V heating circuits 3 ID ø 301mm ED ø 317mm L 328mm H 95mm L1 11mm H1 12mm H2 83mm thread M12x1 6 hole fixing connection male faston 6.3mm tube ø 8.5mm convection oven convection heating element		



Part No.	418928	Ref. No.	RC017 RC18
description	heating element 9000W 240V heating circuits 3 ID ø 458mm ED ø 475mm L 475mm H 114mm H1 31mm H2 73mm thread M12x1 6 hole fixing connection male faston 6.3mm tube ø 8.5mm convection oven convection heating element		

accessories for	418928		
	Part No.	101566	Ref. No. —
	nut thread M12x1 H 10mm WS 19 SS Qty 1 pcs		
	Part No.	506046	Ref. No. —
	flat gasket FIBER ED ø 19.5mm ID ø 13mm thickness 2mm Qty 1 pcs		
	Part No.	528662	Ref. No. —
	flat gasket copper ED ø 16mm ID ø 12mm thickness 1.5mm		



Part No.	418925	Ref. No.	RC611
description	heating element 1500W 230V heating circuits 1 L 293mm W 106mm L1 32mm L2 261mm W2 83mm flange length 50mm flange width 26mm connection length 63mm connection male faston 6.3mm tube ø 8.5mm hole ø 6.2mm W1 23mm convection heating element convection oven INCOLOY windings 2		

accessories for	418925		
	Part No.	520588	Ref. No. JOIN071
	gasket L 46mm W 22mm hole distance 24.5mm silicone for heating element		



Part No.	416500	Ref. No.	IR00612Y RC601
description	heating element 2000W 230V heating circuits 1 L 295mm W 110mm L1 35mm L2 260mm W2 88mm flange length 50mm flange width 26mm connection length 60mm connection male faston 6.3mm tube ø 8.5mm hole ø 6.2mm W1 15mm compression flange dry heating element		

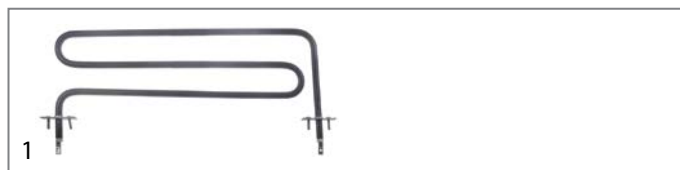

Part No.	418933	Ref. No.	RC114 RC154
description	heating element 2000W 240V heating circuits 1 L 390mm W 134mm W2 100mm flange length 50mm flange width 20mm connection length 50mm connection M4 tube ø 10mm thread M4 W1 34mm rectangular flange convection heating element convection oven		

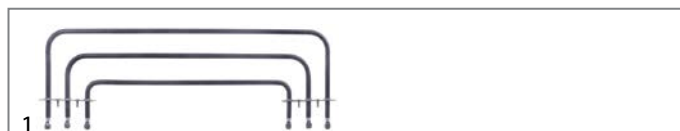

Part No.	418917	Ref. No.	RC111 RC151
description	heating element 3000W 240V heating circuits 3 L 570mm W 140mm W2 110mm flange length 110mm flange width 20mm hole distance 40mm connection length 55mm connection M4 tube ø 10mm thread M4 W1 30mm rectangular flange convection heating element convection oven		

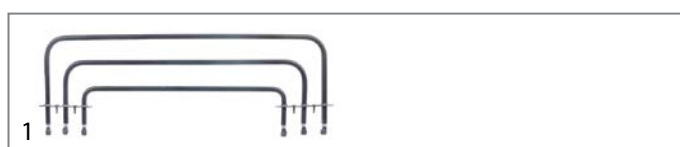

Part No.	418918	Ref. No.	RC110 RC511
description	heating element 4000W 240V heating circuits 3 L 570mm W 140mm W2 110mm flange length 110mm flange width 20mm hole distance 40mm connection length 55mm connection M4 tube ø 10mm thread M4 W1 30mm rectangular flange convection heating element convection oven		



accessories

sealing washers

O-rings

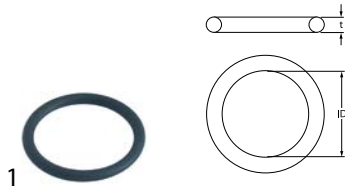

Part No.	505092	Ref. No.	JOIN057
description	O-ring EPDM thickness 5.34mm ID ø 43.82mm Qty 1 pcs		

flange gaskets



Part No.	511688	Ref. No.	JOIN2033
description	gasket silicone L 115mm W 114mm thickness 4mm		



Part No.	511687	Ref. No.	JOIN2029
description	gasket silicone L 138mm W 107mm thickness 4mm		



Part No.	520588	Ref. No.	JOIN071
description	gasket L 46mm W 22mm hole distance 24.5mm silicone for heating element		

thermostats

control and safety thermostats

EGO

control thermostats

55.10/19_series



Part No.	375002	Ref. No.	THER001
-----------------	--------	-----------------	---------

description	thermostat t.max. 320°C temperature range 55-320°C 1-pole 1NO 16A probe ø 3.1mm probe L 226mm capillary pipe 870mm capillary pipe isolated 850mm gland nut shaft L 23mm shaft position upper rotation 270°		
--------------------	------------------------------------------------------------------------------------------------------------------------------------------------------------------------------------------------------------	--	--

55.13_series



Part No.	375154	Ref. No.	THER019
-----------------	--------	-----------------	---------

description	thermostat t.max. 250°C temperature range 50-250°C 1-pole 1NO 16A probe ø 3.1mm probe L 201mm capillary pipe 2970mm capillary pipe isolatedmm gland nut shaft L 23mm shaft position upper rotation 270° probe material SS		
--------------------	---------------------------------------------------------------------------------------------------------------------------------------------------------------------------------------------------------------------------	--	--

55.34_series



Part No.	376051	Ref. No.	THER102
-----------------	--------	-----------------	---------

description	thermostat t.max. 200°C temperature range 70-145-200°C 3-pole 3NC probe ø 3.1mm probe L 263mm capillary pipe 880mm capillary pipe isolated 400mm		
--------------------	--------------------------------------------------------------------------------------------------------------------------------------------------	--	--



IMIT / TEMPOMATIC / ARTHERMO

control thermostats



1

Part No.	390186	Ref. No.	REGU010
description	thermostat t.max. 52°C temperature range fixed 52°C 1-pole 1CO 16A probe ø 6.5mm probe L 95mm capillary pipe 1000mm capillary pipe isolated 1000mm gland nut shaft Lmm contacts 1CO		

CAEM

safety thermostats



1

Part No.	375996	Ref. No.	THER3004
description	safety thermostat switch-off temp. 225°C 1-pole 1NC 16A probe ø 5mm probe L 80mm capillary pipe 900mm capillary pipe isolated 410mm gland nut M10 probe SS 250V		

switches and momentary switches

rocker/momentary rocker switches

30x22mm



1

Part No.	301004	Ref. No.	INT006
description	rocker switch mounting measurements 30x22mm black 2CO 250V 16A connection male faston 6.3mm ambient temperature max. 125/55°C protection IP40		
accessories for	301004		
	Part No.	301036	Ref. No. —
	protective cover internal size 30x22mm for rocker switch mounting measurementsmm		

blank



1

Part No.	301165	Ref. No.	INT006
description	rocker switch mounting measurements 30x22mm black 2CO 250V 16A connection male faston 6.3mm ambient temperature max. 125/55°C protection IP65 with cover cap		
accessories for	301165		
	Part No.	301036	Ref. No. —
	protective cover internal size 30x22mm for rocker switch mounting measurementsmm		

push/momentary push switches

ø12mm



1

Part No.	347567	Ref. No.	INT003
description	momentary push switch mounting ø 12mm white 1NO 250V 4A connection male faston 6.3mm ambient temperature max. 85°C protection IP40		

microswitches

pin-plunger actuated

M12



1

Part No.	345350	Ref. No.	INT008
description	microswitch with plunger mounting distance 22mm thread M12x0.75 thread L 16mm 250V 16A 1CO connection male faston 6.3mm stroke 4mm ambient temperature max. 125°C type EF83161.3 actuating force: 66g		
accessories for	345350		
	Part No.	345351	Ref. No. —
	nut thread M12x0.75 H 1.6mm WS 14 chrome-plated brass Qty 1 pcs		

cam switches

4 operating positions



1

Part No.	300077	Ref. No.	COMU004
description	cam switch 4 operating positions 5NO sequence 0-1-2-3 16A shaft ø 6x4.6mm shaft L 23mm connection male faston 6.3mm plastic		



magnetic switches

M12x1

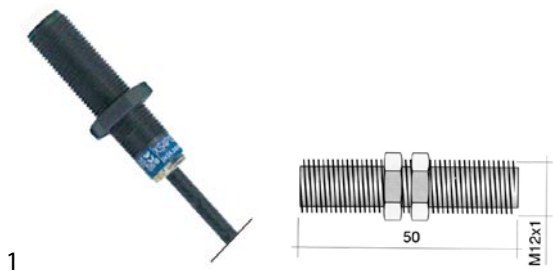

1	Part No.	345900	Ref. No.	INT005
description magnetic switch thread M12x1 1NO 24-240V AC/DCV 0.2A P max. 5-50W connection cable cable length 2000mm				

control equipment

SCHNEIDER ELECTRIC

rotary switches



1	Part No.	347951	Ref. No.	INT037
description rotary selector mounting measurements ø22mm green sequence 0-1 latching illuminated				

TELEMECANIQUE (EFA)

XB2 series

signal element



1	Part No.	345397	Ref. No.	VOY103
description signal element mounting measurements ø22mm red				

rotary switches



1	Part No.	345222	Ref. No.	INT202
description rotary selector mounting measurements ø22mm black latching sequence 0-1				



1	Part No.	345223	Ref. No.	INT205
description rotary selector mounting measurements ø22mm black latching sequence 1-0-2				

ZB2 series

switch blocks



1	Part No.	347566	Ref. No.	INT036
description contact block 2NO illuminated				

ZB4 series

rotary switches



1	Part No.	347951	Ref. No.	INT037
description rotary selector mounting measurements ø22mm green sequence 0-1 latching illuminated				

miscellaneous



1	Part No.	345903	Ref. No.	INT204
description push button black				



lamps

indicator lights

indicator lights 2-piece (lens and indicator lamp)

indicator light lenses

ø12mm (type SDY-3)



Part No.	359261	Ref. No.	VOT060 VOY060
description	indicator light housings mounting measurements ø12mm red round Qty 1 pcs		

indicator lights (complete)

ø13mm

with plug-in socket



Part No.	359045	Ref. No.	VOY062
description	indicator light ø 13mm clear 230V connection male faston 6.3mm temp.-resist. 120°C Qty 1 pcs		



Part No.	359141	Ref. No.	VOY060
description	indicator light ø 13mm red 230V connection male faston 6.3mm temp.-resist. 120°C Qty 1 pcs		

screw-on/push-on fit

halogen lamp

for socket G4 / G6.35 / G9



Part No.	357193	Ref. No.	LAMP050
description	halogen lamp socket G4 12V 20W temp.-resist. 300°C OSRAM HALOSTAR OVEN		

oven lamps

producer-specific oven lamps

BOURGEOIS



Part No.	511690	Ref. No.	JOIN075 JOIN109
description	gasket L 78mm W 42mm silicone hole distance 66.5mm thickness 3mm for lamp		



Part No.	360530	Ref. No.	HUBL009
description	lamp glass L 47.4mm W 32.8mm glas thickness 3.2mm		



Part No.	359580	Ref. No.	LAMP011 Lamp012
description	lamp socket for halogen lamp		

lamps

halogen lamps

for socket G4 / G6.35 / G9



Part No.	357193	Ref. No.	LAMP050
description	halogen lamp socket G4 12V 20W temp.-resist. 300°C OSRAM HALOSTAR OVEN		

timers

programme timers



Part No.	360251	Ref. No.	05224C MOT010
description	gear motor CROUZET chambers 1 operation time 230V 50Hz shaft ømm shaft Lmm H 78mm L 116mm W 55mm type 88256462 shaft ø 5/6mm		



mechanical timers

			
1			
Part No.	350214	Ref. No.	MIN014
description	timer M2 2-pole operation time 120min impulse mechanical 1NO/1NC at 250V 16A permanent position no shaft ø 6x4.6mm shaft 6x4.6mm shaft L 23mm mounting distance 28mm connection lateral		

TELEMECANIQUE (Schneider Electric)

power contactors

			
1			
Part No.	380479	Ref. No.	REL1607
description	power contactor resistive load 25A 230VAC (AC3/400V) 9A/4kW main contacts 3NO auxiliary contacts 1NO/1NC connection screw connection type LC1D09P7		

alarm devices

buzzers

			
1			
Part No.	350050	Ref. No.	BRUI001
description	buzzer 230VAC connection male faston 6.3mm screw mounting thread M4 60dB		

			
1			
Part No.	380976	Ref. No.	REL1600
description	power contactor resistive load 32A 230VAC (AC3/400V) 18A/7.5kW main contacts 3NO auxiliary contacts 1NO/1NC connection screw connection		

contactors

ISKRA (FANAL)

power contactors

			
1			
Part No.	380204	Ref. No.	REL610
description	power contactor resistive load 25A 230VAC (AC3/400V) 9A/4kW main contacts 3NO auxiliary contacts 1NO connection screw connection type Fanal DSL9 10 type ISKRA KNL9 10		

			
1			
Part No.	380603	Ref. No.	REL611
description	power contactor resistive load 40A 230VAC (AC3/400V) 25A/11kW main contacts 4NO auxiliary contacts connection screw connection type LC1D25004		



1

Part No.	380982	Ref. No.	REL1603
description	power contactor resistive load 80A 230VAC (AC3/400V) 50A/22kW main contacts 3NO auxiliary contacts 1NO/1NC connection screw connection type LC1D50P7		

auxiliary contactors



1

Part No.	381139	Ref. No.	REL622
description	auxiliary contactor 230VAC AC1 10A type CA2KN407M7 connection male faston 2.8mm/6.3mm contacts 4NO		

auxiliary contacts



1

Part No.	381140	Ref. No.	REL464
description	auxiliary contact contacts 1NO/1NC AC15 6A connection screw type GVAN11		

miscellaneous

installation contactors



1

Part No.	380601	Ref. No.	REL153
description	contactor		

solid state relays

CROUZET



1

Part No.	403090	Ref. No.	REL232
description	solid state relay CROUZET 1 phase 125A 48-660V 4-32VDC L 57mm W 44mm screw type 84134180		



1

Part No.	403089	Ref. No.	REL231
description	solid state relay CROUZET 1 phase 50A 48-660V 4-32VDC L 57mm W 44mm screw type 84134120		

electronics

PCBs



1

Part No.	402984	Ref. No.	280901 ELEC2003 ELEC2017
description	control PCB combi-steamer UC0611/1011/2011 L 140mm W 100mm		



1

Part No.	400802	Ref. No.	NIV010
description	level relay 240V type ATO 600722/A		



			
1			
Part No.	403685	Ref. No.	ELEC2001 ELEC2015
description	PCB L 200mm W 95mm		

			
1			
Part No.	361851	Ref. No.	ELEC014
description	PCB L 70mm W 20mm		

			
1			
Part No.	402982	Ref. No.	ELEC2004
description	relay PCB combi-steamer UC0611/1011/2011 cable length 220mm push-in		

keypads

keypad units

			
1			
Part No.	403122	Ref. No.	20467
description	keypad unit combi-steamer UC0611/1011/2011 buttons 9 L 350mm W 153mm		

solenoid valves

solenoid valves (water)



ROBERTSHAW/INVENSYS

medium temperature: 90°C 90°C 60°C
 ambient temperature: 60°C 25°C 60°C
 duty cycle: 40% 100% 100%

solenoid valves with reducers

2-fold



1			
Part No.	370696	Ref. No.	ROB2000
description	solenoid valve double straight 230VAC inlet 3/4" outlet 11.5mm t.max. 90°C Invensys plastic output A 1.2l/min flow regulating valve outlet A blue with non-return valve		
spare parts for	370696		
	Part No.	371131	Ref. No. —
	solenoid coil 230VAC		
	Part No.	371174	Ref. No. —
	solenoid coil 230VAC connection coded plug 6W		

with coded terminal



1			
Part No.	370269	Ref. No.	06245
description	solenoid valve double straight 230VAC inlet 3/4" outlet 11.5mm DN10 EATON (INVENSYS)		

electrodes



1			
Part No.	400807	Ref. No.	NIV007
description	level electrode 1/2" total length 112mm probe L 88mm insulated probe length uninsulatedmm connection bullet connector		



1			
Part No.	400804	Ref. No.	NIV602
description	level electrode 3/8" total length 75mm probe L 48mm insulated probe length 47mm conical connection M4		





fans

axial fans

import



1

Part No.	601080 ¹	Ref. No.	MOT030
description	axial fan L 119mm W 119mm H 38mm 230VAC 50/60Hz 23/20W bearing ball bearing connection male faston 2.8mm metal ADDA fan wheel ø 110mm temp.-resist. 70°C		
accessories for	601080		
	Part No.	550898	Ref. No. —
	connecting cable cable length 2000mm connection F 2.8 connection distance 7.9mm for axial flow fan		
	Part No.	692519	Ref. No. —
	guard L 120mm W 120mm plastic		

¹with ball bearings

hot air fans

ebm-papst



1

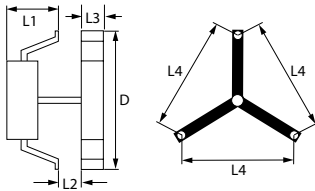

Part No.	601808	Ref. No.	MOT2023
description	hot air fan 230/240V 50W L1 69mm L2mm L3mm L4 87mm fan wheel ø 150mm type RRL152/0020A92-3030LH-197 ebm-papst		

motors

gear motors

for ovens



1

Part No.	500811	Ref. No.	MOT018
description	gear motor AUTOM type ASR/30/FR 230V 50Hz shaft ø 8mm L 150mm W 65mm H 90mm		

pumps

drain pumps

HANNING



1

Part No.	500573	Ref. No.	ROB013
description	drain pump 30W 4-piece 230V inlet ø 24/30mm outlet ø 24mm 50Hz HANNING type DPS25-032 1x pump, 3x pump cover		

service kits



1

Part No.	500573	Ref. No.	ROB013
description	drain pump 30W 4-piece 230V inlet ø 24/30mm outlet ø 24mm 50Hz HANNING type DPS25-032 1x pump, 3x pump cover		



booster pumps II

accessories



1

Part No.	365017	Ref. No.	MOT2013
description	operating capacitor capacity 5µF 450V tolerance 5% 50/60Hz ambient temperature max. -25 to +85°C ø 28mm L 54mm M8 plastic connection male faston 6.3mm 16.10.08 protection		

vibration pumps



1

Part No.	500219	Ref. No.	POMP001
description	vibration pump type CP.3A.958.1/ST 230V 65W 50Hz inlet ø 6 outlet ø 1/8" IT EATON (INVENSYS) L 123mm		

condensators & interference suppression filters

operating capacitors

plastic



1

Part No.	365150	Ref. No.	MOT2008
description	operating capacitor capacity 20µF 425V tolerance 5% 50Hz ambient temperature max. -25 to +85°C ø 40mm L 70mm M8 plastic connection male faston 6.3mm 416.10.25 protection		



1

Part No.	365017	Ref. No.	MOT2013
description	operating capacitor capacity 5µF 450V tolerance 5% 50/60Hz ambient temperature max. -25 to +85°C ø 28mm L 54mm M8 plastic connection male faston 6.3mm 16.10.08 protection		

fuses

fine fuses



1

Part No.	358532	Ref. No.	FUSI003
description	fine fuse size ø5x20mm 2A fast-acting rated 250V Qty 10 pcs		



1

Part No.	358607	Ref. No.	Fusi004
description	fine fuse size ø5x20mm 6.3A slow-acting rated 250V Qty 10 pcs		

electric accessories

terminals

terminal blocks



1

Part No.	550232	Ref. No.	BAR001
description	lustre terminal 12-pole cross section 2.5mm ² max. 32A max 450V temp.-resist. 150°C		

rail-mounted terminals

WIELAND

rail-mounted terminals type 9700A



1

Part No.	550374	Ref. No.	BORN101
description	rail-mounted terminal WIELAND type 9700A/10 S35 1.5-16mm ² top-hat rail 35mm blue W 10mm L 49mm		

1

Part No.	550375	Ref. No.	BORN102A
description	rail-mounted terminal WIELAND type 9700A/10 SL2 S35 1.5-16mm ² top-hat rail 35mm yellow/green W 10mm L 53mm		



1

Part No.	550377	Ref. No.	BORN105
description	rail-mounted terminal WIELAND type 9700A/16 S35 2.5-35mm ² top-hat rail 35mm blue W 16mm L 59mm		



1

Part No.	550378	Ref. No.	BORN108
description	rail-mounted terminal WIELAND type 9700A/16 SL2 S35 2.5-35mm ² top-hat rail 35mm yellow/green W 16mm L 53mm		

accessories



1

Part No.	550370	Ref. No.	BORN211
description	terminal block end bracket clampsmm ²		

ignition parts

electrodes



1

Part No.	106928	Ref. No.	ALLU009
description	ignition electrode flange length 22mm flange width 1 16mm D1 ø 7mm L1 4mm BL1 49mm BL2 20mm connection ø 6mm		

ignition units



1

Part No.	106925	Ref. No.	ALLU030
description	ignition unit outputs 1 230VAC dimensions 85x63x38mm mounting distance 60mm inlet F2.8x0.8 outlet ø4mm type EBI4 1P S service kit 90VA 50-60Hz		

doors



1

Part No.	694536	Ref. No.	DECO214
description	door bolt for combi-steamer thread M5 ø 8mm L 46mm		



1

Part No.	696417	Ref. No.	DECO364
description	locking screw for door thread M5		



1

Part No.	696418	Ref. No.	DECO043
description	locking screw for door thread M5		



1

Part No.	696419	Ref. No.	JOIN655
description	rubber sleeve for door		





1



Part No.	696421	Ref. No.	DECO414
description	threaded bush for door thread M5 IT ø 9.5mm L 24mm		



			
1			
Part No.	696422	Ref. No.	DECO384
description	threaded bush for door thread M5 L 48mm		

door mechanics			
accessories			
			
1			
Part No.	694537	Ref. No.	CHAR203
description	base plate L 51mm W 22mm for catch plastic mounting distance 30mm thickness 2mm		









knobs			
universal knobs			
			
1			
Part No.	110865	Ref. No.	MAN130
description	knob switch zero mark t.max.°C ø 50mm shaft ø 6x4.6mm shaft flat left black		

			
1			
Part No.	110253	Ref. No.	MAN003
description	knob switch zero mark t.max.°C ø 50mm shaft ø 6x4.6mm shaft flat upper black		
accessories for	110253		
	Part No.	550965	Ref. No. —
	knob spring ø 6x4.6mm Qty 1 pcs		

producer-specific knobs			
BOURGEOIS			
			
1			
Part No.	110865	Ref. No.	MAN130
description	knob switch zero mark t.max.°C ø 50mm shaft ø 6x4.6mm shaft flat left black		

locks





handle latches
universal
inside fixing
locks

			
1			
Part No.	694054	Ref. No.	CHAR2006
description	door handle for headed units L 145mm W 40mm H 62mm spring length 33mm inner black		
spare parts for	694054		
	Part No.	514390	Ref. No. —
	spring for door handle ø 6mm L 54mm W 27.5mm		
	Part No.	694675	Ref. No. —
	door catch L 88mm W 40mm H 37mm spring length 33mm mounting distance 60mm		
	Part No.	694734	Ref. No. —
	door handle L 165mm W 40mm H 25mm black		
	Part No.	694735	Ref. No. —
	cap ø 32mm black		
accessories for	694054		
	Part No.	691123	Ref. No. —
	duct for door opener		
	Part No.	694055	Ref. No. —
	door catch L 25mm W 14mm total length 54mm thread M8 thread L 29mm		
	Part No.	694066	Ref. No. —
	door catch with spigot 2-stage L 28mm W 14mm H 15mm H1 16mm total length 51mm thread M8 thread L 23mm stainless steel		
	Part No.	694067	Ref. No. CHAR2007
	door catch with spigot 1-stage L 26mm total length 51mm thread M8		



producer-specific

BOURGOIS

 <p>1</p>			
Part No.	694054	Ref. No.	CHAR2006
description	door handle for headed units L 145mm W 40mm H 62mm spring length 33mm inner black		
spare parts for	694054		
	Part No.	514390	Ref. No. —
	spring for door handle ø 6mm L 54mm W 27.5mm		
	Part No.	694675	Ref. No. —
	door catch L 88mm W 40mm H 37mm spring length 33mm mounting distance 60mm		
	Part No.	694734	Ref. No. —
	door handle L 165mm W 40mm H 25mm black		
	Part No.	694735	Ref. No. —
	cap ø 32mm black		
accessories for	694054		
	Part No.	691123	Ref. No. —
	duct for door opener		
	Part No.	694055	Ref. No. —
	door catch L 25mm W 14mm total length 54mm thread M8 thread L 29mm		
	Part No.	694066	Ref. No. —
	door catch with spigot 2-stage L 28mm W 14mm H 15mm H1 16mm total length 51mm thread M8 thread L 23mm stainless steel		
	Part No.	694067	Ref. No. CHAR2007
	door catch with spigot 1-stage L 26mm total length 51mm thread M8		

edgmount latches

push button latches

RAHRBACH

6186 PRESTO series

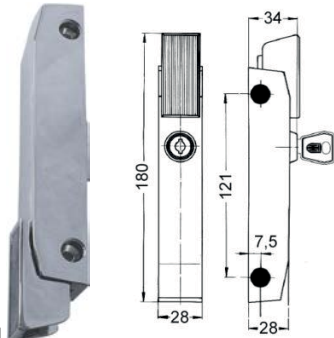
 <p>1</p>			
Part No.	701042	Ref. No.	90000012 MB90000012
description	push button latch L 180mm mounting distance 121mm chrome-plated H 34mm W 28mm type PRESTO no. 6186		

snap locks

universal

 <p>1</p>			
Part No.	700800	Ref. No.	CHAR150
description	snap lock L 59mm W 11.5mm H 15mm mounting distance 50mm complete with door catch nickel-plated brass thickness 2.7mm		

miscellaneous

 <p>1</p>			
Part No.	511618	Ref. No.	00461A
description	door catch H 24.5mm L 31mm W 21mm mounting distance 21mm rollerø 14mm		

 <p>1</p>			
Part No.	511619	Ref. No.	02668B
description	door catch with roller H 23mm adjustable L 90mm W 21mm mounting distance 52/76mm rollerø 14mm		



hinges

door bearing



1

Part No.	511603	Ref. No.	COUS002
description	bush H 7.5mm ID \varnothing 8.2mm with layer		



1

Part No.	690835	Ref. No.	CHAR202
description	hinge bearing without bolt		

miscellaneous



1

Part No.	511602	Ref. No.	CHAR201
description	hinge		

accessories

bushes



1

Part No.	694336	Ref. No.	DECO 071
description	bush ID \varnothing 8mm ED \varnothing 12mm L 15mm		

gaskets

gaskets for heated units

window seals

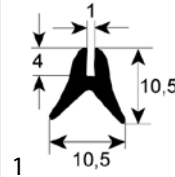

1

Part No.	901512	Ref. No.	JOIN063
description	window gasket profile 1615 L 1350mm suitable for BOURGEOIS Qty 1		

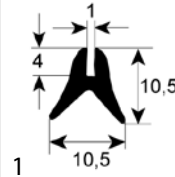

1

Part No.	511610	Ref. No.	JOIN066
description	window gasket profile 1615 L 1950mm Qty 1		

door seals

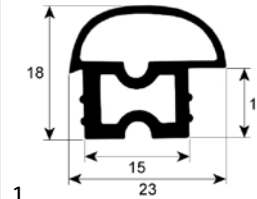

1

Part No.	901411	Ref. No.	10683A MB10683A
description	door seal profile 2035 Qty supplied by meter		

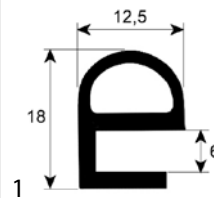

1

Part No.	901516	Ref. No.	JOIN082 KITJOIN082
description	door seal profile 2225 perimeter 2030mm suitable for BOURGEOIS		

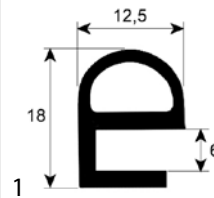

1

Part No.	901409	Ref. No.	JOIN018
description	door seal profile 2225 perimeter 2530mm suitable for BOURGEOIS		



Part No.	901427	Ref. No.	KITJOIN018
description	door seal profile 2225 perimeter 2530mm suitable for BOURGEOIS		

Part No.	901410	Ref. No.	JOIN019 KITJOIN019
description	door seal profile 2225 perimeter 3900mm suitable for BOURGEOIS Qty 1		

Part No.	901425	Ref. No.	JOIN1003
description	door seal profile 2226 L 3500mm Qty 1 W 700mm		

Part No.	901426	Ref. No.	JOIN155 JOIN180
description	door seal profile 2226 perimeter 2250mm Qty 1		

Part No.	901514	Ref. No.	JOIN1015
description	door seal profile 2227 perimeter 2650mm suitable for BOURGEOIS kit		

Part No.	901424	Ref. No.	JOIN021 JOIN022 PROF777
description	door seal profile 2711 L 2600mm Qty 1		

Part No.	901655	Ref. No.	JOIN015
description	door seal profile 2980 L 2230mm		

Part No.	518126	Ref. No.	JOIN016 PROF1612
description	door seal profile 2980 L 2820mm		

Part No.	511620	Ref. No.	JOIN029
description	door seal profile 2985 L 4350mm Qty 1		

gaskets for control panels

Part No.	901510	Ref. No.	JOIN086
description	gasket for control panel W 13mm L 1500mm suitable for BOURGEOIS		

Part No.	901508	Ref. No.	JOIN087
description	gasket for control panel W 13mm L 2050mm suitable for BOURGEOIS		



Part No.	901509	Ref. No.	JOIN088
description	gasket for control panel W 13mm L 3500mm suitable for BOURGEOIS		

O-rings

EPDM

ø1.78mm



Part No.	524421	Ref. No.	JOIN211
description	O-ring EPDM thickness 1.78mm ID ø 2.78mm Qty 1 pcs		

ø3.53mm

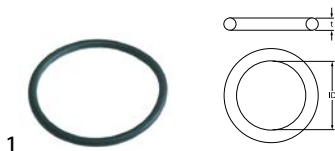

Part No.	505180	Ref. No.	JOIN261
description	O-ring EPDM thickness 3.53mm ID ø 47.22mm Qty 1 pcs		

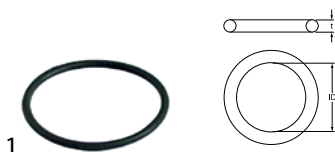

Part No.	511331	Ref. No.	JOIN 261
description	O-ring EPDM thickness 3.53mm ID ø 53.57mm Qty 1 pcs		

ø5.34mm



Part No.	505092	Ref. No.	JOIN057
description	O-ring EPDM thickness 5.34mm ID ø 43.82mm Qty 1 pcs		



Part No.	691033	Ref. No.	JOIN057
description	O-ring EPDM thickness 5.34mm ID ø 62.87mm Qty 1 pcs		

sealing washers

silicone gaskets



Part No.	511691	Ref. No.	JOIN047
description	gasket silicone ED ø 51mm ID ø 4mm thickness 2mm Qty 1 pcs for combi-steamer		

special gaskets

miscellaneous



Part No.	511615	Ref. No.	JOIN660
description	boiler gasket		



Part No.	511600	Ref. No.	00288A JOIN084
description	gasket ED ø 80mm		



Part No.	511689	Ref. No.	JOIN2026
description	gasket for lamp L 100mm W 24mm silicone thickness 2.8mm hole distance 22mm		



springs

compression springs

 <p>1</p>			
Part No.	692202	Ref. No.	RES028
description	compression spring ø 4mm L 3mm wire gauge ø 0.5mm windings 2		

water cycle components

pressure reduction valves

pressure reduction valves

producer-specific

 <p>1</p>			
Part No.	520589	Ref. No.	ROB028
description	pressure reduction valve Norgren series R91 connection 1/4" default settingbar setting range 0.1-3bar p max 10bar t.max. 50°C brass		

 <p>1</p>			
Part No.	520553	Ref. No.	ROB2004
description	pressure reduction valve Norgren series R91 connection 3/4" default settingbar setting range 0.1-3bar p max 10bar t.max. 50°C with manometer and non-return valve brass		

fastening material

screws

grub screws

DIN 913/ISO 4026

 <p>1</p>			
Part No.	504733	Ref. No.	VIS317
description	grub screw thread M4 L 5mm stainless steel DIN 913 intake internal hexagon WS 2 Qty 1 pcs		

miscellaneous

 <p>1</p>			
Part No.	692200	Ref. No.	DECO366
description	grub screw thread M6 L 2.5mm SS intake slotted WS Qty 1 pcs		

washers

washers

miscellaneous

 <p>1</p>			
Part No.	692198	Ref. No.	VIS276
description	plain washer ID ø 8.5mm ED ø 18mm thickness 1.4mm SS Qty 1 pcs		



consumables

sealants and adhesives

high temperature silicone



1

Part No.	890059	Ref. No.	JOIN555
description	high temperature silicone FERMITOPP 300 neutral curing -40 up to +265°C black cartridge 310ml		
description	<p>Fermitopp HN 300 - cartridge 310ml - black Is used for sealing expansion joints on heating flues, ovens, reactors, chimneys, stacks, etc. The sealant is neutrally cross-linking, reacts with the moisture in the air and is characterised by extremely good hot air-resistance. The adhesive surfaces must be dry, clean and free of loose parts and in the case of porous substrates they should, if necessary, be given a first coat of primer. Post-smoothing e.g. with soap solution must take place before skinning. Highly refractory, odourless, UV/water/colour/hot-air resistant Temperature range -50°C to +250°C</p>		

fuses

fine fuses



1

Part No.	358532	Ref. No.	FUSI003
description	fine fuse size ø5x20mm 2A fast-acting rated 250V Qty 10 pcs		



1

Part No.	358607	Ref. No.	Fusi004
description	fine fuse size ø5x20mm 6.3A slow-acting rated 250V Qty 10 pcs		

GASTROPARTS.COM



© 2020 Gastroparts Sp. J. All rights reserved.