



GASTROPARTS

Bonnet

[EN] Cooking

[DE] Kochtechnik

[ES] Cocción

[FR] Cuisson

[IT] Cottura

[PL] Obróbka termiczna

[RU] Термическая обработка

✉ gastroparts@gastroparts.com

☎ tel. +48 56 657 00 66

📘 fb.com/gastroparts.global

GASTROPARTS.COM





heating elements

immersion heating elements

with compression flange 50 x 26mm



| | | | |
|-----------------|--------|-----------------|--------|
| Part No. | 418932 | Ref. No. | 71244E |
|-----------------|--------|-----------------|--------|

| | | | |
|--------------------|---|--|--|
| description | heating element 2000W 240V heating circuits 1 flange 50x26mm L 350mm W 30mm Hmm compression flange connection male faston 6.3mm tube ø 6.3mm immersion heater | | |
|--------------------|---|--|--|

heating elements for convection

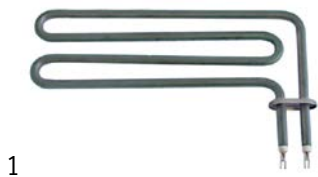

| | | | |
|-----------------|--------|-----------------|----------------------|
| Part No. | 418925 | Ref. No. | 71844E BAAN309621 |
|-----------------|--------|-----------------|----------------------|

| | | | |
|--------------------|---|--|--|
| description | heating element 1500W 230V heating circuits 1 L 293mm W 106mm L1 32mm L2 261mm W2 83mm flange length 50mm flange width 26mm connection length 63mm connection male faston 6.3mm tube ø 8.5mm hole ø 6.2mm W1 23mm convection heating element convection oven INCOLOY windings 2 | | |
|--------------------|---|--|--|

| | | | |
|------------------------|--------|--|--|
| accessories for | 418925 | | |
|------------------------|--------|--|--|



| | | | |
|--------------------|--|-----------------|---|
| Part No. | 520588 | Ref. No. | — |
| description | gasket L 46mm W 22mm hole distance 24.5mm silicone for heating element | | |

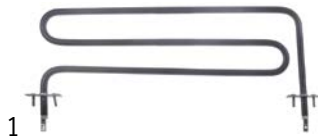

| | | | |
|-----------------|--------|-----------------|--------|
| Part No. | 418933 | Ref. No. | 71240E |
|-----------------|--------|-----------------|--------|

| | | | |
|--------------------|--|--|--|
| description | heating element 2000W 240V heating circuits 1 L 390mm W 134mm W2 100mm flange length 50mm flange width 20mm connection length 50mm connection M4 tube ø 10mm thread M4 W1 34mm rectangular flange convection heating element convection oven | | |
|--------------------|--|--|--|



| | | | |
|-----------------|--------|-----------------|--------------------------------|
| Part No. | 418917 | Ref. No. | 309252 71241E BAAN71241E |
|-----------------|--------|-----------------|--------------------------------|

| | | | |
|--------------------|--|--|--|
| description | heating element 3000W 240V heating circuits 3 L 570mm W 140mm W2 110mm flange length 110mm flange width 20mm hole distance 40mm connection length 55mm connection M4 tube ø 10mm thread M4 W1 30mm rectangular flange convection heating element convection oven | | |
|--------------------|--|--|--|



| | | | |
|-----------------|--------|-----------------|----------------------|
| Part No. | 418918 | Ref. No. | 71242E BAAN309253 |
|-----------------|--------|-----------------|----------------------|

| | | | |
|--------------------|--|--|--|
| description | heating element 4000W 240V heating circuits 3 L 570mm W 140mm W2 110mm flange length 110mm flange width 20mm hole distance 40mm connection length 55mm connection M4 tube ø 10mm thread M4 W1 30mm rectangular flange convection heating element convection oven | | |
|--------------------|--|--|--|

accessories

sealing washers

O-rings

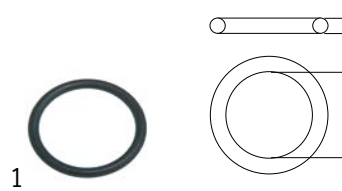

| | | | |
|-----------------|--------|-----------------|----------|
| Part No. | 510408 | Ref. No. | 2001827H |
|-----------------|--------|-----------------|----------|

| | | | |
|--------------------|--|--|--|
| description | O-ring EPDM thickness 5.34mm ID ø 47mm Qty 1 pcs | | |
|--------------------|--|--|--|

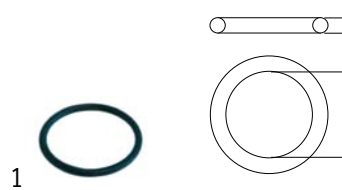

| | | | |
|-----------------|--------|-----------------|---|
| Part No. | 510409 | Ref. No. | 318044 905588 966001 BAAN1323306 BAAN311999 |
|-----------------|--------|-----------------|---|

| | | | |
|--------------------|---|--|--|
| description | O-ring EPDM thickness 5.34mm ID ø 56.52mm Qty 1 pcs | | |
|--------------------|---|--|--|

energy regulators

EGO

1-circuit



| | | | |
|-----------------|--------|-----------------|---|
| Part No. | 380015 | Ref. No. | 1800602 301200 70486E 72113E BAAN167036 BAAN304497 |
|-----------------|--------|-----------------|---|

| | | | |
|--------------------|---|--|--|
| description | energy regulator 230V 13A single-circuit turn direction right shaft ø 6x4.6mm shaft L 23mm mounting thread M4 power release 6-100% no. 50.57021.010 | | |
|--------------------|---|--|--|



thermostats

bi-metal thermostats

bi-metal thermostats



1

| | | | |
|--------------------|--|-----------------|--------|
| Part No. | 375927 | Ref. No. | 301045 |
| description | bi-metal thermostat hole distance 23.5mm switch-off temp. 50°C 1NO 10A connection F6.3 | | |

control and safety thermostats

EGO

control thermostats

55.10/19_ series



1

| | | | |
|--------------------|--|-----------------|--------------------------------------|
| Part No. | 375002 | Ref. No. | 7471032 BAAN1209939 BAAN310615 |
| description | thermostat t.max. 320°C temperature range 55-320°C 1-pole 1NO 16A probe ø 3.1mm probe L 226mm capillary pipe 870mm capillary pipe isolated 850mm gland nut shaft L 23mm shaft position upper rotation 270° | | |

safety thermostats

55.13_ series



1

| | | | |
|--------------------|--|-----------------|------------------|
| Part No. | 375830 | Ref. No. | 905866 905886 |
| description | safety thermostat switch-off temp. 365°C 1-pole 1NC 16A probe ø 3mm probe L 160mm capillary pipe 1730mm capillary pipe isolated 1710mm gland nut probe | | |

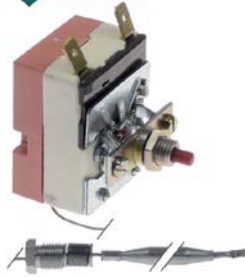

1

| | | | |
|--------------------|--|-----------------|--------|
| Part No. | 390801 | Ref. No. | 71280E |
| description | thermostat switch-off temp. 140°C 1-pole 16A probe ø 6mm probe L 78mm capillary pipe 1500mm capillary pipe isolatedmm gland nut probe connection male faston 6.3mm | | |

55.32_ series



1

| | | | |
|--------------------|--|-----------------|------------------------------------|
| Part No. | 375984 | Ref. No. | 301061 BAAN171095 BAAN304480 |
| description | safety thermostat switch-off temp. 225°C 3-pole 3NC 20A probe ø 6mm probe L 94mm capillary pipe 900mm capillary pipe isolated 670mm gland nut M10x1 probe SS | | |





1

| | | | |
|--------------------|--|-----------------|------------------------------------|
| Part No. | 375706 | Ref. No. | 301049 BAAN169338 BAAN304476 |
| description | safety thermostat switch-off temp. 400°C 3-pole 3NC 20A probe ø 3.9mm probe L 228mm capillary pipe 1190mm capillary pipe isolatedmm gland nut probe SS | | |

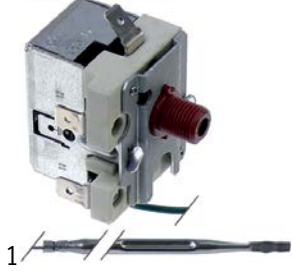

56._ series



| | | | |
|---|--|-----------------|--|
| Part No. | 375442 | Ref. No. | 301039 301066 BAAN172196 BAAN304485 |
| description | safety thermostat capillary pipe 1760mm probe ø 4mm 1-pole probe L 100mm 16A capillary pipe isolated 1600mm gland nut switch-off temp. 320°C probe M10x1 | | |
| accessories for | 375442 | | |
|  | Part No. | 101860 | Ref. No. — |
| | nut thread M10x1 H 4mm WS 14 chrome-plated brass Qty 1 pcs | | |

control thermostats with operation switch

55.34_ series

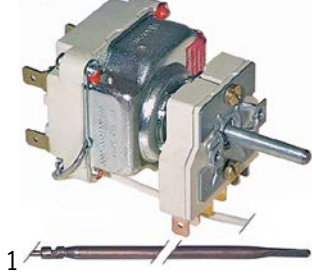

| | | | |
|--------------------|---|-----------------|--------|
| Part No. | 375246 | Ref. No. | 301034 |
| description | thermostat t.max. 645°C temperature range 100-615/645°C 2-pole 2NO 16A probe ø 4mm probe L 230mm capillary pipe 1100mm capillary pipe isolated 600mm gland nut shaft ø 6x4.6mm shaft L 25mm shaft position lower rotation 270° outer switch 2NO probe material copper | | |

accessories

gland nut accessories

ducts



| | | | |
|--------------------|--|-----------------|---------------------------------------|
| Part No. | 550148 | Ref. No. | 91373062 BAAN1323396 BAAN312763 |
| description | gland duct ET M12x0.75 IT M9x1 probe ø max. 6.5mm WS 17 silicone | | |

connecting bows



| | | | |
|--------------------|--|-----------------|--------|
| Part No. | 550060 | Ref. No. | 300177 |
| description | connecting bow long for thermostat Qty 1 pcs | | |

switches and momentary switches

rocker/momentary rocker switches

30x22mm



| | | | |
|--------------------|--|-----------------|--------|
| Part No. | 301202 ¹ | Ref. No. | 905913 |
| description | rocker switch mounting measurements 30x22mm black 2NO 230V 20A 0-1 connection male faston 6.3mm ambient temperature max. 125/55°C protection IP65 with rubber collar | | |

¹non-illuminated

microswitches

lever actuated



| | | | |
|--------------------|---|-----------------|-------------------------------|
| Part No. | 345257 | Ref. No. | 300688 3755E BAAN305693 |
| description | microswitch with lever 250V 16A 1CO connection male faston 6.3mm L 29mm L1 33mm ambient temperature max. 120°C mounting distance 22mm actuating force: 130g lever length 31.5mm | | |



pin-plunger actuated

M10





| | | | |
|--------------------|---|-----------------|--------|
| Part No. | 345032 | Ref. No. | 303621 |
| description | microswitch with plunger thread M10x1 thread L 12mm 250V 16A 1CO connection male faston 6.3mm stroke 7mm mounting distance 22mm L 28mm ambient temperature max. 125°C type SP9603 actuating force: 180g | | |





| | | | |
|--|---|-----------------|--------------------------------------|
| M12 | | | |
|  <p>1</p> | | | |
| Part No. | 345350 | Ref. No. | 1700340 BAAN1320656 BAAN302929 |
| description | microswitch with plunger mounting distance 22mm thread M12x0.75 thread L 16mm 250V 16A 1CO connection male faston 6.3mm stroke 4mm ambient temperature max. 125°C type EF83161.3 actuating force: 66g | | |
| accessories for | 345350 | | |
| | Part No. | 345351 | Ref. No. — |
| |  <p>nut thread M12x0.75 H 1.6mm WS 14 chrome-plated brass Qty 1 pcs</p> | | |

system switches (ROLD)

| | | | |
|--|---|-----------------|--------|
|  <p>1</p> | | | |
| Part No. | 345536 | Ref. No. | 900162 |
| description | element holder mounting \varnothing 16mm flat black | | |

| | | | |
|--|---|-----------------|----------|
|  <p>1</p> | | | |
| Part No. | 345606 | Ref. No. | 2001544H |
| description | momentary switch unit 2CO 250V 16A connection male faston 6.3mm | | |

| | | | |
|--|--|-----------------|--------|
|  <p>1</p> | | | |
| Part No. | 345538 | Ref. No. | 900163 |
| description | push button \varnothing 11.9mm black | | |

| | | | |
|--|--|-----------------|-------------------------------------|
|  <p>1</p> | | | |
| Part No. | 345651 | Ref. No. | 900053 BAAN1323148 BAAN311603 |
| description | switch 2CO 250V 16A connection male faston 6.3mm | | |

cam switches

7-position

| | | | |
|---|---|-----------------|------------------------------------|
|  <p>1</p> | | | |
| Part No. | 300106 | Ref. No. | 300010 BAAN166926 BAAN304345 |
| description | cam switch 7 operating positions 1NO/2CO sequence 0-1-2-3-4-5-6 32A shaft \varnothing 6x4.6mm shaft L 23mm connection screw 7-position shaft flat upper | | |

magnetic switches

accessories

magnets

| | | | |
|--|---|-----------------|---------------------------------------|
|  <p>1</p> | | | |
| Part No. | 345336 | Ref. No. | 2001868H BAAN1321497 BAAN307903 |
| description | magnet \varnothing 4.8mm L 63mm H 11mm W 18.8mm hole distance 51mm M4 | | |

encoders and potentiometers

| | | | |
|---|---------------|-----------------|------------------------------------|
|  <p>1</p> | | | |
| Part No. | 300265 | Ref. No. | 309411 BAAN172230 BAAN701367 |
| description | potentiometer | | |



lamps

indicator lights

indicator lights 3-piece (housing, lens and bulb)

lamps

neon light bulbs



1

| | | | |
|-----------------|--------|-----------------|----------|
| Part No. | 359585 | Ref. No. | 74540008 |
|-----------------|--------|-----------------|----------|

| | | | |
|--------------------|---|--|--|
| description | neon light bulb socket E10 230V green ø 10mm L 28mm | | |
|--------------------|---|--|--|

| | | | |
|------------------------|--------|--|--|
| accessories for | 359585 | | |
|------------------------|--------|--|--|



| | | | |
|--------------------|---|-----------------|---|
| Part No. | 359060 | Ref. No. | — |
| description | lamp socket mounting measurements ø16.2mm socket E10 connection screw | | |



| | | | |
|--------------------|--|-----------------|---|
| Part No. | 359685 | Ref. No. | — |
| description | lamp socket mounting measurements ø16.2mm socket E10 | | |

indicator lights (complete)

ø 6mm



1

| | | | |
|-----------------|--------|-----------------|----------|
| Part No. | 359005 | Ref. No. | 2002147H |
|-----------------|--------|-----------------|----------|

| | | | |
|--------------------|--|--|--|
| description | indicator light ø 6mm 230V yellow cable length 400mm | | |
|--------------------|--|--|--|

ø12mm

with plug-in socket



1

| | | | |
|-----------------|--------|-----------------|------------------------------------|
| Part No. | 359925 | Ref. No. | 308334 BAAN167305 BAAN304818 |
|-----------------|--------|-----------------|------------------------------------|

| | | | |
|--------------------|--|--|--|
| description | indicator light ø 12mm 400V green connection 2-wire cable length 700mm temp.-resist. 150°C | | |
|--------------------|--|--|--|

ø13mm

with plug-in socket



1

| | | | |
|-----------------|--------|-----------------|---|
| Part No. | 359143 | Ref. No. | 904300 904360 BAAN1323249 BAAN311747 |
|-----------------|--------|-----------------|---|

| | | | |
|--------------------|---|--|--|
| description | indicator light ø 13mm yellow 230V connection male faston 6.3mm temp.-resist. 120°C Qty 1 pcs | | |
|--------------------|---|--|--|

30x22mm



1

| | | | |
|-----------------|--------|-----------------|---------|
| Part No. | 359156 | Ref. No. | S175P15 |
|-----------------|--------|-----------------|---------|

| | | | |
|--------------------|--|--|--|
| description | indicator light mounting measurements 30x22mm 230V yellow connection male faston 6.3mm temp.-resist. 125/55°C type RL2 | | |
|--------------------|--|--|--|

screw-on/push-on fit

neon light bulbs



1

| | | | |
|-----------------|--------|-----------------|----------|
| Part No. | 359585 | Ref. No. | 74540008 |
|-----------------|--------|-----------------|----------|

| | | | |
|--------------------|---|--|--|
| description | neon light bulb socket E10 230V green ø 10mm L 28mm | | |
|--------------------|---|--|--|

| | | | |
|------------------------|--------|--|--|
| accessories for | 359585 | | |
|------------------------|--------|--|--|



| | | | |
|--------------------|---|-----------------|---|
| Part No. | 359060 | Ref. No. | — |
| description | lamp socket mounting measurements ø16.2mm socket E10 connection screw | | |



| | | | |
|--------------------|--|-----------------|---|
| Part No. | 359685 | Ref. No. | — |
| description | lamp socket mounting measurements ø16.2mm socket E10 | | |

light bulbs

for ovens



1

| | | | |
|-----------------|--------|-----------------|--------|
| Part No. | 359610 | Ref. No. | 70597E |
|-----------------|--------|-----------------|--------|

| | | | |
|--------------------|--|--|--|
| description | light bulb t.max. 300°C socket E14 15W 230V ø 22mm L 47mm lens L 20mm for oven lamp type Philips | | |
|--------------------|--|--|--|



1

| | | | |
|-----------------|--------|-----------------|--------|
| Part No. | 357153 | Ref. No. | 70598E |
|-----------------|--------|-----------------|--------|

| | | | |
|--------------------|---|--|--|
| description | light bulb t.max. 300°C socket E14 25W 230V ø 25mm L 55mm lens L 30mm for oven type | | |
|--------------------|---|--|--|





1

| | | | |
|-----------------|--------|-----------------|--------|
| Part No. | 359614 | Ref. No. | 308463 |
|-----------------|--------|-----------------|--------|

| | | | |
|--------------------|---|--|--|
| description | light bulb t.max. 300°C socket E27 230V 40W ø 45mm L 71mm lens L 44mm Qty 1 pcs | | |
|--------------------|---|--|--|



| halogen lamp | | | |
|---|--|-----------------|------------------------------------|
| for socket G4 / G6.35 / G9 | | | |
|  <p>1 500°C</p> | | | |
| Part No. | 359599 | Ref. No. | 308477 BAAN172222 BAAN304831 |
| description | halogen lamp socket G4 12V 20W temp.-resist. 500°C | | |

| halogen lamps | | | |
|---|--|-----------------|------------------------------------|
| for socket G4 / G6.35 / G9 | | | |
|  <p>1 500°C</p> | | | |
| Part No. | 359599 | Ref. No. | 308477 BAAN172222 BAAN304831 |
| description | halogen lamp socket G4 12V 20W temp.-resist. 500°C | | |

fluorescent lamps

| fluorescent lamps | | | |
|--|--|-----------------|--|
| G23 | | | |
|  <p>1</p> | | | |
| Part No. | 359933 | Ref. No. | 309597 71819E BAAN309597 BAAN71819E |
| description | fluorescent lamp socket G23 L 237mm 11W 230V | | |

| sockets | | | |
|--|---|-----------------|--------|
| G4 / G5,3 / G6,35 | | | |
|  <p>1</p> | | | |
| Part No. | 359646 | Ref. No. | 147328 |
| description | lamp socket socket G4/G5.3/G6.35 24V ø 17mm H 15mm connection cable 130mm mounting distance 26mm for halogen lamp holder length 31mm cable length 130mm | | |

oven lamps

| lamps | | | |
|--|--|-----------------|--------|
| light bulbs | | | |
|  <p>1</p> | | | |
| Part No. | 359610 | Ref. No. | 70597E |
| description | light bulb t.max. 300°C socket E14 15W 230V ø 22mm L 47mm lens L 20mm for oven lamp type Philips | | |

alarm devices

| buzzers | | | |
|--|--|-----------------|--------|
|  <p>1</p> | | | |
| Part No. | 350050 | Ref. No. | 305106 |
| description | buzzer 230VAC connection male faston 6.3mm screw mounting thread M4 60dB | | |

| | | | |
|--|---|-----------------|--------|
|  <p>1</p> | | | |
| Part No. | 357153 | Ref. No. | 70598E |
| description | light bulb t.max. 300°C socket E14 25W 230V ø 25mm L 55mm lens L 30mm for oven type | | |

contactors

| power contactors | | | |
|---|--|-----------------|----------|
|  <p>1</p> | | | |
| Part No. | 380957 | Ref. No. | 2001138H |
| description | power contactor resistive load 22A 24VAC (AC3/400V) 12A/5.5kW main contacts 3NO auxiliary contacts 1NO connection screw connection type 3RT10-17-1AB01 50/60Hz | | |

| | | | |
|--|---|-----------------|--------|
|  <p>1</p> | | | |
| Part No. | 359614 | Ref. No. | 308463 |
| description | light bulb t.max. 300°C socket E27 230V 40W ø 45mm L 71mm lens L 44mm Qty 1 pcs | | |



TELEMECANIQUE (Schneider Electric)

power contactors



1

| | | | |
|--------------------|---|-----------------|---------|
| Part No. | 380617 | Ref. No. | 1700468 |
| description | power contactor resistive load 25A 24VAC (AC3/400V) 9A/4kW main contacts 3NO auxiliary contacts 1NO/1NC connection screw connection type LC1D09B7 | | |



1

| | | | |
|--------------------|---|-----------------|-------------------|
| Part No. | 380976 | Ref. No. | 1700732 300698 |
| description | power contactor resistive load 32A 230VAC (AC3/400V) 18A/7.5kW main contacts 3NO auxiliary contacts 1NO/1NC connection screw connection | | |



1

| | | | |
|--------------------|--|-----------------|---|
| Part No. | 380979 | Ref. No. | 300697 300699 300760 5875E 900130 905239 905241 905686 906759 910566 BAAN1322995 BAAN169330 BAAN304436 BAANS084P20 |
| description | power contactor resistive load 40A 230VAC (AC3/400V) 25A/11kW main contacts 3NO auxiliary contacts 1NO/1NC connection screw connection type LC1D25P7 | | |



1

| | | | |
|--------------------|--|-----------------|--------|
| Part No. | 380980 | Ref. No. | 300700 |
| description | power contactor resistive load 50A 230VAC (AC3/400V) 32A/15kW main contacts 3NO auxiliary contacts 1NO/1NC connection screw connection type LC1D32P7 | | |

relays

power relays

with bracket mounting



1

| | | | |
|--------------------|--|-----------------|----------------------|
| Part No. | 380312 | Ref. No. | 2001867H 2001887H |
| description | power relays FINDER 230VAC 10A 3CO connection male faston 4.8mm bracket mounting dimensions 52x32.2x36.5mm manuf. no. 60.63.8.230.0000 | | |





1

| | | | |
|--------------------|---|-----------------|----------|
| Part No. | 380139 | Ref. No. | 2001873H |
| description | power relays FINDER 230VAC 16A 2CO connection F6.3 bracket mounting dimensions 68x38.2x35.8mm manuf. no. 62.82.8.230.0000 | | |





| | | | |
|---|---|-----------------|---|
|  | | | |
| 1 | | | |
| Part No. | 380403 | Ref. No. | 2001258H 2001873H 900073 BAAN1323154 BAAN311608 |
| description | power relays FINDER 230VAC 16A 3CO connection F6.3 bracket mounting manuf. no. 62.83.8.230.0500 | | |

| | | | |
|---|---|-----------------|----------|
|  | | | |
| 2 | | | |
| Part No. | 380702 | Ref. No. | 2002044H |
| description | power relays FINDER 230VAC 16A 3NO connection male faston 6.3mm flange dimensions 36x38x68mm manuf. no. 62.83.8.230.0300 230V | | |

| | | | |
|---|--|-----------------|---|
|  | | | |
| 1 | | | |
| Part No. | 380185 | Ref. No. | 2001929h 300283 BAAN1027526 BAAN171090 BAAN304383 |
| description | power relays Italiana Relè 230VAC 30A 1NO connection F6.3 bracket mounting dimensions 36.5x32.2x51.8mm manuf. no. A10-230AC-FA | | |

relay sockets

| | | | |
|---|--|-----------------|-------|
|  | | | |
| 1 | | | |
| Part No. | 380137 | Ref. No. | 5937E |
| description | relay socket 8-pole connection plug-in connection round 8-pole dimensions 65x28x40mm 380V voltage AC 10A Italiana Relè manuf. no. ZVE8 | | |
| accessories for | 380137 | | |
| | Part No. | Ref. No. | — |
|  | 380805 | | |
| | support bracket | | |

transformers

open transformers

with plug connection





| | | | |
|--|---|-----------------|--------|
|  | | | |
| 1 | | | |
| Part No. | 400956 | Ref. No. | 308479 |
| description | transformer primary 230VAC secondary 12VAC 20VA connection male faston 6.3mm 50/60Hz type T602012/E temperature restriction 150°C ambient temperature max. 80°C | | |

electronic controllers

EVCO - EVERY CONTROL

universal controllers

built-in version

| | | | |
|---|--|-----------------|-------------------|
|  | | | |
| 1 | | | |
| Part No. | 378131 | Ref. No. | 651225 S225P20 |
| description | electronic controller EVERY CONTROL EVK411M mounting measurements 71x29mm 12V voltage AC/DC NTC/PTC/Pt100/Pt1000 relay outputs 1 CO-16A(8) NTC/PTC/Pt100/Pt1000/TC(J,K)/mV/mA yes protection IP65 dependend on probe°C display 3½ digits | | |
| accessories for | 378131 | | |
| | Part No. | Ref. No. | — |
|  | 379050 | | |
| | temperature probe Pt100 cable Vetrotex probe -200 up to +600°C cable -50 up to +350°C probe ø6x100mm cable length 2.7m without screw connection 3-wire | | |
| | Part No. | Ref. No. | — |
|  | 379160 | | |
| | temperature probe NTC 10kOhm cable thermoplastic probe -40 up to +110°C cable -40 up to +110°C probe ø6x14mm cable length 1.5m without screw connection 2-wire | | |
| | Part No. | Ref. No. | — |
|  | 379781 | | |
| | temperature probe PTC 1kOhm cable thermoplastic probe -50 up to +150°C cable -40 up to +110°C probe ø6x14mm cable length 1.5m without screw connection 2-wire | | |
| | Part No. | Ref. No. | — |
|  | 379944 | | |
| | temperature probe Pt1000 cable Vetrotex probe -70 up to +500°C cable -50 up to +350°C connection 2-wire thread probe ø6x180mm cable length 1.7m | | |



solenoid valves

solenoid valves (water)

ELBI



1

| | | | |
|--------------------|--|-----------------|--------|
| Part No. | 373020 | Ref. No. | 241447 |
| description | solenoid valve double angled 230VAC inlet 3/4" outlet 14mm input 10l/min DN10 t.max. 90°C duty cycle 100% ELBI flow regulating valve inlet white | | |

ROBERTSHAW/INVENSY

medium temperature: 90°C 90°C 60°C
 ambient temperature: 60°C 25°C 60°C
 duty cycle: 40% 100% 100%



1

| | | | |
|--------------------|--|-----------------|------------------------------------|
| Part No. | 372017 | Ref. No. | 144937 BAAN171061 BAAN302233 |
| description | solenoid valve single straight 230VAC inlet 3/4" outlet 11.5mm DN10 EATON (INVENSYS) | | |

TP





1















| | | | |
|--------------------|--|-----------------|---|
| Part No. | 370021 | Ref. No. | 1700434 3697E BAAN1320666 BAAN302969 |
| description | solenoid valve double straight 230VAC inlet 3/4" outlet 11.5mm DN10 TP flow regulating valve inlet white | | |

spare parts for 370021

| | | | | |
|---|-----------------|--------|-----------------|---|
|  | Part No. | 371013 | Ref. No. | — |
| solenoid coil TP 230VAC 50/60Hz | | | | |

accessories for 370021

| | | | | |
|---|-----------------|--------|-----------------|---|
|  | Part No. | 371220 | Ref. No. | — |
| reducer TP flow rate 3l/min red tolerance ±15% | | | | |
|  | Part No. | 371221 | Ref. No. | — |
| reducer TP flow rate 5.5l/min yellow tolerance ±15% | | | | |
|  | Part No. | 371222 | Ref. No. | — |
| reducer TP flow rate 6l/min grey tolerance ±15% | | | | |

| | | | | |
|---|--|-----------------|-----------------|---|
| accessories for 370021 | Part No. | 371223 | Ref. No. | — |
|  | reducer TP flow rate 10l/min white tolerance ±15% | | | |
| Part No. | 371224 | Ref. No. | — | — |
|  | reducer TP flow rate 12l/min bronze tolerance ±15% | | | |
| Part No. | 371225 | Ref. No. | — | — |
|  | reducer TP flow rate 16l/min light brown tolerance ±15% | | | |
| Part No. | 371226 | Ref. No. | — | — |
|  | reducer TP flow rate 20l/min red tolerance ±15% | | | |
| Part No. | 371230 | Ref. No. | — | — |
|  | reducer TP flow rate 0.25l/min red tolerance ±25% | | | |
| Part No. | 371231 | Ref. No. | — | — |
|  | reducer TP flow rate 0.35l/min violet tolerance ±25% | | | |
| Part No. | 371232 | Ref. No. | — | — |
|  | reducer TP flow rate 0.5l/min orange tolerance ±25% | | | |
| Part No. | 371233 | Ref. No. | — | — |
|  | reducer TP flow rate 0.8l/min white tolerance ±25% | | | |
| Part No. | 371234 | Ref. No. | — | — |
|  | reducer TP flow rate 1l/min light blue tolerance ±25% | | | |
| Part No. | 371235 | Ref. No. | — | — |
|  | reducer TP flow rate 1.2l/min brown tolerance ±25% | | | |
| Part No. | 371236 | Ref. No. | — | — |
|  | reducer TP flow rate 1.5l/min light brown tolerance ±25% | | | |
| Part No. | 371237 | Ref. No. | — | — |
|  | reducer TP flow rate 2.5l/min yellow tolerance ±25% | | | |
| Part No. | 371238 | Ref. No. | — | — |
|  | reducer TP flow rate 3.4l/min dark green tolerance ±25% | | | |
| Part No. | 371239 | Ref. No. | — | — |
|  | reducer TP flow rate 5l/min black tolerance ±25% | | | |
| Part No. | 371240 | Ref. No. | — | — |
|  | reducer TP flow rate 8l/min blue tolerance ±20% | | | |



| | | | | |
|---|-----------------|--------|-----------------|--------|
|  | Part No. | 370017 | Ref. No. | 634084 |
| description solenoid valve single straight 230VAC inlet 3/4" outlet 11.5mm DN10 TP p max 10bar | | | | |
| spare parts for 370017 | | | | |
|  | Part No. | 371013 | Ref. No. | — |
| solenoid coil TP 230VAC 50/60Hz | | | | |

Table continues overleaf





| accessories for | | 370017 | | |
|---|----------|--------|----------|---|
|  | Part No. | 371220 | Ref. No. | — |
| reducer TP flow rate 3l/min red tolerance ±15% | | | | |
|  | Part No. | 371221 | Ref. No. | — |
| reducer TP flow rate 5.5l/min yellow tolerance ±15% | | | | |
|  | Part No. | 371222 | Ref. No. | — |
| reducer TP flow rate 6l/min grey tolerance ±15% | | | | |
|  | Part No. | 371223 | Ref. No. | — |
| reducer TP flow rate 10l/min white tolerance ±15% | | | | |
|  | Part No. | 371224 | Ref. No. | — |
| reducer TP flow rate 12l/min bronze tolerance ±15% | | | | |
|  | Part No. | 371225 | Ref. No. | — |
| reducer TP flow rate 16l/min light brown tolerance ±15% | | | | |
|  | Part No. | 371226 | Ref. No. | — |
| reducer TP flow rate 20l/min red tolerance ±15% | | | | |
|  | Part No. | 371230 | Ref. No. | — |
| reducer TP flow rate 0.25l/min red tolerance ±25% | | | | |
|  | Part No. | 371231 | Ref. No. | — |
| reducer TP flow rate 0.35l/min violet tolerance ±25% | | | | |
|  | Part No. | 371232 | Ref. No. | — |
| reducer TP flow rate 0.5l/min orange tolerance ±25% | | | | |
|  | Part No. | 371233 | Ref. No. | — |
| reducer TP flow rate 0.8l/min white tolerance ±25% | | | | |
|  | Part No. | 371234 | Ref. No. | — |
| reducer TP flow rate 1l/min light blue tolerance ±25% | | | | |
|  | Part No. | 371235 | Ref. No. | — |
| reducer TP flow rate 1.2l/min brown tolerance ±25% | | | | |
|  | Part No. | 371236 | Ref. No. | — |
| reducer TP flow rate 1.5l/min light brown tolerance ±25% | | | | |
|  | Part No. | 371237 | Ref. No. | — |
| reducer TP flow rate 2.5l/min yellow tolerance ±25% | | | | |
|  | Part No. | 371238 | Ref. No. | — |
| reducer TP flow rate 3.4l/min dark green tolerance ±25% | | | | |
|  | Part No. | 371239 | Ref. No. | — |
| reducer TP flow rate 5l/min black tolerance ±25% | | | | |
|  | Part No. | 371240 | Ref. No. | — |
| reducer TP flow rate 8l/min blue tolerance ±20% | | | | |



| | | | |
|---|--|-----------------|----------|
|   1 | | | |
| Part No. | 370018 | Ref. No. | 904693 |
| description | solenoid valve single straight 230VAC inlet 3/4" outlet 14mm DN10 TP | | |
| spare parts for | 370018 | | |
|  | Part No. | 371013 | Ref. No. |
| solenoid coil TP 230VAC 50/60Hz | | | |
| accessories for | 370018 | | |
|  | Part No. | 371220 | Ref. No. |
| reducer TP flow rate 3l/min red tolerance ±15% | | | |
|  | Part No. | 371221 | Ref. No. |
| reducer TP flow rate 5.5l/min yellow tolerance ±15% | | | |
|  | Part No. | 371222 | Ref. No. |
| reducer TP flow rate 6l/min grey tolerance ±15% | | | |
|  | Part No. | 371223 | Ref. No. |
| reducer TP flow rate 10l/min white tolerance ±15% | | | |
|  | Part No. | 371224 | Ref. No. |
| reducer TP flow rate 12l/min bronze tolerance ±15% | | | |
|  | Part No. | 371225 | Ref. No. |
| reducer TP flow rate 16l/min light brown tolerance ±15% | | | |
|  | Part No. | 371226 | Ref. No. |
| reducer TP flow rate 20l/min red tolerance ±15% | | | |
|  | Part No. | 371230 | Ref. No. |
| reducer TP flow rate 0.25l/min red tolerance ±25% | | | |
|  | Part No. | 371231 | Ref. No. |
| reducer TP flow rate 0.35l/min violet tolerance ±25% | | | |
|  | Part No. | 371232 | Ref. No. |
| reducer TP flow rate 0.5l/min orange tolerance ±25% | | | |
|  | Part No. | 371233 | Ref. No. |
| reducer TP flow rate 0.8l/min white tolerance ±25% | | | |
|  | Part No. | 371234 | Ref. No. |
| reducer TP flow rate 1l/min light blue tolerance ±25% | | | |
|  | Part No. | 371235 | Ref. No. |
| reducer TP flow rate 1.2l/min brown tolerance ±25% | | | |
|  | Part No. | 371236 | Ref. No. |
| reducer TP flow rate 1.5l/min light brown tolerance ±25% | | | |
|  | Part No. | 371237 | Ref. No. |
| reducer TP flow rate 2.5l/min yellow tolerance ±25% | | | |

Table continues overleaf



| accessories for 370018 | | | | |
|---|---|--------|----------|---|
|  | Part No. | 371238 | Ref. No. | — |
| | reducer TP flow rate 3.4l/min dark green tolerance ±25% | | | |
|  | Part No. | 371239 | Ref. No. | — |
| | reducer TP flow rate 5l/min black tolerance ±25% | | | |
|  | Part No. | 371240 | Ref. No. | — |
| | reducer TP flow rate 8l/min blue tolerance ±20% | | | |



| | | | | |
|---|--|-----------------|-------------------------------|---|
| Part No. | 370025 | Ref. No. | 314345 3664E BAAN305607 | |
| description | solenoid valve triple straight 230VAC inlet 3/4" outlet 11.5mm DN10 TP | | | |
| spare parts for | 370025 | | | |
|  | Part No. | 371013 | Ref. No. | — |
| | solenoid coil TP 230VAC 50/60Hz | | | |
| accessories for | 370025 | | | |
|  | Part No. | 371220 | Ref. No. | — |
| | reducer TP flow rate 3l/min red tolerance ±15% | | | |
|  | Part No. | 371221 | Ref. No. | — |
| | reducer TP flow rate 5.5l/min yellow tolerance ±15% | | | |
|  | Part No. | 371222 | Ref. No. | — |
| | reducer TP flow rate 6l/min grey tolerance ±15% | | | |
|  | Part No. | 371223 | Ref. No. | — |
| | reducer TP flow rate 10l/min white tolerance ±15% | | | |
|  | Part No. | 371224 | Ref. No. | — |
| | reducer TP flow rate 12l/min bronze tolerance ±15% | | | |
|  | Part No. | 371225 | Ref. No. | — |
| | reducer TP flow rate 16l/min light brown tolerance ±15% | | | |
|  | Part No. | 371226 | Ref. No. | — |
| | reducer TP flow rate 20l/min red tolerance ±15% | | | |
|  | Part No. | 371230 | Ref. No. | — |
| | reducer TP flow rate 0.25l/min red tolerance ±25% | | | |
|  | Part No. | 371231 | Ref. No. | — |
| | reducer TP flow rate 0.35l/min violet tolerance ±25% | | | |
|  | Part No. | 371232 | Ref. No. | — |
| | reducer TP flow rate 0.5l/min orange tolerance ±25% | | | |
|  | Part No. | 371233 | Ref. No. | — |
| | reducer TP flow rate 0.8l/min white tolerance ±25% | | | |

| accessories for 370025 | | | | |
|---|--|--------|----------|---|
|  | Part No. | 371234 | Ref. No. | — |
| | reducer TP flow rate 1l/min light blue tolerance ±25% | | | |
|  | Part No. | 371235 | Ref. No. | — |
| | reducer TP flow rate 1.2l/min brown tolerance ±25% | | | |
|  | Part No. | 371236 | Ref. No. | — |
| | reducer TP flow rate 1.5l/min light brown tolerance ±25% | | | |
|  | Part No. | 371237 | Ref. No. | — |
| | reducer TP flow rate 2.5l/min yellow tolerance ±25% | | | |
|  | Part No. | 371238 | Ref. No. | — |
| | reducer TP flow rate 3.4l/min dark green tolerance ±25% | | | |
|  | Part No. | 371239 | Ref. No. | — |
| | reducer TP flow rate 5l/min black tolerance ±25% | | | |
|  | Part No. | 371240 | Ref. No. | — |
| | reducer TP flow rate 8l/min blue tolerance ±20% | | | |

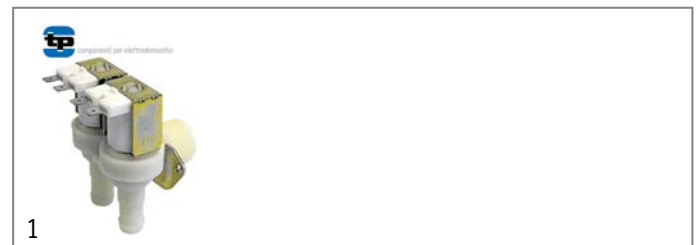





























| | | | | |
|---|--|-----------------|----------|---|
| Part No. | 370020 | Ref. No. | 914123 | |
| description | solenoid valve double angled 230VAC inlet 3/4" outlet 14mm DN10 TP | | | |
| spare parts for | 370020 | | | |
|  | Part No. | 371013 | Ref. No. | — |
| | solenoid coil TP 230VAC 50/60Hz | | | |
| accessories for | 370020 | | | |
|  | Part No. | 371220 | Ref. No. | — |
| | reducer TP flow rate 3l/min red tolerance ±15% | | | |
|  | Part No. | 371221 | Ref. No. | — |
| | reducer TP flow rate 5.5l/min yellow tolerance ±15% | | | |
|  | Part No. | 371222 | Ref. No. | — |
| | reducer TP flow rate 6l/min grey tolerance ±15% | | | |
|  | Part No. | 371223 | Ref. No. | — |
| | reducer TP flow rate 10l/min white tolerance ±15% | | | |
|  | Part No. | 371224 | Ref. No. | — |
| | reducer TP flow rate 12l/min bronze tolerance ±15% | | | |
|  | Part No. | 371225 | Ref. No. | — |
| | reducer TP flow rate 16l/min light brown tolerance ±15% | | | |
|  | Part No. | 371226 | Ref. No. | — |
| | reducer TP flow rate 20l/min red tolerance ±15% | | | |

Table continues overleaf



| accessories for | | 370020 | | |
|---|----------|----------|----------|---|
| Part No. | Ref. No. | Ref. No. | Ref. No. | — |
|  | 371230 | Ref. No. | Ref. No. | — |
| reducer TP flow rate 0.25l/min red tolerance ±25% | | | | |
|  | 371231 | Ref. No. | Ref. No. | — |
| reducer TP flow rate 0.35l/min violet tolerance ±25% | | | | |
|  | 371232 | Ref. No. | Ref. No. | — |
| reducer TP flow rate 0.5l/min orange tolerance ±25% | | | | |
|  | 371233 | Ref. No. | Ref. No. | — |
| reducer TP flow rate 0.8l/min white tolerance ±25% | | | | |
|  | 371234 | Ref. No. | Ref. No. | — |
| reducer TP flow rate 1l/min light blue tolerance ±25% | | | | |
|  | 371235 | Ref. No. | Ref. No. | — |
| reducer TP flow rate 1.2l/min brown tolerance ±25% | | | | |
|  | 371236 | Ref. No. | Ref. No. | — |
| reducer TP flow rate 1.5l/min light brown tolerance ±25% | | | | |
|  | 371237 | Ref. No. | Ref. No. | — |
| reducer TP flow rate 2.5l/min yellow tolerance ±25% | | | | |
|  | 371238 | Ref. No. | Ref. No. | — |
| reducer TP flow rate 3.4l/min dark green tolerance ±25% | | | | |
|  | 371239 | Ref. No. | Ref. No. | — |
| reducer TP flow rate 5l/min black tolerance ±25% | | | | |
|  | 371240 | Ref. No. | Ref. No. | — |
| reducer TP flow rate 8l/min blue tolerance ±20% | | | | |

| accessories for | | 370015 | | |
|---|----------|----------|----------|---|
| Part No. | Ref. No. | Ref. No. | Ref. No. | — |
|  | 371225 | Ref. No. | Ref. No. | — |
| reducer TP flow rate 16l/min light brown tolerance ±15% | | | | |
|  | 371226 | Ref. No. | Ref. No. | — |
| reducer TP flow rate 20l/min red tolerance ±15% | | | | |
|  | 371230 | Ref. No. | Ref. No. | — |
| reducer TP flow rate 0.25l/min red tolerance ±25% | | | | |
|  | 371231 | Ref. No. | Ref. No. | — |
| reducer TP flow rate 0.35l/min violet tolerance ±25% | | | | |
|  | 371232 | Ref. No. | Ref. No. | — |
| reducer TP flow rate 0.5l/min orange tolerance ±25% | | | | |
|  | 371233 | Ref. No. | Ref. No. | — |
| reducer TP flow rate 0.8l/min white tolerance ±25% | | | | |
|  | 371234 | Ref. No. | Ref. No. | — |
| reducer TP flow rate 1l/min light blue tolerance ±25% | | | | |
|  | 371235 | Ref. No. | Ref. No. | — |
| reducer TP flow rate 1.2l/min brown tolerance ±25% | | | | |
|  | 371236 | Ref. No. | Ref. No. | — |
| reducer TP flow rate 1.5l/min light brown tolerance ±25% | | | | |
|  | 371237 | Ref. No. | Ref. No. | — |
| reducer TP flow rate 2.5l/min yellow tolerance ±25% | | | | |
|  | 371238 | Ref. No. | Ref. No. | — |
| reducer TP flow rate 3.4l/min dark green tolerance ±25% | | | | |
|  | 371239 | Ref. No. | Ref. No. | — |
| reducer TP flow rate 5l/min black tolerance ±25% | | | | |
|  | 371240 | Ref. No. | Ref. No. | — |
| reducer TP flow rate 8l/min blue tolerance ±20% | | | | |

| | | | |
|--|--|-----------------|--------|
|   <p>1</p> | | | |
| Part No. | 370015 | Ref. No. | 634085 |
| description | solenoid valve single angled 230VAC inlet 3/4" outlet 11.5mm DN10 TP | | |
| accessories for | 370015 | | |
|  | Part No. 371220 | Ref. No. | — |
| reducer TP flow rate 3l/min red tolerance ±15% | | | |
|  | Part No. 371221 | Ref. No. | — |
| reducer TP flow rate 5.5l/min yellow tolerance ±15% | | | |
|  | Part No. 371222 | Ref. No. | — |
| reducer TP flow rate 6l/min grey tolerance ±15% | | | |
|  | Part No. 371223 | Ref. No. | — |
| reducer TP flow rate 10l/min white tolerance ±15% | | | |
|  | Part No. 371224 | Ref. No. | — |
| reducer TP flow rate 12l/min bronze tolerance ±15% | | | |





| | | | |
|--|--|-----------------|------------------------------------|
|   <p>1</p> | | | |
| Part No. | 370016 | Ref. No. | 23458 BAAN1322350 BAAN303848 |
| description | solenoid valve single angled 230VAC inlet 3/4" outlet 14mm DN10 TP | | |
| spare parts for | 370016 | | |
|  | Part No. 371013 | Ref. No. | — |
| solenoid coil TP 230VAC 50/60Hz | | | |
| accessories for | 370016 | | |
|  | Part No. 371220 | Ref. No. | — |
| reducer TP flow rate 3l/min red tolerance ±15% | | | |

Table continues overleaf



| accessories for | | 370016 | |
|---|----------|----------|----------|
| Part No. | Ref. No. | Part No. | Ref. No. |
|  | 371221 | — | — |
| reducer TP flow rate 5.5l/min yellow tolerance ±15% | | | |
|  | 371222 | — | — |
| reducer TP flow rate 6l/min grey tolerance ±15% | | | |
|  | 371223 | — | — |
| reducer TP flow rate 10l/min white tolerance ±15% | | | |
|  | 371224 | — | — |
| reducer TP flow rate 12l/min bronze tolerance ±15% | | | |
|  | 371225 | — | — |
| reducer TP flow rate 16l/min light brown tolerance ±15% | | | |
|  | 371226 | — | — |
| reducer TP flow rate 20l/min red tolerance ±15% | | | |
|  | 371230 | — | — |
| reducer TP flow rate 0.25l/min red tolerance ±25% | | | |
|  | 371231 | — | — |
| reducer TP flow rate 0.35l/min violet tolerance ±25% | | | |
|  | 371232 | — | — |
| reducer TP flow rate 0.5l/min orange tolerance ±25% | | | |
|  | 371233 | — | — |
| reducer TP flow rate 0.8l/min white tolerance ±25% | | | |
|  | 371234 | — | — |
| reducer TP flow rate 1l/min light blue tolerance ±25% | | | |
|  | 371235 | — | — |
| reducer TP flow rate 1.2l/min brown tolerance ±25% | | | |
|  | 371236 | — | — |
| reducer TP flow rate 1.5l/min light brown tolerance ±25% | | | |
|  | 371237 | — | — |
| reducer TP flow rate 2.5l/min yellow tolerance ±25% | | | |
|  | 371238 | — | — |
| reducer TP flow rate 3.4l/min dark green tolerance ±25% | | | |
|  | 371239 | — | — |
| reducer TP flow rate 5l/min black tolerance ±25% | | | |
|  | 371240 | — | — |
| reducer TP flow rate 8l/min blue tolerance ±20% | | | |
|  | 503139 | — | — |
| solenoid valve filter ø 19.5mm H 16mm | | | |



1





















| Part No. | Ref. No. | Part No. | Ref. No. |
|---|----------|----------|----------|
| 370024 | 634089 | — | — |
| description solenoid valve triple angled 230VAC inlet 3/4" outlet 14mm DN10 TP | | | |
| spare parts for | | 370024 | |
|  | Part No. | 371013 | Ref. No. |
| solenoid coil TP 230VAC 50/60Hz | | | |
| accessories for | | 370024 | |
|  | Part No. | 371220 | Ref. No. |
| reducer TP flow rate 3l/min red tolerance ±15% | | | |
|  | Part No. | 371221 | Ref. No. |
| reducer TP flow rate 5.5l/min yellow tolerance ±15% | | | |
|  | Part No. | 371222 | Ref. No. |
| reducer TP flow rate 6l/min grey tolerance ±15% | | | |
|  | Part No. | 371223 | Ref. No. |
| reducer TP flow rate 10l/min white tolerance ±15% | | | |
|  | Part No. | 371224 | Ref. No. |
| reducer TP flow rate 12l/min bronze tolerance ±15% | | | |
|  | Part No. | 371225 | Ref. No. |
| reducer TP flow rate 16l/min light brown tolerance ±15% | | | |
|  | Part No. | 371226 | Ref. No. |
| reducer TP flow rate 20l/min red tolerance ±15% | | | |
|  | Part No. | 371230 | Ref. No. |
| reducer TP flow rate 0.25l/min red tolerance ±25% | | | |
|  | Part No. | 371231 | Ref. No. |
| reducer TP flow rate 0.35l/min violet tolerance ±25% | | | |
|  | Part No. | 371232 | Ref. No. |
| reducer TP flow rate 0.5l/min orange tolerance ±25% | | | |
|  | Part No. | 371233 | Ref. No. |
| reducer TP flow rate 0.8l/min white tolerance ±25% | | | |
|  | Part No. | 371234 | Ref. No. |
| reducer TP flow rate 1l/min light blue tolerance ±25% | | | |
|  | Part No. | 371235 | Ref. No. |
| reducer TP flow rate 1.2l/min brown tolerance ±25% | | | |
|  | Part No. | 371236 | Ref. No. |
| reducer TP flow rate 1.5l/min light brown tolerance ±25% | | | |
|  | Part No. | 371237 | Ref. No. |
| reducer TP flow rate 2.5l/min yellow tolerance ±25% | | | |

Table continues overleaf



| | |
|---|---|
| accessories for 370024 | |
|  | Part No. 371238 Ref. No. — reducer TP flow rate 3.4l/min dark green tolerance ±25% |
|  | Part No. 371239 Ref. No. — reducer TP flow rate 5l/min black tolerance ±25% |
|  | Part No. 371240 Ref. No. — reducer TP flow rate 8l/min blue tolerance ±20% |

solenoid valves with reducers

| | |
|--|--|
|  <p>1</p> | |
| Part No. | 370255 Ref. No. 914135 |
| description | solenoid valve triple angled 230VAC inlet 3/4" outlet 11.5mm plastic |

| | |
|---|---|
|  <p>1</p> | |
| Part No. | 370250 Ref. No. 147723 |
| description | solenoid valve triple straight 230VAC inlet 3/4" outlet 11.5mm t.max. 90°C TP plastic output B 0.25l/min flow regulating valve outlet B red |



ball valves electric

| | |
|--|---|
|  <p>1</p> | |
| Part No. | 401190 Ref. No. 314359 |
| description | ball valve inlet 3/4" IT outlet 3/4" IT IP42 230V L 68mm 50/60Hz closed off-current mode of operation electric connection cable 300mm 3.5W duty cycle 50% |

fans



axial fans

ebm-papst

| | |
|---|--|
|  <p>1</p> | |
| Part No. | 601030 ¹ Ref. No. 780002656 |
| description | axial fan L 119mm W 119mm H 38mm 230VAC 50Hz 18W bearing ball bearing manuf. no. 4656Z metal connection male faston 2.8mm ebm-papst fan wheel ø 110mm temp.-resist. 75°C |
| accessories for 601030 | |
|  | Part No. 550898 Ref. No. — connecting cable cable length 2000mm connection F 2.8 connection distance 7.9mm for axial flow fan |
|  | Part No. 692497 Ref. No. — guard ø 105mm mounting distance 150mm for axial fan ebm-papstmm |

¹with ball bearings

import

| | |
|---|--|
|  <p>1</p> | |
| Part No. | 601080 ¹ Ref. No. 304194 780002656 906107 BAAN167195 BAAN312100 |
| description | axial fan L 119mm W 119mm H 38mm 230VAC 50/60Hz 23/20W bearing ball bearing connection male faston 2.8mm metal ADDA fan wheel ø 110mm temp.-resist. 70°C |
| accessories for 601080 | |
|  | Part No. 550898 Ref. No. — connecting cable cable length 2000mm connection F 2.8 connection distance 7.9mm for axial flow fan |
|  | Part No. 692519 Ref. No. — guard L 120mm W 120mm plastic |

¹with ball bearings



cross flow fans

COPREL

with standard coil



1

| | | | |
|--------------------|--|-----------------|--------|
| Part No. | 602060 | Ref. No. | 304229 |
| description | cross flow fan COPREL FFR roller \varnothing 60mm roller length 240mm laminated core thickness 20mm motor position right 230V/50-60Hz 33W universal bearing silicone connection male faston 6.3mm airflow 149m ³ /h -10 up to +60°C | | |

hot air motors



1

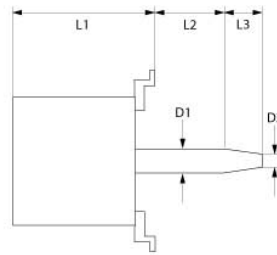

| | | | |
|--------------------|---|-----------------|--------|
| Part No. | 500812 | Ref. No. | 71251E |
| description | fan motor 220-240/380-415V 3 phase 50Hz 0.26kW 1440rpm speeds 1 D1 \varnothing 17mm D2 \varnothing 13.5mm | | |

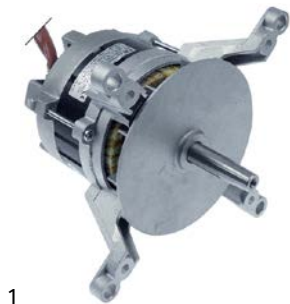

1

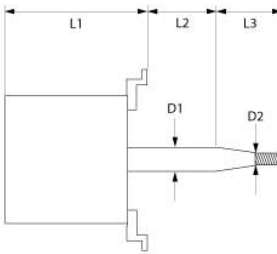

| | | | |
|--------------------|--|-----------------|--------------------------------------|
| Part No. | 499206 | Ref. No. | 304267 BAAN1050261 BAAN1051644 |
| description | fan motor 230/400V 3 phase 50/60Hz 0.12kW 1400/1700rpm speeds 2 L1 145mm L2 30mm L3 25mm D1 \varnothing 17mm D2 \varnothing 14mm M6 1.2/0.7A suitable capacitor 16 μ F/450V Cos(fi) 0.53 type 1079TH | | |

pumps



wash and rinse pumps

HANNING

pumps



1

| | | | |
|---|--|-----------------|-----------------------------------|
| Part No. | 499284 | Ref. No. | 314361 |
| description | pump inlet \varnothing 28mm outlet \varnothing 26mm type UP60-321 Ru. 220-240V 50Hz 1 phase 0.27kW L 190mm rotation direction right capacitor 5 μ F HANNING | | |
| spare parts for | 499284 | | |
|  | Part No. | 365017 | Ref. No. 2000001 304269 |
| | operating capacitor capacity 5 μ F 450V tolerance 5% 50/60Hz ambient temperature max. -25 to +85°C \varnothing 28mm L 54mm M8 plastic connection male faston 6.3mm 16.10.08 protection | | |
|  | Part No. | 507558 | Ref. No. — |
| | mechanical shaft seal for shaft \varnothing 7mm height counter ring 5mm ID \varnothing 6.75mm ED \varnothing 20mm mounting \varnothing counter ring 18.5/slide ring 20mm | | |
|  | Part No. | 532644 | Ref. No. — |
| | O-ring EPDM thickness 3mm ID \varnothing 78mm Qty 1 pcs | | |

drain pumps

ASKOLL



1

| | | | |
|--------------------|---|-----------------|----------|
| Part No. | 500346 | Ref. No. | 2001518H |
| description | drain pump inlet \varnothing 30mm outlet \varnothing 22mm 230V 40W 50Hz ASKOLL type M231 XP with holder | | |



booster pumps II

accessories



1

| | | | |
|--------------------|--|-----------------|-------------------|
| Part No. | 365017 | Ref. No. | 2000001 304269 |
| description | operating capacitor capacity 5µF 450V tolerance 5% 50/60Hz ambient temperature max. -25 to +85°C ø 28mm L 54mm M8 plastic connection male faston 6.3mm 16.10.08 protection | | |



1

| | | | |
|--------------------|--|-----------------|---------|
| Part No. | 365012 | Ref. No. | 2000059 |
| description | operating capacitor capacity 6.3µF 450V tolerance 5% 50Hz ambient temperature max. -25 to +85°C ø 30mm L 61mm M8 plastic connection male faston 6.3mm protection | | |

condensators & interference suppression filters

operating capacitors

plastic



1

| | | | |
|--------------------|---|-----------------|--------------------|
| Part No. | 365021 | Ref. No. | 2001118H 304259 |
| description | operating capacitor capacity 16µF 425V tolerance 5% 50/60Hz ambient temperature max. -25 to +85°C ø 35mm L 73mm single M8 plastic connection male faston 6.3mm 416.10.99 protection | | |



1

| | | | |
|--------------------|--|-----------------|----------|
| Part No. | 365019 | Ref. No. | 2001119H |
| description | operating capacitor capacity 20µF 400V tolerance 5% 50/60Hz ambient temperature max. -25 to +85°C ø 39.5mm L 70mm M8 plastic connection male faston 6.3mm 16.10.25. protection | | |



1

| | | | |
|--------------------|--|-----------------|-------------------|
| Part No. | 365017 | Ref. No. | 2000001 304269 |
| description | operating capacitor capacity 5µF 450V tolerance 5% 50/60Hz ambient temperature max. -25 to +85°C ø 28mm L 54mm M8 plastic connection male faston 6.3mm 16.10.08 protection | | |



1

| | | | |
|--------------------|--|-----------------|---------|
| Part No. | 365012 | Ref. No. | 2000059 |
| description | operating capacitor capacity 6.3µF 450V tolerance 5% 50Hz ambient temperature max. -25 to +85°C ø 30mm L 61mm M8 plastic connection male faston 6.3mm protection | | |



1

| | | | |
|--------------------|--|-----------------|-------|
| Part No. | 365013 | Ref. No. | 3709E |
| description | operating capacitor capacity 8µF 400V tolerance 5% 50Hz ambient temperature max. -25 to +85°C ø 31.5mm L 55mm M8 plastic connection male faston 6.3mm protection | | |

metal



1

| | | | |
|--------------------|--|-----------------|-------|
| Part No. | 365139 | Ref. No. | 5843E |
| description | operating capacitor capacity 10µF 450V tolerance 5% 60Hz ambient temperature max. -25 up to +70°C ø 40mm L 83mm M8 aluminium connection male faston 6.3mm C.87.8BF2 MKP protection | | |

1 electric components





fuses

fine fuses

| | | | |
|---|---|-----------------|--------|
|  | | | |
| 1 | | | |
| Part No. | 358666 | Ref. No. | 309316 |
| description | fine fuse size ø5x20mm 0.315A fast-acting rated 250V Qty 10 pcs | | |

| | | | |
|---|---|-----------------|----------|
|  | | | |
| 1 | | | |
| Part No. | 358530 | Ref. No. | 2001921H |
| description | fine fuse size ø5x20mm 0.8A fast-acting rated 250V Qty 10 pcs | | |

| | | | |
|---|---|-----------------|----------------------|
|  | | | |
| 1 | | | |
| Part No. | 358677 | Ref. No. | 2001981H 2002146H |
| description | fine fuse size ø5x20mm 4A fast-acting rated 250V Qty 10 pcs | | |

| | | | |
|---|--|-----------------|---------|
|  | | | |
| 1 | | | |
| Part No. | 358752 | Ref. No. | 3090506 |
| description | fine fuse size ø6.3x32mm 10A fast-acting rated 500V Qty 10 pcs | | |

electric accessories

terminals

connection terminals with screw/faston connections

| | | | |
|---|--|-----------------|---|
|  | | | |
| 1 | | | |
| Part No. | 550411 | Ref. No. | 2001039H 306090 306157 5876E 906154 |
| description | power terminal block 6-pole max. 40A max 450V connection ø6mm ² / F6.3 temp.-resist. 150°C cross section 6mm ² | | |

gas thermostats

PEL

25ST series

| | | | |
|---|---|-----------------|---------------------------------------|
|  | | | |
| 1 | | | |
| Part No. | 101172 | Ref. No. | 310137 |
| description | gas thermostat PEL type 25ST 100-300°C gas inlet M16x1.5 (tube ø 10mm) bypass nozzle ø 0.35mm gas outlet M16x1.5 (tube ø 10/8mm) thermocouple connection M9x1 pilot connection M10x1 capillary pipe 1200mm probe ø 6mm probe L 100mm shaft ø 8x6.5mm shaft L 21/15mm shaft flat upper | | |
| spare parts for | 101172 | | |
|  | Part No. | 100259 | Ref. No. — |
| | bypass nozzle type PEL22 bore ø 0.35mm thread M6x0.5 | | |
|  | Part No. | 101060 | Ref. No. 7473048 BAAN310651 |
| | magnet unit standard L 39mm D1 ø 15.4mm D2 ø 11mm suitable for PEL20-21/JUNKERS/EGA | | |
|  | Part No. | 106200 | Ref. No. — |
| | nut thread M9x1 suitable for PEL 24/25S | | |
| accessories for | 101172 | | |
|  | Part No. | 100908 | Ref. No. — |
| | union screw thread M10x1 for pipe ø 4mm Qty 1 pcs | | |
|  | Part No. | 100909 | Ref. No. — |
| | union screw thread M10x1 for pipe ø 6mm Qty 1 pcs | | |
|  | Part No. | 101246 | Ref. No. — |
| | olive for pipe ø 4mm Qty 1 pcs | | |
|  | Part No. | 101278 | Ref. No. — |
| | olive for pipe ø 10mm Qty 1 pcs | | |
|  | Part No. | 101286 | Ref. No. — |
| | olive ID ø 6mm Qty 1 pcs | | |
|  | Part No. | 101300 | Ref. No. — |
| | union nut thread M16x1.5 tube ø 10mm | | |
|  | Part No. | 101450 | Ref. No. — |
| | olive for pipe ø 8mm L 12.7mm Qty 1 pcs ED ø 10mm | | |
|  | Part No. | 101451 | Ref. No. — |
| | union nut thread M16x1.5 tube ø 8mm | | |
|  | Part No. | 110079 | Ref. No. — |
| | knob dial plate gas thermostat 1-8 silver | | |
|  | Part No. | 110081 | Ref. No. 171475 |
| | knob ø 70mm shaft ø 8x6.5mm shaft flat universal | | |



gas valves and ignition boxes

gas control valves

SIT

ELETTROSIT



1

| | | | |
|---|--|-----------------|--------------------------------------|
| Part No. | 101127 | Ref. No. | 7472025 BAAN1209942 BAAN310630 |
| description | gas valve SIT type ELETTROSIT 230V gas inlet 3/4" gas outlet 3/4" thermocouple connection M9x1 pilot connection M10x1 lateral equiv. no. 0.810.175 | | |
| spare parts for | 101127 | | |
|  | Part No. | 101312 | Ref. No. — |
| | microswitch | | |
|  | Part No. | 101352 | Ref. No. — |
| | solenoid coil 230V 50Hz suitable for ELETTROSIT | | |
| accessories for | 101127 | | |
|  | Part No. | 100006 | Ref. No. — |
| | piezoelectric igniter suitable for ELETTROSIT body plastic blowing connection ø2.4mm ø 14mm | | |
|  | Part No. | 100904 | Ref. No. — |
| | locking screw M10x1 for pipe ø 4mm Qty 1 pcs | | |
|  | Part No. | 100905 | Ref. No. — |
| | locking screw M10x1 for pipe ø 6mm Qty 1 pcs | | |
|  | Part No. | 101301 | Ref. No. — |
| | gas connection thread 1/2" straight ELETTROSIT screw with O-ring | | |
|  | Part No. | 101303 | Ref. No. — |
| | gas connection straight thread 3/4" ELETTROSIT | | |
|  | Part No. | 101309 | Ref. No. — |
| | extension | | |

NOVASIT

accessories



1

| | | | |
|---|--------------------------------------|-----------------|-------------------|
| Part No. | 101313 | Ref. No. | 2020037 |
| description | solenoid coil 230V 50Hz | | |
| accessories for | 101313 | | |
|  | Part No. | 550896 | Ref. No. — |
| | gasket with screw gas valves NOVASIT | | |

TANDEM



1

| | | | |
|---|--|-----------------|------------------------------------|
| Part No. | 101189 | Ref. No. | 310305 BAAN829205 BAAN847641 |
| description | gas valve 230V 50Hz gas inlet 1/2" gas outlet 1/2" pilot connection M10x1 level slow ignition ignition times pressure range 3-50mbar power supply for modulator equiv. no. 0.830.040 suitable for Tandem | | |
| spare parts for | 101189 | | |
|  | Part No. | 101379 | Ref. No. — |
| | solenoid coil 230V 50Hz suitable for Tandem | | |
| accessories for | 101189 | | |
|  | Part No. | 100904 | Ref. No. — |
| | locking screw M10x1 for pipe ø 4mm Qty 1 pcs | | |
|  | Part No. | 100905 | Ref. No. — |
| | locking screw M10x1 for pipe ø 6mm Qty 1 pcs | | |
|  | Part No. | 101274 | Ref. No. — |
| | olive for pipe ø 16mm Qty 1 pcs | | |
|  | Part No. | 101275 | Ref. No. — |
| | union screw thread 1/2" for pipe ø 16mm Qty 1 pcs | | |
|  | Part No. | 101925 | Ref. No. — |
| | plug with O-ring thread M10x1 for pilot burner suitable for NOVASIT | | |
|  | Part No. | 102845 | Ref. No. — |
| | gas connection angled 1/2" flange 32x32mm hole distance 24x24mm Tandem | | |
|  | Part No. | 102846 | Ref. No. — |
| | gas connection straight 1/2" flange 32x32mm hole distance 24x24mm suitable for Tandem | | |

Table continues overleaf





| | | | |
|---|-----------------|--------|-------------------|
| accessories for | 101189 | | |
|  | Part No. | 102847 | Ref. No. — |
| | O-ring | | |





| | | | |
|--------------------|--|-----------------|--------|
| Part No. | 107831 | Ref. No. | 310196 |
| description | gas valve 230V 50Hz gas inlet 1/2" gas outlet 1/2" pilot connection M10x1 pressure range 3-50mbar type Tandem 830 SIT equiv. no. 0.830.030 | | |

| | | | |
|---|---|--------|-------------------|
| spare parts for | 107831 | | |
|  | Part No. | 101379 | Ref. No. — |
| | solenoid coil 230V 50Hz suitable for Tandem | | |

| | | | |
|---|--|--------|-------------------|
| accessories for | 107831 | | |
|  | Part No. | 100904 | Ref. No. — |
| | locking screw M10x1 for pipe ø 4mm Qty 1 pcs | | |

| | | | |
|--|--|--------|-------------------|
|  | Part No. | 100905 | Ref. No. — |
| | locking screw M10x1 for pipe ø 6mm Qty 1 pcs | | |

| | | | |
|---|---------------------------------|--------|-------------------|
|  | Part No. | 101274 | Ref. No. — |
| | olive for pipe ø 16mm Qty 1 pcs | | |

| | | | |
|---|---|--------|-------------------|
|  | Part No. | 101275 | Ref. No. — |
| | union screw thread 1/2" for pipe ø 16mm Qty 1 pcs | | |

| | | | |
|---|---|--------|-------------------|
|  | Part No. | 101925 | Ref. No. — |
| | plug with O-ring thread M10x1 for pilot burner suitable for NOVASIT | | |

| | | | |
|---|--|--------|-------------------|
|  | Part No. | 102845 | Ref. No. — |
| | gas connection angled 1/2" flange 32x32mm hole distance 24x24mm Tandem | | |

| | | | |
|---|---|--------|-------------------|
|  | Part No. | 102846 | Ref. No. — |
| | gas connection straight 1/2" flange 32x32mm hole distance 24x24mm suitable for Tandem | | |

| | | | |
|---|-----------------|--------|-------------------|
|  | Part No. | 102847 | Ref. No. — |
| | O-ring | | |

ignition boxes

SIT



| | | | |
|--------------------|--|-----------------|--------------------------------------|
| Part No. | 107519 | Ref. No. | 310324 BAAN1064197 BAAN1067290 |
| description | ignition box SIT type 579DBC electrodes 2 waiting time 3s safety time 5s 220/240V 12VA 50/60Hz | | |

ignition parts

pilot burners

SIT

100 series

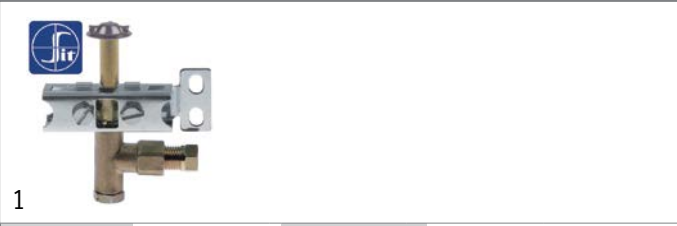



| | | | |
|-----------------|--------|-----------------|--------------------|
| Part No. | 106906 | Ref. No. | 2020124 7434003 |
|-----------------|--------|-----------------|--------------------|

| | | | |
|--------------------|---|--|--|
| description | pilot burner SIT type 100 series 3 flames nozzle ø 0.2mm gas connection 6mm | | |
|--------------------|---|--|--|

| | | | |
|------------------------|--------|--|--|
| spare parts for | 106906 | | |
|------------------------|--------|--|--|

| | | | |
|---|---|--------|-------------------|
|  | Part No. | 100245 | Ref. No. — |
| | pilot burner nozzle LPG code 20 bore ø 0.2mm Qty 1 pcs thread M8x0.75 | | |

| | | | |
|---|-----------------------------|--------|-------------------|
|  | Part No. | 100855 | Ref. No. — |
| | pilot burner bracket triple | | |

| | | | |
|---|--|--------|-------------------|
|  | Part No. | 100885 | Ref. No. — |
| | air mixing sleeve for pilot burner Qty 1 pcs | | |

| | | | |
|---|---|--------|-------------------|
|  | Part No. | 100916 | Ref. No. — |
| | compression spring for pilot burner Qty 1 pcs | | |

| | | | |
|---|---|--------|-------------------|
|  | Part No. | 100917 | Ref. No. — |
| | gasket for pilot burner Qty 1 pcs aluminium | | |

| | | | |
|---|------------------------|--------|-------------------|
|  | Part No. | 100918 | Ref. No. — |
| | screw for pilot burner | | |

| | | | |
|---|---|--------|-------------------|
|  | Part No. | 107162 | Ref. No. — |
| | pilot burner cap SIT 3 flames Hmm Lmm Qty 1 pcs | | |

| | | | |
|---|--|--------|-------------------|
|  | Part No. | 107701 | Ref. No. — |
| | pilot burner bottom part SIT 100 series nozzle ø 0.2mm | | |

Table continues overleaf

2 gas components



| accessories for | | 106906 | |
|--|--|--------|----------|
| Part No. | | 100245 | Ref. No. |
|  | pilot burner nozzle LPG code 20 bore \varnothing 0.2mm Qty 1 pcs thread M8x0.75 | | — |
|  | pilot burner nozzle natural gas bore \varnothing 0.35mm Qty 1 pcs thread M8x0.75 | | — |
|  | locking screw M10x1 for pipe \varnothing 4mm Qty 1 pcs | | — |
|  | locking screw M10x1 for pipe \varnothing 6mm Qty 1 pcs | | — |
|  | pilot tube copper pipe \varnothing 4mm thickness 1mm L 3000mm | | — |
|  | pilot tube copper pipe \varnothing 6mm thickness 1mm L 3000mm | | — |
|  | pilot burner nozzle SIT natural/liquid gas bore \varnothing 0.25mm Qty 1 pcs | | — |
|  | pilot burner bottom part SIT 100 series nozzle \varnothing 0.25mm | | — |
|  | pilot burner bottom part SIT 100 series nozzle \varnothing 0.35mm | | — |

accessories

ignition electrodes



| | | | |
|--------------------|--|-----------------|---------|
| Part No. | 100707 | Ref. No. | 7455048 |
| description | ignition electrode D1 \varnothing 7mm D2 \varnothing 9mm connection \varnothing 2.4mm L1 14mm L2 6mm BL1 18mm BL2 3mm BL3 23mm to clip Qty 1 pcs | | |

electrodes

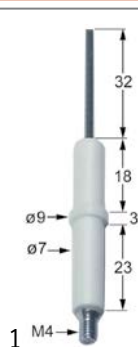

| | | | |
|---|--|-----------------|------------------------------------|
| Part No. | 100701 | Ref. No. | 308480 BAAN824045 BAAN838031 |
| description | ignition electrode connection M4 Qty 1 pcs | | |
| accessories for | 100701 | | |
|  | Part No. | 100906 | Ref. No. |
| | | | 317980 BAAN829766 BAAN838033 |
| | screw connection thread M10x1 for ignition electrode brass Qty 1 pcs WS 10 | | |



| | | | |
|--------------------|--|-----------------|---------|
| Part No. | 100707 | Ref. No. | 7455048 |
| description | ignition electrode D1 \varnothing 7mm D2 \varnothing 9mm connection \varnothing 2.4mm L1 14mm L2 6mm BL1 18mm BL2 3mm BL3 23mm to clip Qty 1 pcs | | |



| | | | |
|--------------------|--|-----------------|------------------------------------|
| Part No. | 100906 | Ref. No. | 317980 BAAN829766 BAAN838033 |
| description | screw connection thread M10x1 for ignition electrode brass Qty 1 pcs WS 10 | | |

ignition cables

pre-assembled cables



| | | | |
|--------------------|---|-----------------|--------|
| Part No. | 100176 | Ref. No. | 307997 |
| description | ignition cable cable length 1000mm connection \varnothing 2.4mm / \varnothing 4mm permanent temperature 200°C | | |



ignition units



1

| | | | |
|--------------------|--|-----------------|--------------------------------|
| Part No. | 102388 | Ref. No. | 308466 680782 BAAN308466 |
| description | ignition unit outputs 4 230VAC dimensions 111x23x34mm mounting distance 100mm inlet F6.3x0.8 outlet F2.8x0.8 type WAC-T4 0.6VA 50/60Hz | | |

thermocouples

thermocouple sets universal



1

| | | | |
|--------------------|--|-----------------|---------|
| Part No. | 107648 | Ref. No. | 7473055 |
| description | thermocouple set SIT 11-piece L 1200mm | | |



1

| | | | |
|--------------------|---|-----------------|--------|
| Part No. | 102286 | Ref. No. | 634321 |
| description | thermocouple set 8-piece L 900mm flexible | | |

plug-in thermocouples

plug-in thermocouples standard

with barrel socket $\varnothing 6(6.5)$ mm

thermocouples SIT

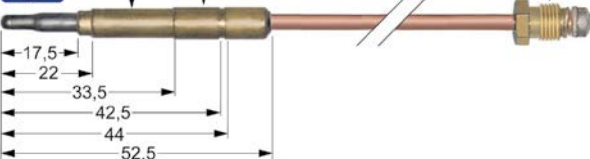

1

| | | | |
|--------------------|--|-----------------|---|
| Part No. | 102682 | Ref. No. | 310276 7473056 BAAN310657 BAAN840079 |
| description | thermocouple SIT aluminized tip M9x1 L 850mm plug connection $\varnothing 6.0(6.5)$ mm | | |

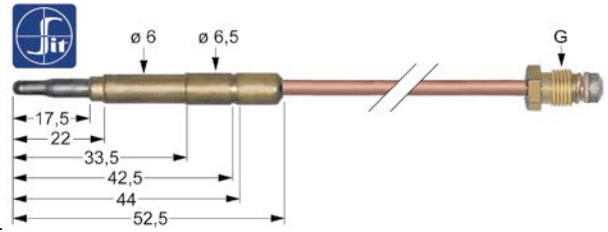

1

| | | | |
|--------------------|--|-----------------|---|
| Part No. | 107613 | Ref. No. | 310277 7473029 BAAN310646 BAAN838026 |
| description | thermocouple SIT M9x1 L 1200mm plug connection $\varnothing 6.0(6.5)$ mm | | |

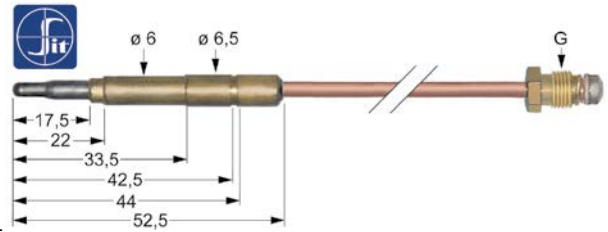

1

| | | | |
|--------------------|--|-----------------|---------|
| Part No. | 107614 | Ref. No. | 7473034 |
| description | thermocouple SIT M9x1 L 1500mm plug connection $\varnothing 6.0(6.5)$ mm | | |

threaded thermocouples

threaded thermocouples standard

with socket with thread M8x1

SIT

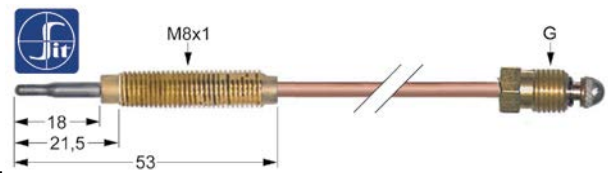

1

| | | | |
|--------------------|-------------------------------------|-----------------|--------|
| Part No. | 107634 | Ref. No. | 310193 |
| description | thermocouple SIT M8x1 L 1500mm M8x1 | | |

| | | | |
|---|--|--------|-----------------|
| accessories for | 107634 | | |
|  | Part No. | 102067 | Ref. No. |
| | | | — |
| | nut thread M8x1 H 3mm brass Qty 1 pcs type SEF 1 | | |

extensions



1

| | | | |
|--------------------|---|-----------------|---------|
| Part No. | 102811 | Ref. No. | 7492000 |
| description | thermocouple extension thread M9x1 - M9x1 L 600mm | | |



accessories

interrupters

| | | | |
|--|-------------------------|-----------------|------------------|
|  <p>1</p> | | | |
| Part No. | 101265 | Ref. No. | 605680 905680 |
| description | interrupter thread M9x1 | | |

gas nozzles

pilot burner nozzles

pilot burner nozzles SIT

100 series

| | | | |
|--|---|-----------------|---------|
|  <p>1</p> | | | |
| Part No. | 102973 | Ref. No. | 7433158 |
| description | pilot burner nozzle natural gas bore \varnothing 0.45mm Qty 1 pcs | | |

160 series

| | | | |
|---|---|-----------------|------------------------------------|
|  <p>1</p> | | | |
| Part No. | 107172 | Ref. No. | 310274 BAAN834138 BAAN838035 |
| description | pilot burner nozzle SIT LPG code 25 Qty 1 pcs | | |

| | | | |
|--|---|-----------------|--------|
|  <p>1</p> | | | |
| Part No. | 107650 | Ref. No. | 311171 |
| description | pilot burner nozzle SIT LPG code 30 Qty 1 pcs | | |

| | | | |
|--|---|-----------------|------------------------------------|
|  <p>1</p> | | | |
| Part No. | 107174 | Ref. No. | 310273 BAAN829765 BAAN838038 |
| description | pilot burner nozzle SIT natural gas code 41 Qty 1 pcs | | |

screw connections

union screws

| | | | |
|--|--|-----------------|------------------------------------|
|  <p>1</p> | | | |
| Part No. | 100906 | Ref. No. | 317980 BAAN829766 BAAN838033 |
| description | screw connection thread M10x1 for ignition electrode brass Qty 1 pcs WS 10 | | |

| | | | |
|--|--|-----------------|------------------------------------|
|  <p>1</p> | | | |
| Part No. | 100907 | Ref. No. | 317979 BAAN829767 BAAN838027 |
| description | screw connection thread M10x1 Qty 1 pcs type SEF 1 \varnothing mm for thermocouple | | |

for ice-cube maker

hoses

formed hoses

straight

silicone hoses

| | | | |
|---|---|-----------------|--------|
|  <p>1</p> | | | |
| Part No. | 530063 | Ref. No. | 71289E |
| description | silicone hose ID \varnothing 18mm ED \varnothing 25mm L 1m t.max. 200°C transparent | | |

brewing units

filter holder gaskets

O-rings

| | | | |
|--|---|-----------------|---|
|  <p>1</p> | | | |
| Part No. | 510409 | Ref. No. | 318044 905588 966001 BAAN1323306 BAAN311999 |
| description | O-ring EPDM thickness 5.34mm ID \varnothing 56.52mm Qty 1 pcs | | |

2 gas components



knobs

producer-specific knobs

BONNET



| | | | |
|--------------------|--|-----------------|--------|
| 1 | | | |
| Part No. | 110081 | Ref. No. | 171475 |
| description | knob ø 70mm shaft ø 8x6.5mm shaft flat universal | | |

locks

edgemount latches

handle latches

CAFF/FERMOD

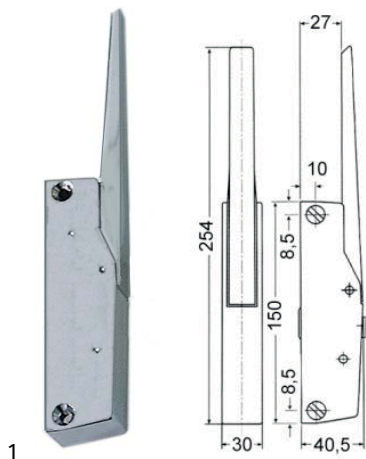

| | | | |
|-----------------|--------|-----------------|---|
| 1 | | | |
| Part No. | 690412 | Ref. No. | 21433E 384634 BAAN1322230 BAAN303576 |

description handle latch L 150mm mounting distance 133mm non lockable G 790 total length 254mm handle length 105mm

accessories for 690412

| | | | | |
|--|--|--------|-----------------|---|
| | Part No. | 690418 | Ref. No. | — |
| | door catch L 36mm W 19mm H 29mm mounting distance 12mm zinc-coated steel for refrigeration units | | | |
| | Part No. | 690419 | Ref. No. | — |
| | door catch L 52mm W 20mm H 30mm mounting distance 26-37mm zamak for refrigeration units | | | |
| | Part No. | 700061 | Ref. No. | — |
| | door catch L 58mm W 20mm H 35mm mounting distance 42mm chrome-plated brass for headed units | | | |
| | Part No. | 700435 | Ref. No. | — |
| | door catch L 58mm W 20mm H 35mm mounting distance 42mm zamak for refrigeration units | | | |

door catches



| | | | |
|--------------------|---|-----------------|-------------------|
| 1 | | | |
| Part No. | 700082 | Ref. No. | 679486 S486P51 |
| description | door catch L 38mm W 18mm mounting distance 26mm | | |

shelves and shelf rails

grates

universal

without upstand

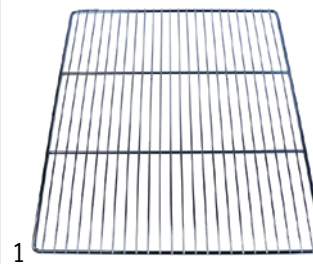

| | | | |
|--------------------|---|-----------------|--------|
| 1 | | | |
| Part No. | 970123 | Ref. No. | 635022 |
| description | grate W 650mm D 530mm GN 2/1 stainless steel wire gauge frame 7.8mm lengthwise wires gauge 3.8mm crossing wires 2 suitable for refrigerator | | |

accessories for 970123

| | | | | |
|--|--|--------|-----------------|---|
| | Part No. | 690330 | Ref. No. | — |
| | rack L 1000mm W 22mm H 4mm aperture 3x8mm hole distance 12.5mm stainless steel | | | |
| | Part No. | 694700 | Ref. No. | — |
| | shelf support L 31/28mm W 22mm H 18mm SS Qty 12 pcs | | | |
| | Part No. | 694701 | Ref. No. | — |
| | shelf support L 31/28mm W 22mm H 17mm SS with hook Qty 12 pcs | | | |

gaskets

gaskets for heated units

window seals

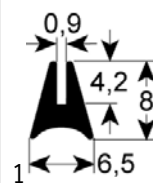

| | | | |
|--------------------|--|-----------------|--------|
| 1 | | | |
| Part No. | 901306 | Ref. No. | 366122 |
| description | window gasket profile 1515 Qty supplied by meter | | |

mechanical components, equipment accessories



| | | | |
|--------------------|---|-----------------|--------|
| Part No. | 901513 | Ref. No. | 71209E |
| description | window gasket profile 1615 suitable for BOURGEOIS Qty supplied by meter | | |

door seals

| | | | |
|--------------------|---------------------------------------|-----------------|--|
| Part No. | 901424 | Ref. No. | 71204E 71206E BAAN309220 BAAN309222 |
| description | door seal profile 2711 L 2600mm Qty 1 | | |

| | | | |
|--------------------|---------------------------------|-----------------|--------|
| Part No. | 518126 | Ref. No. | 71876E |
| description | door seal profile 2980 L 2820mm | | |

O-rings

EPDM

ø5.34mm

| | | | |
|--------------------|--|-----------------|----------|
| Part No. | 510408 | Ref. No. | 2001827H |
| description | O-ring EPDM thickness 5.34mm ID ø 47mm Qty 1 pcs | | |

| | | | |
|--------------------|---|-----------------|---|
| Part No. | 510409 | Ref. No. | 318044 905588 966001 BAAN1323306 BAAN311999 |
| description | O-ring EPDM thickness 5.34mm ID ø 56.52mm Qty 1 pcs | | |

ø7,00mm

| | | | |
|--------------------|---|-----------------|--------|
| Part No. | 532000 | Ref. No. | 366185 |
| description | O-ring EPDM thickness 7mm ID ø 57mm Qty 1 pcs | | |

special gaskets

miscellaneous

| | | | |
|--------------------|------------------|-----------------|--------|
| Part No. | 511600 | Ref. No. | 71860E |
| description | gasket ED ø 80mm | | |

transmission technology and ball bearings

ball bearings

deep-groove ball bearings 2RS

| | | | |
|--------------------|--|-----------------|----------|
| Part No. | 523522 | Ref. No. | 21090500 |
| description | deep-groove ball bearing type 6004-2RS shaft ø 20mm ED ø 42mm W 12mm with sealing discs deep-groove ball bearing DIN 625-1 | | |

dosing pumps

accessories

container filters with non-return valve

| | | | |
|--------------------|--|-----------------|---------|
| Part No. | 361058 | Ref. No. | 2000034 |
| description | container filter with non-return valve SS hose ø 4x6mm ø 20mm L 56mm | | |





hoses

supply hoses

PVC supply hoses



| | | | |
|---|--|-----------------|-------------------|
| Part No. | 520010 | Ref. No. | 2001753H 42551 |
| description | supply hose PVC straight-curved DN13 connections 3/4" L 1500mm operating p. 10bar burst p. 32bar t.max. 90°C blue approval VDE flat seal | | |
| accessories for | 520010 | | |
|  | Part No. | 520053 | Ref. No. — |
| | screen connection 3/4" D1 ø 26mm D2 ø 15mm Qty 10 pcs rubber thickness 8mm | | |
|  | Part No. | 520054 | Ref. No. — |
| | flat gasket rubber ED ø 23.5mm ID ø 14mm thickness 2.3mm Qty 10 pcs | | |



| | | | |
|--------------------|---|-----------------|----------|
| Part No. | 520011 | Ref. No. | 2001738H |
| description | supply hose PVC straight-curved DN13 connections 3/4" L 2000mm operating p. 10bar burst p. 32bar t.max. 90°C approval VDE flat seal | | |

industrial hoses

Niplaflex hoses



| | | | |
|--------------------|---|-----------------|----------|
| Part No. | 530561 | Ref. No. | 2001726H |
| description | pressure hose ID ø 10mm ED ø 17mm L 5m thickness 3.5mm operating p. 10bar burst p. 30bar t.max. 110°C | | |

PVC hoses

PVC hoses without fabric



| | | | |
|--------------------|--|-----------------|----------|
| Part No. | 520029 | Ref. No. | 2001747H |
| description | PVC hose ID ø 6mm ED ø 9mm L 10m thickness 1.5mm t.max. 60°C transparent | | |

silicone hoses

without fabric



| | | | |
|--------------------|---|-----------------|--------|
| Part No. | 530063 | Ref. No. | 71289E |
| description | silicone hose ID ø 18mm ED ø 25mm L 1m t.max. 200°C transparent | | |

with fabric

with monofilament braid

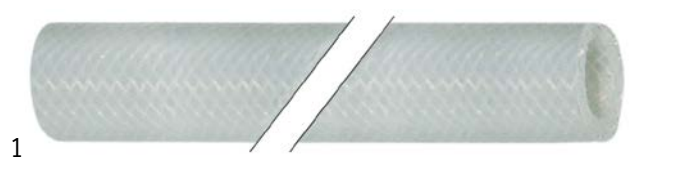

| | | | |
|--------------------|--|-----------------|--------|
| Part No. | 530542 | Ref. No. | 71265E |
| description | silicone hose with monofilament braid ID ø 10mm ED ø 17mm L 5m thickness 3.5mm operating p. 4bar burst pressure at 95°C non definedbar burst pressure 130°C non definedbar t.max. 200°C Qty 5m | | |

valves and tank inlets

ball valves

ball valves electric



| | | | |
|--------------------|---|-----------------|--------|
| Part No. | 401190 | Ref. No. | 314359 |
| description | ball valve inlet 3/4" IT outlet 3/4" IT IP42 230V L 68mm 50/60Hz closed off-current mode of operation electric connection cable 300mm 3.5W duty cycle 50% | | |

water cycle components

supply filters



| | | | |
|--------------------|---|-----------------|----------|
| Part No. | 520261 | Ref. No. | 91297387 |
| description | supply filter thread 1/2" IT - 1/2" IT total length 58mm red brass mesh opening 0.4mm | | |



ancillary products

clamps

hose clamps

DIN 3017 - W2



1

| | | | |
|--------------------|--|-----------------|--------|
| Part No. | 520114 | Ref. No. | 917110 |
| description | hose clamp ø 20-32mm width 9mm Qty 10 pcs DIN 3017 | | |

fastening material

nuts

hexagonal nuts

DIN 985



1

| | | | |
|--------------------|---|-----------------|-----------------------|
| Part No. | 560141 | Ref. No. | 389540 BAAN1050326 |
| description | hexagonal nut thread M5 H 5.4mm SS WS 8 Qty 20 pcs DIN/ISO DIN 985 self-locking | | |

fasteners

clamps

hose clamps

DIN 3017 - W2



1

| | | | |
|--------------------|--|-----------------|--------|
| Part No. | 520114 | Ref. No. | 917110 |
| description | hose clamp ø 20-32mm width 9mm Qty 10 pcs DIN 3017 | | |

consumables

fuses

fine fuses



1

| | | | |
|--------------------|---|-----------------|--------|
| Part No. | 358666 | Ref. No. | 309316 |
| description | fine fuse size ø5x20mm 0.315A fast-acting rated 250V Qty 10 pcs | | |



1

| | | | |
|--------------------|---|-----------------|----------|
| Part No. | 358530 | Ref. No. | 2001921H |
| description | fine fuse size ø5x20mm 0.8A fast-acting rated 250V Qty 10 pcs | | |



1

| | | | |
|--------------------|---|-----------------|----------------------|
| Part No. | 358677 | Ref. No. | 2001981H 2002146H |
| description | fine fuse size ø5x20mm 4A fast-acting rated 250V Qty 10 pcs | | |

ø6.3x32mm 500V



1

| | | | |
|--------------------|--|-----------------|---------|
| Part No. | 358752 | Ref. No. | 3090506 |
| description | fine fuse size ø6.3x32mm 10A fast-acting rated 500V Qty 10 pcs | | |

GASTROPARTS.COM



© 2020 Gastroparts Sp. J. All rights reserved.