



**GASTROPARTS**

# Blanco

**[EN]** Cooking

**[DE]** Kochtechnik

**[ES]** Cocción

**[FR]** Cuisson

**[IT]** Cottura

**[PL]** Obróbka termiczna

**[RU]** Термическая обработка

✉ [gastroparts@gastroparts.com](mailto:gastroparts@gastroparts.com)

☎ tel. +48 56 657 00 66

📘 [fb.com/gastroparts.global](https://fb.com/gastroparts.global)

**GASTROPARTS.COM**



## Hot servery counters (electrical)

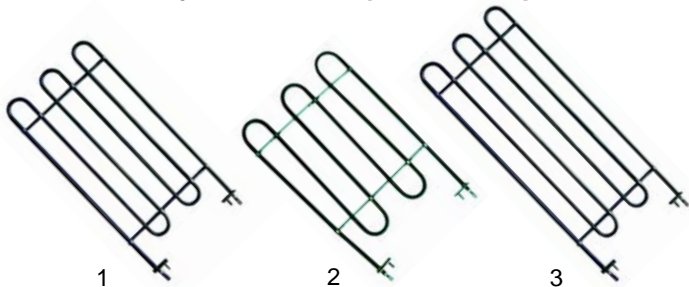

Item	Order	Description	Model	OEM
1	415544	700W/230V bain-marie	SWE_, SGE_, SAW_, SAG_	0105020
2	415894	150W/230V hot cupboard	STW_	0105454
3	415895	250W/230V hot cupboard	SGE_, SAG_, STW_	0105029

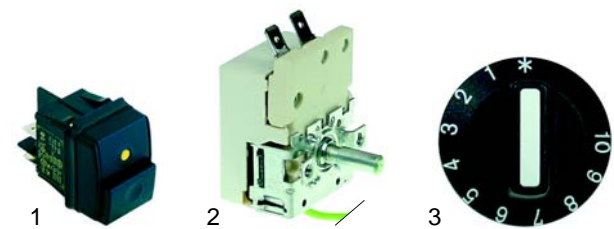

Item	Order	Description	Model	OEM
1	301083	switch	SWE_, SGE_	0105912
2	375714	thermostat 115 C bain-marie		0105883
2	375715	thermostat 85 C hot cupboard	SGE_	0105899
3	111874	knob	SWE_, SGE_	0292846

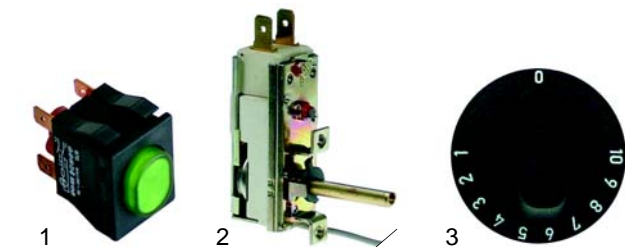

Item	Order	Description	Model	OEM
1	345235	switch		0105798
2	375716	thermostat bain-marie	SAW_, SAG_	0105796
2	375239	thermostat hot cupboard	STW_	0105795
3	111875	knob		0146654

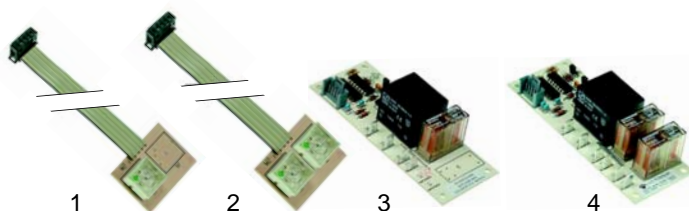

Item	Order	Description	Model	OEM
1	401387	keyboard 1-compartment		0105746
2	401388	keyboard 2-compartment	SAW_, SAG_	0105747
2	401389	electronics 1-compartment	STW_	0105748
3	401390	electronics 2-compartment		0105749

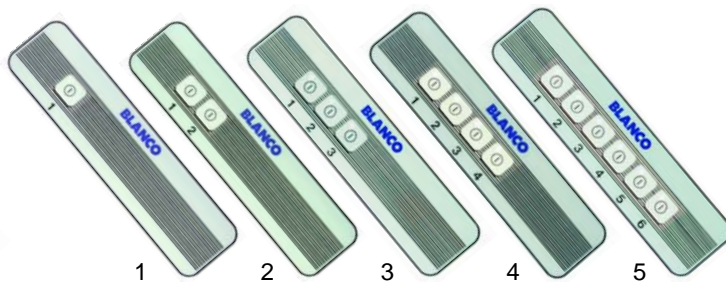

Item	Order	Description	Model	OEM
1	401391	fascia 1-compartment		
2	401392	fascia 2-compartment	SAW2/STW	0146207
3	401394	fascia 3-compartment	SAW3	0146208
4	401395	fascia 4-compartment	SAG2/SAW4	0146209
5	401396	fascia 6-compartment	SAG3	0146211

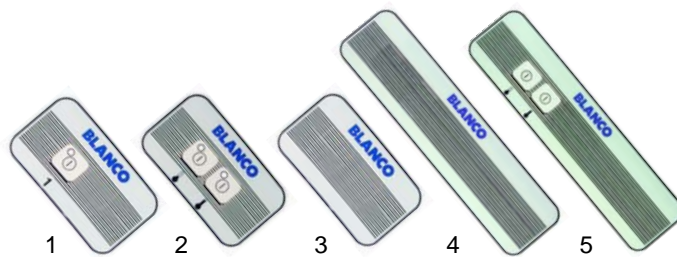

Item	Order	Description	Model	OEM
1	401404	fascia, 1-compartment	SAW1	-
2	401401	fascia, 2-compartment, 2 temperatures		0146533
3	401403	fascia, neutral		0146212
4	401402	fascia, neutral		
5	401405	fascia, 2-compartment, 2 temperatures		0146534

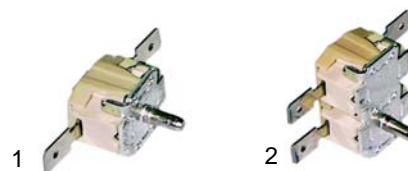

Item	Order	Description	Model	OEM
1	375242	contact thermostat, 95 C, SAW_, SAG_, bain-marie		0105751
2	375243	contact thermostat, 80 C, SAG_, STW_ warming compartment		0105754

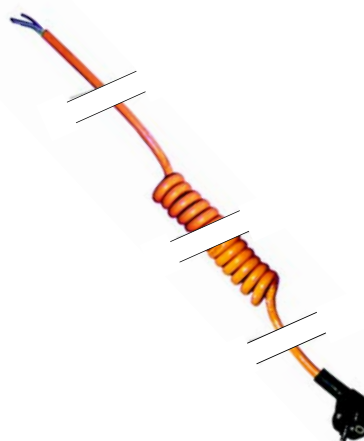

Pos.	Order	Description	Model	OEM
1	550101	spiral cable	SAW_, SAG_, STW_, SEW_, SGE	0105068 0105877

Suitable for Blanco



Item	Order	Description	Model	OEM
1	690899	removing wheel		146822
2	700309	swivel castor, Ø125mm	SEW_	146802
3	700310	swivel castor with break, Ø125mm		146803



Item	Order	Description	Model	OEM
1	693465	console		146585
2	693466	stuff	SEW_	146587
3	690897	pipe	SGE_	359997

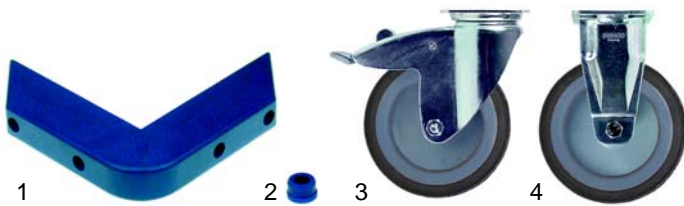

Item	Order	Description	Model	OEM
1	690898	bumper angle		146843
2	690900	stuff		362356
3	710004	swivel castor with break, Ø125 mm	SGE_	146806
4	700311	fixed roller for heavy loads, Ø125 mm		146807



Item	Order	Description	Model	OEM
1	690153	bumper angle		0146220
2	690902	stuff		0146223
3	710003	swivel castor, Ø125 mm	SAW_	0146805 0146164
4	710004	swivel castor with break, Ø125 mm		0146806 0146157

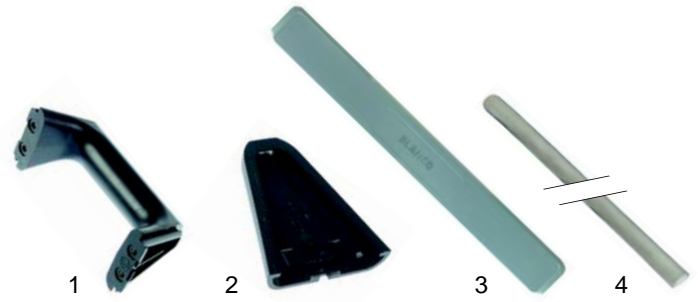

Item	Order	Description	Model	OEM
1	690904	handle	SAW_	0146416
2	690905	side part-handle	SAG_	0146417
3	690906	side part/neutral	STW_	0146418
4	690907	gasket/side part		0146203



Item	Order	Description	Model	OEM
1	700311	fixed roller for heavy loads, Ø125 mm		0146807
2	710004	swivel castor with break, Ø125 mm	SAW_	0146169
			SAG_	0146806
			STW_	0146150
3	690903	catch		0144345

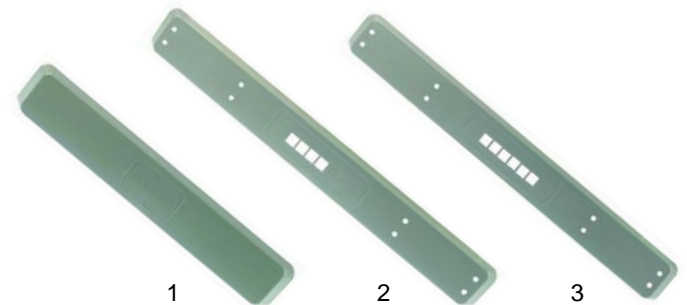

Item	Order	Description	Model	OEM
1	690911	side part, neutral	SAW1	0146419
2	690912	side part	SAG2/4	0276880
3	690913	side part	SAG3	0276882

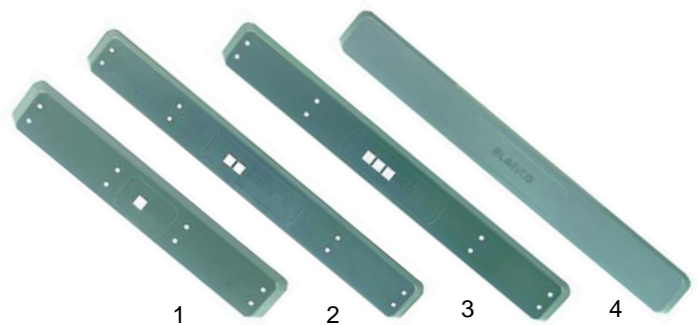

Item	Order	Description	Model	OEM
1	690921	side part, neutral	SAW1	0276874
2	690922	side part	SAW2/4	0276878
3	690923	side part	SAW3	0276879
4	690906	side part, neutral	universal	0146418

## Tray transport systems (electrical)

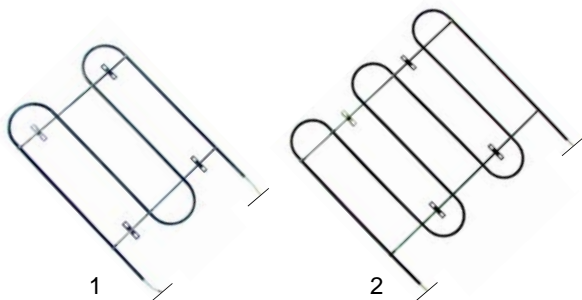

Item	Order	Description	Model	OEM
1	418278	350W/230V	TTW-F_DB26 TTW-F_DBDG TTW-F_BBEU	105793
2	418284	550W/230V	TTW-F_DB24	105794

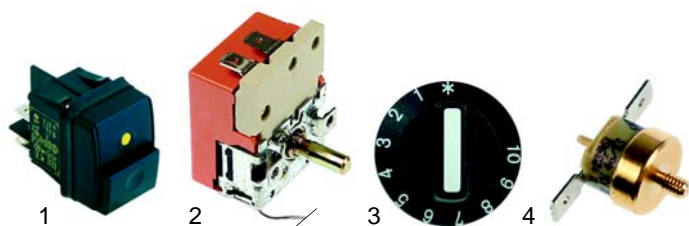

Item	Order	Description	Model	OEM
1	301083	switch		105912
2	375729	thermostat		359583
3	111874	knob	TTW-F__	292846
4	375730	safety thermostat 115 C		105803



Item	Order	Description	Model	OEM
1	379054	transformer		0105791
2	379559	electronic controller	TTW-F__	0106386 0105790
3	379052	sensor		0105788



Item	Order	Description	Model	OEM
1	690910	door handle		362976 146624
2	690909	spring	TTW-F__	147251
3	690916	latch		292360
4	690917	key cylinder		144350



Item	Order	Description	Model	OEM
1	693465	handel console		146585
2	693466	stuff	TTW-F__	146587
3	690897	pipe, Ø25 mm, 362 mm		359998



Item	Order	Description	Model	OEM
1	700235	swivel castor, Ø160mm		146788
2	700236	fixed roller for heavy loads, Ø160mm	TTW-F__	146789

## Caldofreddo (electrical)

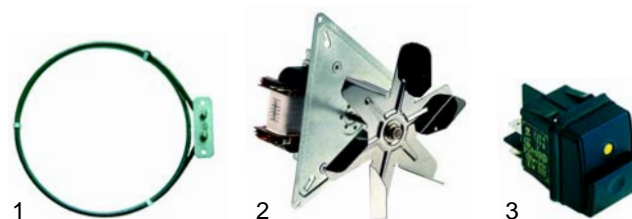

Item	Order	Description	Model	OEM
1	415893	1800W/230V		0105708
2	601267	fan	CF__	0106188
3	301083	switch		0105912

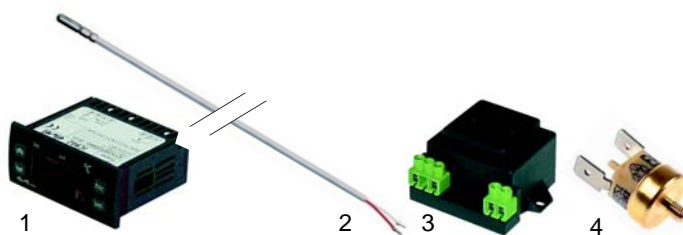

Item	Order	Description	Model	OEM
1	379562	electronic controller		0106189
2	379052	sensor		0105788
3	379054	transformer	CF__	0105791
4	375732	safety thermostat, 150 C		0297578

B

Suitable for Blanco





Item	Order	Description	Model	OEM
1	690924	bumper angle		0146908
2	690902	stuff		0146223
3	693465	console	CF__	0146585
4	693466	stuff		0146587
5	690897	pipe, Ø25 mm, 362 mm		0359998



Item	Order	Description	Model	OEM
1	379054	transformer 12 V		0105791
2	379559	electronic controller	BW__	0105790
3	379052	sensor PTC		0105788

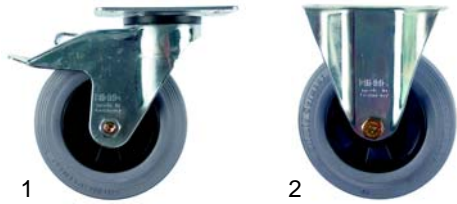

Item	Order	Description	Model	OEM
1	700235	swivel castor, Ø160mm		146788
2	700236	fixed roller for heavy loads, Ø160mm	CF__	146789



Item	Order	Description	Model	OEM
1	700314	swivel castor, Ø200mm		0145132
2	700315	swivel castor with break, Ø200mm	BW__	0145133
3	700313	fixed roller for heavy loads, Ø200mm		0145130

## Dinner carts (electrical)

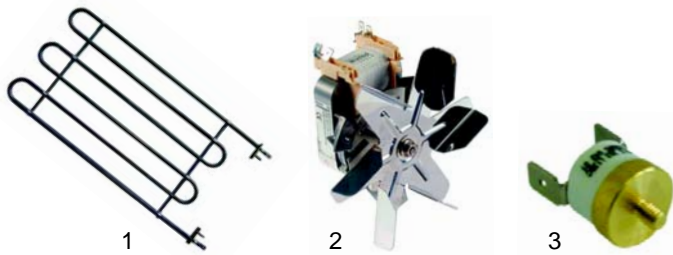

Item	Order	Description	Model	OEM
1	415596	1500 W/230 V		0105439
2	601254	fan complete	BW__	0105913
3	390311	safety thermostat, 135 °C		0105805



Item	Order	Description	Model	OEM
1	693465	console		0146585
2	693466	stuff	BW__	0146587
3	690897	pipe, Ø25 mm, 362 mm		0292297 0359998

## Stacking devices/plate dispensers (electrical)

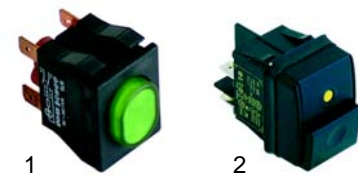

Item	Order	Description	Model	OEM
1	345235	switch	BW__(old)	0105798
2	301083	switch	BW__(new)	0105912

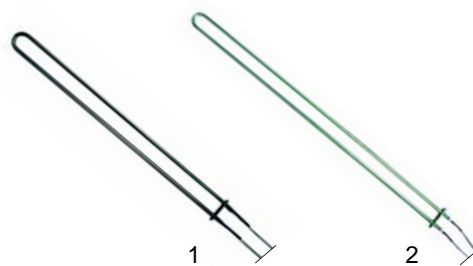

Item	Order	Description	Model	OEM
1	415706	275 W/230 V	RHE (until 1995)	0105700
2	415714	400 W/230 V		0105677

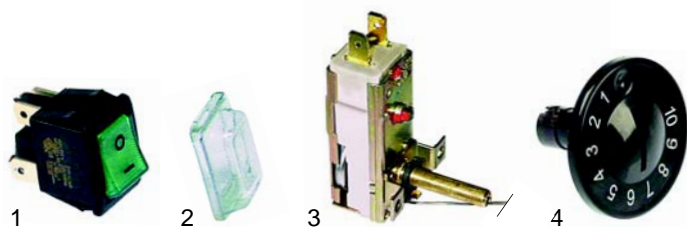

Item	Order	Description	Model	OEM
1	301069	switch		0105674
2	301064	hood		
3	390079	thermostat	RHE (until 1995)	0105678
4	111893	knob		0105675



Item	Order	Description	Model	OEM
1	415893	1800W/230V	2SHV (until 1992) 2SHV_ (from 1995)	0105672 0105708
2	601268	fan complete	2SHV_	0105671
3	375733	thermostat, 80 C/63 C		0105733



Item	Order	Description	Model	OEM
1	418285	275W/230V	RHE (from 1995)	0105911
2	301083	switch		0105912

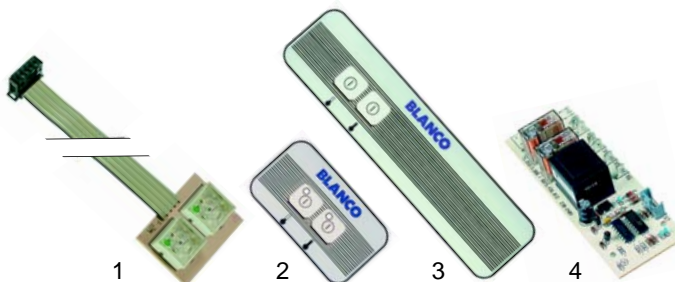

Item	Order	Description	Model	OEM
1	401388	keyboard		0105747
2	401401	fascia		0146533
3	401405	electronics, 2-compartment, 2 temperatures	_SHE (from '92 until '95) 2SHME_ (from '92 until '95) 2SHV_ (from '92 until '95)	0146534
4	401399	electronics, 2-compartment, 2 temperatures		0105771



Item	Order	Description	Model	OEM
1	375239	thermostat		0105795
2	111893	knob	RHE (from 1995)	0105675
3	390311	safety thermostat, 135 C		0105805

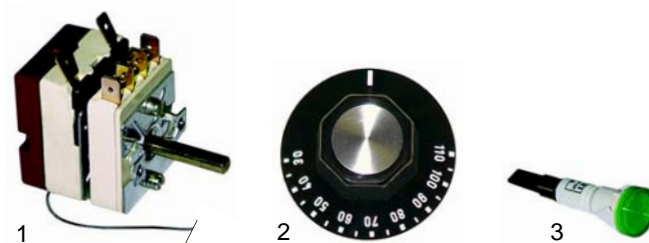

Item	Order	Description	Model	OEM
1	375406	thermostat	_SHE-_ (until 1992)	0105127
2	110119	knob	2SHME-_ (until 1992), 2SHV-_ (until 1992)	0105373
3	359148	signal lamp		0105188

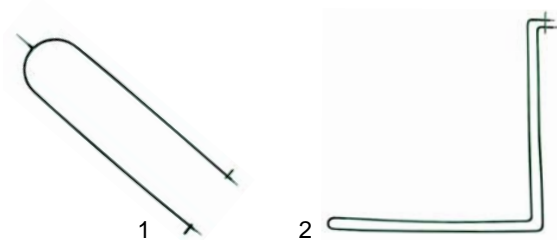

Item	Order	Description	Model	OEM
1	415910	900W/230V	SHE (until 1995) 2SHME (until 1995)	0105723
2	415892	900W/230V	_SHE (from 1995) 2SHME (from 1995)	0146753



Item	Order	Description	Model	OEM
1	375241	thermostat		0105797
2	111875	knob	_SHE-_ (from 1995) 2SHME-_ (from 1995),	0146654
3	390311	safety thermostat, 135 C	2SHV-_ (from 1995)	0105805
4	345235	switch		0105798

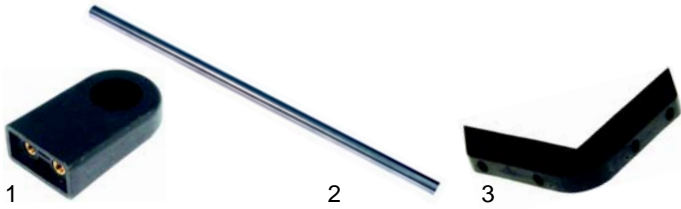

Item	Order	Description	Model	OEM
1	690925	handle console	(until 1992)	0144041
2	690928	pipe, Ø25 mm, 708 mm, cuttable	RE_, RHG, SE_, SHG, SHMG, VHV-, CHV_, CHV-U, CE, LEB, CEV, CEBH, UNI, UNI-U	0295344
3	690378	bumper angle		0145429

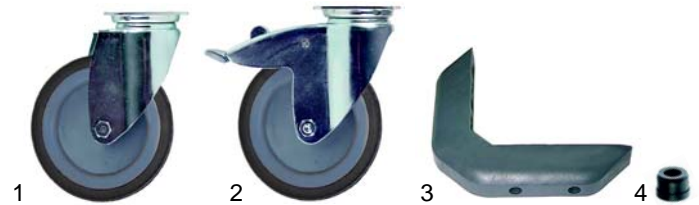

Item	Order	Description	Model	OEM
1	710003	swivel castor, Ø125 mm	(from 1995)	0146805
2	710004	swivel castor with break, Ø125 mm	RE_, RHG, SE_, SHG, SHMG, VHV-, CHV_, CHV-U, CE, LEB, CEV, CEBH, UNI, UNI-U	0146806
3	690153	bumper angle		0146220
4	690902	stuff		0146223



Item	Order	Description	Model	OEM
1	710003	swivel castor, Ø125 mm	(from 1992)	0146805
2	710004	swivel castor with break, Ø125 mm	RE_, RHG, SE_, SHG, SHMG, VHV-, CHV_, CHV-U, CE, LEB, CEV, CEBH, UNI, UNI-U	0145058 0146806 0145059



Item	Order	Description	Model	OEM
1	690151	tension spring, 49 mm		0146304
2	690150	tension spring, 89 mm	universal	0146305
3	690152	tension spring, 209 mm (hot and cold devices)		0146303 0146302

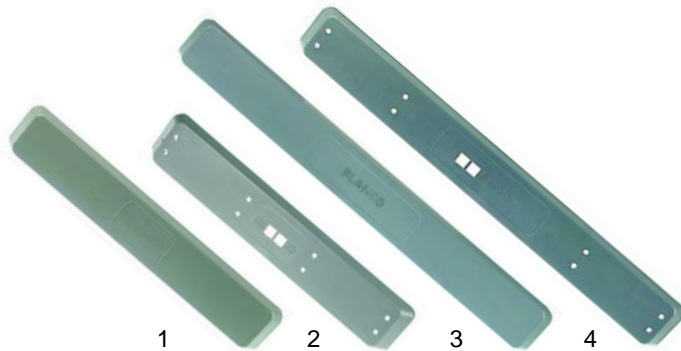

Item	Order	Description	Model	OEM
1	690911	side part right, 454 mm	(from 1992)	0146419
2	690926	side part left, 454 mm	RE_, RHG, SE_, SHG, SHMG, VHV-, CHV_, CHV-U, CE, LEB, CEV, CEBH, UNI, UNI-U	0276875 0146414
3	690906	side part right, 654 mm		0146418
4	690922	side part link, 654 mm		0146412 0276878

## Thermoport (electrical)

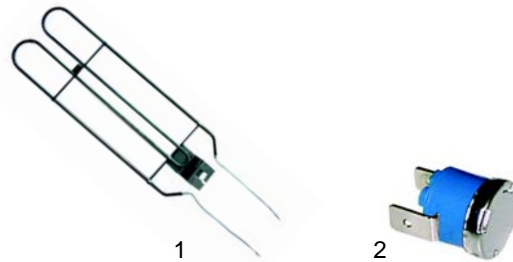

Item	Order	Description	Model	OEM
1	415218	500 W/230 V, 320 mm		0252477
2	390104	contact thermostat, 95 °C		0105483

## Devices with electronics

### Side parts

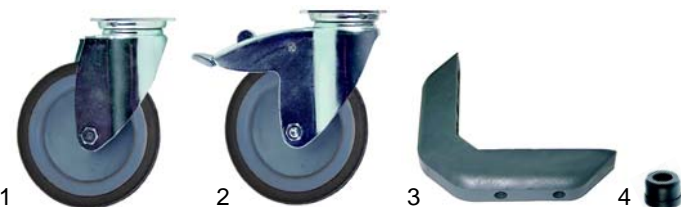

Item	Order	Description	Model	OEM
1	710003	swivel castor, Ø125 mm	(from 1992 - 1995)	0146805
2	710004	swivel castor with break, Ø125 mm	RE_, RHG, SE_, SHG, SHMG, VHV-, CHV_, CHV-U, CE, LEB, CEV, CEBH, UNI, UNI-U	0146162 0146806 0146155
3	690153	bumper angle		0146220
4	690902	stuff		0146223

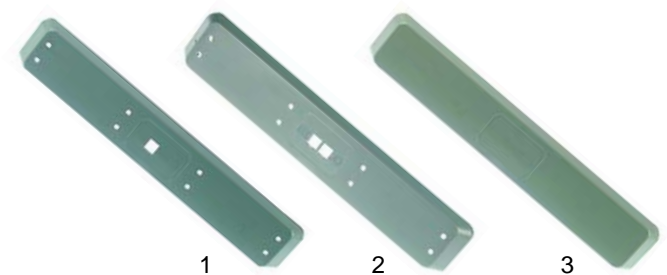

Item	Order	Description	Model	OEM
1	690921	side part, 1-compartment, 454 mm		0276874
2	690926	side part, 2-compartment, 454 mm 2 temperatures		0276875
3	690911	side part/neutral, 454 mm		0146419



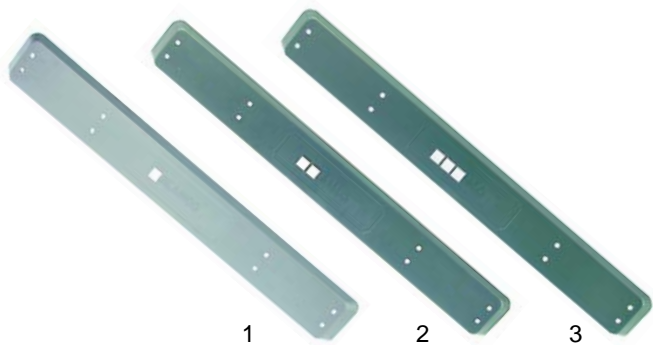

Item	Order	Description	Model	OEM
1	690927	side part, 1-compartment, 654 mm		0276877
2	690922	side part, 2-compartment, 654 mm		0276878
3	690923	side part, 3-compartment, 654 mm		0276879

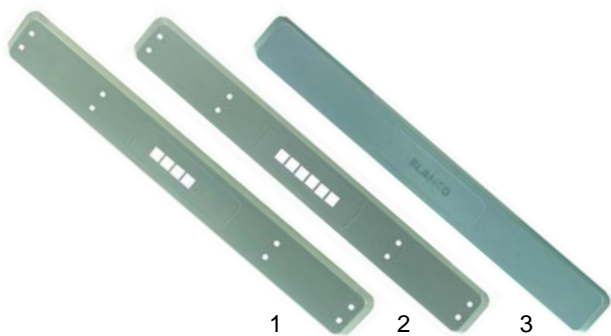

Item	Order	Description	Model	OEM
1	690912	side part, 4-compartment, 654 mm		0276880
2	690913	side part, 6-compartment, 654 mm		0276882
3	690906	side part/neutral, 654 mm		0146418

## Frontfoils

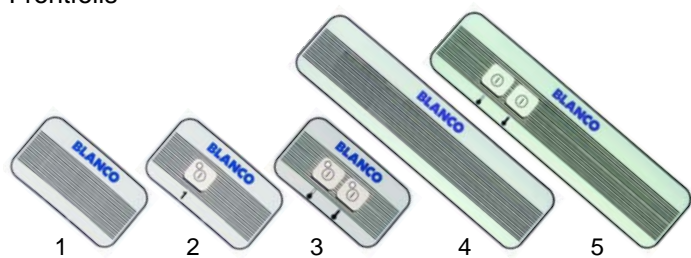

Item	Order	Description	Model	OEM
1	401403	fascia, neutral		0146212
2	401404	fascia, 1-compartment		-
3	401401	fascia, 2-compartment, 2 temperatures		0146533
4	401402	fascia, neutral		-
5	401405	fascia, 2-compartment, 2 temperatures		0143534

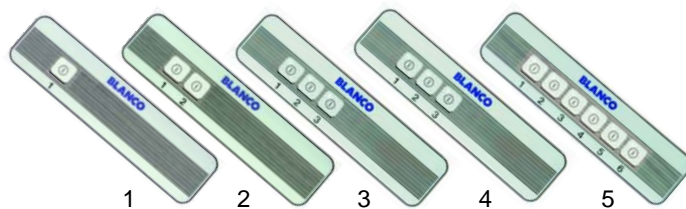

Item	Order	Description	Model	OEM
1	401391	fascia, 1-compartment		0146206
2	401392	fascia, 2-compartment		0146207
3	401394	fascia, 3-compartment		0146208
4	401395	fascia, 4-compartment		0146209
5	401396	fascia, 6-compartment		0146211

## Keyboards

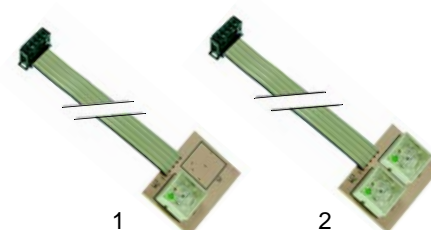

Item	Order	Description	Model	OEM
1	401387	keyboard, 1-compartment		0105746
2	401388	keyboard, 2-compartment		0105747

## Electronics

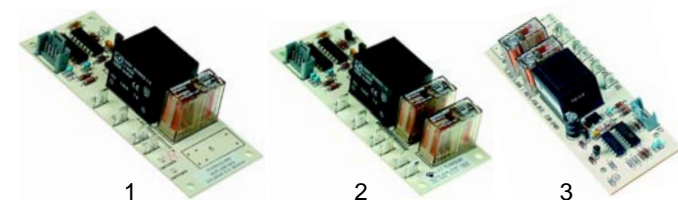

Item	Order	Description	Model	OEM
1	401389	electronics, 1-compartment		0105748
2	401390	electronics, 2-compartment		0105749
3	401399	electronics, 2-compartment		0105771

## Thermostats

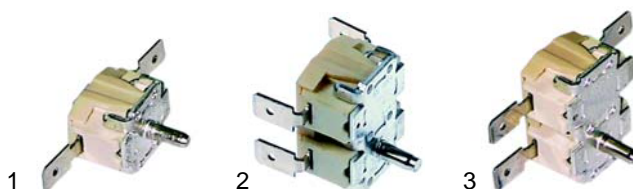

Item	Order	Description	Model	OEM
1	375242	95 C		0105751
2	375733	2 temperatures 80 C/63 C		0105733
3	375243	thermostat 80 C safety thermostat, 105 C		0105754





**GASTROPARTS.COM**



© 2020 Gastroparts Sp. J. All rights reserved.