



GASTROPARTS

Bartscher

[EN] Cooking

[DE] Kochtechnik

[ES] Cocción

[FR] Cuisson

[IT] Cottura

[PL] Obróbka termiczna

[RU] Термическая обработка

✉ gastroparts@gastroparts.com

☎ tel. +48 56 657 00 66

📘 fb.com/gastroparts.global

GASTROPARTS.COM





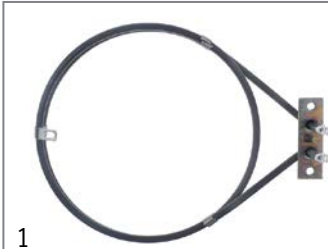

heating elements

heating elements for convection



Part No.	420038	Ref. No.	A0YXD1A4A16
description	heating element 1260W 230V heating circuits 1 ID ø 181mm ED ø 193mm L 240mm H 29mm L1 39mm W1 30mm H1 12mm H2 17mm flange length 70mm flange width 22mm hole distance 56mm connection male faston 6.3mm tube ø 6.6mm hole ø 6mm		
For models:	A120788		



Part No.	415966	Ref. No.	ORES006
description	heating element 2500W 230V heating circuits 1 ID ø 176mm ED ø 188mm L 210mm H 28mm L1 22mm W1 30mm H1 3mm H2 25mm flange length 70mm flange width 22mm hole distance 56mm connection male faston 6.3mm tube ø 6.3mm convection heating element hole ø 5mm rectangular flange		
spare parts for	415966		
	Part No.	510368	Ref. No. 02005174
	gasket L 70mm W 23.5mm hole ø 5mm hole distance 56mm FIBER thickness 2mm for heating element		
accessories for	415966		
	Part No.	510368	Ref. No. 02005174
	gasket L 70mm W 23.5mm hole ø 5mm hole distance 56mm FIBER thickness 2mm for heating element		

energy regulators

EGO

1-circuit



Part No.	380015	Ref. No.	05057021010
description	energy regulator 230V 13A single-circuit turn direction right shaft ø 6x4.6mm shaft L 23mm mounting thread M4 power release 6-100% no. 50.57021.010		
For models:	151510		

thermostats

control and safety thermostats

EGO

control thermostats

55.10/19_ series



Part No.	375002	Ref. No.	A010401
description	thermostat t.max. 320°C temperature range 55-320°C 1-pole 1NO 16A probe ø 3.1mm probe L 226mm capillary pipe 870mm capillary pipe isolated 850mm gland nut shaft L 23mm shaft position upper rotation 270°		

55.13_ series

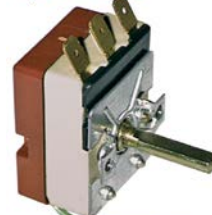

Part No.	375087	Ref. No.	06553670
description	thermostat t.max. 300°C temperature range 50-300°C 1-pole 1CO 16A probe ø 3.03mm probe L 160mm capillary pipe 1130mm capillary pipe isolated 1103mm gland nut shaft L 23mm shaft position upper rotation 270°		



Part No.	375505	Ref. No.	01044465 030008099 A039884
description	thermostat t.max. 320°C temperature range 50-320°C 1-pole 1NO 16A probe ø 3mm probe L 160mm capillary pipe 870mm capillary pipe isolatedmm gland nut shaft ø 6x4.6mm shaft L 23mm shaft position upper rotation 270°		
For models:	104447, A150671, A150674		



55.34_ series



Part No.	375412	Ref. No.	016728
-----------------	--------	-----------------	--------

description thermostat t.max. 320°C temperature range 50-320°C 3-pole 3NO 16A probe ø 3.1mm probe L 226mm capillary pipe 1480mm capillary pipe isolated 1400mm gland nut shaft ø 6x4.6mm shaft L 23mm shaft position upper rotation 318°

safety thermostats

55.13_ series



Part No.	375830	Ref. No.	020411
-----------------	--------	-----------------	--------

description safety thermostat switch-off temp. 365°C 1-pole 1NC 16A probe ø 3mm probe L 160mm capillary pipe 1730mm capillary pipe isolated 1710mm gland nut probe

IMIT / TEMPOMATIC / ARTHERMO

control thermostats



Part No.	390006	Ref. No.	0929044
-----------------	--------	-----------------	---------

description thermostat t.max. 86°C temperature range 0-86°C 1-pole 1CO 16A probe ø 6.5mm probe L 95mm capillary pipe 1500mm capillary pipe isolatedmm gland nut shaft ø 6x4.6mm shaft L 19mm rotation 270°

accessories for 390006



Part No.	110100	Ref. No.	—
description	knob thermostat t.max. 90°C 0-90°C ø 42mm shaft ø 6x4.6mm shaft flat -135° black		



Part No.	110105	Ref. No.	—
description	rosette knob ø 42mm ø 56mm zero mark		

switches and momentary switches

push/momentary push switches

ø25mm



1

Part No.	348211	Ref. No.	016148
-----------------	--------	-----------------	--------

description push switch mounting ø 25mm red 1NO/indicator light 250V 16A illuminated connection male faston 6.3mm ambient temperature max. 85°C protection IP65 with cover

microswitches

pin-plunger actuated

M10



1

Part No.	347341	Ref. No.	016240435 A040031
-----------------	--------	-----------------	----------------------

description microswitch with plunger thread M10x1 thread L 16mm 250V 10A 1NO connection male faston 6.3mm stroke 5mm mounting distancemm L 41mm ambient temperature max. 85°C type X3L502K6DD actuating force: 130g

For models: A150107, A150207

system switches (ROLD)



1

Part No.	345606	Ref. No.	0226071
-----------------	--------	-----------------	---------

description momentary switch unit 2CO 250V 16A connection male faston 6.3mm



1

Part No.	345538	Ref. No.	0227050
-----------------	--------	-----------------	---------

description push button ø 11.9mm black



magnetic switches

accessories

magnets

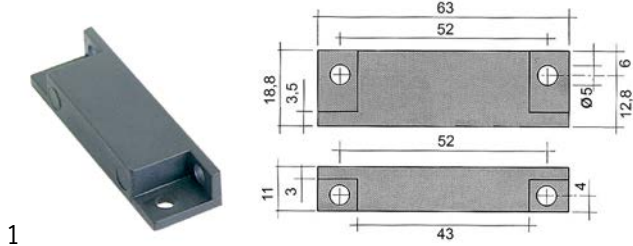

1

Part No.	345336	Ref. No.	0926014
description	magnet \varnothing 4.8mm L 63mm H 11mm W 18.8mm hole distance 51mm M4		

lamps

indicator lights

indicator lamps for socket type SRZ / SDK / SDY / SFK



1

Part No.	359130	Ref. No.	010426 0216006
description	indicator lamp 230V clear connection male faston 6.3mm \varnothing 8mm		

indicator lights (complete)

 \varnothing 6mm

1

Part No.	359031	Ref. No.	0216022
description	indicator light \varnothing 6mm 230V green		

 \varnothing 9mm

1

Part No.	359137	Ref. No.	021784
description	indicator light \varnothing 9mm 230V yellow connection male faston 6.3mm temp.-resist. 120°C with lens		

 \varnothing 10mm

with plug-in socket



1

Part No.	359139	Ref. No.	0216019
description	indicator light \varnothing 10mm green 230V connection male faston 6.3mm Qty 1 pcs		



1

Part No.	359140	Ref. No.	0216018
description	indicator light \varnothing 10mm yellow 230V connection male faston 6.3mm Qty 1 pcs		

screw-on/push-on fit

light bulbs

for ovens



1

Part No.	359610	Ref. No.	014034 A0YXD1A4A10
description	light bulb t.max. 300°C socket E14 15W 230V \varnothing 22mm L 47mm lens L 20mm for oven lamp type Philips		
For models:	105780, A120788		

halogen lamp

for socket G4 / G6.35 / G9



1

Part No.	359946	Ref. No.	A01140014
description	halogen lamp socket G9 230V 40W temp.-resist. 300°C		
For models:	A114001		



oven lamps

universal oven lamps

mounting diameter 35.5mm



1

Part No.	359718	Ref. No.	030003005+030008380 A0YXD1A4A12	
description	oven lamp mounting \varnothing 35.5mm 230V 15W socket E14 temp.-resist. 300°C connection male faston 6.3mm hard glas			
For models:	105780, A120788			
spare parts for	359718			
	Part No.	359701	Ref. No.	—
	lamp socket socket E14 220-230V mounting \varnothing 35.5mm connection male faston 6.3mm 15W			
	Part No.	359740	Ref. No.	—
	light bulb t.max. 300°C socket E14 15W 230V \varnothing 22mm L 48mm lens L 20mm for oven lamp IMPORT			



lamps

light bulbs



Part No.	359610	Ref. No.	014034 A0YXD1A4A10
description	light bulb t.max. 300°C socket E14 15W 230V ø 22mm L 47mm lens L 20mm for oven lamp type Philips		
For models:	105780, A120788		

halogen lamps

for socket G4 / G6.35 / G9



Part No.	359946	Ref. No.	A01140014
description	halogen lamp socket G9 230V 40W temp.-resist. 300°C		
For models:	A114001		

timers

mechanical timers



Part No.	360475	Ref. No.	A0YXD1A4A06
description	timer M11 with bell 1-pole operation time 120min impulse mechanical 1NO at 250V 16A permanent position no shaft ø 6x4.6mm shaft 6x4.6mm shaft L 21mm mounting distance 28mm		
For models:	A120788		



Part No.	360476	Ref. No.	01207908 A040897 (old version)
description	timer M11 with bell 2-pole operation time 15min 2NO at 250V 16A shaft ø 6mm shaft L 15mm connection male faston 6.3mm		

contactors

GENERAL ELECTRIC (AEG)

power contactors



Part No.	380244	Ref. No.	040100023
description	power contactor resistive load 25A 230VAC (AC3/400V) 9A/4kW main contacts 3NO auxiliary contacts 1NO connection screw connection type AEG LS4K 10A type GE CL00A 310		



Part No.	380264	Ref. No.	017594
description	power contactor resistive load 45A 230VAC (AC3/400V) 25A/11kW main contacts 3NO auxiliary contacts connection screw connection type AEG LS11K 00A type GE CL25A 300		

SIEMENS

power contactors



Part No.	380389	Ref. No.	0229037
description	power contactor resistive load 22A 230VAC (AC3/400V) 9A/4kW main contacts 3NO auxiliary contacts 1NO connection screw connection type 3RT10-16-1AP01		

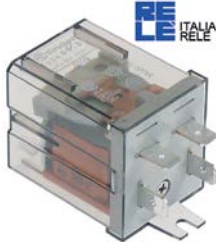

			
1			
Part No.	380957	Ref. No.	0927051
description	power contactor resistive load 22A 24VAC (AC3/400V) 12A/5.5kW main contacts 3NO auxiliary contacts 1NO connection screw connection type 3RT10-17-1AB01 50/60Hz		

			
1			
Part No.	380185	Ref. No.	020473
description	power relays Italiana Relè 230VAC 30A 1NO connection F6.3 bracket mounting dimensions 36.5x32.2x51.8mm manuf. no. A10-230AC-FA		

relays

power relays

with bracket mounting

			
1			
Part No.	380312	Ref. No.	0229023 0229024
description	power relays FINDER 230VAC 10A 3CO connection male faston 4.8mm bracket mounting dimensions 52x32.2x36.5mm manuf. no. 60.63.8.230.0000		

			
1			
Part No.	380139	Ref. No.	0926021
description	power relays FINDER 230VAC 16A 2CO connection F6.3 bracket mounting dimensions 68x38.2x35.8mm manuf. no. 62.82.8.230.0000		

			
1			
Part No.	380403	Ref. No.	0229036
description	power relays FINDER 230VAC 16A 3CO connection F6.3 bracket mounting manuf. no. 62.83.8.230.0500		

probes

producer-specific probes

core probes

			
1			
Part No.	379886	Ref. No.	0SON000
description	core temperature probe Pt100 cable PTFE probe -40 up to +250°C cable -40 up to +250°C connection 2-wire probe ø4x100mm thread M10x1.5 cable length 3m handle ø 15mm handle length 90mm		

solenoid valves

solenoid valves (water)

























TP			
			
1			
Part No.	370111	Ref. No.	0927001
description	solenoid valve double straight 24VAC inlet 3/4" outlet 11.5mm DN10 TP		
spare parts for	370111		
	Part No.	371035	Ref. No. —
	solenoid coil 24VAC		
accessories for	370111		
	Part No.	371220	Ref. No. —
	reducer TP flow rate 3l/min red tolerance ±15%		
	Part No.	371221	Ref. No. —
	reducer TP flow rate 5.5l/min yellow tolerance ±15%		
	Part No.	371222	Ref. No. —
	reducer TP flow rate 6l/min grey tolerance ±15%		
	Part No.	371223	Ref. No. —
	reducer TP flow rate 10l/min white tolerance ±15%		
	Part No.	371224	Ref. No. —
	reducer TP flow rate 12l/min bronze tolerance ±15%		

Table continues overleaf



accessories for		370111		
Part No.	Ref. No.	Ref. No.	Ref. No.	—
	371225	Ref. No.	—	reducer TP flow rate 16l/min light brown tolerance ±15%
	371226	Ref. No.	—	reducer TP flow rate 20l/min red tolerance ±15%
	371230	Ref. No.	—	reducer TP flow rate 0.25l/min red tolerance ±25%
	371231	Ref. No.	—	reducer TP flow rate 0.35l/min violet tolerance ±25%
	371232	Ref. No.	—	reducer TP flow rate 0.5l/min orange tolerance ±25%
	371233	Ref. No.	—	reducer TP flow rate 0.8l/min white tolerance ±25%
	371234	Ref. No.	—	reducer TP flow rate 1l/min light blue tolerance ±25%
	371235	Ref. No.	—	reducer TP flow rate 1.2l/min brown tolerance ±25%
	371236	Ref. No.	—	reducer TP flow rate 1.5l/min light brown tolerance ±25%
	371237	Ref. No.	—	reducer TP flow rate 2.5l/min yellow tolerance ±25%
	371238	Ref. No.	—	reducer TP flow rate 3.4l/min dark green tolerance ±25%
	371239	Ref. No.	—	reducer TP flow rate 5l/min black tolerance ±25%
	371240	Ref. No.	—	reducer TP flow rate 8l/min blue tolerance ±20%

  1				
Part No.	370017	Ref. No.	0240011	
description	solenoid valve single straight 230VAC inlet 3/4" outlet 11.5mm DN10 TP p max 10bar			
spare parts for	370017			
	Part No.	371013	Ref. No.	—
solenoid coil TP 230VAC 50/60Hz				
accessories for	370017			
	Part No.	371220	Ref. No.	—
reducer TP flow rate 3l/min red tolerance ±15%				
	Part No.	371221	Ref. No.	—
reducer TP flow rate 5.5l/min yellow tolerance ±15%				

accessories for		370017		
Part No.	Ref. No.	Ref. No.	Ref. No.	—
	371222	Ref. No.	—	reducer TP flow rate 6l/min grey tolerance ±15%
	371223	Ref. No.	—	reducer TP flow rate 10l/min white tolerance ±15%
	371224	Ref. No.	—	reducer TP flow rate 12l/min bronze tolerance ±15%
	371225	Ref. No.	—	reducer TP flow rate 16l/min light brown tolerance ±15%
	371226	Ref. No.	—	reducer TP flow rate 20l/min red tolerance ±15%
	371230	Ref. No.	—	reducer TP flow rate 0.25l/min red tolerance ±25%
	371231	Ref. No.	—	reducer TP flow rate 0.35l/min violet tolerance ±25%
	371232	Ref. No.	—	reducer TP flow rate 0.5l/min orange tolerance ±25%
	371233	Ref. No.	—	reducer TP flow rate 0.8l/min white tolerance ±25%
	371234	Ref. No.	—	reducer TP flow rate 1l/min light blue tolerance ±25%
	371235	Ref. No.	—	reducer TP flow rate 1.2l/min brown tolerance ±25%
	371236	Ref. No.	—	reducer TP flow rate 1.5l/min light brown tolerance ±25%
	371237	Ref. No.	—	reducer TP flow rate 2.5l/min yellow tolerance ±25%
	371238	Ref. No.	—	reducer TP flow rate 3.4l/min dark green tolerance ±25%
	371239	Ref. No.	—	reducer TP flow rate 5l/min black tolerance ±25%
	371240	Ref. No.	—	reducer TP flow rate 8l/min blue tolerance ±20%



solenoid valves with reducers



1

Part No.	370628	Ref. No.	017696
description	solenoid valve double straight 230VAC inlet 3/4" input 16l/min DN10 TP plastic outlet 11.5mm		

fans

hot air motors



1

Part No.	601993	Ref. No.	OMOT001
description	fan motor 230V 1 phase 50Hz 0.18/0.12kW 2800rpm speeds 1 L1 85mm L2 65mm L3 23mm D1 ø 8mm D2 ø 6mm M5x0.8 0.8A suitable capacitor 5µF/450V		
accessories for	601993		
	Part No.	365017	Ref. No. —
	operating capacitor capacity 5µF 450V tolerance 5% 50/60Hz ambient temperature max. -25 to +85°C ø 28mm L 54mm M8 plastic connection male faston 6.3mm 16.10.08 protection		



1

Part No.	601690	Ref. No.	010578043
description	fan motor 230V 50Hz 0.09kW 2450rpm L1 80mm L2 20mm L3 35mm L4 20mm D1 ø 12mm D2 ø 8x6mm M5		
For models:	105780		



1

Part No.	601688	Ref. No.	010578050
description	fan wheel D1 ø 200mm H1 43mm blades 39 D2 ø 8x6mm D3 ø 8mm H2 29mm		
For models:	105780		

hot air fans

miscellaneous



1

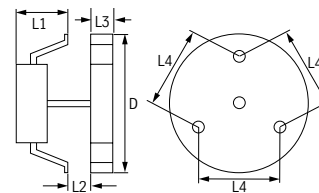

Part No.	601125	Ref. No.	0A036410
description	hot air fan 220-240V 45W 50/60Hz L1 70mm L2 11mm L3 25mm L4 87mm fan wheel ø 150mm FIME type C30R0479CLF		
For models:	A120788		
accessories for	601125		
	Part No.	550879	Ref. No. —
	insulation ø 130mm thickness 3mm hole ø 20mm for hot air fan		



pumps

drain pumps

ASKOLL



1

Part No.	500214	Ref. No.	0130105 0130146
description	drain pump inlet ø 30mm outlet ø 22mm 230/240V 30W 50Hz ASKOLL type R113		

condensators & interference suppression filters

operating capacitors

plastic



1

Part No.	365021	Ref. No.	0206004
description	operating capacitor capacity 16µF 425V tolerance 5% 50/60Hz ambient temperature max. -25 to +85°C ø 35mm L 73mm single M8 plastic connection male faston 6.3mm 416.10.99 protection		



1

Part No.	365019	Ref. No.	0206005
description	operating capacitor capacity 20µF 400V tolerance 5% 50/60Hz ambient temperature max. -25 to +85°C ø 39.5mm L 70mm M8 plastic connection male faston 6.3mm 16.10.25. protection		

filters

interference suppression filters



1

Part No.	365044	Ref. No.	0926144
description	interference suppression filter type FC701Y2F 250V 50-60Hz conductor 2 with E connection cable 200mm L 42mm ø 23mm Hmm Wmm plastic Qty 1 pcs		

fuses

fine fuses



1

Part No.	358533	Ref. No.	01143561
description	fine fuse size ø5x20mm 6.3A fast-acting rated 250V Qty 10 pcs		

electric accessories

terminals

connection terminals with screw/faston connections



1

Part No.	550411	Ref. No.	0220011
description	power terminal block 6-pole max. 40A max 450V connection ø6mm ² / F6.3 temp.-resist. 150°C cross section 6mm ²		

gas valves and ignition boxes

ignition boxes

HONEYWELL



1

Part No.	102367	Ref. No.	OCEN000
description	ignition box HONEYWELL type S4565A 2092 1 electrodes 3 waiting times safety time 10s 220-240V 4VA 50/60Hz		



ignition parts

pilot burners

SIT

100 series

accessories

pilot burner bottom parts



1

Part No.	107701	Ref. No.	020484
description	pilot burner bottom part SIT 100 series nozzle \varnothing 0.2mm		
spare parts for	107701		
	Part No.	100245	Ref. No. 016106
	pilot burner nozzle LPG code 20 bore \varnothing 0.2mm Qty 1 pcs thread M8x0.75		
	Part No.	100916	Ref. No. —
	compression spring for pilot burner Qty 1 pcs		
	Part No.	100917	Ref. No. —
	gasket for pilot burner Qty 1 pcs aluminium		
	Part No.	100918	Ref. No. —
	screw for pilot burner		
accessories for	107701		
	Part No.	100246	Ref. No. —
	pilot burner nozzle natural gas bore \varnothing 0.35mm Qty 1 pcs thread M8x0.75		
	Part No.	100904	Ref. No. —
	locking screw M10x1 for pipe \varnothing 4mm Qty 1 pcs		
	Part No.	100905	Ref. No. —
	locking screw M10x1 for pipe \varnothing 6mm Qty 1 pcs		
	Part No.	102110	Ref. No. —
	pilot tube copper pipe \varnothing 4mm thickness 1mm L 3000mm		
	Part No.	102111	Ref. No. —
	pilot tube copper pipe \varnothing 6mm thickness 1mm L 3000mm		
	Part No.	102742	Ref. No. —
	pilot burner nozzle LPG code 25 bore \varnothing 0.25mm Qty 1 pcs		

pilot burner nozzles



1

Part No.	100245	Ref. No.	016106
description	pilot burner nozzle LPG code 20 bore \varnothing 0.2mm Qty 1 pcs thread M8x0.75		
For models:	105014		

thermocouples

thermopiles

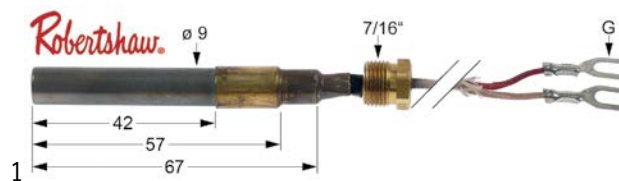

Part No.	102116	Ref. No.	040400130
description	thermopile ROBERTSHAW L 900mm probe \varnothing 9mm probe L 57mm 250-750mV screw connection 7/16"		

gas nozzles

pilot burner nozzles

pilot burner nozzles SIT

100 series



1

Part No.	100245	Ref. No.	016106
description	pilot burner nozzle LPG code 20 bore \varnothing 0.2mm Qty 1 pcs thread M8x0.75		
For models:	105014		

knobs

producer-specific knobs

BARTSCHER



1

Part No.	112620 ¹	Ref. No.	A0YXD1A4A09
description	knob thermostat t.max. 300°C 50-300°C \varnothing 48mm shaft \varnothing 6x4.6mm shaft flat upper black		
For models:	105780, A120788		

¹with rosette 70mm



1

Part No.	112621 ¹	Ref. No.	A0YXD1A4A08
description	knob time 120min t.max. °C°C \varnothing 48mm shaft \varnothing 6x4.6mm shaft flat upper black		
For models:	A120788		

¹with rosette 70mm



handles and hand wheels

handle bars

handle bars



Part No.	694307	Ref. No.	A0YXD1A34
description	handle rod tube \varnothing 19mm thickness 1mm L 453mm SS		
For models:	A120788		

hinges

oven hinges



Part No.	701380	Ref. No.	0A0YXD4A42
description	hinge mounting distance 142mm lever length 116mm groove distance 7mm spring thickness 3.5mm mounting ear position L 155mm W 19mm		
For models:	A120788		

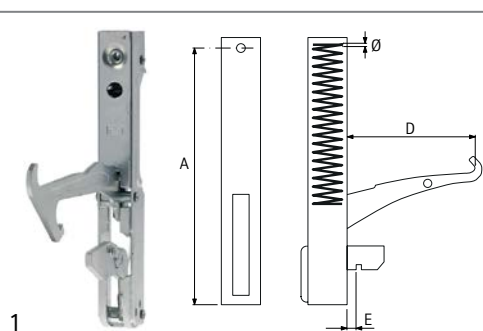

Part No.	700000	Ref. No.	01057803
description	oven hinge mounting distance 142mm mounting distance 2mm lug mountingmm lever length 127mm groove distance 10mm spring thickness 3.7mm mounting ear position L 155mm mounting pos. left/right		
For models:	105780		
accessories for	700000		
	Part No.	693045	Ref. No. —
	opposite support L 110mm W 12mm mounting distance 94mm		
	Part No.	700707	Ref. No. —
	opposite support mounting distance 94mm L 140mm mounting pos. left W 13mm with welded metal sheet H 110mm for hinge		

equipment feet and end caps

equipment feet

with screw mounting



Part No.	513287	Ref. No.	0926117
description	equipment foot tube \varnothing 60mm thread M12 thread L 33mm H 155-235mm SS size 2" Qty 1 pcs		

screw-in feet



Part No.	700966	Ref. No.	A038973
description	equipment foot thread L 20mm \varnothing 37mm H 20mm Qty 1 pcs		
For models:	105780, A120788		

bolting feet



Part No.	697849	Ref. No.	01044461
description	equipment foot H 28mm thread M8 D1 \varnothing 50mm D2 \varnothing 38mm thread L 10mm		
For models:	104447		



Part No.	697996	Ref. No.	016240431
description	equipment foot \varnothing 23mm H 23.5mm bore \varnothing 5mm Qty 1 pcs		



Part No.	697998	Ref. No.	01058356
description	equipment foot \varnothing 24/36mm H 25mm bore \varnothing 19mm Qty 1 pcs thread M8x1.25		



			
1			
Part No.	691509	Ref. No.	OAT93602 A042567 A0AT93602 EB-600-04
description	equipment foot ø 28mm H 17.5mm rubber bore ø 6mm Qty 1 pcs		
For models:	151510, A114001, A150107, A150207, A150671, A150674, A151300, A1515001, A151600, A203093, A203094, EB600		

gaskets

gaskets for heated units

door seals with fixing hook

			
1			
Part No.	901354	Ref. No.	A038980
description	oven gasket L 430mm W 330mm with 8 mounting clips		
For models:	A120788		

O-rings

EPDM

			
1			
Part No.	510408	Ref. No.	011510 011620
description	O-ring EPDM thickness 5.34mm ID ø 47mm Qty 1 pcs		

sealing washers

fibre gaskets

			
1			
Part No.	510405	Ref. No.	012291
description	flat gasket fibre ED ø 56mm ID ø 42mm thickness 2mm for thread 1¼" Qty 1 pcs		

hoses

industrial hoses

Niplaflex hoses

			
1			
Part No.	570561	Ref. No.	011637
description	pressure hose ID ø 10mm ED ø 17mm L 40m thickness 3.5mm operating p. 10bar burst p. 30bar t.max. 110°C		

			
1			
Part No.	530561	Ref. No.	011503
description	pressure hose ID ø 10mm ED ø 17mm L 5m thickness 3.5mm operating p. 10bar burst p. 30bar t.max. 110°C		

ancillary products

clamps

hose clamps

DIN 3017 - W2

			
1			
Part No.	520110	Ref. No.	0423010 neu 21.05.96
description	hose clamp ø 8-12mm width 9mm Qty 10 pcs DIN 3017		

fastening material

screws

cylinder head bolts

DIN 912/ISO 4762

			
1			
Part No.	560305	Ref. No.	A041543
description	cylinder head bolt thread M5 thread L 16mm WS 4 intake internal hexagon DIN 912/ISO 4762		



fasteners

clamps

hose clamps

DIN 3017 - W2



Part No.	520110	Ref. No.	0423010 neu 21.05.96
description	hose clamp ø 8-12mm width 9mm Qty 10 pcs DIN 3017		

consumables

fuses

fine fuses



Part No.	358533	Ref. No.	01143561
description	fine fuse size ø5x20mm 6.3A fast-acting rated 250V Qty 10 pcs		

GASTROPARTS.COM



© 2020 Gastroparts Sp. J. All rights reserved.