



**GASTROPARTS**

# Baron

**[EN]** Cooking

**[DE]** Kochtechnik

**[ES]** Cocción

**[FR]** Cuisson

**[IT]** Cottura

**[PL]** Obróbka termiczna

**[RU]** Термическая обработка

✉ [gastroparts@gastroparts.com](mailto:gastroparts@gastroparts.com)

☎ tel. +48 56 657 00 66

📘 [fb.com/gastroparts.global](https://fb.com/gastroparts.global)

**GASTROPARTS.COM**







## heating elements

## immersion heating elements



1

<b>Part No.</b>	418112	<b>Ref. No.</b>	OA037484 6A037484 BN6A037484
<b>description</b>	heating element 15000W 220V heating circuits 6 L 310mm W 230mm H 130mm thermostat sleeves $\varnothing$ 6/4mm length thermostat sleeves 137/125mm number of thermostat sleeves 2 thermostat sleeve clinging / not clinging connection male faston 6.3mm immersion heater		
<b>For models:</b>	ECVME 10, ECVME 20, ECVME 21, ECVMG 10, ECVMG 20, ECVMG 21, ECVPE 10, ECVPE 20, ECVPE 21, ECVPG 10, ECVPG 20, ECVPG 21		
<b>spare parts for</b>	418112		
	<b>Part No.</b>	375638	<b>Ref. No.</b> OA046186 6A046186 BN6A046186
<b>accessories for</b>	418112		
	<b>Part No.</b>	550692	<b>Ref. No.</b> OA037485 BN6A037485
	gasket silicone thickness 7mm ID $\varnothing$ 193.7mm Qty 1 pcs for heating element suitable for BARON equiv. no. A037485		



1

<b>Part No.</b>	418111	<b>Ref. No.</b>	OA037483 BN6A037483
<b>description</b>	heating element 7500W 220V heating circuits 6 L 310mm W 145mm H 130mm thermostat sleeves $\varnothing$ 6x4mm length thermostat sleeves 137/125mm number of thermostat sleeves 2 thermostat sleeve clinging / not clinging connection male faston 6.3mm immersion heater special fixing		
<b>For models:</b>	ECVME 6, ECVMG 6, ECVPE 6, ECVPG 6		
<b>accessories for</b>	418111		
	<b>Part No.</b>	550692	<b>Ref. No.</b> OA037485 BN6A037485
	gasket silicone thickness 7mm ID $\varnothing$ 193.7mm Qty 1 pcs for heating element suitable for BARON equiv. no. A037485		

## heating elements for convection



1

<b>Part No.</b>	418110	<b>Ref. No.</b>	OA037470 BN6A037470
<b>description</b>	heating element 10500W 230V heating circuits 3 ID $\varnothing$ 370mm ED $\varnothing$ 384mm L 405mm H 141mm L1 20mm W1 105mm H1 41mm H2 100mm flange length 142mm flange width 25mm hole distance 63mm connection M5 tube $\varnothing$ 6.5mm convection heating element hole $\varnothing$ 6mm rectangular flange		
<b>For models:</b>	ECVME 10, ECVME 20, ECVME 6, ECVPE 20		



1

<b>Part No.</b>	418197	<b>Ref. No.</b>	LAR65011250
<b>description</b>	heating element 15000W 230V heating circuits 3 ID $\varnothing$ 512mm ED $\varnothing$ 530mm L 545mm H 130mm L1 15mm W1 105mm H1 25mm H2 105mm flange length 142mm flange width 25mm hole distance 126mm connection M4 connection length 68mm tube $\varnothing$ 8.5mm convection heating element hole $\varnothing$ 6mm rectangular flange		





1

<b>Part No.</b>	415829	<b>Ref. No.</b>	R65011540
<b>description</b>	heating element 7500W 230V heating circuits 3 ID $\varnothing$ 248mm ED $\varnothing$ 260mm L 287mm H 88mm L1 20mm W1 105mm H1 23mm H2 65mm flange length 142mm flange width 25mm hole distance 64mm connection M4 connection length 78mm convection heating element hole $\varnothing$ 5mm rectangular flange		
<b>accessories for</b>	415829		
	<b>Part No.</b>	531270	<b>Ref. No.</b> —
	gasket L 141mm W 22mm D1 $\varnothing$ 10mm D2 $\varnothing$ 9mm 9 holes graphite thickness 1mm suitable for UNOX		



			
1			
<b>Part No.</b>	418107	<b>Ref. No.</b>	0A037460 BN6A037460
<b>description</b>	heating element 7500W 230V heating circuits 3 ID ø 368mm ED ø 385mm L 405mm H 135mm L1 24mm W1 105mm H1 35mm H2 100mm flange length 142mm flange width 24mm hole distance 64mm connection M5 connection length 92mm tube ø 8.5mm convection heating element hole ø 5.5mm rectangular flange		
<b>For models:</b>	ECVME 10, ECVME 20, ECVME 21, ECVME 6, ECVPE 10, ECVPE 21, ECVPE 6		

			
1			
<b>Part No.</b>	418109	<b>Ref. No.</b>	0A037475 BN6A037475
<b>description</b>	heating element 9000W 230V heating circuits 3 ID ø 470mm ED ø 485mm L 520mm H 155mm L1 18mm W1 104mm H1 50mm H2 105mm flange length 142mm flange width 25mm hole distance 63mm connection M5 tube ø 6.5mm convection heating element hole ø 6.3mm rectangular flange		
<b>For models:</b>	ECVME 10, ECVME 20, ECVME 6, ECVPE 20		

			
1			
<b>Part No.</b>	418108	<b>Ref. No.</b>	0A037480 BN6A037480
<b>description</b>	heating element 7500W 230V heating circuits 3 ID ø 475mm ED ø 495mm L 515mm H 143mm L1 15mm W1 105mm H1 43mm H2 100mm flange length 142mm flange width 25mm hole distance 64mm connection M4 tube ø 8.5mm convection heating element hole ø 6mm rectangular flange		
<b>For models:</b>	ECVME 10, ECVME 20, ECVME 21, ECVME 6, ECVPE 10, ECVPE 21		

accessories			
sealing washers			
O-rings			
			
1			
<b>Part No.</b>	510408	<b>Ref. No.</b>	0118462630 BN0118462630
<b>description</b>	O-ring EPDM thickness 5.34mm ID ø 47mm Qty 1 pcs		

			
1			
<b>Part No.</b>	419110	<b>Ref. No.</b>	R65011900
<b>description</b>	heating element 9000W 230V heating circuits 3 ID ø 250mm ED ø 266mm L 290mm H 93mm L1 24mm W1 105mm H1 11mm H2 82mm flange length 142mm flange width 25mm hole distance 63mm connection M4 tube ø 8.5mm hole ø 6.1mm		

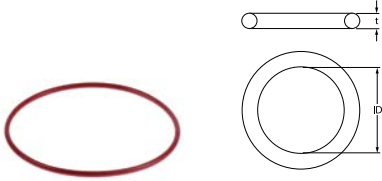
miscellaneous			
			
1			
<b>Part No.</b>	550692	<b>Ref. No.</b>	0A037485 BN6A037485
<b>description</b>	gasket silicone thickness 7mm ID ø 193.7mm Qty 1 pcs for heating element suitable for BARON equiv. no. A037485		
<b>For models:</b>	ECVME 10, ECVME 20, ECVME 21, ECVME 6, ECVMG 10, ECVMG 20, ECVMG 21, ECVMG 6, ECVPE 10, ECVPE 20, ECVPE 21, ECVPE 6, ECVPG 10, ECVPG 20, ECVPG 21, ECVPG 6		



## energy regulators

EGO

1-circuit



<b>Part No.</b>	380015	<b>Ref. No.</b>	41826630141 65080250 826630140 LA65080250 LAR65080250
<b>description</b>	energy regulator 230V 13A single-circuit turn direction right shaft ø 6x4.6mm shaft L 23mm mounting thread M4 power release 6-100% no. 50.57021.010		
<b>For models:</b>	SERIE 900, SERIE700		

## thermostats

bi-metal thermostats

bi-metal thermostats



<b>Part No.</b>	375638	<b>Ref. No.</b>	0A046186 6A046186 BN6A046186
<b>description</b>	bi-metal thermostat hole distance 23.5mm 1NC 1-pole connection F6.3 2 hole fixing		

control and safety thermostats

EGO

control thermostats

55.10/19\_ series



<b>Part No.</b>	375647	<b>Ref. No.</b>	6A046100 BN6A046100
<b>description</b>	thermostat t.max. 110°C temperature range 31-110°C 1-pole 1NO 16A probe ø 6mm probe L 133mm capillary pipe 870mm capillary pipe isolated gland nut shaft ø 6x4.6mm shaft L 23mm shaft position upper rotation 318°		

E-G-O



<b>Part No.</b>	375945	<b>Ref. No.</b>	CR0734520
<b>description</b>	thermostat t.max. 470°C temperature range 90-470°C 1-pole 1NO 16A probe ø 3.9mm probe L 163mm capillary pipe 870mm capillary pipe isolated 600mm shaft ø 4.5x6mm shaft L 23mm shaft position upper rotation 270°		

E-G-O



<b>Part No.</b>	375636	<b>Ref. No.</b>	0A046195 BN6A046195
<b>description</b>	thermostat t.max. 60°C temperature range fixed 60°C 1-pole 1CO 16A probe ø 11mm probe L 29mm capillary pipe 1470mm capillary pipe isolated 1450mm gland nut screw-in probe probe thread M14x1		

55.34\_ series

E-G-O

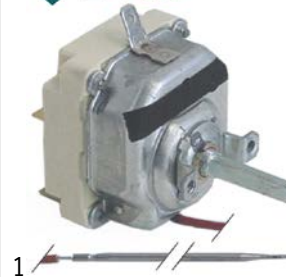

<b>Part No.</b>	375603	<b>Ref. No.</b>	41826630123 41826630161 BN826630123
<b>description</b>	thermostat t.max. 300°C temperature range 50-300°C 3-pole 3NO 16A probe ø 3mm probe L 219mm capillary pipe 900mm capillary pipe isolated 900mm gland nut shaft ø 6x4.6mm shaft L 23mm shaft position upper rotation 270°		
<b>For models:</b>	SERIE 600, SERIE 900, SERIE700		



<b>Part No.</b>	375192	<b>Ref. No.</b>	MA1309115
<b>description</b>	thermostat t.max. 300°C temperature range 50-300°C 3-pole 3NO 16A probe ø 3mm probe L 219mm capillary pipe 900mm capillary pipe isolatedmm gland nut shaft ø 6x4.6mm shaft L 23mm shaft position upper rotation 270°		



<b>Part No.</b>	375412	<b>Ref. No.</b>	6A038400 6A044600 BN6A044600
<b>description</b>	thermostat t.max. 320°C temperature range 50-320°C 3-pole 3NO 16A probe ø 3.1mm probe L 226mm capillary pipe 1480mm capillary pipe isolated 1400mm gland nut shaft ø 6x4.6mm shaft L 23mm shaft position upper rotation 318°		



<b>Part No.</b>	390076	<b>Ref. No.</b>	6A044900
<b>description</b>	thermostat t.max. 320°C temperature range 50-320°C 3-pole probe ø 3mm probe L 219mm capillary pipe isolatedmm gland nut		

safety thermostats

55.10/19\_ series



<b>Part No.</b>	375285	<b>Ref. No.</b>	6A049500 BN6A049500
<b>description</b>	safety thermostat switch-off temp. 327°C 1-pole 1NC 16A probe ø 6mm probe L 77mm capillary pipe 870mm capillary pipe isolatedmm gland nut probe SS		

55.32\_ series



<b>Part No.</b>	375277	<b>Ref. No.</b>	41826630350 85326010002 BN41826630350
<b>description</b>	safety thermostat switch-off temp. 150°C 3-pole 3NC 20A probe ø 6mm probe L 79mm capillary pipe 900mm capillary pipe isolated 700mm gland nut probe		
<b>For models:</b>	SERIE 600, SERIE 900, SERIE700		



<b>Part No.</b>	375649	<b>Ref. No.</b>	6A049405
<b>description</b>	safety thermostat switch-off temp. 160°C 3-pole 20A probe ø 6mm probe L 87mm capillary pipe 890mm capillary pipe isolated 880mm gland nut probe SS		



E-G-O



1

<b>Part No.</b>	375380	<b>Ref. No.</b>	BN6A049405
<b>description</b>	safety thermostat switch-off temp. 160°C 3-pole 20A probe ø 6mm probe L 89mm capillary pipe 900mm capillary pipe isolated 900mm gland nut probe SS		

E-G-O



1

<b>Part No.</b>	375684	<b>Ref. No.</b>	LA65070350
<b>description</b>	safety thermostat switch-off temp. 360°C 1-pole 20A probe ø 11mm probe L 16mm capillary pipe 900mm capillary pipe isolated 900mm gland nut probe screw-in probe probe thread M14x1		

E-G-O

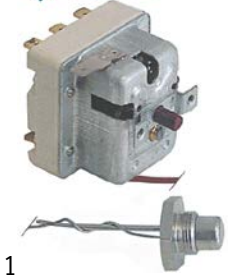

1

<b>Part No.</b>	375635	<b>Ref. No.</b>	0A046190 6A046190 BN6A046190
<b>description</b>	safety thermostat switch-off temp. 300°C 1-pole 20A probe ø 11mm probe L 16mm capillary pipe 900mm capillary pipe isolated 900mm gland nut screw-in probe probe thread M14x1		
<b>For models:</b>	ECVME 10, ECVME 20, ECVME 21, ECVME 6, ECVMG 10, ECVMG 20, ECVMG 21, ECVMG 6, ECVPE 10, ECVPE 20, ECVPE 21, ECVPE 6, ECVPG 10, ECVPG 20, ECVPG 21, ECVPG 6		

E-G-O



1

<b>Part No.</b>	375562	<b>Ref. No.</b>	41826630130 BN826630130
<b>description</b>	safety thermostat switch-off temp. 360°C 3-pole 20A probe ø 4mm probe L 120mm capillary pipe 900mm capillary pipe isolated 900mm gland nut probe SS		
<b>For models:</b>	7BRF/E805, SERIE 600, SERIE 900, SERIE700		

various

safety thermostats

E-G-O

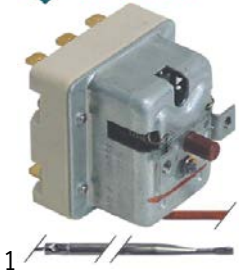

1

<b>Part No.</b>	375228	<b>Ref. No.</b>	6A046150 BN6A046150
<b>description</b>	safety thermostat switch-off temp. 350°C 3-pole 20A probe ø 3mm probe L 188mm capillary pipe 900mm capillary pipe isolated 900mm gland nut probe SS		

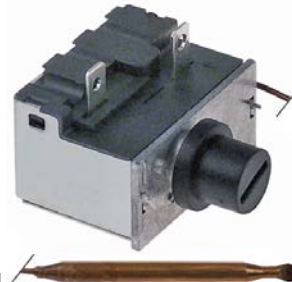

1

<b>Part No.</b>	375637	<b>Ref. No.</b>	0A046185 BN6A046185
<b>description</b>	safety thermostat switch-off temp. 135°C temperature range°C 1-pole 1NC 16A probe ø 6mm probe L 75mm capillary pipe 600mm capillary pipe isolatedmm gland nut shaft ømm probe copper 250V		
<b>For models:</b>	ECVPE 10, ECVPE 20, ECVPE 21, ECVPE 6, ECVPG 10, ECVPG 20, ECVPG 21, ECVPG 6		





accessories

gland nut accessories

bolts with slot

 <p>1</p>			
<b>Part No.</b>	520243	<b>Ref. No.</b>	BN6A038801
<b>description</b>	bolt with slot thread M9x1 Qty 10 pcs nickel-plated brass		
<b>accessories for</b>	520243		
	<b>Part No.</b>	510591	<b>Ref. No.</b> —
	washer with slot ED ø 8.8mm slit width 1.2mm Qty 10		
	<b>Part No.</b>	510592	<b>Ref. No.</b> —
	gasket ø 8x8.7mm Qty 10 pcs slotted silicone		

connecting bows

 <p>1</p>			
<b>Part No.</b>	550060	<b>Ref. No.</b>	6A045900 821550060 BN6A045900 MA1988500 MA921200
<b>description</b>	connecting bow long for thermostat Qty 1 pcs		

switches and momentary switches

push/momentary push switches



30x22mm



 <p>1</p>			
<b>Part No.</b>	301086	<b>Ref. No.</b>	0A038550 BN6A038550
<b>description</b>	push switch mounting measurements 30x22mm black 2NO 250V 12A 0-1 connection male faston 6.3mm ambient temperature max. 85/55°C protection IP54 with protective collar		
<b>For models:</b>	ECVME 10, ECVME 20, ECVME 21, ECVME 6, ECVMG 10, ECVMG 20, ECVMG 21, ECVMG 6, ECVPE 10, ECVPE 20, ECVPE 21, ECVPE 6, ECVPG 10, ECVPG 20, ECVPG 21, ECVPG 6		

ø25mm

 <p>1</p>			
<b>Part No.</b>	345162 <sup>1</sup>	<b>Ref. No.</b>	41826630200 626630200 BN826630200
<b>description</b>	push switch mounting ø 25mm yellow 2NO 250V 16A illuminated connection male faston 6.3mm ambient temperature max. 85°C protection IP40		
<b>For models:</b>	7BM/E410, 7BMV/E800, SERIE 600, SERIE 900, SERIE GIANO 110, SERIE700		

<sup>1</sup>illuminated

 <p>1</p>			
<b>Part No.</b>	346318	<b>Ref. No.</b>	41826630050 BN41826630050 BN826630050
<b>description</b>	momentary push switch mounting ø 25mm red 1NO 250V 16A with cover cap ignition connection male faston 6.3mm ambient temperature max. 85°C protection IP65		
<b>For models:</b>	SERIE 900, SERIE GIANO 110, SERIE GIANO 140, SERIE700		
<b>accessories for</b>	346318		
	<b>Part No.</b>	345039	<b>Ref. No.</b>
	41826630060 41826630420 826630060 826630420 BN826630060 BN826630420 CR0410310		
	protective cover round ED ø 33mm external size 23mm internal size 21mm H 12mm clear mounting ø 25mm		

 <p>1</p>			
<b>Part No.</b>	345039	<b>Ref. No.</b>	41826630060 41826630420 BN826630060 BN826630420 CR0410310
<b>description</b>	protective cover round ED ø 33mm external size 23mm internal size 21mm H 12mm clear mounting ø 25mm		
<b>For models:</b>	7BM/E410, 7BMV/E800, 7FRI/G815, 7FT/G800, 7FTT/G405, 7FTT/G410, SERIE 600, SERIE 900, SERIE GIANO 110, SERIE GIANO 140, SERIE700		
<b>accessories for</b>	345039		
	<b>Part No.</b>	345001	<b>Ref. No.</b> —
	momentary push switch mounting ø 25mm yellow 1NO/indicator light 250V 16A cover connection male faston 6.3mm ambient temperature max. 85°C protection IP65		



## 2 hole fixing



<b>Part No.</b>	346359	<b>Ref. No.</b>	3108870 BN3108870
<b>description</b>	momentary push switch connection cable ambient temperature max. 85°C protection IP40 door contact switch		
<b>For models:</b>	ECVME 10, ECVME 20, ECVME 21, ECVME 6, ECVMG 10, ECVMG 20, ECVMG 21, ECVMG 6, ECVPE 10, ECVPE 20, ECVPE 21, ECVPE 6, ECVPG 10, ECVPG 20, ECVPG 21, ECVPG 6		

## accessories

## blank elements



<b>Part No.</b>	346353	<b>Ref. No.</b>	3102870 BN3102870
<b>description</b>	dummy element		

## microswitches

## lever actuated



<b>Part No.</b>	345773	<b>Ref. No.</b>	85326043085
<b>description</b>	microswitch with lever 250V 16A 1CO connection male faston 6.3mm L 60mm ambient temperature max. 125°C mounting distance 22mm actuating force: 65g lever length 51mm		
<b>For models:</b>	SERIE 900, SERIE700		

## pin-plunger actuated

## M10



<b>Part No.</b>	345032	<b>Ref. No.</b>	6A039800 BN6A039800
<b>description</b>	microswitch with plunger thread M10x1 thread L 12mm 250V 16A 1CO connection male faston 6.3mm stroke 7mm mounting distance 22mm L 28mm ambient temperature max. 125°C type SP9603 actuating force: 180g		
<b>For models:</b>	7FRI/E610		

## cam switches

## 5 operating positions

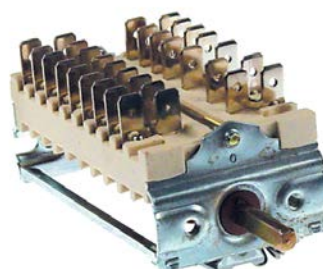

<b>Part No.</b>	346352	<b>Ref. No.</b>	0A046015 BN6A046015
<b>description</b>	cam switch 5 operating positions 5NO/2CO sequence 1-0-2-3-4 16A shaft ø 6x4.6mm shaft L 23mm connection male faston 6.3mm ceramic		

## operation switches



<b>Part No.</b>	300002	<b>Ref. No.</b>	41826630150 6A046001 BN6A046001
<b>description</b>	cam switch 2 operating positions 4NO 16A sequence 0-1 shaft ø 6x4.6mm shaft L 23mm connection male faston 6.3mm ceramic		
<b>For models:</b>	SERIE 600, SERIE 900, SERIE700		



<b>Part No.</b>	300080	<b>Ref. No.</b>	65085010 6A044800 710300 MA710300 R65085010
<b>description</b>	cam switch 2 operating positions 4NO 16A sequence 0-1 shaft ø 6x4.6mm shaft L 23mm connection screw operation switch ceramic ambient temperature max. 150°C		
<b>accessories for</b>	300080		
	<b>Part No.</b>	551456	<b>Ref. No.</b> —
	gasket for switch ED ø 14mm ID ø 2.5mm thickness 3.5mm white		



1

<b>Part No.</b>	300200	<b>Ref. No.</b>	65260030 6A046000 LAR65260030 MA1037313200
<b>description</b>	operation switch 2 operating positions 2NO 16A sequence 0-1 shaft $\varnothing$ 6x4.6mm shaft L 23mm connection male faston 6.3mm operation switch ceramic		

miscellaneous



1

<b>Part No.</b>	346360	<b>Ref. No.</b>	3108879 BN3108879
<b>description</b>	switch mounting pos. door		
<b>For models:</b>	ECVME 20, ECVME 21, ECVME 6, ECVMG 10, ECVMG 20, ECVMG 21, ECVMG 6, ECYPE 10, ECYPE 20, ECYPE 21, ECYPE 6, ECYPG 10, ECYPG 20, ECYPG 21, ECYPG 6		

magnetic switches

40x13mm

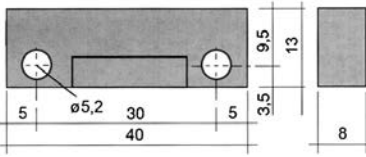
1

<b>Part No.</b>	346351	<b>Ref. No.</b>	346351 418SA047085 6A047085 BN6A047085
<b>description</b>	magnetic switch L 40mm W 13mm 1NO 250V 0.04A P max. 10W connection cable cable length 650mm		

control equipment

MOELLER/EATON

switches (complete)

rotary switches



1

<b>Part No.</b>	346461	<b>Ref. No.</b>	LAR65080150
<b>description</b>	rotary switch mounting measurements $\varnothing$ 22mm black latching 1NC/1NO sequence 0-1		

accessories

magnets

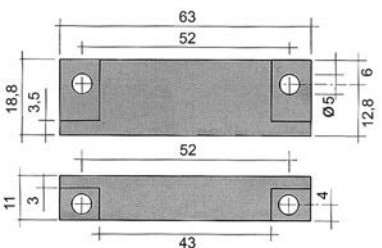
1

<b>Part No.</b>	345336	<b>Ref. No.</b>	3108889 BN3108890
<b>description</b>	magnet $\varnothing$ 4.8mm L 63mm H 11mm W 18.8mm hole distance 51mm M4		
<b>For models:</b>	ECVME 10, ECVME 20, ECVME 21, ECVME 6, ECVMG 10, ECVMG 20, ECVMG 21, ECVMG 6, ECYPE 10, ECYPE 20, ECYPE 21, ECYPE 6, ECYPG 10, ECYPG 20, ECYPG 21, ECYPG 6		

SIEMENS

3SB series  $\varnothing$  16mm

push buttons



1

<b>Part No.</b>	346356	<b>Ref. No.</b>	3102801 BN3102801
<b>description</b>	push button mounting measurements $\varnothing$ 16mm green		

encoders and potentiometers





1

<b>Part No.</b>	401194	<b>Ref. No.</b>	3103267 BN3103267
<b>description</b>	encoder		
<b>For models:</b>	ECVME 10, ECVME 20, ECVME 21, ECVME 6, ECVMG 10, ECVMG 20, ECVMG 21, ECVMG 6, ECYPE 10, ECYPE 20, ECYPE 21, ECYPE 6, ECYPG 10, ECYPG 20, ECYPG 21, ECYPG 6		



			
1			
<b>Part No.</b>	401338	<b>Ref. No.</b>	LAR65301450
<b>description</b>	encoder		

			
1			
<b>Part No.</b>	403084	<b>Ref. No.</b>	LA65301941
<b>description</b>	encoder shaft L 18mm cable length 200mm shaft 6x4.6mm		

			
1			
<b>Part No.</b>	300188	<b>Ref. No.</b>	3103260 BN3103260
<b>description</b>	potentiometer rotation 310° oven		



## lamps

### indicator lights

#### indicator lights 2-piece (lens and indicator lamp)

#### indicator light lenses

#### ø10mm (type SRZ-3)

			
1			
<b>Part No.</b>	359123	<b>Ref. No.</b>	6A038501
<b>description</b>	indicator light housings mounting measurements ø10mm green round Qty 1 pcs		
<b>accessories for</b>	359123		
	<b>Part No.</b>	359132	<b>Ref. No.</b> —
	indicator lamp green 250V connection male faston 6.3mm protection IP54 ambient temperature max. 85°C		

#### ø12mm (type SDY-3)

			
1			
<b>Part No.</b>	359262	<b>Ref. No.</b>	6A001438 BN6A001438
<b>description</b>	indicator light housings mounting measurements ø12mm green round Qty 1 pcs		

			
1			
<b>Part No.</b>	359261	<b>Ref. No.</b>	6A001436 BN6A001436
<b>description</b>	indicator light housings mounting measurements ø12mm red round Qty 1 pcs		

### indicator lights (complete)

#### ø10mm

#### with screw socket

			
1			
<b>Part No.</b>	359380	<b>Ref. No.</b>	CR0682520
<b>description</b>	indicator light ø 10mm 230V red connection male faston 6.3mm socket screw base		

			
1			
<b>Part No.</b>	359379	<b>Ref. No.</b>	CR0587500
<b>description</b>	indicator light ø 10mm 230V yellow connection male faston 6.3mm socket screw base		

#### ø18mm

			
1			
<b>Part No.</b>	346358	<b>Ref. No.</b>	3102850 BN3102850
<b>description</b>	lamp socket ø 18mm 230V without cap		

### screw-on/push-on fit

#### halogen lamp

#### for socket G4 / G6.35 / G9

			
1	<b>500°C</b>		
<b>Part No.</b>	359599	<b>Ref. No.</b>	LA65270020
<b>description</b>	halogen lamp socket G4 12V 20W temp.-resist. 500°C		



fluorescent lamps

accessories

ballasts



1

<b>Part No.</b>	401187	<b>Ref. No.</b>	0A047060 BN6A047060
<b>description</b>	electrical ballast 60W for fluorescent lamps		
<b>For models:</b>	ECVME 10, ECVME 20, ECVME 6, ECVMG 10, ECVMG 20, ECVMG 6, ECVPE 10, ECVPE 20, ECVPE 6, ECVPG 10, ECVPG 20, ECVPG 6		

oven lamps

lamps

halogen lamps

for socket G4 / G6.35 / G9



1

<b>Part No.</b>	359599	<b>Ref. No.</b>	LA65270020
<b>description</b>	halogen lamp socket G4 12V 20W temp.-resist. 500°C		

sockets

G4 / G5,3 / G6,35



1

<b>Part No.</b>	359836	<b>Ref. No.</b>	3108860 BN3108860
<b>description</b>	lamp socket socket G4 for halogen lamp		
<b>For models:</b>	ECVME 10, ECVME 20, ECVME 21, ECVME 6, ECVMG 10, ECVMG 20, ECVMG 21, ECVMG 6, ECVPE 10, ECVPE 20, ECVPE 21, ECVPE 6, ECVPG 10, ECVPG 20, ECVPG 21, ECVPG 6		

timers

programme timers

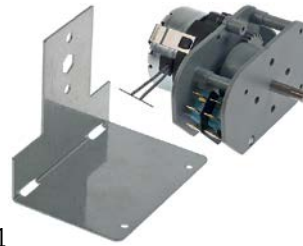

1

<b>Part No.</b>	360633	<b>Ref. No.</b>	0A047080 BN6A047080
<b>description</b>	time switch kit 14000F3 operation time 120min impulse electric shaft ø 6x4.6mm shaft L 20mm CDC 230V engines 1 chambers 2		



1

<b>Part No.</b>	360709	<b>Ref. No.</b>	LAR65090110
<b>description</b>	timer CDC 14003F3 engines 1 chambers 3 operation time 120min shaft ø 6x4.6mm shaft L 22mm manuf. no. 14003F3120ME0.0010		



1

<b>Part No.</b>	360336	<b>Ref. No.</b>	3102335 BN3102335
<b>description</b>	timer FIBER P25 engines 1 chambers 1 operation time 30s 230V shaft ø 6x4.6mm shaft L 18mm manuf. no. P255J01C6R7 motor type M51BJOR6400		
<b>For models:</b>	ECVME 10, ECVME 20, ECVME 21, ECVME 6, ECVMG 10, ECVMG 20, ECVMG 21, ECVMG 6, ECVPE 10, ECVPE 20, ECVPE 21, ECVPE 6, ECVPG 10, ECVPG 20, ECVPG 21, ECVPG 6		
<b>spare parts for</b>	360336		
	<b>Part No.</b>	360673	<b>Ref. No.</b> —
	motor kit pinion ø 6.8mm teeth 15 230V voltage AC 50/60Hz turn direction clockwise motor ø 48mm H 18.5mm motor type UDS-40NE1RNZ165 cable length 150mm with holder		



## alarm devices

## buzzers

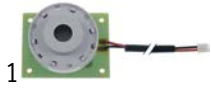

<b>Part No.</b>	350086	<b>Ref. No.</b>	LA65301440 LAR65301440
<b>description</b>	buzzer 12VDC connection cable 200mm PCB buzzer 20dB		

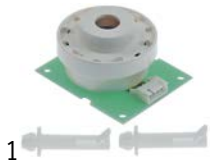

<b>Part No.</b>	350223	<b>Ref. No.</b>	LA65302450
<b>description</b>	buzzer 12VDC connection coded PCB buzzer 20dB		



<b>Part No.</b>	350080	<b>Ref. No.</b>	3103266 BN3103266
<b>description</b>	buzzer buzzer		
<b>For models:</b>	ECVME 10, ECVME 20, ECVME 21, ECVME 6, ECVMG 10, ECVMG 20, ECVMG 21, ECVMG 6, ECVPE 10, ECVPE 20, ECVPE 21, ECVPE 6, ECVPG 10, ECVPG 20, ECVPG 21, ECVPG 6		

## contactors

## GENERAL ELECTRIC (AEG)

## power contactors



<b>Part No.</b>	380239	<b>Ref. No.</b>	0A047031 6A047031 BN6A047031
<b>description</b>	power contactor resistive load 20A 230VAC (AC3/400V) 8.4A/4kW main contacts 3NO auxiliary contacts 1NC connection screw connection type LS05 01A type AEG LS05 01A type GE MC1A 301A		
<b>For models:</b>	ECVME 6, ECVPE 6, ECVPG 6		



<b>Part No.</b>	380337	<b>Ref. No.</b>	0A047037 BN0A047037 BN6A047037
<b>description</b>	power contactor resistive load 20A 230VAC (AC3/400V) 8.4A/4kW main contacts 4NO auxiliary contacts connection screw connection type AEG LS05 400A type GE MC1A 400A		
<b>For models:</b>	ECVME 10, ECVME 20, ECVME 21, ECVME 6, ECVMG 10, ECVMG 20, ECVMG 21, ECVMG 6, ECVPE 10, ECVPE 20, ECVPE 21, ECVPE 6, ECVPG 10, ECVPG 20, ECVPG 21, ECVPG 6		



<b>Part No.</b>	380245	<b>Ref. No.</b>	0A047034 6A047034 BN6A047034
<b>description</b>	power contactor resistive load 25A 230VAC (AC3/400V) 9A/4kW main contacts 3NO auxiliary contacts 1NC connection screw connection type AEG LS4K 01A type GE CL00A 301 H 85mm		
<b>For models:</b>	ECVME 10, ECVME 6, ECVPE 10, ECVPE 20, ECVPE 21, ECVPE 6, ECVPG 10, ECVPG 20, ECVPG 21		



<b>Part No.</b>	380262	<b>Ref. No.</b>	0A047036 BN6A047036
<b>description</b>	power contactor resistive load 32A 230VAC (AC3/400V) 17A/7.5kW main contacts 3NO auxiliary contacts 1NC connection screw connection type AEG LS7K01A type GE CL02A 301 H 85mm		
<b>For models:</b>	ECVME 20, ECVPE 10, ECVPE 20		

1

<b>Part No.</b>	380261	<b>Ref. No.</b>	41853310065 BN41853310065
<b>description</b>	power contactor resistive load 32A 230VAC (AC3/400V) 17A/7.5kW main contacts 3NO auxiliary contacts 1NO connection screw connection type AEG LS7K 10A type GE CLO2A 310		
<b>For models:</b>	SERIE 900, SERIE700		

auxiliary contacts



1

<b>Part No.</b>	380242	<b>Ref. No.</b>	0A047038 6A047038 BN6A047038
<b>description</b>	auxiliary contact contacts 1NO/1NC for contactors M+LS05 connection screw AC-12 10A type AEG HS05K 11HS type GE MARN 211		
<b>For models:</b>	ECVME 21, ECVME 6, ECVMG 10, ECVMG 20, ECVMG 21, ECVMG 6, ECVPE 10, ECVPE 20, ECVPE 21, ECVPE 6, ECVPG 10, ECVPG 20, ECVPG 21, ECVPG 6		

ISKRA (FANAL)

power contactors



1

<b>Part No.</b>	380203	<b>Ref. No.</b>	826630300
<b>description</b>	power contactor resistive load 25A 230VAC (AC3/400V) 9A/4kW main contacts 3NO auxiliary contacts 1NC connection screw connection type Fanal DSL9 01 type ISKRA KNL9 01 230V		



1

<b>Part No.</b>	380204	<b>Ref. No.</b>	85326046038
<b>description</b>	power contactor resistive load 25A 230VAC (AC3/400V) 9A/4kW main contacts 3NO auxiliary contacts 1NO connection screw connection type Fanal DSL9 10 type ISKRA KNL9 10		
<b>For models:</b>	SERIE 600, SERIE 900, SERIE700		

LOVATO

power contactors



1

<b>Part No.</b>	380855	<b>Ref. No.</b>	6A047200 BN826630300	
<b>description</b>	power contactor resistive load 25A 230VAC (AC3/400V) 4.2kW main contacts 3NO auxiliary contacts 1NO			
<b>accessories for</b>	380855			
	<b>Part No.</b>	380055	<b>Ref. No.</b>	—
	RC circuit voltage AC/DC suitable for BF09-32 rated 240V			
	<b>Part No.</b>	380118	<b>Ref. No.</b>	—
	auxiliary contact contacts 1NO/1NC AC1 10A for contactors BF series connection screw type G480/11			

SIEMENS

power contactors



1

<b>Part No.</b>	381387	<b>Ref. No.</b>	CM187301 MACM187301
<b>description</b>	power contactor resistive load 22A 230VAC (AC3/400V) 4kW main contacts 3NO auxiliary contacts 1NO connection screw connection type 3RT2016-1AP01		



1

<b>Part No.</b>	380389	<b>Ref. No.</b>	187300 CM187300 MACM187300
<b>description</b>	power contactor resistive load 22A 230VAC (AC3/400V) 9A/4kW main contacts 3NO auxiliary contacts 1NO connection screw connection type 3RT10-16-1AP01		





## OMRON

## power contactors



1

<b>Part No.</b>	380882	<b>Ref. No.</b>	6A047037
<b>description</b>	power contactor resistive load 25A 230VAC AC3 10A main contacts 3NO auxiliary contacts 1NO connection screw connection type J7KN-10D-10 OMRON		

## relays

## power relays

## with bracket mounting



1

<b>Part No.</b>	380139	<b>Ref. No.</b>	41826630250 BN826630250
<b>description</b>	power relays FINDER 230VAC 16A 2CO connection F6.3 bracket mounting dimensions 68x38.2x35.8mm manuf. no. 62.82.8.230.0000		
<b>For models:</b>	SERIE 900, SERIE700		



1

<b>Part No.</b>	380702	<b>Ref. No.</b>	6A001407
<b>description</b>	power relays FINDER 230VAC 16A 3NO connection male faston 6.3mm flange dimensions 36x38x68mm manuf. no. 62.83.8.230.0300 230V		

## with male contacts

## female contact 2.0mm



1

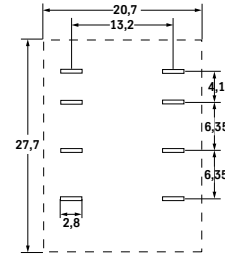

<b>Part No.</b>	380377	<b>Ref. No.</b>	0A047070 6A047070 BN6A047070 FR995940
<b>description</b>	power relays FINDER 220-240VAC 10A 2CO connection F2 plug-in connection manuf. no. 55.32.8.230.0000 94.92.3 250V		
<b>accessories for</b>	380377		
	<b>Part No.</b>	380341	<b>Ref. No.</b> —
	relay socket 4-pole contacts 12 300V voltage AC 6A Italiana Relè manuf. no. ZMD4		
	<b>Part No.</b>	380378	<b>Ref. No.</b> —
	relay socket 2-pole 55/85 dimensions 70.5x30x27mm 250V voltage AC 10A FINDER manuf. no. 94.72		
	<b>Part No.</b>	380384	<b>Ref. No.</b> 0A047074 BN6A047074
	relay socket 2-pole contacts male faston 2.8mm 250V voltage AC 10A W 23mm for		
	<b>Part No.</b>	380399	<b>Ref. No.</b> —
	relay socket 4-pole dimensions 76.2x27x86.1mm 250V voltage AC 1A FINDER manuf. no. 94.94.3		

## relay sockets



1

<b>Part No.</b>	380638	<b>Ref. No.</b>	MA2609500
<b>description</b>	relay socket 8-pole dimensions 51x41x23mm 250V 10A FINDER manuf. no. 90.26		





time relays

time relays



<b>Part No.</b>	380489	<b>Ref. No.</b>	LA65090480
<b>description</b>	time relay CROUZET MUR1-88826105 time range 0.1s-100h 24-240VAC/24VDC 8A mounting measurements DIN railmm 1CO connection grip connection		



<b>Part No.</b>	380386	<b>Ref. No.</b>	0A047065 BN6A047065
<b>description</b>	time relay CROUZET MUS2-88826004 time range 0.1s-100h 24-240VAC 0.7A 1NO connection grip connection		

transformers

open transformers

with clamp terminal

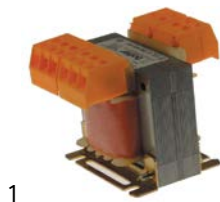

<b>Part No.</b>	401189	<b>Ref. No.</b>	0A047047 BN6A047047
<b>description</b>	transformer 20VA		
<b>For models:</b>	ECVME 10, ECVME 20, ECVME 21, ECVME 6, ECVMG 10, ECVMG 20, ECVMG 21, ECVMG 6, ECVPE 10, ECVPE 20, ECVPE 21, ECVPE 6, ECVPG 10, ECVPG 20, ECVPG 21, ECVPG 6		

encapsulated transformers

with screw connection



<b>Part No.</b>	400127	<b>Ref. No.</b>	LA65180430
<b>description</b>	transformer primary 230VAC secondary 12VAC 40VA secondary 3.2A H 63mm L 75mm W 78mm connection 2-wire connection systems 50/60Hz moulded		

PMA



<b>Part No.</b>	400126	<b>Ref. No.</b>	LA65180420
<b>description</b>	transformer primary 230VAC secondary 12VAC 20VA secondary 2.1A connection screw 50Hz		

probes

producer-specific probes

probes



<b>Part No.</b>	379936	<b>Ref. No.</b>	3103275 BN3103275
<b>description</b>	temperature probe Pt100 cable Vetrotex probe -200 up to +600°C cable -50 up to +350°C connection 2-wire thread probe ø4-6x100mm cable length 1m		
<b>For models:</b>	ECVME 10, ECVME 20, ECVME 21, ECVME 6, ECVMG 20, ECVMG 21, ECVMG 6, ECVPE 10, ECVPE 20, ECVPE 21, ECVPE 6, ECVPG 10, ECVPG 20, ECVPG 21, ECVPG 6		



<b>Part No.</b>	379935	<b>Ref. No.</b>	3103270 BN3103270
<b>description</b>	temperature probe Pt100 cable Vetrotex probe -200 up to +600°C cable -50 up to +350°C connection 2-wire thread probe ø6x100mm cable length 0.8m		



<b>Part No.</b>	379937	<b>Ref. No.</b>	3103282 BN3103282
<b>description</b>	temperature probe thermocouple K (NiCr-Ni) cable PTFE probe -50 up to 1150°C cable -40 up to +250°C connection 2-wire thread probe ø4x120mm cable length 2.4m -40 up to +250°C		
<b>For models:</b>	ECVME 10, ECVME 20, ECVME 21, ECVME 6, ECVMG 10, ECVMG 20, ECVMG 21, ECVMG 6, ECVPE 10, ECVPE 20, ECVPE 21, ECVPE 6, ECVPG 10, ECVPG 20, ECVPG 21, ECVPG 6		



core probes



<b>Part No.</b>	379939	<b>Ref. No.</b>	3103280 BN3103280
-----------------	--------	-----------------	----------------------

**description** core temperature probe Pt100 cable PTFE probe -40 up to +250°C cable -40 up to +250°C connection plug probe ø4x100mm thread cable length 1.25m handle ø 10mm handle length 90/100mm

**For models:** ECVME 10, ECVME 20, ECVME 21, ECVME 6, ECVMG 10, ECVMG 20, ECVMG 21, ECVMG 6, ECVPE 10, ECVPE 20, ECVPE 21, ECVPE 6, ECVPG 10, ECVPG 20, ECVPG 21, ECVPG 6

**accessories for** 379939

	<b>Part No.</b>	379938	<b>Ref. No.</b>	3103285 BN3103285
<b>description</b> female connector 4-pole				



<b>Part No.</b>	379510	<b>Ref. No.</b>	LA65321102
-----------------	--------	-----------------	------------

**description** core temperature probe thermocouple K (NiCr-Ni) cable PTFE probe -40 up to +250°C cable -40 up to +250°C connection 6-pin connector probe ø3.5x90mm thread cable length 1.1m handle ømm handle length 90mm

accessories

plugs/bushes

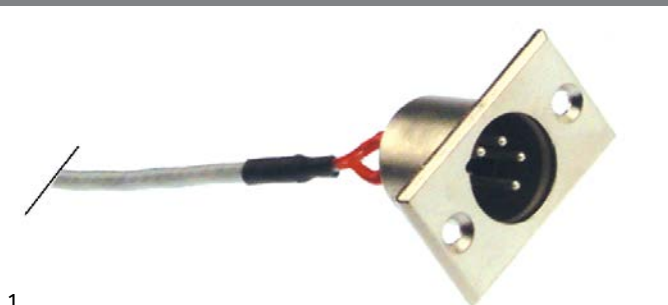

<b>Part No.</b>	379938	<b>Ref. No.</b>	3103285 BN3103285
-----------------	--------	-----------------	----------------------

**description** female connector 4-pole

**For models:** ECVME 10, ECVME 20, ECVME 21, ECVME 6, ECVMG 10, ECVMG 20, ECVMG 21, ECVMG 6, ECVPE 10, ECVPE 20, ECVPE 21, ECVPE 6, ECVPG 10, ECVPG 20, ECVPG 21, ECVPG 6

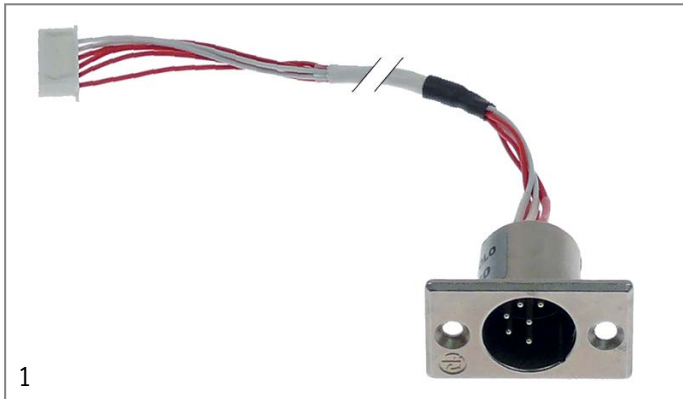

<b>Part No.</b>	381462	<b>Ref. No.</b>	LA65321360
<b>description</b>	female connector with cable 6-pole for combi-steamer L 1000mm		



<b>Part No.</b>	379940	<b>Ref. No.</b>	3103290 BN3103290
-----------------	--------	-----------------	----------------------

**description** lid

**For models:** ECVME 10, ECVME 20, ECVME 21, ECVME 6, ECVMG 10, ECVMG 20, ECVMG 21, ECVMG 6, ECVPE 10, ECVPE 20, ECVPE 21, ECVPE 6, ECVPG 10, ECVPG 20, ECVPG 21, ECVPG 6

electronics

PCBs

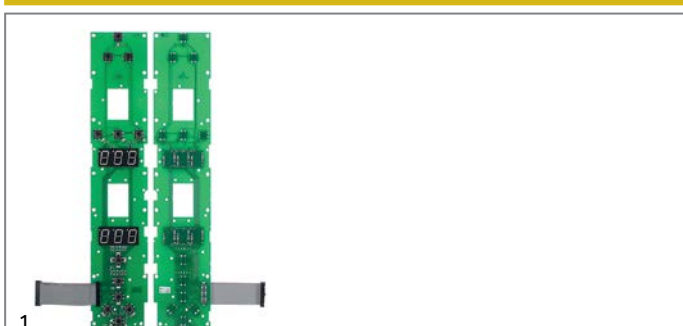

<b>Part No.</b>	403823	<b>Ref. No.</b>	LA65302240
<b>description</b>	keypad PCB for combi-steamer L 443mm W 83mm		



<b>Part No.</b>	401192	<b>Ref. No.</b>	3103249 BN3103249
-----------------	--------	-----------------	----------------------

**description** main PCB

**For models:** ECVME 10, ECVME 20, ECVME 21, ECVME 6, ECVMG 10, ECVMG 20, ECVMG 21, ECVMG 6, ECVPE 10, ECVPE 20, ECVPE 21, ECVPE 6, ECVPG 10, ECVPG 20, ECVPG 21, ECVPG 6

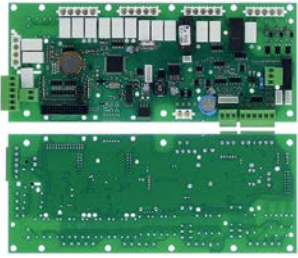
1

<b>Part No.</b>	403824	<b>Ref. No.</b>	LA65302250
<b>description</b>	main PCB for combi-steamer L 250mm W 103mm		



1

<b>Part No.</b>	401195	<b>Ref. No.</b>	3103245 3198400 BN3103245 BN3198400
<b>description</b>	PCB combi-steamer CV10E complete without potentiometer		

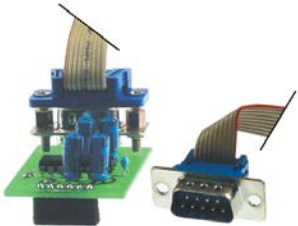

1

<b>Part No.</b>	401193	<b>Ref. No.</b>	3103246 BN3103246
<b>description</b>	PCB HACCP interface		
<b>For models:</b>	ECVME 10, ECVME 20, ECVME 21, ECVME 6, ECVMG 10, ECVMG 20, ECVMG 21, ECVMG 6, ECVPE 10, ECVPE 20, ECVPE 21, ECVPE 6, ECVPG 10, ECVPG 20, ECVPG 21, ECVPG 6		

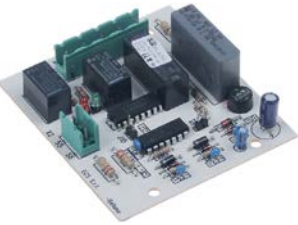

1

<b>Part No.</b>	402924	<b>Ref. No.</b>	BN3103241
<b>description</b>	PCB L 83mm W 74mm suitable for OLIS		

## keypads

### control panel

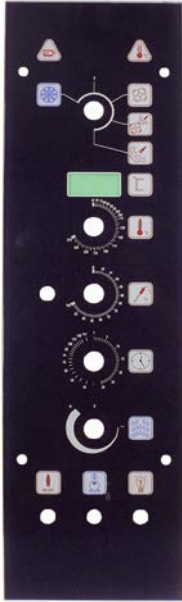

1

<b>Part No.</b>	697946	<b>Ref. No.</b>	BN3108550
<b>description</b>	control panel combi-steamer CV6E W 212mm H 725mm D 6mm suitable for OLIS glas		

## solenoid valves

### solenoid valves (water)

ELBI

spare parts and accessories

reducers

outlet side



1

<b>Part No.</b>	371060	<b>Ref. No.</b>	LA65110520
<b>description</b>	reducer ELBI flow rate 0.25l/min pressure range 0 up to 10bar tolerance ±15/25% green		

RPE



1

<b>Part No.</b>	374021	<b>Ref. No.</b>	3103610 BN3103610
<b>description</b>	solenoid valve double straight 230VAC inlet 3/4" outlet 10mm DN10 RPE		
<b>For models:</b>	ECVPE 10, ECVPE 20, ECVPE 21, ECVPE 6, ECVPG 10, ECVPG 21, ECVPG 6		



			
1			
<b>Part No.</b>	374017	<b>Ref. No.</b>	3103620 BN3103620
<b>description</b>	solenoid valve single straight 230VAC inlet 3/4" outlet 10mm input 6l/min DN10 RPE polyamide flow regulating valve inlet white membranes NBR pressure range 0.2-10bar		
<b>For models:</b>	ECVME 10, ECVME 20, ECVME 21, ECVME 6, ECVMG 10, ECVMG 20, ECVMG 21, ECVMG 6		

<b>JOHN GUEST</b>			
			
1			
<b>Part No.</b>	370768 <sup>1</sup>	<b>Ref. No.</b>	LA65110200
<b>description</b>	solenoid valve single straight 230VAC inlet 3/4" outlet 10mm input/min output/min DN10 t.max. 90°C duty cycle 100% RPE		

<sup>1</sup>cylindrical outlet

<b>reducers</b>			
<b>outlet side</b>			
			
1			
<b>Part No.</b>	371269	<b>Ref. No.</b>	LA65110500
<b>description</b>	reducer flow rate 0.07-0.14l/min brown		

<b>TP</b>			
<b>solenoid valves with reducers</b>			
			
1			
<b>Part No.</b>	370354	<b>Ref. No.</b>	41826630220 BN826630220
<b>description</b>	solenoid valve single angled 230VAC inlet 3/4" outlet 11.5mm output 5l/min t.max. 90°C TP plastic flow regulating valve outlet black flow regulating valve inlet white		
<b>For models:</b>	7BM/E410, 7BMV/E800, SERIE GIANO 110, SERIE700		

## ball valves electric

			
1			
<b>Part No.</b>	401190	<b>Ref. No.</b>	3103590 BN3103590 BN3198150
<b>description</b>	ball valve inlet 3/4" IT outlet 3/4" IT IP42 230V L 68mm 50/60Hz closed off-current mode of operation electric connection cable 300mm 3.5W duty cycle 50%		
<b>For models:</b>	ECVPE 10, ECVPE 20, ECVPE 21, ECVPE 6, ECVPG 10, ECVPG 20, ECVPG 21, ECVPG 6		

## pressure switches

### for steam control

			
1			
<b>Part No.</b>	541074	<b>Ref. No.</b>	3103630 BN3103630 LAR63070050
<b>description</b>	pressure control ø 45mm triggering pressure 0.5bar reset pressure 0.35bar pressure connection vertical steam control pressure range 0.35/0.51bar connection 1/8" pressure connection 1/8"		
<b>For models:</b>	ECVME 10, ECVME 20, ECVME 21, ECVME 6, ECVMG 10, ECVMG 20, ECVMG 21, ECVMG 6		

## electrodes

			
1			
<b>Part No.</b>	401208	<b>Ref. No.</b>	0A037482 BN6A037482
<b>description</b>	level electrode 1/4" total length 150mm probe L 124mm insulated probe length 69mm PTFE insulated connection male faston 6.3mm stainless steel ø 2.5mm		
<b>For models:</b>	ECVME 10, ECVME 20, ECVME 21, ECVME 6, ECVMG 10, ECVMG 20, ECVMG 21, ECVMG 6, ECVPE 10, ECVPE 20, ECVPE 21, ECVPE 6, ECVPG 10, ECVPG 20, ECVPG 21, ECVPG 6		



1

<b>Part No.</b>	401209	<b>Ref. No.</b>	0A037481 BN6A037481
<b>description</b>	level electrode 1/4" total length 180mm probe L 155mm insulated probe length 70mm PTFE insulated connection male faston 6.3mm stainless steel ø 2.5mm		
<b>For models:</b>	ECVME 10, ECVME 20, ECVME 21, ECVME 6, ECVMG 10, ECVMG 20, ECVMG 21, ECVMG 6, ECVPE 10, ECVPE 20, ECVPE 21, ECVPE 6, ECVPG 10, ECVPG 20, ECVPG 21, ECVPG 6		

## fans

### axial fans

#### ebm-papst



1

<b>Part No.</b>	601030 <sup>1</sup>	<b>Ref. No.</b>	3102350 65060050 BN3102350 LA65060050 LAR65060050
<b>description</b>	axial fan L 119mm W 119mm H 38mm 230VAC 50Hz 18W bearing ball bearing manif. no. 4656Z metal connection male faston 2.8mm ebm-papst fan wheel ø 110mm temp.-resist. 75°C		
<b>For models:</b>	ECVME 10, ECVME 20, ECVME 21, ECVME 6, ECVMG 10, ECVMG 20, ECVMG 21, ECVMG 6, ECVPE 10, ECVPE 20, ECVPE 21, ECVPE 6, ECVPG 10, ECVPG 20, ECVPG 21, ECVPG 6		
<b>accessories for</b>	601030		
	<b>Part No.</b>	550898	<b>Ref. No.</b> —
	connecting cable cable length 2000mm connection F 2.8 connection distance 7.9mm for axial flow fan		
	<b>Part No.</b>	692497	<b>Ref. No.</b> —
	guard ø 105mm mounting distance 150mm for axial fan ebm-papstmm		

<sup>1</sup>with ball bearings

### import

1

<b>Part No.</b>	601080 <sup>1</sup>	<b>Ref. No.</b>	MACM303000
<b>description</b>	axial fan L 119mm W 119mm H 38mm 230VAC 50/60Hz 23/20W bearing ball bearing connection male faston 2.8mm metal ADDA fan wheel ø 110mm temp.-resist. 70°C		
<b>accessories for</b>	601080		
	<b>Part No.</b>	550898	<b>Ref. No.</b> —
	connecting cable cable length 2000mm connection F 2.8 connection distance 7.9mm for axial flow fan		
	<b>Part No.</b>	692519	<b>Ref. No.</b> —
	guard L 120mm W 120mm plastic		

<sup>1</sup>with ball bearings

### hot air motors

1

<b>Part No.</b>	550857	<b>Ref. No.</b>	LA58003870 LAR58003870
<b>description</b>	counterflange for fan motor ED ø 50mm int. ø 1 25mm int. ø 2 16mm thickness 6mm brass		

1

<b>Part No.</b>	550859	<b>Ref. No.</b>	LA58003850 LAR58003850
<b>description</b>	counterflange for fan motor ED ø 60mm int. ø 1 34mm int. ø 2 25mm thickness 6mm brass		





1

<b>Part No.</b>	500644	<b>Ref. No.</b>	3102300 BN3102300
<b>description</b>	fan motor 230/400V 3 phase 50/60Hz 0.55kW 0.58HP 1420/1700rpm speeds 1 L1 188mm L2 67mm L3 46mm D1 ø 24mm D2 ø 20mm M12L IT 1.1/1.9A Cos(fi) 0.6 at 50Hz 1420/1700rpm type ST80/4 no. 654282 mounting distance 185mm		
<b>accessories for</b>	500644		
	<b>Part No.</b>	560449	<b>Ref. No.</b> BN3102250 LA58004000 LAR58004000
	hexagonal screw thread M12x1.5 L thread L 22mm bore ø 6.3mm WS 19 total length 30mm		

1

<b>Part No.</b>	500646	<b>Ref. No.</b>	3102200 BN3102200
<b>description</b>	fan motor 230V 1 phase 50/60Hz 0.55kW 1400/1680rpm speeds 1 L1 188mm L2 67mm L3 47mm D1 ø 24mm D2 ø 20mm M12L IT 2.4A suitable capacitor 20µF/450V Cos(fi) 0.95 at 50Hz 1400rpm at 60Hz 1680rpm type LM80/4 no. 601259		
<b>accessories for</b>	500646		
	<b>Part No.</b>	365019	<b>Ref. No.</b> —
	operating capacitor capacity 20µF 400V tolerance 5% 50/60Hz ambient temperature max. -25 to +85°C ø 39.5mm L 70mm M8 plastic connection male faston 6.3mm 16.10.25. protection		
	<b>Part No.</b>	560449	<b>Ref. No.</b> BN3102250 LA58004000 LAR58004000
	hexagonal screw thread M12x1.5 L thread L 22mm bore ø 6.3mm WS 19 total length 30mm		

1

<b>Part No.</b>	500647	<b>Ref. No.</b>	3102210 BN3102210
<b>description</b>	fan motor 230V 1 phase 50Hz 0.13/0.55kW 700/1400rpm speeds 2 L1 188mm L2 64mm L3 46mm D1 ø 24mm D2 ø 20mm 0.66/2.4A suitable capacitor 25µF Cos(fi) 0.98 at 50Hz 700/1400rpm at 60Hz 850/1700rpm 4P/8P type LM/FB80 no. 483823		

1

<b>Part No.</b>	500649	<b>Ref. No.</b>	3102212 BN3102212
<b>description</b>	fan motor 230V 1 phase 50Hz 0.13/0.55kW 700/1400rpm speeds 2 L1 200mm L2 67mm L3 47mm D1 ø 24mm D2 ø 20mm M12L IT 0.66/2.4A suitable capacitor 8/25 µF Cos(fi) 0.98 at 50Hz 700/1400rpm at 60Hz 850/1700rpm 4P/8P type LM/FB80 no. 635521		
<b>For models:</b>	ECVME 10, ECVME 20, ECVME 21, ECVME 6, ECVMG 10, ECVMG 20, ECVMG 21, ECVMG 6, ECVPE 10, ECVPE 20, ECVPE 21, ECVPE 6		

1

<b>Part No.</b>	500645	<b>Ref. No.</b>	3102310 BN3102310
<b>description</b>	fan motor 400V 3 phase 50Hz 0.13/0.55kW 720/1440rpm speeds 2 L1 188mm L2 64mm L3 46mm D1 ø 24mm D2 ø 20mm 0.4/0.85A Cos(fi) 0.60/0.75 at 50Hz 720/1440rpm at 60Hz 860/1720rpm type FB80 4/8 no. 520481		





1

<b>Part No.</b>	500648	<b>Ref. No.</b>	3103212 BN3102312
<b>description</b>	fan motor 400V 3 phase 50Hz 0.13/0.55kW 720/1440rpm speeds 2 L1 198mm L2 65mm L3 47mm D1 ø 24mm D2 ø 20mm M12L IT 400 0.4/0.85A Cos(φ) 0.60/0.75 at 50Hz 720/1440rpm at 60Hz 860/1720rpm type FB80 4/8 no. 500256		
<b>For models:</b>	ECVME 10, ECVME 20, ECVME 21, ECVME 6, ECVPE 10, ECVPE 20, ECVPE 21, ECVPE 6, ECVPG 10, ECVPG 20, ECVPG 21, ECVPG 6		

1

<b>Part No.</b>	601213	<b>Ref. No.</b>	3101600 BN3101600
<b>description</b>	fan wheel D1 ø 335mm H1 135mm blades 16 D2 ø 19.5mm D3 ø 23.5mm H2 50.5mm		
<b>For models:</b>	ECVME 10, ECVME 21, ECVME 6, ECVMG 10, ECVMG 21, ECVMG 6, ECVPE 10, ECVPE 21, ECVPE 6, ECVPG 10, ECVPG 21, ECVPG 6		

1

<b>Part No.</b>	602148	<b>Ref. No.</b>	LA75400471
<b>description</b>	fan wheel blades 12 D1 ø 350mm D2 ø 19.5mm D3 ø 23mm H1 118mm H2 50mm		

1

<b>Part No.</b>	601244	<b>Ref. No.</b>	LA75400440
<b>description</b>	fan wheel D1 ø 350mm H1 114mm blades 12 D2 ø 19.5mm D3 ø 23mm H2 45mm		

1

<b>Part No.</b>	601214	<b>Ref. No.</b>	3101630 BN3101630
<b>description</b>	fan wheel D1 ø 335mm H1 135mm blades 12 D2 ø 19.5mm D3 ø 23.5mm H2 51mm		
<b>For models:</b>	ECVME 20, ECVMG 20, ECVPE 20, ECVPG 20		
<b>accessories for</b>	601214		
	<b>Part No.</b>	560449	<b>Ref. No.</b>
			BN3102250 LA58004000 LAR58004000
	hexagonal screw thread M12x1.5 L thread L 22mm bore ø 6.3mm WS 19 total length 30mm		

1

<b>Part No.</b>	550856	<b>Ref. No.</b>	LA58003860 LAR58003860
<b>description</b>	flange for fan motor ED ø 50mm int. ø 1 19.5mm int. ø 2 16mm thickness 3mm brass		

1

<b>Part No.</b>	550858	<b>Ref. No.</b>	LA58003840 LAR58003840
<b>description</b>	flange for fan motor ED ø 60mm int. ø 1 28.5mm int. ø 2 25mm thickness 4mm brass		

1

<b>Part No.</b>	550850	<b>Ref. No.</b>	3102500 BN3102500
<b>description</b>	flange pair for fan motor ED ø 70mm int. ø 1 43.5mm int. ø 2 24.5mm thickness 5mm brass		
<b>For models:</b>	ECVME 10, ECVME 20, ECVME 21, ECVME 6, ECVMG 10, ECVMG 20, ECVMG 21, ECVMG 6, ECVPE 10, ECVPE 20, ECVPE 21, ECVPE 6, ECVPG 10, ECVPG 20, ECVPG 21, ECVPG 6		



1			
<b>Part No.</b>	550849	<b>Ref. No.</b>	3102400 BN3102400
<b>description</b>	gasket for fan motor ID $\varnothing$ 24mm ED $\varnothing$ 36mm thickness 4.5mm		



1			
<b>Part No.</b>	560449	<b>Ref. No.</b>	BN3102250 LA58004000 LAR58004000
<b>description</b>	hexagonal screw thread M12x1.5 L thread L 22mm bore $\varnothing$ 6.3mm WS 19 total length 30mm		

1			
<b>Part No.</b>	511171	<b>Ref. No.</b>	LA70020040
<b>description</b>	shaft seal ID $\varnothing$ 14.5mm ED $\varnothing$ 20mm thickness 3mm		

1			
<b>Part No.</b>	511172	<b>Ref. No.</b>	LA70020050
<b>description</b>	shaft sealing ID $\varnothing$ 24mm ED $\varnothing$ 29mm thickness 3mm		

## hot air fans

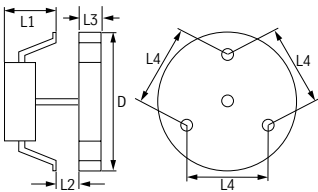
## miscellaneous

1				
				
<b>Part No.</b>	601125	<b>Ref. No.</b>	BN6A036410	
<b>description</b>	hot air fan 220-240V 45W 50/60Hz L1 70mm L2 11mm L3 25mm L4 87mm fan wheel $\varnothing$ 150mm FIME type C30R0479CLF			
<b>accessories for</b>	601125			
	<b>Part No.</b>	550879	<b>Ref. No.</b>	—
	insulation $\varnothing$ 130mm thickness 3mm hole $\varnothing$ 18mm for hot air fan			

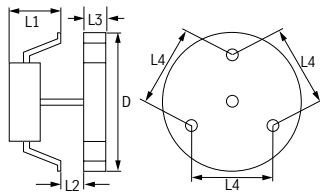
1			
			
<b>Part No.</b>	601339	<b>Ref. No.</b>	6A036410
<b>description</b>	hot air fan 230V 45W L1 78mm L2 13mm L3 25mm L4 87mm fan wheel $\varnothing$ 150mm Medys type 30.200.CLH		

## accessories

## miscellaneous

1			
<b>Part No.</b>	551434	<b>Ref. No.</b>	LA58004010 LAR58004010
<b>description</b>	plain washer $\varnothing$ 30mm thickness 3mm hole $\varnothing$ 12.5mm for fan wheel combi-steamer		

## motors

## gear motors

## for combi-steamers

1			
<b>Part No.</b>	502291	<b>Ref. No.</b>	LA65090260
<b>description</b>	gear motor METEOR type 58U59DB4A1/00 8W 230V voltage AC 50Hz 30rpm shaft $\varnothing$ 6x5mm L 69mm W 49mm H 65mm		





## pumps

### booster pumps II

#### accessories

 <p>1</p>			
<b>Part No.</b>	365015	<b>Ref. No.</b>	LA65190180
<b>description</b>	operating capacitor capacity 10µF 400V tolerance 5%Hz ambient temperature max. -25 to +85°C ø 35.5mm L 59mm M8 plastic connection male faston 6.3mm protection		

### vibration pumps

 <p>1</p>			
<b>Part No.</b>	500568	<b>Ref. No.</b>	R65110600
<b>description</b>	vibration pump 230V 32W 50Hz inlet ø 7 outlet ø 1/8" IT CEME type E512/A32		
<b>spare parts for</b>	500568		
	<b>Part No.</b>	390698	<b>Ref. No.</b> —
	thermal fuse switch-off temp. 110°C suitable for ULKA pump		
	<b>Part No.</b>	520153	<b>Ref. No.</b> —
	bracket rubber dimensions 53x34x28mm		

## condensators & interference suppression filters

### operating capacitors

#### plastic

 <p>1</p>			
<b>Part No.</b>	365015	<b>Ref. No.</b>	LA65190180
<b>description</b>	operating capacitor capacity 10µF 400V tolerance 5%Hz ambient temperature max. -25 to +85°C ø 35.5mm L 59mm M8 plastic connection male faston 6.3mm protection		

## filters

### interference suppression filters

 <p>1</p>			
<b>Part No.</b>	365044	<b>Ref. No.</b>	LA65280200
<b>description</b>	interference suppression filter type FC701Y2F 250V 50-60Hz conductor 2 with E connection cable 200mm L 42mm ø 23mm Hmm Wmm plastic Qty 1 pcs		

## fuses

### fine fuses

#### fine fuse holders

 <p>1</p>			
<b>Part No.</b>	358512	<b>Ref. No.</b>	LA65210020
<b>description</b>	fuse holder		

### overload switches

 <p>1</p>			
<b>Part No.</b>	358515	<b>Ref. No.</b>	LA65160310
<b>description</b>	overload switch drop-away current 2.5A		

## electric accessories

### cables

#### accessories

#### cable glands

#### threaded cable glands

#### screw connections

 <p>1</p>			
<b>Part No.</b>	550971	<b>Ref. No.</b>	MA1037115100
<b>description</b>	cable gland thread PG16 cable ø 14mm mounting ø 22.5mm Qty 1 pcs plastic WS 27		

#### miscellaneous

 <p>1</p>			
<b>Part No.</b>	403839	<b>Ref. No.</b>	LA66110310
<b>description</b>	cable for combi-steamer L 370m copper insulation glass fibre braiding/silicone rubber		



## terminals

## porcelain clamps



1

<b>Part No.</b>	550115	<b>Ref. No.</b>	MA1037117600
<b>description</b>	porcelain terminal block 2-pole 10mm <sup>2</sup> max. 30A max 450V L 37mm W 37mm H 23mm mounting distancemm Qty 1 pcs		

## connection terminals with screw/faston connections



1

<b>Part No.</b>	550278	<b>Ref. No.</b>	MA1037117300
<b>description</b>	power terminal block 3-pole max. 40A max 400V connection ø6mm <sup>2</sup> / F6.3 temp.-resist. 150°C cross section 6mm <sup>2</sup>		



1

<b>Part No.</b>	550411	<b>Ref. No.</b>	MA1037104000
<b>description</b>	power terminal block 6-pole max. 40A max 450V connection ø6mm <sup>2</sup> / F6.3 temp.-resist. 150°C cross section 6mm <sup>2</sup>		



1

<b>Part No.</b>	550977 <sup>1</sup>	<b>Ref. No.</b>	41826630100 BN826630100 CR0588170
<b>description</b>	power terminal block 6-pole max. 40A max 450V connection ø6mm <sup>2</sup> / F6.3 temp.-resist. 150°C cross section 6mm <sup>2</sup> with ground lug		

<sup>1</sup>with ground lug

## various



1

<b>Part No.</b>	693955	<b>Ref. No.</b>	MA1878400
<b>description</b>	terminal grounding cable		

## gas thermostats

## PEL

## 25ST series

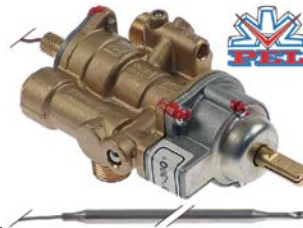

1













<b>Part No.</b>	101991	<b>Ref. No.</b>	41826920330 BN41826920330
<b>description</b>	gas thermostat PEL type 25ST 100-300°C gas inlet M16x1.5 (tube ø 10mm) bypass nozzle ø 0mm gas outlet M16x1.5 (tube ø 10/8mm) thermocouple connection M9x1 pilot connection M10x1 capillary pipe 1200mm probe ø 6mm probe L 100mm shaft ø 8x6.5mm shaft L 21/15mm shaft flat upper		
<b>For models:</b>	SERIE 600		
<b>spare parts for</b>	101991		
	<b>Part No.</b>	101060	<b>Ref. No.</b> —
	magnet unit standard L 39mm D1 ø 15.4mm D2 ø 11mm suitable for PEL20-21/JUNKERS/EGA		
	<b>Part No.</b>	106191	<b>Ref. No.</b> —
	bypass nozzle type PEL22 bore ø 0mm thread M6x0.5		
	<b>Part No.</b>	106200	<b>Ref. No.</b> —
	nut thread M9x1 suitable for PEL 24/25S		
<b>accessories for</b>	101991		
	<b>Part No.</b>	100908	<b>Ref. No.</b> 0100777 41822450040 41822450110 6A016110 822450040 822450110 BN6A016110 BN6A017000 BN822450040 MA673500 R0100777 SIR0100777
	union screw thread M10x1 for pipe ø 4mm Qty 1 pcs		
	<b>Part No.</b>	100909	<b>Ref. No.</b> 6A011705 822450450 BN6A011705 LA62060223 LAR62060223
	union screw thread M10x1 for pipe ø 6mm Qty 1 pcs		
	<b>Part No.</b>	101246	<b>Ref. No.</b> 41822450120 6A016120 822450120 MA673600
	olive for pipe ø 4mm Qty 1 pcs		
	<b>Part No.</b>	101278	<b>Ref. No.</b> 41822450100 6A011480 822450100 MA86720
	olive for pipe ø 10mm Qty 1 pcs		
	<b>Part No.</b>	101286	<b>Ref. No.</b> LA62070023 LAR62070023
	olive ID ø 6mm Qty 1 pcs		
	<b>Part No.</b>	101300	<b>Ref. No.</b> 41822450090 822450090 MA1326500
	union nut thread M16x1.5 tube ø 10mm		

Table continues overleaf



accessories for		101991	
	Part No.	101450	Ref. No. —
olive for pipe ø 8mm L 12.7mm Qty 1 pcs ED ø 10mm			
	Part No.	101451	Ref. No. —
union nut thread M16x1.5 tube ø 8mm			
	Part No.	110079	Ref. No. —
knob dial plate gas thermostat 1-8 silver			
	Part No.	110081	Ref. No. —
knob ø 70mm shaft ø 8x6.5mm shaft flat universal			

## gas valves and ignition boxes

### gas control valves

#### SIT

#### ELETTROSIT













1

Part No.	101127	Ref. No.	6A050000
<b>description</b>	gas valve SIT type ELETTROSIT 230V gas inlet 3/4" gas outlet 3/4" thermocouple connection M9x1 pilot connection M10x1 lateral equiv. no. 0.810.175		
<b>spare parts for</b>	101127		
	Part No.	101312	Ref. No. BN6A050003
microswitch			
	Part No.	101352	Ref. No. —
solenoid coil 230V 50Hz suitable for ELETTROSIT			
<b>accessories for</b>	101127		
	Part No.	100006	Ref. No. —
piezoelectric igniter suitable for ELETTROSIT body plastic blowing connection ø2.4mm ø 14mm			
	Part No.	100904	Ref. No. 6A011608 BN6A011608 MA1394700
locking screw M10x1 for pipe ø 4mm Qty 1 pcs			
	Part No.	100905	Ref. No. 6A011607 BN6A011607
locking screw M10x1 for pipe ø 6mm Qty 1 pcs			
	Part No.	101301	Ref. No. —
gas connection thread 1/2" straight ELETTROSIT screw with O-ring			
	Part No.	101303	Ref. No. —
gas connection straight thread 3/4" ELETTROSIT			
	Part No.	101309	Ref. No. —
extension			

#### NOVASIT











1

Part No.	101908	Ref. No.	418SA050010 MA1871200
<b>description</b>	gas valve SIT series Novasit 820 230V 50Hz gas inlet 1/2" gas outlet 1/2" thermocouple connection M9x1 pilot connection M10x1 ignition pressurebar pressure regulator connection blind equiv. no. 0.820.018 output pilot burner M10x1 input pressure max. 60bar setting range 3-30bar		
<b>spare parts for</b>	101908		
	Part No.	101065	Ref. No. —
magnet unit with cable L 44mm D1 ø 30mm D2 ø 20mm suitable for NOVASIT			
	Part No.	101313	Ref. No. —
solenoid coil 230V 50Hz			
<b>accessories for</b>	101908		
	Part No.	100006	Ref. No. —
piezoelectric igniter suitable for ELETTROSIT body plastic blowing connection ø2.4mm ø 14mm			
	Part No.	101305	Ref. No. —
gas connection straight 1/2" flange 45x45mm ELETTROSIT/V4400/4600/4605 suitable for SIT/HONEYWELL hole distance 36x36mm			
	Part No.	101306	Ref. No. MA2865800
gas connection angled flange 45x45mm hole distance 36x36mm 1/2" ELETTROSIT/V4400/4600/4605 screw with O-ring suitable for SIT/HONEYWELL			
	Part No.	101307	Ref. No. —
gas connection straight flange 45x45mm hole distance 36x36mm 3/4" ELETTROSIT/V4400/4600/4605 screw with O-ring suitable for SIT/HONEYWELL			
	Part No.	101308	Ref. No. —
gas connection angled flange 45x45mm hole distance 36x36mm 3/4" ELETTROSIT/V4400/4600/4605 screw with O-ring suitable for SIT/HONEYWELL			
	Part No.	101312	Ref. No. BN6A050003
microswitch			
	Part No.	101314	Ref. No. —
solenoid coil 24V 50Hz			
	Part No.	101317	Ref. No. —
plug with cable L 1000mm suitable for NOVASIT			
	Part No.	101318	Ref. No. —
cover cap for solenoid coil suitable for NOVASIT			







1			
<b>Part No.</b>	106001	<b>Ref. No.</b>	3103650 BN3103650
<b>description</b>	gas valve SIT series Novasit 826 230V 50Hz gas inlet 1/2" gas outlet 1/2" thermocouple connection pilot connection closed ignition pressure 3-5mbar pressure range 2-50mbar pressure regulator connection standard equiv. no. 0.826.011 power supply for modulator 230VAC rectified		
<b>For models:</b>	ECVMG 10, ECVMG 20, ECVMG 21, ECVMG 6, ECVPG 10, ECVPG 20, ECVPG 21, ECVPG 6		
<b>spare parts for</b>	106001		
	<b>Part No.</b>	101542	<b>Ref. No.</b> —
	solenoid coil 50Hz NOVA 822/826/827 suitable for NOVASIT 230V		
<b>accessories for</b>	106001		
	<b>Part No.</b>	101305	<b>Ref. No.</b> —
	gas connection straight 1/2" flange 45x45mm ELETTROSIT/V4400/4600/4605 suitable for SIT/HONEYWELL hole distance 36x36mm		
	<b>Part No.</b>	101306	<b>Ref. No.</b> MA2865800
	gas connection angled flange 45x45mm hole distance 36x36mm 1/2" ELETTROSIT/V4400/4600/4605 screw with O-ring suitable for SIT/HONEYWELL		
	<b>Part No.</b>	101307	<b>Ref. No.</b> —
	gas connection straight flange 45x45mm hole distance 36x36mm 3/4" ELETTROSIT/V4400/4600/4605 screw with O-ring suitable for SIT/HONEYWELL		
	<b>Part No.</b>	101308	<b>Ref. No.</b> —
	gas connection angled flange 45x45mm hole distance 36x36mm 3/4" ELETTROSIT/V4400/4600/4605 screw with O-ring suitable for SIT/HONEYWELL		
	<b>Part No.</b>	101859	<b>Ref. No.</b> —
	panel-mounted inlet with cable L 1000mm for rectifier suitable for NOVASIT		

<b>accessories</b>			
			
1			
<b>Part No.</b>	101306	<b>Ref. No.</b>	MA2865800
<b>description</b>	gas connection angled flange 45x45mm hole distance 36x36mm 1/2" ELETTROSIT/V4400/4600/4605 screw with O-ring suitable for SIT/HONEYWELL		
<b>spare parts for</b>	101306		
	<b>Part No.</b>	517104	<b>Ref. No.</b> —
	O-ring EPDM thickness 2.62mm ID ø 31.42mm Qty 1 pcs		

			
1			
<b>Part No.</b>	100905	<b>Ref. No.</b>	6A011607 BN6A011607
<b>description</b>	locking screw M10x1 for pipe ø 6mm Qty 1 pcs		

			
1			
<b>Part No.</b>	101312	<b>Ref. No.</b>	BN6A050003
<b>description</b>	microswitch		

## ignition boxes

<b>BRAHMA</b>			
			
1			
<b>Part No.</b>	102337	<b>Ref. No.</b>	3103675 BN3103675
<b>description</b>	ignition box BRAHMA type CM11F electrodes 2 waiting time 1.5s safety time 5s 220-240V 7VA 50-60Hz		
<b>For models:</b>	ECVMG 10, ECVMG 20, ECVMG 21, ECVMG 6, ECVPG 10, ECVPG 20, ECVPG 21, ECVPG 6		

## ignition parts

### pilot burners

<b>SIT</b>			
<b>100 series</b>			
			
1			
<b>Part No.</b>	106906	<b>Ref. No.</b>	27090022 6A001456 6A013200 85327090022 BN6A001456 BN6A013200 LARG3050020
<b>description</b>	pilot burner SIT type 100 series 3 flames nozzle ø 0.2mm gas connection 6mm		
<b>For models:</b>	SERIE 900, SERIE700		
<b>spare parts for</b>	106906		
	<b>Part No.</b>	100245	<b>Ref. No.</b> —
	pilot burner nozzle LPG code 20 bore ø 0.2mm Qty 1 pcs thread M8x0.75		

Table continues overleaf





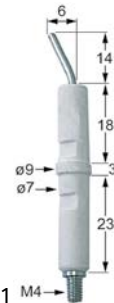

spare parts for		106906	
	Part No.	100855	Ref. No. —
	pilot burner bracket triple		
	Part No.	100885	Ref. No. 6A013104 BN6A013104
	air mixing sleeve for pilot burner Qty 1 pcs		
	Part No.	100916	Ref. No. —
	compression spring for pilot burner Qty 1 pcs		
	Part No.	100917	Ref. No. —
	gasket for pilot burner Qty 1 pcs aluminium ID ø 8.5mm ED ø 11mm thickness 1.2mm		
	Part No.	100918	Ref. No. —
	screw for pilot burner		
	Part No.	107162	Ref. No. —
	pilot burner cap SIT 3 flames Hmm Lmm Qty 1 pcs		
	Part No.	107701	Ref. No. —
	pilot burner bottom part SIT 100 series nozzle ø 0.2mm		
accessories for		106906	
	Part No.	100245	Ref. No. —
	pilot burner nozzle LPG code 20 bore ø 0.2mm Qty 1 pcs thread M8x0.75		
	Part No.	100246	Ref. No. 6A013103
	pilot burner nozzle natural gas bore ø 0.35mm Qty 1 pcs thread M8x0.75		
	Part No.	100904	Ref. No. 6A011608 BN6A011608 MA1394700
	locking screw M10x1 for pipe ø 4mm Qty 1 pcs		
	Part No.	100905	Ref. No. 6A011607 BN6A011607
	locking screw M10x1 for pipe ø 6mm Qty 1 pcs		
	Part No.	102110	Ref. No. —
	pilot tube copper pipe ø 4mm thickness 1mm L 3000mm		
	Part No.	102111	Ref. No. —
	pilot tube copper pipe ø 6mm thickness 1mm L 3000mm		
	Part No.	107171	Ref. No. —
	pilot burner nozzle SIT natural/liquid gas bore ø 0.25mm Qty 1 pcs		
	Part No.	107700	Ref. No. —
	pilot burner bottom part SIT 100 series nozzle ø 0.25mm		
	Part No.	107702	Ref. No. —
	pilot burner bottom part SIT 100 series nozzle ø 0.35mm		

accessories			
pilot burner nozzles			
	1		
<b>Part No.</b>	100246	<b>Ref. No.</b>	6A013103
<b>description</b>	pilot burner nozzle natural gas bore ø 0.35mm Qty 1 pcs thread M8x0.75		

ignition electrodes			
	1		
<b>Part No.</b>	100706	<b>Ref. No.</b>	41853310150 636700 6A013300 85326010046 BN41853310150 MA224211 MA636700
<b>description</b>	ignition electrode connection M4 Qty 1 pcs		
<b>For models:</b>	SERIE 900, SERIE700		











	1		
<b>Part No.</b>	100707	<b>Ref. No.</b>	6A013302 BN6A013302
<b>description</b>	ignition electrode D1 ø 7mm D2 ø 9mm connection ø2.4mm L1 14mm L2 6mm BL1 18mm BL2 3mm BL3 23mm to clip Qty 1 pcs		
<b>For models:</b>	7FRI/G815		

miscellaneous			
	1		
<b>Part No.</b>	100885	<b>Ref. No.</b>	6A013104 BN6A013104
<b>description</b>	air mixing sleeve for pilot burner Qty 1 pcs		







140 - 145 -150 series



<b>Part No.</b>	107114 <sup>1</sup>	<b>Ref. No.</b>	41826920030 BN826920030 MACM029000
<b>description</b>	pilot burner SIT type 140 series 2 flames nozzle ømm gas connectionmm		
<b>For models:</b>	7FT/G800, 7FTT/G405, 7FTT/G410		
<b>spare parts for</b>	107114		
	<b>Part No.</b>	100907	<b>Ref. No.</b> 6A011708 MA1891700
	screw connection thread M10x1 Qty 1 pcs type SEF 1 ømm for thermocouple		
<b>accessories for</b>	107114		
	<b>Part No.</b>	100204	<b>Ref. No.</b> 6A013109 MA1888000
	pilot burner nozzle SIT LPG code 14 bore ø 0.18/0.20mm Qty 1 pcs suitable for 140 series		
	<b>Part No.</b>	100205	<b>Ref. No.</b> 41822140380 822140380 BN822140380
	pilot burner nozzle SIT LPG code 19 bore ø 0.23/0.26mm Qty 1 pcs suitable for SIT 150 series		
	<b>Part No.</b>	100206	<b>Ref. No.</b> —
	pilot burner nozzle SIT natural gas code 36 bore ø 0.60/0.55mm Qty 1 pcs suitable for SIT 150 series		
	<b>Part No.</b>	100207	<b>Ref. No.</b> 41822140120 6A013107 822140120 MA1887800
	pilot burner nozzle SIT natural gas code 27 bore ø 0.40/0.38mm suitable for SIT 140 series		
	<b>Part No.</b>	100216	<b>Ref. No.</b> —
	pilot burner nozzle SIT natural gas code 38 bore ø 0.45mm Qty 1 pcs suitable for SIT 150 series		
	<b>Part No.</b>	100701	<b>Ref. No.</b> 41826650010 826650010 BN41826650010 MA1888300 MA1949900
	ignition electrode connection M4 Qty 1 pcs		
	<b>Part No.</b>	100801	<b>Ref. No.</b> —
	gasket for pilot burner Qty 1 pcs		
	<b>Part No.</b>	100897	<b>Ref. No.</b> 41822450050 822450050 BN822450050 MA1888100
	olive for pipe ø 4mm Qty 1 pcs for pilot burner		
	<b>Part No.</b>	100898	<b>Ref. No.</b> 41822450470 6A011706 822450470 BN41822450470 BN6A011706
	olive for pipe ø 6mm Qty 1 pcs for pilot burner		
	<b>Part No.</b>	100906	<b>Ref. No.</b> 6A011707 MA1888400
	screw connection thread M10x1 for ignition electrode brass Qty 1 pcs WS 10		

<sup>1</sup>incl. thermocouple fitting

<b>accessories for</b>	107114		
	<b>Part No.</b>	100908	<b>Ref. No.</b> 0100777 41822450040 41822450110 6A016110 822450040 822450110 BN6A016110 BN6A017000 BN822450040 MA673500 R0100777 SIR0100777
	union screw thread M10x1 for pipe ø 4mm Qty 1 pcs		
	<b>Part No.</b>	100909	<b>Ref. No.</b> 6A011705 822450450 BN6A011705 LA62060223 LAR62060223
	union screw thread M10x1 for pipe ø 6mm Qty 1 pcs		
	<b>Part No.</b>	102110	<b>Ref. No.</b> —
	pilot tube copper pipe ø 4mm thickness 1mm L 3000mm		
	<b>Part No.</b>	102111	<b>Ref. No.</b> —
	pilot tube copper pipe ø 6mm thickness 1mm L 3000mm		

160 series

















<b>Part No.</b>	100056	<b>Ref. No.</b>	41826920370 BN41826920370
<b>description</b>	pilot burner SIT type 160 series 3 flames nozzle ømm gas connectionmm		
<b>For models:</b>	SERIE 600		
<b>spare parts for</b>	100056		
	<b>Part No.</b>	100907	<b>Ref. No.</b> 6A011708 MA1891700
	screw connection thread M10x1 Qty 1 pcs type SEF 1 ømm for thermocouple		
<b>accessories for</b>	100056		
	<b>Part No.</b>	100202	<b>Ref. No.</b> —
	pilot burner nozzle natural gas code 41 Qty 1 pcs nozzle ø 0.41mm		
	<b>Part No.</b>	100203	<b>Ref. No.</b> 822140370
	pilot burner nozzle LPG code 25 Qty 1 pcs nozzle ø 0.25mm		
	<b>Part No.</b>	100701	<b>Ref. No.</b> 41826650010 826650010 BN41826650010 MA1888300 MA1949900
	ignition electrode connection M4 Qty 1 pcs		
	<b>Part No.</b>	100801	<b>Ref. No.</b> —
	gasket for pilot burner Qty 1 pcs		
	<b>Part No.</b>	100869	<b>Ref. No.</b> —
	pilot burner nozzle natural gas code 51 Qty 1 pcs suitable for 160 series nozzle ø 0.51mm		
	<b>Part No.</b>	100870	<b>Ref. No.</b> —
	olive for pipe ø 4mm Qty 1 pcs suitable for 160 series for pilot burner		





Table continues overleaf









accessories for		100056		
	Part No.	100906	Ref. No.	6A011707 MA1888400
screw connection thread M10x1 for ignition electrode brass Qty 1 pcs WS 10				
	Part No.	100908	Ref. No.	0100777 41822450040 41822450110 6A016110 822450040 822450110 BN6A016110 BN6A017000 BN822450040 MA673500 R0100777 SIR0100777
union screw thread M10x1 for pipe ø 4mm Qty 1 pcs				
	Part No.	100909	Ref. No.	6A011705 822450450 BN6A011705 LA62060223 LAR62060223
union screw thread M10x1 for pipe ø 6mm Qty 1 pcs				
	Part No.	101287	Ref. No.	—
olive for pipe ø 6mm Qty 1 pcs				
	Part No.	102110	Ref. No.	—
pilot tube copper pipe ø 4mm thickness 1mm L 3000mm				
	Part No.	102111	Ref. No.	—
pilot tube copper pipe ø 6mm thickness 1mm L 3000mm				
	Part No.	107650	Ref. No.	41822140360 822140360 BN822140360 CR0410100
pilot burner nozzle SIT LPG code 30 Qty 1 pcs				

**190 series**



<b>Part No.</b>	100110	<b>Ref. No.</b>	41826920110 BN41826920110 BN826920110 MA1949700	
<b>description</b>	pilot burner SIT type 190 series 3 flames nozzle ømm gas connectionmm			
<b>For models:</b>	SERIE 900, SERIE700			
<b>accessories for</b>	100110			
	Part No.	100202	Ref. No.	—
pilot burner nozzle natural gas code 41 Qty 1 pcs nozzle ø 0.41mm				
	Part No.	100203	Ref. No.	822140370
pilot burner nozzle LPG code 25 Qty 1 pcs nozzle ø 0.25mm				
	Part No.	100701	Ref. No.	41826650010 826650010 BN41826650010 MA1888300 MA1949900
ignition electrode connection M4 Qty 1 pcs				
	Part No.	100906	Ref. No.	6A011707 MA1888400
screw connection thread M10x1 for ignition electrode brass Qty 1 pcs WS 10				

accessories for		100110		
	Part No.	100907	Ref. No.	6A011708 MA1891700
screw connection thread M10x1 Qty 1 pcs type SEF 1 ømm for thermocouple				
	Part No.	100908	Ref. No.	0100777 41822450040 41822450110 6A016110 822450040 822450110 BN6A016110 BN6A017000 BN822450040 MA673500 R0100777 SIR0100777
union screw thread M10x1 for pipe ø 4mm Qty 1 pcs				
	Part No.	100909	Ref. No.	6A011705 822450450 BN6A011705 LA62060223 LAR62060223
union screw thread M10x1 for pipe ø 6mm Qty 1 pcs				
	Part No.	101282	Ref. No.	MA469000
olive for pipe ø 4mm L 7.4mm Qty 1 pcs				
	Part No.	101287	Ref. No.	—
olive for pipe ø 6mm Qty 1 pcs				
	Part No.	102110	Ref. No.	—
pilot tube copper pipe ø 4mm thickness 1mm L 3000mm				
	Part No.	102111	Ref. No.	—
pilot tube copper pipe ø 6mm thickness 1mm L 3000mm				
	Part No.	107650	Ref. No.	41822140360 822140360 BN822140360 CR0410100
pilot burner nozzle SIT LPG code 30 Qty 1 pcs				

**POLIDORO**

**pilot burners**



	<b>Part No.</b>	100051	<b>Ref. No.</b>	4185327090026 BN4185327090026 SIR0108109
<b>description</b>	pilot burner POLIDORO 3 flames code gas connectionmm			
<b>For models:</b>	SERIE 900, SERIE700			
<b>spare parts for</b>	100051			
	Part No.	100907	Ref. No.	6A011708 MA1891700
screw connection thread M10x1 Qty 1 pcs type SEF 1 ømm for thermocouple				
<b>accessories for</b>	100051			
	Part No.	100000	Ref. No.	—
pilot burner nozzle POLIDORO LPG code 22 bore ø 0.22mm Qty 1 pcs				

Table continues overleaf



<b>accessories for</b> 100051			
	Part No.	100208	Ref. No. —
	pilot burner nozzle POLIDORO LPG code 20 bore ø 0.2mm Qty 1 pcs		
	Part No.	100209	Ref. No. —
	pilot burner nozzle POLIDORO natural gas code 40 bore ø 0.4mm Qty 1 pcs		
	Part No.	100701	Ref. No. 41826650010 826650010 BN41826650010 MA1888300 MA1949900
	ignition electrode connection M4 Qty 1 pcs		
	Part No.	100906	Ref. No. 6A011707 MA1888400
	screw connection thread M10x1 for ignition electrode brass Qty 1 pcs WS 10		
	Part No.	100907	Ref. No. 6A011708 MA1891700
	screw connection thread M10x1 Qty 1 pcs type SEF 1 ømm for thermocouple		
	Part No.	100908	Ref. No. 0100777 41822450040 41822450110 6A016110 822450040 822450110 BN6A016110 BN6A017000 BN822450040 MA673500 R0100777 SIR0100777
	union screw thread M10x1 for pipe ø 4mm Qty 1 pcs		
	Part No.	100909	Ref. No. 6A011705 822450450 BN6A011705 LA62060223 LAR62060223
	union screw thread M10x1 for pipe ø 6mm Qty 1 pcs		
	Part No.	102110	Ref. No. —
	pilot tube copper pipe ø 4mm thickness 1mm L 3000mm		
	Part No.	102111	Ref. No. —
	pilot tube copper pipe ø 6mm thickness 1mm L 3000mm		
	Part No.	102508	Ref. No. —
	union screw thread M10x1 for pipe ø 4mm Qty 5 pcs		
	Part No.	102509	Ref. No. —
	union screw thread M10x1 for pipe ø 6mm Qty 5 pcs		
	Part No.	102699	Ref. No. —
	pilot burner nozzle POLIDORO natural gas code 25.2 bore ø 2x0.25mm Qty 1 pcs 2 bores		
	Part No.	102795	Ref. No. —
	olive for pipe ø 4mm Qty 1 pcs		
	Part No.	102797	Ref. No. —
	olive for pipe ø 6mm Qty 1 pcs		
	Part No.	106703	Ref. No. 6A013230 BN6A013230
	pilot burner nozzle POLIDORO natural gas code 27.2 bore ø 2x0.27mm Qty 1 pcs		
	Part No.	106704	Ref. No. 6A013240 BN6A013240
	pilot burner nozzle POLIDORO LPG code 16.2 bore ø 2x0.16mm Qty 1 pcs		
	Part No.	106763	Ref. No. —
	pilot burner nozzle POLIDORO natural gas code 27.2A bore ø 2x 0.27mm Qty 1 pcs		
	Part No.	106859	Ref. No. —















			
<b>Part No.</b>	100076	<b>Ref. No.</b>	6A013220 BN6A013220
<b>description</b>	pilot burner POLIDORO 3 flames natural gas code 29.2 gas connection 6mm		
<b>For models:</b>	7BR/GM30, 7FRI/G815		
<b>spare parts for</b>	100076		
	Part No.	100907	Ref. No. 6A011708 MA1891700
	screw connection thread M10x1 Qty 1 pcs type SEF 1 ømm for thermocouple		
<b>accessories for</b> 100076			
	Part No.	100000	Ref. No. —
	pilot burner nozzle POLIDORO LPG code 22 bore ø 0.22mm Qty 1 pcs		
	Part No.	100208	Ref. No. —
	pilot burner nozzle POLIDORO LPG code 20 bore ø 0.2mm Qty 1 pcs		
	Part No.	100209	Ref. No. —
	pilot burner nozzle POLIDORO natural gas code 40 bore ø 0.4mm Qty 1 pcs		
	Part No.	100701	Ref. No. 41826650010 826650010 BN41826650010 MA1888300 MA1949900
	ignition electrode connection M4 Qty 1 pcs		
	Part No.	100906	Ref. No. 6A011707 MA1888400
	screw connection thread M10x1 for ignition electrode brass Qty 1 pcs WS 10		
	Part No.	100907	Ref. No. 6A011708 MA1891700
	screw connection thread M10x1 Qty 1 pcs type SEF 1 ømm for thermocouple		
	Part No.	100908	Ref. No. 0100777 41822450040 41822450110 6A016110 822450040 822450110 BN6A016110 BN6A017000 BN822450040 MA673500 R0100777 SIR0100777
	union screw thread M10x1 for pipe ø 4mm Qty 1 pcs		
	Part No.	100909	Ref. No. 6A011705 822450450 BN6A011705 LA62060223 LAR62060223
	union screw thread M10x1 for pipe ø 6mm Qty 1 pcs		
	Part No.	102110	Ref. No. —
	pilot tube copper pipe ø 4mm thickness 1mm L 3000mm		
	Part No.	102111	Ref. No. —
	pilot tube copper pipe ø 6mm thickness 1mm L 3000mm		

Table continues overleaf



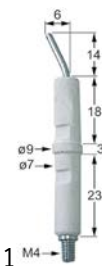

accessories for		100076	
	Part No.	102508	Ref. No. —
	union screw thread M10x1 for pipe ø 4mm Qty 5 pcs		
	Part No.	102509	Ref. No. —
	union screw thread M10x1 for pipe ø 6mm Qty 5 pcs		
	Part No.	102699	Ref. No. —
	pilot burner nozzle POLIDORO natural gas code 25.2 bore ø 2x0.25mm Qty 1 pcs 2 bores		
	Part No.	102795	Ref. No. —
	olive for pipe ø 4mm Qty 1 pcs		
	Part No.	102797	Ref. No. —
	olive for pipe ø 6mm Qty 1 pcs		
	Part No.	106703	Ref. No. 6A013230 BN6A013230
	pilot burner nozzle POLIDORO natural gas code 27.2 bore ø 2x0.27mm Qty 1 pcs		
	Part No.	106704	Ref. No. 6A013240 BN6A013240
	pilot burner nozzle POLIDORO LPG code 16.2 bore ø 2x0.16mm Qty 1 pcs		
	Part No.	106763	Ref. No. —
	pilot burner nozzle POLIDORO natural gas code 27.2A bore ø 2x 0.27mm Qty 1 pcs		
	Part No.	106859	Ref. No. —
	pilot burner nozzle POLIDORO LPG code 24 bore ø 0.24mm Qty 1 pcs		

		<b>Part No.</b>	100706	<b>Ref. No.</b>	41853310150 636700 6A013300 85326010046 BN41853310150 MA224211 MA636700
<b>description</b>		ignition electrode connection M4 Qty 1 pcs			
<b>For models:</b>		SERIE 900, SERIE700			

		<b>Part No.</b>	100707	<b>Ref. No.</b>	6A013302 BN6A013302
<b>description</b>		ignition electrode D1 ø 7mm D2 ø 9mm connection ø2.4mm L1 14mm L2 6mm BL1 18mm BL2 3mm BL3 23mm to clip Qty 1 pcs			
<b>For models:</b>		7FRI/G815			

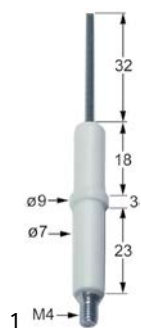
**electrodes**

		<b>Part No.</b>	100701	<b>Ref. No.</b>	41826650010 BN41826650010 MA1888300 MA1949900
<b>description</b>		ignition electrode connection M4 Qty 1 pcs			
<b>For models:</b>		SERIE 600, SERIE 900, SERIE GIANO 110, SERIE GIANO 140, SERIE700			
<b>accessories for</b>		100701			
	Part No.	100906	Ref. No.	6A011707 MA1888400	
	screw connection thread M10x1 for ignition electrode brass Qty 1 pcs WS 10				

		<b>Part No.</b>	106619	<b>Ref. No.</b>	6A013301 BN6A013301
<b>description</b>		ignition electrode D1 ø 7mm D2 ø 9mm L1 8mm BL1 18mm BL2 3mm BL3 23mm to clip connection ø 2.4mm			
<b>For models:</b>		7FT/G800, 7FTT/G405, 7FTT/G410			



2 gas components

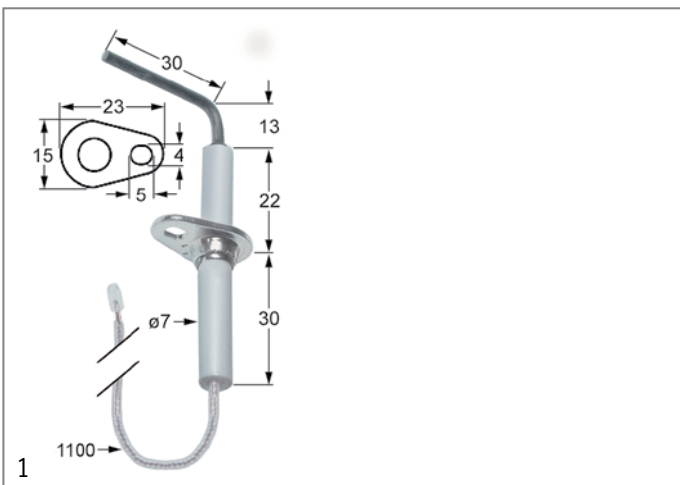

<b>Part No.</b>	102335	<b>Ref. No.</b>	3104900 BN3104900
<b>description</b>	ignition electrode flange length 23mm flange width 15mm D1 ø 7mm L1 13mm L2 30mm BL1 22mm BL2 30mm cable length 1100mm fixing dimensions ø5x4mm with flange		
<b>For models:</b>	ECVMG 10, ECVMG 20, ECVMG 21, ECVMG 6, ECVPG 10, ECVPG 20, ECVPG 21, ECVPG 6		



<b>Part No.</b>	100906	<b>Ref. No.</b>	6A011707 MA1888400
<b>description</b>	screw connection thread M10x1 for ignition electrode brass Qty 1 pcs WS 10		
<b>For models:</b>	7FT/G800, 7FTT/G405, 7FTT/G410		

### ignition cables

#### pre-assembled cables

<b>Part No.</b>	100026	<b>Ref. No.</b>	4185326050065 BN2532997 BN4185326050065 BN85326050065
<b>description</b>	ignition cable cable length 1000mm connection ø4mm / F6.3mm		
<b>For models:</b>	SERIE 900, SERIE700		

<b>Part No.</b>	100179	<b>Ref. No.</b>	41826690061 41826690062 BN826690062 LAR66600400
<b>description</b>	ignition cable cable length 1200mm connection F2.8mm / ø2.4mm		
<b>For models:</b>	SERIE 900, SERIE GIANO 110, SERIE GIANO 140, SERIE700		

<b>Part No.</b>	100025	<b>Ref. No.</b>	6A013000 BN6A013000
<b>description</b>	ignition cable cable length 600mm connection ø4mm / F6.3mm		

<b>Part No.</b>	100016	<b>Ref. No.</b>	2510698 41826690011 BN2510698 BN41826690011
<b>description</b>	ignition cable cable length 900mm connection ø2.4mm / ø2.4mm		
<b>For models:</b>	7FRI/G815		

<b>Part No.</b>	100019	<b>Ref. No.</b>	85326050610 BN4185326050610
<b>description</b>	ignition cable cable length 900mm connection ø2.4mm / ø4mm		
<b>For models:</b>	SERIE 900, SERIE700		

### ignition units

<b>Part No.</b>	102485	<b>Ref. No.</b>	BN6A050100 MA2971400
<b>description</b>	ignition unit outputs 2 220-240VAC 0.6VA 50-60Hz		

<b>Part No.</b>	101002	<b>Ref. No.</b>	6A050100 6A050105
<b>description</b>	ignition unit outputs 2 230VAC dimensions 88x23x34mm mounting distance 73mm inlet F6.3x0.8 outlet F2.8x0.8 0.6VA 50/60Hz		





**thermocouples**

**plug-in thermocouples**

**plug-in thermocouples standard**

with barrel socket  $\varnothing 6(6.5)$ mm

**thermocouples SIT**

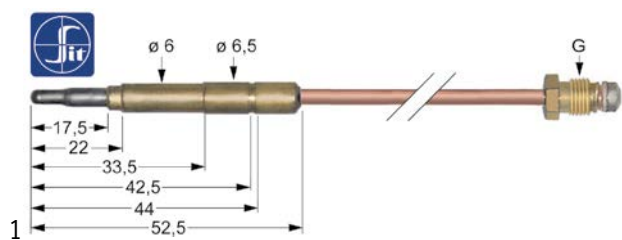

<b>Part No.</b>	107621	<b>Ref. No.</b>	41853310070 BN41853310070 SI0100815 SIR0100815
<b>description</b>	thermocouple SIT M10x1 L 1500mm plug connection $\varnothing 6.0(6.5)$ mm		
<b>For models:</b>	SERIE 900, SERIE700		

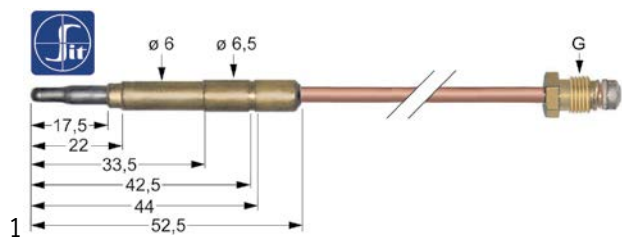

<b>Part No.</b>	107601	<b>Ref. No.</b>	MA1206400
<b>description</b>	thermocouple SIT M8x1 L 600mm plug connection $\varnothing 6.0(6.5)$ mm		

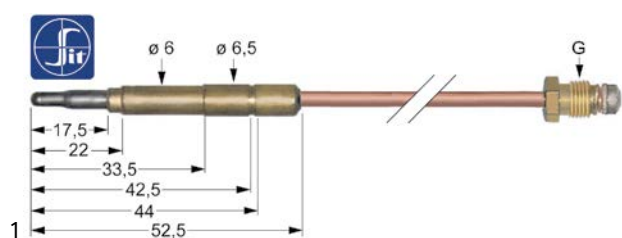

<b>Part No.</b>	107613	<b>Ref. No.</b>	6A001455 BN6A001455
<b>description</b>	thermocouple SIT M9x1 L 1200mm plug connection $\varnothing 6.0(6.5)$ mm		

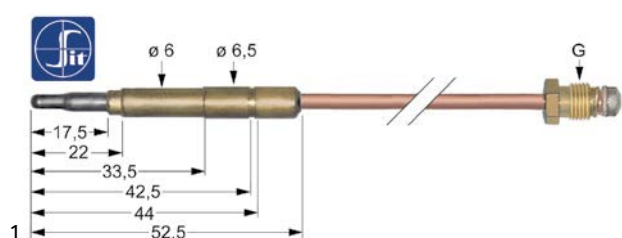

<b>Part No.</b>	107614	<b>Ref. No.</b>	6A011800
<b>description</b>	thermocouple SIT M9x1 L 1500mm plug connection $\varnothing 6.0(6.5)$ mm		

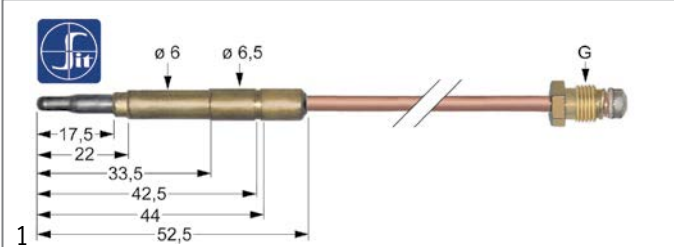

<b>Part No.</b>	107606	<b>Ref. No.</b>	6A011906
<b>description</b>	thermocouple SIT M9x1 L 320mm plug connection $\varnothing 6.0(6.5)$ mm		

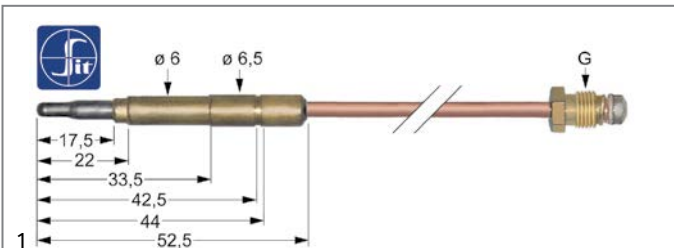

<b>Part No.</b>	107607	<b>Ref. No.</b>	6A011901 BN6A011901
<b>description</b>	thermocouple SIT M9x1 L 400mm plug connection $\varnothing 6.0(6.5)$ mm		

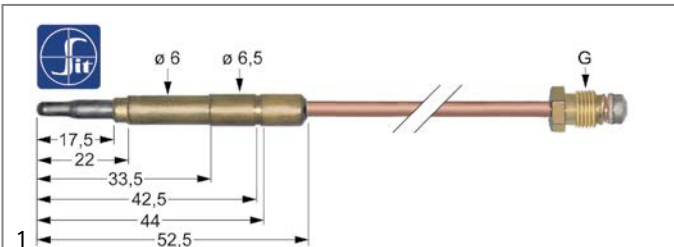

<b>Part No.</b>	107608	<b>Ref. No.</b>	1031504300 6A011902 6A011912 BN6A011902 BN6A011912 MA1031504300
<b>description</b>	thermocouple SIT M9x1 L 500mm plug connection $\varnothing 6.0(6.5)$ mm		

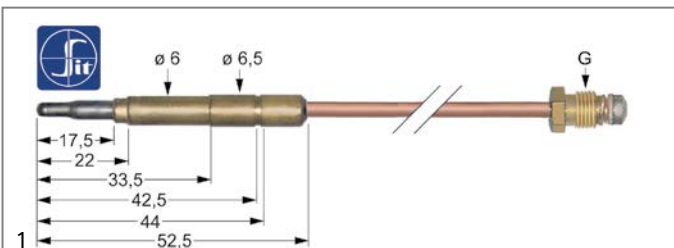

<b>Part No.</b>	107609	<b>Ref. No.</b>	6A011903 85326010055 BN6A011903
<b>description</b>	thermocouple SIT M9x1 L 600mm plug connection $\varnothing 6.0(6.5)$ mm		
<b>For models:</b>	SERIE 900, SERIE700		



<b>Part No.</b>	107611	<b>Ref. No.</b>	41826920080 4185326010057 6A011900 6A011904 BN41826920080 BN4185326010057 BN826920080 MA1916000 MACM029100
<b>description</b>	thermocouple SIT M9x1 L 850mm plug connection $\phi 6.0(6.5)$ mm		
<b>For models:</b>	7FT/G800, 7FTT/G405, 7FTT/G410, 7PCV/G120, SERIE 600, SERIE 900, SERIE GIANO 110, SERIE GIANO 140, SERIE700		

thermocouples with aluminised tip

<b>Part No.</b>	102045	<b>Ref. No.</b>	BN6A011800
<b>description</b>	thermocouple M9x1 L 1500mm plug connection $\phi 6.0(6.5)$ mm		

plug-in thermocouples with interruption

<b>Part No.</b>	107164	<b>Ref. No.</b>	6A011910 BN6A011910 CR0843660
<b>description</b>	thermocouple SIT with interrupter M9x1 L 1000mm plug connection $\phi 6.0(6.5)$ mm soldering connection		
<b>For models:</b>	7FRI/G815		

<b>Part No.</b>	102068	<b>Ref. No.</b>	41826920130 BN41826920130
<b>description</b>	thermocouple SIT with interrupter M9x1 L 320mm plug connection $\phi 6.0$ mm soldering connection		
<b>For models:</b>	SERIE 900, SERIE700		

<b>Part No.</b>	107177	<b>Ref. No.</b>	41826920050 6A011909 BN41826920050 BN6A011909
<b>description</b>	thermocouple SIT with interrupter M9x1 L 600mm plug connection $\phi 6.0$ mm F 6.3mm		
<b>For models:</b>	7FT/G800, 7FTT/G405, 7FTT/G410, SERIE 600, SERIE 900, SERIE GIANO 110, SERIE700		

threaded thermocouples

threaded thermocouples standard

with socket with thread M8x1

SIT

<b>Part No.</b>	107633	<b>Ref. No.</b>	MA1665000
<b>description</b>	thermocouple SIT M8x1 L 1200mm M8x1		
<b>accessories for</b>	107633		
	<b>Part No.</b>	102067	<b>Ref. No.</b> 6A012300 BN6A012300 MA939300
nut thread M8x1 H 3mm brass Qty 1 pcs type SEF 1			

<b>Part No.</b>	107630	<b>Ref. No.</b>	6A011905 BN6A011905
<b>description</b>	thermocouple SIT M8x1 L 600mm M8x1		
<b>accessories for</b>	107630		
	<b>Part No.</b>	102067	<b>Ref. No.</b> 6A012300 BN6A012300 MA939300
nut thread M8x1 H 3mm brass Qty 1 pcs type SEF 1			



<b>Part No.</b>	107635	<b>Ref. No.</b>	6A015900 BN6A015900
<b>description</b>	thermocouple SIT M9x1 L 320mm M8x1		
<b>accessories for</b>	107635		
	<b>Part No.</b>	102067	<b>Ref. No.</b>
			6A012300 BN6A012300 MA939300
nut thread M8x1 H 3mm brass Qty 1 pcs type SEF 1			

<b>Part No.</b>	107636	<b>Ref. No.</b>	6A012000 BN6A012000
<b>description</b>	thermocouple SIT M9x1 L 600mm M8x1		
<b>accessories for</b>	107636		
	<b>Part No.</b>	102067	<b>Ref. No.</b>
			6A012300 BN6A012300 MA939300
nut thread M8x1 H 3mm brass Qty 1 pcs type SEF 1			

**thermopiles**

<b>Part No.</b>	102116	<b>Ref. No.</b>	41826920100 BN826920100
<b>description</b>	thermopile ROBERTSHAW L 900mm probe ø 9mm probe L 57mm 250-750mV screw connection 7/16"		

**accessories**

**nuts**



<b>Part No.</b>	102067	<b>Ref. No.</b>	6A012300 BN6A012300 MA939300
<b>description</b>	nut thread M8x1 H 3mm brass Qty 1 pcs type SEF 1		

**screws**



<b>Part No.</b>	101260	<b>Ref. No.</b>	MA1359100
<b>description</b>	thermocouple fitting thread M8x1 Qty 1 pcs		

**interrupters**



<b>Part No.</b>	101265	<b>Ref. No.</b>	6A013603
<b>description</b>	interrupter thread M9x1		

**gas burners**

**hob burners**

**accessories**

**air mixers**



<b>Part No.</b>	106615	<b>Ref. No.</b>	41822120040 BN822120040
<b>description</b>	air mixing tube L 42mm ø 22mm		
<b>For models:</b>	7FT/G800, 7FTT/G405, 7FTT/G410		

**bar burners**

**bar burners**



<b>Part No.</b>	104216	<b>Ref. No.</b>	85149000 LAR63010120
<b>description</b>	bar burner 1-row ø 50mm Wmm Hmm L 485mm		



1

<b>Part No.</b>	105777 <sup>1</sup>	<b>Ref. No.</b>	3104830 BN3104830
<b>description</b>	bar burner ø 50mm Wmm Hmm L 440mm with bolt M5x25 flange width 57mm flange length 57mm combi-steamer		
<b>For models:</b>	ECVMG 10, ECVMG 6, ECVPG 10, ECVPG 6		

<sup>1</sup>for ovens with 6+10 grids

2

<b>Part No.</b>	105779 <sup>1</sup>	<b>Ref. No.</b>	3104840 BN3104840
<b>description</b>	bar burner ø 50mm Wmm Hmm L 440mm with bolt M5x25 flange width 57mm flange length 57mm gas range		
<b>For models:</b>	ECVMG 21, ECVPG 21		

<sup>1</sup>for ovens with 20 grids

1

<b>Part No.</b>	105778	<b>Ref. No.</b>	3104850 BN3104850
<b>description</b>	bar burner ø 50mm Wmm Hmm L 600mm flange width 57mm flange length 57mm convection oven		
<b>For models:</b>	ECVMG 20, ECVPG 20		

## gas nozzles

### main nozzles

#### gas nozzles M10x1



1

<b>Part No.</b>	100155	<b>Ref. No.</b>	MA2902500
<b>description</b>	gas injector thread M10x1 bore ø 1.45mm L 30mm WS 12		



1

<b>Part No.</b>	106403	<b>Ref. No.</b>	MA707200
<b>description</b>	gas injector thread M10x1 bore ø 1.9mm L 30mm WS 12		



1

<b>Part No.</b>	106474	<b>Ref. No.</b>	41822140220 BN822140220
<b>description</b>	gas injector thread M10x1 WS 12 bore ø 2mm		
<b>For models:</b>	7PCV/G120		

### pilot burner nozzles

#### pilot burner nozzles POLIDORO



1

<b>Part No.</b>	106704	<b>Ref. No.</b>	6A013240 BN6A013240
<b>description</b>	pilot burner nozzle POLIDORO LPG code 16.2 bore ø 2x0.16mm Qty 1 pcs		



1

<b>Part No.</b>	106703	<b>Ref. No.</b>	6A013230 BN6A013230
<b>description</b>	pilot burner nozzle POLIDORO natural gas code 27.2 bore ø 2x0.27mm Qty 1 pcs		

#### pilot burner nozzles SIT

##### 100 series



1

<b>Part No.</b>	100246	<b>Ref. No.</b>	6A013103
<b>description</b>	pilot burner nozzle natural gas bore ø 0.35mm Qty 1 pcs thread M8x0.75		

##### 140/150 series



1

<b>Part No.</b>	100204	<b>Ref. No.</b>	6A013109 MA1888000
<b>description</b>	pilot burner nozzle SIT LPG code 14 bore ø 0.18/0.20mm Qty 1 pcs suitable for 140 series		





1

<b>Part No.</b>	100205	<b>Ref. No.</b>	41822140380 BN822140380
<b>description</b>	pilot burner nozzle SIT LPG code 19 bore ø 0.23/0.26mm Qty 1 pcs suitable for SIT 150 series		
<b>For models:</b>	7FT/G800, 7FTT/G405, 7FTT/G410, 7PCV/G120		





 <p>1</p>			
<b>Part No.</b>	100207	<b>Ref. No.</b>	41822140120 6A013107 MA1887800
<b>description</b>	pilot burner nozzle SIT natural gas code 27 bore ø 0.40/0.38mm suitable for SIT 140 series		
<b>For models:</b>	7FT/G800, 7FTT/G405, 7FTT/G410, 7PCV/G120, SERIE 900, SERIE GIANO 110, SERIE GIANO 140, SERIE700		

160 series			
 <p>1</p>			
<b>Part No.</b>	107649	<b>Ref. No.</b>	41822140440 BN41822140440 MA1033719600
<b>description</b>	pilot burner nozzle SIT LPG code 20 Qty 1 pcs		

 <p>1</p>			
<b>Part No.</b>	107172	<b>Ref. No.</b>	MA1874700
<b>description</b>	pilot burner nozzle SIT LPG code 25 Qty 1 pcs		



 <p>1</p>			
<b>Part No.</b>	107650	<b>Ref. No.</b>	41822140360 BN822140360 CR0410100
<b>description</b>	pilot burner nozzle SIT LPG code 30 Qty 1 pcs		

 <p>1</p>			
<b>Part No.</b>	107174	<b>Ref. No.</b>	1033719700 41822140430 MA1033719700
<b>description</b>	pilot burner nozzle SIT natural gas code 41 Qty 1 pcs		



 <p>1</p>			
<b>Part No.</b>	107175	<b>Ref. No.</b>	41822140350 BN822140350
<b>description</b>	pilot burner nozzle SIT natural gas code 51 Qty 1 pcs suitable for 160 series		



screw connections

olives

 <p>1</p>			
<b>Part No.</b>	101278	<b>Ref. No.</b>	41822450100 6A011480 MA86720
<b>description</b>	olive for pipe ø 10mm Qty 1 pcs		
<b>For models:</b>	7FT/G800, 7FTT/G405, 7FTT/G410, 7PCV/G120		
<b>accessories for</b>	101278		
	<b>Part No.</b>	100943	<b>Ref. No.</b> —
union nut thread M17x1 tube ø 10mm			
	<b>Part No.</b>	101300	<b>Ref. No.</b> 41822450090 822450090 MA1326500
union nut thread M16x1.5 tube ø 10mm			
	<b>Part No.</b>	101478	<b>Ref. No.</b> MA1665200
union nut thread 3/8" for pipe ø 10mm			

 <p>1</p>			
<b>Part No.</b>	106638	<b>Ref. No.</b>	BN6A016300
<b>description</b>	olive for pipe ø 12mm L 10mm Qty 1 pcs		



 <p>1</p>			
<b>Part No.</b>	101273	<b>Ref. No.</b>	0100842 6A016300 MA417810 MA673300 R0100842 SIR0100842
<b>description</b>	olive for pipe ø 12mm L 9.5mm brass Qty 1 pcs suitable for universal		
<b>accessories for</b>	101273		
	<b>Part No.</b>	100944	<b>Ref. No.</b> —
union nut thread M18x1.5 for pipe ø 12mm			
	<b>Part No.</b>	101276	<b>Ref. No.</b> 6A011620 6A011625 MA459300
union screw thread 3/8" tube ø 12mm Qty 1 pcs			

 <p>1</p>			
<b>Part No.</b>	101256	<b>Ref. No.</b>	6A016500 MA1127400
<b>description</b>	olive for pipe ø 16mm Qty 1 pcs		
<b>accessories for</b>	101256		
	<b>Part No.</b>	101253	<b>Ref. No.</b> 6A016401 MA1421000
union nut thread M24x1.5 PEL for pipe ø 16mm			



gas components









			
1			
<b>Part No.</b>	101246	<b>Ref. No.</b>	41822450120 6A016120 MA673600
<b>description</b>	olive for pipe ø 4mm Qty 1 pcs		
<b>For models:</b>	7FT/G800, 7FTT/G405, 7FTT/G410		
<b>accessories for</b>	101246		
	<b>Part No.</b>	100908	<b>Ref. No.</b> 0100777 41822450040 41822450110 6A016110 822450040 822450110 BN6A016110 BN6A017000 BN822450040 MA673500 R0100777 SIR0100777
union screw thread M10x1 for pipe ø 4mm Qty 1 pcs			

			
1			
<b>Part No.</b>	100897	<b>Ref. No.</b>	41822450050 BN822450050 MA1888100
<b>description</b>	olive for pipe ø 4mm Qty 1 pcs for pilot burner		
<b>For models:</b>	7FT/G800, 7FTT/G405, 7FTT/G410, 7PCV/G120		

			
1			
<b>Part No.</b>	100898	<b>Ref. No.</b>	41822450470 6A011706 BN41822450470 BN6A011706
<b>description</b>	olive for pipe ø 6mm Qty 1 pcs for pilot burner		
<b>accessories for</b>	100898		
	<b>Part No.</b>	100909	<b>Ref. No.</b> 6A011705 822450450 BN6A011705 LA62060223 LAR62060223
union screw thread M10x1 for pipe ø 6mm Qty 1 pcs			

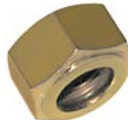
			
1			
<b>Part No.</b>	101286	<b>Ref. No.</b>	LA62070023 LAR62070023
<b>description</b>	olive ID ø 6mm Qty 1 pcs		
<b>accessories for</b>	101286		
	<b>Part No.</b>	100909	<b>Ref. No.</b> 6A011705 822450450 BN6A011705 LA62060223 LAR62060223
union screw thread M10x1 for pipe ø 6mm Qty 1 pcs			
	<b>Part No.</b>	101464	<b>Ref. No.</b> —
union nut thread M12x1 for pipe ø 6mm			

<b>union nuts</b>			
			
1			
<b>Part No.</b>	101253	<b>Ref. No.</b>	6A016401 MA1421000
<b>description</b>	union nut thread M24x1.5 PEL for pipe ø 16mm		
<b>accessories for</b>	101253		
	<b>Part No.</b>	101256	<b>Ref. No.</b> 6A016500 MA1127400
olive for pipe ø 16mm Qty 1 pcs			





<b>union screws</b>			
			
1			
<b>Part No.</b>	100904	<b>Ref. No.</b>	6A011608 BN6A011608 MA1394700
<b>description</b>	locking screw M10x1 for pipe ø 4mm Qty 1 pcs		
<b>For models:</b>	7FRI/G815, 7FT/G800, 7FTT/G405, 7FTT/G410		

			
1			
<b>Part No.</b>	100905	<b>Ref. No.</b>	6A011607 BN6A011607
<b>description</b>	locking screw M10x1 for pipe ø 6mm Qty 1 pcs		

			
1			
<b>Part No.</b>	100906	<b>Ref. No.</b>	6A011707 MA1888400
<b>description</b>	screw connection thread M10x1 for ignition electrode brass Qty 1 pcs WS 10		
<b>For models:</b>	7FT/G800, 7FTT/G405, 7FTT/G410		

			
1			
<b>Part No.</b>	100907	<b>Ref. No.</b>	6A011708 MA1891700
<b>description</b>	screw connection thread M10x1 Qty 1 pcs type SEF 1 ømm for thermocouple		



			
1			
<b>Part No.</b>	100908	<b>Ref. No.</b>	0100777 41822450040 41822450110 6A016110 BN6A016110 BN6A017000 BN822450040 MA673500 R0100777 SIR0100777
<b>description</b>	union screw thread M10x1 for pipe ø 4mm Qty 1 pcs		
<b>For models:</b>	7FT/G800, 7FTT/G405, 7FTT/G410, 7PCV/G120		
<b>accessories for</b>	100908		
			
<b>Part No.</b>	100897	<b>Ref. No.</b>	41822450050 822450050 BN822450050 MA1888100
olive for pipe ø 4mm Qty 1 pcs for pilot burner			
			
<b>Part No.</b>	101246	<b>Ref. No.</b>	41822450120 6A016120 822450120 MA673600
olive for pipe ø 4mm Qty 1 pcs			
			
<b>Part No.</b>	101280	<b>Ref. No.</b>	—
olive for pipe ø 4mm Qty 1 pcs			
			
<b>Part No.</b>	101282	<b>Ref. No.</b>	MA469000
olive for pipe ø 4mm L 7.4mm Qty 1 pcs			

			
1			
<b>Part No.</b>	100909	<b>Ref. No.</b>	6A011705 822450450 BN6A011705 LA62060223 LAR62060223
<b>description</b>	union screw thread M10x1 for pipe ø 6mm Qty 1 pcs		
<b>accessories for</b>	100909		
			
<b>Part No.</b>	100898	<b>Ref. No.</b>	41822450470 6A011706 822450470 BN41822450470 BN6A011706
olive for pipe ø 6mm Qty 1 pcs for pilot burner			
			
<b>Part No.</b>	101286	<b>Ref. No.</b>	LA62070023 LAR62070023
olive ID ø 6mm Qty 1 pcs			
			
<b>Part No.</b>	101287	<b>Ref. No.</b>	—
olive for pipe ø 6mm Qty 1 pcs			
			
<b>Part No.</b>	101288	<b>Ref. No.</b>	—
olive for pipe ø 6mm L 6mm aluminium Qty 1 pcs ED ø 8.5mm			

## equipmentspecific units for convection ovens/combi-steamers

### drain units

#### drip rails

			
1			
<b>Part No.</b>	691961	<b>Ref. No.</b>	LA69180010
<b>description</b>	drain unit L 90mm edition since 2009		

### drain valves

			
1			
<b>Part No.</b>	694977	<b>Ref. No.</b>	LA62280038
<b>description</b>	drain pipe angled 90° polypropylene DN50 for combi-steamer		

### spare parts and accessories

			
1			
<b>Part No.</b>	692835	<b>Ref. No.</b>	LAR58003110
<b>description</b>	pin for air baffle combi-steamer L 38mm ø 7mm		

			
1			
<b>Part No.</b>	694979	<b>Ref. No.</b>	LA69180110
<b>description</b>	thermostatic steam trap for combi-steamer plastic		



## filters



1

<b>Part No.</b>	691271	<b>Ref. No.</b>	LA10201710 LAR10201710
<b>description</b>	drain filter ø 87mm		

## frame



1

<b>Part No.</b>	693398	<b>Ref. No.</b>	41853310100
<b>description</b>	frame for level glass		

## cleaning system

## cleaning arms



1

<b>Part No.</b>	542409	<b>Ref. No.</b>	LAR58007020
<b>description</b>	mounting flange with gasket for wash arm suitable for LAINOX combi-steamer		

## hoses



1

<b>Part No.</b>	694953	<b>Ref. No.</b>	LA80150040
<b>description</b>	hose ID ø 13mm ED ø 23mm L 1mm EPDM blue/white t.max. 120°C for combi-steamer		

## screw connections



1

<b>Part No.</b>	542412	<b>Ref. No.</b>	LAR58007000
<b>description</b>	bolt for flange wash arm L 50mm M12x1 suitable for combi-steamer		

## hoses



1

<b>Part No.</b>	520534	<b>Ref. No.</b>	LA70060040
<b>description</b>	hose ID ø 50mm ED ø 58mm L 50mm silicone Qty 1 for combi-steamer thickness 4mm		



1

<b>Part No.</b>	530901	<b>Ref. No.</b>	LA70060050
<b>description</b>	hose ID ø 54mm ED ø 60mm L 50mm for combi-steamer		

## doors



1

<b>Part No.</b>	697863	<b>Ref. No.</b>	BN3106355
<b>description</b>	locking screw for oven door		

## vibration pumps



1



<b>Part No.</b>	500568	<b>Ref. No.</b>	R65110600
<b>description</b>	vibration pump 230V 32W 50Hz inlet ø 7 outlet ø 1/8" IT CEME type E512/A32		

## spare parts for

	<b>Part No.</b>	390698	<b>Ref. No.</b>	—
	thermal fuse switch-off temp. 110°C suitable for ULKA pump			
	<b>Part No.</b>	520153	<b>Ref. No.</b>	—
	bracket rubber dimensions 53x34x28mm			



miscellaneous			
 <p>1</p>			
<b>Part No.</b>	690099	<b>Ref. No.</b>	LA58002150 LAR58002150
<b>description</b>	hinge pin mounting pos. upper for door		

 <p>1</p>			
<b>Part No.</b>	691297	<b>Ref. No.</b>	LA62030113
<b>description</b>	reducer thread 1/4 / 1/8		
<b>accessories for</b>	691297		
	Part No.	529544	Ref. No. —
	 <p>O-ring EPDM thickness 2.62mm ID ø 7.59mm Qty 1 pcs</p>		

## handles and hand wheels

### cylindrical handles

fixed			
 <p>1</p>			
<b>Part No.</b>	110703	<b>Ref. No.</b>	MA1829200
<b>description</b>	cylindrical handle thread M10 ø 28mm L 87mm		

## locks

### espagnolette locks

producer-specific			
BARON			
 <p>1</p>			
<b>Part No.</b>	514302	<b>Ref. No.</b>	0A011409 BNGA011409
<b>description</b>	ball ø 8mm		
<b>For models:</b>	ECVME 10, ECVME 20, ECVME 21, ECVME 6, ECVMG 10, ECVMG 20, ECVMG 21, ECVMG 6, ECVPE 10, ECVPE 20, ECVPE 21, ECVPE 6, ECVPG 10, ECVPG 20, ECVPG 21, ECVPG 6		

 <p>1</p>			
<b>Part No.</b>	514300	<b>Ref. No.</b>	3107935 BN3107935
<b>description</b>	bush		
<b>For models:</b>	ECVME 10, ECVME 20, ECVME 21, ECVME 6, ECVMG 10, ECVMG 20, ECVMG 21, ECVMG 6, ECVPE 10, ECVPE 20, ECVPE 21, ECVPE 6, ECVPG 10, ECVPG 20, ECVPG 21, ECVPG 6		









 <p>1</p>			
<b>Part No.</b>	514297	<b>Ref. No.</b>	3107915 BN3107915
<b>description</b>	catch hook L 78.6mm D1 ø 28mm D2 ø 32mm D3 ø 40mm		
<b>For models:</b>	ECVME 10, ECVME 20, ECVME 21, ECVME 6, ECVMG 10, ECVMG 20, ECVMG 21, ECVMG 6, ECVPE 10, ECVPE 20, ECVPE 21, ECVPE 6, ECVPG 10, ECVPG 20, ECVPG 21, ECVPG 6		





 <p>1</p>			
<b>Part No.</b>	514416	<b>Ref. No.</b>	3107991 BN3107991
<b>description</b>	catch hook L 92.5mm D1 ø 28mm D2 ø 32mm D3 ø 40mm		





 <p>1</p>			
<b>Part No.</b>	514301	<b>Ref. No.</b>	3107955 BN3107955
<b>description</b>	compression spring ø 6.5mm L 14mm wire gauge ø 1.2mm		
<b>For models:</b>	ECVME 10, ECVME 20, ECVME 21, ECVME 6, ECVMG 10, ECVMG 20, ECVMG 21, ECVMG 6, ECVPE 10, ECVPE 20, ECVPE 21, ECVPE 6, ECVPG 10, ECVPG 20, ECVPG 21, ECVPG 6		

 <p>1</p>			
<b>Part No.</b>	514296	<b>Ref. No.</b>	3107910 BN3107910
<b>description</b>	door catch H 28mm D1 ø 44mm D2 ø 35mm D3 ø 32mm mounting distance 10mm		
<b>For models:</b>	ECVME 10, ECVME 20, ECVME 21, ECVME 6, ECVMG 10, ECVMG 20, ECVMG 21, ECVMG 6, ECVPE 10, ECVPE 20, ECVPE 21, ECVPE 6, ECVPG 10, ECVPG 20, ECVPG 21, ECVPG 6		





			
1			
<b>Part No.</b>	514295	<b>Ref. No.</b>	3107990 BN3107990
<b>description</b>	door handle complete		
<b>spare parts for</b>	514295		
	<b>Part No.</b>	514298	<b>Ref. No.</b> 3107945 BN3107945
	plate		
	<b>Part No.</b>	514299	<b>Ref. No.</b> 3107941 BN3107941
	ring		
	<b>Part No.</b>	514300	<b>Ref. No.</b> 3107935 BN3107935
	bush		
	<b>Part No.</b>	514301	<b>Ref. No.</b> 3107955 BN3107955
	compression spring $\varnothing$ 6.5mm L 14mm wire gauge $\varnothing$ 1.2mm		
	<b>Part No.</b>	514302	<b>Ref. No.</b> 0A011409 BN6A011409
	ball $\varnothing$ 8mm		
	<b>Part No.</b>	514303	<b>Ref. No.</b> 3107930 BN3107930
	pin $\varnothing$ 8mm L 19.5mm		
	<b>Part No.</b>	514416	<b>Ref. No.</b> 3107991 BN3107991
	catch hook L 92.5mm D1 $\varnothing$ 28mm D2 $\varnothing$ 32mm D3 $\varnothing$ 40mm		
<b>accessories for</b>	514295		
	<b>Part No.</b>	514296	<b>Ref. No.</b> 3107910 BN3107910
	door catch H 28mm D1 $\varnothing$ 44mm D2 $\varnothing$ 35mm D3 $\varnothing$ 32mm mounting distance 10mm		

			
1			
<b>Part No.</b>	514394	<b>Ref. No.</b>	3107900 BN3107900
<b>description</b>	door handle complete		
<b>spare parts for</b>	514394		
	<b>Part No.</b>	514297	<b>Ref. No.</b> 3107915 BN3107915
	catch hook L 78.6mm D1 $\varnothing$ 28mm D2 $\varnothing$ 32mm D3 $\varnothing$ 40mm		
	<b>Part No.</b>	514298	<b>Ref. No.</b> 3107945 BN3107945
	plate		
	<b>Part No.</b>	514299	<b>Ref. No.</b> 3107941 BN3107941
	ring		

<b>spare parts for</b>	514394		
	<b>Part No.</b>	514300	<b>Ref. No.</b> 3107935 BN3107935
	bush		
	<b>Part No.</b>	514301	<b>Ref. No.</b> 3107955 BN3107955
	compression spring $\varnothing$ 6.5mm L 14mm wire gauge $\varnothing$ 1.2mm		
	<b>Part No.</b>	514302	<b>Ref. No.</b> 0A011409 BN6A011409
	ball $\varnothing$ 8mm		
	<b>Part No.</b>	514303	<b>Ref. No.</b> 3107930 BN3107930
	pin $\varnothing$ 8mm L 19.5mm		
<b>accessories for</b>	514394		
	<b>Part No.</b>	514296	<b>Ref. No.</b> 3107910 BN3107910
	door catch H 28mm D1 $\varnothing$ 44mm D2 $\varnothing$ 35mm D3 $\varnothing$ 32mm mounting distance 10mm		

			
1			
<b>Part No.</b>	514303	<b>Ref. No.</b>	3107930 BN3107930
<b>description</b>	pin $\varnothing$ 8mm L 19.5mm		
<b>For models:</b>	ECVME 10, ECVME 20, ECVME 21, ECVME 6, ECVMG 10, ECVMG 20, ECVMG 21, ECVMG 6, ECYPE 10, ECYPE 20, ECYPE 21, ECYPE 6, ECVPG 10, ECVPG 20, ECVPG 21, ECVPG 6		

			
1			
<b>Part No.</b>	514298	<b>Ref. No.</b>	3107945 BN3107945
<b>description</b>	plate		
<b>For models:</b>	ECVME 10, ECVME 20, ECVME 21, ECVME 6, ECVMG 10, ECVMG 20, ECVMG 21, ECVMG 6, ECYPE 10, ECYPE 20, ECYPE 21, ECYPE 6, ECVPG 10, ECVPG 20, ECVPG 21, ECVPG 6		

			
1			
<b>Part No.</b>	514299	<b>Ref. No.</b>	3107941 BN3107941
<b>description</b>	ring		
<b>For models:</b>	ECVME 10, ECVME 20, ECVME 21, ECVME 6, ECVMG 10, ECVMG 20, ECVMG 21, ECVMG 6, ECYPE 10, ECYPE 20, ECYPE 21, ECYPE 6, ECVPG 10, ECVPG 20, ECVPG 21, ECVPG 6		









miscellaneous

			
1			
<b>Part No.</b>	691286	<b>Ref. No.</b>	LAR58001780
<b>description</b>	catch for glass plate		

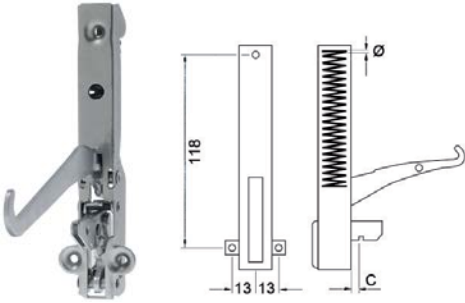
hinges

oven hinges

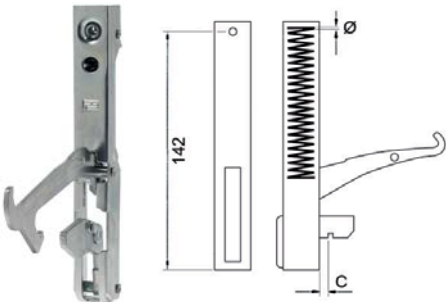
			
1			
<b>Part No.</b>	690030	<b>Ref. No.</b>	1034400400 CR1075440
<b>description</b>	oven hinge mounting distance 118mm lug mounting 13mm lever length 117mm groove distance 10mm spring thickness 3.5mm mounting ear position left/right spring length 60mm L 155mm W 21mm		
<b>accessories for</b>	690030		
	<b>Part No.</b>	<b>Ref. No.</b>	—
	700003		
	opposite support L 110mm W 12mm mounting distance 94mm		

			
1			
<b>Part No.</b>	700459	<b>Ref. No.</b>	BN6A035980
<b>description</b>	oven hinge mounting distance 142mm mounting distance 2mm lug mountingmm lever length 117mm groove distance 7mm spring thickness 3.5mm mounting ear position spring length 58mm L 156mm W 22mm		
<b>accessories for</b>	700459		
	<b>Part No.</b>	<b>Ref. No.</b>	—
	693045		
	opposite support L 110mm W 12mm mounting distance 94mm		

door bearing

			
1			
<b>Part No.</b>	692831	<b>Ref. No.</b>	LA58002670 LAR58002670
<b>description</b>	door bolt mounting pos. bottom left thread M12 bolt 15mm bolt ø 10mm		

			
1			
<b>Part No.</b>	691284	<b>Ref. No.</b>	LA58001760 LAR58001760
<b>description</b>	hinge for glass plate		

			
1			
<b>Part No.</b>	514292	<b>Ref. No.</b>	3106800 BN3106800
<b>description</b>	hinge bearing mounting pos. lower without bolt		

			
1			
<b>Part No.</b>	514294	<b>Ref. No.</b>	3106850 BN3106850
<b>description</b>	hinge bearing mounting pos. lower without bolt		

			
1			
<b>Part No.</b>	514291	<b>Ref. No.</b>	3106700 BN3106700
<b>description</b>	hinge bearing mounting pos. upper left without bolt		

			
1			
<b>Part No.</b>	690586	<b>Ref. No.</b>	LA11426830
<b>description</b>	hinge bearing mounting pos. upper left without bolt		



1

<b>Part No.</b>	514293	<b>Ref. No.</b>	3106750 BN3106750
<b>description</b>	hinge bearing mounting pos. upper right without bolt		



1

<b>Part No.</b>	514524	<b>Ref. No.</b>	LA11207240 LAR11207240
<b>description</b>	hinge bearing without bolt for combi-steamer mounting pos. bottom left		



1

<b>Part No.</b>	691285	<b>Ref. No.</b>	LA58001770 LAR58001770
<b>description</b>	hinge bolt		



1

<b>Part No.</b>	690099	<b>Ref. No.</b>	LA58002150 LAR58002150
<b>description</b>	hinge pin mounting pos. upper for door		

## accessories

## miscellaneous



1

<b>Part No.</b>	690595	<b>Ref. No.</b>	LA58002550 LAR58002550
<b>description</b>	bush for door hinge		



1

<b>Part No.</b>	690592	<b>Ref. No.</b>	LAR58002540
<b>description</b>	pin for hinge		



1

<b>Part No.</b>	690593	<b>Ref. No.</b>	LA58002570 LAR58002570
<b>description</b>	plain washer ID ø 15mm ED ø 30mm thickness 3mm Qty 1 pcs for door hinge		



1

<b>Part No.</b>	690594	<b>Ref. No.</b>	LA58002560 LAR58002560
<b>description</b>	pressure screw for door hinge		

## gaskets

## gaskets for heated units

## door seals

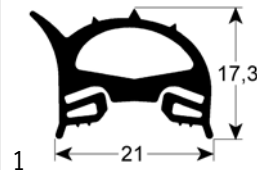

1

<b>Part No.</b>	900454	<b>Ref. No.</b>	3108820 BN3108820
<b>description</b>	door seal profile 2510 W 447mm L 1448mm external size		
<b>For models:</b>	ECVME 21, ECVMG 21, ECVPE 21, ECVPG 21		



1

<b>Part No.</b>	900451	<b>Ref. No.</b>	3108600 BN3108600
<b>description</b>	door seal profile 2510 W 450mm L 540mm external size Qty 1		
<b>For models:</b>	ECVME 6, ECVMG 6, ECVPE 6, ECVPG 6		



1

<b>Part No.</b>	900452	<b>Ref. No.</b>	3108700 BN3108700
<b>description</b>	door seal profile 2510 W 450mm L 780mm external size Qty 1		
<b>For models:</b>	ECVME 10, ECVMG 10, ECVPE 10, ECVPG 10		



<b>Part No.</b>	900453	<b>Ref. No.</b>	3108800 BN3108800
<b>description</b>	door seal profile 2510 W 640mm L 770mm external size Qty 1		
<b>For models:</b>	ECVME 20, ECVMG 20, ECVPE 20, ECVPG 20		

<b>Part No.</b>	902154	<b>Ref. No.</b>	LA70044922
<b>description</b>	door seal profile 2761 W 700mm L 1510mm external size Qty 1 suitable for LAINOX		

<b>Part No.</b>	902023	<b>Ref. No.</b>	LA70048012
<b>description</b>	door seal profile 2761 W 46mm L 775mm external size Qty 1 suitable for LAINOX		

<b>Part No.</b>	901679	<b>Ref. No.</b>	LAR70044210
<b>description</b>	door seal profile 2770/2771 H 520mm W 470mm outer plug size suitable for LAINOX		

<b>Part No.</b>	902024	<b>Ref. No.</b>	LA70048002
<b>description</b>	door seal profile 2761 W 470mm L 560mm external size Qty 1		

gaskets for tray rack trolleys

<b>Part No.</b>	901161	<b>Ref. No.</b>	LA80100910
<b>description</b>	tray rack trolley gasket L 1000mm		

<b>Part No.</b>	902153	<b>Ref. No.</b>	LA70044812
<b>description</b>	door seal profile 2761 W 550mm L 700mm external size Qty 1 suitable for LAINOX		

<b>Part No.</b>	902454	<b>Ref. No.</b>	LA70044882
<b>description</b>	door seal profile 2761 W 690mm L 775mm outer plug size Qty 1 suitable for LAINOX		

O-rings

EPDM

ø5.34mm

<b>Part No.</b>	510408	<b>Ref. No.</b>	0118462630 BN0118462630
<b>description</b>	O-ring EPDM thickness 5.34mm ID ø 47mm Qty 1 pcs		



## miscellaneous



<b>Part No.</b>	532492	<b>Ref. No.</b>	LAR70010050
<b>description</b>	O-ring set EPDM thickness 1.78/2.62mm ID ø 9.25/7.59mm Qty 2 pcs		

## Viton

ø2.00mm

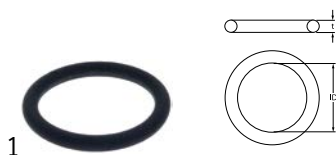

<b>Part No.</b>	512506	<b>Ref. No.</b>	LA70010080
<b>description</b>	O-ring Viton thickness 2mm ID ø 14mm Qty 1 pcs		

## shaft gaskets

## shaft gaskets



<b>Part No.</b>	511171	<b>Ref. No.</b>	LA70020040
<b>description</b>	shaft seal ID ø 14.5mm ED ø 20mm thickness 3mm		



<b>Part No.</b>	511172	<b>Ref. No.</b>	LA70020050
<b>description</b>	shaft sealing ID ø 24mm ED ø 29mm thickness 3mm		

## springs

## compression springs



<b>Part No.</b>	514301	<b>Ref. No.</b>	3107955 BN3107955
<b>description</b>	compression spring ø 6.5mm L 14mm wire gauge ø 1.2mm		
<b>For models:</b>	ECVME 10, ECVME 20, ECVME 21, ECVME 6, ECVMG 10, ECVMG 20, ECVMG 21, ECVMG 6, ECVPE 10, ECVPE 20, ECVPE 21, ECVPE 6, ECVPG 10, ECVPG 20, ECVPG 21, ECVPG 6		

## manometers



<b>Part No.</b>	541062	<b>Ref. No.</b>	6A021900 BN6A021900	
<b>description</b>	manometer ø 63mm pressure range 0 up to 1bar connection marking adjustable kettle thread 1/4"			
<b>spare parts for</b>	541062			
	<b>Part No.</b>	541130	<b>Ref. No.</b>	—
glass panel ø 58mm thickness 2mm				

## dosing pumps

## membrane dosing pumps

## self-priming

## LANG

## accessories



<b>Part No.</b>	101286	<b>Ref. No.</b>	LA62070023 LAR62070023
<b>description</b>	olive ID ø 6mm Qty 1 pcs		

## accessories for 101286



<b>Part No.</b>	100909	<b>Ref. No.</b>	6A011705 822450450 BN6A011705 LA62060223 LAR62060223
union screw thread M10x1 for pipe ø 6mm Qty 1 pcs			



<b>Part No.</b>	101464	<b>Ref. No.</b>	—
union nut thread M12x1 for pipe ø 6mm			

## accessories

## container filters with non-return valve



<b>Part No.</b>	361058	<b>Ref. No.</b>	LA65110650
<b>description</b>	container filter with non-return valve SS hose ø 4x6mm ø 20mm L 56mm		









hoses

industrial hoses

PE hoses



<b>Part No.</b>	520973	<b>Ref. No.</b>	LA80150000
<b>description</b>	hose John Guest thickness 1.5mm LLDPE blue ID ø 7mm ED ø 10mm		
<b>accessories for</b>	520973		
	<b>Part No.</b>	440564	<b>Ref. No.</b> —
	push-in fitting John Guest straight thread 1/4" BSP pipe connection ø10mm		
	<b>Part No.</b>	440565	<b>Ref. No.</b> —
	push-in fitting John Guest straight thread 3/8" BSP pipe connection ø10mm		
	<b>Part No.</b>	440608	<b>Ref. No.</b> —
	push-in fitting John Guest straight thread 1/2" BSP stub ø 10mm		
	<b>Part No.</b>	440639	<b>Ref. No.</b> —
	push-in fitting John Guest angled thread 1/4" BSP pipe connection ø10mm		
	<b>Part No.</b>	520359	<b>Ref. No.</b> LA62090528 LAR62090528
	push-in fitting John Guest angled pipe connection ø10mm grommet ø 10mm		
	<b>Part No.</b>	520363	<b>Ref. No.</b> —
	push-in fitting John Guest T-piece pipe connection ø10mm - ø10mm - ø10mm		
	<b>Part No.</b>	520494	<b>Ref. No.</b> LA62090478 LAR62090478
	push-in fitting John Guest angled pipe connection ø10mm - ø10mm		

PU hoses

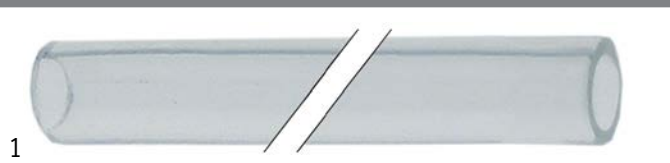

<b>Part No.</b>	512505	<b>Ref. No.</b>	LA80150020
<b>description</b>	PU hose ID ø 5mm ED ø 8mm L 1m thickness 1.5mm t.max. -40 up to +60°C polyurethane transparent/colourless		

silicone hoses

without fabric



<b>Part No.</b>	530063	<b>Ref. No.</b>	MA1036100700
<b>description</b>	silicone hose ID ø 18mm ED ø 25mm L 1m t.max. 200°C transparent		

<b>Part No.</b>	570157	<b>Ref. No.</b>	LA80120060
<b>description</b>	silicone hose ID ø 7mm ED ø 12mm L 1m thickness 2.5mm transparent for combi-steamer		

formed hoses

straight

<b>Part No.</b>	520534	<b>Ref. No.</b>	LA70060040
<b>description</b>	hose ID ø 50mm ED ø 58mm L 50mm silicone Qty 1 for combi-steamer thickness 4mm		

<b>Part No.</b>	530901	<b>Ref. No.</b>	LA70060050
<b>description</b>	hose ID ø 54mm ED ø 60mm L 50mm for combi-steamer		

<b>Part No.</b>	592327	<b>Ref. No.</b>	LA80150060
<b>description</b>	water hose ID ø 7mm ext. ø 10 L 1000mm operating p. 3bar temp.-resist. 92°C for combi-steamer		





## fittings, hose and pipe connectors

### fittings

#### double nipples



1

<b>Part No.</b>	521182	<b>Ref. No.</b>	LA62020118 LAR62020118
<b>description</b>	double nipple plastic thread 1/4" - 1/4" Qty 1 pcs		

#### screw pipe fittings

#### angle pieces



1

<b>Part No.</b>	699452	<b>Ref. No.</b>	LA62090633 LAR62090633
<b>description</b>	angle piece thread M14x1 tube ø 10mm brass		

#### hose connectors

#### plastic



1

<b>Part No.</b>	362015	<b>Ref. No.</b>	LAR62090638
<b>description</b>	hose connector plastic straight IT 1/4" hose ø 8mm		

#### stainless steel



1

<b>Part No.</b>	542385	<b>Ref. No.</b>	LA62090663 LAR62090663
<b>description</b>	hose connector SS angled thread 1/4" hose ø 10mm Qty 1 pcs		

#### producer-specific



1

<b>Part No.</b>	440027	<b>Ref. No.</b>	LA62090482 LAR62090482
<b>description</b>	connecting piece for hose ID 6mm WS 15 total length 79mm plastic John Guest		



1

<b>Part No.</b>	520339	<b>Ref. No.</b>	LA62090518 LAR62090518
<b>description</b>	hose connector thread 1/4" straight grommet ø 10mm grommet length 20mm WS 20 total length 37mm thread L 11mm plastic		



1

<b>Part No.</b>	520360	<b>Ref. No.</b>	LAR62090508
<b>description</b>	hose connector thread 1/4" with coupling straight plastic		

### push-in fittings

#### JOHN GUEST



1

<b>Part No.</b>	520359	<b>Ref. No.</b>	LA62090528 LAR62090528
<b>description</b>	push-in fitting John Guest angled pipe connection ø10mm grommet ø 10mm		
<b>accessories for</b>	520359		
	<b>Part No.</b>	520973	<b>Ref. No.</b> LA80150000
	hose John Guest thickness 1.5mm LLDPE blue ID ø 7mm ED ø 10mm		



1

<b>Part No.</b>	440671	<b>Ref. No.</b>	LA62090678 LAR62090678
<b>description</b>	push-in fitting John Guest angled pipe connection ø8mm grommet ø 8mm		
<b>accessories for</b>	440671		
	<b>Part No.</b>	520972	<b>Ref. No.</b> —
	hose John Guest thickness 1mm LLDPE blue ID ø 6mm ED ø 8mm		





1 

<b>Part No.</b>	520492	<b>Ref. No.</b>	LAG2090458 LAR62090458
<b>description</b>	push-in fitting John Guest straight pipe connection ø10mm - ø10mm		

1 

<b>Part No.</b>	520494	<b>Ref. No.</b>	LAG2090478 LAR62090478	
<b>description</b>	push-in fitting John Guest angled pipe connection ø10mm - ø10mm			
<b>accessories for</b>	520494			
	<b>Part No.</b>	520973	<b>Ref. No.</b>	LA80150000
	hose John Guest thickness 1.5mm LLDPE blue ID ø 7mm ED ø 10mm			

1 

<b>Part No.</b>	520495	<b>Ref. No.</b>	LAG2090608 LAR62090608	
<b>description</b>	push-in fitting John Guest straight thread 1/8" BSP stub ø 8mm			
<b>accessories for</b>	520495			
	<b>Part No.</b>	520971	<b>Ref. No.</b>	—
	hose thickness 1mm LLDPE blue ID ø 4mm ED ø 6mm operating pressure at 20°C 16bar			

1 

<b>Part No.</b>	440031	<b>Ref. No.</b>	LAG2090688 LAR62090688
<b>description</b>	push-in fitting John Guest straight thread 1/2" pipe connection ø8mm - ø8mm bulkhead connector		

## valves and tank inlets

### ball valves

#### universal

#### ball valves with butterfly handle

1 

<b>Part No.</b>	540658	<b>Ref. No.</b>	MA1450500
<b>description</b>	ball valve connection 3/4" IT - 3/4" IT DN20 total length 69mm		

### ball valves electric

1 

<b>Part No.</b>	401190	<b>Ref. No.</b>	3103590 BN3103590 BN3198150
<b>description</b>	ball valve inlet 3/4" IT outlet 3/4" IT IP42 230V L 68mm 50/60Hz closed off-current mode of operation electric connection cable 300mm 3.5W duty cycle 50%		
<b>For models:</b>	ECVPE 10, ECVPE 20, ECVPE 21, ECVPE 6, ECVPG 10, ECVPG 20, ECVPG 21, ECVPG 6		

## ancillary products

### clamps

#### hose clamps

#### DIN 3017 - W2

1 

<b>Part No.</b>	520112	<b>Ref. No.</b>	LAR61630011
<b>description</b>	hose clamp ø 12-20mm width 9mm Qty 10 pcs DIN 3017		



## fastening material

## screws

## hexagonal screws



1

<b>Part No.</b>	560594	<b>Ref. No.</b>	LA61020562 LAR61020562
<b>description</b>	hexagonal screw thread M6 thread L 20mm WS 10 total length 59mm		

## grub screws

## DIN 913/ISO 4026



1

<b>Part No.</b>	560024	<b>Ref. No.</b>	LA61090052 LAR61090052
<b>description</b>	grub screw thread M6 L 16mm SS DIN 913/ISO 4026 intake internal hexagon WS 3 Qty 20 pcs		

## DIN 916/ISO 4029



1

<b>Part No.</b>	560173	<b>Ref. No.</b>	6A009190 BN6A009190
<b>description</b>	grub screw thread M4 L 10mm SS DIN 916/ISO 4029 intake internal hexagon WS 2 Qty 20 pcs		
<b>For models:</b>	7FT/G800, 7FTT/G405, 7FTT/G410		

## miscellaneous



1

<b>Part No.</b>	690594	<b>Ref. No.</b>	LA58002560 LAR58002560
<b>description</b>	pressure screw for door hinge		

## nuts

## hexagonal nuts

## hexagonal nuts metric (without norm)



1

<b>Part No.</b>	550681	<b>Ref. No.</b>	LA58004050 LAR58004050
<b>description</b>	nut thread M12x1.25 H 5mm WS 17 brass Qty 1 pcs		



1

<b>Part No.</b>	101345	<b>Ref. No.</b>	41822180010 BN6A010820 BN822180010
<b>description</b>	nut thread M15x1 H 3mm WS 19 brass Qty 1 pcs		
<b>For models:</b>	7FT/G800, 7FTT/G405, 7FTT/G410		



1

<b>Part No.</b>	102067	<b>Ref. No.</b>	6A012300 BN6A012300 MA939300
<b>description</b>	nut thread M8x1 H 3mm brass Qty 1 pcs type SEF 1		

## washers

## spring washers



1

<b>Part No.</b>	696397	<b>Ref. No.</b>	LAR61620091
<b>description</b>	spring washer ID $\phi$ 6.3mm ED $\phi$ 14mm Qty 1 pcs		

## washers

## miscellaneous



1

<b>Part No.</b>	690593	<b>Ref. No.</b>	LA58002570 LAR58002570
<b>description</b>	plain washer ID $\phi$ 15mm ED $\phi$ 30mm thickness 3mm Qty 1 pcs for door hinge		



1

<b>Part No.</b>	551434	<b>Ref. No.</b>	LA58004010 LAR58004010
<b>description</b>	plain washer $\phi$ 30mm thickness 3mm hole $\phi$ 12.5mm for fan wheel combi-steamer		



fasteners

clamps

hose clamps

DIN 3017 - W2



<b>Part No.</b>	520112	<b>Ref. No.</b>	LAR61630011
<b>description</b>	hose clamp ø 12-20mm width 9mm Qty 10 pcs DIN 3017		

consumables

sealants and adhesives

high temperature silicone

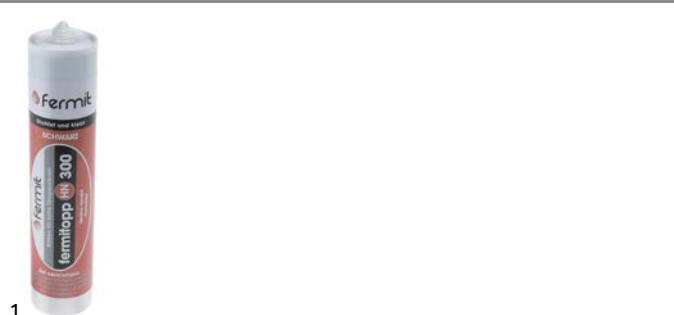

<b>Part No.</b>	890059	<b>Ref. No.</b>	6A098350 BNGA098350
<b>description</b>	high temperature silicone FERMITOPP 300 neutral curing -40 up to +265°C black cartridge 310ml		
<b>description</b>	<p>Fermitopp HN 300 - cartridge 310ml - black</p> <p>Is used for sealing expansion joints on heating flues, ovens, reactors, chimneys, stacks, etc. The sealant is neutrally cross-linking, reacts with the moisture in the air and is characterised by extremely good hot air-resistance. The adhesive surfaces must be dry, clean and free of loose parts and in the case of porous substrates they should, if necessary, be given a first coat of primer. Post-smoothing e.g. with soap solution must take place before skinning.</p> <p>Highly refractory, odourless, UV/water/colour/hot-air resistant Temperature range -50°C to +250°C</p>		

cleaning agents

combiteamer detergents/descalers

Notice: Articles labelled 'DANGEROUS GOODS' are delivered by road through a forwarder for reasons of safety and are charged separately!



<b>Part No.</b>	802039 <sup>1</sup>	<b>Ref. No.</b>	4185312300
<b>description</b>	detergent for combi-steamer LAINOX Combi Clean 10 litres		
<b>description</b>	<p>LAINOX Combi Clean - detergent - canister 10l</p> <p>Triple-action alkaline detergent, specially designed for cleaning the cooking chambers of Lainox combi steamers. With its special 3-in-1 formula with detergent, rinse aid and descaler the detergent removes food residue and gives the cooking chamber a streak-free shine. The detergent helps ensure a long seal life. Can corrode metals.</p>		

<sup>1</sup>DANGEROUS GOODS

fuses

fine fuses

fine fuse holders



<b>Part No.</b>	358512	<b>Ref. No.</b>	LA65210020
<b>description</b>	fuse holder		

**GASTROPARTS.COM**



© 2020 Gastroparts Sp. J. All rights reserved.