



GASTROPARTS

Bake-Off

[EN] Cooking

[DE] Kochtechnik

[ES] Cocción

[FR] Cuisson

[IT] Cottura

[PL] Obróbka termiczna

[RU] Термическая обработка

✉ gastroparts@gastroparts.com

☎ tel. +48 56 657 00 66

📘 fb.com/gastroparts.global

GASTROPARTS.COM





heating elements

heating elements for convection



1

Part No.	420228	Ref. No.	373500013
description	heating element 2000W 240V heating circuits 1 ID ø 180mm ED ø 192mm L 246mm H 42mm L1 48mm W1 30mm H1 20mm H2 28mm flange length 70mm flange width 22mm hole distance 56mm connection screw connection length 65mm tube ø 6.25mm convection heating element hole ø 5mm		



1

Part No.	420189	Ref. No.	373500041
description	heating element 2535/3100W 208/230V heating circuits 1 ID ø 220mm ED ø 232mm L 269mm H 60mm L1 34mm W1 61mm H1 23mm H2 37mm flange length 100mm flange width 22mm hole distance 86mm connection male faston 6.3mm tube ø 6.3mm convection heating element hole ø 5mm flange connection		



1

Part No.	419149	Ref. No.	373500032
description	heating element 3990W 230V heating circuits 2 ID ø 215mm ED ø 227mm L 245mm H 42mm L1 15mm W1 61mm H1 16mm H2 24mm flange length 100mm flange width 22mm hole distance 86mm connection male faston 6.3mm connection length 79mm tube ø 6.3mm convection heating element hole ø 5mm rectangular flange		



1

Part No.	419163	Ref. No.	373500040
description	heating element 5000W 230V heating circuits 2 ID ø 214mm ED ø 228mm L 245mm H 42mm L1 12mm W1 60mm H1 9mm H2 34mm flange length 100mm flange width 22mm hole distance 86mm connection male faston 6.3mm connection length 62mm tube ø 6.3mm convection heating element hole ø 5mm		

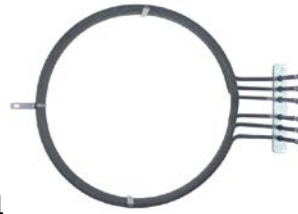

1

Part No.	419150	Ref. No.	373500014 373500015
description	heating element 9000W 220V heating circuits 3 ID ø 316mm ED ø 329mm L 396mm H 83mm L1 66mm W1 103mm H1 18mm H2 65mm flange length 142mm flange width 25mm hole distance 126mm connection M6 connection length 95mm tube ø 6.3mm convection heating element hole ø 5mm rectangular flange		
For models:	5TTR		

energy regulators

EGO

1-circuit



1

Part No.	380019	Ref. No.	373506020
description	energy regulator 240V 13A single-circuit turn direction right shaft ø 6x4.6mm shaft L 23mm mounting thread M4 power release 6-100% no. 50.57071.010		

thermostats

control and safety thermostats

EGO

control thermostats

55.10/19_ series



1

Part No.	390943	Ref. No.	182500060
description	thermostat t.max. 269°C 1-pole 1NO 16A probe ø 3mm probe L 225mm capillary pipe 900mm capillary pipe isolated 800mm gland nut shaft ø 6x4.6mm shaft L 23mm shaft position upper rotation 270°		



safety thermostats

55.31_ series



Part No.	375377	Ref. No.	182500021 182500022
description	safety thermostat switch-off temp. 350°C 3-pole 3NC 1x20/2x0.5A probe ø 6mm probe L 157mm capillary pipe 1230mm capillary pipe isolated 1100mm gland nut probe		
For models:	5TTR		

CAEM

control thermostats

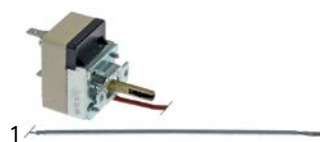

Part No.	390790	Ref. No.	182500044
description	thermostat t.max. 300°C temperature range 50-280°C 1-pole 1NO 16A probe ø 3mm probe L 160mm capillary pipe 1450mm capillary pipe isolated 650mm gland nut shaft ø 6x4.6mm shaft L 22mm rotation 270° 250V		

safety thermostats



Part No.	376043	Ref. No.	182500035
description	safety thermostat switch-off temp. 335°C 1-pole 16A probe ø 3mm probe L 180mm capillary pipe 970mm capillary pipe isolated 780mm probe SS		

switches and momentary switches

rocker/momentary rocker switches

30x22mm



Part No.	347662	Ref. No.	167600000
description	momentary rocker switch mounting measurements 30x22mm black 2CO 250V 16A steam connection male faston 6.3mm ambient temperature max. 100/55°C protection IP40		

microswitches

pin-plunger actuated

M10



Part No.	345032	Ref. No.	151600000 151600020
description	microswitch with plunger thread M10x1 thread L 12mm 250V 16A 1CO connection male faston 6.3mm stroke 7mm mounting distance 22mm L 28mm ambient temperature max. 125°C type SP9603 actuating force: 180g		
For models:	5TTR		

cam switches

operation switches



Part No.	300002	Ref. No.	113000001
description	cam switch 2 operating positions 4NO 16A sequence 0-1 shaft ø 6x4.6mm shaft L 23mm connection male faston 6.3mm ceramic		



lamps

indicator lights

indicator lights (complete)

ø10mm

with plug-in socket



1

Part No.	359139	Ref. No.	149000000
description	indicator light ø 10mm green 230V connection male faston 6.3mm Qty 1 pcs		

screw-on/push-on fit

light bulbs

for ovens



1

Part No.	359740	Ref. No.	146600012
description	light bulb t.max. 300°C socket E14 15W 230V ø 22mm L 48mm lens L 20mm for oven lamp IMPORT		

halogen lamp

for socket G4 / G6.35 / G9



1

Part No.	357192	Ref. No.	146600008 391548021
description	halogen lamp socket G4 12V 20W temp.-resist. °C OSRAM HALOSTAR STARLITE		



1

Part No.	347637	Ref. No.	146600003
description	halogen lamp socket G4 24V 20W temp.-resist. 300°C ø 8mm L 30mm		
For models:	5TTR		



1

Part No.	357196	Ref. No.	146618600
description	halogen lamp socket G9 230V 40W temp.-resist. 300°C OSRAM HALOPIN OVEN		

linear lamps

infrared lamps

with base type X lug



1

Part No.	359617	Ref. No.	146600007
description	infrared lamp 1000W 220V L 365mm lens L 340mm total length 480mm with mounting strap		

oven lamps

universal oven lamps

mounting diameter 35.5mm





1

Part No.	359705	Ref. No.	166400007
description	oven lamp glass thr.ø 33.5mm ø 52mm hard glas temp.-resist. 350°C		

accessories for 359705

	Part No.	359610	Ref. No.	—
	description	light bulb t.max. 300°C socket E14 15W 230V ø 22mm L 47mm lens L 20mm for oven lamp type Philips		

	Part No.	359700	Ref. No.	—
	description	gasket for pizza oven fibre glass ID ø 32.5mm ED ø 55mm thickness 5mm		

	Part No.	359721	Ref. No.	—
	description	gasket silicone ED ø 48mm ID ø 39.5mm thickness 5mm Qty 1 pcs		

	Part No.	359837	Ref. No.	—
	description	gasket ID ø 33mm ED ø 46mm thickness 1mm graphite		

	Part No.	359838	Ref. No.	—
	description	gasket ID ø 33mm ED ø 45mm		



1

Part No.	359661	Ref. No.	391548020
description	oven lamp glass thread 32.1 ø 58mm hard glas temp.-resist. 350°C		

accessories for 359661

	Part No.	359700	Ref. No.	—
	description	gasket for pizza oven fibre glass ID ø 32.5mm ED ø 55mm thickness 5mm		



55x70mm



1

Part No.	359375	Ref. No.	166400010
description	lamp socket complete version socket E14 mounting measurements 55x70mm		

lamps

light bulbs



1

Part No.	359740	Ref. No.	146600012
description	light bulb t.max. 300°C socket E14 15W 230V ø 22mm L 48mm lens L 20mm for oven lamp IMPORT		

halogen lamps

for socket G4 / G6.35 / G9



1

Part No.	357192	Ref. No.	146600008 391548021
description	halogen lamp socket G4 12V 20W temp.-resist.°C OSRAM HALOSTAR STARLITE		



1

Part No.	357196	Ref. No.	146618600
description	halogen lamp socket G9 230V 40W temp.-resist. 300°C OSRAM HALOPIN OVEN		

sockets

G4 / G5,3 / G6,35



1

Part No.	359646	Ref. No.	166400002
description	lamp socket socket G4/G5.3/G6.35 24V ø 17mm H 15mm connection cable 130mm mounting distance 26mm for halogen lamp holder length 31mm cable length 130mm		
For models:	5TTR, 6TTR		

timers

programme timers



1

Part No.	360703	Ref. No.	366900005
description	timer CDC 8802F1 engines 1 chambers 2 operation time 4min 230V 50Hz shaft ømm shaft Lmm manuf. no. 8802F10AGE000.0010 motor type M48R 230V		

electric timers

with time spread



1

Part No.	350154	Ref. No.	183000010 183000015
description	timer MS65 with bell operation time 120min time spread 30min 2CO/1NO at 250V 16A permanent position yes impulse electric shaft ø 6x4.6mm shaft L 20mm connection lateral Invensys 230V 3-pole		

alarm devices

buzzer boards



1

Part No.	350106	Ref. No.	381000002
description	buzzer board 230VAC L 53mm W 31mm connection male faston 4.8mm		



contactors

GENERAL ELECTRIC (AEG)

power contactors



1

Part No.	380337	Ref. No.	182500047
description	power contactor resistive load 20A 230VAC (AC3/400V) 8.4A/4kW main contacts 4NO auxiliary contacts connection screw connection type AEG LS05 400A type GE MC1A 400A		



1

Part No.	381136	Ref. No.	182500042
description	power contactor resistive load 25A 24VAC (AC3/400V) 12A/5.5kW main contacts 3NO auxiliary contacts 1NO connection screw connection type AEG type GE CL01A310T1		
For models:	5TTR		

auxiliary contacts



1

Part No.	380269	Ref. No.	320800007
description	auxiliary contact contacts 1NC AC15 6A for contactors CL+LS_K connection screw AC-12 10A type AEG HS07K 01 type GE BCLF 01		
For models:	5TTR		

relays

time relays

time relays



1

Part No.	360523	Ref. No.	183000006
description	time relay FIBER E50BM_0100 time range 6s-6h 24-240VAC/24VDC 5A 1CO connection plug-in connection round 8-pole		
For models:	5TTR		

electronic controllers

EVCO - EVERY CONTROL

universal controllers

built-in version



1

Part No.	378282	Ref. No.	182500010
description	electronic controller EVERY CONTROL EVK411 mounting measurements 71x29mm built-in depth 59mm 230V voltage AC TC (J,K) relay outputs 1 CO-16A(8) TC (J,K) yes protection IP65 -100 up to +800°C display 4 digits		
accessories for	378282		
	Part No.	Ref. No.	—
	temperature probe thermocouple K (NiCr-Ni) cable Vetrotex probe -50 up to 1150°C cable -50 up to +350°C probe ø4.5x150mm cable length 3m without screw connection 2-wire		
	Part No.	Ref. No.	—
	temperature probe thermocouple J (Fe-CuNi) cable Vetrotex probe -50 up to +750°C cable -50 up to +350°C probe ø6x100mm cable length 3m without screw connection cable colours red/blue 2-wire		
	Part No.	Ref. No.	—
	temperature probe thermocouple J (Fe-CuNi) cable Vetrotex probe -50 up to +750°C cable -50 up to +350°C probe ø6x50mm cable length 3m without screw connection 2-wire		
	Part No.	Ref. No.	—
	temperature probe thermocouple J (Fe-CuNi) cable Vetrotex probe 0 up to +350°C cable°C probe ø6x100mm cable length 1.35m without screw connection cable colours red/blue 2-wire		



probes

producer-specific probes

probes



Part No.	379807	Ref. No.	179600000
description	temperature probe thermocouple J (Fe-CuNi) cable Vetrotex probe -50 up to +750°C cable -50 up to +350°C connection 2-wire thread probe ø6x85mm cable length 1.5m		
For models:	5TTR		

electronics

PCBs



Part No.	401840	Ref. No.	780605044 780605046
description	keypad PCB		
For models:	5TTR		

keypads

front foils



Part No.	401838	Ref. No.	382000012
description	keypad foil L 300mm W 110mm		
For models:	5TTR		



Part No.	401839	Ref. No.	382000051
description	keypad foil L 563mm W 115mm		



Part No.	401844	Ref. No.	382000052
description	keypad foil L 563mm W 115mm		

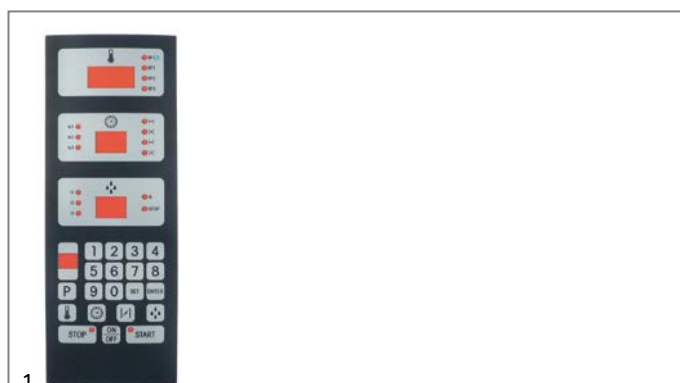

Part No.	505299	Ref. No.	382000019
description	keypad foil suitable for convection oven L 300mm W 110mm buttons 19		
For models:	5TTR		



solenoid valves

solenoid valves (water)

ELBI

spare parts and accessories

reducers

outlet side



1



Part No.	371060	Ref. No.	374000008
description	reducer ELBI flow rate 0.25l/min pressure range 0 up to 10bar tolerance ±15/25% green		

RPE

JOHN GUEST



1

Part No.	370772	Ref. No.	120800017	
description	solenoid valve double straight 230VAC inlet 3/4" outlet JG 8 DN10 t.max. 60°C duty cycle 100% RPE			
accessories for	370772			
	Part No.	371265	Ref. No.	—
	reducer flow rate 3l/min black			
	Part No.	371269	Ref. No.	—
	reducer flow rate 0.07-0.14l/min brown			

solenoid valves with reducers

single



1

Part No.	370692	Ref. No.	120800009
description	solenoid valve single straight 220-240VAC inlet 3/4" outlet 11.5mm input 10-12l/min output 0.32-0.42l/min t.max. 60°C duty cycle 100% RPE plastic flow regulating valve outlet green flow regulating valve inlet white 2-ways medium temp max. 25°C		



1

Part No.	374005	Ref. No.	120800005
description	solenoid valve single straight 24VAC inlet 3/4" outlet 11.5mm input 10-12l/min t.max. 25°C duty cycle 100% RPE plastic flow regulating valve inlet white 7.2VA		
For models:	5TTR		

fans

axial fans

import



1

Part No.	601159 ¹	Ref. No.	391500005
description	axial fan L 119mm W 119mm H 25mm 24VDC 5W bearing ball bearing connection cable 350mm plastic ADDA fan wheel ø 110mm temp.-resist. 70°C input current 0.19A		

¹with ball bearings

hot air motors



1

Part No.	602014	Ref. No.	353000022 753000035 753000045 753000120 753000122
description	fan motor 208-240V 1 phase 50/60Hz 0.19-0.26/0.34-0.35kW 2800/3450rpm speeds 2 L1 98mm L2 33mm D1 ø 8mm M5 1-1.2/1.7-1.5A type MFA80		

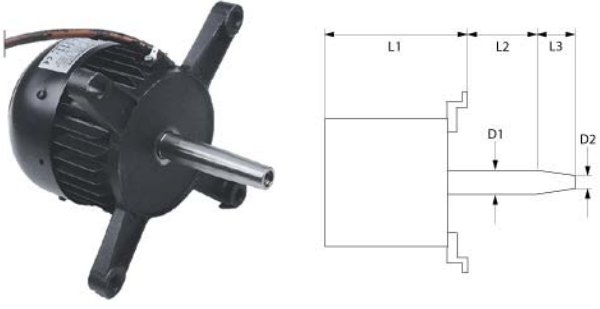
1

Part No.	601770	Ref. No.	353000010
description	fan motor 220-240/380-415V 3 phase 50/60Hz 0.5HP 1400/1600rpm speeds 1 L1 158mm L2 45mm L3 47mm D1 ø 24mm D2 ø 20mm M12L IT at 50Hz 1400rpm at 60Hz 1600rpm type 1088.4354		
For models:	5TTR, 6TTR		



1

Part No.	601799	Ref. No.	391500007 391500015
description	fan wheel D1 ø 197mm H1 43mm blades 45 D2 ø 8mm D3 ø 8mm H2 25mm		



1

Part No.	601781	Ref. No.	391500011 391500016
description	fan wheel D1 ø 198mm H1 61mm blades 45 D2 ø 8mm D3 ø 8x6.8mm H2 14.5mm		



1

Part No.	601785	Ref. No.	391500013
description	fan wheel D1 ø 240mm H1 61mm blades 55 D2 ø 8mm D3 ø 8x6.5mm H2 20mm		



1

Part No.	560449	Ref. No.	393000001
description	hexagonal screw thread M12x1.5 L thread L 22mm bore ø 6.3mm WS 19 total length 30mm		

gas valves and ignition boxes

ignition boxes

HONEYWELL



1

Part No.	104598	Ref. No.	378615150
description	ignition box HONEYWELL type S4565XXXX electrodes 3 waiting times safety time 10s 220-240V 4VA 50/60Hz		

ignition parts

ignition units



1

Part No.	103334	Ref. No.	184507050
description	ignition unit outputs 2 220-240VAC dimensions 83x42x32mm mounting distance 34mm inlet F2.8 outlet F2.8 type TSM 17VA 50/60Hz		

equipmentspecific units

for convection ovens/combi-steamers

spare parts and accessories



1

Part No.	692107	Ref. No.	308200001 743600000 743600010
description	mounting set for glass plate 6-fold		
For models:	5TTR		



glass panels



Part No.	692056	Ref. No.	391505401
description	glass panel L 721mm W 591mm thickness 5mm mounting pos. outer		
For models:	5TTR		



Part No.	692055	Ref. No.	391505400 391505400+743600000 391505400+743600010
description	glass panel L 770mm W 564mm thickness 6mm mounting pos. inner		
For models:	5TTR		





locks

turning lever locks

universal



RAHRBACH



Part No.	690500	Ref. No.	311506500 751606500
description	handle latch right L 185mm H 66mm handle material plastic type 6300 series		
For models:	6TTR		
spare parts for	690500		
	Part No.	699841	Ref. No. —
	cover cap for turning lever lock ø 32mm H 14mm		
accessories for	690500		
	Part No.	514281	Ref. No. —
	base plate L 110mm W 35mm for door catch thickness 10mm		
	Part No.	690136	Ref. No. —
	sliding plate mounting pos. right L 28mm H 3mm W 21mm H2 12.5mm		
	Part No.	691174	Ref. No. —
	counterpart L 90mm W 60mm for door latch		
	Part No.	700091	Ref. No. —
	door catch mounting pos. right off-set 20mm L 110mm H 56mm W 33mm mounting distance 68/68mm zinc die cast series 6300		



accessories for	690500		
	Part No.	700098	Ref. No. 355606500
	door catch mounting pos. right off-set 38mm L 110mm H 74mm W 33mm mounting distance 68/68mm series 1750		



Part No.	700098	Ref. No.	355606500
description	door catch mounting pos. right off-set 38mm L 110mm H 74mm W 33mm mounting distance 68/68mm series 1750		
For models:	6TTR		
spare parts for	700098		
	Part No.	690136	Ref. No. —
	sliding plate mounting pos. right L 28mm H 3mm W 21mm H2 12.5mm		
accessories for	700098		
	Part No.	514281	Ref. No. —
	base plate L 110mm W 35mm for door catch thickness 10mm		

STUV





Part No.	700098	Ref. No.	355606500
description	door catch mounting pos. right off-set 38mm L 110mm H 74mm W 33mm mounting distance 68/68mm series 1750		
For models:	6TTR		
spare parts for	700098		
	Part No.	690136	Ref. No. —
	sliding plate mounting pos. right L 28mm H 3mm W 21mm H2 12.5mm		
accessories for	700098		
	Part No.	514281	Ref. No. —
	base plate L 110mm W 35mm for door catch thickness 10mm		







producer-specific

BAKE OFF



Part No.	700098	Ref. No.	355606500
description	door catch mounting pos. right off-set 38mm L 110mm H 74mm W 33mm mounting distance 68/68mm series 1750		
For models:	6TTR		
spare parts for	700098		
	Part No.	690136	Ref. No. —
	sliding plate mounting pos. right L 28mm H 3mm W 21mm H2 12.5mm		
accessories for	700098		
	Part No.	514281	Ref. No. —
	base plate L 110mm W 35mm for door catch thickness 10mm		





			
1			
Part No.	690500	Ref. No.	311506500 751606500
description	handle latch right L 185mm H 66mm handle material plastic type 6300 series		
For models:	6TTR		
spare parts for	690500		
		Part No. 699841	Ref. No. —
	cover cap for turning lever lock ø 32mm H 14mm		
accessories for	690500		
		Part No. 514281	Ref. No. —
	base plate L 110mm W 35mm for door catch thickness 10mm		
		Part No. 690136	Ref. No. —
	sliding plate mounting pos. right L 28mm H 3mm W 21mm H2 12.5mm		
		Part No. 691174	Ref. No. —
	counterpart L 90mm W 60mm for door latch		
		Part No. 700091	Ref. No. —
	door catch mounting pos. right off-set 20mm L 110mm H 56mm W 33mm mounting distance 68/68mm zinc die cast series 6300		
		Part No. 700098	Ref. No. 355606500
	door catch mounting pos. right off-set 38mm L 110mm H 74mm W 33mm mounting distance 68/68mm series 1750		

handle latches

universal

inside fixing

locks

			
1			
Part No.	694054	Ref. No.	351656020
description	door handle for headed units L 145mm W 40mm H 62mm spring length 33mm inner black		
spare parts for	694054		
		Part No. 514390	Ref. No. —
	spring for door handle ø 6mm L 54mm W 27.5mm		
		Part No. 694675	Ref. No. —
	door catch L 88mm W 40mm H 37mm spring length 33mm mounting distance 60mm		

spare parts for	694054		
		Part No. 694734	Ref. No. —
	door handle L 165mm W 40mm H 25mm black		
		Part No. 694735	Ref. No. —
	cap ø 32mm black		
accessories for	694054		
		Part No. 691123	Ref. No. —
	duct for door opener		
		Part No. 694055	Ref. No. —
	door catch L 25mm W 14mm total length 54mm thread M8 thread L 29mm		
		Part No. 694066	Ref. No. —
	door catch with spigot 2-stage L 28mm W 14mm H 15mm H1 16mm total length 51mm thread M8 thread L 23mm stainless steel		
		Part No. 694067	Ref. No. —
	door catch with spigot 1-stage L 26mm total length 51mm thread M8		

producer-specific

BAKE OFF

			
1			
Part No.	691839	Ref. No.	629310020 664110020 676010020 743600002
description	door catch kit		
For models:	5TTR		

hinges

oven hinges

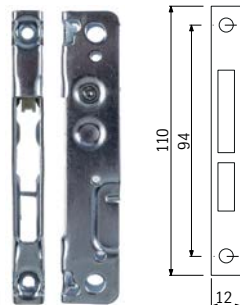
			
1			
Part No.	693045	Ref. No.	366400005 36640005
description	opposite support L 110mm W 12mm mounting distance 94mm		



Part No.	700459	Ref. No.	31100005
description	oven hinge mounting distance 142mm mounting distance 2mm lug mountingmm lever length 117mm groove distance 7mm spring thickness 3.5mm mounting ear position spring length 58mm L 156mm W 22mm		
accessories for	700459		
	Part No.	693045	Ref. No. 36640005 36640005
	opposite support L 110mm W 12mm mounting distance 94mm		

Part No.	901500	Ref. No.	331800003 331800015
description	door seal profile 2769 L 7000mm		

door seals with fixing hook

Part No.	901503	Ref. No.	331800006
description	door seal L 650mm W 340mm 4-sided with 12 mounting clips		

hoses

industrial hoses

PE hoses

Part No.	520549 ¹	Ref. No.	385500020
description	hose Lm operating p. 6bar burst p. 10bar t.max. 65°C LLDPE transparent ID ø 6mm ED ø 8mm John Guest supplied by meter		

¹by the meter

fittings, hose and pipe connectors

push-in fittings

JOHN GUEST

Part No.	520497	Ref. No.	373000021
description	push-in fitting John Guest straight pipe connection ø8mm - ø8mm		

gaskets

gaskets for heated units

door seals

Part No.	900171	Ref. No.	331800008
description	door seal profile 2050 external size Qty supplied by meter		
For models:	5TTR		

Part No.	900901	Ref. No.	331800011 331807020
description	door seal profile 2746 Qty supplied by meter		
For models:	6TTR		



			
1			
Part No.	440660	Ref. No.	374000020
description	push-in fitting John Guest angled pipe connection ø8mm - ø12mm		
accessories for	440660		
	Part No.	520972	Ref. No. —
	hose John Guest thickness 1mm LLDPE blue ID ø 6mm ED ø 8mm		
	Part No.	520974	Ref. No. —
	hose John Guest thickness 1.5mm LLDPE blue ID ø 9mm ED ø 12mm		

			
1			
Part No.	440031	Ref. No.	363600000
description	push-in fitting John Guest straight thread 1/2" pipe connection ø8mm - ø8mm bulkhead connector		

beverage technology

valves

non-return valves

			
1			
Part No.	440729	Ref. No.	390500020
description	non-return valve John Guest pipe connection 5/16" - 5/16" operating pressure at 20°C 10bar opening pressure 0.02bar POM		

GASTROPARTS.COM



© 2020 Gastroparts Sp. J. All rights reserved.