



GASTROPARTS

Ambassade

[EN] Cooking

[DE] Kochtechnik

[ES] Cocción

[FR] Cuisson

[IT] Cottura

[PL] Obróbka termiczna

[RU] Термическая обработка

✉ gastroparts@gastroparts.com

☎ tel. +48 56 657 00 66

📘 fb.com/gastroparts.global

GASTROPARTS.COM





heating elements

heating elements for ovens



Part No.	418479	Ref. No.	6530624
description	heating element 950W 230V heating circuits 1 L 405mm W 96mm L1 75mm L2 330mm W1 15mm W2 66mm flange length 110mm flange width 22mm hole distance 95mm connection male faston 6.3mm connection length 18mm tube ø 6.3mm rectangular flange hole ø 5mm dry heating element heated cabinet		
For models:	CG1051CTA, CG1051CTAE, CG1051EA, CG1051EAE, CG1051GA, CG1051GAE, CG731CFE, CG731E, CG741E, CME401CA, CME410MCA, CME801CA, CME810MCA		

heating elements for convection



Part No.	418936	Ref. No.	6539168
description	heating element 1700W 240V heating circuits 1 ID ø 176mm ED ø 190mm L 248mm H 34mm L1 58mm W1 31mm H1 12mm H2 22mm flange length 70mm flange width 22mm hole distance 56mm connection male faston 6.3mm connection length 55mm tube ø 6.3mm convection heating element hole ø 5mm rectangular flange		
For models:	CG1051CTA, CG1051CTAE, CG731CFCT, CG731CT, CG741CT, CG831CFCT, CG831CT		



Part No.	418935	Ref. No.	6527752
description	heating element 2650W 240V heating circuits 1 ID ø 201mm ED ø 218mm L 252mm H 36mm L1 28mm W1 31mm H1 9mm H2 27mm flange length 70mm flange width 23mm hole distance 56mm connection male faston 6.3mm connection length 38mm tube ø 6.3mm convection heating element hole ø 5mm rectangular flange		
For models:	CG1052GCT, CG641CT, GC1052CFGCT		



Part No.	417628	Ref. No.	65211012
description	heating element 7000W 230V heating circuits 3 ID ø 216mm ED ø 229mm L 263mm H 78mm L1 23mm W1 112mm H1 11mm H2 68mm flange length 142mm flange width 25mm hole distance 6.3mm connection M4 connection length 66mm tube ø 6.5mm hole ø 6mm with gasket		

energy regulators

miscellaneous



Part No.	381406	Ref. No.	65225001
description	energy regulator 230V 13A no. 50.67021.461 turn direction right EGO shaft ø 6x4.6mm shaft L 23mm mounting thread M4 power release 6-70%		

thermostats

control and safety thermostats

EGO

control thermostats

55.13_ series



Part No.	375007	Ref. No.	6528195	
description	thermostat t.max. 110°C temperature range 30-110°C 1-pole 1NO 16A probe ø 6mm probe L 113mm capillary pipe 870mm capillary pipe isolatedmm gland nut M9x1 shaft L 25mm shaft position upper rotation 270°			
For models:	CE1051VTR, CG1051CTA, CG1051CTAE, CG1051EA, CG1051EAE, CG1051GA, CG1051GAE, CME401CA, CME410M, CME410MCA, CME-801CA, CME810M, CME810MCA			
accessories for	375007			
	Part No.	110119	Ref. No.	—
	knob thermostat t.max. 110°C ø 50mm shaft ø 6x4.6mm shaft flat upper black temperature range 30-110°C rotation 270°			
	Part No.	110241	Ref. No.	—
	knob thermostat t.max. 110°C ø 50mm shaft ø 6x4.6mm shaft flat upper black temperature range 30-110°C			



Part No.	375460	Ref. No.	65224008 6538102
description	thermostat t.max. 255°C temperature range 55-255°C 1-pole 1NO 16A probe ø 3.1mm probe L 201mm capillary pipe 1170mm capillary pipe isolated 1100mm gland nut shaft ø 6x4.6mm shaft L 23mm shaft position upper		

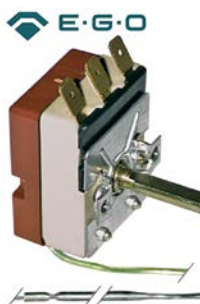

Part No.	375087	Ref. No.	6553670
description	thermostat t.max. 300°C temperature range 50-300°C 1-pole 1CO 16A probe ø 3.03mm probe L 160mm capillary pipe 1130mm capillary pipe isolated 1103mm gland nut shaft L 23mm shaft position upper rotation 270°		
For models:	CE1051B, CE1051CTA, CE1051EA, CE1051VTR, CE1052E, CE1052VTR, CE641E, CE741E, CE741VTR, CE841E, CE841VTR, CG1051CTA, CG1051CTAE, CG1051EA, CG1051EAE, CG1051EB, CG1052GCT, CG-1052GE, CG641CT, CG641E, CG731CFE, CG731E, CG741E, CG831CFE, CG831E, CME410G, GC1052CFGCT, GC1052CFGE		

55.34_ series



Part No.	376051	Ref. No.	65224002
description	thermostat t.max. 200°C temperature range 70-145-200°C 3-pole 3NC probe ø 3.1mm probe L 263mm capillary pipe 880mm capillary pipe isolated 400mm		
For models:	CFE505RT, CFE605RT, CFE705RT, CFE714RT		

safety thermostats

55.13_ series



Part No.	375830	Ref. No.	6538562
description	safety thermostat switch-off temp. 365°C 1-pole 1NC 16A probe ø 3mm probe L 160mm capillary pipe 1730mm capillary pipe isolated 1710mm gland nut probe		
For models:	CE1051B, CE1052E, CE1052VTR, CE641E, CG1051EB, CG1052GCT, CG1052GE, CG641CT, CG641E, GC1052CFGCT, GC1052CFGE		

55.32_ series





Part No.	376047	Ref. No.	6539942
description	safety rod thermostat switch-off temp. 368°C 3-pole 3NO 16A probe ø 3mm probe L 160mm capillary pipe 1490mm capillary pipe isolated 76mm		
For models:	CE1051CTA, CE1051EA, CE1051VTR, CE741E, CE741VTR, CE841E, CE841VTR, CFE505RT, CFE605RT, CFE705RT, CFE714RT, CG1051CTA, CG1051CTAE, CG1051EA, CG1051EAE, CG731CFE, CG731E, CG741E, CG831CFE, CG831E		

switches and momentary switches

rocker/momentary rocker switches

30x22mm



Part No.	301062	Ref. No.	6540129
description	rocker switch mounting measurements 30x22mm green 2NO 250V 16A illuminated connection male faston 6.3mm ambient temperature max. 100/55°C protection IP40		
For models:	CME401CA, CME410G, CME410GE, CME410GL, CME410GR, CME410M, CME410MCA, CME410RF, CME410SKS, CME410SLK, CME410SLR, CME410SR, CME413FR, CME415FR, CME416FR, CME419FR, CME-434FR, CME610SKS, CME610SLK, CME610SLR, CME610SR, CME610SRK, CME625FR, CME626FR, CME801CA, CME810M, CME810MCA		
accessories for	301062		
	Part No.	301036	Ref. No. —
	protective cover internal size 30x22mm for rocker switch mounting measurementsmm		



push/momentary push switches

27.2x22.2mm



1

Part No.	345033 ¹	Ref. No.	65222009 6532192
description	push switch mounting measurements 27.2x22.2mm red 2NO 250V 16A illuminated connection male faston 6.3mm ambient temperature max. 85°C protection IP40		
For models:	CFE505RT, CFE605RT, CFE705RT, CFE714RT		

¹illuminated

microswitches

lever actuated



1

Part No.	530480	Ref. No.	65222001
description	microswitch with plunger 250V 16A 1CO connection male faston 6.3mm L 42mm ambient temperature max. 125°C mounting distance 22mm type EF83161.3 actuating force: 20g		
For models:	CFE505RT, CFE605RT, CFE705RT, CFE714RT		

cam switches

5 operating positions

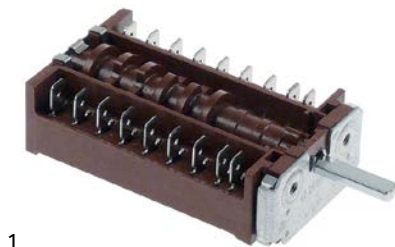

1

Part No.	300258	Ref. No.	65221002
description	cam switch 5 operating positions shaft \varnothing 6x4.6mm shaft L 23mm connection male faston 6.3mm		

operation switches



1

Part No.	300200	Ref. No.	6528979
description	operation switch 2 operating positions 2NO 16A sequence 0-1 shaft \varnothing 6x4.6mm shaft L 23mm connection male faston 6.3mm operation switch ceramic		
For models:	CE1051VTR, CG1051CTA, CG1051CTAE, CG1051EA, CG1051EAE, CG1051GA, CG1051GAE		

lamps

indicator lights

indicator lights (complete)

 \varnothing 9mm

1

Part No.	359135	Ref. No.	6537606
description	indicator light \varnothing 9mm 230V red connection male faston 6.3mm temp.-resist. 120°C with lens		
For models:	CE1051B, CE1051CTA, CE1051EA, CE1051VTR, CE1052E, CE1052VTR, CE841E, CE841VTR, CG1051EB, CG1052GCT, CG1052GE, CG641CT, CG641E, CG731CFCT, CG731CFE, CG731CT, CG731E, CG741CT, CG741E, CG831CFCT, CG831CFE, CG831CT, CG831E, CME401CA, CME410G, CME410GE, CME410GL, CME410GR, CME410M, CME410MCA, CME410RF, CME410SKS, CME410SLK, CME410SLR, CME410SR, CME413FR, CME415FR, CME416FR, CME419FR, CME420E, CME420VTR, CME423VTR, CME434FR, CME610SKS, CME610SLK, CME610SLR, CME610SR, CME610SRK, CME625FR, CME626FR...(Other models you can see in the webshop)		



1

Part No.	359137	Ref. No.	6537607
description	indicator light \varnothing 9mm 230V yellow connection male faston 6.3mm temp.-resist. 120°C with lens		
For models:	CE1051B, CE1051CTA, CE1051EA, CE1051VTR, CE1052E, CE1052VTR, CE741E, CE741VTR, CE841E, CE841VTR, CG1051EB, CG1051GA, CG1051GAE, CG1052GCT, CG1052GE, CG641CT, CG641E, CG731CFCT, CG731CFE, CG731CT, CG731E, CG741CT, CG741E, CG831CFCT, CG831CFE, CG831CT, CG831E, GC1052CFGCT, GC1052CFGE		



1

Part No.	360662	Ref. No.	90000125
description	indicator light \varnothing 9mm yellow 230V connection cable 200mm		



27.2x22.2mm



1

Part No.	359631	Ref. No.	6532193
description	indicator light mounting measurements 27.2x22.2mm 230V yellow connection male faston 6.3mm 1-pole		
For models:	CFE505RT, CFE605RT, CFE705RT, CFE714RT		



1

Part No.	360660	Ref. No.	6532194 6533194
description	indicator light mounting measurements 27.2x22.2mm green 220V connection male faston 6.3mm		
For models:	CFE505RT, CFE605RT, CFE705RT, CFE714RT		



1

Part No.	360659	Ref. No.	65231002
description	indicator light mounting measurements 27.2x22.2mm white 220V connection male faston 6.3mm		
For models:	CFE705RT, CFE714RT		

oven lamps

universal oven lamps

55x70mm



1

Part No.	360608	Ref. No.	65232002
description	lamp 230-240V 25W socket E14 complete temp.-resist. 300°C connection F6.3 L 95mm W 80mm		

timers

electric timers



1

Part No.	350197	Ref. No.	65270002
description	timer MI1 operation time 120min time spreadmin 1CO/1NO at 250V 16A permanent position yes impulse electric shaft ø 6x4.6mm shaft L 23mm mounting distance 28mm connection lateral 2-pole		

mechanical timers



1

Part No.	360632	Ref. No.	6532959
description	timer C10 2-pole operation time 135min impulse mechanical 1NO/1NC at 250V 16A shaft 6x4.6mm shaft L 23mm mounting distance 28.8mm connection male faston 6.3mm 250V		



1

Part No.	350168	Ref. No.	6528965
description	timer C53 2-pole operation time 120min impulse mechanical 1NO/1NC at 250V 16A permanent position no shaft 6x4.6mm shaft L 23mm mounting distance 28mm connection lateral		
For models:	CFE505RT, CFE605RT, CFE705RT, CFE714RT		

alarm devices

buzzers



1

Part No.	350215	Ref. No.	65290012
description	buzzer 220VAC/DC connection male faston 6.3mm moulded built-in version thread M28x1 83dB mounting ø 42.5/32.5mm		



contactors

GENERAL ELECTRIC (AEG)

power contactors



1

Part No.	381345	Ref. No.	65223002
description	power contactor resistive load 20A 400VAC (AC3/400V) 4A/2.2kW main contacts 4NO auxiliary contacts connection screw connection type 100275 type AEG type GE MCOA400ATU		
For models:	CME410GL, CME410GR, CME410SLK, CME410SLR, CME415FR, CME416FR, CME419FR, CME434FR, CME610SLK, CME610SLR, CME610SRK, CME625FR, CME626FR		

relays

time relays

time relays



1

Part No.	360631	Ref. No.	6537884
description	time relay CROUZET MLS2-88826054 time range 0.1s-100h 24-240VAC 0.7A mounting measurements DIN railmm 1NO connection screw		
For models:	CFE705RT, CFE714RT		



solenoïd valves

















solenoïd valves (water)

TP





1

Part No.	370021	Ref. No.	65042005	
description	solenoid valve double straight 230VAC inlet 3/4" outlet 11.5mm DN10 TP flow regulating valve inlet white			
spare parts for	370021			
	Part No.	371013	Ref. No.	—
accessories for	370021			
	Part No.	371220	Ref. No.	—
	reducer TP flow rate 3l/min red tolerance ±15%			

accessories for		370021		
	Part No.	371221	Ref. No.	—
	reducer TP flow rate 5.5l/min yellow tolerance ±15%			
	Part No.	371222	Ref. No.	—
	reducer TP flow rate 6l/min grey tolerance ±15%			
	Part No.	371223	Ref. No.	—
	reducer TP flow rate 10l/min white tolerance ±15%			
	Part No.	371224	Ref. No.	—
	reducer TP flow rate 12l/min bronze tolerance ±15%			
	Part No.	371225	Ref. No.	—
	reducer TP flow rate 16l/min light brown tolerance ±15%			
	Part No.	371226	Ref. No.	—
	reducer TP flow rate 20l/min red tolerance ±15%			
	Part No.	371230	Ref. No.	—
	reducer TP flow rate 0.25l/min red tolerance ±25%			
	Part No.	371231	Ref. No.	—
	reducer TP flow rate 0.35l/min violet tolerance ±25%			
	Part No.	371232	Ref. No.	—
	reducer TP flow rate 0.5l/min orange tolerance ±25%			
	Part No.	371233	Ref. No.	—
	reducer TP flow rate 0.8l/min white tolerance ±25%			
	Part No.	371234	Ref. No.	—
	reducer TP flow rate 1l/min light blue tolerance ±25%			
	Part No.	371235	Ref. No.	—
	reducer TP flow rate 1.2l/min brown tolerance ±25%			
	Part No.	371236	Ref. No.	—
	reducer TP flow rate 1.5l/min light brown tolerance ±25%			
	Part No.	371237	Ref. No.	—
	reducer TP flow rate 2.5l/min yellow tolerance ±25%			
	Part No.	371238	Ref. No.	—
	reducer TP flow rate 3.4l/min dark green tolerance ±25%			
	Part No.	371239	Ref. No.	—
	reducer TP flow rate 5l/min black tolerance ±25%			
	Part No.	371240	Ref. No.	—
	reducer TP flow rate 8l/min blue tolerance ±20%			



  1			
Part No.	370025	Ref. No.	65109013
description	solenoid valve triple straight 230VAC inlet 3/4" outlet 11.5mm DN10 TP		
spare parts for	370025		
	Part No.	371013	Ref. No. —
	solenoid coil TP 230VAC 50/60Hz		
accessories for	370025		
	Part No.	371220	Ref. No. —
	reducer TP flow rate 3l/min red tolerance ±15%		
	Part No.	371221	Ref. No. —
	reducer TP flow rate 5.5l/min yellow tolerance ±15%		
	Part No.	371222	Ref. No. —
	reducer TP flow rate 6l/min grey tolerance ±15%		
	Part No.	371223	Ref. No. —
	reducer TP flow rate 10l/min white tolerance ±15%		
	Part No.	371224	Ref. No. —
	reducer TP flow rate 12l/min bronze tolerance ±15%		
	Part No.	371225	Ref. No. —
	reducer TP flow rate 16l/min light brown tolerance ±15%		
	Part No.	371226	Ref. No. —
	reducer TP flow rate 20l/min red tolerance ±15%		
	Part No.	371230	Ref. No. —
	reducer TP flow rate 0.25l/min red tolerance ±25%		
	Part No.	371231	Ref. No. —
	reducer TP flow rate 0.35l/min violet tolerance ±25%		
	Part No.	371232	Ref. No. —
	reducer TP flow rate 0.5l/min orange tolerance ±25%		
	Part No.	371233	Ref. No. —
	reducer TP flow rate 0.8l/min white tolerance ±25%		
	Part No.	371234	Ref. No. —
	reducer TP flow rate 1l/min light blue tolerance ±25%		
	Part No.	371235	Ref. No. —
	reducer TP flow rate 1.2l/min brown tolerance ±25%		
	Part No.	371236	Ref. No. —
	reducer TP flow rate 1.5l/min light brown tolerance ±25%		
	Part No.	371237	Ref. No. —
	reducer TP flow rate 2.5l/min yellow tolerance ±25%		

accessories for	370025		
	Part No.	371238	Ref. No. —
	reducer TP flow rate 3.4l/min dark green tolerance ±25%		
	Part No.	371239	Ref. No. —
	reducer TP flow rate 5l/min black tolerance ±25%		
	Part No.	371240	Ref. No. —
	reducer TP flow rate 8l/min blue tolerance ±20%		

metal			
ODE			
solenoid valves steam (water)			
4991K series			
 1			
Part No.	370801	Ref. No.	6532053
description	solenoid valve brass 2-ways 220-230V/50-60Hz inlet 1/4" outlet 1/4" L 35mm DN 2.5mm ODE coil type BDA p max 14bar		
For models:	CFE705RT, CFE714RT		

fans			
hot air motors			
 1			
Part No.	601221	Ref. No.	65260003
description	fan wheel D1 ø 180mm H1 60mm blades 12 D2 ø 9mm D3 ø 12.5mm H2 35mm		
For models:	CFE707RT, CFE714RT		



hot air fans

ebm-papst



1

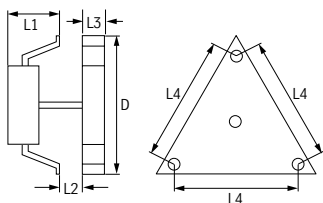

Part No.	601249	Ref. No.	6539352
description	hot air fan 230V 32W 0.27A L1 60mm L2 20mm L3 20mm L4 157mm fan wheel ø 150mm ebm-papst type R2K150-AC01-15		
For models:	CE1051CTA, CE1051EA, CG1051CTA, CG1051CTAE, CG1052GCT, CG641CT, CG731CFCT, CG731CT, CG741CT, CG831CFCT, CG831CT, GC1052CFGCT		



1

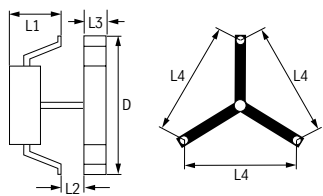

Part No.	602033	Ref. No.	6527753
description	hot air fan 220V 46W 4 hole fixing L1 15mm L2 65mm L3 20mm L4 134/147mm fan wheel ø 150mm type R2S150-AD08-09 ebm-papst		

HANNING



1

Part No.	602034	Ref. No.	65260006
description	hot air fan 200-240V L1mm L2mm L3 25mm L4mm fan wheel ø 180mm HANNING type EMC		
For models:	CFE505RT		

motors

motors

for combi-steamers



1

Part No.	602028	Ref. No.	65260008
description	motor 75W 220-240V 50Hz 1 phase 0.55A shaft ø 11.5mm shaft length 75mm flange ø 90mm 2800rpm type 1074.1922 ø 130mm H 200mm mounting distance 64.5mm FIR 0.075kW		

electric accessories

terminals

connection terminals with screw/faston connections



1

Part No.	550411	Ref. No.	6551785
description	power terminal block 6-pole max. 40A max 450V connection ø6mm ² / F6.3 temp.-resist. 150°C cross section 6mm ²		
For models:	CE1051B, CE1051CTA, CE1051EA, CE1051VTR, CE1052E, CE1052VTR, CE741E, CE841E, CE841VTR, CFE505RT, CFE605RT, CFE705RT, CFE714RT, CG1051CTA, CG1051CTAE, CG1051EA, CG1051EAE, CG1052GCT, CG641CT, CG731CFCT, CG731CT, CG741CT, CG831CFCT, CG831CT, CME410G, CME410GE, CME410GL, CME410GR, CME410M, CME410MCA, CME410SKS, CME410SLK, CME410SLR, CME410SR, CME415FR, CME416FR, CME419FR, CME420E, CME420VTR, CME423VTR, CME434FR, CME610SKS, CME610SLK, CME610SLR, CME610SR, CME610SRK, CME625FR, CME626FR, CME801CA, CME810M...(Other models you can see in the webshop)		





ignition parts

ignition units

 <p>1</p>			
Part No.	102389	Ref. No.	65226007
description	ignition unit outputs 6 230VAC dimensions 135x23x34mm mounting distance 123mm inlet F6.3x0.8 outlet F2.8x0.8 0.6VA 50/60Hz		
For models:	CMG410GL, CMG410GR, CMG410SLK, CMG410SLR, CMG610SLK, CMG610SLR, CMG610SRK		

miscellaneous

 <p>1</p>			
Part No.	692595	Ref. No.	50309500
description	bracket for motor gasket SS L 79.5mm W 70mm		

 <p>1</p>			
Part No.	698635	Ref. No.	50325200
description	reducer bore ø 6mm D1 ø 50mm D2 ø 59mm SS H 35mm Qty 1 pcs		

 <p>1</p>			
Part No.	698636	Ref. No.	5038147
description	spacer piece SS thread 3/4" thickness 5mm H 70mm Qty 1 pcs		
For models:	CME410M, CME413FR, CME415FR, CME416FR, CME419FR, CME434FR, CME625FR, CME626FR		

knobs

producer-specific knobs

<p>AMBASSADE</p>  <p>1</p>			
Part No.	112740	Ref. No.	65044000 88044000
description	knob switch zero mark t.max.°C ø 49mm shaft ø 6x4.6mm shaft flat upper black		
For models:	CFE705RT, CFE714RT		

 <p>1</p>			
Part No.	112787	Ref. No.	8828178
description	knob switch zero mark t.max.°C ø 55mm shaft ø 6x4.6mm shaft flat universal		

 <p>1</p>			
Part No.	112056	Ref. No.	65044004 88044004
description	knob thermostat t.max. 110°C 30-110°C ø 49mm shaft ø 6x4.6mm shaft flat upper black temperature range 30-110°C		
For models:	CE1051CTA, CE1051EA, CG1051GA, CG1051GAE, CME401CA, CME410G, CME410M, CME410MCA, CME801CA, CME810M, CME810MCA		

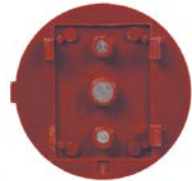
 <p>1</p>			
Part No.	112049	Ref. No.	65043002
description	rosette knob		
For models:	CE1051B, CE1051CTA, CE1051EA, CE1051VTR, CE1052E, CE1052VTR, CE641E, CE741E, CE741VTR, CE841E, CE841VTR, CG1051EB, CG-1051GA, CG1051GAE, CG1052GCT, CG1052GE, CG641CT, CG641E, CG731CFCT, CG731CFE, CG731CT, CG731E, CG741CT, CG741E, CG831CFCT, CG831CFE, CG831CT, CG831E, CME401CA, CME410G, CME410M, CME410MCA, CME410SKS, CME410SR, CME413FR, CME-415FR, CME416FR, CME419FR, CME420E, CME420VTR, CME423VTR, CME434FR, CME610SKS, CME610SR, CME625FR, CME626FR, CME-801CA, CME810M, CME810MCA, GC1052CFGCT...(Other models you can see in the webshop)		



accessories

rosettes

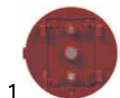

1

Part No.	112049	Ref. No.	65043002
description	rosette knob		
For models:	CE1051B, CE1051CTA, CE1051EA, CE1051VTR, CE1052E, CE1052VTR, CE641E, CE741E, CE741VTR, CE841E, CE841VTR, CG1051EB, CG-1051GA, CG1051GAE, CG1052GCT, CG1052GE, CG641CT, CG641E, CG731CFCT, CG731CFE, CG731CT, CG731E, CG741CT, CG741E, CG831CFCT, CG831CFE, CG831CT, CG831E, CME401CA, CME410G, CME410M, CME410MCA, CME410SKS, CME410SR, CME413FR, CME-415FR, CME416FR, CME419FR, CME420E, CME420VTR, CME423VTR, CME434FR, CME610SKS, CME610SR, CME625FR, CME626FR, CME-801CA, CME810M, CME810MCA, GC1052CFGCT...(Other models you can see in the webshop)		

producer-specific

AMBASSADE



1

Part No.	692671	Ref. No.	65132002
description	snap lock L 59mm W 10mm H 15mm mounting distance 50mm complete with door catch thickness 2.4mm		



1

Part No.	692670	Ref. No.	65139012
description	snap lock L 60mm W 19mm H 20mm mounting distance 50.5mm complete with door catch thickness 1.2mm		

locks

edgmount latches

handle latches

CAFF/FERMOD

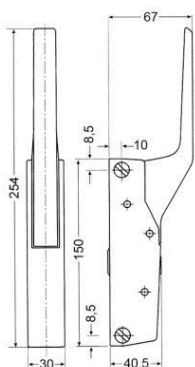

1

Part No.	701453	Ref. No.	6532023
description	handle latch L 150mm mounting distance 133mm metal heated units W 29.7mm type 790 / 791 total length 250mm handle length 100mm overall height 67mm		
For models:	CFE705RT, CFE707RT, CFE710RT, CFE714RT		

hinges

edgmount hinges

CAFF/FERMOD



1

Part No.	692669	Ref. No.	6532022
description	edgmount hinge L 96mm W 15/17mm mounting distance 64/32mm hinging left/right without lift centre of rotation 14/23mm		
For models:	CFE705RT, CFE707RT, CFE710RT		

snap locks

universal



1

Part No.	692609	Ref. No.	6532934
description	snap lock L 70mm W 13mm H 21mm mounting distance 60/30mm complete with door catch zamak		

gaskets

gaskets for heated units

door seals

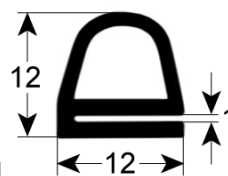

1

Part No.	902157	Ref. No.	65111018
description	door seal profile 2211 W 470mm L 590mm external size		



door seals with fixing hook



Part No.	901850	Ref. No.	65111034 6531833
description	door seal L 420mm W 315mm 4-sided with hook		



Part No.	902008	Ref. No.	65111016
description	door seal L 460mm W 405mm 4-sided with mounting clip		
For models:	CFE605RT		



Part No.	902007	Ref. No.	65111003
description	door seal L 505mm W 405mm 4-sided with mounting clip		



Part No.	901965	Ref. No.	65111012
description	door seal L 580mm W 390mm 4-sided with mounting clip		
For models:	CFE705RT		



Part No.	901967	Ref. No.	65111013 65111027
description	door seal L 930mm W 565mm 4-sided with 5 mounting clips		
For models:	CFE714RT		

hoses

industrial hoses

silicone hoses

without fabric

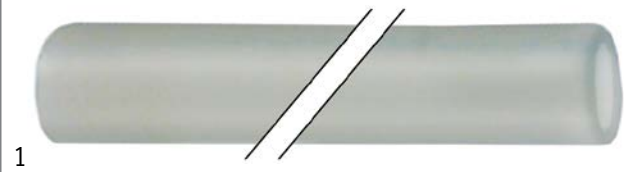

Part No.	570042	Ref. No.	0228530
description	silicone hose ID ø 8mm ED ø 12mm L 5m		

measuring equipment

thermometers

built-in thermometers

ø60mm



Part No.	542180	Ref. No.	65224012
description	thermometer mounting ø 60mm t.max. 400°C 0-400°C probe ø 8mm probe L 150mm capillary pipe 1500mm		

GASTROPARTS.COM



© 2020 Gastroparts Sp. J. All rights reserved.