



GASTROPARTS

Virtus

- [EN]** Equipment
- [DE]** Geräte
- [ES]** Aparatos
- [FR]** Équipement
- [IT]** Attrezzature
- [PL]** Urządzenia
- [RU]** Оборудование

✉ gastroparts@gastroparts.com

☎ +48 56 657 00 66

📘 fb.com/gastroparts.global

GASTROPARTS.COM







heating elements

heating elements for ovens

			
Part No.	420111	Ref. No.	965.060.00
description	heating element 1500W 230V heating circuits 1 L 555mm W 210mm L1 70mm L2 485mm W1 88mm W2 33mm flange length 70mm flange width 22mm hole distance 56mm hole \varnothing 5mm tube \varnothing 8.5mm connection male faston 6.3mm connection length 17mm windings 3 flange connection dry heating element for oven		
For models:	VS70120CFGE, VS7080CFE, VS7080CFEQ, VS7080CFGE, VS7080CFVE, VS7080TPFE, VS90120CFGE, VS90160CFGE, VS9080CFES, VS9080CFGE, VS9080CFVE, VS9080TPFE		

heating elements for bain maries

			
Part No.	415927	Ref. No.	665.004.00
description	heating element 1200W 240V heating circuits 1 L 405mm W 88mm H 32mm lug length 40mm lug width 18mm dry heating element hole distance 44mm connection M5 bracket mounting mounting thread M5		
For models:	VS7080BMET, VS7080BMFEP		

			
Part No.	416538	Ref. No.	965.002.00
description	heating element 1470W 230V heating circuits 1 L 528mm W 95mm H 30mm lug length 40mm lug width 19mm tube \varnothing 8.5mm dry heating element hole distance 46mm connection M5 bracket mounting connection length 34mm hole \varnothing 5mm water bath		
For models:	VS9080BMET, VS9080BMFEP		

			
Part No.	415926	Ref. No.	665.003.00
description	heating element 1800W 240V heating circuits 1 L 403mm W 128mm H 32mm lug length 40mm lug width 18mm tube \varnothing 8.5mm dry heating element hole distance 80mm bracket mounting mounting thread M5		
For models:	VS7040BMET, VS7040BMFEP		

			
Part No.	416537	Ref. No.	965.001.00
description	heating element 2200W 230V heating circuits 1 L 523mm W 134mm H 32mm lug length 40mm lug width 18mm tube \varnothing 9mm dry heating element hole distance 79mm connection M5 bracket mounting connection length 30mm mounting thread M5 bain marie		
For models:	VS9040BMET, VS9040BMFEP		

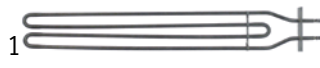
			
Part No.	417724	Ref. No.	965.062.00
description	heating element 2500W 230V heating circuits 1 L 630mm W 90mm flange length 100mm flange width 35mm hole distance 88mm connection M5 tube \varnothing 8.5mm rectangular flange hole \varnothing 6mm immersion heater bain marie		
For models:	VS9040GRACQE, VS9080GRACQE		

heating elements for fryers

off-center connection

with thread

			
Part No.	420482	Ref. No.	665.101.00
description	heating element 12000W 230V heating circuits 3 L 315mm W 175mm H 32mm flange length 26mm flange \varnothing 1 62mm sensor screw connection M10x1 number of thermostat sleeves 2 thermostat sleeve upper/lower L1 15mm L2 300mm W1 30mm W2 33mm for o-ring \varnothing 51/56mm tube \varnothing 8.5mm cable length 515mm connection cable		
For models:	VS7040FRE17X, VS7080FRE17X, VS9040FRE17, VS9080FRE17		

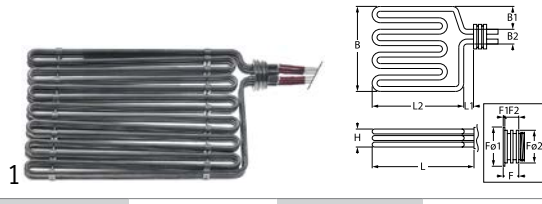
			
Part No.	420560	Ref. No.	965.065.00
description	heating element 20000W 400V heating circuits 3 L 425mm W 255mm H 35mm flange length 19mm flange \varnothing 1 62mm flange \varnothing 2 57mm L1 21mm L2 408mm W2 34mm thread M54x1.5 tube \varnothing 8.5mm cable length 510mm fryer		
For models:	VS7040FRE17X, VS7080FRE17X, VS9040FRE17, VS9040FRE21, VS-9080FRE17, VS9080FRE21		

2 hole fixing

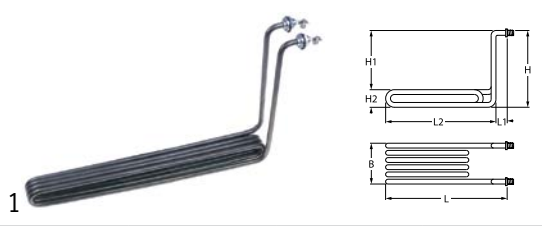
			
Part No.	419031	Ref. No.	965.009.00
description	heating element 3400/3700W 230/240V heating circuits 1 L 405mm W 44mm H 228mm L1 25mm L2 380mm H1 192mm H2 36mm thread M14x1.5 mounting distance 36mm tube \varnothing 8.5mm 2 hole fixing connection M5 immersion heater windings 4 fryer		
For models:	VS9040FRE15, VS9080FRE15		



heating elements for griddles



Part No.	417736	Ref. No.	665.095.00 665.095.12
description	heating element 1800W 230V heating circuits 1 L 470mm W 95mm H 95mm tube ø 8.5mm connection M4		
For models:	V080FTREVCRT, V7040FTREVCRT, VS7040FTET, VS7040FTREVCRT, VS7040FTEVT, VS7040FTRET, VS7040FTREVT, VS7080FTET, VS7080FTEVCRT, VS7080FTEVT, VS7080FTRET, VS7080FTREVT, VS7080FTRRET, VS7080FTRREVC, VS7080FTRREVT		



Part No.	420105	Ref. No.	665.102.00
description	heating element 2000W 230V heating circuits 1 L 480mm W 90mm H 42mm tube ø 8.5mm IRCA L1 50mm L2 430mm W1 49mm W2 20mm flange connection connection M5 hole distance 89mm flange length 100mm flange width 35mm hole ø 6mm windings 2 dry heating element		
For models:	VS7040GRACQE, VS7080GRACQE		



Part No.	417735	Ref. No.	965.059.12
description	heating element 2500W 230V heating circuits 1 L 610mm W 80mm H 95mm tube ø 8.5mm connection M4		
For models:	V9040FTREVCRT, V9080FTREVCRT, V9080FTRRECR, VS9040FTREVCRT, VS9040FTET, VS9040FTEVCRT, VS9040FTEVT, VS9040FTRECR, VS-9040FTRET, VS9040FTREVT, VS9080FTREVCRT, VS9080FTET, VS9080FTEVCRT, VS9080FTEVT, VS9080FTRECR, VS9080FTRET, VS9080FTREVT, VS9080FTRRET, VS9080FTRREVC, VS9080FTRREVT		

heating elements for refrigeration

heating elements for defrosting



Part No.	419195	Ref. No.	B00REZ116
description	heating element 2x100W 2x115V L 380mm Wmm cable length 1500mm tube ø 8.5mm defrosting		
For models:	BMA0008-F, BMA0010-F, BNA0036-F, BNA0037-F, BNA0045-F, BNA0052-F, BNA0053-F, BNA0054-F, BNA0055-F, BNA0057-F, BNA0064-F, BNA0065-F, BNA0066-F, CCZ0036-F, CCZ0037-F		

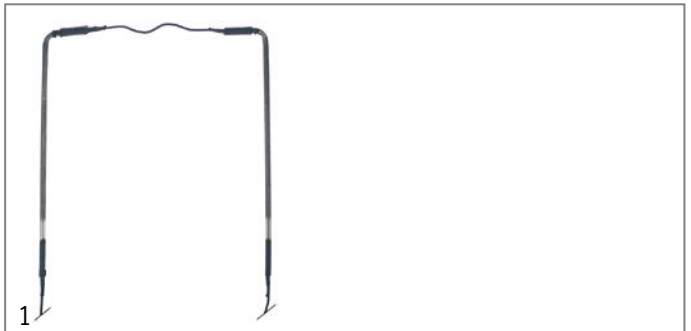

Part No.	419197	Ref. No.	B00REZ111
description	heating element 2x200W 2x110V L 400mm Wmm cable length 1500mm tube ø 8.5mm defrosting		
For models:	BMB0035-F, BMB0036-F, BMB0037-F, BNB0010-F, BNB0011-F, BNB0012-F, BNB0013-F, BNB0014-F, BNB0015-F, BNZ0007-F, PB9RI-F, VTGB4A-F		



Part No.	419196	Ref. No.	B00REZ100
description	heating element 55W 220V L 410mm W 50mm H 80mm cable length 1600mm tube ø 8.5mm defrosting		
For models:	BMB0035-F, BMB0036-F, BMB0037-F, BNA0030-F, BNA0031-F, BNA0036-F, BNA0044-F, BNA0056-F, BNZ0002-F, BNZ0004-F, BNZ0006-F, BNZ0008-F, CCZ0036-F, CCZ0037-F, PB9RI-F, VTGB2A-F, VTGB2-F, VTGB3A-F, VTGB3-F, VTGB4-F		

heating elements for tilting bratt pan



Part No.	417726	Ref. No.	665.110.00
description	heating element tilting bratt pan 3330W 230V L 385mm W 220mm H 35mm connection M4 dry heating element heating circuits 1 tube ø 8.5mm		
For models:	VS7080BREI, VS7080BREIM		

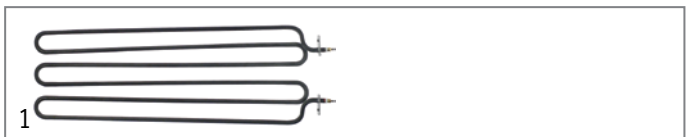

Part No.	417725	Ref. No.	965.073.00
description	heating element tilting bratt pan 5000W 230V L 550mm W 190mm H 25mm connection M4 dry heating element heating circuits 1 tube ø 8.5mm		
For models:	VS9080BREI, VS9080BREIM		



heating elements for pasta cookers

 <p>1</p>			
Part No.	419247	Ref. No.	665.103.00
description	heating element 4500W 230V heating circuits 3 L 350mm connection male faston 6.3mm tube ø 6.3mm flange ø 72mm thermostat sleeves ø 8.5mm length thermostat sleeves 200mm immersion heater		
For models:	VS9040CPES, VS9080CPES		

heating elements for pizza presses

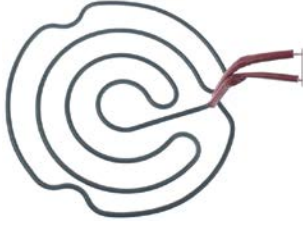
 <p>1</p>			
Part No.	418047	Ref. No.	91711080
description	heating element 1600W 230V L 300mm Wmm heating circuits 1 cable length 1450mm connection length 30mm dry heating element tube ø 6.3mm ext. ø 300		
For models:	CBC0003		

 <p>1</p>			
Part No.	418048	Ref. No.	91711081
description	heating element 1790W 208V heating circuits 1 cable length 1350mm tube ø 6.3mm ext. ø 300 connection distance 50mm		
For models:	CBC0001		

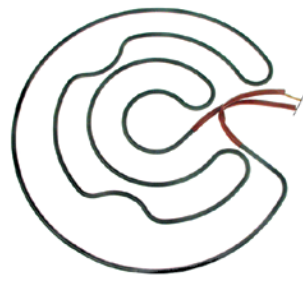
 <p>1</p>			
Part No.	418049	Ref. No.	91711082
description	heating element 2200W 220V heating circuits 1 cable length 1480mm dry heating element tube ø 6.3mm ext. ø 385 connection distance 38mm		
For models:	CBC0004		

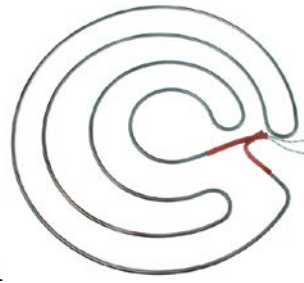
 <p>1</p>			
Part No.	418051	Ref. No.	91711084
description	heating element 2900/3200W 208/230V cable length 1400mm dry heating element tube ø 6.3mm ext. ø 475		
For models:	CBC0002		

dry heating elements for dishwashers

 <p>1</p>			
Part No.	420561	Ref. No.	12048965
description	heating element 2800W 230V heating circuits 1 L 325mm W 55mm H 40mm tube ø 6.5mm connection F6.3x0.8 dry heating element dishwasher		
For models:	GLB0067-F, GLB0069-F		

heating cables

<p>drain heating cables</p>  <p>1</p>			
Part No.	381244	Ref. No.	B00REZ104
description	drain heating cable 40W 220V 50Hz L 2000mm L1 (unheated) 1000mm L2 (heated) 1000mm cable ø 5mm connection 2-wire		
For models:	BNZ0007-F, VTGB4A-F		

 <p>1</p>			
Part No.	381250	Ref. No.	B00REZ103
description	drain heating cable 80W 220V ø 5.5mm L 3000mm L1 (unheated) 950mm L2 (heated) 2050mm thread probe ø 8x7mm rubber probe L 42mm cable silicone resistor at +20°C 0.6kOhm cable colours grey cable length 3m 2-wire		
For models:	BMB0030-F, BMC0012-F, BMC0014-F, BMC0016-F		

connection on both sides

<p>with wire end ferrules</p>  <p>1</p>			
Part No.	381402	Ref. No.	B00REZ112
description	heating cable 37W 220V 50Hz L 7000mm L1 (unheated) 300mm L2 (heated) 6700mm cable ø 3mm		
For models:	BNB0012-F, BNB0013-F		





			
Part No.	419220	Ref. No.	B00REZ113
description	heating cable 37W 220V L 9000mm L1 (unheated) 740mm L2 (heated) 8260mm silicone impregnated glass fibre braiding \varnothing 3mm connection terminal		
For models:	BNB0014-F, BNB0015-F, VTGB4A-F		

heating cartridges

			
Part No.	419212	Ref. No.	B00REZ106
description	heating cartridge 190W 230V \varnothing 12mm L 180mm thread 3/8" cable length 1000mm		
For models:	BMA0021-F, BMA0022-F, BMA0024-F, BMA0025-F, BMA0029-F, BMB0030-F, BMC0012-F, BMC0014-F, BMC0016-F		

ceramic heaters

245x60mm



			
Part No.	415104	Ref. No.	665.010.00
description	ceramic emitter 1000W 230V cable beaded cord L 245mm W 60mm H 35mm		
For models:	VS7040SPET, VS9040SPET		
spare parts for	415104		
	Part No.	415109	Ref. No. —
		spring clip	
accessories for	415104		
	Part No.	415110	Ref. No. —
		reflector L 245mm W 95mm H 31mm thickness 0.75mm hole \varnothing 15x40mm	



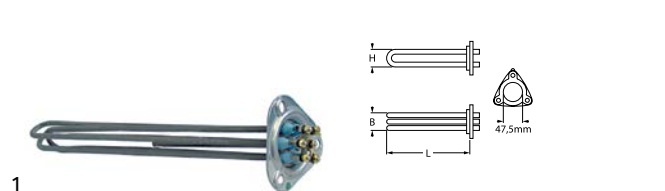

coil heating elements

			
Part No.	420330	Ref. No.	927132
description	heating element 2000W 240V L 454mm W 210mm \varnothing 27.5mm thread M14x1 connection M4 for drying warewashing heating circuits 1 2 hole fixing		
For models:	GLB0045, GLB0047, GLB0048, GLB0049, GLB0050, GLB0051		

immersion heating elements

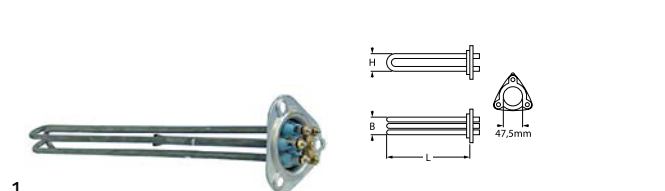
3 hole flange \varnothing 47.5mm

			
Part No.	416240	Ref. No.	230083C
description	heating element 6545W 230/400V mounting \varnothing 48mm heating circuits 3 L 355mm W 31mm H 37mm number of thermostat sleeves 1 thermostat sleeves \varnothing 7mm length thermostat sleeves 175mm thermostat sleeve upper centre not clinging tube \varnothing 6.5mm hole distance 63mm hole \varnothing 10mm connection M4 3 hole flange immersion heater		
For models:	GLB0040, GLB0041, GLB0042, GLB0043C, GLB0044C, GLB0049, GLB0050, GLB0051		
accessories for	416240		
	Part No.	510408	Ref. No. 456002
		O-ring EPDM thickness 5.34mm ID \varnothing 47mm Qty 1 pcs	
	Part No.	510562	Ref. No. —
		O-ring silicone thickness 5.34mm ID \varnothing 47mm Qty 1 pcs	

			
Part No.	416241	Ref. No.	230020C
description	heating element 8000W 230V mounting \varnothing 47.5mm heating circuits 3 L 355mm W 35mm H 35mm number of thermostat sleeves 1 thermostat sleeves \varnothing 7.5mm length thermostat sleeves 185mm thermostat sleeve not clinging tube \varnothing 6.3mm hole distance 64mm hole \varnothing 8mm connection M4 3 hole flange immersion heater		
For models:	GLB0043C, GLB0043C-60Hz, GLB0045, GLB0047, GLB0048, GLB0049, GLB0050, GLB0051		
spare parts for	416241		
	Part No.	510408	Ref. No. 456002
		O-ring EPDM thickness 5.34mm ID \varnothing 47mm Qty 1 pcs	
accessories for	416241		
	Part No.	510093	Ref. No. 467002 69870
		protection cap	
	Part No.	510408	Ref. No. 456002
		O-ring EPDM thickness 5.34mm ID \varnothing 47mm Qty 1 pcs	
	Part No.	510562	Ref. No. —
		O-ring silicone thickness 5.34mm ID \varnothing 47mm Qty 1 pcs	



1

Part No.	416242	Ref. No.	80398C
description	heating element 9500W 230V mounting \varnothing 47.5mm heating circuits 3 L 330mm W 35mm H 35mm number of thermostat sleeves 1 thermostat sleeves \varnothing 7mm length thermostat sleeves 175mm thermostat sleeve eccentric, non clinging tube \varnothing 8.5mm hole distance 72mm hole \varnothing 8/10mm connection M4 3 hole flange immersion heater		
For models:	GLB0044C, GLB0047, GLB0048, GLB0051		
spare parts for	416242		
	Part No.	510408	Ref. No. 456002
	O-ring EPDM thickness 5.34mm ID \varnothing 47mm Qty 1 pcs		

3 hole flange \varnothing 57.5mm

1

Part No.	417738	Ref. No.	965.068.00
description	heating element 10500W 230V mounting \varnothing 57.5mm heating circuits 3 L 575mm W 30mm H 40mm tube \varnothing 8.5mm hole distance 75mm hole \varnothing 8/10mm cable length 700mm connection cable 3 hole flange kettle		
For models:	VS9080PEI150		

with round flange \varnothing 57.5mm

1

Part No.	416662	Ref. No.	665.022.00
description	heating element 6000W 230V heating circuits 3 L 405mm W 31mm H 46mm tube \varnothing 6.3mm thermostat sleeves \varnothing 7.5mm length thermostat sleeves 270mm number of thermostat sleeves 1 thermostat sleeve eccentric, clinging connection male faston 6.3mm immersion heater round flange mounting \varnothing 57.5mm		
For models:	VS7080PEI50		
spare parts for	416662		
	Part No.	510409	Ref. No. —
	O-ring EPDM thickness 5.34mm ID \varnothing 56.52mm Qty 1 pcs		
accessories for	416662		
	Part No.	520235	Ref. No. —
	3 hole flange hole distance 70.5mm perforation \varnothing 6.5mm ID \varnothing 53.5mm		
	Part No.	550002	Ref. No. —
	tension strap H 10mm L 21mm W 10mm hole \varnothing 6.5mm for heating element		

with round flange (miscellaneous)

1

Part No.	419247	Ref. No.	665.103.00
description	heating element 4500W 230V heating circuits 3 L 350mm connection male faston 6.3mm tube \varnothing 6.3mm flange \varnothing 72mm thermostat sleeves \varnothing 8.5mm length thermostat sleeves 200mm immersion heater		
For models:	VS9040CPES, VS9080CPES		

miscellaneous

1

Part No.	420362	Ref. No.	12024747
description	heating element 9000W 230V heating circuits 3 L 280mm W 77mm H 29mm flange hole distance 47.5mm hole \varnothing 6mm connection male faston 6.3mm tube \varnothing 8.5mm flange length 105mm flange width 60mm immersion heater		
For models:	AIC0039-F, AIC0041-F, AIC0043-F, AIC0045-F		
accessories for	420362		
	Part No.	550994	Ref. No. 12023680
	gasket L 105mm W 60mm thickness 3mm for heating element		

1







Part No.	417197	Ref. No.	12024752
description	heating element 9000W 230V heating circuits 3 L 280mm W 78mm H 35mm hole distance 48mm hole \varnothing 6mm tube \varnothing 8.5mm flange length 105mm flange width 60mm immersion heater thermostat sleeves \varnothing 3mm number of thermostat sleeves 1 length thermostat sleeves 115mm		
For models:	AIC0037-F, AIC0039-F, AIC0041-F, AIC0043-F, AIC0045-F		
accessories for	417197		
	Part No.	550994	Ref. No. 12023680
	gasket L 105mm W 60mm thickness 3mm for heating element		

1"

1

Part No.	420074	Ref. No.	965.066.00
description	heating element 260W 230V heating circuits 1 L 242mm W 18mm H 6.25mm tube \varnothing 6.25mm thermostat sleeves \varnothing 5mm length thermostat sleeves 230mm number of thermostat sleeves 1 thermostat sleeve centred, adjacent connection male faston 6.3mm connection length 35mm immersion heater flange with thread WS 32 thread 1"		
For models:	VS7080PEI50, VS7080PGI50, VS9080PEI150, VS9080PGI150		
spare parts for	420074		
	Part No.	503158	Ref. No. —
	flat gasket FIBER ED \varnothing 44mm ID \varnothing 33mm thickness 2mm Qty 1 pcs		
accessories for	420074		
	Part No.	507532	Ref. No. —
	nut thread 1" H 10mm WS 40 brass Qty 1 pcs		





			
1			
Part No.	416235	Ref. No.	70562 80360
description	heating element 3000W 230V heating circuits 1 L 320mm W 50mm H 40mm thread M10x1 mounting distance 44mm tube ø 6.3mm connection male faston 6.3mm 2 hole fixing L1 32mm L2 288mm		
For models:	GLB0040, GLB0041		
spare parts for	416235		
	Part No.	510893	Ref. No. —
	O-ring EPDM thickness 2.62mm ID ø 9.92mm Qty 1 pcs		
accessories for	416235		
	Part No.	510416	Ref. No. —
	flat gasket fibre ED ø 19mm ID ø 10.5mm thickness 1.5mm for thread M10 Qty 1 pcs		
	Part No.	510893	Ref. No. —
	O-ring EPDM thickness 2.62mm ID ø 9.92mm Qty 1 pcs		
	Part No.	521129	Ref. No. —
	nut thread M10 H 6mm SS WS 17 Qty 1 pcs DIN/ISO DIN 439		
	Part No.	560192	Ref. No. —
	tooth lock washer ID ø 10.4mm ED ø 18mm SS DIN/ISO DIN 6798A Qty 1 pcs for thread M10		

			
1			
Part No.	420334	Ref. No.	41211
description	heating element 3000W 230V heating circuits 1 L 380mm W 87mm H 26mm thread M10x1 mounting distance 81mm tube ø 6.3mm connection M4 immersion heater 2 hole fixing		
For models:	GLB0041, GLB0042		

heating elements for convection

			
1			
Part No.	419270	Ref. No.	12024349
description	heating element 15000W 230V heating circuits 3 ID ø 540mm ED ø 560mm L 580mm H 148mm W1 160mm H1 16mm H2 132mm flange length 210mm flange width 30mm hole distance 180mm connection M4 tube ø 10mm mounting thread M6		
For models:	AIC0041-F, AIC0045-F, AIC0073-F, AIC0075-F		

			
1			
Part No.	419271	Ref. No.	12024359
description	heating element 15000W 230V heating circuits 3 ID ø 620mm ED ø 640mm L 660mm H 152mm W1 160mm H1 20mm H2 132mm flange length 210mm flange width 30mm hole distance 180mm connection M4 tube ø 10mm mounting thread M6		
For models:	AIC0041-F, AIC0045-F, AIC0073-F, AIC0075-F		

			
1			
Part No.	419268	Ref. No.	12039496
description	heating element 9000W 230V heating circuits 3 ID ø 410mm ED ø 417mm L 450mm H 100mm L1 15mm W1 105mm H1 80mm H2 20mm flange length 142mm flange width 25mm mounting distance 125mm connection M4 tube ø 8.5mm mounting thread M6		
For models:	AIC0037-F, AIC0039-F, AIC0043-F, AIC0071-F, AIC0072-F, AIC0074-F		
accessories for	419268		
	Part No.	521284	Ref. No. 12041165
	gasket for heating element L 142mm W 25mm thickness 2mm graphite		

			
1			
Part No.	419269	Ref. No.	12039497
description	heating element 9000W 230V heating circuits 3 ID ø 490mm ED ø 507mm L 53mm H 100mm L1 14mm W1 100mm H1 83mm H2 17mm flange length 142mm flange width 25mm mounting distance 125mm connection M4 tube ø 8.5mm mounting thread M6		
For models:	AIC0039-F, AIC0043-F, AIC0072-F, AIC0074-F		



radiation heaters



1

Part No.	490079	Ref. No.	965.041.00
description	radiation heater octagonal 3400W 230V L 300mm W 300mm heating circuits 2 H 30mm with heating coil energy regulation with temperature signalization connections 4+2 connection type cable AD		
For models:	VS9040PVET, VS9080CFVE, VS9080PVET, VS9080TPET, VS9080TPFE		
spare parts for	490079		
	Part No.	390931	Ref. No. —
	safety thermostat for radiation heater		



1

Part No.	490222	Ref. No.	965.069.00
description	radiation heater octagonal 3400W 230V L 300mm W 300mm heating circuits 2 H 35mm with heating coil energy regulation with temperature signalization		
For models:	VS9040PVET, VS9080CFVE, VS9080PVET		

2-circuit



1

Part No.	490118	Ref. No.	665.052.00
description	radiation heater ø 250mm 2500W heating circuits 2 partial power 1000W		
For models:	VS7080CFVE, VS7080PVET, VS7080TPET, VS7080TPFE		

accessories

hexagonal nuts



1

Part No.	560131	Ref. No.	12009839
description	hexagonal nut thread M4 H 3.2mm WS 7 SS DIN/ISO DIN 934 / ISO 4032/8673 Qty 20 pcs		
For models:	AIC0037-F, AIC0038-F, AIC0039-F, AIC0040-F, AIC0041-F, AIC0042-F, AIC0043-F, AIC0044-F, AIC0045-F, AIC0046-F, AIC0074-F, AIC0075-F		



1

Part No.	560132	Ref. No.	12010284
description	hexagonal nut thread M5 H 4mm WS 8 SS DIN/ISO DIN 934 / ISO 4032/8673 Qty 20 pcs		
For models:	AIC0037-F, AIC0038-F, AIC0039-F, AIC0040-F, AIC0041-F, AIC0042-F, AIC0043-F, AIC0044-F, AIC0045-F, AIC0046-F, AIC0071-F, AIC0072-F, AIC0073-F, AIC0074-F, AIC0075-F, AIC0076-F, AIC0077-F, AIC0078-F, AIC0079-F, AIC0080-F		

washers



1

Part No.	560111	Ref. No.	12009987
description	plain washer ID ø 4.3mm ED ø 9mm thickness 0.8mm SS Qty 20 pcs DIN 125A for thread M4		
For models:	AIC0037-F, AIC0038-F, AIC0039-F, AIC0040-F, AIC0041-F, AIC0042-F, AIC0043-F, AIC0044-F, AIC0045-F, AIC0046-F, AIC0071-F, AIC0072-F, AIC0073-F, AIC0074-F, AIC0075-F, AIC0076-F, AIC0077-F, AIC0078-F, AIC0079-F, AIC0080-F		



1

Part No.	560112	Ref. No.	12009944
description	plain washer ID ø 5.3mm ED ø 10mm thickness 1mm SS Qty 20 pcs DIN 125A for thread M5		
For models:	AIC0037-F, AIC0038-F, AIC0039-F, AIC0040-F, AIC0041-F, AIC0042-F, AIC0043-F, AIC0044-F, AIC0045-F, AIC0046-F, AIC0071-F, AIC0072-F, AIC0073-F, AIC0074-F, AIC0075-F, AIC0076-F, AIC0077-F, AIC0078-F, AIC0079-F, AIC0080-F		



1

Part No.	560113	Ref. No.	12009868
description	plain washer ID ø 6.4mm ED ø 12mm thickness 1.6mm SS Qty 20 pcs DIN 125A for thread M6		
For models:	AIC0037-F, AIC0038-F, AIC0039-F, AIC0040-F, AIC0041-F, AIC0042-F, AIC0043-F, AIC0044-F, AIC0045-F, AIC0046-F, AIC0071-F, AIC0072-F, AIC0073-F, AIC0074-F, AIC0075-F, AIC0076-F, AIC0077-F, AIC0078-F, AIC0079-F, AIC0080-F		

tooth lock washers



1

Part No.	560125	Ref. No.	12009928
description	tooth lock washer ID ø 4.2mm ED ø 8mm SS DIN/ISO DIN 6798A Qty 20 pcs for thread M4		
For models:	AIC0037-F, AIC0038-F, AIC0039-F, AIC0040-F, AIC0041-F, AIC0042-F, AIC0043-F, AIC0044-F, AIC0045-F, AIC0046-F, AIC0071-F, AIC0072-F, AIC0073-F, AIC0074-F, AIC0075-F, AIC0076-F, AIC0077-F, AIC0079-F, AIC0080-F		



ring nuts



1

Part No.	550662	Ref. No.	256.377.00
-----------------	--------	-----------------	------------

description	ring nut thread M54x1.5 H 7mm
--------------------	-------------------------------

For models:	VS7040FRE17X, VS7040FRE88, VS7080FRE17X, VS9040FRE17, VS-9040FRE21, VS9040FRE88, VS9080FRE17, VS9080FRE21
--------------------	---

accessories for	550662
------------------------	--------

Part No.	550449	Ref. No.	—
-----------------	--------	-----------------	---



special wrench for ring nut

sealing washers

fibre gaskets

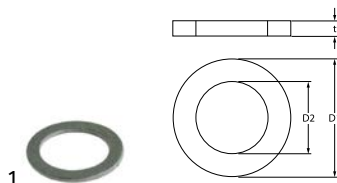

1

Part No.	510404	Ref. No.	953.031.00
-----------------	--------	-----------------	------------

description	flat gasket fibre ED ϕ 44mm ID ϕ 34mm thickness 2mm Qty 1 pcs
--------------------	---

For models:	VS7080PEI50, VS7080PGI50, VS9080PEI150, VS9080PGI150
--------------------	--

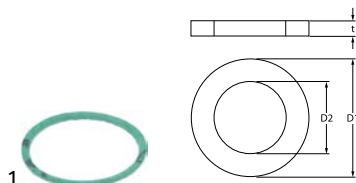

1

Part No.	529484	Ref. No.	953.030.00
-----------------	--------	-----------------	------------

description	flat gasket fibre ED ϕ 58mm ID ϕ 50mm thickness 2mm Qty 1 pcs
--------------------	---

For models:	VS9080PEI150, VS9080PGI150
--------------------	----------------------------

O-rings

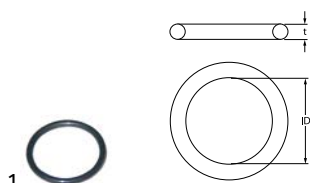

1

Part No.	510072	Ref. No.	456016
-----------------	--------	-----------------	--------

description	O-ring EPDM thickness 3.53mm ID ϕ 32.93mm Qty 1 pcs
--------------------	--

For models:	GLB0041, GLB0042
--------------------	------------------



1

Part No.	510408	Ref. No.	456002
-----------------	--------	-----------------	--------

description	O-ring EPDM thickness 5.34mm ID ϕ 47mm Qty 1 pcs
--------------------	---

For models:	GLB0040, GLB0041, GLB0042, GLB0043C, GLB0043C-60Hz, GLB0044C
--------------------	--

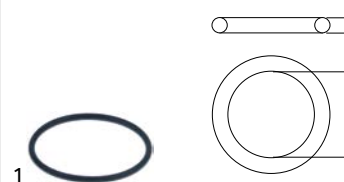

1

Part No.	510243	Ref. No.	653.018.00
-----------------	--------	-----------------	------------

description	O-ring Viton thickness 3.53mm ID ϕ 55.56mm Qty 1 pcs
--------------------	---

For models:	VS7040FRE17X, VS7040FRE88, VS7080FRE17X, VS9040FRE17, VS-9040FRE21, VS9040FRE88, VS9080FRE17, VS9080FRE21
--------------------	---

flange gaskets



1

Part No.	550069	Ref. No.	12023679
-----------------	--------	-----------------	----------

description	gasket L 210mm W 46mm D1 ϕ 12mm D2 ϕ 7mm graphite thickness 2mm for heating element
--------------------	---

For models:	AIC0041-F, AIC0045-F, AIC0073-F, AIC0075-F
--------------------	--



1

Part No.	550994	Ref. No.	12023680
-----------------	--------	-----------------	----------

description	gasket L 105mm W 60mm thickness 3mm for heating element
--------------------	---

For models:	AIC0037-F, AIC0039-F, AIC0041-F, AIC0043-F, AIC0045-F
--------------------	---

spring clips



1

Part No.	550419	Ref. No.	238.003.00
-----------------	--------	-----------------	------------

description	probe clip for pipe ϕ 8.5mm for probe ϕ 6mm Qty 1 pcs
--------------------	---

For models:	VS7040FRE10, VS7080FRE10, VS9040FRE15, VS9080FRE15
--------------------	--



protection caps

			
1			
Part No.	510093	Ref. No.	467002 69870
description	protection cap		
For models:	GLB0040, GLB0041, GLB0042, GLB0043C, GLB0043C-60Hz, GLB0044C, GLB0045, GLB0047, GLB0048, GLB0049, GLB0050, GLB0051		

			
1			
Part No.	520876	Ref. No.	463007
description	protection cap for heating element ø 11.5mm H 32mm W 25mm plastic		
For models:	GLB0041, GLB0042		

			
1			
Part No.	692776	Ref. No.	983.009.00
description	support bracket for heating element		
For models:	VS9040FRE15, VS9080FRE15		

hot plates

square & rectangular

with radiused edge

			
1			
Part No.	490212	Ref. No.	965.063.00
description	hot plate dimensions 300x300mm 3500W 230V with spill ring connection 4 screw clamps protector yes square		
For models:	VS7040PCEQT, VS7040PCET, VS7080PCEQT, VS7080PCET, VS9040PCEST, VS9080CFES, VS9080PCEST		

round

with radiused edge

for domestic and commercial kitchens

			
1			
Part No.	490020	Ref. No.	665.006.00
description	hot plate ø 220mm 2600W 230V connection 4 screw clamps with 8mm spill ring		
For models:	VS7040PCEQT, VS7040PCET, VS7080CFE, VS7080PCEQT, VS7080PCEST		
accessories for	490020		
	Part No.	550796	Ref. No. —
fixing plate for hot plate ø220mm			

energy regulators

EGO

1-circuit

			
1			
Part No.	380015	Ref. No.	661.058.00
description	energy regulator 230V 13A single-circuit turn direction right shaft ø 6x4.6mm shaft L 23mm mounting thread M4 power release 6-100% no. 50.57021.010		
For models:	VS7080PEI50, VS7080PG50, VS7080PGI50, VS9080PEI150, VS9080PGI150		



2-circuit

			
1			
Part No.	380027	Ref. No.	661.102.00
description	energy regulator EGO 230V 13A dual circuit turn direction right shaft ø 6x4.6mm shaft L 23mm mounting thread M4 power release 6-70% no. 50.55021.100		
For models:	VS7080CFVE, VS7080PVET, VS9040PVET, VS9080CFVE, VS9080PVET		

thermostats

bi-metal thermostats

safety bi-metal thermostats

			
1			
Part No.	390233	Ref. No.	926189
description	bi-metal safety thermostat hole distance 24mm switch-off temp. 110°C 1NC 1-pole 16A connection F6.3 2 hole fixing without holder		
For models:	GLB0040, GLB0041, GLB0042, GLB0043C, GLB0043C-60Hz, GLB0044C, GLB0045, GLB0047, GLB0048, GLB0049, GLB0050, GLB0051		
accessories for	390233		
	Part No.	504736	Ref. No. —
bracket for contact thermostat			
	Part No.	550388	Ref. No. —
bracket for contact thermostat mounting distance 24.5mm mounting ø 3.8			



control and safety thermostats

EGO

control thermostats

55.10/19_ series

E-G-O



Part No.	375001	Ref. No.	661.004.00
description	thermostat t.max. 112°C temperature range 30-110°C 1-pole 1NO 16A probe ø 6mm probe L 130mm capillary pipe 900mm capillary pipe isolated 960mm gland nut M9x1 shaft L 23mm shaft position upper rotation 270°		
For models:	VS7040BMET, VS7040BMFEP, VS9040BMET, VS9040BMFEP		

E-G-O



Part No.	375548	Ref. No.	961.039.00
description	thermostat t.max. 142°C temperature range fixed 142°C 1-pole 1CO 16A probe ø 4mm probe L 157mm capillary pipe 870mm capillary pipe isolated 870mm gland nut shaft ø 6x4.6mm shaft Lmm shaft position		
For models:	VS7080PEI50, VS7080PGI50, VS9080PEI150, VS9080PGI150		

E-G-O



Part No.	375945	Ref. No.	661.121.00
description	thermostat t.max. 470°C temperature range 90-470°C 1-pole 1NO 16A probe ø 3.9mm probe L 163mm capillary pipe 870mm capillary pipe isolated 600mm shaft ø 4.5x6mm shaft L 23mm shaft position upper rotation 270°		
For models:	VS7080TPET, VS7080TPFE, VS9080TPET, VS9080TPFE		

55.13_ series

E-G-O



Part No.	375492	Ref. No.	961.034.00
description	thermostat t.max. 190°C temperature range 94-190°C 1-pole 1NO 16A probe ø 6mm probe L 94mm capillary pipe 1090mm capillary pipe isolated 960mm gland nut M10x1 shaft ø 6x4.6mm shaft L 23mm shaft position upper rotation 310° probe material SS		
For models:	VS7040FRE17X, VS7040FRE88, VS7040FRG17VL, VS7080FRE17X, VS7080FRG17VL, VS9040FRE17, VS9040FRE21, VS9040FRE88, VS9040FRG17VL, VS9040FRG21VL, VS9080FRE17, VS9080FRE21, VS9080FRG17VL, VS9080FRG21VL		

55.34_ series

E-G-O



Part No.	375143	Ref. No.	661.005.00
description	thermostat t.max. 110°C temperature range 32-110°C 3-pole 3NO 16A probe ø 6mm probe L 138mm capillary pipe 1480mm capillary pipe isolated 1100mm gland nut M9x1 shaft ø 6x4.6mm shaft L 23mm shaft position upper rotation 270°		
For models:	VS7080BMET, VS7080BMFEP, VS9080BMET, VS9080BMFEP		

E-G-O



Part No.	375097	Ref. No.	661.041.00
description	thermostat t.max. 195°C temperature range 95-195°C 3-pole 3NO 16A probe ø 6mm probe L 117mm capillary pipe 1780mm capillary pipe isolated 1400mm gland nut M9x1 shaft ø 6x4.6mm shaft L 23mm shaft position upper rotation 270°		
For models:	VS7040FRE10, VS7080FRE10, VS9040FRE15, VS9080FRE15		



Part No.	375559	Ref. No.	661.123.00
description	thermostat t.max. 230°C temperature range 95-230°C 3-pole 3NO 16A probe ø 4mm probe L 128mm capillary pipe 1250mm capillary pipe isolated 1000mm gland nut shaft ø 6x4.6mm shaft L 23mm shaft position upper rotation 270°		
For models:	VS7040GRACQE, VS7080GRACQE, VS9040GRACQE, VS9080GRACQE		



Part No.	375944	Ref. No.	661.116.00
description	thermostat t.max. 350°C temperature range 100-350°C 3-pole 3NOA probe ø 3mm probe L 147mm capillary pipe 900mm capillary pipe isolatedmm gland nut shaft ø 6x4.6mm shaft L 26mm shaft position upper rotation 270° probe material SS		
For models:	V080FTREVCRT, V7040FTREVCRT, V9040FTREVCRT, V9080FTREVCRT, V9080FTRRECRT, VS7040FTET, VS7040FTEVCRT, VS7040FTEVT, VS7040FTRET, VS7040FTREVT, VS7080FTET, VS7080FTEVCRT, VS7080FTEVT, VS7080FTRET, VS7080FTREVT, VS7080FTRRET, VS7080FTRREVC, VS7080FTRREVT, VS9040FTECRT, VS9040FTET, VS9040FTEVCRT, VS9040FTEVT, VS9040FTRECRT, VS9040FTRET, VS9040FTREVT, VS9080FTECRT, VS9080FTET, VS9080FTEVCRT, VS9080FTEVT, VS9080FTRECRT, VS9080FTRET, VS9080FTREVT, VS9080FTRRET, VS9080FTRREVC, VS9080FTRREVT		

55.32_ series



Part No.	375316	Ref. No.	661.051.00
description	safety thermostat switch-off temp. 140°C 3-pole 20A probe ø 6mm probe L 173mm capillary pipe 830mm capillary pipe isolated 800mm gland nut probe SS		
For models:	VS7040BMET, VS7040BMFEP, VS7040CPES, VS7080BMET, VS7080BMFEP, VS7080CPES, VS9040BMET, VS9040BMFEP, VS9040CPES, VS9080BMET, VS9080BMFEP, VS9080CPES		



Part No.	375375	Ref. No.	961.033.00
description	safety thermostat switch-off temp. 230°C 3-pole 20A probe ø 6mm probe L 94mm capillary pipe 900mm capillary pipe isolated 670mm gland nut M10x1 probe SS		
For models:	VS7040FRE17X, VS7040FRE88, VS7080FRE17X, VS9040FRE17, VS-9040FRE21, VS9040FRE88, VS9080FRE17, VS9080FRE21		

safety thermostats

55.13_ series



Part No.	375441	Ref. No.	12024591
description	safety thermostat switch-off temp. 360°C 1-pole 1NC 16A probe ø 3mm probe L 110mm capillary pipe 870mm capillary pipe isolated 700mm gland nut probe screw connection M8x1		
For models:	AIC0037-F, AIC0038-F, AIC0039-F, AIC0040-F, AIC0041-F, AIC0042-F, AIC0043-F, AIC0044-F, AIC0045-F, AIC0046-F, AIC0071-F, AIC0072-F, AIC0073-F, AIC0074-F, AIC0075-F, AIC0076-F, AIC0077-F, AIC0078-F, AIC0079-F, AIC0080-F		



Part No.	375445	Ref. No.	961.044.00
description	safety thermostat switch-off temp. 230°C 3-pole 2x20/1x0.5A probe ø 4mm probe L 120mm capillary pipe 900mm capillary pipe isolated 700mm gland nut probe		
For models:	VS7040FRGS13, VS7080FRGS13, VS9040FRGS13, VS9040FRGS20, VS9080FRGS13, VS9080FRGS20		



1 

Part No.	375312	Ref. No.	661.048.00
description	safety thermostat switch-off temp. 245°C 3-pole 3NC 20A probe ø 4mm probe L 120mm capillary pipe 1800mm capillary pipe isolated 1800mm gland nut probe SS		
For models:	VS7040FRE10, VS7080FRE10, VS9040FRE15, VS9080FRE15		
accessories for	375312		
	Part No.	550981	Ref. No. —
	probe clip for pipe ø 8.5mm for probe ø 6mm for heating elements spacing 0.4mm Qty 1 pcs		



1 

Part No.	375187	Ref. No.	661.115.00
description	safety thermostat switch-off temp. 360°C 3-pole 3NC 2x20/1x0.5A probe ø 6mm probe L 79mm capillary pipe 890mm capillary pipe isolatedmm gland nut probe SS		
For models:	V080FTREVCRT, V7040FTREVCRT, V9040FTREVCRT, V9080FTREVCRT, V9080FTRRRCRT, VS70120CFGE, VS7040FTET, VS7040FTEVCRT, VS-7040FTEVT, VS7040FTRET, VS7040FTREVT, VS7080BREI, VS7080BREIM, VS7080BRGI, VS7080BRGIM, VS7080CFE, VS7080CFEQ, VS7080CFGE, VS7080CFVE, VS7080FTET, VS7080FTEVCRT, VS7080FTEVT, VS7080FTRET, VS7080FTREVT, VS7080FTRRRET, VS7080FTRRREV, VS7080FTRRV, VS7080PG50, VS7080TPFE, VS90120CFGE, VS90160CFGE, VS9040FTECRT, VS9040FTET, VS9040FTEVCRT, VS9040FTEVT, VS9040FTRECRT, VS9040FTRET, VS9040FTREVT, VS9080BREI, VS9080BREIM, VS9080BRGI, VS9080BRGIM, VS9080CFES, VS9080CFGE, VS9080CFVE, VS9080FTECRT, VS9080FTET, VS9080FTEVCRT, VS9080FTEVT, VS-9080FTRECRT...(Other models you can see in the webshop)		

56._ series



1 

Part No.	375447	Ref. No.	12024884
description	safety thermostat switch-off temp. 150°C 1-pole 1CO 16A probe ø 6mm probe L 77mm capillary pipe 1460mm capillary pipe isolated 1100mm gland nut M9x1 starting temperature 139°C probe		
For models:	AIC0037-F, AIC0038-F, AIC0039-F, AIC0040-F, AIC0041-F, AIC0042-F, AIC0043-F, AIC0044-F, AIC0045-F, AIC0046-F		



1 

Part No.	375783	Ref. No.	961.035.00
description	safety thermostat switch-off temp. 240°C 1-pole 0.5A probe ø 6mm probe L 77mm capillary pipe 860mm capillary pipe isolated 750mm gland nut M10x1 probe SS		
For models:	VS7040FRG17VL, VS7080FRG17VL, VS9040FRG17VL, VS9040FRG21VL, VS9080FRG17VL, VS9080FRG21VL		

control thermostats with operation switch

55.13_ series



1 

Part No.	375073	Ref. No.	961.045.00
description	thermostat t.max. 320°C temperature range 50-320°C 1-pole capillary pipe isolatedmm gland nut		
For models:	VS7080BREI, VS7080BREIM, VS7080BRGI, VS7080BRGIM, VS9080BREI, VS9080BREIM, VS9080BRGI, VS9080BRGIM		

IMIT / TEMPOMATIC / ARTHERMO

safety thermostats



1 

Part No.	390770	Ref. No.	927057
description	safety thermostat switch-off temp. 90-110°C 1-pole 1CO 16/0.5A probe ø 6.5mm probe L 90mm capillary pipe 2000mm capillary pipe isolated 1950mm gland nut probe		
For models:	GLB0047, GLB0048, GLB0049		



TECASA			
safety thermostats			
 <p>1</p>			
Part No.	390452	Ref. No.	12023830
description	safety thermostat switch-off temp. 125°C 1-pole 16A probe ø 6mm probe L 73mm capillary pipe 870mm capillary pipe isolated 690mm gland nut M9x1 probe SS		
For models:	GLB0067-F, GLB0069-F, GLB0071-F, GLB0080, GLB0081, GLB0082		

accessories

probe clips

spring clips

for thermostat



 <p>1</p>			
Part No.	550419	Ref. No.	238.003.00
description	probe clip for pipe ø 8.5mm for probe ø 6mm Qty 1 pcs		
For models:	VS7040FRE10, VS7080FRE10, VS9040FRE15, VS9080FRE15		

plunger sockets

 <p>1</p>			
Part No.	513031	Ref. No.	929038
description	thermowell L 125mm SS single		
For models:	GLB0045, GLB0047, GLB0048, GLB0049, GLB0050, GLB0051		

switches and momentary switches



rocker/momentary rocker switches

30x22mm			
 <p>1</p>			
Part No.	301003	Ref. No.	B00DU102
description	rocker switch mounting measurements 30x22mm green 2NO 250V 16A illuminated 0-I connection male faston 6.3mm ambient temperature max. 125/55°C protection IP65		
For models:	BMA0008-F, BMA0010-F, BMA0021-F, BMA0022-F, BMA0024-F, BMA0025-F, BMA0027-F, BMA0028-F, BMA0029-F, BMA0036-F, BMB0030-F, BMB0036-F, BMB0037-F, BMC0014-F, BMC0016-F, BNA0030-F, BNA0031-F, BNA0036-F, BNA0037-F, BNA0044-F, BNA0045-F, BNA0052-F, BNA0053-F, BNA0054-F, BNA0055-F, BNA0056-F, BNA0057-F, BNA0064-F, BNA0065-F, BNA0066-F, BNB0010-F, BNB0011-F, BNB0012-F, BNB0013-F, BNB0014-F, BNB0015-F, BNZ0001-F, BNZ0002-F, BNZ0003-F, BNZ0004-F, BNZ0005-F, BNZ0006-F, BNZ0007-F, BNZ0008-F, CCZ0036-F, CCZ0037-F, PB9RI-F, VTGB2A-F, VTGB2-F, VTGB3A-F...(Other models you can see in the webshop)		
accessories for	301003		
			
Part No.	301036	Ref. No.	—
description	protective cover internal size 30x22mm for rocker switch mounting measurementsmm		

push/momentary push switches

ø22mm			
 <p>1</p>			
Part No.	348233	Ref. No.	12023927
description	momentary push switch mounting ø 22mm black 1NO/1NC 250V 3A connection F2,8x0,5		
For models:	AIC0037-F, AIC0038-F, AIC0039-F, AIC0040-F, AIC0041-F, AIC0042-F, AIC0043-F, AIC0044-F, AIC0045-F, AIC0046-F		
ø25mm			
 <p>1</p>			
Part No.	348219	Ref. No.	961.048.00
description	momentary push switch mounting ø 25mm black 1NO 250V 16A connection male faston 6.3mm ambient temperature max. 120°C		
For models:	VS7080BREI, VS7080BREIM, VS7080BRGI, VS7080BRGIM, VS9080BREI, VS9080BREIM, VS9080BRGI, VS9080BRGIM		



			
1			
Part No.	345039	Ref. No.	961.049.00
description	protective cover round ED ø 33mm external size 23mm internal size 21mm H 12mm clear mounting ø 25mm		
For models:	VS7080BREI, VS7080BREIM, VS7080BRGI, VS7080BRGIM, VS9080BREI, VS9080BREIM, VS9080BRGI, VS9080BRGIM		
accessories for	345039		
	Part No.	Ref. No.	—
	 momentary push switch mounting ø 25mm yellow 1NO/indicator light 250V 16A cover connection male faston 6.3mm ambient temperature max. 85°C protection IP65		

accessories

gaskets

			
1			
Part No.	551456	Ref. No.	953.020.00
description	gasket for switch ED ø 14mm ID ø 2.5mm thickness 3.5mm white		
For models:	V080FTREVCRT, V7040FTREVCRT, V9040FTREVCRT, V9080FTREVCRT, V9080FTRRECRT, VS70120CFGE, VS7040BMET, VS7040BMFEP, VS7040CPES, VS7040FRE10, VS7040FRE17X, VS7040FRE88, VS7040FRG17VL, VS7040FTET, VS7040FTEVCRT, VS7040FTEVT, VS7040FTRET, VS7040FTREVT, VS7040GRACQE, VS7040PCEQT, VS7040PCET, VS7040SPET, VS7080BMET, VS7080BMFEP, VS7080BREI, VS7080BREIM, VS7080BRGI, VS7080BRGIM, VS7080CFE, VS7080CFEQ, VS7080CFGE, VS7080CFVE, VS7080CPES, VS7080FRE10, VS7080FRE17X, VS7080FRG17VL, VS7080FTET, VS7080FTEVCRT, VS7080FTEVT, VS7080FTRET, VS7080FTREVT, VS7080FTRRET, VS7080FTRREVC, VS7080FTRREVT, VS7080GRACQE, VS7080PCEQT, VS7080PCET, VS7080PEI50, VS7080PG50, VS7080PGI50...(Other models you can see in the webshop)		

microswitches

lever actuated

			
1			
Part No.	345773	Ref. No.	761.004.00
description	microswitch with lever 250V 16A 1CO connection male faston 6.3mm L 60mm ambient temperature max. 125°C mounting distance 22mm actuating force: 65g lever length 51mm		
For models:	VS7040FRE10, VS7040FRE17X, VS7040FRE88, VS7080BREI, VS7080BREIM, VS7080BRGI, VS7080BRGIM, VS7080FRE10, VS-7080FRE17X, VS9040FRE15, VS9040FRE17, VS9040FRE21, VS-9040FRE88, VS9080BREI, VS9080BREIM, VS9080BRGI, VS9080BRGIM, VS9080FRE15, VS9080FRE17, VS9080FRE21		

			
1			
Part No.	345125	Ref. No.	927246
description	microswitch with lever 250V 16A 1CO connection male faston 6.3mm ambient temperature max. 85°C mounting distance 25mm type C99ZP3 actuating force: 25g lever length 63.5mm		
For models:	GLB0045, GLB0047, GLB0048, GLB0049, GLB0050, GLB0051		

roller-lever actuated

microswitches

			
1			
Part No.	345250	Ref. No.	12025193
description	microswitch with handle with a switch 250V 16A 1CO connection male faston 6.3mm L 27mm L1 36mm ambient temperature max. 125°C mounting distance 22mm type RL6-1-FGE-P12-5-L actuating force: 90g		
For models:	AIC0037-F, AIC0038-F, AIC0039-F, AIC0040-F, AIC0041-F, AIC0042-F, AIC0043-F, AIC0044-F, AIC0045-F, AIC0046-F, AIC0071-F, AIC0072-F, AIC0073-F, AIC0074-F, AIC0075-F, AIC0076-F, AIC0077-F, AIC0078-F, AIC0079-F, AIC0080-F		

with push button

switches with snap-fit

			
1			
Part No.	348008	Ref. No.	B00DU103
description	microswitch with push button 250V 2.5A 1NO/1NC connection male faston 2.8mm/6.3mm L 27mm L1 22mm ambient temperature max. 104°C actuating force: 180g		
For models:	BMA0008-F, BMA0010-F, BMA0021-F, BMA0022-F, BMA0024-F, BMA0025-F, BMA0026-F, BMA0027-F, BMA0028-F, BMA0029-F, BMA0032-F, BMA0035-F, BMA0036-F, BMB0028-F, BMB0029-F, BMB0030-F, BMB0033-F, BMB0034-F, BMB0035-F, BMB0036-F, BMB0037-F, BMC0012-F, BMC0014-F, BMC0015-F, BMC0016-F, PB9RI-F		

roller actuated

roller 0°

			
1			
Part No.	348145	Ref. No.	91310430
description	microswitch 250V 16A 1CO connection screw thread L 15mm thread M12x1 mounting distance 25.4mm actuating force: 500g type MK V11D15		
For models:	CBC0001, CBC0002, CBC0003, CBC0004		



accessories



Part No.	691077	Ref. No.	12009985
description	insulation L 45mm for microswitch W 30mm thickness 1mm		
For models:	AIC0037-F, AIC0038-F, AIC0039-F, AIC0040-F, AIC0041-F, AIC0042-F, AIC0043-F, AIC0044-F, AIC0045-F, AIC0046-F, AIC0071-F, AIC0072-F, AIC0073-F, AIC0074-F, AIC0075-F, AIC0076-F, AIC0077-F, AIC0078-F, AIC0079-F, AIC0080-F		



cam switches

7-position



Part No.	300025	Ref. No.	661.002.00
description	cam switch 7 operating positions 1NO/2CO sequence 0-1-2-3-4-5-6 16A shaft ø 6x4.6mm shaft L 23mm connection screw 7-position ceramic		
For models:	VS7040PCEQT, VS7040PCET, VS7080CFE, VS7080CFEQ, VS7080PCEQT, VS7080PCET, VS9080CFES		

accessories for

	Part No.	112172	Ref. No.	—
		knob universal ø 70mm black without adaptor/dial plate		
	Part No.	112213	Ref. No.	—
		knob dial plate silver switch 7-position t.max. °C°C ED ø 63mm ID ø 45.5mm		
	Part No.	112311	Ref. No.	—
		knob adapter shaft ø 6x4.6mm L 0mm with spring		



Part No.	300106	Ref. No.	961.000.00
description	cam switch 7 operating positions 1NO/2CO sequence 0-1-2-3-4-5-6 32A shaft ø 6x4.6mm shaft L 23mm connection screw 7-position shaft flat upper		
For models:	VS9040PCEST, VS9080PCEST		

4 operating positions



Part No.	300010	Ref. No.	661.117.00
description	cam switch 4 operating positions 2NO/2CO sequence 0-1-2-3 16A shaft ø 6x4.6mm shaft L 23mm connection male faston 6.3mm ceramic		
For models:	VS7080PEI50, VS7080PG50, VS7080PGI50, VS9080PEI150, VS9080PGI150		



Part No.	300081	Ref. No.	661.113.00
description	cam switch 4 operating positions 3NO/2CO sequence 0-1-2-3 16A shaft ø 6x4.6mm shaft L 23mm connection screw		
For models:	VS70120CFGE, VS7080CFE, VS7080CFEQ, VS7080CFGE, VS7080CFVE, VS7080TPFE, VS90120CFGE, VS90160CFGE, VS9080CFES, VS9080CFGE, VS9080CFVE, VS9080TPFE		



Part No.	300210	Ref. No.	661.037.00
description	cam switch 4 operating positions 4NO sequence 0-1-2-3 16A shaft ø 6x4.6mm shaft L 23mm connection screw ceramic		
For models:	VS7040CPES, VS7080CPES, VS9040CPES, VS9080CPES		

accessories for	300210
	Part No. 551456 Ref. No. 953.020.00
	gasket for switch ED ø 14mm ID ø 2.5mm thickness 3.5mm white

with potentiometer



Part No.	300252	Ref. No.	961.042.00
description	potentiometer 2 operating positions 2NO sequence 0-1 16A shaft ø 6x4.6mm shaft L 23mm connection coded plug cable length 1420mm 10kOhm 12V with cable and indicator light		
For models:	VS9040INDT, VS9040INDWT, VS9080INDT		



operation switches

E-G-O



1

Part No.	300080	Ref. No.	661.000.00
description	cam switch 2 operating positions 4NO 16A sequence 0-1 shaft \varnothing 6x4.6mm shaft L 23mm connection screw operation switch ceramic ambient temperature max. 150°C		
For models:	V080FTREVCRT, V7040FTREVCRT, V9040FTREVCRT, V9080FTREVCRT, V9080FTRRRCRT, VS7040BMET, VS7040BMFEP, VS7040FRE10, VS-7040FTEV, VS7040FTEVCRT, VS7040FTEVT, VS7040FTRET, VS7040FTREVT, VS7040GRACQE, VS7040SPET, VS7080BMET, VS7080BMFEP, VS7080FRE10, VS7080FTET, VS7080FTEVCRT, VS7080FTEVT, VS7080FTRET, VS7080FTREVT, VS7080FTRRRET, VS7080FTRRREVC, VS7080FTRRREVT, VS7080GRACQE, VS9040BMET, VS9040BMFEP, VS9040FRE15, VS9040FTECART, VS9040FTET, VS9040FTEVCRT, VS9040FTEVT, VS9040FTRETCRT, VS9040FTRET, VS9040FTREVT, VS9040GRACQE, VS-9040SPET, VS9080BMET, VS9080BMFEP, VS9080FRE15, VS9080FTECART, VS9080FTET, VS9080FTEVCRT, VS9080FTEVT, VS9080FTRETCRT, VS9080FTRET, VS9080FTREVT, VS9080FTRRRET...(Other models you can see in the webshop)		
accessories for	300080		
	Part No.	551456	Ref. No. 953.020.00
	gasket for switch ED \varnothing 14mm ID \varnothing 2.5mm thickness 3.5mm white		

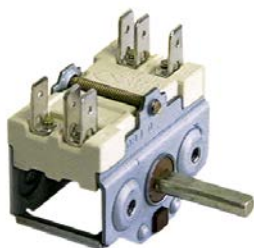

1

Part No.	300001	Ref. No.	661.093.00
description	cam switch operation switch 16A sequence 0-1 shaft \varnothing 6x4.6mm connection male faston 6.3mm 2-pole		
For models:	VS7040FRE17X, VS7040FRE88, VS7040FRG17VL, VS7080FRE17X, VS7080FRG17VL, VS7080TPET, VS7080TPFE, VS9040FRE17, VS9040FRE21, VS9040FRE88, VS9040FRG17VL, VS9040FRG21VL, VS9080FRE17, VS9080FRE21, VS9080FRG17VL, VS9080FRG21VL, VS9080TPET, VS9080TPFE		
accessories for	300001		
	Part No.	551456	Ref. No. 953.020.00
	gasket for switch ED \varnothing 14mm ID \varnothing 2.5mm thickness 3.5mm white		

magnetic switches

36x13mm



1

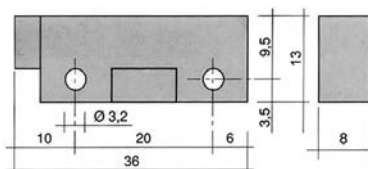

Part No.	345118 ¹	Ref. No.	211002 211002AG 80871
description	magnetic switch L 36mm W 13mm 1NO 250V 1A P max. 50W connection cable cable length 980mm		
For models:	GLB0040, GLB0041, GLB0043C, GLB0043C-60Hz, GLB0044C, GLB0045, GLB0047, GLB0048, GLB0049, GLB0050, GLB0051		
accessories for	345118		
	Part No.	345399	Ref. No. 927088 CWM7
	magnet \varnothing 3.3mm L 40mm H 8mm W 13mm hole distance 30mm M3		

¹with coded connector

65x20mm



1

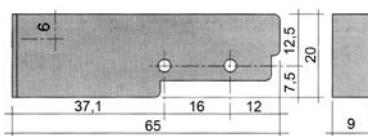

Part No.	345116	Ref. No.	12024560 927017
description	magnetic switch L 65mm W 20mm 1NO 250V 0.4A P max. 100W connection cable cable length 3000mm		
For models:	AIC0037-F, AIC0038-F, AIC0039-F, AIC0040-F, AIC0041-F, AIC0042-F, AIC0043-F, AIC0044-F, AIC0045-F, AIC0046-F, AIC0071-F, AIC0072-F, AIC0073-F, AIC0074-F, AIC0075-F, AIC0076-F, AIC0077-F, AIC0078-F, AIC0079-F, AIC0080-F, GLB0041, GLB0042, GLB0045, GLB0047, GLB0048		
accessories for	345116		
	Part No.	345399	Ref. No. 927088 CWM7
	magnet \varnothing 3.3mm L 40mm H 8mm W 13mm hole distance 30mm M3		



∅ 6mm



1

Part No.	345202	Ref. No.	12024477
description	magnetic switch 250V 0.04A P max. 10W probe L 29mm 1NO connection plug cable length 1400mm		
For models:	BKZ0008-F, BKZ0022-F, BKZ0023-F, BKZ0027-F, BKZ0028-F, BKZ0040, BKZ0041, GLB0067-F, GLB0069-F, GLB0071-F, GLB0080, GLB0081, GLB0082		

accessories

magnets

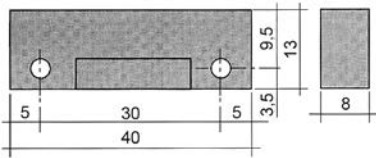
1

Part No.	345399	Ref. No.	927088 CWM7
description	magnet ∅ 3.3mm L 40mm H 8mm W 13mm hole distance 30mm M3		
For models:	GLB0045, GLB0047, GLB0048, GLB0049, GLB0050, GLB0051		

1

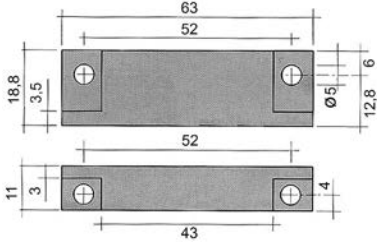
Part No.	345336	Ref. No.	926014
description	magnet ∅ 4.8mm L 63mm H 11mm W 18.8mm hole distance 51mm M4		
For models:	GLB0045, GLB0047, GLB0048, GLB0049, GLB0050, GLB0051		



1

Part No.	505004	Ref. No.	12024303
description	magnet ∅mm L 17mm H 12mm W 14mm		
For models:	AIC0037-F, AIC0038-F, AIC0039-F, AIC0040-F, AIC0041-F, AIC0042-F, AIC0071-F, AIC0072-F, AIC0073-F, AIC0076-F, AIC0077-F, AIC0078-F		

control equipment

LOVATO



1

Part No.	301321	Ref. No.	961.051.00
description	contact block LOVATO LPX C10 1NO max 690V 10A light grey		
For models:	VS7080BREIM, VS7080BRGIM, VS9080BREIM, VS9080BRGIM		

plastic series

rotary switches



1

Part No.	301320	Ref. No.	961.050.00
description	rotary selector mounting measurements ∅22mm black/silver sequence 1-0-2 latching		
For models:	VS7080BREIM, VS7080BRGIM, VS9080BREIM, VS9080BRGIM		

encoders and potentiometers



1

Part No.	300252	Ref. No.	961.042.00
description	potentiometer 2 operating positions 2NO sequence 0-1 16A shaft ∅ 6x4.6mm shaft L 23mm connection coded plug cable length 1420mm 10kOhm 12V with cable and indicator light		
For models:	VS9040INDT, VS9040INDWT, VS9080INDT		

lamps

indicator lights

indicator lamps for socket type SA / SC / SD / SF / SR



1

Part No.	360736	Ref. No.	663.082.00
description	indicator light 250V red connection 2-wire cable length 800mm cable material silicone		
For models:	VS7080CFVE, VS7080PVET, VS9040PVET, VS9080CFVE, VS9080PVET		



indicator lights (complete)

ø 8mm



1

Part No.	360742	Ref. No.	963.016.00
description	indicator light ø 8mm green 28V connection male faston 2.8mm		
For models:	VS9040INDT, VS9040INDWT, VS9080INDT		

ø12mm

with screw socket



1

Part No.	360763	Ref. No.	963.014.00
description	indicator light ø 12mm red 230V connection male faston 6.3mm with O-ring		
For models:	VS7080PEI50, VS7080PGI50, VS7080TPET, VS7080TPFE, VS9080PEI150, VS9080PGI150, VS9080TPET, VS9080TPFE		

ø13mm

with screw socket



1

Part No.	359146	Ref. No.	963.013.00
description	indicator light ø 13mm 230V yellow		
For models:	V080FTREVCRT, V7040FTREVCRT, V9040FTREVCRT, V9080FTREVCRT, V9080FTRRECRT, VS70120CFGE, VS7040BMET, VS7040BMFEP, VS7040CPES, VS7040FRE10, VS7040FRE17X, VS7040FRE88, VS7040FRG17VL, VS7040FTET, VS7040FTEVCRT, VS7040FTEVT, VS7040FTRET, VS7040FTREVT, VS7040GRACQE, VS7040PCEQT, VS7040PCET, VS7040SPET, VS7080BMET, VS7080BMFEP, VS7080BREI, VS7080BREIM, VS7080BRGI, VS7080BRGIM, VS7080CFE, VS7080CFEQ, VS7080CFGE, VS7080CFVE, VS7080CPES, VS7080FRE10, VS7080FRE17X, VS7080FRG17VL, VS7080FTET, VS7080FTEVCRT, VS7080FTEVT, VS7080FTRET, VS7080FTREVT, VS7080FTRRET, VS7080FTRREVC, VS7080FTRREVT, VS7080GRACQE, VS7080PCEQT, VS7080PCET, VS7080PEI50, VS7080PG50, VS7080PGI50...(Other models you can see in the webshop)		
accessories for	359146		
	Part No.	510302	Ref. No. —
	Part No.	511505	Ref. No. —

30x22mm



1

Part No.	301303	Ref. No.	B00DU101
description	indicator lamp mounting measurements 30x22mm red indicator light 250V 16A connection male faston 6.3mm ambient temperature max. 125°C protection IP40		
For models:	BMA0008-F, BMA0010-F, BMA0021-F, BMA0022-F, BMA0024-F, BMA0025-F, BMA0027-F, BMA0028-F, BMA0029-F, BMA0036-F, BMB0030-F, BMB0036-F, BMB0037-F, BMC0014-F, BMC0016-F, BNA0036-F, BNA0037-F, BNA0045-F, BNA0052-F, BNA0053-F, BNA0054-F, BNA0055-F, BNA0056-F, BNA0057-F, BNA0064-F, BNA0065-F, BNA0066-F, BNB0010-F, BNB0011-F, BNB0012-F, BNB0013-F, BNB0014-F, BNB0015-F, BNZ0004-F, BNZ0006-F, BNZ0007-F, BNZ0008-F, PB9RI-F, VTGB2-F, VTGB3-F, VTGB4A-F, VTGB4-F		

LED

indicator lamps

mounting diameter 8mm



1

Part No.	360744	Ref. No.	963.015.00
description	indicator light LED mounting ø 8mm red 5-28VDC connection F2.8x0.8 mounting thread M8		
For models:	VS9040INDT, VS9040INDWT, VS9080INDT		

LED bars



1

Part No.	357216	Ref. No.	B00LA370
description	LED bar L 1200mm W 20mm H 20mm aluminium cable length 1000mm		
For models:	BNA0065-F		



1

Part No.	357217	Ref. No.	B00LA470
description	LED bar L 1600mm W 20mm H 20mm aluminium cable length 750mm		
For models:	BNA0066-F		

1

Part No.	357215	Ref. No.	B00LA700
description	LED bar L 500mm W 19mm H 7mm aluminium cable length 900mm		
For models:	BMB0035-F, BMB0037-F		



1

Part No.	357214	Ref. No.	B00LA270
description	LED bar L 690mm W 20mm H 20mm aluminium cable length 850mm		
For models:	BNA0064-F		

screw-on/push-on fit

halogen lamp

for socket G4 / G6.35 / G9



1

Part No.	359596	Ref. No.	12025123
description	halogen lamp socket G4 12V 10W temp.-resist. 500°C		
For models:	AIC0037-F, AIC0038-F, AIC0039-F, AIC0040-F, AIC0041-F, AIC0042-F, AIC0043-F, AIC0044-F, AIC0045-F, AIC0046-F, AIC0071-F, AIC0072-F, AIC0073-F, AIC0074-F, AIC0075-F, AIC0076-F, AIC0077-F, AIC0078-F, AIC0079-F, AIC0080-F		

oven lamps

lamps

halogen lamps

for socket G4 / G6.35 / G9



1

Part No.	359596	Ref. No.	12025123
description	halogen lamp socket G4 12V 10W temp.-resist. 500°C		
For models:	AIC0037-F, AIC0038-F, AIC0039-F, AIC0040-F, AIC0041-F, AIC0042-F, AIC0043-F, AIC0044-F, AIC0045-F, AIC0046-F, AIC0071-F, AIC0072-F, AIC0073-F, AIC0074-F, AIC0075-F, AIC0076-F, AIC0077-F, AIC0078-F, AIC0079-F, AIC0080-F		

contactors

GENERAL ELECTRIC (AEG)

power contactors



1

Part No.	380237	Ref. No.	12024011
description	power contactor resistive load 16A 230VAC (AC3/400V) 6A/3kW main contacts 3NO auxiliary contacts 1NC connection male faston 6.3mm type AEG LS0701F		
For models:	AIC0037-F, AIC0038-F, AIC0039-F, AIC0040-F, AIC0041-F, AIC0042-F, AIC0043-F, AIC0044-F, AIC0045-F, AIC0046-F, AIC0071-F, AIC0072-F, AIC0073-F, AIC0074-F, AIC0075-F, AIC0076-F, AIC0077-F, AIC0078-F, AIC0079-F, AIC0080-F, GLB0067-F, GLB0069-F, GLB0071-F, GLB0080, GLB0081, GLB0082		



1

Part No.	380239	Ref. No.	926040
description	power contactor resistive load 20A 230VAC (AC3/400V) 8.4A/4kW main contacts 3NO auxiliary contacts 1NC connection screw connection type LS05 01A type AEG LS05 01A type GE MC1A 301A		
For models:	GLB0047, GLB0048, GLB0050, GLB0051		



1

Part No.	381191	Ref. No.	926282 DTC112NO
description	power contactor resistive load 25A 400VAC (AC3/400V) 12A/5.5kW main contacts 3NO auxiliary contacts 1NO connection screw connection type AEG type GE CL01A310T6		
For models:	GLB0041, GLB0042, GLB0044C		



ISKRA (FANAL)

power contactors



1

Part No.	380547	Ref. No.	461.021.00
description	power contactor resistive load 20A 230VAC (AC3/400V) 5A/2.2kW main contacts 3NO auxiliary contacts 1NC connection screw connection type Fanal DSL3 01 type ISKRA K03M 01		
For models:	VS7040FRE10, VS7040FRE17X, VS7040FRE88, VS7080BREI, VS-7080BREIM, VS7080FRE10, VS7080FRE17X, VS7080PEI50, VS-9040FRE15, VS9040FRE17, VS9040FRE88, VS9080FRE15, VS9080FRE17		

LOVATO

power contactors



1

Part No.	380714	Ref. No.	91310136
description	power contactor resistive load 25A 230VAC (AC3/400V) 9A/4.2kW main contacts 3NO auxiliary contacts 1NO connection screw connection type BF0910A230		
For models:	CBC0001, CBC0002, CBC0003, CBC0004		



1

Part No.	380716	Ref. No.	961.002.00
description	power contactor resistive load 28A 230VAC (AC3/400V) 12A/5.7kW main contacts 3NO auxiliary contacts 1NO connection screw connection type BF1210A230		
For models:	VS7040FRE17X, VS7080FRE17X, VS9040FRE17, VS9080BREI, VS-9080BREIM, VS9080FRE17		

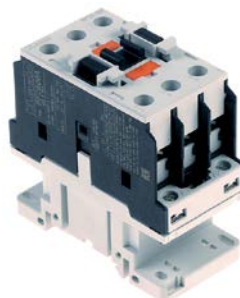

1

Part No.	380721	Ref. No.	961.043.00
description	power contactor resistive load 45A 230VAC (AC3/400V) 26A/13kW main contacts 3NO auxiliary contacts connection screw connection type BF2600A230		
For models:	VS9080PEI150		

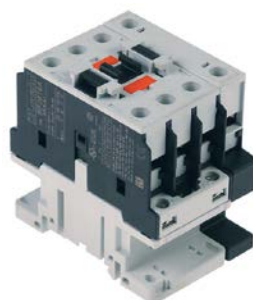

1

Part No.	380787	Ref. No.	961.005.00
description	power contactor resistive load 45A 230VAC (AC3/400V) 26A/13kW main contacts 4NO connection screw connection type BF26T4A230		
For models:	VS7040FRE17X, VS7080FRE17X, VS9040FRE17, VS9040FRE21, VS-9080FRE17, VS9080FRE21		

SIEMENS

power contactors



1

Part No.	381387	Ref. No.	73350
description	power contactor resistive load 22A 230VAC (AC3/400V) 4kW main contacts 3NO auxiliary contacts 1NO connection screw connection type 3RT2016-1AP01		
For models:	GLB0041, GLB0043C-60Hz, GLB0047		

1

Part No.	380614	Ref. No.	12024040
description	power contactor resistive load 22A 230VAC (AC3/400V) 9A/4kW main contacts 3NO auxiliary contacts 1NO connection elastic terminals type 3RT2016-2AP01		
For models:	AIC0037-F, AIC0039-F, AIC0071-F, AIC0072-F, GLB0071-F, GLB0080, GLB0082		



1

Part No.	380390	Ref. No.	80351
description	power contactor resistive load 40A 230VAC (AC3/400V) 12A/5.5kW main contacts 3NO auxiliary contacts connection screw connection type 3RT10-24-1AL20 50/60Hz		
For models:	GLB0045, GLB0047, GLB0048		



1

Part No.	380389	Ref. No.	229037
description	power contactor resistive load 22A 230VAC (AC3/400V) 9A/4kW main contacts 3NO auxiliary contacts 1NO connection screw connection type 3RT10-16-1AP01		
For models:	GLB0040, GLB0041, GLB0042, GLB0043C, GLB0044C		



1

Part No.	381543	Ref. No.	12041014
description	power contactor resistive load 40A 230VAC (AC3/400V) 5.5kW main contacts 3NO auxiliary contacts 1NO/1NC connection plug-in connection type 3RT2024-2AL20		
For models:	AIC0041-F, AIC0043-F, AIC0073-F, AIC0074-F		



1

Part No.	380957	Ref. No.	927160
description	power contactor resistive load 22A 24VAC (AC3/400V) 12A/5.5kW main contacts 3NO auxiliary contacts 1NO connection screw connection type 3RT10-17-1AB01 50/60Hz		
For models:	GLB0049, GLB0050, GLB0051		

small relay switches



1

Part No.	380696	Ref. No.	12024012
description	small relay switch 230V (AC3/400V) 9A/4kW main contacts 3NO auxiliary contacts 1NC connection male faston 6.3mm resistive load 16A		
For models:	GLB0071-F		



1

Part No.	381393	Ref. No.	73351
description	power contactor resistive load 40A 230VAC (AC3/400V) 12A/5.5kW main contacts 3NO auxiliary contacts 1NC/1NO connection screw type 3RT2024-1AL20		
For models:	GLB0043C-60Hz, GLB0047		



motor protection circuit breakers



1

Part No.	380541	Ref. No.	927368 DEI35
description	motor protection circuit breaker type 3RV1011-0JA10 setting range 0.7-1A (AC3/400V) 0.25kW		
For models:	GLB0045, GLB0047, GLB0048, GLB0049, GLB0050, GLB0051		

relays

power relays

with DIN rail mounting

upper



1

Part No.	380809	Ref. No.	12023706 12034668
description	power relays FINDER 230VAC 16A 2NO connection male faston 6.3mm bracket mounting manuf. no. 62.82.8.230.0307		
For models:	BKZ0027-F, BKZ0040, GLB0067-F, GLB0069-F		

lateral



1

Part No.	380313	Ref. No.	229036
description	power relays FINDER 230VAC 16A 3CO connection male faston DIN rail manuf. no. 62.83.8.230.0008		
For models:	GLB0045, GLB0047, GLB0048		

with bracket mounting



1

Part No.	380139	Ref. No.	929115
description	power relays FINDER 230VAC 16A 2CO connection F6.3 bracket mounting dimensions 68x38.2x35.8mm manuf. no. 62.82.8.230.0000		
For models:	GLB0040, GLB0041, GLB0042, GLB0043C, GLB0044C, GLB0047, GLB0048		



1

Part No.	380808	Ref. No.	461.063.00
description	power relays FINDER 230VAC 16A 3CO connection male faston 6.3mm bracket mounting manuf. no. 62.83.8.230.0000		
For models:	VS7080BREIM, VS7080BRGIM, VS9080BREIM, VS9080BRGIM		



1

Part No.	380185	Ref. No.	229029 DER111
description	power relays Italiana Relè 230VAC 30A 1NO connection F6.3 bracket mounting dimensions 36.5x32.2x51.8mm manuf. no. A10-230AC-FA		
For models:	GLB0040, GLB0047, GLB0048		

with male contacts

bullet connectors, 8 contacts



1

Part No.	380951	Ref. No.	961.036.00
description	power relays FINDER 230VAC 10A 2CO connection plug-in connection round 8-pole manuf. no. 60.12.4.101.0040 90.26/ZVE8 250V		
For models:	VS7080PEI50, VS7080PGI50, VS9080PEI150, VS9080PGI150		



relay sockets



1			
Part No.	380638	Ref. No.	961.037.00
description	relay socket 8-pole dimensions 51x41x23mm 250V 10A FINDER manuf. no. 90.26		
For models:	VS7080PEI50, VS7080PGI50, VS9080PEI150, VS9080PGI150		

transformers

open transformers

with clamp terminal



1			
Part No.	400887	Ref. No.	12024173
description	transformer primary 230VAC secondary 12/24VAC 65VA connection screw 50-60Hz		
For models:	AIC0037-F, AIC0038-F, AIC0039-F, AIC0040-F, AIC0041-F, AIC0042-F, AIC0043-F, AIC0044-F, AIC0045-F, AIC0046-F, AIC0071-F, AIC0072-F, AIC0073-F, AIC0074-F, AIC0075-F, AIC0076-F, AIC0077-F, AIC0078-F, AIC0079-F, AIC0080-F		

power supplies



1			
Part No.	378362	Ref. No.	B00LA111
description	power supply primary 100-240VAC secondary 12VDC 50VA secondary 4.2A H 40mm L 130mm W 100mm connection screw 50-60Hz type NES-50-12		
For models:	BMB0037-F, BNA0064-F, BNA0065-F, BNA0066-F		

electronic controllers

DIXELL

refrigeration controllers

accessories



1			
Part No.	381247	Ref. No.	A00DJ108
description	data cable DIXELL		
For models:	BMA0008-F, BMA0010-F, BMA0021-F, BMA0022-F, BMA0024-F, BMA0025-F, BMA0026-F, BMA0027-F, BMA0028-F, BMA0032-F, BMA0035-F, BMA0036-F, BMB0028-F, BMB0029-F, BMB0033-F, BMB0034-F, BNA0030-F, BNA0031-F, BNA0036-F, BNA0037-F, BNA0044-F, BNA0045-F, BNA0056-F, BNZ0001-F, BNZ0002-F, BNZ0003-F, BNZ0004-F, BNZ0005-F, BNZ0006-F, BNZ0007-F, BNZ0008-F, CCZ0036-F, CCZ0037-F, PB9RI-F, VTGB2A-F, VTGB2-F, VTGB3A-F, VTGB3-F, VTGB4A-F, VTGB4-F		
accessories for	381247		
	Part No.	381245	Ref. No. —
	description	display DIXELL DX60 mounting measurements 157x28mm built-in depth 20mmV voltage relay outputs protection IP00°C display 3½ digits	
	Part No.	381246	Ref. No. —
	description	refrigeration controller DIXELL XW60K-5L1CO mounting measurements 140x110mm built-in depth 60mm 230V voltage AC NTC relay outputs 4 NO-20A(8) NO-16A(5) NO-8A(3) NO-16A(5) NTC NTC DI DI yes protection -40 up to 110°C display DX60	

EVCO - EVERY CONTROL

refrigeration controllers

built-in version 2-piece



1			
Part No.	403412	Ref. No.	A00DJ120
description	keypad PCB refrigerated counter BGL2-VT incl. control panel mounting pos. horizontal buttons 6		
For models:	BMA0026-F, BMA0032-F, BMA0035-F, BMB0028-F, BMB0029-F, BMB0033-F, BMB0034-F, BMB0035-F, BMC0012-F, BMC0015-F, BNA0030-F, BNA0031-F, BNA0036-F, BNA0037-F, BNA0044-F, BNA0045-F, BNZ0001-F, BNZ0002-F, BNZ0003-F, BNZ0005-F, BNZ0006-F, BNZ0007-F, CCZ0036-F, CCZ0037-F, VTGB2A-F, VTGB3A-F, VTGB4A-F		
accessories for	403412		
	Part No.	381249	Ref. No. A00DJ109
	description	temperature probe NTC 10kOhm cable PVC probe -40 up to +110°C cable -10 up to 100°C connection 2-wire thread probe ø6x14mm cable length 3m	

1 electric components



probes

universal probes

temperature probes



Part No.	379160	Ref. No.	A00DJ102
description	temperature probe NTC 10kOhm cable thermoplastic probe -40 up to +110°C cable -40 up to +110°C probe ø6x14mm cable length 1.5m without screw connection 2-wire		
For models:	BMA0008-F, BMA0010-F, BMA0029-F, BMB0030-F, BMB0035-F, BMB0036-F, BMB0037-F, BMC0012-F, BMC0014-F, BMC0016-F, BNA0036-F, BNA0037-F, BNA0045-F, BNA0052-F, BNA0053-F, BNA0054-F, BNA0055-F, BNA0057-F, BNA0064-F, BNA0065-F, BNA0066-F, BNB0010-F, BNB0011-F, BNB0012-F, BNB0013-F, BNB0014-F, BNB0015-F, BNZ0007-F, CCZ0036-F, CCZ0037-F, PB9RI-F, VTGB4A-F		

producer-specific probes

probes



Part No.	403942	Ref. No.	231016
description	temperature probe		
For models:	GLB0041, GLB0043C-60Hz, GLB0047, GLB0049		



Part No.	381544	Ref. No.	12039678
description	temperature probe connection plug probe 4x540mm cable length 2m		
For models:	AIC0041-F, AIC0042-F, AIC0045-F, AIC0046-F, AIC0075-F, AIC0080-F		



Part No.	403925	Ref. No.	12041634
description	temperature probe connection plug probe ø4x362 cable length 2m		
For models:	AIC0071-F, AIC0072-F, AIC0073-F, AIC0074-F, AIC0076-F, AIC0077-F, AIC0078-F, AIC0079-F		



Part No.	403924	Ref. No.	12044609
description	temperature probe connection plug probe ø4x425mm cable length 2m		
For models:	AIC0037-F, AIC0038-F, AIC0039-F, AIC0040-F, AIC0043-F, AIC0044-F		



Part No.	403929	Ref. No.	12047675
description	temperature probe connection plug probe ø4x627 cable length 2m		
For models:	AIC0075-F, AIC0080-F		



Part No.	381249	Ref. No.	A00DJ109
description	temperature probe NTC 10kOhm cable PVC probe -40 up to +110°C cable -10 up to 100°C connection 2-wire thread probe ø6x14mm cable length 3m		
For models:	BMA0008-F, BMA0010-F, BMA0021-F, BMA0022-F, BMA0024-F, BMA0025-F, BMA0027-F, BMA0028-F, BMA0029-F, BMA0032-F, BMB0028-F, BMB0029-F, BMB0030-F, BMB0033-F, BMB0035-F, BMB0036-F, BMB0037-F, BMC0012-F, BMC0014-F, BMC0015-F, BMC0016-F, BNA0030-F, BNA0031-F, BNA0036-F, BNA0037-F, BNA0044-F, BNA0045-F, BNA0052-F, BNA0053-F, BNA0054-F, BNA0055-F, BNA0056-F, BNA0057-F, BNA0064-F, BNA0065-F, BNA0066-F, BNB0010-F, BNB0011-F, BNB0012-F, BNB0013-F, BNB0014-F, BNB0015-F, BNZ0001-F, BNZ0002-F, BNZ0003-F, BNZ0004-F, BNZ0005-F, BNZ0006-F, BNZ0007-F, BNZ0008-F... (Other models you can see in the webshop)		



Part No.	400910	Ref. No.	231014
description	temperature probe NTC 10kOhm cable silicone probe -40 up to +110°C cable -50 up to +180°C connection coded plug thread probe ø4.5x30mm cable length 0.35m		
For models:	GLB0040, GLB0041, GLB0042, GLB0043C, GLB0044C, GLB0045, GLB0047, GLB0048		



Part No.	378339	Ref. No.	12025036
description	temperature probe NTC 64kOhm cable silicone probe -40 up to +110°C cable -50 up to +180°C connection plug thread probe ø6x-14mm cable length 2.5m		
For models:	GLB0067-F, GLB0069-F, GLB0071-F, GLB0080, GLB0081, GLB0082		



Part No.	379525	Ref. No.	12024642
description	temperature probe thermocouple K (NiCr-Ni) cable PTFE probe -50 up to 1150°C cable -40 up to +250°C connection male faston 6.3mm thread probe ø3x70mm cable length 1m		
For models:	AIC0037-F, AIC0038-F, AIC0039-F, AIC0040-F, AIC0041-F, AIC0042-F, AIC0043-F, AIC0044-F, AIC0045-F, AIC0046-F, AIC0071-F, AIC0072-F, AIC0073-F, AIC0074-F, AIC0075-F, AIC0076-F, AIC0077-F, AIC0078-F, AIC0079-F, AIC0080-F		



Part No.	379528	Ref. No.	12023901
description	temperature probe thermocouple K (NiCr-Ni) cable PTFE probe -50 up to 1150°C cable -40 up to +250°C connection male faston thread probe ø3x70mm cable length 1.6m		
For models:	AIC0037-F, AIC0038-F, AIC0039-F, AIC0040-F, AIC0041-F, AIC0042-F, AIC0043-F, AIC0044-F, AIC0045-F, AIC0046-F		

1 electric components



core probes

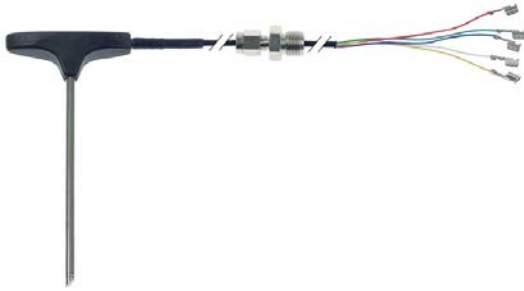

1

Part No.	378670	Ref. No.	12039548
description	core temperature probe thermocouple K (NiCr-Ni) cable PTFE probe -40 up to +250°C cable -40 up to +250°C connection 5-wire probe ø4x100mm thread 1/4" cable length 2m handle ømm handle length 55mm multipoint probe		
For models:	AIC0037-F, AIC0038-F, AIC0039-F, AIC0040-F, AIC0041-F, AIC0042-F, AIC0043-F, AIC0044-F, AIC0045-F, AIC0046-F, AIC0071-F, AIC0072-F, AIC0073-F, AIC0074-F, AIC0075-F, AIC0076-F, AIC0077-F, AIC0078-F, AIC0079-F, AIC0080-F		

accessories

screw connections



1

Part No.	691086	Ref. No.	12023581
description	union screw		
For models:	AIC0037-F, AIC0038-F, AIC0039-F, AIC0040-F, AIC0041-F, AIC0042-F, AIC0043-F, AIC0044-F, AIC0045-F, AIC0046-F, AIC0071-F, AIC0072-F, AIC0073-F, AIC0074-F, AIC0075-F, AIC0076-F, AIC0077-F, AIC0078-F, AIC0079-F, AIC0080-F		

miscellaneous



1

Part No.	691085	Ref. No.	12024247
description	sealing ring for probe		
For models:	AIC0037-F, AIC0038-F, AIC0039-F, AIC0040-F, AIC0041-F, AIC0042-F, AIC0043-F, AIC0044-F, AIC0045-F, AIC0046-F, AIC0071-F, AIC0072-F, AIC0073-F, AIC0074-F, AIC0075-F, AIC0076-F, AIC0077-F, AIC0078-F, AIC0079-F, AIC0080-F		

electronics

EPROMS



1

Part No.	403244	Ref. No.	81008
description	EPROM for dishwasher CODE 81008		
For models:	GLB0045, GLB0047, GLB0048		



1

Part No.	403241	Ref. No.	81001
description	EPROM type U61E for dishwasher CODE 81001-3		
For models:	GLB0040, GLB0041, GLB0042, GLB0043C, GLB0044C		

frequency converters





1

Part No.	403922	Ref. No.	12048794
description	frequency converter with heat sink for combi-steamer 200-240V 47-63 Hz L 150mm W 115mm H 90mm output frequency 0-550Hz 6.2A output current 2.3A SIEMENS SINAMICS G110 CPM110 AIN 6SL3211-0AB13-7UA1		
For models:	AIC0037-F, AIC0071-F		







			
1			
Part No.	403935	Ref. No.	12048798
description	frequency converter with heat sink for combi-steamer 200-240V L 150mm W 115mm H 90mm output frequency 0-550Hz 6.2A output current 2.3A		
For models:	AIC0038-F, AIC0039-F, AIC0040-F, AIC0041-F, AIC0042-F, AIC0043-F, AIC0044-F, AIC0045-F, AIC0046-F, AIC0072-F, AIC0073-F, AIC0074-F, AIC0075-F, AIC0076-F, AIC0077-F, AIC0078-F, AIC0079-F, AIC0080-F		

PCBs

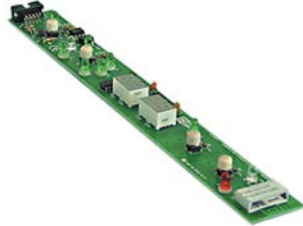
			
1			
Part No.	403076	Ref. No.	12046671
description	display PCB combi-steamer COE061 L 160mm W 110mm with potentiometer		
For models:	AIC0071-F, AIC0072-F, AIC0073-F, AIC0074-F, AIC0075-F, AIC0076-F, AIC0077-F, AIC0078-F, AIC0079-F, AIC0080-F		
accessories for	403076		
	Part No.	402230	Ref. No. —
PCB for combi-steamer			

			
1			
Part No.	403237	Ref. No.	12024028
description	display PCB dishwasher AD15/21/48 L 100mm W 35mm		
For models:	GLB0067-F, GLB0069-F, GLB0071-F		

			
1			
Part No.	400897	Ref. No.	227059
description	display PCB dishwasher GS 60		
For models:	GLB0040		
accessories for	400897		
	Part No.	403250	Ref. No. 926272
ribbon cable 10-pole L 3000mm plug type coded 2 row plug: number of poles 10			

			
1			
Part No.	400898	Ref. No.	80889 80900
description	keypad PCB dishwasher LP10/20/30 with display		
For models:	GLB0041, GLB0042, GLB0043C, GLB0043C-60Hz, GLB0044C, GLB0045, GLB0047, GLB0048		
accessories for	400898		
	Part No.	402970	Ref. No. 41523
ribbon cable 10-pole L 1200mm plug type 2 row coded Qty 1m			

			
1			
Part No.	402225	Ref. No.	12046670
description	PCB combi-steamer VE101/202		
For models:	AIC0037-F, AIC0038-F, AIC0039-F, AIC0040-F, AIC0041-F, AIC0042-F, AIC0043-F, AIC0044-F, AIC0045-F, AIC0046-F		

			
1			
Part No.	403308	Ref. No.	12008750
description	PCB dishwasher AD-72/48/64 L 128mm W 118mm suitable for FAGOR with housing H 55mm for dishwasher Qty 1 pcs		
For models:	GLB0067-F, GLB0069-F, GLB0082		

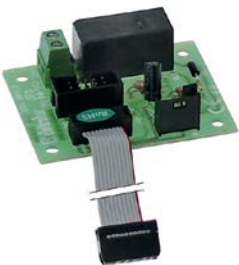
1

Part No.	401049	Ref. No.	215022
description	PCB dishwasher LP10/20/30		
For models:	GLB0040, GLB0041, GLB0042, GLB0043C, GLB0044C, GLB0045, GLB0047, GLB0048		



1

Part No.	403572	Ref. No.	215032-1
description	PCB dishwasher Protech 1113/611 TR10 L 178mm W 125mm		
For models:	GLB0043C-60Hz, GLB0047		

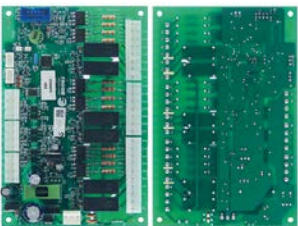

1

Part No.	403923	Ref. No.	12046673
description	PCB for combi-steamer 61/101 L 150mm W 100mm suitable for FAGOR		
For models:	AIC0038-F, AIC0040-F, AIC0042-F, AIC0044-F, AIC0046-F, AIC0076-F, AIC0077-F, AIC0078-F, AIC0079-F, AIC0080-F		



1

Part No.	403934	Ref. No.	12046659
description	PCB for combi-steamer L 155mm W 100mm		
For models:	AIC0037-F, AIC0038-F, AIC0039-F, AIC0040-F, AIC0041-F, AIC0042-F, AIC0043-F, AIC0044-F, AIC0045-F, AIC0046-F, AIC0071-F, AIC0072-F, AIC0073-F, AIC0074-F, AIC0075-F, AIC0076-F, AIC0077-F, AIC0078-F, AIC0079-F, AIC0080-F		



1

Part No.	361978	Ref. No.	91310260
description	PCB pizza oven/pizza press L 125mm W 108mm with display buttons 6		
For models:	CBC0001, CBC0002, CBC0003, CBC0004		



1

Part No.	401451	Ref. No.	663.048.00
description	PCB pyroceram range 110/920 series		
For models:	VS9040PVET, VS9080CFVE, VS9080PVET		

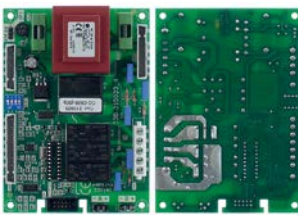

1

Part No.	400899	Ref. No.	215023	
description	power PCB dishwasher LP10/20/30 without EPROM			
For models:	GLB0040, GLB0041, GLB0042, GLB0043C, GLB0044C, GLB0045, GLB0047, GLB0048			
accessories for	400899			
	Part No.	400761	Ref. No.	—
	plug connector 5-pole			
	Part No.	400900	Ref. No.	—
	EPROM CODE 225029-3			
	Part No.	401558	Ref. No.	—
	EPROM CODE 81000-1			
	Part No.	403241	Ref. No.	81001
	EPROM type U61E for dishwasher CODE 81001-3			
	Part No.	550048	Ref. No.	—
	female bullet			



keypads

front foils



1

Part No.	403927	Ref. No.	12044109
description	keypad foil for combi-steamer black L 540mm W 173mm		
For models:	AIC0071-F, AIC0072-F, AIC0073-F, AIC0074-F, AIC0075-F		



1

Part No.	403928	Ref. No.	12044176
description	keypad foil for combi-steamer black L 540mm W 173mm		
For models:	AIC0076-F, AIC0077-F, AIC0078-F, AIC0079-F, AIC0080-F		



1

Part No.	403710	Ref. No.	A00DJ105
description	keypad foil for fridge suitable for FRENEX		
For models:	BMA0008-F, BMA0010-F, BMA0021-F, BMA0022-F, BMA0024-F, BMA0025-F, BMA0026-F, BMA0027-F, BMA0028-F, BMA0029-F, BMA0032-F, BMA0035-F, BMA0036-F, BMB0028-F, BMB0029-F, BMB0030-F, BMB0033-F, BMB0034-F, BMB0035-F, BMB0036-F, BMB0037-F, BMC0012-F, BMC0014-F, BMC0015-F, BMC0016-F, BNA0030-F, BNA0031-F, BNA0036-F, BNA0037-F, BNA0044-F, BNA0045-F, BNA0056-F, BNA0064-F, BNA0065-F, BNA0066-F, BNZ0001-F, BNZ0002-F, BNZ0003-F, BNZ0004-F, BNZ0005-F, BNZ0006-F, BNZ0007-F, BNZ0008-F, CCZ0036-F, CCZ0037-F, PB9RI-F, VTGB2A-F, VTGB2-F, VTGB3A-F, VTGB3-F...(Other models you can see in the webshop)		

solenoid valves

solenoid valves (water)

ELBI

straight



1

Part No.	373025	Ref. No.	12023921
description	solenoid valve triple straight 230VAC inlet 3/4" outlet 11.5mm DN10 ELBI		
For models:	AIC0037-F, AIC0038-F, AIC0039-F, AIC0040-F, AIC0041-F, AIC0042-F, AIC0043-F, AIC0044-F, AIC0045-F, AIC0046-F		
spare parts for	373025		
	Part No.	370467	Ref. No. —
	solenoid valve filter suitable for ELBI		



1

Part No.	370315	Ref. No.	929172
description	solenoid valve double straight 230VAC inlet 3/4" outlet 11.5mm input 16l/min t.max. 90°C ELBI plastic flow regulating valve inlet black		
For models:	GLB0041, GLB0043C, GLB0044C, GLB0045, GLB0047, GLB0048		



1			
Part No.	370849	Ref. No.	12115418
description	solenoid valve triple straight 220-240V/50-60Hz inlet 3/4" outlet 10.5 t.max. 90°C duty cycle 100% ELBI 369 plastic flow regulating valve inlet black		
For models:	AIC0037-F, AIC0038-F, AIC0039-F, AIC0040-F, AIC0041-F, AIC0042-F, AIC0044-F, AIC0045-F, AIC0046-F		

spare parts and accessories

reducers

outlet side

1			
Part No.	371260	Ref. No.	12008692
description	reducer type ELBI flow rate 0.5l/min pressure range 0 up to 10bar tolerance ±15/25% red		
For models:	AIC0078-F, AIC0079-F, AIC0080-F		

TP

1			
Part No.	370017	Ref. No.	12025161 240018
description	solenoid valve single straight 230VAC inlet 3/4" outlet 11.5mm DN10 TP p max 10bar		
For models:	AIC0037-F, AIC0038-F, AIC0039-F, AIC0040-F, AIC0041-F, AIC0042-F, AIC0043-F, AIC0044-F, AIC0045-F, AIC0046-F, AIC0071-F, AIC0072-F, AIC0073-F, AIC0074-F, AIC0075-F, AIC0076-F, AIC0077-F, AIC0078-F, AIC0079-F, AIC0080-F, GLB0040, GLB0043C-60Hz		
spare parts for	370017		
	Part No.	371013	Ref. No. —
accessories for	370017		
	Part No.	371220	Ref. No. —
	Part No.	371221	Ref. No. —
	Part No.	371222	Ref. No. —
	Part No.	371223	Ref. No. —

accessories for	370017		
	Part No.	371224	Ref. No. —
	Part No.	371225	Ref. No. —
	Part No.	371226	Ref. No. —
	Part No.	371230	Ref. No. —
	Part No.	371231	Ref. No. —
	Part No.	371232	Ref. No. —
	Part No.	371233	Ref. No. —
	Part No.	371234	Ref. No. 12025263
	Part No.	371235	Ref. No. —
	Part No.	371236	Ref. No. —
	Part No.	371237	Ref. No. —
	Part No.	371238	Ref. No. —
	Part No.	371239	Ref. No. —
	Part No.	371240	Ref. No. —

1			
Part No.	370860	Ref. No.	256.347.00
description	solenoid valve single angled 230VAC inlet 3/4" outlet 11.5mm DN10 TP		
For models:	VS7080BREI, VS7080BREIM, VS7080BRGI, VS7080BRGIM, VS7080PEI50, VS7080PG50, VS7080PGI50, VS9080BREI, VS9080BREIM, VS9080BRGI, VS9080BRGIM, VS9080PEI150, VS9080PGI150		



spare parts and accessories

reducers

outlet side



1

Part No.	691081	Ref. No.	12024509
description	reducer flow rate 0.25l/min green tolerance $\pm 25\%$		
For models:	AIC0037-F, AIC0038-F, AIC0039-F, AIC0040-F, AIC0041-F, AIC0042-F, AIC0043-F, AIC0044-F, AIC0046-F, AIC0071-F, AIC0072-F, AIC0073-F, AIC0074-F, AIC0076-F, AIC0077-F		



1

Part No.	691082	Ref. No.	12024045
description	reducer flow rate 8l/min violet tolerance $\pm 25\%$		
For models:	AIC0037-F, AIC0038-F, AIC0039-F, AIC0040-F, AIC0041-F, AIC0042-F, AIC0044-F, AIC0045-F, AIC0046-F		



1

Part No.	371234	Ref. No.	12025263
description	reducer TP flow rate 1l/min light blue tolerance $\pm 25\%$		
For models:	AIC0037-F, AIC0038-F, AIC0039-F, AIC0040-F, AIC0041-F, AIC0042-F, AIC0043-F, AIC0044-F, AIC0045-F, AIC0046-F, AIC0071-F, AIC0072-F, AIC0073-F, AIC0074-F, AIC0075-F		

metal

PARKER

2-way

VE-123 series



1

Part No.	370727	Ref. No.	927142
description	solenoid valve brass 2-ways 24VAC inlet 1/2" IT outlet 1/2" IT connection 1/2" L 72mm DN 13mm t.max. 140°C -10 up to 140°C PARKER type series VE123 coil type ZB09 membranes Viton p max 5bar 50/60Hz 24V voltage AC		
For models:	GLB0049, GLB0050, GLB0051		

solenoid valves (refrigeration)

CASTEL

valves



1

Part No.	370402	Ref. No.	A00SL100
description	solenoid valve CASTEL type 1028/2 230V p max 45bar 1/4" connection 1/4" -35 up to 110°C refrigeration copper/brass DN 6.35mm		
For models:	BMA0021-F, BMA0022-F, BMA0024-F, BMA0025-F, BMA0026-F, BMA0027-F, BMA0028-F, BMA0029-F, BMA0032-F, BMB0028-F, BMB0029-F, BMB0033-F, BMB0034-F, BMC0014-F, BMC0016-F, BNA0030-F, BNA0031-F, BNA0036-F, BNA0044-F, CCZ0036-F, CCZ0037-F		

SANHUA

valves



1

Part No.	370837	Ref. No.	A00SL101
description	solenoid valve SANHUA type MDF-A03-3H003 230V p max 45bar L 112mm -35 up to 110°C refrigeration copper/brass		
For models:	BMA0035-F, BMA0036-F, BMB0030-F, BMC0012-F, BMC0014-F, BMC0015-F, BMC0016-F, BNZ0004-F, BNZ0008-F, VTGB2A-F, VTGB2-F, VTGB3A-F, VTGB3-F, VTGB4-F		

pressure switches

for warewashing

ø 58mm with male faston 6.3mm

with connection horizontal





1

Part No.	541002	Ref. No.	224002
description	pressure control pressure range 110/60mbar connection 6mm ø 58mm pressure connection horizontal warewashing pressure connection ø 6mm		
For models:	GLB0040, GLB0043C-60Hz		





			
1			
Part No.	541105	Ref. No.	926049
description	pressure control pressure range 180/70mbar connection 6mm ø 58mm pressure connection horizontal warewashing		
For models:	GLB0041, GLB0042, GLB0043C, GLB0043C-60Hz, GLB0044C, GLB0045, GLB0047, GLB0048, GLB0049, GLB0050, GLB0051		

			
1			
Part No.	541001	Ref. No.	224004
description	pressure control pressure range 35/17mbar connection 6mm ø 58mm pressure connection horizontal warewashing		
For models:	GLB0040, GLB0041, GLB0042, GLB0043C, GLB0044C		

accessories			
			
1			
Part No.	541109	Ref. No.	12023510
description	Y-piece plastic hose ø 8-6-8mm for pressure switch		
For models:	GLB0067-F, GLB0069-F		

for steam control			
			
1			
Part No.	542406	Ref. No.	962.001.00
description	pressure control ø 45mm kettle pressure range 0.45/0.4bar connection 1/4" p max 1/1bar		
For models:	VS70120CFGG, VS7080PEI50, VS7080PGI50, VS90120CFGG, VS9080PEI150, VS9080PGI150		

accessories			
			
1			
Part No.	542440	Ref. No.	931.217.00
description	screw connection for pressure switches ø 6mm 3/8"		
For models:	VS9080PEI150, VS9080PGI150		

electrodes			
			
1			
Part No.	694804	Ref. No.	12024460
description	duct for level electrode screw mounting total length 49mm plastic ø 8mm		
For models:	AIC0037-F, AIC0038-F, AIC0039-F, AIC0040-F, AIC0041-F, AIC0042-F, AIC0043-F, AIC0044-F, AIC0045-F, AIC0046-F		

			
1			
Part No.	400884	Ref. No.	12023573
description	level electrode push-in total length 105mm probe L 95mm insulated probe lengthmm connection M4		
For models:	AIC0037-F, AIC0038-F, AIC0039-F, AIC0040-F, AIC0041-F, AIC0042-F, AIC0043-F, AIC0044-F, AIC0045-F, AIC0046-F		

			
1			
Part No.	400885	Ref. No.	12023574
description	level electrode push-in total length 120mm probe L 110mm insulated probe lengthmm connection M4		
For models:	AIC0037-F, AIC0038-F, AIC0039-F, AIC0040-F, AIC0041-F, AIC0042-F, AIC0043-F, AIC0044-F, AIC0045-F, AIC0046-F		

			
1			
Part No.	400886	Ref. No.	12023575
description	level electrode push-in total length 130mm probe L 120mm insulated probe lengthmm connection M4		
For models:	AIC0037-F, AIC0038-F, AIC0039-F, AIC0040-F, AIC0041-F, AIC0042-F, AIC0043-F, AIC0044-F, AIC0045-F, AIC0046-F		

flow meters and flow sensors

flow meters			
miscellaneous			
			
1			
Part No.	402680	Ref. No.	240998
description	flow meter pressure range 0.2-10bar connection 10mm L 69mm		
For models:	GLB0049, GLB0050, GLB0051		



cooling aggregates

Part No.	379304***	Ref. No.	123456
description			
For models:			

Part No.	379304***	Ref. No.	123456
description			
For models:			

Part No.	379304***	Ref. No.	123456
description			
For models:			

compressors

EMBRACO / ASPERA

R134A

HBP monophase

High evaporation temperature above -15°C



1

Part No.	605189	Ref. No.	A00K0110
description	compressor coolant R134a type EMT6160Z 220-240V 50Hz HBP 7.8kg 1/4HP cylinder capacity 6.76cm ³ CSIR H 166mmWWW 325W 412W 513W 630W 762W 910W ambient temperature max. 45°C		
For models:	CCZ0036-F		



1

Part No.	605135	Ref. No.	A00K0101
description	compressor coolant R134a type EMT6170Z 220-240V 50Hz HBP fully hermetic 8.1kg 1/6HP cylinder capacity 7.69cm ³ CSIR H 166mmWWW 281W 358W 448W 550W 663W 982W		
For models:	BMA0008-F, BMA0010-F, BMA0021-F, BMA0022-F, BMA0024-F, BMA0025-F, BMA0027-F, BMA0029-F, BMA0035-F, BMC0014-F, BMC0016-F, BNA0036-F, BNA0037-F, BNA0044-F, BNA0045-F, BNA0054-F, BNA0055-F, BNA0056-F, BNA0057-F, BNA0065-F, BNA0066-F, BNZ0005-F, BNZ0006-F, CCZ0037-F		



1

Part No.	605208	Ref. No.	A00K0109
description	compressor coolant R134a type NEK6210Z-A 220-240V 50Hz HBP 11kg 1/3HP cylinder capacity 12.1cm ³ CSIR H 200mmWWW 364W 485W 636W 818W 1030W 1273W test method EN 12900 ambient temperature max. 55°C		
For models:	BMA0028-F, BMA0036-F		

HMBP monophase

High/Medium evaporation temperature above -20/-15 °C



1

Part No.	605016	Ref. No.	A00K0100
description	compressor coolant R134a type EM65HHR 220-240V 50Hz HBP fully hermetic 7.62kg 1/6HP cylinder capacity 5.54cm ³ CSIRWWW 287W 389W 499W 617W 742W test method ASHRAE 842W		
For models:	BMC0012-F, BMC0016-F, BNA0030-F, BNA0031-F, BNA0052-F, BNA0053-F, BNA0064-F, BNZ0001-F, BNZ0002-F, CCZ0036-F		



R404a/R507

LBP monophase

Lower evaporation temperature below -20°C



1

Part No.	605256	Ref. No.	A00KO105
description	compressor coolant R404a type NEU2140GK 220-240V 50Hz LBP 10.6kg 1/2HP cylinder capacity 8.77cm ³ CSR H 206mm 326W 421W 531W 658W 801WWWWWW test method EN 12900		
For models:	BMB0030-F, BMC0012-F, BMC0016-F		



1

Part No.	605144	Ref. No.	A00KO102
description	compressor coolant R404a/R507 type NEK2168GK 220-240V 50Hz LBP 22.9kg 3/4HP cylinder capacity 14.28cm ³ CSR H 200mm 345W 454W 587W 742W 921W 1123WWWWWW		
For models:	BMA0026-F, BMA0032-F, BMB0033-F, BMC0014-F, BMC0015-F, PB9R1-F		



1

Part No.	605174	Ref. No.	A00KO103
description	compressor coolant R404a/R507 type NJ2192GK 220-240V 50Hz LBP 20.4kg 1 1/4HP cylinder capacity 26.2cm ³ CSR H 265mm 685W 989W 1342W 1745W 2196W 2196WWWWWW		
For models:	BMB0028-F, BMB0029-F, BMB0034-F, BMB0035-F, BMB0036-F, BMB0037-F, BMC0015-F, BNB0010-F, BNB0011-F, BNB0012-F, BNB0013-F, BNB0014-F, BNB0015-F, BNZ0004-F, BNZ0007-F, BNZ0008-F, VTGB2A-F, VTGB2-F, VTGB3A-F, VTGB3-F, VTGB4A-F, VTGB4-F		

fans

axial fans

import





1

Part No.	602165	Ref. No.	764.055.00
description	axial fan L 119mm W 119mm H 38mm 230VAC 50/60Hz 15/14W manuf. no. 4715MS-23T-B5A connection male faston 2.8mm NMB fan wheel ø 110mm		
For models:	VS7080TPET, VS7080TPFE, VS9080TPET, VS9080TPFE		



1

Part No.	601080 ¹	Ref. No.	12023862	
description	axial fan L 119mm W 119mm H 38mm 230VAC 50/60Hz 23/20W bearing ball bearing connection male faston 2.8mm metal ADDA fan wheel ø 110mm temp.-resist. 70°C			
For models:	AIC0037-F, AIC0038-F, AIC0039-F, AIC0040-F, AIC0041-F, AIC0042-F, AIC0071-F, AIC0072-F, AIC0073-F, AIC0076-F, AIC0077-F, AIC0078-F			
accessories for	601080			
	Part No.	550898	Ref. No.	—
	connecting cable cable length 2000mm connection F 2.8 connection distance 7.9mm for axial flow fan			
	Part No.	692519	Ref. No.	—
	guard L 120mm W 120mm plastic			

¹with ball bearings



1

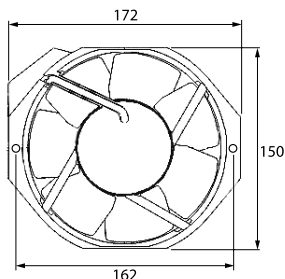

Part No.	601932	Ref. No.	A00FA107
description	axial fan L 172mm W 150mm H 51mm 230 50/60Hz 23W bearing ball bearing manuf. no. AC17251CU7C1Y connection cable 1000mm MA-VIB airflow 336/390m ³ /h		
For models:	BMA0008-F, BMA0010-F, BMA0026-F, BMA0027-F, BMA0028-F, BMB0034-F, BMB0035-F, BMB0036-F, BMB0037-F, BMC0015-F, PB9RI-F		



2

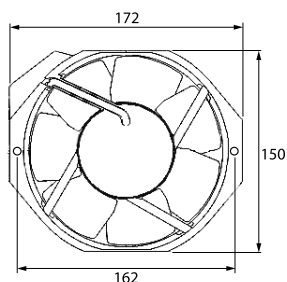

Part No.	601654 ¹	Ref. No.	12024106
description	axial fan L 172mm W 150mm H 51mm 230VAC 50/60Hz 28/24W bearing ball bearing manuf. no. A2175-HBL T.GN connection cable cable length 280mm metal SUNON fan wheel ø 142mm temp.-resist. -10 up to +80°C mounting distance 162mm		
For models:	AIC0043-F, AIC0044-F, AIC0045-F, AIC0046-F, AIC0074-F, AIC0075-F, AIC0079-F, AIC0080-F		

¹with ball bearings

refrigeration fans

refrigeration motors universal

ELCO

N series - standard





1

Part No.	601930	Ref. No.	A00FA109 A00KN100-A A00KN101-A A00KN700-A
description	fan motor ELCO 10W 230V 50/60Hz bearing slide bearing L1 55.5mm L2 91.5mm L3 119mm W 83mm cable length 2000mm 1300/1550rpm 5 mounting options VN10-20/929		
For models:	BMA0008-F, BMA0010-F, BMA0029-F, BMC0012-F, BMC0014-F, BMC0016-F, BNA0036-F, BNA0037-F, BNA0045-F, BNA0064-F, BNA0065-F, BNA0066-F, CCZ0036-F, CCZ0037-F		
spare parts for	601930		
	Part No.	601284	Ref. No. —
fan wheel sucking ø 254mm fan wheel mounting 25.4mm blade angle 28° W 42mm aluminium			



1

Part No.	601928	Ref. No.	A00FA104 A00KN102-A A00KN153-A A00KN701-A
description	fan motor ELCO 16W 230V 50Hz bearing slide bearing L1 55.5mm L2 91.5mm L3 119mm W 83mm cable length 2000mm 1300/1550rpm 5 mounting options VNT16-25/1774		
For models:	BMB0030-F, BMB0035-F, BMB0036-F, BMB0037-F, BMC0012-F, BMC0016-F, BNZ0007-F, PB9RI-F, VTGB4A-F		
spare parts for	601928		
	Part No.	601284	Ref. No. —
fan wheel sucking ø 254mm fan wheel mounting 25.4mm blade angle 28° W 42mm aluminium			
	Part No.	601413	Ref. No. —
fixing plate suitable for fanwheel ED ø 32mm shaft ø 7 mounting distance 26mm			



cooling motors (complete)



1

Part No.	601511	Ref. No.	12038161
description	fan 230V 10W 50Hz fan wheel ø 195mm blade angle 22° connection cable 500mm		
For models:	BKZ0022-F		

cold air circulating fans (complete)

HIDRIA

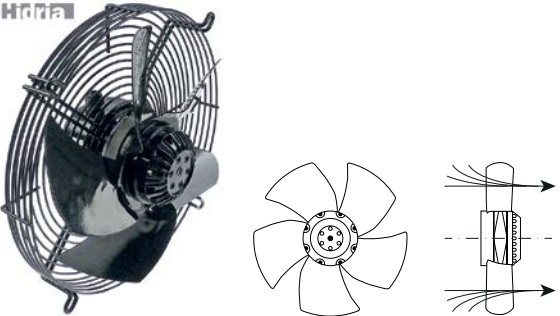

1

Part No.	601811	Ref. No.	12026785
description	fan type R09R-3030HP-4M-2543 fan wheel ø 300mm 230V 50/60Hz 65/90W suitable capacitor 2.5µF HIDRIA suitable for blast chiller suitable for FRIULINOX 1400/1500rpm blowing H 138mm cable lengthmm mounting distance 265mm		
For models:	BKZ0022-F, BKZ0023-F		

cold air circulating fans

cold air circulating fans



1

Part No.	601919	Ref. No.	A00FA102 A00SHP009-A
description	fan motor 220-230V 50-60Hz 5W shaft ø 6mm shaft L 14mm L 73mm W 62mm H 62mm cable length 2900mm input current 2A		
For models:	BMB0030-F, BMC0014-F, BMC0016-F, BNA0030-F, BNA0031-F, BNA0036-F, BNA0037-F, BNA0044-F, BNA0045-F, BNA0052-F, BNA0053-F, BNA0054-F, BNA0055-F, BNA0056-F, BNA0057-F, BNA0064-F, BNA0065-F, BNA0066-F, BNB0010-F, BNB0011-F, BNB0012-F, BNB0013-F, BNB0014-F, BNB0015-F, BNZ0002-F, BNZ0004-F, BNZ0006-F, BNZ0007-F, BNZ0008-F, CCZ0036-F, CCZ0037-F, VTGB2A-F, VTGB2-F, VTGB3A-F, VTGB3-F, VTGB4A-F, VTGB4-F		
spare parts for	601919		
		Part No.	601568
		Ref. No.	—
	fan wheel blowing ø 154mm fan wheel mounting 25.4mm blade angle 28° W 34mm aluminium		

cross flow fans

ebm-papst



1

Part No.	601936	Ref. No.	A00FA103
description	cross flow fan QLZ06/1800A265-2524 roller ø 60mm roller length 180mm laminated core thickness 28mm motor position right 230V/50Hz 31W refrigeration bearing rubber connection male faston 6.3mm airflow 160m³/h 0 up to +60°C 230V 150m³/h 50Hz		
For models:	BMA0021-F, BMA0022-F, BMA0024-F, BMA0025-F, BMA0032-F, BMA0035-F, BMA0036-F, BMB0028-F, BMB0029-F, BMB0033-F, BMC0016-F		



hot air motors



1

Part No.	602143	Ref. No.	12024325
description	fan motor 3 phase 50Hz 0.75kW 1400rpm L1 150mm L2 45mm L3 37mm D1 ø 17mm D2 ø 14mm 3.2A type 3036AB2350		
For models:	AIC0037-F, AIC0038-F, AIC0039-F, AIC0040-F, AIC0041-F, AIC0042-F, AIC0043-F, AIC0044-F, AIC0045-F, AIC0046-F, AIC0071-F, AIC0072-F, AIC0073-F, AIC0074-F, AIC0075-F, AIC0076-F, AIC0077-F, AIC0078-F, AIC0079-F, AIC0080-F		



1

Part No.	602182	Ref. No.	12024786
description	fan wheel blades 12 D1 ø 280mm D2 ø 13mm D3 ø 16.5mm H1 128mm H2 20.5mm H3 80mm		
For models:	AIC0038-F, AIC0076-F		



1

Part No.	601795	Ref. No.	12024306
description	fan wheel D1 ø 350mm H1 125mm blades 12 D2 ø 13mm D3 ø 16mm H2 15mm		
For models:	AIC0037-F, AIC0039-F, AIC0040-F, AIC0041-F, AIC0042-F, AIC0043-F, AIC0044-F, AIC0045-F, AIC0046-F, AIC0071-F, AIC0072-F, AIC0073-F, AIC0074-F, AIC0075-F, AIC0077-F, AIC0078-F, AIC0079-F, AIC0080-F		



1

Part No.	691049	Ref. No.	12024510
description	shaft seal ID ø 17mm ED ø 28mm thickness 7mm		
For models:	AIC0037-F, AIC0038-F, AIC0039-F, AIC0040-F, AIC0041-F, AIC0042-F, AIC0043-F, AIC0044-F, AIC0045-F, AIC0046-F, AIC0071-F, AIC0072-F, AIC0073-F, AIC0074-F, AIC0075-F, AIC0076-F, AIC0077-F, AIC0078-F, AIC0079-F, AIC0080-F		

radial fans



1

Part No.	602181	Ref. No.	12039373
description	radial fan 230V voltage AC 50/60Hz 135W H1 193mm L1 182mm D1 ø 90mm W1 145mm W2 28mm H2 50mm W3 83mm H3 80mm combi-steamer		
For models:	AIC0046-F		

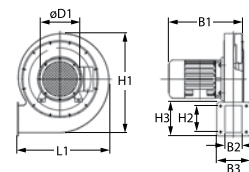

1

Part No.	602183	Ref. No.	12044607
description	radial fan 230V voltage AC 50Hz 55W H1 156mm L1 160mm D1 ø 126mm W1 90mm H2 50mm W3 83mm combi-steamer		
For models:	AIC0038-F, AIC0040-F, AIC0042-F, AIC0044-F, AIC0046-F, AIC0076-F, AIC0077-F, AIC0078-F, AIC0079-F, AIC0080-F		

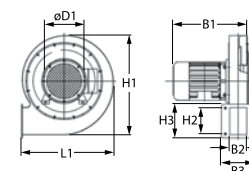

accessories universal



1

Part No.	521073	Ref. No.	A00EP101
description	fanwheel cover ø 290mm for evaporator fan hole distance 210mm plastic black H 50mm		
For models:	BMC0012-F, CCZ0036-F, CCZ0037-F		



			
1			
Part No.	601933	Ref. No.	A00EP100
description	fanwheel cover W 180mm for fan wheel H 50mm mounting distance 160mm		
For models:	BNA0030-F, BNA0031-F, BNA0036-F, BNA0037-F, BNA0044-F, BNA0045-F, BNA0052-F, BNA0053-F, BNA0054-F, BNA0055-F, BNA0056-F, BNA0057-F, BNA0064-F, BNA0065-F, BNA0066-F, BNB0010-F, BNB0011-F, BNB0012-F, BNB0013-F, BNB0014-F, BNB0015-F, BNZ0002-F, BNZ0004-F, BNZ0006-F, BNZ0007-F, BNZ0008-F, CCZ0036-F, CCZ0037-F, VTGB2A-F, VTGB2-F, VTGB3A-F, VTGB3-F, VTGB4A-F, VTGB4-F		

motors



gear motors

for tilting bratt pans

			
1			
Part No.	501582	Ref. No.	964.003.00
description	gear motor type AO-4/M 24V for tilting bratt pan		
For models:	VS7080BREIM, VS7080BRGIM, VS9080BREIM, VS9080BRGIM		

for ovens

for flues

			
1			
Part No.	530008	Ref. No.	12024638
description	gear motor MECHTEX type SOE-40 3.5W 230V voltage AC 50/60Hz 10rpm shaft ø 6x5mm L 65mm W 51mm H 40mm chimney motor		
For models:	AIC0037-F, AIC0038-F, AIC0039-F, AIC0040-F, AIC0041-F, AIC0042-F, AIC0043-F, AIC0044-F, AIC0045-F, AIC0046-F, AIC0071-F, AIC0072-F, AIC0073-F, AIC0074-F, AIC0075-F, AIC0076-F, AIC0077-F, AIC0078-F, AIC0079-F, AIC0080-F		
spare parts for	530008		
	Part No.	360673	Ref. No. —
	 motor kit pinion ø 6.8mm teeth 15 230V voltage AC 50/60Hz turn direction clockwise motor ø 48mm H 18.5mm motor type UDS-4ONE1RNZ165 cable length 150mm with holder		

for dishwashers

			
1			
Part No.	601861	Ref. No.	927105
description	gear motor FIR type 71-B5 180W 400V voltage AC 50/60Hz 3 phase 900/1100rpm shaft ø 14mm L 227mm for transport system without gearbox		
For models:	GLB0045, GLB0047, GLB0048, GLB0049, GLB0050, GLB0051		

miscellaneous

			
1			
Part No.	501518	Ref. No.	12024754
description	gear motor 230V 50/60Hz		
For models:	AIC0037-F, AIC0038-F, AIC0039-F, AIC0040-F, AIC0041-F, AIC0042-F, AIC0043-F, AIC0044-F, AIC0045-F, AIC0046-F		

pumps

wash and rinse pumps

FIR

pumps







			
1			
Part No.	500037	Ref. No.	929167
description	pump inlet ø 28mm outlet ø 26mm type 2211.1410 230V 50Hz 1 phase 0.074kW 0.1HP L 190mm rotation direction left capacitor 5µF FIR		
For models:	GLB0040, GLB0041, GLB0042, GLB0044C		
spare parts for	500037		
	Part No.	365017	Ref. No. 206010
	 operating capacitor capacity 5µF 450V tolerance 5% 50/60Hz ambient temperature max. -25 to +85°C ø 28mm L 54mm M8 plastic connection male faston 6.3mm 16.10.08 protection		
	Part No.	510384	Ref. No. —
	 pump cover inlet ø 28mm outlet ø 26mm ø 100mm ID ø 76mm		

Table continues overleaf

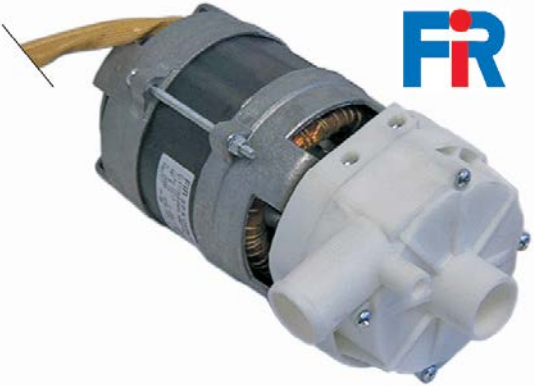

spare parts for 500037			
	Part No.	510695	Ref. No. —
mechanical shaft seal height counter ring 5.5mm ID ø 11mm			
	Part No.	521203	Ref. No. —
impellor ø 72mm H 18mm thread M7 shaft ø 11mm shaft length 32mm blades 3			
	Part No.	521703	Ref. No. —
pump cover gasket EPDM thickness 2.5mm ID ø 75mm Qty 1 pcs			



1			
Part No.	502287	Ref. No.	77047
description	pump inlet ø 30mm outlet ø 26mm type 5213.4050 230/400V 50Hz 3 phase 0.11kW 0.15HP L 200mm rotation direction left		
For models:	GLB0049, GLB0050, GLB0051		
spare parts for	502287		
	Part No.	699372	Ref. No. 80814
flange for pump with cover type 5213 L 103mm W 103mm H 69mm			



1			
Part No.	499353	Ref. No.	12024782
description	pump inlet ø 30mm outlet ø 26mm type 5213E2451 230V 50Hz 1 phase 0.22kW 0.1HP L 190mm rotation direction left capacitor 5µF FIR		
For models:	AIC0043-F, AIC0044-F, AIC0045-F, AIC0046-F		



1			
Part No.	499336	Ref. No.	929175
description	pump inlet ø 62 outlet ø 62 type 2250.2732 230/400V 50Hz 2.95kW 4HP		
For models:	GLB0044C		
spare parts for	499336		
	Part No.	510687	Ref. No. 929179
mechanical shaft seal for shaft ø 18mm height counter ring 8mm ID ø 17mm ED ø 39mm H 15mm mounting ø 42mm int. ø 1 21mm			
	Part No.	521026	Ref. No. —
pump cover gasket ID ø 182.5mm thickness 5x4.5mm			
	Part No.	521028	Ref. No. —
pump cover FIR inlet ø 62mm outlet ø 62mm turn direction right ø 215mm ID ø 175mm inner height 40mm			
	Part No.	521277	Ref. No. 929181
impellor ø 135mm H 39mm pump type Fir 2275 - 3.6HP thread M14L			







1			
Part No.	499334	Ref. No.	929174
description	pump inlet ø 62mm outlet ø 62mm type 2250.2731 230/400V 50Hz 1 phase 3kW FIR		
For models:	GLB0043C, GLB0044C		
spare parts for	499334		
	Part No.	510687	Ref. No. 929179
mechanical shaft seal for shaft ø 18mm height counter ring 8mm ID ø 17mm ED ø 39mm H 15mm mounting ø 42mm int. ø 1 21mm			
	Part No.	512455	Ref. No. 929189
fan wheel ø 155mm H 18mm shaft intake ø 18mm plastic blades 12			

Table continues overleaf

spare parts for 499334				
	Part No.	521026	Ref. No.	—
	pump cover gasket ID ø 182.5mm thickness 5x4.5mm			
	Part No.	521028	Ref. No.	—
	pump cover FIR inlet ø 62mm outlet ø 62mm turn direction right ø 215mm ID ø 175mm inner height 40mm			
	Part No.	521277	Ref. No.	929181
	impeller ø 135mm H 39mm pump type Fir 2275 - 3.6HP thread M14L			







1

Part No.	500117	Ref. No.	926150	
description	pump inlet ø 63mm outlet ø 47mm type 4225.22725 230/400V 50Hz 3 phase 1.4kW 2HP L 280mm rotation direction right FIR			
For models:	GLB0049, GLB0050, GLB0051			
spare parts for 500117				
	Part No.	510602	Ref. No.	124002
	impeller ø 110mm H 34mm rotation direction right thread M8L shaft ø 28mm seat ø 12.2mm blades 6			
	Part No.	510693	Ref. No.	141002
	mechanical shaft seal for shaft ø 12mm slide ring ext. ø 24mm slide ring H 15.5mm slide ring int. ø 11mm counter ring mounting ø 24mm height counter ring 8mm counter ring int. ø 13.5mm			
	Part No.	521513	Ref. No.	116002
	pump cover FIR inlet ø 63mm outlet ø 47mm turn direction right ID ø 150mm inner height 32mm			
	Part No.	524416	Ref. No.	—
	pump cover gasket thickness 4x4mm Qty 1 pcs			



1

Part No.	500570	Ref. No.	75175	
description	pump inlet ø 63mm outlet ø 47mm type 422512725 230/400V 50Hz 3 phase 1.1kW 1.5HP L 285mm rotation direction right FIR			
For models:	GLB0045, GLB0047, GLB0048			
spare parts for 500570				
	Part No.	510693	Ref. No.	141002
	mechanical shaft seal for shaft ø 12mm slide ring ext. ø 24mm slide ring H 15.5mm slide ring int. ø 11mm counter ring mounting ø 24mm height counter ring 8mm counter ring int. ø 13.5mm			
	Part No.	521082	Ref. No.	80881
	impeller ø 96mm H 32mm rotation direction right thread M8L			
	Part No.	521513	Ref. No.	116002
	pump cover FIR inlet ø 63mm outlet ø 47mm turn direction right ID ø 150mm inner height 32mm			
	Part No.	524416	Ref. No.	—
	pump cover gasket thickness 4x4mm Qty 1 pcs			



1

Part No.	499283	Ref. No.	75175HZ	
description	pump inlet ø 63mm outlet ø 47mm type 422512760 230/400V 60Hz 3 phase 1.1kW L 290mm rotation direction right FIR			
For models:	GLB0047			



1

Part No.	501540	Ref. No.	929123
description	pump inlet \varnothing 63mm outlet \varnothing 47mm type 422522726 230/400V 50Hz 3 phase 1.4kW 2HP L 280mm rotation direction right FIR		
For models:	GLB0041		
spare parts for	501540		
	Part No.	510602	Ref. No. 124002
	impeller \varnothing 110mm H 34mm rotation direction right thread M8L shaft \varnothing 28mm seat \varnothing 12.2mm blades 6		
	Part No.	510693	Ref. No. 141002
	mechanical shaft seal for shaft \varnothing 12mm slide ring ext. \varnothing 24mm slide ring H 15.5mm slide ring int. \varnothing 11mm counter ring mounting \varnothing 24mm height counter ring 8mm counter ring int. \varnothing 13.5mm		
	Part No.	521513	Ref. No. 116002
	pump cover FIR inlet \varnothing 63mm outlet \varnothing 47mm turn direction right ID \varnothing 150mm inner height 32mm		
	Part No.	524416	Ref. No. —
	pump cover gasket thickness 4x4mm Qty 1 pcs		



HANNING pumps



1

Part No.	499166	Ref. No.	12024233
description	pump inlet \varnothing 28mm outlet \varnothing 26mm type UP60-414 220-240V 50/60Hz 1 phase 0.25kW L 190mm rotation direction right capacitor 5 μ F HANNING p max 1bar Qmax. 150l/min		
For models:	GLB0067-F, GLB0069-F, GLB0071-F, GLB0080, GLB0081, GLB0082		
spare parts for	499166		
	Part No.	365017	Ref. No. 206010
	operating capacitor capacity 5 μ F 450V tolerance 5% 50/60Hz ambient temperature max. -25 to +85°C \varnothing 28mm L 54mm M8 plastic connection male faston 6.3mm 16.10.08 protection		

spare parts for 499166

	Part No.	507558	Ref. No.	—
	mechanical shaft seal for shaft \varnothing 7mm height counter ring 5mm ID \varnothing 6.75mm ED \varnothing 20mm mounting \varnothing counter ring 18.5/slide ring 20mm			
	Part No.	532644	Ref. No.	—
	O-ring EPDM thickness 3mm ID \varnothing 78mm Qty 1 pcs			

INSERT STAR pumps



1

Part No.	501562	Ref. No.	12043287
description	pump inlet \varnothing 38mm outlet \varnothing 38mm type 2/123 FA-22 230V 50Hz 1 phase 0.59kW 0.8HP rotation direction right capacitor 10 μ F INSERT-STAR		
For models:	GLB0067-F, GLB0069-F, GLB0071-F, GLB0080, GLB0081		

LGB

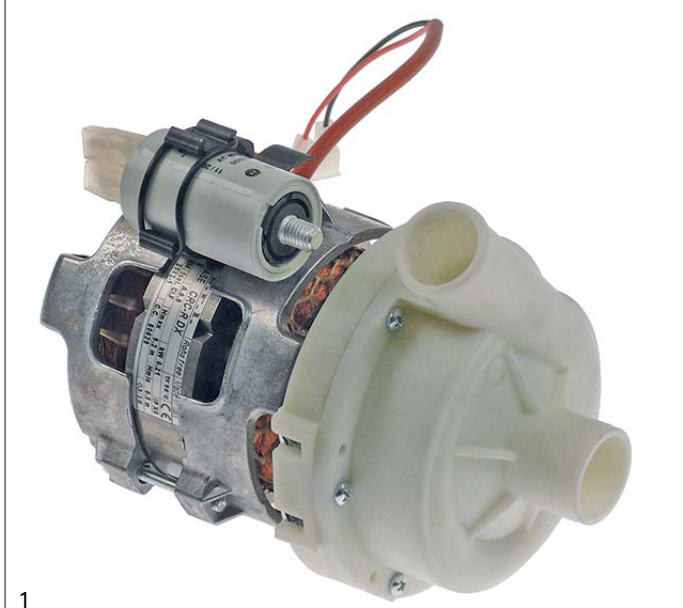

1





Part No.	501526	Ref. No.	80629
description	pump inlet \varnothing 28mm outlet \varnothing 26mm type CRC-R DX 230V 60Hz 1 phase 0.21kW L 175mm rotation direction left capacitor 4 μ F LGB		
For models:	GLB0043C-60Hz		
spare parts for	501526		
	Part No.	365031	Ref. No. —
	operating capacitor capacity 4 μ F 450V tolerance 5% 50/60Hz ambient temperature max. -25 to +85°C \varnothing 31mm L 58mm M8 plastic connection male faston 6.3mm protection		
	Part No.	509002	Ref. No. —
	O-ring EPDM thickness 2.62mm ID \varnothing 82.22mm Qty 1 pcs		



Table continues overleaf



spare parts for		501526	
	Part No.	510703	Ref. No. —
mechanical shaft seal for shaft \varnothing 13mm slide ring H 13mm height counter ring 5.5mm ED \varnothing 26mm			
	Part No.	521091	Ref. No. —
pump cover LGB inlet \varnothing 28mm outlet \varnothing 26mm pump type CRC-R DX			
	Part No.	521092	Ref. No. —
impeller \varnothing 80mm H 25mm pump type CRC-R DX thread M6R shaft \varnothing 13mm shaft length 20mm			







1

Part No.	499282	Ref. No.	77553
description	pump inlet \varnothing 60mm outlet \varnothing 49mm type ZF400VSX 220-230/380-400V 50Hz 3 phase 0.7kW L 270mm rotation direction right LGB		
For models:	GLB0048, GLB0050, GLB0051		
spare parts for	499282		
	Part No.	502279	Ref. No. —
impeller H 31mm ED \varnothing 100mm blades 6			
	Part No.	510702	Ref. No. —
mechanical shaft seal height counter ring 5.5mm ID \varnothing 12mm			
	Part No.	510709	Ref. No. 926255
mechanical shaft seal			
	Part No.	521058	Ref. No. —
fanwheel cover suitable for LGB ID \varnothing 138mm ED \varnothing 142mm H 59mm plastic			
	Part No.	521547	Ref. No. 116013
pump cover LGB inlet \varnothing 60mm outlet \varnothing 50mm supporting pressure M8 turn direction right \varnothing 160mm ID \varnothing 127mm inner height 36mm			
	Part No.	532623	Ref. No. —
O-ring EPDM thickness 2.62mm ID \varnothing 120.32mm Qty 1 pcs			



1

Part No.	500360	Ref. No.	80114
description	pump inlet \varnothing 62mm outlet \varnothing 50mm type ZF522SX 230V 50Hz 1 phase 1.1kW 1.5HP L 220mm rotation direction right capacitor 16 μ F LGB		
For models:	GLB0040		
spare parts for	500360		
	Part No.	365021	Ref. No. —
operating capacitor capacity 16 μ F 425V tolerance 5% 50/60Hz ambient temperature max. -25 to +85°C \varnothing 35mm L 73mm single M8 plastic connection male faston 6.3mm 416.10.99 protection			
	Part No.	510551	Ref. No. 456023 926084
pump cover gasket ID \varnothing 158.3mm pump type 1214/1293/1225/2243/1226/1204/3473/1241 thickness 3.53mm EPDM Qty 1 pcs			
	Part No.	510693	Ref. No. 141002
mechanical shaft seal for shaft \varnothing 12mm slide ring ext. \varnothing 24mm slide ring H 15.5mm slide ring int. \varnothing 11mm counter ring mounting \varnothing 24mm height counter ring 8mm counter ring int. \varnothing 13.5mm			
	Part No.	521280	Ref. No. —
impeller \varnothing 107mm H 26mm thread M8L shaft \varnothing 20mm shaft length 15mm seat \varnothing 8.2mm blades 6			
	Part No.	521536	Ref. No. 926086
pump cover ALBA / LGB inlet \varnothing 62mm outlet \varnothing 50mm auxiliary pressure connection 12mm supporting pressure closed turn direction right \varnothing 180mm ID \varnothing 150mm inner height 38mm			

booster pumps I

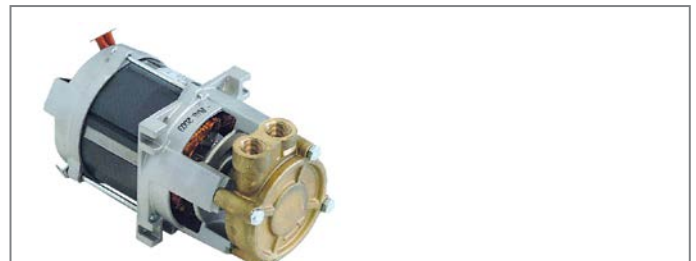

1

Part No.	500358	Ref. No.	130120
description	pump inlet \varnothing 3/8" outlet \varnothing 3/8" type PS46 230V 50Hz 0.45kW \varnothing 100mm L 200mm capacitor 10 μ F LGB		
For models:	GLB0043C		
spare parts for	500358		
	Part No.	510713	Ref. No. —
slide ring for shaft \varnothing 12mm ED \varnothing 24mm H 16mm			

Table continues overleaf



spare parts for 500358	
	Part No. 510723 Ref. No. — counter ring H 8mm ED ø 26mm ID ø 13.5mm for mechanical shaft seal
	Part No. 698400 Ref. No. — pump cover gasket pump type PS46 thickness 2mm ID ø 66mm Qty 1 pcs
accessories for 500358	
	Part No. 365015 Ref. No. 12024376 206002 operating capacitor capacity 10µF 400V tolerance 5%Hz ambient temperature max. -25 to +85°C ø 35.5mm L 59mm M8 plastic connection male faston 6.3mm protection
	Part No. 511279 Ref. No. — hose connector brass straight thread 3/8" hose ø 12mm Qty 1 pcs
	Part No. 520202 Ref. No. 927015 hose connector nickel-plated brass straight thread 3/8" hose ø 12mm Qty 1 pcs
	Part No. 520677 Ref. No. — hose connector brass straight thread 3/8" hose ø 13mm Qty 1 pcs

	
1	
Part No.	499073 Ref. No. 12024708
description	pump inlet ø 31 outlet ø 27 type 887084885 230V 50Hz 0.75kW L 146mm capacitor 2.5µF NIDEC
For models:	AIC0037-F, AIC0038-F, AIC0039-F, AIC0040-F, AIC0041-F, AIC0042-F

drain pumps

HANNING

	
1	
Part No.	501561 Ref. No. 12094265
description	drain pump 38W 200-240V inlet ø 30mm outlet ø 24mm 50/60Hz type DP25R-396 HANNING
For models:	GLB0069-F, GLB0081

	
1	
Part No.	501595 Ref. No. 12039546
description	drain pump 38W 200-240V inlet ø 30mm outlet ø 24mm 50-60Hz type DPS25R-391 HANNING max. 15min input current 0.4A
For models:	AIC0037-F, AIC0038-F, AIC0039-F, AIC0040-F, AIC0041-F, AIC0042-F, AIC0043-F, AIC0044-F, AIC0045-F, AIC0046-F

	
1	
Part No.	500363 Ref. No. 80117
description	drain pump 40W 230V
For models:	GLB0040

	
1	
Part No.	500737 Ref. No. 12023456
description	drain pump 95W 230V inlet ø 24mm outlet ø 24mm 50Hz type BE38B5-017 HANNING
For models:	GLB0071-F, GLB0080



booster pumps II

accessories

1 

Part No.	365015	Ref. No.	12024376 206002
description	operating capacitor capacity 10µF 400V tolerance 5%Hz ambient temperature max. -25 to +85°C ø 35.5mm L 59mm M8 plastic connection male faston 6.3mm protection		
For models:	GLB0043C, GLB0044C, GLB0067-F, GLB0069-F, GLB0071-F, GLB0080, GLB0081, GLB0082		

1 

Part No.	365017	Ref. No.	206010
description	operating capacitor capacity 5µF 450V tolerance 5% 50/60Hz ambient temperature max. -25 to +85°C ø 28mm L 54mm M8 plastic connection male faston 6.3mm 16.10.08 protection		
For models:	GLB0040, GLB0041, GLB0042		

accessories

pump covers

1 

Part No.	521563	Ref. No.	929191
description	pump cover		
For models:	GLB0043C, GLB0043C-60Hz, GLB0044C		

pump cover gaskets

1 

Part No.	524535	Ref. No.	929180
description	pump cover gasket thickness 4.5x4.5mm ID ø 182mm Qty 1 pcs		
For models:	GLB0043C, GLB0043C-60Hz, GLB0044C		

condensators & interference suppression filters

operating capacitors

plastic

1 

Part No.	365015	Ref. No.	12024376 206002
description	operating capacitor capacity 10µF 400V tolerance 5%Hz ambient temperature max. -25 to +85°C ø 35.5mm L 59mm M8 plastic connection male faston 6.3mm protection		
For models:	GLB0043C, GLB0044C, GLB0067-F, GLB0069-F, GLB0071-F, GLB0080, GLB0081, GLB0082		

1 

Part No.	365019	Ref. No.	206005
description	operating capacitor capacity 20µF 400V tolerance 5% 50/60Hz ambient temperature max. -25 to +85°C ø 39.5mm L 70mm M8 plastic connection male faston 6.3mm 16.10.25. protection		
For models:	GLB0040, GLB0047, GLB0048		

1 

Part No.	365226	Ref. No.	12025135
description	operating capacitor capacity 3µF 450V with plastic sheathing tolerance 5% 50/60Hz ø 34mm L 64mm		
For models:	AIC0037-F, AIC0038-F, AIC0039-F, AIC0040-F, AIC0041-F, AIC0042-F		

1 

Part No.	365017	Ref. No.	206010
description	operating capacitor capacity 5µF 450V tolerance 5% 50/60Hz ambient temperature max. -25 to +85°C ø 28mm L 54mm M8 plastic connection male faston 6.3mm 16.10.08 protection		
For models:	GLB0040, GLB0041, GLB0042		



filters

interference suppression filters



1

Part No.	365221	Ref. No.	661.120.00
description	interference suppression filter 250V 50/60Hz connection 5 male faston 6.3mm M8 plastic capacity 0,22µF(X2)+2x2mH +2X2,5nF(Y2)+-1M0hmµF		
For models:	VS7080PG50, VS7080PGI50, VS9080PGI150		



1

Part No.	358760	Ref. No.	926283
description	fine fuse size ø6.3x32mm 0.315A medium lag rated 250V Qty 10 pcs		
For models:	GLB0040, GLB0041, GLB0042, GLB0043C, GLB0044C, GLB0045, GLB0047, GLB0048		

fine fuse holders



1

Part No.	550536	Ref. No.	12025158
description	fuse holder suitable fuse ø10x38mm 30A rated 600V		
For models:	AIC0037-F, AIC0038-F, AIC0039-F, AIC0040-F, AIC0041-F, AIC0042-F, AIC0043-F, AIC0045-F, AIC0071-F, AIC0072-F, AIC0073-F, AIC0074-F, AIC0075-F, AIC0076-F, AIC0077-F, AIC0078-F, AIC0079-F, AIC0080-F, GLB0071-F, GLB0080, GLB0082		



1

Part No.	550499	Ref. No.	H.228047
description	fuse holder suitable fuse ø5x20mm 6.3A rated 500V		
For models:	GLB0040, GLB0041, GLB0042, GLB0043C, GLB0044C, GLB0047, GLB0048, GLB0049		



1

Part No.	550519	Ref. No.	H.228048
description	cover plate suitable fuseA ratedV connection for fuse holder		
For models:	GLB0040, GLB0041, GLB0042, GLB0043C, GLB0044C, GLB0047, GLB0048		

thermal fuses



1

Part No.	358193	Ref. No.	663.078.00
description	thermal fuse switch-off temp. 110°C		
For models:	VS7080TPET, VS7080TPFE		



1

Part No.	358190	Ref. No.	663.077.00
description	thermal fuse switch-off temp. 98°C		
For models:	VS9080TPET, VS9080TPFE		

fuses

fine fuses



1

Part No.	358530	Ref. No.	926284
description	fine fuse size ø5x20mm 0.8A fast-acting rated 250V Qty 10 pcs		
For models:	GLB0040, GLB0041, GLB0042, GLB0043C, GLB0044C, GLB0045, GLB0047, GLB0048		



1

Part No.	358677	Ref. No.	228004
description	fine fuse size ø5x20mm 4A fast-acting rated 250V Qty 10 pcs		
For models:	GLB0040, GLB0041, GLB0042, GLB0043C, GLB0043C-60Hz, GLB0044C, GLB0047, GLB0048		



1

Part No.	358594	Ref. No.	228012
description	fine fuse size ø5x20mm 0.16A slow-acting rated 250V Qty 10 pcs		
For models:	GLB0043C-60Hz, GLB0047		



1

Part No.	358603	Ref. No.	228011
description	fine fuse size ø5x20mm 2A slow-acting rated 250V Qty 10 pcs		
For models:	GLB0043C-60Hz, GLB0047		



electric accessories

cables

power supply cables



1			
Part No.	551265	Ref. No.	B00FK100
description	supply cord CEE7/7 type E+F 3-pole contacts P+N+E 1.5mm ² max. 16A max 230V 2m H05VVF insulation PVC countries D/F/B/I black		
For models:	BMA0008-F, BMA0010-F, BMA0021-F, BMA0022-F, BMA0024-F, BMA0025-F, BMA0026-F, BMA0027-F, BMA0028-F, BMA0029-F, BMA0032-F, BMA0035-F, BMA0036-F, BMB0028-F, BMB0029-F, BMB0030-F, BMB0033-F, BMB0034-F, BMB0035-F, BMB0036-F, BMB0037-F, BMC0012-F, BMC0014-F, BMC0015-F, BMC0016-F, BNA0030-F, BNA0031-F, BNA0036-F, BNA0037-F, BNA0044-F, BNA0045-F, BNA0052-F, BNA0053-F, BNA0054-F, BNA0055-F, BNA0056-F, BNA0057-F, BNA0064-F, BNA0065-F, BNA0066-F, BNB0010-F, BNB0011-F, BNB0012-F, BNB0013-F, BNB0014-F, BNB0015-F, BNZ0001-F, BNZ0002-F, BNZ0003-F, BNZ0004-F... (Other models you can see in the webshop)		

accessories

cable glands

threaded cable glands

screw connections



1			
Part No.	550971	Ref. No.	12009963
description	cable gland thread PG16 cable ø 14mm mounting ø 22.5mm Qty 1 pcs plastic WS 27		
For models:	AIC0037-F, AIC0071-F		

fastening nuts



1			
Part No.	550974	Ref. No.	12010063
description	nut thread PG21 WS 34 plastic Qty 1 pcs thickness 7.5mm mounting ømm cable ømm		
For models:	AIC0037-F, AIC0039-F, AIC0072-F		

ribbon cables

group 1



1			
Part No.	402970	Ref. No.	41523
description	ribbon cable 10-pole L 1200mm plug type 2 row coded Qty 1m		
For models:	GLB0041, GLB0042, GLB0043C, GLB0044C, GLB0045, GLB0047, GLB0048		

1			
Part No.	403250	Ref. No.	926272
description	ribbon cable 10-pole L 3000mm plug type coded 2 row plug: number of poles 10		
For models:	GLB0040		

1			
Part No.	400902	Ref. No.	80934
description	ribbon cable 10-pole L 750mm plug type FC-10P raster size 2.54mm		
For models:	GLB0043C-60Hz, GLB0047		

terminals

connection terminals with screw/faston connections



1			
Part No.	505212	Ref. No.	12024110
description	power terminal block 2-pole max. 20A max 600V connection ø2.5mm ² / F6.3 temp.-resist. 150°C cross section 4mm ²		
For models:	GLB0067-F, GLB0069-F, GLB0081		



1			
Part No.	550278	Ref. No.	M566050000
description	power terminal block 3-pole max. 40A max 400V connection ø6mm ² / F6.3 temp.-resist. 150°C cross section 6mm ²		
For models:	VS7040BMET, VS7040BMFEP, VS7040CPES, VS7040FRG17VL, VS-7040SPET, VS7080CPES, VS7080FRG17VL, VS9040BMET, VS9040BMFEP, VS9040CPES, VS9040FRG17VL, VS9040FRG21VL, VS9040SPET, VS9080CPES, VS9080FRG17VL, VS9080FRG21VL		



1			
Part No.	550411	Ref. No.	12025183 220011 M566050500
description	power terminal block 6-pole max. 40A max 450V connection ø6mm ² / F6.3 temp.-resist. 150°C cross section 6mm ²		
For models:	GLB0040, GLB0041, GLB0042, GLB0043C, GLB0043C-60Hz, GLB0044C, GLB0067-F, GLB0069-F, GLB0081, V080FTREVCRT, V7040FTREVCRT, V9040FTREVCRT, V9080FTREVCRT, V9080FTRRECR, VS70120CFGE, VS7040FRE17X, VS7040FRE88, VS7040FTET, VS7040FTEVCRT, VS7040FTEVT, VS7040FTRET, VS7040FTREVT, VS7040GRACQE, VS7040PCEQT, VS7040PCET, VS7080BMET, VS7080BMFEP, VS7080CFE, VS7080CFEQ, VS7080CFGE, VS7080CFVE, VS7080FTET, VS7080FTEVCRT, VS7080FTEVT, VS7080FTRET, VS7080FTREVT, VS7080FTRRET, VS7080FTRREVC, VS7080FTRREVT, VS7080GRACQE, VS7080PCEQT, VS7080PCET, VS7080PVET, VS7080TPET, VS7080TPFE, VS90120CFGE, VS90160CFGE, VS9040FRE17, VS9040FRE21, VS9040FRE88... (Other models you can see in the webshop)		



connection terminals with screw connection



1

Part No.	551402	Ref. No.	463.026.00
description	power terminal block 3-pole max. 40A max 450V connection M5 temp.-resist. 150°C		
For models:	VS7080BRGI, VS7080BRGIM, VS7080PG50, VS7080PGI50, VS9080BRGI, VS9080BRGIM, VS9080PGI150		



1

Part No.	550507	Ref. No.	663.036.00
description	power terminal block 4-pole max. 40A max 400V connection M6/M6 temp.-resist. 150°C		
For models:	VS7040CPES, VS7080CPES		



1

Part No.	550355	Ref. No.	963.007.00
description	power terminal block 6-pole max. 40A max 400V connection M6/M6 temp.-resist. 150°C cross section 6mm ² hole distance 122mm		
For models:	VS7040FRE10, VS7080BREI, VS7080BREIM, VS7080CFVE, VS7080FRE10, VS7080PVET, VS9040FRE15, VS9040INDT, VS9040INDWT, VS9040PVET, VS9080BREI, VS9080BREIM, VS9080CFVE, VS9080FRE15, VS9080INDT, VS9080PVET		

rail-mounted terminals

SIEMENS

feed-through terminals



1

Part No.	551238	Ref. No.	663.061.00
description	rail-mounted terminal 16mm ² beige 1-pole		
For models:	VS7040PCEQT, VS7040PCET, VS7080FRE17X, VS7080PCEQT, VS7080PCET, VS9040PCEST, VS9080FRE17, VS9080FRE21, VS9080PCEST		



1

Part No.	551420	Ref. No.	663.059.00
description	rail-mounted terminal 16mm ² beige for grill		
For models:	VS7040PCEQT, VS7040PCET, VS7080FRE17X, VS7080PCEQT, VS7080PCET, VS7080PEI50, VS9040PCEST, VS9080FRE17, VS9080FRE21, VS9080PCEST, VS9080PEI50		



1

Part No.	551431	Ref. No.	663.076.00
description	rail-mounted terminal SIEMENS 16mm ² blue H 46mm W 41mm L 10mm		
For models:	VS7040PCEQT, VS7040PCET, VS7080FRE17X, VS7080PCEQT, VS7080PCET, VS9040PCEST, VS9080FRE17, VS9080FRE21, VS9080PCEST		



1

Part No.	551396	Ref. No.	663.060.00
description	rail-mounted terminal SIEMENS type 8WA1011-1PK00 16mm ² yellow/green for DIN rail 35mm H 40mm W 10mm L 53mm		
For models:	VS7040PCEQT, VS7040PCET, VS7080FRE17X, VS7080PCEQT, VS7080PCET, VS9040PCEST, VS9080FRE17, VS9080FRE21, VS9080PCEST		

WEIDMÜLLER

feed-through terminals





1

Part No.	551230	Ref. No.	12024942
description	rail-mounted terminal 70mm ² for DIN rail 35mm grey 1-pole		
For models:	AIC0045-F, AIC0075-F		





accessories			
			
1			
Part No.	550789	Ref. No.	12024199
description	rail-mounted terminal grey for DIN rail 35mm		
For models:	AIC0038-F, AIC0040-F, AIC0042-F, AIC0044-F, AIC0046-F, AIC0076-F, AIC0077-F, AIC0078-F, AIC0079-F, AIC0080-F, GLB0071-F, GLB0080, GLB0082		

WIELAND			
rail-mounted terminals type 9700A			
			
1			
Part No.	550381	Ref. No.	12023373
description	rail-mounted terminal WIELAND type 9700A/8 S35 1.0-10mm ² top-hat rail 35mm grey W 8mm L 46.6mm		
For models:	AIC0037-F, AIC0071-F, GLB0071-F, GLB0080, GLB0082		

miscellaneous			
			
1			
Part No.	550996	Ref. No.	927115
description	rail-mounted terminal 0.5-4mm ² green/yellow for TS 35 (plastic)		
For models:	GLB0049		

accessories universal			
connection bridges			
			
1			
Part No.	551457	Ref. No.	663.056.00
description	connection bridge for rail-mounted terminal		
For models:	VS7040PCEQT, VS7040PCET, VS7080FRE17X, VS7080PCEQT, VS7080PCET, VS9040PCEST, VS9080FRE17, VS9080FRE21, VS9080PCEST		

DIN rails			
			
1			
Part No.	551018	Ref. No.	12022528
description	DIN rail W 35mm L 72mm hole distance 52mm		
For models:	AIC0037-F, AIC0039-F, AIC0071-F, AIC0072-F		

gas taps			
PEL			
21S series			
			
1			
Part No.	103342	Ref. No.	671.090.00
description	flange PEL type 21S with plug tube ø 21mm		
For models:	V70120TPPCFG2, V70120TPPCG2T, V90120TPPCFG2, V90120TPPCG2T, VS7080TPPCFG, VS7080TPPCGT, VS9080TPPCFG, VS9080TPPCGT		



			
1			
Part No.	109515	Ref. No.	671.088.00
description	gas tap PEL type 21S gas inlet pipe flange ø21mm bypass nozzle ø 0mm gas outlet M16x1.5 (tube ø 10/8mm) thermocouple connection M8x1 pilot connection M10x1 shaft ø 8x6.5mm shaft L 22/15mm shaft flat upper		
For models:	V70120TPPCFG2, V70120TPPCG2T, V7040FTRGVCRT, V7080FTRGVCRT, V90120TPPCFG2, V90120TPPCG2T, V9040FTRGVCRT, V9080FTRGVCRT, V9080FTRRGCR, VS70120CFG, VS70120CFGE, VS70120CFGG, VS70120PCGT, VS70120TPFG, VS7040CPGS, VS7040FTGT, VS7040FTGVCRT, VS7040FTGVT, VS7040FTRGT, VS7040FTRGVT, VS7040GRL, VS7040PCGT, VS7080CFG, VS7080CFGE, VS7080CPGS, VS7080FTGT, VS7080FTGVCRT, VS7080FTGVT, VS7080FTRGT, VS7080FTRGVT, VS7080GRL, VS7080PCGT, VS7080TPPCFG, VS7080TPPCGT, VS90120CFGE, VS90120CFGG, VS90120PCGP, VS90120PCGT, VS90160CFG, VS90160CFGE, VS9040CPGS, VS9040FTGVCRT, VS9040FTGT, VS9040FTGVCRT, VS9040FTGVT, VS9040FTRGCR...(Other models you can see in the webshop)		
spare parts for	109515		
			
Part No.	101060	Ref. No.	—
description	magnet unit standard L 39mm D1 ø 15.4mm D2 ø 11mm suitable for PEL20-21/JUNKERS/EGA		
			
Part No.	101206	Ref. No.	—
description	gas tap front part shaft ø 8x6.5mm shaft L 22/15mm shaft flat upper/lower suitable for PEL21		

Table continues overleaf





spare parts for		109515	
	Part No.	101230	Ref. No. —
thermocouple nut T1: M8x1 T2: M18x1 aluminium			
accessories for		109515	
	Part No.	100908	Ref. No. —
union screw thread M10x1 for pipe ø 4mm Qty 1 pcs			
	Part No.	100909	Ref. No. —
union screw thread M10x1 for pipe ø 6mm Qty 1 pcs			
	Part No.	101246	Ref. No. —
olive for pipe ø 4mm Qty 1 pcs			
	Part No.	101278	Ref. No. —
olive for pipe ø 10mm Qty 1 pcs			
	Part No.	101286	Ref. No. —
olive ID ø 6mm Qty 1 pcs			
	Part No.	101300	Ref. No. —
union nut thread M16x1.5 tube ø 10mm			
	Part No.	101450	Ref. No. —
olive for pipe ø 8mm L 12.7mm Qty 1 pcs ED ø 10mm			
	Part No.	101451	Ref. No. —
union nut thread M16x1.5 tube ø 8mm			
	Part No.	110078	Ref. No. —
knob without symbol ø 70mm shaft ø 6x4.6mm shaft flat universal			
	Part No.	112206	Ref. No. —
knob dial plate silver gas tap PEL21/22/23 t.max.°C ED ø 63mm ID ø 45.5mm			

22S/O series



1

Part No.	101086	Ref. No.	671.031.00
description	gas tap PEL type 22S/O gas inlet M20x1.5 (tube ø 12mm) bypass nozzle ø 0.35mm gas outlet M20x1.5 (tube ø 12/10mm) thermocouple connection M9x1 pilot connection M10x1 shaft ø 10x8mm shaft L 25/17mm shaft flat lower		
For models:	VS70120TPFG, VS7040GRACQG, VS7080GRACQG, VS7080TPFG, VS7080TPGT, VS90120TPFG, VS9040GRACQG, VS9080GRACQG, VS9080TPFG, VS9080TPGT		
spare parts for		101086	
	Part No.	100259	Ref. No. —
bypass nozzle type PEL22 bore ø 0.35mm thread M6x0.5			
	Part No.	101058	Ref. No. —
magnet unit L 39mm D1 ø 15.4mm D2 ø 13.5mm suitable for PEL22/EGA24197 standard			
	Part No.	101201	Ref. No. —
gas tap front part shaft ø 10x8mm shaft L 25/17mm shaft flat upper/lower suitable for PEL22			

spare parts for		101086	
	Part No.	101231	Ref. No. —
thermocouple nut T1: M9x1 T2: M18x1			
	Part No.	101240	Ref. No. —
gas connection thread M20x1.5 tube ø 12/10mm for PEL gas taps with gasket and screws horizontal			
	Part No.	101460	Ref. No. —
O-ring ø 12.37mm D1 ø 2.62mm suitable for PEL22			
	Part No.	101461	Ref. No. —
screw kit suitable for PEL22 Qty 4 pcs			
accessories for		101086	
	Part No.	100908	Ref. No. —
union screw thread M10x1 for pipe ø 4mm Qty 1 pcs			
	Part No.	100909	Ref. No. —
union screw thread M10x1 for pipe ø 6mm Qty 1 pcs			
	Part No.	101241	Ref. No. —
gas connection thread M20x1.5 tube ø 12/10mm for PEL gas taps vertical			
	Part No.	101246	Ref. No. —
olive for pipe ø 4mm Qty 1 pcs			
	Part No.	101248	Ref. No. —
olive for pipe ø 12mm Qty 1 pcs suitable for PEL			
	Part No.	101249	Ref. No. —
olive for pipe ø 10mm Qty 1 pcs			
	Part No.	101250	Ref. No. —
union nut thread M20x1.5 for pipe ø 10mm			
	Part No.	101251	Ref. No. —
union nut thread M20x1.5 for pipe ø 12mm			
	Part No.	101286	Ref. No. —
olive ID ø 6mm Qty 1 pcs			
	Part No.	110080	Ref. No. —
knob ø 70mm shaft ø 10x8mm shaft flat universal			
	Part No.	112206	Ref. No. —
knob dial plate silver gas tap PEL21/22/23 t.max.°C ED ø 63mm ID ø 45.5mm			



gas thermostats

SIT

630 Eurosit series



Part No.	107688	Ref. No.	256.277.00
description	gas thermostat 100-340°C gas inlet 3/8" gas outlet 3/8" thermocouple connection M9x1 pilot connection M10x1 probe ø 4mm probe L 72mm capillary pipe 1050mm		
For models:	V70120TPPCFG2, V90120TPPCFG2, VS70120CFG, VS70120CFGG, VS70120TPFG, VS7080CFG, VS7080TPFG, VS7080TPPCFG, VS90120CFG, VS90120CFGG, VS90120TPFG, VS90160CFG, VS9080CFG, VS9080TPFG, VS9080TPPCFG		

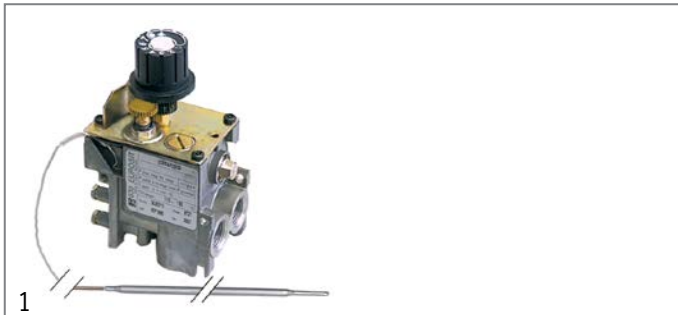



Part No.	103076	Ref. No.	256.408.00
description	gas thermostat type 630 Eurosit series t.max. 190°C 110-190°C gas inlet 3/8" gas outlet 3/8" thermocouple connection M9x1 pilot connection M10x1 probe ø 4mm probe L 202mm capillary pipe 1050mm SIT		
For models:	VS7040FRGS13, VS7080FRGS13, VS9040FRGS13, VS9040FRGS20, VS9080FRGS13, VS9080FRGS20		

PEL

25ST series



Part No.	101441	Ref. No.	971.000.00
description	gas thermostat PEL type 25ST 30-90°C gas inlet M16x1.5 (tube ø 10mm) bypass nozzle ø 0.35mm gas outlet M16x1.5 (tube ø 10/8mm) thermocouple connection M9x1 pilot connection M10x1 capillary pipe 1200mm probe ø 6mm probe L 160mm shaft ø 8x6.5mm shaft L 21/15mm shaft flat upper		
For models:	VS7040BMGT, VS7080BMGT, VS9040BMGT, VS9080BMGT		

spare parts for	101441		
	Part No.	100259	Ref. No. —
	bypass nozzle type PEL22 bore ø 0.35mm thread M6x0.5		
	Part No.	101060	Ref. No. —
	magnet unit standard L 39mm D1 ø 15.4mm D2 ø 11mm suitable for PEL20-21/JUNKERS/EGA		

spare parts for	101441		
	Part No.	106200	Ref. No. —
	nut thread M9x1 suitable for PEL 24/25S		
accessories for	101441		
	Part No.	100908	Ref. No. —
	union screw thread M10x1 for pipe ø 4mm Qty 1 pcs		
	Part No.	100909	Ref. No. —
	union screw thread M10x1 for pipe ø 6mm Qty 1 pcs		
	Part No.	101246	Ref. No. —
	olive for pipe ø 4mm Qty 1 pcs		
	Part No.	101278	Ref. No. —
	olive for pipe ø 10mm Qty 1 pcs		
	Part No.	101286	Ref. No. —
	olive ID ø 6mm Qty 1 pcs		
	Part No.	101300	Ref. No. —
	union nut thread M16x1.5 tube ø 10mm		
	Part No.	101450	Ref. No. —
	olive for pipe ø 8mm L 12.7mm Qty 1 pcs ED ø 10mm		
	Part No.	101451	Ref. No. —
	union nut thread M16x1.5 tube ø 8mm		

gas valves and ignition boxes

gas control valves

SIT

NOVASIT













Part No.	101908	Ref. No.	256.331.00 256.335.00
description	gas valve SIT series Novasit 820 230V 50Hz gas inlet 1/2" gas outlet 1/2" thermocouple connection M9x1 pilot connection M10x1 ignition pressurebar pressure regulator connection blind equiv. no. 0.820.018 output pilot burner M10x1 input pressure max. 60bar setting range 3-30bar		
For models:	VS7040FRG17VL, VS7080BRGI, VS7080BRGIM, VS7080FRG17VL, VS7080PG50, VS7080PGI50, VS9040FRG17VL, VS9040FRG21VL, VS9080BRGI, VS9080BRGIM, VS9080FRG17VL, VS9080FRG21VL, VS9080PGI150		
spare parts for	101908		
	Part No.	101065	Ref. No. —
	magnet unit with cable L 44mm D1 ø 30mm D2 ø 20mm suitable for NOVASIT		

Table continues overleaf



spare parts for		101908	
	Part No.	101313	Ref. No. —
	solenoid coil 230V 50Hz		
accessories for		101908	
	Part No.	100006	Ref. No. —
	piezoelectric igniter suitable for ELETTROSIT body plastic blowing connection \varnothing 2.4mm \varnothing 14mm		
	Part No.	101305	Ref. No. —
	gas connection straight 1/2" flange 45x45mm ELETTROSIT/V4400/4600/4605 suitable for SIT/HONEYWELL hole distance 36x36mm		
	Part No.	101306	Ref. No. —
	gas connection angled flange 45x45mm hole distance 36x36mm 1/2" ELETTROSIT/V4400/4600/4605 screw with O-ring suitable for SIT/HONEYWELL		
	Part No.	101307	Ref. No. —
	gas connection straight flange 45x45mm hole distance 36x36mm 3/4" ELETTROSIT/V4400/4600/4605 screw with O-ring suitable for SIT/HONEYWELL		
	Part No.	101308	Ref. No. —
	gas connection angled flange 45x45mm hole distance 36x36mm 3/4" ELETTROSIT/V4400/4600/4605 screw with O-ring suitable for SIT/HONEYWELL		
	Part No.	101312	Ref. No. 968.501.00
	microswitch		
	Part No.	101314	Ref. No. —
	solenoid coil 24V 50Hz		
	Part No.	101317	Ref. No. —
	plug with cable L 1000mm suitable for NOVASIT		
	Part No.	101318	Ref. No. —
	cover cap for solenoid coil suitable for NOVASIT		

accessories



Part No.	101312	Ref. No.	968.501.00
description	microswitch		
For models:	VS7040FRG17VL, VS7080BRGI, VS7080BRGIM, VS7080FRG17VL, VS7080PG50, VS7080PGI50, VS9040FRG17VL, VS9040FRG21VL, VS9080BRGI, VS9080BRGIM, VS9080FRG17VL, VS9080FRG21VL, VS9080PGI150		

SIGMA



Part No.	107926	Ref. No.	12046364
description	gas valve type 0848160 230V 50Hz gas inlet 3/4" gas outlet 3/4" pressure range 0.5-12mbar SIT equiv. no. 0848160		
For models:	AIC0038-F, AIC0040-F, AIC0042-F, AIC0044-F, AIC0046-F, AIC0076-F, AIC0077-F, AIC0078-F, AIC0079-F, AIC0080-F		

ignition parts

pilot burners

SIT



100 series





Part No.	106901	Ref. No.	672.080.00
description	pilot burner SIT type 100 series 1 flame nozzle \varnothing 0.2mm gas connection 6mm		
For models:	V70120TPPCFG2, V70120TPPCG2T, V90120TPPCFG2, V90120TPPCG2T, VS70120CFG, VS70120CFGE, VS70120CFGG, VS70120PCGT, VS70120TPFG, VS7040PCGT, VS7080CFG, VS7080CFGE, VS7080PCGT, VS7080TPPCFG, VS7080TPPCGT, VS90120CFG, VS90120CFGE, VS90120CFGG, VS90120PCGP, VS90120PCGT, VS90160CFG, VS90160CFGE, VS9040PCGT, VS9040PCGT, VS9080CFG, VS9080CFGE, VS9080PCGP, VS9080PCGT, VS9080TPPCFG, VS9080TPPCGT		
spare parts for		106901	
	Part No.	100854	Ref. No. —
	pilot burner bracket double		
	Part No.	100916	Ref. No. —
	compression spring for pilot burner Qty 1 pcs		
	Part No.	100917	Ref. No. —
	gasket for pilot burner Qty 1 pcs aluminium		
	Part No.	100918	Ref. No. —
	screw for pilot burner		
accessories for		106901	
	Part No.	100904	Ref. No. —
	locking screw M10x1 for pipe \varnothing 4mm Qty 1 pcs		
	Part No.	100905	Ref. No. —
	locking screw M10x1 for pipe \varnothing 6mm Qty 1 pcs		















Table continues overleaf



accessories for 106901			
Part No.	102110	Ref. No.	—
	pilot tube copper pipe ø 4mm thickness 1mm L 3000mm		
Part No.	102111	Ref. No.	—
	pilot tube copper pipe ø 6mm thickness 1mm L 3000mm		
Part No.	102742	Ref. No.	—
	pilot burner nozzle LPG code 25 bore ø 0.25mm Qty 1 pcs		

 <p>1</p>			
Part No.	103344	Ref. No.	672.184.00
description	pilot burner SIT type 100 series 3 flames nozzle ø 0.35mm gas connection 4mm		
For models:	VS7040FRGS13, VS7080FRGS13, VS9040FRGS13, VS9040FRGS20, VS9080FRGS13, VS9080FRGS20		
spare parts for 103344			
Part No.	100246	Ref. No.	—
	pilot burner nozzle natural gas bore ø 0.35mm Qty 1 pcs thread M8x0.75		
Part No.	100855	Ref. No.	—
	pilot burner bracket triple		
Part No.	100883	Ref. No.	—
	pilot burner bottom part PRO-GAS 100 series nozzle ø 0.35mm		
Part No.	100885	Ref. No.	—
	air mixing sleeve for pilot burner Qty 1 pcs		
Part No.	100904	Ref. No.	—
	locking screw M10x1 for pipe ø 4mm Qty 1 pcs		
Part No.	102664	Ref. No.	—
	pilot burner cap 3 flames suitable for 100 series H 29mm L 40mm		

 <p>1</p>			
Part No.	106907	Ref. No.	672.057.00
description	pilot burner SIT type 100 series 3 flames nozzle ø 0.35mm gas connection 6mm		
For models:	VS70120TPFG, VS7040GRACQG, VS7080GRACQG, VS7080TPFG, VS7080TPGT, VS90120TPFG, VS9040GRACQG, VS9080GRACQG, VS9080TPFG, VS9080TPGT		
spare parts for 106907			
Part No.	100246	Ref. No.	—
	pilot burner nozzle natural gas bore ø 0.35mm Qty 1 pcs thread M8x0.75		
Part No.	100855	Ref. No.	—
	pilot burner bracket triple		

spare parts for 106907			
Part No.	100885	Ref. No.	—
	air mixing sleeve for pilot burner Qty 1 pcs		
Part No.	100916	Ref. No.	—
	compression spring for pilot burner Qty 1 pcs		
Part No.	100917	Ref. No.	—
	gasket for pilot burner Qty 1 pcs aluminium		
Part No.	100918	Ref. No.	—
	screw for pilot burner		
Part No.	107162	Ref. No.	—
	pilot burner cap SIT 3 flames Hmm Lmm Qty 1 pcs		
Part No.	107702	Ref. No.	—
	pilot burner bottom part SIT 100 series nozzle ø 0.35mm		
accessories for 106907			
Part No.	100245	Ref. No.	—
	pilot burner nozzle LPG code 20 bore ø 0.2mm Qty 1 pcs thread M8x0.75		
Part No.	100904	Ref. No.	—
	locking screw M10x1 for pipe ø 4mm Qty 1 pcs		
Part No.	100905	Ref. No.	—
	locking screw M10x1 for pipe ø 6mm Qty 1 pcs		
Part No.	102110	Ref. No.	—
	pilot tube copper pipe ø 4mm thickness 1mm L 3000mm		
Part No.	102111	Ref. No.	—
	pilot tube copper pipe ø 6mm thickness 1mm L 3000mm		
Part No.	107171	Ref. No.	—
	pilot burner nozzle SIT natural/liquid gas bore ø 0.25mm Qty 1 pcs		
Part No.	107700	Ref. No.	—
	pilot burner bottom part SIT 100 series nozzle ø 0.25mm		
Part No.	107701	Ref. No.	—
	pilot burner bottom part SIT 100 series nozzle ø 0.2mm		

 <p>1</p>			
Part No.	107881	Ref. No.	672.172.00
description	pilot burner SIT type 100 series 3 flames nozzle ø 0.35mm gas connection 6mm with igniter		
For models:	VS7040FRG17VL, VS7080FRG17VL, VS9040FRG17VL, VS9040FRG21VL, VS9080FRG17VL, VS9080FRG21VL		



accessories

ignition electrodes

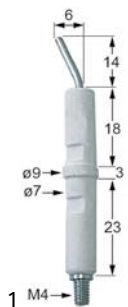





Part No.	100706	Ref. No.	672.060.00
description	ignition electrode connection M4 Qty 1 pcs		
For models:	VS70120TPFG, VS7040FRG17VL, VS7040FRGS13, VS7040GRACQG, VS7080FRG17VL, VS7080FRGS13, VS7080GRACQG, VS7080TPFG, VS7080TPGT, VS90120TPFG, VS9040FRG17VL, VS9040FRG21VL, VS9040FRGS13, VS9040FRGS20, VS9040GRACQG, VS9080FRG17VL, VS9080FRG21VL, VS9080FRGS13, VS9080FRGS20, VS9080GRACQG, VS9080TPFG, VS9080TPGT		

140 - 145 -150 series



Part No.	103357	Ref. No.	256.059.00
description	pilot burner SIT type 140 series 2 flames natural/liquid gas		
For models:	VS70120CFGG, VS7040CPGS, VS7040GRL, VS7080CPGS, VS7080GRL, VS90120CFGG, VS9040CPGS, VS9040GRL, VS9080CPGS, VS9080GRL		
spare parts for	103357		
	Part No.	100205	Ref. No. —
	pilot burner nozzle SIT LPG code 19 bore ø 0.23/0.26mm Qty 1 pcs suitable for SIT 150 series		
	Part No.	100207	Ref. No. —
	pilot burner nozzle SIT natural gas code 27 bore ø 0.40/0.38mm suitable for SIT 140 series		
	Part No.	100897	Ref. No. —
	olive for pipe ø 4mm Qty 1 pcs for pilot burner		
	Part No.	100906	Ref. No. —
	screw connection thread M10x1 for ignition electrode brass Qty 1 pcs WS 10		
	Part No.	100908	Ref. No. —
	union screw thread M10x1 for pipe ø 4mm Qty 1 pcs		
	Part No.	107114	Ref. No. —
	pilot burner SIT type 140 series 2 flames nozzle 6mm gas connectionmm		
accessories for	103357		
	Part No.	100204	Ref. No. —
	pilot burner nozzle SIT LPG code 14 bore ø 0.18/0.20mm Qty 1 pcs suitable for 140 series		
	Part No.	100216	Ref. No. —
	pilot burner nozzle SIT natural gas code 38 bore ø 0.45mm Qty 1 pcs suitable for SIT 150 series		
	Part No.	100701	Ref. No. 256.017.00 256.060.00
	ignition electrode connection M4 Qty 1 pcs		

accessories for	103357		
	Part No.	100801	Ref. No. —
	gasket for pilot burner Qty 1 pcs		
	Part No.	100898	Ref. No. —
	olive for pipe ø 6mm Qty 1 pcs for pilot burner		
	Part No.	100909	Ref. No. —
	union screw thread M10x1 for pipe ø 6mm Qty 1 pcs		
	Part No.	102110	Ref. No. —
	pilot tube copper pipe ø 4mm thickness 1mm L 3000mm		
	Part No.	102111	Ref. No. —
	pilot tube copper pipe ø 6mm thickness 1mm L 3000mm		







	Part No.	107836	Ref. No.	672.173.00
	description	pilot burner SIT type 140 series 2 flames nozzle ø 0.40/0.38mm complete		
For models:	V70120TPPCFG2, V70120TPPCG2T, V7040FTRGVCRT, V7080FTRGVCRT, V90120TPPCFG2, V90120TPPCG2T, V9040FTRGVCRT, V9080FTRGVCRT, V9080FTRRGCR, VS7040BMGT, VS7040FTGT, VS7040FTGVCRT, VS7040FTGVT, VS7040FTRGT, VS7040FTRGVT, VS7080BMGT, VS-7080BRGI, VS7080BRGIM, VS7080FTGT, VS7080FTGVCRT, VS7080FTGVT, VS7080FTRGT, VS7080FTRGVT, VS7080FTRRG, VS7080FTRRGVC, VS7080FTRRGVT, VS7080TPPCFG, VS7080TPPCGT, VS9040BMGT, VS9040FTGCR, VS9040FTGT, VS9040FTGVCRT, VS9040FTGVT, VS9040FTRGCR, VS9040FTRGT, VS9040FTRGVT, VS9080BMGT, VS-9080BRGI, VS9080BRGIM, VS9080FTGCR, VS9080FTGT, VS9080FTGVCRT, VS9080FTGVT, VS9080FTRGCR, VS9080FTRGCR, VS9080FTRGT, VS9080FTRGVT, VS9080FTRRG, VS9080FTRRGVC, VS9080FTRRGVT, VS9080TPPCFG... (Other models you can see in the webshop)			
spare parts for	107836			
	Part No.	100207	Ref. No.	—
	pilot burner nozzle SIT natural gas code 27 bore ø 0.40/0.38mm suitable for SIT 140 series			
	Part No.	100701	Ref. No.	256.017.00 256.060.00
	ignition electrode connection M4 Qty 1 pcs			
	Part No.	100897	Ref. No.	—
	olive for pipe ø 4mm Qty 1 pcs for pilot burner			
	Part No.	100906	Ref. No.	—
	screw connection thread M10x1 for ignition electrode brass Qty 1 pcs WS 10			
	Part No.	100909	Ref. No.	—
	union screw thread M10x1 for pipe ø 6mm Qty 1 pcs			
accessories for	107836			
	Part No.	100801	Ref. No.	—
	gasket for pilot burner Qty 1 pcs			
	Part No.	102110	Ref. No.	—
	pilot tube copper pipe ø 4mm thickness 1mm L 3000mm			

Table continues overleaf

















accessories for	107836		
Part No.	102111	Ref. No.	—
	pilot tube copper pipe ø 6mm thickness 1mm L 3000mm		

160 series



1

Part No.	100056	Ref. No.	672.042.00
description	pilot burner SIT type 160 series 3 flames nozzle ømm gas connectionmm		
For models:	V70120TPPCFG2, V90120TPPCFG2, VS70120CFG, VS70120TPFG, VS7080CFG, VS7080PG50, VS7080PGI50, VS7080TPFG, VS7080TPPCFG, VS90120CFG, VS90120TPFG, VS90160CFG, VS9080CFG, VS9080PGI150, VS9080TPFG, VS9080TPPCFG		
spare parts for	100056		
	Part No.	100907	Ref. No. —
	screw connection thread M10x1 Qty 1 pcs type SEF 1 ømm for thermocouple		
accessories for	100056		
	Part No.	100202	Ref. No. —
	pilot burner nozzle natural gas code 41 Qty 1 pcs nozzle ø 0.41mm		
	Part No.	100203	Ref. No. —
	pilot burner nozzle LPG code 25 Qty 1 pcs nozzle ø 0.25mm		
	Part No.	100701	Ref. No. 256.017.00 256.060.00
	ignition electrode connection M4 Qty 1 pcs		
	Part No.	100801	Ref. No. —
	gasket for pilot burner Qty 1 pcs		
	Part No.	100869	Ref. No. —
	pilot burner nozzle natural gas code 51 Qty 1 pcs suitable for 160 series nozzle ø 0.51mm		
	Part No.	100870	Ref. No. —
	olive for pipe ø 4mm Qty 1 pcs suitable for 160 series for pilot burner		
	Part No.	100906	Ref. No. —
	screw connection thread M10x1 for ignition electrode brass Qty 1 pcs WS 10		
	Part No.	100908	Ref. No. —
	union screw thread M10x1 for pipe ø 4mm Qty 1 pcs		
	Part No.	100909	Ref. No. —
	union screw thread M10x1 for pipe ø 6mm Qty 1 pcs		
	Part No.	101287	Ref. No. —
	olive for pipe ø 6mm Qty 1 pcs		
	Part No.	102110	Ref. No. —
	pilot tube copper pipe ø 4mm thickness 1mm L 3000mm		
	Part No.	102111	Ref. No. —
	pilot tube copper pipe ø 6mm thickness 1mm L 3000mm		
	Part No.	107650	Ref. No. —
	pilot burner nozzle SIT LPG code 30 Qty 1 pcs		

electrodes

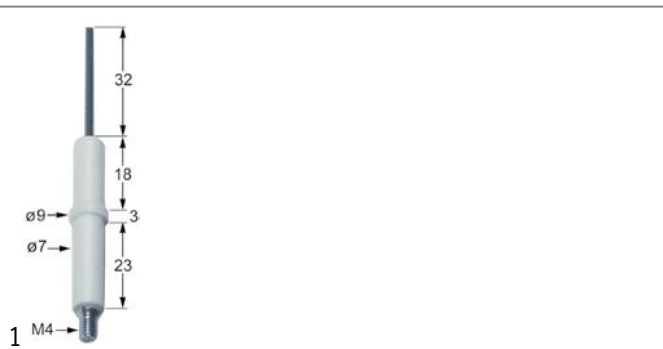

Part No.	100701	Ref. No.	256.017.00 256.060.00
description	ignition electrode connection M4 Qty 1 pcs		
For models:	V70120TPPCFG2, V70120TPPCG2T, V7040FTRGVCRT, V7080FTRGVCRT, V90120TPPCFG2, V90120TPPCG2T, V9040FTRGVCRT, V9080FTRGVCRT, V9080FTRRGVCRT, VS70120CFG, VS70120CFGG, VS70120TPFG, VS7040BMGT, VS7040CPGS, VS7040FTGT, VS7040FTGVCRT, VS-7040FTGVT, VS7040FTRGT, VS7040FTRGVT, VS7040GRL, VS7080BMGT, VS7080BRGI, VS7080BRGIM, VS7080CFG, VS7080CPGS, VS7080FTGT, VS7080FTGVCRT, VS7080FTGVT, VS7080FTRGT, VS7080FTRGVT, VS7080FTRRGT, VS7080FTRRGVC, VS7080FTRRGVT, VS7080GRL, VS7080PG50, VS7080PGI50, VS7080TPFG, VS7080TPPCFG, VS7080TPPCGT, VS90120CFG, VS90120CFGG, VS90120TPFG, VS90160CFG, VS9040BMGT, VS9040CPGS, VS9040FTGVCRT, VS9040FTGT, VS9040FTGVCRT, VS9040FTGVT, VS9040FTRGVCRT...(Other models you can see in the webshop)		
accessories for	100701		
	Part No.	100906	Ref. No. —
	screw connection thread M10x1 for ignition electrode brass Qty 1 pcs WS 10		

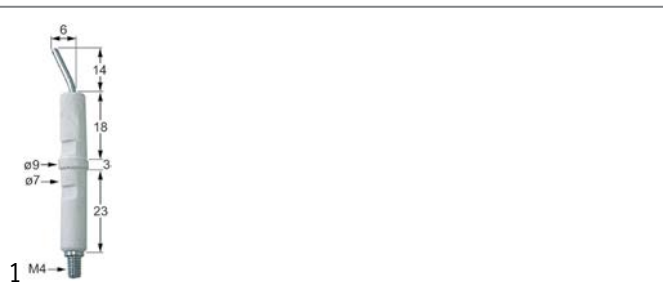

Part No.	100706	Ref. No.	672.060.00
description	ignition electrode connection M4 Qty 1 pcs		
For models:	VS70120TPFG, VS7040FRG17VL, VS7040FRGS13, VS7040GRACQG, VS7080FRG17VL, VS7080FRGS13, VS7080GRACQG, VS7080TPFG, VS7080TPGT, VS90120TPFG, VS9040FRG17VL, VS9040FRG21VL, VS9040FRGS13, VS9040FRGS20, VS9040GRACQG, VS9080FRG17VL, VS9080FRG21VL, VS9080FRGS13, VS9080FRGS20, VS9080GRACQG, VS9080TPFG, VS9080TPGT		

1

Part No.	104806	Ref. No.	12039586
description	ignition electrode flange length 23mm flange width 16mm D1 ø 9.4mm D2 ø 9.4mm L1 25mm BL1 17mm BL2 36mm		
For models:	AIC0038-F, AIC0040-F		



1

Part No.	104803	Ref. No.	12039448
description	ignition electrode flange length 23mm flange width 16mm D1 ø 9.5mm D2 ø 9.5mm L1 10mm L2 79mm BL1 72.5mm BL2 24mm flange		
For models:	AIC0042-F, AIC0046-F, AIC0078-F, AIC0080-F		



1

Part No.	104804	Ref. No.	12039685
description	ignition electrode flange length 23mm flange width 16mm D1 ø 9mm D2 ø 9mm L1 17mm L2 79mm BL1 80mm BL2 17mm connection M4 flange		
For models:	AIC0038-F, AIC0040-F, AIC0044-F, AIC0076-F, AIC0077-F, AIC0079-F		



1

Part No.	104802	Ref. No.	12039447
description	ignition electrode flange length 28mm flange width 16mm D1 ø 9.4mm D2 ø 9.4mm L1 9mm L2 73mm BL1 72.5mm BL2 26mm connection F2.8 cable length 260mm mounting distance 20mm flange		
For models:	AIC0042-F, AIC0046-F, AIC0078-F, AIC0080-F		



1

Part No.	104805	Ref. No.	12039684
description	ignition electrode flange length 28mm flange width 16mm D1 ø 9mm D2 ø 9mm L1 16.5mm L2 80mm BL1 81mm BL2 16.5mm connection F2.8 cable length 250mm mounting distance 20mm flange		
For models:	AIC0038-F, AIC0040-F, AIC0044-F, AIC0076-F, AIC0077-F, AIC0079-F		

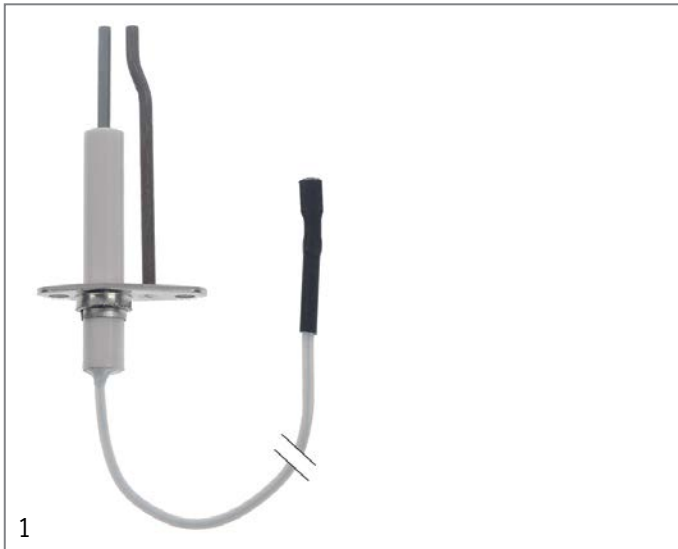

Part No.	104807	Ref. No.	12039585
description	ignition electrode flange length 38mm flange width 16mm D1 ø 9.4mm D2 ø 9.4mm L1 25mm BL1 17mm BL2 36mm connection F2.8 cable length 250mm fixing dimensions 4mm mounting distance 28mm flange		
For models:	AIC0038-F, AIC0040-F		

piezoelectric igniters

mounting diameter 22mm



Part No.	103341	Ref. No.	912.091.00
description	piezoelectric igniter body plastic blowing mounting ø 22mm connection ø2.4mm		
For models:	V70120TPPCFG2, V70120TPPCG2T, V7040FTRGVCRT, V7080FTRGVCRT, V90120TPPCFG2, V90120TPPCG2T, V9040FTRGVCRT, V9080FTRGVCRT, V9080FTRRGCR, VS70120CFG, VS70120CFGG, VS70120TPFG, VS7040BMGT, VS7040CPGS, VS7040FRGS13, VS7040FTGT, VS7040FTGVCRT, VS7040FTGVT, VS7040FTRGT, VS7040FTRGVT, VS7040GRACQG, VS7040GRL, VS7080BMGT, VS7080CFG, VS7080CPGS, VS7080FRGS13, VS7080FTGT, VS7080FTGVCRT, VS7080FTGVT, VS7080FTRGT, VS7080FTRGVT, VS7080FTRRG, VS7080FTRRGV, VS7080FTRRGVT, VS7080GRACQG, VS7080GRL, VS7080TPFG, VS7080TPGT, VS7080TPPCFG, VS7080TPPCGT, VS90120CFG, VS90120CFGG, VS90120TPFG, VS90160CFG, VS9040BMGT, VS9040CPGS, VS9040FRGS13, VS9040FRGS20, VS9040FTGCR, VS9040FTGT...(Other models you can see in the webshop)		

spare parts for	103341		
------------------------	--------	--	--

	Part No.	100013	Ref. No.	—
--	-----------------	--------	-----------------	---

description	piezoelectric igniter body plastic blowing mounting ø 22mm connection ø2.4mm cable lengthmm		
--------------------	---	--	--

	Part No.	101339	Ref. No.	951.047.00
--	-----------------	--------	-----------------	------------

description	cover cap for piezoelectric igniter		
--------------------	-------------------------------------	--	--

accessories

	1		
Part No.	101339	Ref. No.	951.047.00
description	cover cap for piezoelectric igniter		
For models:	V70120TPPCFG2, V70120TPPCG2T, V7040FTRGVCRT, V7080FTRGVCRT, V90120TPPCFG2, V90120TPPCG2T, V9040FTRGVCRT, V9080FTRGVCRT, V9080FTRRGCR, VS70120CFG, VS70120CFGG, VS70120TPFG, VS7040BMGT, VS7040CPGS, VS7040FRGS13, VS7040FTGT, VS7040FTGVCRT, VS7040FTGVT, VS7040FTRGT, VS7040FTRGVT, VS7040GRACQG, VS7040GRL, VS7080BMGT, VS7080CFG, VS7080CPGS, VS7080FRGS13, VS7080FTGT, VS7080FTGVCRT, VS7080FTGVT, VS7080FTRGT, VS7080FTRGVT, VS7080FTRRG, VS7080FTRRGV, VS7080FTRRGVT, VS7080GRACQG, VS7080GRL, VS7080TPFG, VS7080TPGT, VS7080TPPCFG, VS7080TPPCGT, VS90120CFG, VS90120CFGG, VS90120TPFG, VS90160CFG, VS9040BMGT, VS9040CPGS, VS9040FRGS13, VS9040FRGS20, VS9040FTGCR, VS9040FTGT...(Other models you can see in the webshop)		

ignition units

	1		
Part No.	101012	Ref. No.	961.030.00
description	ignition unit outputs 2 230VAC dimensions 48x32x32mm mounting distance 56mm inlet F2.8x0.8 outlet F2.8x0.8 type ZIG2 50-60Hz		
For models:	VS7080BRGI, VS7080BRGIM, VS7080PG50, VS7080PGI50, VS9080BRGI, VS9080BRGIM, VS9080PGI50		

	1		
Part No.	101002	Ref. No.	661.118.00
description	ignition unit outputs 2 230VAC dimensions 88x23x34mm mounting distance 73mm inlet F6.3x0.8 outlet F2.8x0.8 0.6VA 50/60Hz		
For models:	VS7040FRG17VL, VS7080FRG17VL, VS9040FRG17VL, VS9040FRG21VL, VS9080FRG17VL, VS9080FRG21VL		

ignition switches

	1		
Part No.	348219	Ref. No.	961.048.00
description	momentary push switch mounting ø 25mm black 1NO 250V 16A connection male faston 6.3mm ambient temperature max. 120°C		
For models:	VS7080BREI, VS7080BREIM, VS7080BRGI, VS7080BRGIM, VS9080BREI, VS9080BREIM, VS9080BRGI, VS9080BRGIM		



thermocouples

plug-in thermocouples

plug-in thermocouples standard

with barrel socket $\varnothing 6(6.5)$ mm

thermocouples SIT

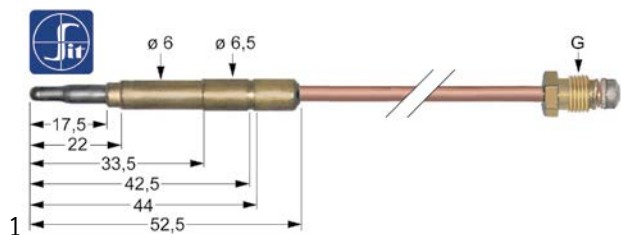

Part No.	107613	Ref. No.	672.154.00
description	thermocouple SIT M9x1 L 1200mm plug connection $\varnothing 6.0(6.5)$ mm		
For models:	V70120TPPCFG2, V90120TPPCFG2, VS70120CFG, VS7080CFG, VS7080TPPCFG, VS90120CFG, VS90160CFG, VS9080CFG, VS9080TPPCFG		

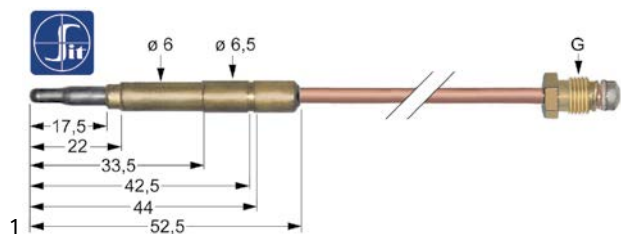

Part No.	107614	Ref. No.	672.104.00 672.179.00
description	thermocouple SIT M9x1 L 1500mm plug connection $\varnothing 6.0(6.5)$ mm		
For models:	VS70120CFG, VS70120TPFG, VS7080TPFG, VS90120CFG, VS90120TPFG, VS9080TPFG		

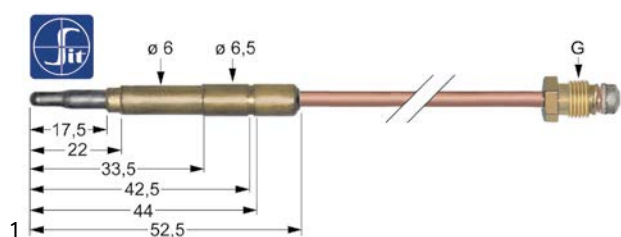

Part No.	107608	Ref. No.	672.001.00 672.025.00
description	thermocouple SIT M9x1 L 500mm plug connection $\varnothing 6.0(6.5)$ mm		
For models:	V70120TPPCFG2, V70120TPPCG2T, V90120TPPCFG2, V90120TPPCG2T, VS70120CFG, VS70120CFGE, VS70120CFG, VS70120PCGT, VS70120TPFG, VS7040PCGS, VS7040GRL, VS7040PCGT, VS7080CFG, VS7080CFGE, VS7080PCGS, VS7080GRL, VS7080PCGT, VS7080PG50, VS7080PGI50, VS7080TPFG, VS7080TPGT, VS7080TPPCFG, VS7080TPPCGT, VS90120CFG, VS90120CFGE, VS90120CFG, VS90120PCGP, VS90120PCGT, VS90120TPFG, VS90160CFG, VS90160CFGE, VS9040GRL, VS9040PCGP, VS9040PCGT, VS9080CFG, VS9080CFGE, VS9080GRL, VS9080PCGP, VS9080PCGT, VS9080PGI50, VS9080TPFG, VS9080TPGT, VS9080TPPCFG, VS9080TPPCGT		

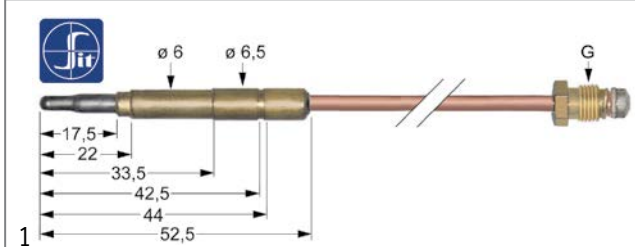

Part No.	107611	Ref. No.	672.083.00 672.099.00
description	thermocouple SIT M9x1 L 850mm plug connection $\varnothing 6.0(6.5)$ mm		
For models:	V70120TPPCFG2, V70120TPPCG2T, V90120TPPCFG2, V90120TPPCG2T, VS70120CFG, VS70120CFGE, VS70120CFG, VS70120PCGT, VS70120TPFG, VS7040BMGT, VS7040GRACQ, VS7040PCGT, VS7080BMGT, VS7080BRGI, VS7080BRGIM, VS7080CFG, VS7080CFGE, VS7080GRACQ, VS7080PCGT, VS7080TPPCFG, VS7080TPPCGT, VS90120CFG, VS90120CFGE, VS90120CFG, VS90120PCGP, VS90120PCGT, VS90160CFG, VS90160CFGE, VS9040BMGT, VS9040PCGS, VS9040GRACQ, VS9040PCGP, VS9040PCGT, VS9080BMGT, VS9080BRGI, VS9080BRGIM, VS9080CFG, VS9080CFGE, VS9080PCGS, VS9080GRACQ, VS9080PCGP, VS9080PCGT, VS9080TPPCFG, VS9080TPPCGT		

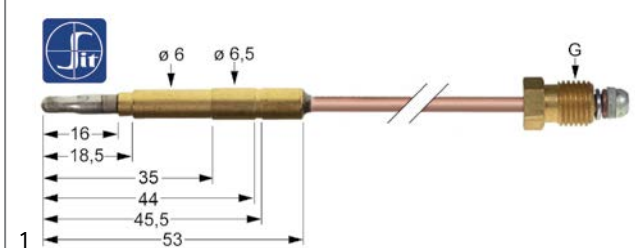

Part No.	107876	Ref. No.	672.168.00
description	thermocouple SIT M9x1 L 850mm plug connection $\varnothing 6.0(6.5)$ mm		
For models:	V7040FTRGVCRT, V7080FTRGVCRT, V9040FTRGVCRT, V9080FTRGVCRT, V9080FTRGCR, VS7040FTGT, VS7040FTGVCRT, VS7040FTGVT, VS7040FTRGT, VS7040FTRGVT, VS7080FTGT, VS7080FTGVCRT, VS7080FTGVT, VS7080FTRGT, VS7080FTRGVT, VS7080FTRRG, VS7080FTRRGV, VS7080FTRRGV, VS9040FTGCR, VS9040FTGT, VS9040FTGVCRT, VS9040FTGVT, VS9040FTRGCR, VS9040FTRGT, VS9040FTRGVT, VS9080FTGCR, VS9080FTGT, VS9080FTGVCRT, VS9080FTGVT, VS9080FTRGCR, VS9080FTRGT, VS9080FTRGVT, VS9080FTRRG, VS9080FTRRGV, VS9080FTRRGV		

plug-in thermocouples with interruption

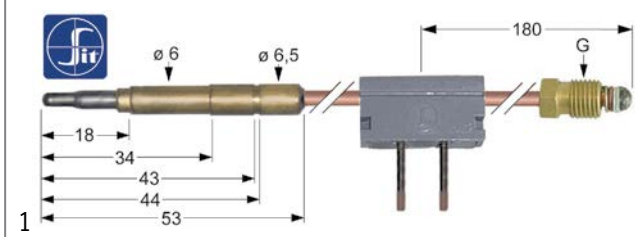

Part No.	107864	Ref. No.	672.167.00
description	thermocouple SIT with interrupter M9x1 L 600mm plug connection $\varnothing 6.0(6.5)$ mm soldering connection		
For models:	VS7040FRG17VL, VS7080FRG17VL, VS9040FRG17VL, VS9040FRG21VL, VS9080FRG17VL, VS9080FRG21VL		

1 gas components



gas burners

hob burners

accessories

pan supports



1

Part No.	210132	Ref. No.	681.008.14
description	pan support W 340mm L 570mm suitable for 700 series		
For models:	V70120TPPCFG2, V70120TPPCG2T, VS70120CFG, VS70120CFGE, VS70120CFGG, VS70120PCGT, VS70120TPFG, VS7040PCGT, VS7080CFG, VS7080CFGE, VS7080PCGT, VS7080TPPCFG, VS7080TPPCGT		
accessories for	210132		
	Part No.	210050	Ref. No. —
	reducer for pan support L 260mm W 260mm chrome-plated steel suitable for universal		



1

Part No.	210060	Ref. No.	681.019.14
description	pan support W 400mm L 400mm enamelled		
For models:	V90120TPPCFG2, V90120TPPCG2T, VS90120CFG, VS90120CFGE, VS90120CFGG, VS90120PCGP, VS90120PCGT, VS90120TPFG, VS90160CFG, VS90160CFGE, VS9040PCGP, VS9040PCGT, VS9080CFG, VS9080CFGE, VS9080PCGP, VS9080PCGT, VS9080TPPCFG, VS9080TPPCGT		

air mixers



1

Part No.	104696	Ref. No.	923.271.00
description	air mixer ED ø 95mm thickness 0.75mm hole ø 10mm round burner		
For models:	VS70120TPFG, VS7080TPFG, VS7080TPGT, VS90120TPFG, VS9080TPFG, VS9080TPGT		





1

Part No.	104693	Ref. No.	941.124.00
description	air mixer H 6mm ED ø 31mm ID ø 10mm hole ø 6.5 6 holemm		
For models:	V70120TPPCFG2, V70120TPPCG2T, V90120TPPCFG2, V90120TPPCG2T, VS70120CFG, VS70120TPFG, VS7080CFG, VS7080TPFG, VS7080TPPCFG, VS7080TPPCGT, VS90120CFG, VS90120TPFG, VS90160CFG, VS9080CFG, VS9080TPFG, VS9080TPPCFG, VS9080TPPCGT		



1

Part No.	103127	Ref. No.	672.016.00
description	air mixing sleeve L 36mm ED ø 40mm ID ø 36mm aluminium		
For models:	V70120TPPCFG2, V70120TPPCG2T, V90120TPPCFG2, V90120TPPCG2T, VS70120CFG, VS70120CFGE, VS70120CFGG, VS70120PCGT, VS70120TPFG, VS7040PCGT, VS7080CFG, VS7080CFGE, VS7080PCGT, VS7080TPPCFG, VS7080TPPCGT, VS90120CFG, VS90120CFGE, VS90120CFGG, VS90120PCGP, VS90120PCGT, VS90160CFG, VS90160CFGE, VS9040PCGP, VS9040PCGT, VS9080CFG, VS9080CFGE, VS9080PCGP, VS9080PCGT, VS9080TPPCFG, VS9080TPPCGT		
accessories for	103127		
	Part No.	103118	Ref. No. —
	burner cap ø 61mm		
	Part No.	103119	Ref. No. —
	burner ring for burner cap ø 61mm		
	Part No.	103120	Ref. No. —
	burner head for burner cap ø 61mm		
	Part No.	103121	Ref. No. 672.010.00
	venturi		
	Part No.	103122	Ref. No. 673.020.00
	burner holder ø 35mm H 82mm nozzle mounting M10x1 mounting distance 55mm connection M16x1.5mm with nozzle holder		
	Part No.	103124	Ref. No. 672.101.00
	burner head E ø 150mm for burner cap ø 110mm 7.5kW code 672.077 A		
	Part No.	103125	Ref. No. 672.079.00
	burner cap D ø 110mm 5.5kW bore ø 2.6mm with central hole		
	Part No.	103126	Ref. No. 672.093.00
	burner cap E ø 110mm 7.5kW bore ø 3mm with central hole		
	Part No.	105067	Ref. No. 672.078.00
	burner cap C ø 84mm 3.5kW		
	Part No.	105069	Ref. No. 672.076.00
	burner head C for burner cap ø 84mm 3.5kW		
	Part No.	105070	Ref. No. 672.077.00
	burner head D ø 150mm for burner cap ø 110mm 5.5kW code 672.077 E		



1

Part No.	105711	Ref. No.	672.133.00
description	air mixing tube L 42mm ED ø 20mm brass		
For models:	VS7040FRGS13, VS7040GRL, VS7080FRGS13, VS7080GRL, VS-9040FRGS13, VS9040FRGS20, VS9040GRL, VS9080FRGS13, VS-9080FRGS20, VS9080GRL		



bar burners

bar burners



1

Part No.	106846	Ref. No.	972.017.00
description	bar burner 2 row L 610mm W 220mm ømm H 47mm chargrill		
For models:	VS9040GRL, VS9080GRL		



1

Part No.	107880	Ref. No.	672.174.00
description	bar burner 3 row L 450mm W 245mm ø 25mm for grill		
For models:	VS7040GRACQG, VS7080GRACQG		



1

Part No.	104689	Ref. No.	972.043.00
description	bar burner 3 row L 620mm W 250mm ø 27mm for grill		
For models:	VS9040GRACQG, VS9080GRACQG		



1

Part No.	104691	Ref. No.	672.153.00
description	bar burner L 520mm W 200mm ø 25mm H 60mm for tilting bratt pan		
For models:	V7040FTRGVCRT, V7080FTRGVCRT, V9040FTRGVCRT, V9080FTRGVCRT, V9080FTRRGCR, VS7040FTGT, VS7040FTGVCRT, VS7040FTGVT, VS7040FTRGT, VS7040FTRGVT, VS7080FTGT, VS7080FTGVCRT, VS-7080FTGVT, VS7080FTRGT, VS7080FTRGVT, VS7080FTRRG, VS7080FTRRGVC, VS7080FTRRGVT, VS9040FTGCRT, VS9040FTGT, VS9040FTGVCRT, VS9040FTGVT, VS9040FTRGCR, VS9040FTRGT, VS9040FTRGVT, VS9080FTGCRT, VS9080FTGT, VS9080FTGVCRT, VS9080FTGVT, VS9080FTRGCR, VS9080FTRGT, VS9080FTRGVT, VS9080FTRRG, VS9080FTRRGVC, VS9080FTRRGVT		



1

Part No.	104690	Ref. No.	672.183.00
description	bar burner L 590mm W 585mm ø 25mm H 170mm tilting bratt pan for model 70/80 BRG		
For models:	VS7080BRGI, VS7080BRGIM		



1

Part No.	104797	Ref. No.	972.051.00
description	bar burner L 590mm W 585mm ø 25mm H 170mm tilting bratt pan for model 90/80 BRG		
For models:	VS9080BRGI, VS9080BRGIM		



1

Part No.	104694	Ref. No.	672.053.00
description	bar burner ø 29/32/29mm for gas oven		
For models:	VS70120CFGG, VS90120CFGG		



1

Part No.	103360	Ref. No.	972.042.00
description	bar burner ø 40mm L 600mm flange width 25mm flange length 48mm		
For models:	VS7080BMGT, VS9080BMGT		



1

Part No.	105515	Ref. No.	972.041.00
description	bar burner ø 40mm Wmm Hmm L 250mm flange ø 61mm bain marie		
For models:	VS7040BMGT, VS9040BMGT		





1

Part No.	103358	Ref. No.	672.145.00
description	bar burner ø 50mm L 343mm flange width 25mm flange length 60mm pasta cooker		
For models:	VS7040CPGS, VS7080CPGS		



 <p>1</p>			
Part No.	103359	Ref. No.	672.175.00
description	bar burner ø 50mm L 365mm flange width 25mm flange length 60mm		
For models:	VS7040FRG17VL, VS7080FRG17VL, VS9040FRG17VL, VS9080FRG17VL		

 <p>1</p>			
Part No.	105160	Ref. No.	672.072.15
description	bar burner ø 50mm Wmm Hmm L 428mm flange width 71mm kettle flange ø 75mm		
For models:	VS9040CPGS, VS9080CPGS		
spare parts for	105160		
	 <p>Part No. 105159 Ref. No. —</p>	end cap suitable for burner for pasta cooker	

 <p>1</p>			
Part No.	105523	Ref. No.	972.040.00
description	bar burner ø 50mm Wmm Hmm L 475mm flange ø 75mm		
For models:	VS9080PGI150		

 <p>1</p>			
Part No.	103343	Ref. No.	972.045.00
description	bar burner ø 52mm L 490mm flange width 24mm flange length 60mm fryer		
For models:	VS9040FRG21VL, VS9080FRG21VL		

<p>lava rock grids</p>  <p>1</p>			
Part No.	211053	Ref. No.	9111068.00
description	lava rock grid L 625mm W 325mm H 36mm stainless steel		
For models:	VS9040GRL, VS9080GRL		

tube burners

 <p>1</p>			
Part No.	105401	Ref. No.	672.181.00
description	burner L 300mm W 75mm H 42mm for fryer		
For models:	VS7040FRGS13, VS7080FRGS13, VS9040FRGS13, VS9040FRGS20, VS9080FRGS13, VS9080FRGS20		

solid top burners

 <p>1</p>			
Part No.	105485	Ref. No.	972.044.00
description	solid top burner ø 65mm H 102mm L 284mm		
For models:	V70120TPPCFG2, V70120TPPCG2T, V90120TPPCFG2, V90120TPPCG2T, VS7080TPPCFG, VS7080TPPCGT, VS9080TPPCFG, VS9080TPPCGT		

forced air burners

 <p>1</p>			
Part No.	107930	Ref. No.	12039680
description	burner L 250mm ø 38mm combi-steamer FAGOR		
For models:	AIC0038-F, AIC0076-F		

 <p>1</p>			
Part No.	107929	Ref. No.	12039583
description	burner L 260mm ø 37.5mm for combi-steamer FAGOR		
For models:	AIC0038-F, AIC0040-F		



			
1			
Part No.	107927	Ref. No.	12039556
description	burner L 270mm ø 38mm for combi-steamer		
For models:	AIC0040-F, AIC0044-F, AIC0077-F, AIC0079-F		

			
1			
Part No.	107925	Ref. No.	12039442
description	burner L 300mm ø 44mm for combi-steamer FAGOR		
For models:	AIC0042-F, AIC0046-F, AIC0078-F, AIC0080-F		





			
1			
Part No.	107899	Ref. No.	12044424
description	burner L 435mm ø 52mm for combi-steamer FAGOR		
For models:	AIC0044-F		

accessories

nozzle holders

			
1			
Part No.	104699	Ref. No.	675.511.00
description	nozzle holder L 153mm screw pipe fitting 1/2" ET M14x1		
For models:	VS7040FRGS13, VS7080FRGS13, VS9040FRGS13, VS9080FRGS13		

			
1			
Part No.	104697	Ref. No.	675.512.00
description	nozzle holder L 225mm screw pipe fitting 1/2" ET M14x1		
For models:	VS9040FRGS20, VS9080FRGS20		

			
1			
Part No.	104108	Ref. No.	673.023.00
description	nozzle holder nozzle mounting M10x1 tube ø 10mm gas inlet M16x1.5 gas outlet M14x1		
For models:	VS7080BRGI, VS7080BRGIM, VS9080BRGI, VS9080BRGIM		
accessories for	104108		
	Part No.	102382	Ref. No. 673.024.00
	Part No.	104105	Ref. No. —
	Part No.	104107	Ref. No. —

gas nozzles

gas nozzles sets

			
1			
Part No.	103346	Ref. No.	265.034.13
description	gas injector set natural/liquid gas 70/80 BRG		
For models:	VS7080BRGI, VS7080BRGIM		

			
1			
Part No.	103356	Ref. No.	265.035.13
description	gas injector set natural/liquid gas BRG90/80EM		
For models:	VS9080BRGI, VS9080BRGIM		

auxiliary gas parts

screw connections

olives

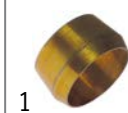
			
1			
Part No.	101000	Ref. No.	12008775
description	olive for pipe ø 16mm L 10.5mm brass Qty 1 pcs		
For models:	AIC0038-F, AIC0040-F, AIC0042-F, AIC0044-F, AIC0046-F, AIC0078-F, AIC0079-F, AIC0080-F		



union nuts



1

Part No.	106331	Ref. No.	12008085
description	union nut thread M26x1.5 WS 30 L 17.5mm brass for pipe ø 17mm		
For models:	AIC0038-F, AIC0040-F, AIC0042-F, AIC0044-F, AIC0046-F, AIC0079-F, AIC0080-F		

gas lines

main gas lines

producer-specific



1

Part No.	109204	Ref. No.	631.196.00
description	gas line tube ø 6mm L 255mm W 70mm connection with screw connection for kettle for pressure switch		
For models:	VS7080PEI50, VS7080PGI50		

gas hoses

screw pipe fittings



1

Part No.	107879	Ref. No.	678.084.00
description	T-piece T-piece thread 1/4" for pipe ø 6mm L 55mm brass gas		
For models:	VS7080PEI50, VS7080PGI50, VS9080PEI150, VS9080PGI150		

equipment-specific units

for fridges

housing and bezels

shelf rails



1

Part No.	701389	Ref. No.	17000226
description	rack L 530mm W 20mm H 14mm SS U-shape mounting pos. on both sides pair		
For models:	BNA0030-F, BNA0031-F, BNA0036-F, BNA0044-F, BNA0056-F, VTGB2A-F, VTGB2-F, VTGB3A-F, VTGB3-F, VTGB4-F		

doors

doors



1

Part No.	694689	Ref. No.	01A01KA108
description	door W 700mm H 1600mm thickness 47mm FRENEX hinging right/left		
For models:	BMA0021-F, BMA0024-F, BMA0026-F, BMA0028-F, BMA0032-F, BMA0035-F, BMA0036-F, BMB0028-F, BMB0034-F, BMB0036-F, BMC0015-F, BMC0016-F		



for refrigerated counters

doors



1	Part No.	694687	Ref. No.	01A01KA100
	description	door hinging right/left suitable for FRENEX W 450mm H 660mm thickness 45mm FRENEX without hinge		
	For models:	BNA0030-F, BNA0031-F, BNA0036-F, BNA0037-F, BNA0044-F, BNA0045-F, BNA0052-F, BNA0053-F, BNA0054-F, BNA0055-F, BNA0056-F, BNA0057-F, BNB0010-F, BNB0011-F, BNB0012-F, BNB0013-F, BNB0014-F, BNB0015-F, CCZ0036-F, CCZ0037-F, VTGB2A-F, VTGB2-F, VTGB3A-F, VTGB3-F, VTGB4A-F, VTGB4-F		

for bain marie

spare parts and accessories



1	Part No.	692889	Ref. No.	984.006.00
	description	door magnet H 6mm ø 20mm M5 thread L 15mm		
	For models:	V70120TPPCFG2, V90120TPPCFG2, VS70120B, VS70120CFG, VS70120CFGE, VS70120TPFG, VS7040B, VS7040CPES, VS7040CPGS, VS7040FRE10, VS7040FRE17X, VS7040FRE88, VS7040FRG17VL, VS7040FRGS13, VS7040GRL, VS7080B, VS7080CPES, VS7080CPGS, VS7080FRE10, VS7080FRE17X, VS7080FRG17VL, VS7080FRGS13, VS7080GRL, VS90120B, VS90120CFG, VS90120CFGE, VS90120PCGP, VS90120TPFG, VS9040B, VS9040CPES, VS9040CPGS, VS9040FRE15, VS-9040FRE17, VS9040FRE21, VS9040FRE88, VS9040FRG17VL, VS9040FRG21VL, VS9040FRGS13, VS9040FRGS20, VS9040GRL, VS9040PCGP, VS9080B, VS9080CPES, VS9080CPGS, VS9080FRE15, VS9080FRE17, VS9080FRE21, VS9080FRG17VL, VS9080FRG21VL, VS9080FRGS13... (Other models you can see in the webshop)		



1	Part No.	692796	Ref. No.	256.431.00
	description	mounting set hexagon L 31mm thread M5		
	For models:	VS70120B, VS7040B, VS7040CPES, VS7040CPGS, VS7040FRE10, VS7040FRE17X, VS7040FRE88, VS7040FRG17VL, VS7040FRGS13, VS7040GRL, VS7080B, VS7080CPES, VS7080CPGS, VS7080FRE10, VS7080FRE17X, VS7080FRG17VL, VS7080FRGS13, VS7080GRL, VS90120B, VS90120PCGP, VS9040B, VS9040CPES, VS9040CPGS, VS-9040FRE15, VS9040FRE17, VS9040FRE21, VS9040FRE88, VS9040FRG-17VL, VS9040FRG21VL, VS9040FRGS13, VS9040FRGS20, VS9040GRL, VS9040PCGP, VS9080B, VS9080CPES, VS9080CPGS, VS9080FRE15, VS9080FRE17, VS9080FRE21, VS9080FRG17VL, VS9080FRG21VL, VS9080FRGS13, VS9080FRGS20, VS9080GRL, VS9080PCGP		



1	Part No.	705023	Ref. No.	610.272.00
	description	scraper W 100mm L 420mm		
	For models:	VS7040GRACQE, VS7040GRACQG, VS7080GRACQE, VS7080GRACQG, VS9040GRACQE, VS9040GRACQG, VS9080GRACQE, VS9080GRACQG		

for pyroceram ranges

spare parts and accessories



1	Part No.	694978	Ref. No.	256.424.00
	description	mounting set		
	For models:	VS7080CFVE, VS7080PVET, VS9040PVET, VS9080CFVE, VS9080PVET		



for deep fryers

spare parts and accessories



1			
Part No.	692810	Ref. No.	256.420.00
description	cover for holder fryer heaters L 64mm W 56mm H 80mm mounting pos. left		
For models:	VS7040FRE10, VS7080FRE10, VS9040FRE15, VS9080FRE15		



1			
Part No.	692778	Ref. No.	611.042.00
description	cover for holder fryer heaters L 64mm W 56mm H 80mm mounting pos. right		
For models:	VS7040FRE10, VS7080FRE10, VS9040FRE15, VS9080FRE15		



1			
Part No.	692795	Ref. No.	941.130.00
description	fixing plate L 35mm W 10mm H 8mm M5 mounting distance 17mm		
For models:	V080FTREVCRT, V70120TPPCFG2, V70120TPPCG2T, V7040FTREVCRT, V7040FTRGVCRT, V7080FTRGVCRT, V90120TPPCFG2, V90120TPPCG2T, V9040FTREVCRT, V9040FTRGVCRT, V9080FTREVCRT, V9080FTRGVCRT, V9080FTRRRCRT, V9080FTRRGCRT, VS70120CFG, VS70120CFGE, VS70120CFGG, VS70120PCGT, VS70120TPFG, VS7040BMET, VS-7040BMFEP, VS7040BMGT, VS7040CPES, VS7040CPGS, VS7040FRE10, VS7040FRE17X, VS7040FRE88, VS7040FRG17VL, VS7040FRGS13, VS7040FTET, VS7040FTEVCRT, VS7040FTEVT, VS7040FTGT, VS7040FTGVCRT, VS7040FTGVT, VS7040FTRET, VS7040FTREVT, VS7040FTRGT, VS7040FTRGVT, VS7040GRACQE, VS7040GRACQG, VS7040GRL, VS7040PCEQT, VS7040PCET, VS7040PCGT, VS7040SPET, VS7080BMET, VS7080BMFEP, VS7080BMGT, VS7080BREI... (Other models you can see in the webshop)		



1			
Part No.	692796	Ref. No.	256.431.00
description	mounting set hexagon L 31mm thread M5		
For models:	VS70120B, VS7040B, VS7040CPES, VS7040CPGS, VS7040FRE10, VS7040FRE17X, VS7040FRE88, VS7040FRG17VL, VS7040FRGS13, VS7040GRL, VS7080B, VS7080CPES, VS7080CPGS, VS7080FRE10, VS7080FRE17X, VS7080FRG17VL, VS7080FRGS13, VS7080GRL, VS90120B, VS90120PCGP, VS9040B, VS9040CPES, VS9040CPGS, VS-9040FRE15, VS9040FRE17, VS9040FRE21, VS9040FRE88, VS9040FRG-17VL, VS9040FRG21VL, VS9040FRGS13, VS9040FRGS20, VS9040GRL, VS9040PCGP, VS9080B, VS9080CPES, VS9080CPGS, VS9080FRE15, VS9080FRE17, VS9080FRE21, VS9080FRG17VL, VS9080FRG21VL, VS9080FRGS13, VS9080FRGS20, VS9080GRL, VS9080PCGP		



1			
Part No.	692886	Ref. No.	6211992.00
description	protective plate cover for fryer L 210mm W 60mm H 38mm mounting pos. heating element		
For models:	VS7040FRE10, VS7080FRE10		

door magnets



1			
Part No.	692889	Ref. No.	984.006.00
description	door magnet H 6mm ø 20mm M5 thread L 15mm		
For models:	V70120TPPCFG2, V90120TPPCFG2, VS70120B, VS70120CFG, VS70120CFGE, VS70120TPFG, VS7040B, VS7040CPES, VS7040CPGS, VS7040FRE10, VS7040FRE17X, VS7040FRE88, VS7040FRG17VL, VS7040FRGS13, VS7040GRL, VS7080B, VS7080CPES, VS7080CPGS, VS7080FRE10, VS7080FRE17X, VS7080FRG17VL, VS7080FRGS13, VS7080GRL, VS90120B, VS90120CFG, VS90120CFGE, VS90120PCGP, VS90120TPFG, VS9040B, VS9040CPES, VS9040CPGS, VS9040FRE15, VS-9040FRE17, VS9040FRE21, VS9040FRE88, VS9040FRG17VL, VS9040FRG21VL, VS9040FRGS13, VS9040FRGS20, VS9040GRL, VS9040PCGP, VS9080B, VS9080CPES, VS9080CPGS, VS9080FRE15, VS9080FRE17, VS9080FRE21, VS9080FRG17VL, VS9080FRG21VL, VS9080FRGS13... (Other models you can see in the webshop)		

1 mechanical components, equipment accessories



miscellaneous



1

Part No.	692776	Ref. No.	983.009.00
description	support bracket for heating element		
For models:	VS9040FRE15, VS9080FRE15		

for griddles

spare parts and accessories



1

Part No.	692889	Ref. No.	984.006.00
description	door magnet H 6mm ø 20mm M5 thread L 15mm		
For models:	V70120TPPCFG2, V90120TPPCFG2, VS70120B, VS70120CFG, VS70120CFGE, VS70120TPFG, VS7040B, VS7040CPES, VS7040CPGS, VS7040FRE10, VS7040FRE17X, VS7040FRE88, VS7040FRG17VL, VS7040FRGS13, VS7040GRL, VS7080B, VS7080CPES, VS7080CPGS, VS7080FRE10, VS7080FRE17X, VS7080FRG17VL, VS7080FRGS13, VS7080GRL, VS90120B, VS90120CFG, VS90120CFGE, VS90120PCGP, VS90120TPFG, VS9040B, VS9040CPES, VS9040CPGS, VS9040FRE15, VS-9040FRE17, VS9040FRE21, VS9040FRE88, VS9040FRG17VL, VS9040FRG21VL, VS9040FRGS13, VS9040FRGS20, VS9040GRL, VS9040PCGP, VS9080B, VS9080CPES, VS9080CPGS, VS9080FRE15, VS9080FRE17, VS9080FRE21, VS9080FRG17VL, VS9080FRG21VL, VS9080FRGS13... (Other models you can see in the webshop)		



1

Part No.	692779	Ref. No.	631.175.00
description	drain connection for griddle ø 45mm L 60mm W 85mm mounting distance 65mm		
For models:	V9080FTRRECRT, V9080FTRRGCR, VS7040FTET, VS7040FTGT, VS7040FTRET, VS7040FTRTGT, VS7080FTET, VS7080FTGT, VS7080FTRET, VS7080FTRTGT, VS7080FTRRET, VS7080FTRRTGT, VS9040FTECRT, VS-9040FTET, VS9040FTGCRT, VS9040FTGT, VS9040FTRECRT, VS9040FTRET, VS9040FTRGCR, VS9040FTRTGT, VS9080FTECRT, VS9080FTET, VS9080FTGCRT, VS9080FTGT, VS9080FTRECRT, VS9080FTRET, VS9080FTRGCRT, VS9080FTRGT, VS9080FTRRET, VS9080FTRRTGT		



1

Part No.	692795	Ref. No.	941.130.00
description	fixing plate L 35mm W 10mm H 8mm M5 mounting distance 17mm		
For models:	V080FTREVCRT, V70120TPPCFG2, V70120TPPCG2T, V7040FTREVCRT, V7040FTRGVCRT, V7080FTRGVCRT, V90120TPPCFG2, V90120TPPCG2T, V9040FTREVCRT, V9040FTRGVCRT, V9080FTREVCRT, V9080FTRGVCRT, V9080FTRRECRT, V9080FTRRGCR, VS70120CFG, VS70120CFGE, VS70120CFGG, VS70120PCGT, VS70120TPFG, VS7040BMET, VS-7040BMFEP, VS7040BMGT, VS7040CPES, VS7040CPGS, VS7040FRE10, VS7040FRE17X, VS7040FRE88, VS7040FRG17VL, VS7040FRGS13, VS7040FTET, VS7040FTEVCRT, VS7040FTEVT, VS7040FTGT, VS7040FTGVCRT, VS7040FTGVT, VS7040FTRET, VS7040FTREVT, VS7040FTRGT, VS7040FTRGVT, VS7040GRACQE, VS7040GRACQG, VS7040GRL, VS7040PCQET, VS7040PCET, VS7040PCGT, VS7040SPET, VS7080BMET, VS7080BMFEP, VS7080BMGT, VS7080BREI... (Other models you can see in the webshop)		



1

Part No.	692805	Ref. No.	683.028.00
description	hook for solid top L 360mm		
For models:	V70120TPPCFG2, V70120TPPCG2T, V90120TPPCFG2, V90120TPPCG2T, VS70120TPFG, VS7080TPFG, VS7080TPGT, VS7080TPPCFG, VS7080TPPCGT, VS90120TPFG, VS9080TPFG, VS9080TPGT, VS9080TPPCFG, VS9080TPPCGT		

sumps



1

Part No.	696805	Ref. No.	6111127.13
description	grease collecting tray for griddle L 175mm W 185mm H 110mm		
For models:	VS7040FTET, VS7040FTRET, VS9040FTECRT, VS9040FTET, VS9040FTRECRT, VS9040FTRET		



1	Part No.	696811	Ref. No.	6111249.00
	description	grease collecting tray for griddle L 270mm W 205mm H 110mm		
	For models:	V080FTREVCRT, V7080FTRGVCRT, V9080FTREVCRT, V9080FTRGVCRT, V9080FTRRGVCRT, VS7080FTEVCRT, VS7080FTEVT, VS7080FTGT, VS7080FTGVCRT, VS7080FTGVT, VS7080FTREVT, VS7080FTRGT, VS7080FTRGVT, VS7080FTRREVC, VS7080FTRREVT, VS7080FTRRGT, VS7080FTRRGVC, VS7080FTRRGVT, VS9080FTEVCRT, VS9080FTEVT, VS9080FTGVCRT, VS9080FTGVT, VS9080FTREVT, VS9080FTRGVCRT, VS9080FTRGT, VS9080FTRGVT, VS9080FTRREVC, VS9080FTRREVT, VS9080FTRRGT, VS9080FTRRGVC, VS9080FTRRGVT		

for convection ovens/combi-steamers

drain units

drip rails



1	Part No.	696855	Ref. No.	12039485
	description	drip rail L 540mm plastic W 44.5mm		
	For models:	AIC0037-F, AIC0038-F, AIC0039-F, AIC0040-F, AIC0071-F, AIC0072-F, AIC0076-F, AIC0077-F		

drain valves



1	Part No.	696854	Ref. No.	12126816
	description	drain fitting for combi-steamer		
	For models:	AIC0044-F, AIC0045-F, AIC0046-F		

1	Part No.	696858	Ref. No.	12043409
	description	bush ID ø 4mm ED ø 8mm L 5.5mm		
	For models:	AIC0037-F, AIC0038-F, AIC0039-F, AIC0040-F, AIC0041-F, AIC0043-F, AIC0044-F, AIC0045-F, AIC0046-F, AIC0071-F, AIC0072-F, AIC0073-F, AIC0074-F, AIC0075-F, AIC0076-F, AIC0077-F, AIC0079-F, AIC0080-F		

1	Part No.	696856	Ref. No.	12023506
	description	bush ID ø 7mm ED ø 11mm L 8mm		
	For models:	AIC0043-F, AIC0044-F, AIC0045-F, AIC0046-F, AIC0074-F, AIC0075-F, AIC0079-F, AIC0080-F		

steam generators

steam generators



1	Part No.	692897	Ref. No.	12046049
	description	steam generator L 290mm W 120mm H 300mm		
	For models:	AIC0039-F		



1	Part No.	692906	Ref. No.	12046048
	description	steam generator L 300mm W 120mm H 420mm		
	For models:	AIC0037-F		



Part No.	696836	Ref. No.	12046053
description	steam generator L 310mm W 120mm H 530mm		
For models:	AIC0041-F, AIC0043-F		

steam pipes



Part No.	521283	Ref. No.	12047930
description	steam pipe L 200mm W 85mm ø 53mm for combi-steamer steam generator		
For models:	AIC0037-F, AIC0039-F, AIC0041-F, AIC0043-F		

spare parts and accessories

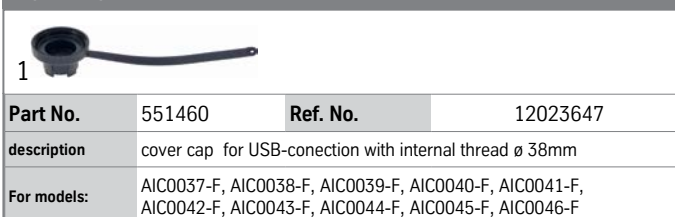

Part No.	551460	Ref. No.	12023647
description	cover cap for USB-connection with internal thread ø 38mm		
For models:	AIC0037-F, AIC0038-F, AIC0039-F, AIC0040-F, AIC0041-F, AIC0042-F, AIC0043-F, AIC0044-F, AIC0045-F, AIC0046-F		

hoses



Part No.	696852	Ref. No.	12024425
description	hose ID ø 30/23mm ED ø 36/30mm L 177mm for combi-steamer		
For models:	AIC0041-F, AIC0042-F, AIC0045-F, AIC0046-F		



Part No.	530918	Ref. No.	12039649
description	hose ID ø 30mm ED ø 40mm L 110mm for steam generator		
For models:	AIC0038-F, AIC0040-F, AIC0041-F, AIC0042-F, AIC0043-F, AIC0044-F, AIC0045-F, AIC0046-F		



Part No.	530919	Ref. No.	12044832
description	hose ID ø 73mm ED ø 85mm L 150mm for steam generator		
For models:	AIC0046-F		

door mechanics

accessories



Part No.	696851	Ref. No.	12022138
description	base plate W 40mm zinc-plated sheet steel L 44mm		
For models:	AIC0043-F, AIC0044-F, AIC0045-F, AIC0046-F, AIC0074-F, AIC0075-F, AIC0079-F, AIC0080-F		

miscellaneous

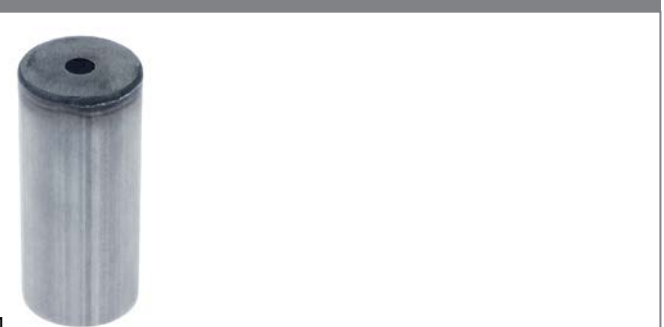

Part No.	692330	Ref. No.	12022242
description	atomizer for combi-steamer L 97mm ø 43mm hole ø 10mm		
For models:	AIC0074-F		





1

Part No.	691695	Ref. No.	12024231
description	duct for flues D1 ø 80mm D2 ø 55mm rubber		
For models:	AIC0037-F, AIC0038-F, AIC0039-F, AIC0040-F, AIC0041-F, AIC0042-F, AIC0043-F, AIC0044-F, AIC0071-F, AIC0072-F, AIC0073-F, AIC0074-F, AIC0076-F, AIC0077-F, AIC0078-F, AIC0079-F		



1

Part No.	698491	Ref. No.	12024419 12113061
description	level tank level control bore ø 17mm L 205mm thread M12 W 28mm ø 20.5mm H 80mm		
For models:	AIC0037-F, AIC0038-F, AIC0039-F, AIC0040-F, AIC0041-F, AIC0042-F, AIC0043-F, AIC0044-F, AIC0045-F, AIC0046-F		



1

Part No.	696427	Ref. No.	12009970
description	rivet nut thread M5 DN 4mm L 12mm SS Qty 1 pcs ø 7mm WS 6		
For models:	AIC0037-F, AIC0038-F, AIC0039-F, AIC0040-F, AIC0041-F, AIC0042-F, AIC0043-F, AIC0044-F, AIC0045-F, AIC0046-F, AIC0071-F, AIC0072-F, AIC0073-F, AIC0074-F, AIC0075-F, AIC0076-F, AIC0077-F, AIC0078-F, AIC0079-F, AIC0080-F		



1

Part No.	542288	Ref. No.	12024796
description	valve body for combi-steamer hose ø 24mm		
For models:	AIC0037-F, AIC0038-F, AIC0039-F, AIC0040-F, AIC0041-F, AIC0042-F, AIC0043-F, AIC0044-F, AIC0045-F, AIC0046-F		

for tilting bratt pans

spare parts and accessories



1

Part No.	699598	Ref. No.	941.154.00
description	bolt L 24mm ø 14mm for tilting bratt pan		
For models:	VS7080BREI, VS7080BREIM, VS7080BRGI, VS7080BRGIM, VS9080BREI, VS9080BREIM, VS9080BRGI, VS9080BRGIM		



1

Part No.	694964	Ref. No.	941.164.00
description	bolt L 78mm ø 10mm stainless steel		
For models:	VS7080BREIM, VS7080BRGIM, VS9080BREIM, VS9080BRGIM		



1

Part No.	694976	Ref. No.	9111769.00
description	bracket for spindle zinc-coated steel mounting pos. centre		
For models:	VS7080BREI, VS7080BREIM, VS7080BRGI, VS7080BRGIM, VS9080BREI, VS9080BREIM, VS9080BRGI, VS9080BRGIM		



1

Part No.	514518	Ref. No.	951.069.00
description	disc ø 17.5mm plastic		
For models:	VS7080BREI, VS7080BRGI, VS9080BREI, VS9080BRGI		



1

Part No.	692773	Ref. No.	941.157.00
description	fixing plate L 60mm W 40mm H 15mm		
For models:	VS7080BREI, VS7080BREIM, VS7080BRGI, VS7080BRGIM, VS9080BREI, VS9080BREIM, VS9080BRGI, VS9080BRGIM		



1

Part No.	542394	Ref. No.	256.466.00
description	inlet spout connection 1/2" tube ø 25mm overall height 150mm rotation°		
For models:	VS7080BREI, VS7080BREIM, VS7080BRGI, VS7080BRGIM, VS9080BREI, VS9080BREIM, VS9080BRGI, VS9080BRGIM		



1

Part No.	551432	Ref. No.	561.012.00
description	terminal plastic		
For models:	VS7080BREIM, VS7080BRGIM, VS9080BREIM, VS9080BRGIM		



1

Part No.	542390	Ref. No.	0777.10073.8 M538003000
description	thread bolt thread M10x1.5		
For models:	VS7080BREI, VS7080BREIM, VS7080BRGI, VS7080BRGIM, VS9080BREI, VS9080BREIM, VS9080BRGI, VS9080BRGIM		



1

Part No.	699450	Ref. No.	256.460.00
description	mounting set for hinge		
For models:	VS7080BREI, VS7080BREIM, VS7080BRGI, VS7080BRGIM, VS9080BREI, VS9080BREIM, VS9080BRGI, VS9080BRGIM		

housing and bezels



1

Part No.	692799	Ref. No.	256.304.00
description	protector ø 108mm plastic		
For models:	VS7080BRGI, VS7080BRGIM, VS7080PG50, VS7080PGI50, VS9080BRGI, VS9080BRGIM, VS9080PGI150		



1

Part No.	699597	Ref. No.	256.461.00
description	mounting set for hinge for lid WS 13		
For models:	VS7080BREI, VS7080BREIM, VS7080BRGI, VS7080BRGIM, VS9080BREI, VS9080BREIM, VS9080BRGI, VS9080BRGIM		

spindles



1

Part No.	692887	Ref. No.	941.163.00
description	bearing block hinge for tilting bratt pan ø 20mm ID ø 15.5mm L 54mm		
For models:	VS7080BREIM, VS7080BRGIM, VS9080BREIM, VS9080BRGIM		



1

Part No.	692777	Ref. No.	941.165.00
description	spacer bush thickness 2.3mm ID ø 10mm ED ø 15mm H 19mm		
For models:	VS7080BREIM, VS7080BRGIM, VS9080BREIM, VS9080BRGIM		



1

Part No.	692891	Ref. No.	910.732.00
description	threaded rod for tilting bratt pan ID ø 25mm ED ø 30mm L 670mm		
For models:	VS7080BREI, VS7080BRGI, VS9080BREI, VS9080BRGI		



1

Part No.	530900	Ref. No.	941.162.00
description	threaded rod thread M12x1.5 zinc-coated steel thread L 80mm		
For models:	VS7080BREIM, VS7080BRGIM, VS9080BREIM, VS9080BRGIM		



miscellaneous



1

Part No.	692888	Ref. No.	941.181.00
description	fixing bolt L 35mm ø 12mm for tilting bratt pan WS 19		
For models:	VS7080BREI, VS7080BRGI, VS9080BREI, VS9080BRGI		
accessories for	692888		
	Part No.	692798	Ref. No. 256.471.00
	fixing bolt L 35mm ø 12mm with nut with disc tilting bratt pan WS 19		



1

Part No.	692798	Ref. No.	256.471.00
description	fixing bolt L 35mm ø 12mm with nut with disc tilting bratt pan WS 19		
For models:	VS7080BREI, VS7080BRGI, VS9080BREI, VS9080BRGI		
spare parts for	692798		
	Part No.	692888	Ref. No. 941.181.00
	fixing bolt L 35mm ø 12mm for tilting bratt pan WS 19		

for boiling pans

spare parts and accessories



1

Part No.	692783	Ref. No.	941.139.15
description	adjusting bush for kettle ø 40/20mm L 80mm		
For models:	VS7080PEI50, VS7080PG50, VS7080PGI50		



1

Part No.	514517	Ref. No.	641.149.00
description	bracket for kettle		
For models:	VS7080PEI50, VS7080PG50, VS7080PGI50		



1

Part No.	514528	Ref. No.	941.137.00
description	bush for kettle lid ø 39mm ID ø 16mm H 12mm		
For models:	VS7080PEI50, VS7080PG50, VS7080PGI50, VS9080PEI150, VS9080PGI150		



1

Part No.	692797	Ref. No.	941.138.00
description	bush for kettle ø 39mm L 55mm		
For models:	VS7080PEI50, VS7080PG50, VS7080PGI50, VS9080PEI150, VS9080PGI150		



1

Part No.	692782	Ref. No.	641.150.00
description	spindle for kettle L 285mm ED ø 16mm		
For models:	VS7080PEI50, VS7080PG50, VS7080PGI50		



1

Part No.	692787	Ref. No.	631.195.00
description	threaded part brass L 160mm ID ø 34mm 1 1/2"		
For models:	VS7080PEI50, VS7080PG50, VS7080PGI50		



1

Part No.	692801	Ref. No.	931.213.00
description	threaded part for drain tap L 140mm thread 2"		
For models:	VS9080PEI150, VS9080PGI150		

filters



1

Part No.	514521	Ref. No.	611.373.00
description	drain filter for kettle L 145mm W 75mm		
For models:	VS7080PEI50, VS7080PG50, VS7080PGI50, VS9080PEI150, VS9080PGI150		

miscellaneous



1

Part No.	542398	Ref. No.	678.082.00
description	water inlet for kettle fixed		
For models:	VS7080PEI50, VS7080PG50, VS7080PGI50, VS9080PEI150, VS9080PGI150		

for lava stone grill



1

Part No.	692889	Ref. No.	984.006.00
description	door magnet H 6mm ø 20mm M5 thread L 15mm		
For models:	V70120TPPCFG2, V90120TPPCFG2, VS70120B, VS70120CFG, VS70120CFGE, VS70120TPFG, VS7040B, VS7040CPES, VS7040CPGS, VS7040FRE10, VS7040FRE17X, VS7040FRE88, VS7040FRG17VL, VS7040FRGS13, VS7040GRL, VS7080B, VS7080CPES, VS7080CPGS, VS7080FRE10, VS7080FRE17X, VS7080FRG17VL, VS7080FRGS13, VS7080GRL, VS90120B, VS90120CFG, VS90120CFGE, VS90120PCGP, VS90120TPFG, VS9040B, VS9040CPES, VS9040CPGS, VS9040FRE15, VS-9040FRE17, VS9040FRE21, VS9040FRE88, VS9040FRG17VL, VS9040FRG21VL, VS9040FRGS13, VS9040FRGS20, VS9040GRL, VS9040PCGP, VS9080B, VS9080CPES, VS9080CPGS, VS9080FRE15, VS9080FRE17, VS9080FRE21, VS9080FRG17VL, VS9080FRG21VL, VS9080FRGS13... (Other models you can see in the webshop)		



1

Part No.	692892	Ref. No.	9221341.00
description	grease collecting tray L 750mm W 157mm H 22mm		
For models:	VS9040GRL, VS9080GRL		



1

Part No.	692809	Ref. No.	512.002.00
description	level glass size 35x35 2 bracket mounting for lava rock grill		
For models:	VS7040GRL, VS7080GRL, VS9040GRL, VS9080GRL		

for neutral elements

doors



1

Part No.	692889	Ref. No.	984.006.00
description	door magnet H 6mm ø 20mm M5 thread L 15mm		
For models:	V70120TPPCFG2, V90120TPPCFG2, VS70120B, VS70120CFG, VS70120CFGE, VS70120TPFG, VS7040B, VS7040CPES, VS7040CPGS, VS7040FRE10, VS7040FRE17X, VS7040FRE88, VS7040FRG17VL, VS7040FRGS13, VS7040GRL, VS7080B, VS7080CPES, VS7080CPGS, VS7080FRE10, VS7080FRE17X, VS7080FRG17VL, VS7080FRGS13, VS7080GRL, VS90120B, VS90120CFG, VS90120CFGE, VS90120PCGP, VS90120TPFG, VS9040B, VS9040CPES, VS9040CPGS, VS9040FRE15, VS-9040FRE17, VS9040FRE21, VS9040FRE88, VS9040FRG17VL, VS9040FRG21VL, VS9040FRGS13, VS9040FRGS20, VS9040GRL, VS9040PCGP, VS9080B, VS9080CPES, VS9080CPGS, VS9080FRE15, VS9080FRE17, VS9080FRE21, VS9080FRG17VL, VS9080FRG21VL, VS9080FRGS13... (Other models you can see in the webshop)		



for pasta cookers

spare parts and accessories



1

Part No.	692889	Ref. No.	984.006.00
description	door magnet H 6mm ø 20mm M5 thread L 15mm		
For models:	V70120TPPCFG2, V90120TPPCFG2, VS70120B, VS70120CFG, VS70120CFGE, VS70120TPFG, VS7040B, VS7040CPES, VS7040CPGS, VS7040FRE10, VS7040FRE17X, VS7040FRE88, VS7040FRG17VL, VS7040FRGS13, VS7040GRL, VS7080B, VS7080CPES, VS7080CPGS, VS7080FRE10, VS7080FRE17X, VS7080FRG17VL, VS7080FRGS13, VS7080GRL, VS90120B, VS90120CFG, VS90120CFGE, VS90120PCGP, VS90120TPFG, VS9040B, VS9040CPES, VS9040CPGS, VS9040FRE15, VS-9040FRE17, VS9040FRE21, VS9040FRE88, VS9040FRG17VL, VS9040FRG21VL, VS9040FRGS13, VS9040FRGS20, VS9040GRL, VS9040PCGP, VS9080B, VS9080CPES, VS9080CPGS, VS9080FRE15, VS9080FRE17, VS9080FRE21, VS9080FRG17VL, VS9080FRG21VL, VS9080FRGS13... (Other models you can see in the webshop)		



1

Part No.	692795	Ref. No.	941.130.00
description	fixing plate L 35mm W 10mm H 8mm M5 mounting distance 17mm		
For models:	V080FTREVCRT, V70120TPPCFG2, V70120TPPCG2T, V7040FTREVCRT, V7040FTRGVCRT, V7080FTRGVCRT, V90120TPPCFG2, V90120TPPCG2T, V9040FTREVCRT, V9040FTRGVCRT, V9080FTREVCRT, V9080FTRGVCRT, V9080FTRRECR, V9080FTRRGCR, VS70120CFG, VS70120CFGE, VS70120CFGG, VS70120PCGT, VS70120TPFG, VS7040BMET, VS-7040BMFEP, VS7040BMGT, VS7040CPES, VS7040CPGS, VS7040FRE10, VS7040FRE17X, VS7040FRE88, VS7040FRG17VL, VS7040FRGS13, VS7040FTET, VS7040FTEVCRT, VS7040FTEVT, VS7040FTGT, VS7040FTGVCRT, VS7040FTGVT, VS7040FTRET, VS7040FTREVT, VS7040FTRGT, VS7040FTRGVT, VS7040GRACQE, VS7040GRACQG, VS7040GRL, VS7040PCEQT, VS7040PCET, VS7040PCGT, VS7040SPET, VS7080BMET, VS7080BMFEP, VS7080BMGT, VS7080BREI... (Other models you can see in the webshop)		



1

Part No.	699392	Ref. No.	256.216.00
description	hinge 1 pair for door		
For models:	V70120TPPCFG2, V90120TPPCFG2, VS70120B, VS70120CFG, VS70120CFGE, VS70120TPFG, VS7040B, VS7040CPES, VS7040CPGS, VS7040FRE10, VS7040FRE17X, VS7040FRE88, VS7040FRG17VL, VS7040FRGS13, VS7040GRL, VS7080B, VS7080CPES, VS7080CPGS, VS7080FRE10, VS7080FRE17X, VS7080FRG17VL, VS7080FRGS13, VS7080GRL, VS90120B, VS90120CFG, VS90120CFGE, VS90120PCGP, VS90120TPFG, VS9040B, VS9040CPES, VS9040CPGS, VS9040FRE15, VS-9040FRE17, VS9040FRE21, VS9040FRE88, VS9040FRG17VL, VS9040FRG21VL, VS9040FRGS13, VS9040FRGS20, VS9040GRL, VS9040PCGP, VS9080B, VS9080CPES, VS9080CPGS, VS9080FRE15, VS9080FRE17, VS9080FRE21, VS9080FRG17VL, VS9080FRG21VL, VS9080FRGS13... (Other models you can see in the webshop)		



1

Part No.	542393	Ref. No.	256.313.00
description	inlet spout connection 3/8" tube ø 12mm overall height 67mm rotation°		
For models:	VS7040CPES, VS7040CPGS, VS7080CPES, VS7080CPGS, VS9040CPES, VS9040CPGS, VS9080CPES, VS9080CPGS		

1
mechanical components,
equipment accessories



1

Part No.	692796	Ref. No.	256.431.00
description	mounting set hexagon L 31mm thread M5		
For models:	VS70120B, VS7040B, VS7040CPES, VS7040CPGS, VS7040FRE10, VS7040FRE17X, VS7040FRE88, VS7040FRG17VL, VS7040FRGS13, VS7040GRL, VS7080B, VS7080CPES, VS7080CPGS, VS7080FRE10, VS7080FRE17X, VS7080FRG17VL, VS7080FRGS13, VS7080GRL, VS90120B, VS90120PCGP, VS9040B, VS9040CPES, VS9040CPGS, VS-9040FRE15, VS9040FRE17, VS9040FRE21, VS9040FRE88, VS9040FRG-17VL, VS9040FRG21VL, VS9040FRGS13, VS9040FRGS20, VS9040GRL, VS9040PCGP, VS9080B, VS9080CPES, VS9080CPGS, VS9080FRE15, VS9080FRE17, VS9080FRE21, VS9080FRG17VL, VS9080FRG21VL, VS9080FRGS13, VS9080FRGS20, VS9080GRL, VS9080PCGP		

for ovens

spare parts and accessories



1

Part No.	692889	Ref. No.	984.006.00
description	door magnet H 6mm ø 20mm M5 thread L 15mm		
For models:	V70120TPPCFG2, V90120TPPCFG2, VS70120B, VS70120CFG, VS70120CFGE, VS70120TPFG, VS7040B, VS7040CPES, VS7040CPGS, VS7040FRE10, VS7040FRE17X, VS7040FRE88, VS7040FRG17VL, VS7040FRGS13, VS7040GRL, VS7080B, VS7080CPES, VS7080CPGS, VS7080FRE10, VS7080FRE17X, VS7080FRG17VL, VS7080FRGS13, VS7080GRL, VS90120B, VS90120CFG, VS90120CFGE, VS90120PCGP, VS90120TPFG, VS9040B, VS9040CPES, VS9040CPGS, VS9040FRE15, VS-9040FRE17, VS9040FRE21, VS9040FRE88, VS9040FRG17VL, VS9040FRG21VL, VS9040FRGS13, VS9040FRGS20, VS9040GRL, VS9040PCGP, VS9080B, VS9080CPES, VS9080CPGS, VS9080FRE15, VS9080FRE17, VS9080FRE21, VS9080FRG17VL, VS9080FRG21VL, VS9080FRGS13... (Other models you can see in the webshop)		



1

Part No.	692795	Ref. No.	941.130.00
description	fixing plate L 35mm W 10mm H 8mm M5 mounting distance 17mm		
For models:	V080FTREVCRT, V70120TPPCFG2, V70120TPPCG2T, V7040FTREVCRT, V7040FTRGVCRT, V7080FTRGVCRT, V90120TPPCFG2, V90120TPPCG2T, V9040FTREVCRT, V9040FTRGVCRT, V9080FTREVCRT, V9080FTRGVCRT, V9080FTRRECR, V9080FTRRGCR, VS70120CFG, VS70120CFGE, VS70120CFGG, VS70120PCGT, VS70120TPFG, VS7040BMET, VS-7040BMFEP, VS7040BMGT, VS7040CPES, VS7040CPGS, VS7040FRE10, VS7040FRE17X, VS7040FRE88, VS7040FRG17VL, VS7040FRGS13, VS7040FTET, VS7040FTEVCRT, VS7040FTEVT, VS7040FTGT, VS7040FTGVCRT, VS7040FTGVT, VS7040FTRET, VS7040FTREVT, VS7040FTRGT, VS7040FTRGVT, VS7040GRACQE, VS7040GRACQG, VS7040GRL, VS7040PCEQT, VS7040PCET, VS7040PCGT, VS7040SPET, VS7080BMET, VS7080BMFEP, VS7080BMGT, VS7080BREI... (Other models you can see in the webshop)		



1

Part No.	692774	Ref. No.	6221484.00
description	fixing plate L 60mm W 40mm H 1.5mm		
For models:	VS7080CFVE, VS7080PVET, VS9040PVET, VS9080CFVE, VS9080PVET		



1

Part No.	692805	Ref. No.	683.028.00
description	hook for solid top L 360mm		
For models:	V70120TPPCFG2, V70120TPPCG2T, V90120TPPCFG2, V90120TPPCG2T, VS70120TPFG, VS7080TPFG, VS7080TPGT, VS7080TPPCFG, VS7080TPPCGT, VS90120TPFG, VS9080TPFG, VS9080TPGT, VS9080TPPCFG, VS9080TPPCGT		



1

Part No.	692796	Ref. No.	256.431.00
description	mounting set hexagon L 31mm thread M5		
For models:	VS70120B, VS7040B, VS7040CPES, VS7040CPGS, VS7040FRE10, VS7040FRE17X, VS7040FRE88, VS7040FRG17VL, VS7040FRGS13, VS7040GRL, VS7080B, VS7080CPES, VS7080CPGS, VS7080FRE10, VS7080FRE17X, VS7080FRG17VL, VS7080FRGS13, VS7080GRL, VS90120B, VS90120PCGP, VS9040B, VS9040CPES, VS9040CPGS, VS-9040FRE15, VS9040FRE17, VS9040FRE21, VS9040FRE88, VS9040FRG-17VL, VS9040FRG21VL, VS9040FRGS13, VS9040FRGS20, VS9040GRL, VS9040PCGP, VS9080B, VS9080CPES, VS9080CPGS, VS9080FRE15, VS9080FRE17, VS9080FRE21, VS9080FRG17VL, VS9080FRG21VL, VS9080FRGS13, VS9080FRGS20, VS9080GRL, VS9080PCGP		



miscellaneous



1

Part No.	699368	Ref. No.	935.045.13
description	bottom plate L 640mm W 425mm H 5mm SS		
For models:	VS70120CFGG, VS90120CFGG		

for dishwashers

boilers

boilers for dishwashers



1

Part No.	501511	Ref. No.	104061
description	boiler ø 145mm L 420mm hose ø 18/27mm		
For models:	GLB0043C-60Hz		

accessories



1

Part No.	518348	Ref. No.	468117
description	hose connector		
For models:	GLB0041, GLB0042, GLB0043C, GLB0044C		



1

Part No.	518671	Ref. No.	12097453
description	hose connector for boiler L 54mm hose ø 10mm		
For models:	GLB0067-F, GLB0069-F, GLB0071-F, GLB0080, GLB0081, GLB0082		

gaskets



1

Part No.	699343	Ref. No.	12048366
description	gasket L 118mm W 73mm H 9mm thickness 9mm		
For models:	GLB0071-F, GLB0080		



1

Part No.	698802	Ref. No.	35510
description	gasket L 65mm W 10mm H 4mm thickness 4mm		
For models:	GLB0040		

housing and bezels

flanges



1

Part No.	699252	Ref. No.	75057
description	flange H 40mm ø 130mm mounting pos. lower		
For models:	GLB0045, GLB0047, GLB0048, GLB0049, GLB0050, GLB0051		



1

Part No.	699251	Ref. No.	75141
description	flange H 65mm ø 130mm mounting pos. upper		
For models:	GLB0045, GLB0047, GLB0048, GLB0049, GLB0050, GLB0051		



1

Part No.	699345	Ref. No.	K75057
description	flange with ring gasket H 35mm ø 130mm		
For models:	GLB0047		



1

Part No.	699346	Ref. No.	K75141
description	flange with ring gasket H 35mm ø 130mm mounting pos. upper M6		
For models:	GLB0047		



gearboxes



1

Part No.	518634	Ref. No.	927102
description	gearbox motor shaft \varnothing 14mm flange \varnothing 160mm drive shaft \varnothing 25mm type VF49A60		
For models:	GLB0047, GLB0048		

hood mechanics for dishwashers

bushes



1

Part No.	505272	Ref. No.	12025255
description	bush ED \varnothing 22mm ID \varnothing 10mm L 7mm plastic		
For models:	GLB0071-F, GLB0080, GLB0082		

guide bars



1

Part No.	698803	Ref. No.	41038
description	sliding rail L 458mm mounting pos. rear W 21mm H 20mm		
For models:	GLB0041, GLB0042, GLB0043C, GLB0044C		

miscellaneous



1

Part No.	698811	Ref. No.	41100
description	door bumper ED \varnothing 20mm H 20mm		
For models:	GLB0043C-60Hz		



1

Part No.	508375	Ref. No.	80105
description	fixing support		
For models:	GLB0040		

basket guides

basket holders



1

Part No.	699347	Ref. No.	75076
description	buffer for basket transport L 25m \varnothing 17.5mm		
For models:	GLB0045, GLB0047, GLB0048, GLB0049, GLB0050, GLB0051		



1

Part No.	699344	Ref. No.	75058
description	roller for basket H 35mm \varnothing 45mm		
For models:	GLB0045, GLB0047, GLB0048, GLB0049, GLB0050, GLB0051		

air traps

air traps



1

Part No.	519499	Ref. No.	107012
description	air trap L 46mm W 35mm H 72mm thread 3/4" hose \varnothing 5.5mm plastic		
For models:	GLB0043C-60Hz		

accessories for	519499			
	Part No.	516261	Ref. No.	437098
	Part No.	519498	Ref. No.	417120





1

Part No.	518200	Ref. No.	984005
description	air trap \varnothing 34mm H 78mm hose \varnothing 6mm plastic		
For models:	GLB0040, GLB0041, GLB0042, GLB0043C, GLB0044C, GLB0045, GLB0047, GLB0048, GLB0049, GLB0050, GLB0051		

spare parts for	518200			
	Part No.	504618	Ref. No.	—

Table continues overleaf



spare parts for		518200	
	Part No.	510075	Ref. No. —
	flat gasket rubber ED ø 22mm ID ø 13mm thickness 1.5mm Qty 1 pcs		
	Part No.	510106	Ref. No. —
	hose connector for air trap		

			
1			
Part No.	524810	Ref. No.	144032
description	air trap W 95mm H 150mm hose ø 6/8mm plastic		
For models:	GLB0043C-60Hz		

mechanics for flight type dishwashers			
			
1			
Part No.	699351	Ref. No.	75231 K75649
description	cover for eccentrics plastic D1 ø 147mm D2 ø 32.6mm		
For models:	GLB0045, GLB0047, GLB0048, GLB0049, GLB0050, GLB0051		

			
1			
Part No.	504423	Ref. No.	927048
description	protector L 230mm W 95mm H 16mm hole ø 25x7mm thickness 4mm		
For models:	GLB0045, GLB0047, GLB0048, GLB0049, GLB0050, GLB0051		

pipes			
			
1			
Part No.	698771	Ref. No.	42028
description	aspiration tube tube ø 60.5mm L 87mm ID ø 57mm		
For models:	GLB0041, GLB0043C-60Hz, GLB0047, GLB0049		

backflow preventers			
			
1			
Part No.	518486	Ref. No.	144010
description	backflow preventer connection 1/2" dishwasher hose ø 12mm		
For models:	GLB0045, GLB0047, GLB0048, GLB0049, GLB0050, GLB0051		

miscellaneous			
			
1			
Part No.	519481	Ref. No.	927110
description	heater battery L 440mm W 260mm H 195mm		
For models:	GLB0045, GLB0047, GLB0048, GLB0049, GLB0050, GLB0051		

			
1			
Part No.	698716	Ref. No.	CWP2
description	PCB support L 34mm		
For models:	GLB0043C-60Hz		

			
1			
Part No.	698871	Ref. No.	419036
description	spacer for PCB L 18mm W 6mm D1 ø 6mm D2 ø 3mm		
For models:	GLB0043C-60Hz, GLB0047		



door mechanics

spare parts and accessories



1

Part No.	507579	Ref. No.	75064
description	catch hook for door		
For models:	GLB0047, GLB0048, GLB0049, GLB0050, GLB0051		



1

Part No.	507580	Ref. No.	75226
description	catch hook for door		
For models:	GLB0045, GLB0047, GLB0048, GLB0049, GLB0050, GLB0051		

linkage



1

Part No.	698800	Ref. No.	44593
description	bar L 670mm thread M6/M10 \varnothing 10mm		
For models:	GLB0043C-60Hz		

sliding plates



1

Part No.	517801	Ref. No.	307012
description	sliding plate L 75mm W 12mm H 10mm		
For models:	GLB0040		

hinges



1

Part No.	504797	Ref. No.	35060
description	door hinge mounting pos. left \varnothing 10mm L 70mm		
For models:	GLB0040		

door seals

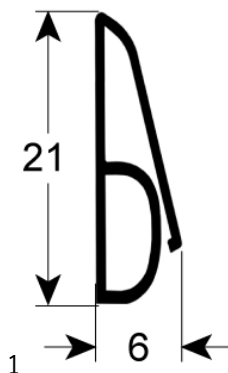

1

Part No.	512471	Ref. No.	41583
description	door seal L 740mm W 21mm		
For models:	GLB0041		

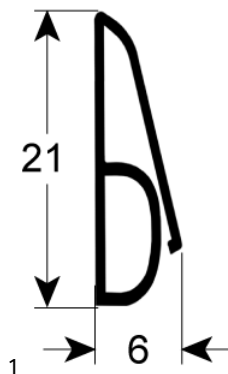

1

Part No.	512460	Ref. No.	42783
description	door seal L 800mm W 21mm		
For models:	GLB0043C-60Hz		

door frames



1

Part No.	901694	Ref. No.	41197
description	frame for door mounting pos. upper W 34mm L 595mm SS mounting distance 225mm		
For models:	GLB0041, GLB0042		

miscellaneous



1

Part No.	698748	Ref. No.	35013
description	side panel for door L 235mm W 100mm thickness 2mm		
For models:	GLB0040		



screw connections



1

Part No.	519498	Ref. No.	417120
description	nut thread 3/4" H 10mm WS 30 plastic Qty 1 pcs		
For models:	GLB0043C-60Hz		



1

Part No.	504369	Ref. No.	12007871
description	nut thread 5/8" pipe (22.7mm) H 7.3mm WS 32 brass Qty 1 pcs		
For models:	GLB0082		



1

Part No.	698874	Ref. No.	417119
description	nut thread M3 H 3.5mm plastic Qty 1 pcs for PCB		
For models:	GLB0043C-60Hz, GLB0047		



1

Part No.	698876	Ref. No.	486078
description	screw thread M6x30mm Qty 1 pcs SS		
For models:	GLB0041, GLB0043C, GLB0043C-60Hz, GLB0044C, GLB0045, GLB0047, GLB0048, GLB0049, GLB0050, GLB0051		

curtains

curtains



1

Part No.	533008	Ref. No.	75120
description	curtain W 540mm H 405mm plastic thickness 1.3mm		
For models:	GLB0045, GLB0047, GLB0048, GLB0049, GLB0050, GLB0051		
accessories for	533008		
	Part No.	Ref. No.	75121
	curtain rod L 545mm ø 8mm		



1

Part No.	533018	Ref. No.	77120
description	curtain W 585mm H 400mm		
For models:	GLB0048		



1

Part No.	533007	Ref. No.	75123
description	curtain W 620mm H 250mm thickness 1.4mm		
For models:	GLB0045, GLB0047, GLB0048, GLB0049, GLB0050, GLB0051		

curtain rods



1

Part No.	533009	Ref. No.	75121
description	curtain rod L 545mm ø 8mm		
For models:	GLB0045, GLB0047, GLB0048, GLB0049, GLB0050, GLB0051		



1

Part No.	533019	Ref. No.	75124
description	curtain rod L 620mm ø 8mm		
For models:	GLB0045, GLB0047, GLB0048, GLB0049, GLB0050, GLB0051		

washing and rinsing systems



1

Part No.	505040	Ref. No.	12110631
description	bush for wash arm		
For models:	GLB0067-F, GLB0069-F, GLB0081		





			
1			
Part No.	505041	Ref. No.	12025116
description	bush for wash arm		
For models:	GLB0071-F, GLB0080, GLB0082		

			
1			
Part No.	517568	Ref. No.	41064
description	counterflange for wash arm support \varnothing 69mm ID \varnothing 63mm H 35mm mounting distance 64mm hole \varnothing 7mm		
For models:	GLB0041, GLB0042, GLB0043C, GLB0043C-60Hz, GLB0044C		
accessories for	517568		
	Part No.	531605	Ref. No. 42053
	extension for rinsing shaft \varnothing 16mm H 122mm thread L 12mm WS 19		
	Part No.	532603	Ref. No. 926252
	O-ring EPDM thickness 3.53mm ID \varnothing 69.85mm Qty 1 pcs		
	Part No.	698750	Ref. No. 41185
	throttle disc \varnothing 71.5mm hole \varnothing 17/22mm		

			
1			
Part No.	517441	Ref. No.	41064CP
description	counterflange for wash arm support with throttle disc \varnothing 70mm ID \varnothing 63mm L 110mm W 89mm H 35mm		
For models:	GLB0041, GLB0042, GLB0043C, GLB0043C-60Hz, GLB0044C		
spare parts for	517441		
	Part No.	698750	Ref. No. 41185
	throttle disc \varnothing 71.5mm hole \varnothing 17/22mm		
accessories for	517441		
	Part No.	531605	Ref. No. 42053
	extension for rinsing shaft \varnothing 16mm H 122mm thread L 12mm WS 19		
	Part No.	532603	Ref. No. 926252
	O-ring EPDM thickness 3.53mm ID \varnothing 69.85mm Qty 1 pcs		

			
1			
Part No.	518240	Ref. No.	437078
description	flat gasket rubber ED \varnothing 33mm ID \varnothing 17mm thickness 1.5mm Qty 1 pcs		
For models:	GLB0040, GLB0041, GLB0042, GLB0043C, GLB0044C		

			
1			
Part No.	513158	Ref. No.	80365
description	knurled nut		
For models:	GLB0041, GLB0042, GLB0043C, GLB0044C		

			
1			
Part No.	518238	Ref. No.	143173
description	manifold \varnothing 12mm L 98mm		
For models:	GLB0041, GLB0042, GLB0043C, GLB0043C-60Hz, GLB0045, GLB0047, GLB0048, GLB0049, GLB0050, GLB0051		

			
1			
Part No.	518089	Ref. No.	80184
description	retaining ring for wash arm ID \varnothing 40mm ED \varnothing 44mm thickness 3mm		
For models:	GLB0040		

			
1			
Part No.	518434	Ref. No.	429050
description	rinse arm support mounting pos. upper		
For models:	GLB0040, GLB0041, GLB0042, GLB0043C, GLB0044C		

			
1			
Part No.	518443	Ref. No.	468165
description	rinse arm support mounting pos. upper		
For models:	GLB0040, GLB0041, GLB0042, GLB0043C, GLB0044C, GLB0045, GLB0047, GLB0048, GLB0049, GLB0050, GLB0051		

1

Part No.	513286	Ref. No.	80281
description	screw connection		
For models:	GLB0040		



1

Part No.	513270	Ref. No.	80316
description	throttle disc		
For models:	GLB0040		



1

Part No.	501546	Ref. No.	12048173
description	wash arm support mounting pos. upper ø 42mm H 78mm L1 340mm		
For models:	GLB0071-F, GLB0080		
accessories for	501546		
	Part No.	532103	Ref. No. 12049214
	O-ring EPDM thickness 3.53mm ID ø 13.87mm Qty 10 pcs		
	Part No.	699343	Ref. No. 12048366
	gasket L 118mm W 73mm H 9mm thickness 9mm		



1

Part No.	519493	Ref. No.	75165
description	wash pipe ø 48mm L 617mm plastic		
For models:	GLB0045, GLB0047, GLB0048, GLB0050, GLB0051		

for woks



1

Part No.	694580	Ref. No.	955.016.00
description	wok bowl for induction wok ø 310mm H 69mm Ceran		
For models:	VS9040INDWT		

knobs

accessories

gaskets



1

Part No.	691074	Ref. No.	12024516
description	gasket switch shaft		
For models:	GLB0067-F, GLB0069-F		

handles and hand wheels

hand wheels

hand wheels



1

Part No.	694351	Ref. No.	951.000.00
description	hand wheel ø 200mm D1 ø 40mm bore ø 18mm depth of bore 23mm thread M6 hole distance 9mm groove widthmm L1 40mm L2 60mm handle length 108mm with folding handle		
For models:	VS7080BREI, VS7080BRGI, VS9080BREI, VS9080BRGI		



cylindrical handles

fixed



1

Part No.	691314	Ref. No.	651.012.00
description	cylindrical handle thread M8 ø 28mm L 86mm		
For models:	VS7080PEI50, VS7080PG50, VS7080PGI50		

bracket handles



1

Part No.	502297	Ref. No.	9211711.00
description	pull handle L 230mm H 65mm mounting distance 180mm for oven right stainless steel		
For models:	V70120TPPCFG2, VS70120B, VS70120CFG, VS70120CFGE, VS70120TPFG, VS7040GRACQE, VS7040GRACQG, VS7080B, VS7080CPES, VS7080CPGS, VS7080FRE10, VS7080FRE17X, VS7080FRG17VL, VS7080FRGS13, VS7080GRACQE, VS7080GRACQG, VS7080GRL, VS7080TPFG, VS90120B, VS90120CFG, VS90120CFGE, VS90120PCGP, VS90120TPFG, VS9040GRACQE, VS9040GRACQG, VS9080B, VS9080CPES, VS9080CPGS, VS9080FRE15, VS9080FRE17, VS-9080FRE21, VS9080FRG17VL, VS9080FRG21VL, VS9080FRGS13, VS9080FRGS20, VS9080GRACQE, VS9080GRACQG, VS9080GRL, VS9080PCGP		



1

Part No.	502292	Ref. No.	9211812.00
description	pull handle L 230mm H 65mm mounting distance 180mm for oven stainless steel		
For models:	V70120TPPCFG2, V90120TPPCFG2, VS70120CFG, VS70120CFGE, VS70120TPFG, VS7080CFE, VS7080CFEQ, VS7080CFG, VS7080CFGE, VS7080CFVE, VS7080TPFE, VS7080TPPCFG, VS90120CFG, VS90120CFGE, VS90120TPFG, VS90160CFG, VS90160CFGE, VS9080CFES, VS9080CFG, VS9080CFGE, VS9080CFVE, VS9080TPFE, VS9080TPFG, VS9080TPPCFG		



1

Part No.	692802	Ref. No.	256.459.00
description	pull handle L 245mm mounting distance 224mm thread M6 for tilting bratt pan ø 20mm with fixing sheet silver		
For models:	VS7080BREI, VS7080BREIM, VS7080BRGI, VS7080BRGIM, VS9080BREI, VS9080BREIM, VS9080BRGI, VS9080BRGIM		

HANDLES AND HAND WHEELS/LOCKS VIRTUS

locks

edgemoount latches

handle latches

miscellaneous



1

Part No.	694003	Ref. No.	B00KI102
description	handle latch L 137mm mounting distance 118mm lockable refrigeration units I-01 H 31.5mm W 28mm type I-01 total length 190mm handle material plastic		
For models:	BMA0008-F, BMA0010-F, PB9RI-F		
accessories for	694003		
	Part No.	700078	Ref. No.
			—
	door catch L 47mm W 14mm H 29mm mounting distance 21-33mm zinc die cast adjustable		

espagnolette locks

universal



1

Part No.	700771	Ref. No.	12024673
description	latch gear opening to the left shaft intake ø 8x8mm L 170mm W 40mm H 40mm		
For models:	AIC0043-F, AIC0044-F, AIC0045-F, AIC0046-F, AIC0074-F, AIC0075-F, AIC0079-F, AIC0080-F		



hinges

spring assisted hinges

producer-specific

CORECO



1			
Part No.	690763	Ref. No.	12038130
description	spring assisted hinge right/left L 111mm W 75mm refrigerator mounting distance 25mm		
For models:	BKZ0008-F, BKZ0022-F, BKZ0023-F		
accessories for	690763		
	Part No.	691738	Ref. No. —
	hinge L 100mm W 48mm mounting pos. left thickness 5mm for door for refrigerated counters		
	Part No.	701161	Ref. No. —
	hinge camp mounting pos. bottom right L 100mm W 48mm H 17mm shaft diameter 8x8mm		

FAGOR

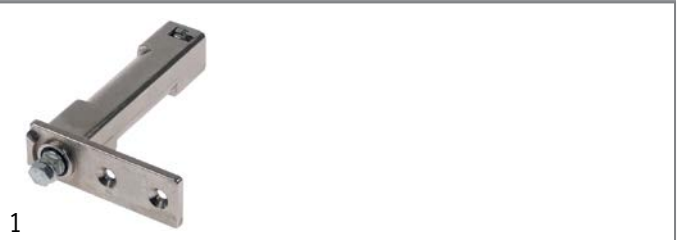

1			
Part No.	690763	Ref. No.	12038130
description	spring assisted hinge right/left L 111mm W 75mm refrigerator mounting distance 25mm		
For models:	BKZ0008-F, BKZ0022-F, BKZ0023-F		
accessories for	690763		
	Part No.	691738	Ref. No. —
	hinge L 100mm W 48mm mounting pos. left thickness 5mm for door for refrigerated counters		
	Part No.	701161	Ref. No. —
	hinge camp mounting pos. bottom right L 100mm W 48mm H 17mm shaft diameter 8x8mm		

FRENOX



1			
Part No.	701653	Ref. No.	P30090008
description	bracket for hinge L 180mm W 31mm lower mounting distance 58mm		
For models:	BMA0021-F, BMA0022-F, BMA0024-F, BMA0025-F, BMA0026-F, BMA0027-F, BMA0028-F, BMA0029-F, BMA0032-F, BMA0035-F, BMA0036-F, BMB0028-F, BMB0029-F, BMB0030-F, BMB0033-F, BMB0034-F, BMB0035-F, BMB0036-F, BMB0037-F, BMC0012-F, BMC0014-F, BMC0015-F, BMC0016-F		
accessories for	701653		
	Part No.	701416	Ref. No. B02ME100
	spring assisted hinge left/right L 114mm W 75mm mounting distance 25mm brass suitable for FRENOX		





1			
Part No.	701651	Ref. No.	B02ME101
description	bush for door hinge 8 ED ø 11mm 19.5 H 11.5mm Qty 5 pcs		
For models:	BMA0021-F, BMA0022-F, BMA0024-F, BMA0025-F, BMA0026-F, BMA0027-F, BMA0028-F, BMA0029-F, BMA0032-F, BMA0035-F, BMA0036-F, BMB0028-F, BMB0029-F, BMB0030-F, BMB0033-F, BMB0034-F, BMB0035-F, BMB0036-F, BMB0037-F, BMC0012-F, BMC0014-F, BMC0015-F, BMC0016-F		



1			
Part No.	701388	Ref. No.	B02ME102
description	bush type for door hinge mounting pos. upper ED ø 31mm H 19mm plastic shaft diameter 14.3mm		
For models:	BMA0021-F, BMA0022-F, BMA0024-F, BMA0025-F, BMA0026-F, BMA0027-F, BMA0028-F, BMA0029-F, BMA0032-F, BMA0035-F, BMA0036-F, BMB0028-F, BMB0029-F, BMB0030-F, BMB0033-F, BMB0034-F, BMB0035-F, BMB0036-F, BMB0037-F, BMC0012-F, BMC0014-F, BMC0015-F, BMC0016-F		
accessories for	701388		
	Part No.	701416	Ref. No. B02ME100
	spring assisted hinge left/right L 114mm W 75mm mounting distance 25mm brass suitable for FRENOX		
	Part No.	701655	Ref. No. —
	bush upper for door hinge ID ø 10mm ED ø 14mm L 36mm for aluminium		

1 mechanical components, equipment accessories





			
1			
Part No.	701416	Ref. No.	B02ME100
description	spring assisted hinge left/right L 114mm W 75mm mounting distance 25mm brass suitable for FRENOX		
For models:	BMA0021-F, BMA0022-F, BMA0024-F, BMA0025-F, BMA0026-F, BMA0027-F, BMA0028-F, BMA0029-F, BMA0032-F, BMA0035-F, BMA0036-F, BMB0028-F, BMB0029-F, BMB0030-F, BMB0033-F, BMB0034-F, BMB0035-F, BMB0036-F, BMB0037-F, BMC0012-F, BMC0014-F, BMC0015-F, BMC0016-F, BNA0036-F, BNA0037-F, BNA0045-F, BNA0052-F, BNA0053-F, BNA0054-F, BNA0055-F, BNA0057-F, BNA0064-F, BNA0065-F, BNA0066-F, BNB0010-F, BNB0011-F, BNB0012-F, BNB0013-F, BNB0014-F, BNB0015-F, BNZ0007-F, CCZ0036-F, CCZ0037-F, VTGB4A-F		
accessories for	701416		
	Part No.	701388	Ref. No. B02ME102
	bush type for door hinge mounting pos. upper ED ø 31mm H 19mm plastic shaft diameter 14.3mm		
	Part No.	701653	Ref. No. P30090008
	bracket for hinge L 180mm W 31mm lower mounting distance 58mm		

oven hinges

			
1			
Part No.	700001	Ref. No.	684.011.00
description	opposite support L 118mm W 17mm mounting distance 94mm		
For models:	V70120TPPCFG2, V90120TPPCFG2, VS70120CFG, VS70120CFGE, VS70120CFGG, VS70120TPFG, VS7080CFE, VS7080CFEQ, VS7080CFG, VS7080CFGE, VS7080CFVE, VS7080TPFE, VS7080TPFG, VS7080TPPCFG, VS90120CFG, VS90120CFGE, VS90120CFGG, VS90120TPFG, VS90160CFG, VS90160CFGE, VS9080CFES, VS9080CFG, VS9080CFGE, VS9080CFVE, VS9080TPFE, VS9080TPFG, VS9080TPPCFG		

			
1			
Part No.	701621	Ref. No.	684.030.00
description	oven hinge mounting distance 173mm lug mounting 14mm lever length 115mm groove distance 7mm spring thickness 3.8mm mounting ear position left/right spring length 110mm L 207mm W 25mm		
For models:	V70120TPPCFG2, V90120TPPCFG2, VS70120CFG, VS70120CFGE, VS70120TPFG, VS7080CFE, VS7080CFEQ, VS7080CFG, VS7080CFGE, VS7080CFVE, VS7080TPFE, VS7080TPFG, VS7080TPPCFG, VS90120CFG, VS90120CFGE, VS90120TPFG, VS90160CFG, VS90160CFGE, VS9080CFES, VS9080CFG, VS9080CFGE, VS9080CFVE, VS9080TPFE, VS9080TPFG, VS9080TPPCFG		

			
1			
Part No.	700006	Ref. No.	684.027.00
description	oven hinge mounting distance 173mm mounting distance 2 105mm lug mounting 14mm lever length 120mm groove distance 11mm spring thickness 3.5mm mounting ear position left spring length 112mm W 25mm		
For models:	VS70120CFGG, VS90120CFGG		
accessories for	700006		
	Part No.	700001	Ref. No. 684.011.00
	opposite support L 118mm W 17mm mounting distance 94mm		
	Part No.	700007	Ref. No. 684.026.00
	oven hinge mounting distance 173mm mounting distance 2 105mm lug mounting 14mm lever length 120mm groove distance 11mm spring thickness 3.5mm mounting ear position right spring length 112mm W 25mm		



1			
Part No.	700007	Ref. No.	684.026.00
description	oven hinge mounting distance 173mm mounting distance 2 105mm lug mounting 14mm lever length 120mm groove distance 11mm spring thickness 3.5mm mounting ear position right spring length 112mm W 25mm		
For models:	VS70120CFGG, VS90120CFGG		
accessories for	700007		
	Part No.	700001	Ref. No. 684.011.00
	opposite support L 118mm W 17mm mounting distance 94mm		
	Part No.	700006	Ref. No. 684.027.00
	oven hinge mounting distance 173mm mounting distance 2 105mm lug mounting 14mm lever length 120mm groove distance 11mm spring thickness 3.5mm mounting ear position left spring length 112mm W 25mm		

1			
Part No.	692903	Ref. No.	12047967
description	hinge L 54mm W 32mm H 12.5mm mounting pos. lower thread M6 ID ø 15.5mm		
For models:	AIC0037-F, AIC0038-F, AIC0039-F, AIC0040-F, AIC0041-F, AIC0042-F, AIC0043-F, AIC0044-F, AIC0045-F, AIC0046-F, AIC0071-F, AIC0072-F, AIC0073-F, AIC0074-F, AIC0075-F, AIC0076-F, AIC0077-F, AIC0078-F, AIC0079-F, AIC0080-F		

1			
Part No.	701461	Ref. No.	P30037072
description	hinge L 56mm W 39mm set		
For models:	CCZ0036-F, CCZ0037-F		

1			
Part No.	521285	Ref. No.	12039312
description	hinge bearing L 152mm W 29mm H 8.5mm mounting pos. upper without bolt		
For models:	AIC0037-F, AIC0038-F, AIC0039-F, AIC0040-F, AIC0041-F, AIC0042-F, AIC0043-F, AIC0044-F, AIC0045-F, AIC0046-F, AIC0071-F, AIC0072-F, AIC0073-F, AIC0074-F, AIC0075-F, AIC0076-F, AIC0077-F, AIC0078-F, AIC0079-F, AIC0080-F		

1			
Part No.	691089	Ref. No.	12023636
description	hinge pin		
For models:	AIC0037-F, AIC0038-F, AIC0039-F, AIC0040-F, AIC0041-F, AIC0042-F, AIC0043-F, AIC0044-F, AIC0045-F, AIC0046-F, AIC0071-F, AIC0072-F, AIC0073-F, AIC0074-F, AIC0075-F, AIC0076-F, AIC0077-F, AIC0078-F, AIC0079-F, AIC0080-F		

door bearing

1			
Part No.	690764	Ref. No.	12037723
description	bush W 23.5mm H 53.5mm mounting pos. upper/lower ø 16mm ID ø 10mm grey for hinge		
For models:	BKZ0008-F, BKZ0022-F, BKZ0023-F		
accessories for	690764		
	Part No.	700817	Ref. No. 12038076
	hinge bolt upper ø 10mm L 30mm IT M6 for refrigerated counters mounting pos. upper		

accessories

shafts

1			
Part No.	692904	Ref. No.	12039311
description	hinge L 54mm W 32mm H 10mm mounting pos. lower thread M6 ID ø 15.5mm		
For models:	AIC0037-F, AIC0038-F, AIC0039-F, AIC0040-F, AIC0041-F, AIC0042-F, AIC0043-F, AIC0044-F, AIC0045-F, AIC0046-F, AIC0071-F, AIC0072-F, AIC0073-F, AIC0074-F, AIC0075-F, AIC0076-F, AIC0077-F, AIC0078-F, AIC0079-F, AIC0080-F		

1			
Part No.	700817	Ref. No.	12038076
description	hinge bolt upper ø 10mm L 30mm IT M6 for refrigerated counters mounting pos. upper		
For models:	BKZ0008-F, BKZ0022-F, BKZ0023-F		



pullouts

drawer slides



Part No.	692488	Ref. No.	A00CK100
description	drawer rail Qty 2 pcs L 550mm pull-out length 400mm W 60mm H 20mm		
For models:	BNA0030-F, BNA0031-F, BNA0036-F, BNA0037-F, BNA0044-F, BNA0045-F, BNA0052-F, BNA0053-F, BNA0054-F, BNA0055-F, BNA0056-F, BNA0057-F, BNB0010-F, BNB0011-F, BNB0012-F, BNB0013-F, BNB0014-F, BNB0015-F, CCZ0036-F, CCZ0037-F, VTGB2A-F, VTGB2-F, VTGB3A-F, VTGB3-F, VTGB4A-F, VTGB4-F		

fittings for catering equipment

aerators and air bleeders



Part No.	542408	Ref. No.	256.334.00
description	aerator and air bleeder thread 3/8" ET WS 24 chrome-plated with adapter for kettle L 37mm		
For models:	VS7080PEI50, VS7080PGI50, VS9080PEI150, VS9080PGI150		
spare parts for	542408		
	Part No.	540825	Ref. No. —
	aerator and air bleeder thread 3/8" ET WS 24 chrome-plated L 37mm		

lid hinges

MODULAR

lid hinges



Part No.	514520	Ref. No.	6111636.00
description	lid hinge L 250mm ID ø 40mm ED ø 42mm lid radius 215mm		
For models:	VS7080PEI50, VS7080PG50, VS7080PGI50		

spare parts



Part No.	692783	Ref. No.	941.139.15
description	adjusting bush for kettle ø 40/20mm L 80mm		
For models:	VS7080PEI50, VS7080PG50, VS7080PGI50		



Part No.	692797	Ref. No.	941.138.00
description	bush for kettle ø 39mm L 55mm		
For models:	VS7080PEI50, VS7080PG50, VS7080PGI50, VS9080PEI150, VS9080PGI150		

drain taps

brass

drain taps











Part No.	541672	Ref. No.	678.086.00
description	drain tap 1 1/2" IT conical seal A 85mm B1 58mm B2 126mm		
For models:	VS7080PEI50, VS7080PG50, VS7080PGI50		
spare parts for	541672		
	Part No.	540213	Ref. No. —
	handle ID ø 5mm L 117mm		
	Part No.	540956	Ref. No. —
	gasket for drain tap hose ext. ø 46mm ID ø 38mm H 2mm		
accessories for	541672		
	Part No.	510404	Ref. No. 953.031.00
	flat gasket fibre ED ø 44mm ID ø 34mm thickness 2mm Qty 1 pcs		

Table continues overleaf



accessories for 541672			
	Part No.	890116	Ref. No. —
	fitting grease FERMIT GLISSA tube 60g -20 up to +140°C approval complies with KTW recommendation		
	Part No.	890118	Ref. No. —
	fitting grease FERMIT GLISSA can 1000g -20 up to +140°C approval complies with KTW recommendation		
	Part No.	890119	Ref. No. —
	fitting grease FERMIT GLISSA tube 30g -20 up to +140°C approval complies with KTW recommendation		



1	Part No.	540275	Ref. No.	678.051.00
	description	drain tap 2" IT with union nut A 90mm B 151mm B1 80mm chrome-plated brass		
	For models:	VS9080PEI150, VS9080PGI150		
	spare parts for	540275		
	Part No.	540214	Ref. No.	—
	handle ID ø 6mm L 145mm			
accessories for 540275				
	Part No.	529484	Ref. No.	953.030.00
	flat gasket fibre ED ø 58mm ID ø 50mm thickness 2mm Qty 1 pcs			
	Part No.	542448	Ref. No.	—
	gasket silicone 60x49x2 for drain tap 2"			

test taps

test taps



1	Part No.	542396	Ref. No.	678.079.00
	description	test tap thread 3/8" IT W 78mm W1 22mm head ø 45mm head thickness 18mm		
	For models:	VS7080PEI50, VS7080PGI50, VS9080PEI150, VS9080PGI150		

safety valves



1	Part No.	514121	Ref. No.	678.049.00
	description	safety valve triggering pressure 0.5bar with CE approval M88 thread 1 1/4"		
	For models:	VS7080PEI50, VS7080PGI50, VS9080PEI150, VS9080PGI150		

filters

grease filters

grease filter



1	Part No.	970962	Ref. No.	643.007.00
	description	grease filter W 270mm L 270mm thickness 12mm for induction device		
	For models:	VS9040INDT, VS9040INDWT, VS9080INDT		

equipment feet and end caps

equipment feet

with screw mounting

universal



1	Part No.	700868	Ref. No.	73100
	description	equipment foot tube ø 64mm thread M12 thread L 25mm H 155-235mm SS size 2 1/2" Qty 1 pcs		
	For models:	GLB0047		



1

Part No.	513287	Ref. No.	926117
description	equipment foot tube ø 60mm thread M12 thread L 33mm H 155-235mm SS size 2" Qty 1 pcs		
For models:	GLB0045, GLB0047, GLB0048, GLB0049, GLB0050, GLB0051		

with fixing plate



1

Part No.	701616	Ref. No.	912.090.14
description	equipment foot tube ø 64mm plate size 74x74mm hole distance 56x56mm H 130-190mm SS size 2" Qty 1 pcs		
For models:	V70120TPPCFG2, V90120TPPCFG2, VS70120B, VS70120CFG, VS70120CFGE, VS70120CFGG, VS70120TPFG, VS7040B, VS7040CPES, VS7040CPGS, VS7040FRE10, VS7040FRE17X, VS7040FRE88, VS7040FRG17VL, VS7040FRGS13, VS7040GRACQE, VS7040GRACQG, VS7040GRL, VS7080B, VS7080BREI, VS7080BREIM, VS7080BRGI, VS7080BRGIM, VS7080CFE, VS7080CFEQ, VS7080CFG, VS7080CFGE, VS7080CFVE, VS7080CPES, VS7080CPGS, VS7080FRE10, VS7080FRE17X, VS7080FRG17VL, VS7080FRGS13, VS7080GRACQE, VS7080GRACQG, VS7080GRL, VS7080PEI50, VS7080PG50, VS7080PGI50, VS7080TPFE, VS7080TPFG, VS7080TPPCFG, VS90120B, VS90120CFG, VS90120CFGE, VS90120CFGG, VS90120PCGP, VS90120TPFG, VS90160CFG... (Other models you can see in the webshop)		



1

Part No.	701100	Ref. No.	12009104 12033566
description	equipment foot tube ø 64mm plate size 82x82mm hole distance 65x65mm H 135-200mm SS size 2 1/2" Qty 1 pcs		
For models:	AIC0037-F, AIC0038-F, AIC0039-F, AIC0040-F, AIC0041-F, AIC0042-F, AIC0071-F, AIC0072-F, AIC0073-F, AIC0076-F, AIC0077-F, AIC0078-F, BKZ0008-F, BKZ0023-F, GLB0071-F, GLB0080, GLB0082		



1

Part No.	701007	Ref. No.	B00AY100
description	equipment foot tube ø 64mm plate size 82x82mm hole distance 68x68mm H 100-150mm SS size 2 1/2" Qty 1 pcs		
For models:	BMA0021-F, BMA0022-F, BMA0024-F, BMA0025-F, BMA0026-F, BMA0027-F, BMA0028-F, BMA0029-F, BMA0032-F, BMA0035-F, BMA0036-F, BMB0028-F, BMB0029-F, BMB0030-F, BMB0033-F, BMB0034-F, BMB0035-F, BMB0036-F, BMB0037-F, BMC0012-F, BMC0014-F, BMC0015-F, BMC0016-F, BNA0030-F, BNA0031-F, BNA0036-F, BNA0037-F, BNA0044-F, BNA0045-F, BNA0052-F, BNA0053-F, BNA0054-F, BNA0055-F, BNA0056-F, BNA0057-F, BNA0064-F, BNA0065-F, BNA0066-F, BNB0010-F, BNB0011-F, BNB0012-F, BNB0013-F, BNB0014-F, BNB0015-F, BNZ0001-F, BNZ0002-F, BNZ0003-F, BNZ0004-F, BNZ0005-F, BNZ0006-F... (Other models you can see in the webshop)		

screw-in feet



1

Part No.	510115	Ref. No.	12024163
description	equipment foot thread M10 thread L 40mm ø 30mm H 10mm Qty 1 pcs		
For models:	GLB0067-F, GLB0069-F, GLB0081		



1

Part No.	692781	Ref. No.	951.083.00
description	equipment foot thread M8 thread L 54mm ø 25mm H 11mm Qty 1 pcs		
For models:	V080FTREVCRT, V70120TPPCG2T, V7040FTREVCRT, V9040FTREVCRT, V9080FTREVCRT, VS7040FTEVCRT, VS7040FTEVT, VS7040FTREVT, VS7080FTEVCRT, VS7080FTEVT, VS7080FTREVT, VS7080FTRREVC, VS7080FTRREVT, VS7080TPGT, VS7080TPPCGT, VS9040FTEVCRT, VS9040FTEVT, VS9040FTREVT, VS9080FTEVCRT, VS9080FTEVT, VS-9080FTEVT, VS9080FTRREVC, VS9080FTRREVT		

TENTE

with fixing plate

chrome-plated steel



1

Part No.	700214	Ref. No.	B00AY101
description	swivel castor ø 100mm plate fixing housing zinc-plated sheet steel plate size 105x85mm hole distance 60x78mm capacity 80kg bearing slide bearing wheel body polypropylene tread TPE tyres H 128mm wheel width 32mm		
For models:	BMA0021-F, BMA0022-F, BMA0024-F, BMA0025-F, BMA0026-F, BMA0027-F, BMA0028-F, BMA0029-F, BMA0032-F, BMA0035-F, BMA0036-F, BMB0028-F, BMB0029-F, BMB0030-F, BMB0033-F, BMB0034-F, BMB0035-F, BMB0036-F, BMB0037-F, BMC0012-F, BMC0014-F, BMC0015-F, BMC0016-F, BNA0030-F, BNA0031-F, BNA0036-F, BNA0037-F, BNA0044-F, BNA0045-F, BNA0052-F, BNA0053-F, BNA0054-F, BNA0055-F, BNA0056-F, BNA0057-F, BNA0064-F, BNA0065-F, BNA0066-F, BNB0010-F, BNB0011-F, BNB0012-F, BNB0013-F, BNB0014-F, BNB0015-F, BNZ0001-F, BNZ0002-F, BNZ0003-F, BNZ0004-F, BNZ0005-F, BNZ0006-F... (Other models you can see in the webshop)		



			
1			
Part No.	700213 ¹	Ref. No.	B00AY102
description	swivel castor with swivel brake ø 100mm plate fixing housing zinc-plated sheet steel plate size 105x85mm hole distance 60x78mm capacity 80kg bearing slide bearing wheel body polypropylene tread TPE tyres H 128mm wheel width 32mm Qty 1 pcs		
For models:	BMA0029-F, BMB0030-F, BMB0035-F, BMB0036-F, BMB0037-F, BMC0012-F, BMC0014-F, BMC0016-F, BNA0036-F, BNA0037-F, BNA0045-F, BNA0052-F, BNA0053-F, BNA0054-F, BNA0055-F, BNA0057-F, BNA0064-F, BNA0065-F, BNA0066-F, BNB0010-F, BNB0011-F, BNB0012-F, BNB0013-F, BNB0014-F, BNB0015-F, BNZ0007-F, CCZ0036-F, CCZ0037-F, VTGB4A-F		

¹with swivel brake

baskets

crumb screens

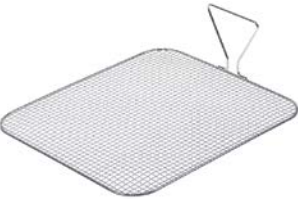
			
1			
Part No.	970965	Ref. No.	983.048.00
description	crumb screen L 332mm W 297mm H 100mm chrome-plated steel for grill		
For models:	VS7040FRE17X, VS7040FRG17VL, VS7080FRE17X, VS7080FRG17VL, VS9040FRG17VL, VS9080FRE17, VS9080FRG17VL		

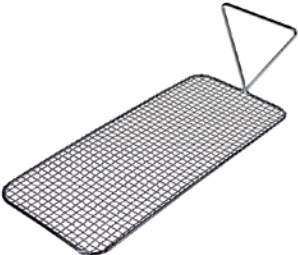
			
1			
Part No.	970632	Ref. No.	683.095.00
description	crumb screen L 338mm W 134mm H 100mm		
For models:	VS7040FRE88, VS9040FRE88		

			
1			
Part No.	970983	Ref. No.	683.096.00
description	crumb screen L 339mm W 220mm H 100mm chrome-plated steel suitable for for fryer 13 L		
For models:	VS7040FRGS13, VS7080FRGS13, VS9040FRE17, VS9040FRGS13, VS9080FRGS13		

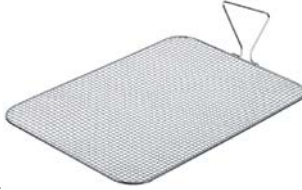
			
1			
Part No.	970964	Ref. No.	983.045.00
description	crumb screen L 430mm W 297mm H 110mm		
For models:	VS7040FRE17X, VS7080FRE17X, VS9040FRE17, VS9040FRE21, VS9040FRG21VL, VS9040FRGS20, VS9080FRE17, VS9080FRE21, VS9080FRG21VL, VS9080FRGS20		

			
1			
Part No.	970545	Ref. No.	683.001.23
description	crumb screen L 330mm W 235mm suitable for fryer		
For models:	VS7040FRE10, VS7080FRE10		

			
1			
Part No.	970963	Ref. No.	983.010.00
description	crumb screen L 410mm W 260mm H 140mm for fryer		
For models:	VS9040FRE15, VS9080FRE15		

warewashing baskets

accessories

sliding corners

			
1			
Part No.	970820	Ref. No.	75075
description	sliding corner L 44mm W 44mm H 17mm		
For models:	GLB0045, GLB0047, GLB0048, GLB0049, GLB0050, GLB0051		



shelves and shelf rails

chargrill grids

			
1			
Part No.	211099	Ref. No.	611.937.00
description	chargrill grid L 440mm W 325mm H 20mm stainless steel for lava rock grill		
For models:	VS7040GRL, VS7080GRL		

grates

universal

without upstand

			
1			
Part No.	970834	Ref. No.	B01RF100
description	grate W 330mm D 530mm H 10mm plastic-coated steel wire gauge frame 6.9mm lengthwise wires gauge 3.5mm crossing wires 1 grey		
For models:	BNA0030-F, BNA0031-F, BNA0036-F, BNA0037-F, BNA0044-F, BNA0045-F, BNA0052-F, BNA0053-F, BNA0054-F, BNA0055-F, BNA0056-F, BNA0057-F, BNB0010-F, BNB0011-F, BNB0012-F, BNB0013-F, BNB0014-F, BNB0015-F, VTGB2A-F, VTGB2-F, VTGB3A-F, VTGB3-F, VTGB4A-F, VTGB4-F		

			
1			
Part No.	970835	Ref. No.	B01RF115
description	grate W 600mm D 400mm H 12mm plastic-coated steel wire gauge frame 7.5mm lengthwise wires gauge 5.5mm crossing wires 1 grey		
For models:	BNZ0001-F, BNZ0002-F, BNZ0003-F, BNZ0004-F, BNZ0005-F, BNZ0006-F, BNZ0007-F, BNZ0008-F, CCZ0036-F, CCZ0037-F		



with upstand

			
1			
Part No.	970833	Ref. No.	B01RF102
description	grate W 530mm D 650mm GN 2/1 H 29.5mm plastic-coated steel wire gauge frame 8mm lengthwise wires gauge 3.5mm crossing wires 2 grey		
For models:	BMA0021-F, BMA0022-F, BMA0024-F, BMA0025-F, BMA0032-F, BMA0035-F, BMB0028-F, BMB0029-F, BMB0030-F, BMB0033-F, BMB0035-F, BMC0012-F, BMC0014-F, BMC0015-F, BMC0016-F		

grates

			
1			
Part No.	692770	Ref. No.	982.024.00
description	chimney grate L 400mm W 80mm cast iron		
For models:	V080FTREVCRT, V70120TPPCFG2, V70120TPPCG2T, V7040FTREVCRT, V7040FTRGVCRT, V7080FTRGVCRT, V90120TPPCFG2, V90120TPPCG2T, V9040FTREVCRT, V9040FTRGVCRT, V9080FTREVCRT, V9080FTRGVCRT, V9080FTRRECRT, V9080FTRRGCRT, VS70120CFG, VS70120CFGGE, VS70120CFGG, VS70120PCGT, VS70120TPFG, VS7040BMET, VS7040BMFEP, VS7040BMGT, VS7040CPGS, VS7040FRE17X, VS7040FRE88, VS7040FRG17VL, VS7040FRGS13, VS7040FTET, VS7040FTEVCRT, VS7040FTEVT, VS7040FTGT, VS7040FTGVCRT, VS7040FTGVT, VS7040FTRET, VS7040FTREVT, VS7040FTRGT, VS7040FTRGVT, VS7040GRACQE, VS7040GRACQG, VS7040GRL, VS7040PCEQT, VS7040PCET, VS7040PCGT, VS7080BMET, VS7080BMFEP, VS7080BMGT, VS7080BREI, VS7080BREIM, VS7080BRGI, VS7080BRGIM...(Other models you can see in the webshop)		

grid attachments

			
1			
Part No.	694963	Ref. No.	622.967.00
description	rack support L 630mm H 175mm mounting pos. left/right W 40mm mounting distance 603mm		
For models:	V70120TPPCFG2, V90120TPPCFG2, VS70120CFG, VS70120CFGGE, VS70120TPFG, VS7080CFE, VS7080CFEQ, VS7080CFG, VS7080CFGE, VS7080CFVE, VS7080TPFE, VS7080TPFG, VS7080TPPCFG, VS90120CFG, VS90120CFGGE, VS90120TPFG, VS90160CFG, VS90160CFGGE, VS9080CFES, VS9080CFG, VS9080CFGGE, VS9080CFVE, VS9080TPFE, VS9080TPFG, VS9080TPPCFG		
accessories for	694963		
	Part No.	701650	Ref. No. —
	bolt for grid attachment L 18mm head ø 15mm M6		

			
1			
Part No.	692890	Ref. No.	9111317.00
description	rack support L 630mm H 190mm mounting pos. left/right W 50mm mounting distance 608mm		
For models:	VS70120CFGG, VS90120CFGG		



shelf rails and supports

producer-specific

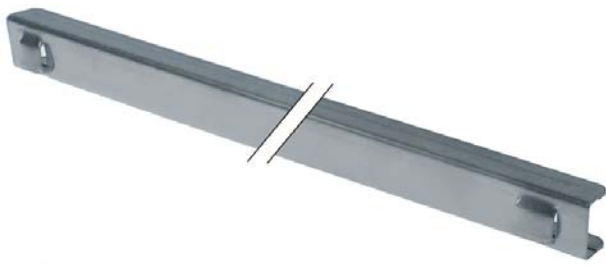

1

Part No.	701329	Ref. No.	P11070025
description	guide U-shape L 630mm W 19mm mounting pos. left/right hook width 13mm inner high 15mm		
For models:	BMA0021-F, BMA0022-F, BMA0024-F, BMA0025-F, BMA0032-F, BMA0035-F, BMB0028-F, BMB0029-F, BMB0030-F, BMB0033-F, BMB0035-F, BMC0012-F, BMC0014-F, BMC0015-F, BMC0016-F		

Part No.	901724	Ref. No.	A00CO119
description	refrigeration gasket profile 9198 W 620mm L 1540mm plug size		
For models:	BMA0008-F, BMA0010-F, BMA0021-F, BMA0022-F, BMA0024-F, BMA0025-F, BMA0026-F, BMA0027-F, BMA0028-F, BMA0032-F, BMA0035-F, BMA0036-F, BMB0028-F, BMB0029-F, BMB0033-F, BMB0034-F, BMB0035-F, BMB0036-F, BMB0037-F, BMC0014-F, BMC0015-F, BMC0016-F, PB9RI-F		

gaskets

refrigeration gaskets

plug-in gaskets

profile 9198

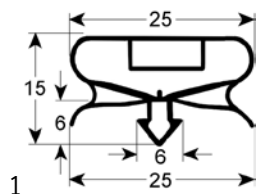

1

Part No.	901737	Ref. No.	A00CO107
description	refrigeration gasket profile 9198 W 493mm L 618mm plug size		
For models:	BNZ0001-F, BNZ0002-F, BNZ0003-F, BNZ0004-F, BNZ0005-F, BNZ0006-F, BNZ0007-F, BNZ0008-F, CCZ0036-F, CCZ0037-F		

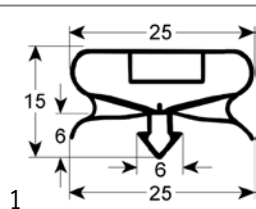

1

Part No.	901736	Ref. No.	A00CO101
description	refrigeration gasket profile 9198 W 610mm L 405mm plug size FRENIX		
For models:	BNA0030-F, BNA0031-F, BNA0036-F, BNA0037-F, BNA0044-F, BNA0045-F, BNA0052-F, BNA0053-F, BNA0054-F, BNA0055-F, BNA0056-F, BNA0057-F, BNA0064-F, BNA0065-F, BNA0066-F, BNB0010-F, BNB0011-F, BNB0012-F, BNB0013-F, BNB0014-F, BNB0015-F, CCZ0036-F, CCZ0037-F, VTGB2A-F, VTGB2-F, VTGB3A-F, VTGB3-F, VTGB4A-F, VTGB4-F		

Part No.	901735	Ref. No.	A00CO118
description	refrigeration gasket profile 9198 W 620mm L 730mm plug size		
For models:	BMB0030-F, BMC0012-F, BMC0016-F		

gaskets for heated units

door seals

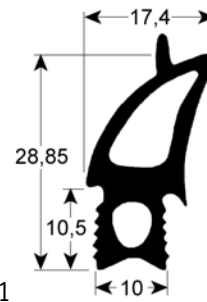

1

Part No.	902197	Ref. No.	12041578
description	door seal profile 2730 W 675mm L 775mm		
For models:	AIC0041-F, AIC0042-F, AIC0073-F, AIC0078-F		

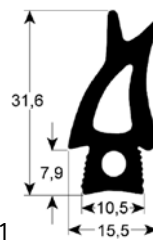

1

Part No.	902480	Ref. No.	12039475
description	door seal profile 2732 W 460mm L 770mm outer plug size for combi-steamer suitable for FAGOR		
For models:	AIC0039-F, AIC0040-F, AIC0072-F, AIC0077-F		

mechanical components,
equipment accessories
1

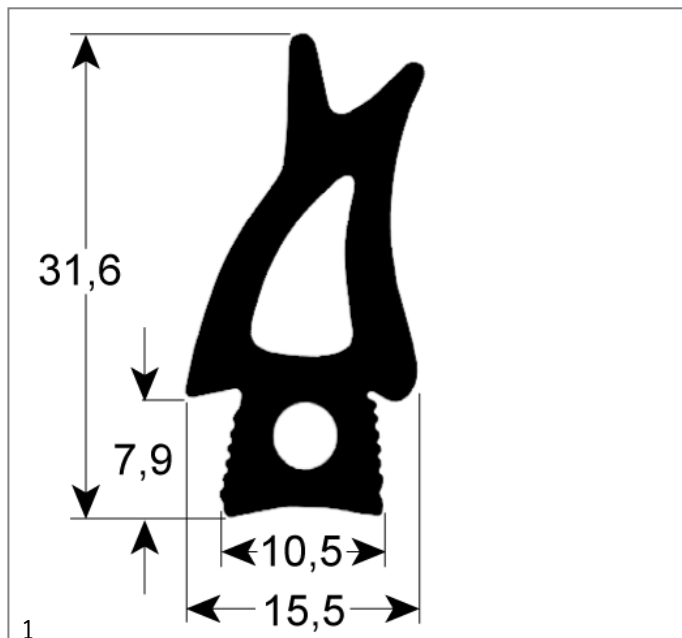

Part No.	902555	Ref. No.	12041134
description	door seal profile 2732 W 470mm L 1150mm outer plug size Qty 1 suitable for FAGOR		
For models:	AIC0043-F, AIC0044-F, AIC0074-F, AIC0079-F		

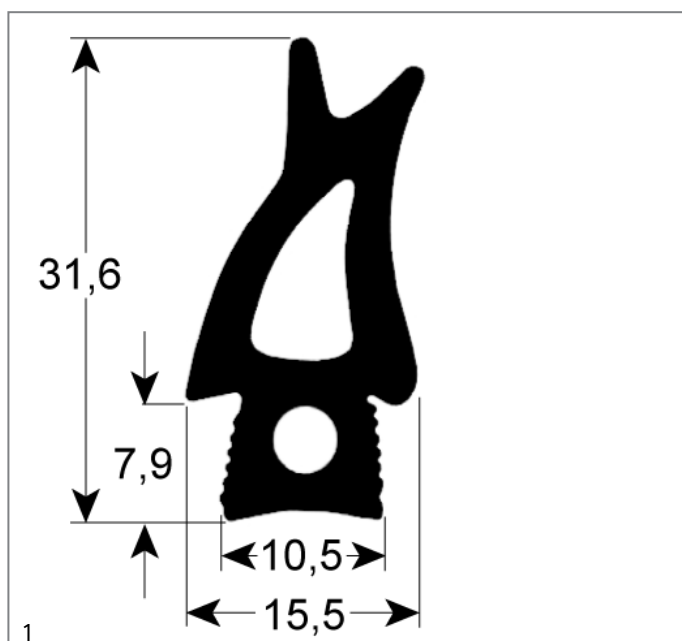

Part No.	902554	Ref. No.	12039599
description	door seal profile 2732 W 470mm L 500mm Qty 1 for model outer plug size suitable for FAGOR		
For models:	AIC0037-F, AIC0038-F, AIC0071-F, AIC0076-F		



Part No.	902483	Ref. No.	FO4NEA0039
description	door seal profile 2763 L 1800mm suitable for TECNODOM		

gaskets for tray rack trolleys

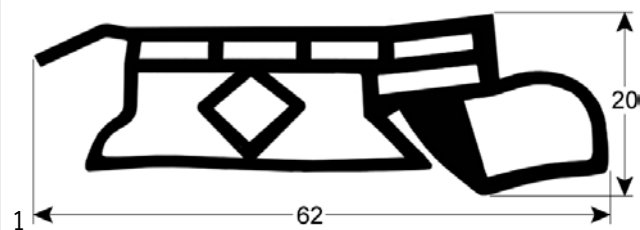

Part No.	902553	Ref. No.	12041088
description	tray rack trolley gasket profile 4160 L 510mm suitable for FAGOR Qty 1		
For models:	AIC0043-F, AIC0044-F, AIC0074-F, AIC0079-F		

O-rings

EPDM

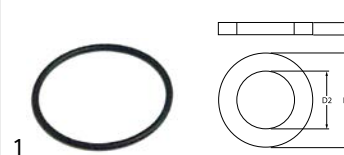

Part No.	532021	Ref. No.	953.018.00
description	O-ring EPDM thickness 1.78mm ID $\varnothing 33.05\text{mm}$ Qty 10 pcs		
For models:	VS7040FRG17VL, VS7080BRGI, VS7080BRGIM, VS7080FRG17VL, VS7080PG50, VS7080PGI50, VS9040FRG17VL, VS9040FRG21VL, VS9080BRGI, VS9080BRGIM, VS9080FRG17VL, VS9080FRG21VL, VS9080PGI150		

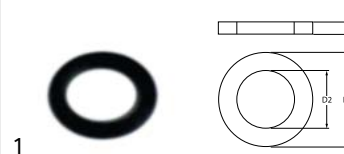

Part No.	528485	Ref. No.	456060
description	O-ring EPDM thickness 1.78mm ID $\varnothing 6.07\text{mm}$ Qty 1 pcs		
For models:	GLB0041, GLB0042, GLB0043C, GLB0044C		



Part No.	510303	Ref. No.	CGR106
description	O-ring EPDM thickness 1.78mm ID $\varnothing 6.75\text{mm}$ Qty 1 pcs		
For models:	GLB0043C-60Hz		

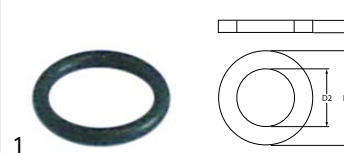

Part No.	504574	Ref. No.	456019
description	O-ring EPDM thickness 1.78mm ID $\varnothing 9.25\text{mm}$ Qty 1 pcs		
For models:	GLB0043C-60Hz		



Part No.	532103	Ref. No.	12049214
description	O-ring EPDM thickness 3.53mm ID ø 13.87mm Qty 10 pcs		
For models:	GLB0071-F, GLB0080		

Part No.	532718	Ref. No.	80816
description	O-ring EPDM thickness 4mm ID ø 80mm Qty 1 pcs		
For models:	GLB0040, GLB0041, GLB0042, GLB0044C, GLB0049, GLB0050, GLB0051		

Part No.	511322	Ref. No.	953.025.00
description	O-ring EPDM thickness 3.53mm ID ø 20.22mm Qty 1 pcs		
For models:	VS7040BMET, VS7040BMFEP, VS7040BMGT, VS7080BMET, VS7080BMFEP, VS7080BMGT, VS9040BMET, VS9040BMFEP, VS9040BMGT, VS9080BMET, VS9080BMFEP, VS9080BMGT		

Part No.	510408	Ref. No.	456002
description	O-ring EPDM thickness 5.34mm ID ø 47mm Qty 1 pcs		
For models:	GLB0040, GLB0041, GLB0042, GLB0043C, GLB0043C-60Hz, GLB0044C		

Part No.	510072	Ref. No.	456016
description	O-ring EPDM thickness 3.53mm ID ø 32.93mm Qty 1 pcs		
For models:	GLB0041, GLB0042		

Part No.	510551	Ref. No.	456023 926084
description	pump cover gasket ID ø 158.3mm pump type 1214/1293/1225/2243/1226/1204/3473/1241 thickness 3.53mm EPDM Qty 1 pcs		
For models:	GLB0040, GLB0041, GLB0042, GLB0045, GLB0047, GLB0048, GLB0049, GLB0050, GLB0051		

Part No.	512511	Ref. No.	12115850
description	O-ring EPDM thickness 3.53mm ID ø 32mm Qty 10 pcs		
For models:	GLB0067-F, GLB0069-F		

Viton

Part No.	528155	Ref. No.	CGR4131NT
description	O-ring Viton thickness 3.53mm ID ø 32.93mm Qty 1 pcs		
For models:	GLB0041, GLB0043C-60Hz, GLB0047		

Part No.	532118	Ref. No.	653.017.00
description	O-ring EPDM thickness 3.53mm ID ø 55.56mm Qty 10 pcs		
For models:	VS7040FRE17X, VS7040FRE88, VS7080FRE17X, VS9040FRE17, VS-9040FRE21, VS9040FRE88, VS9080FRE17, VS9080FRE21		

Part No.	510243	Ref. No.	653.018.00
description	O-ring Viton thickness 3.53mm ID ø 55.56mm Qty 1 pcs		
For models:	VS7040FRE17X, VS7040FRE88, VS7080FRE17X, VS9040FRE17, VS-9040FRE21, VS9040FRE88, VS9080FRE17, VS9080FRE21		

Part No.	532603	Ref. No.	926252
description	O-ring EPDM thickness 3.53mm ID ø 69.85mm Qty 1 pcs		
For models:	GLB0041, GLB0042, GLB0043C, GLB0043C-60Hz, GLB0044C		



sealing washers

fibre gaskets



Part No.	518541	Ref. No.	437021
description	flat gasket FIBER ED ø 12mm ID ø 8mm thickness 1.5mm Qty 1 pcs		
For models:	GLB0041, GLB0042, GLB0043C, GLB0044C		



Part No.	506241	Ref. No.	CGF17
description	flat gasket FIBER ED ø 24mm ID ø 16mm thickness 2mm Qty 1 pcs		
For models:	GLB0049, GLB0050, GLB0051		



Part No.	510074	Ref. No.	437025
description	flat gasket FIBER ED ø 35mm ID ø 27mm thickness 1.5mm Qty 1 pcs		
For models:	GLB0040, GLB0041, GLB0042, GLB0043C, GLB0044C		



Part No.	510404	Ref. No.	953.031.00
description	flat gasket fibre ED ø 44mm ID ø 34mm thickness 2mm Qty 1 pcs		
For models:	VS7080PEI50, VS7080PGI50, VS9080PEI150, VS9080PGI150		



Part No.	529484	Ref. No.	953.030.00
description	flat gasket fibre ED ø 58mm ID ø 50mm thickness 2mm Qty 1 pcs		
For models:	VS9080PEI150, VS9080PGI150		

rubber gaskets



Part No.	507544	Ref. No.	75402
description	flat gasket rubber ED ø 29mm ID ø 17mm thickness 1mm Qty 1 pcs		
For models:	GLB0041		



Part No.	515018	Ref. No.	12009947
description	flat gasket rubber ED ø 32mm ID ø 21mm thickness 3mm Qty 1 pcs		
For models:	GLB0082		



Part No.	518240	Ref. No.	437078
description	flat gasket rubber ED ø 33mm ID ø 17mm thickness 1.5mm Qty 1 pcs		
For models:	GLB0040, GLB0041, GLB0042, GLB0043C, GLB0044C		



Part No.	516261	Ref. No.	437098
description	flat gasket rubber ED ø 33mm ID ø 25mm thickness 2.5mm for air trap Qty 1 pcs		
For models:	GLB0043C-60Hz		



Part No.	510876	Ref. No.	437104
description	flat gasket rubber ED ø 45mm ID ø 33mm thickness 3mm Qty 1 pcs		
For models:	GLB0043C-60Hz		



Part No.	513059	Ref. No.	437063
description	flat gasket rubber ED ø 52mm ID ø 40mm thickness 3mm Qty 1 pcs		
For models:	GLB0049, GLB0050, GLB0051		



Part No.	518205	Ref. No.	80182
description	flat gasket rubber ED ø 61mm ID ø 47mm thickness 2mm Qty 1 pcs		
For models:	GLB0040		



Part No.	518060	Ref. No.	456040
description	gasket rubber ED ø 132mm ID ø 122mm thickness 5mm		
For models:	GLB0040, GLB0041, GLB0042		



foam rubber gaskets

1 			
Part No.	505408	Ref. No.	12041815
description	foam rubber gasket W 15mm thickness 2mm self-adhesive Qty 1 suitable for FAGOR control panel combi-steamer L 540mm		
For models:	AIC0037-F, AIC0038-F, AIC0039-F, AIC0040-F, AIC0041-F, AIC0042-F, AIC0043-F, AIC0044-F, AIC0045-F, AIC0046-F, AIC0071-F, AIC0072-F, AIC0073-F, AIC0074-F, AIC0075-F, AIC0076-F, AIC0077-F, AIC0078-F, AIC0079-F, AIC0080-F		

sealing cords

square

1 			
Part No.	694980	Ref. No.	953.004.00
description	sealing cord square size 12x12mm braided L 1.05m for hob		
For models:	V70120TPPCFG2, V70120TPPCG2T, V90120TPPCFG2, V90120TPPCG2T, VS70120TPFG, VS7080TPFG, VS7080TPGT, VS7080TPPCFG, VS7080TPPCGT, VS90120TPFG, VS9080TPFG, VS9080TPGT, VS9080TPPCFG, VS9080TPPCGT		

shaft gaskets

shaft gaskets

1 			
Part No.	691049	Ref. No.	12024510
description	shaft seal ID ø 17mm ED ø 28mm thickness 7mm		
For models:	AIC0037-F, AIC0038-F, AIC0039-F, AIC0040-F, AIC0041-F, AIC0042-F, AIC0043-F, AIC0044-F, AIC0045-F, AIC0046-F, AIC0071-F, AIC0072-F, AIC0073-F, AIC0074-F, AIC0075-F, AIC0076-F, AIC0077-F, AIC0078-F, AIC0079-F, AIC0080-F		

special gaskets

door seals for dishwashers

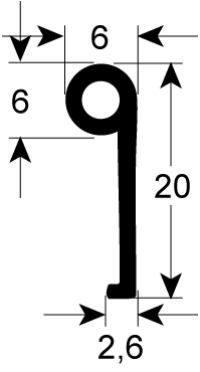
1 			
Part No.	518123	Ref. No.	41247
description	door seal L 1050mm W 6mm H 20mm Qty 1		
For models:	GLB0041, GLB0042, GLB0043C, GLB0044C		

miscellaneous

1 			
Part No.	511999	Ref. No.	75168
description	gasket for flange ED ø 123mm ID ø 46mm rubber thickness 3mm hole distance 53mm		
For models:	GLB0045, GLB0047, GLB0048, GLB0049, GLB0050, GLB0051		

1 			
Part No.	551456	Ref. No.	953.020.00
description	gasket for switch ED ø 14mm ID ø 2.5mm thickness 3.5mm white		
For models:	V080FTREVCRT, V7040FTREVCRT, V9040FTREVCRT, V9080FTREVCRT, V9080FTRRRETCRT, VS70120CFGE, VS7040BMET, VS7040BMFEP, VS7040CPES, VS7040FRE10, VS7040FRE17X, VS7040FRE88, VS7040FRG17VL, VS7040FTET, VS7040FTEVCRT, VS7040FTEVT, VS7040FTRET, VS7040FTREVT, VS7040GRACQE, VS7040PCEQT, VS7040PCET, VS7040SPET, VS7080BMET, VS7080BMFEP, VS7080BREI, VS7080BREIM, VS7080BRGi, VS7080BRGIM, VS7080CFE, VS7080CFEQ, VS7080CFGE, VS7080CFVE, VS7080CPES, VS7080FRE10, VS7080FRE17X, VS7080FRG17VL, VS7080FTET, VS7080FTEVCRT, VS7080FTEVT, VS7080FTRET, VS7080FTREVT, VS7080FTRRRET, VS7080FTREVC, VS7080FTREVT, VS7080GRACQE, VS7080PCEQT, VS7080PCET, VS7080PEI50, VS7080PG50, VS7080PGI50... (Other models you can see in the webshop)		

gaskets for wash arm support

1 			
Part No.	518339	Ref. No.	437064
description	gasket D2 ø 50mm thickness 2mm with 3 screw holes wash arm support equiv. no. 437064 suitable for COLGED hole ø 50mm hole distance 67mm		
For models:	GLB0040, GLB0041		

1 			
Part No.	518402	Ref. No.	437050
description	gasket with 3 screw holes wash arm support hole distance 61mm D2 ø 34mm thickness 2.5mm hole ø 34mm		
For models:	GLB0045, GLB0047, GLB0048, GLB0049, GLB0050, GLB0051		

mechanical components,
equipment accessories
1



refrigeration cycle components

filter driers

miscellaneous



1

Part No.	750047	Ref. No.	A00DR100
description	dryer size 30g ø 24mm L 143mm connection 6,5/6,5mm type DP20-DP70,DP140		
For models:	BMA0008-F, BMA0010-F, BMA0021-F, BMA0022-F, BMA0024-F, BMA0025-F, BMA0026-F, BMA0027-F, BMA0028-F, BMA0029-F, BMA0032-F, BMA0035-F, BMA0036-F, BMB0028-F, BMB0029-F, BMB0030-F, BMB0033-F, BMB0034-F, BMB0035-F, BMB0036-F, BMB0037-F, BMC0012-F, BMC0014-F, BMC0015-F, BMC0016-F, BNA0036-F, BNA0037-F, BNA0045-F, BNA0064-F, BNA0065-F, BNA0066-F, BNZ0007-F, CCZ0036-F, CCZ0037-F, PB9RI-F, VTGB4A-F		

evaporators

for fridges

producer-specific



1

Part No.	750402	Ref. No.	01A01EV270
description	evaporator L 420mm H 455mm thickness 105mm FRENOX		
For models:	BNA0052-F, BNA0053-F, BNA0064-F		

producer-specific



1

Part No.	750405	Ref. No.	01A01EV371
description	evaporator double for deep freezing FRENOX		
For models:	BNB0012-F, BNB0013-F, BNB0014-F, BNB0015-F, VTGB4A-F		



1

Part No.	750655	Ref. No.	A00EV701
description	evaporator L 389mm W 100mm H 200mm total length 505mm overall width 105mm overall height 200mm		
For models:	BMA0026-F, BMA0032-F, BMB0028-F, BMB0029-F, BMB0033-F, BMB0034-F, BMC0015-F, PB9RI-F		



1

Part No.	750653	Ref. No.	A00EV150
description	evaporator L 390mm W 100mm H 195mm total length 465mm overall width 100mm overall height 200mm		
For models:	BMB0035-F, BMB0036-F, BMB0037-F		



1

Part No.	750546	Ref. No.	A00SHP009
description	evaporator L 395mm W 105mm H 367mm suitable for FRENOX complete with fan		
For models:	BMA0021-F, BMA0022-F, BMB0030-F, BMC0012-F, BMC0014-F, BMC0016-F		



1

Part No.	750654	Ref. No.	A00EV700
description	evaporator L 400mm W 96mm H 200mm total length 480mm overall width 103mm overall height 200mm		
For models:	BMA0008-F, BMA0010-F, BMA0027-F		

1

Part No.	750401	Ref. No.	A00EV140
description	evaporator L 410mm W 100mm H 200mm total length 480mm mounting distance 1 65mm suitable for FRENOX		
For models:	BMA0028-F		



1

Part No.	750404	Ref. No.	01A01EV271
description	evaporator L 410mm W 110mm H 445mm for deep freezing FRENOX		
For models:	BNB0010-F, BNB0011-F, BNB0012-F, BNB0013-F, BNZ0007-F, CCZ0036-F, CCZ0037-F		



1

Part No.	750406	Ref. No.	01A01EV372
description	evaporator L 415mm W 105mm H 480mm double for refrigeration FRENOX		
For models:	BNA0036-F, BNA0037-F, BNA0045-F, BNA0054-F, BNA0055-F, BNA0057-F, BNA0065-F, BNA0066-F		

for refrigerated counters



1

Part No.	750651	Ref. No.	A00EV101
description	evaporator L 390mm W 90mm H 200mm total length 400mm overall width 95mm overall height 430mm		
For models:	BNA0044-F, BNA0056-F, BNB0010-F, BNB0011-F, BNB0012-F, BNB0013-F, BNB0014-F, BNB0015-F, BNZ0004-F, BNZ0006-F, BNZ0007-F, BNZ0008-F, CCZ0036-F, CCZ0037-F, VTGB2A-F, VTGB2-F, VTGB3A-F, VTGB3-F, VTGB4A-F, VTGB4-F		

for display coolers



1

Part No.	750650	Ref. No.	A00EV100
description	evaporator L 390mm W 90mm H 150mm total length 400mm overall width 95mm overall height 430mm		
For models:	BNA0030-F, BNA0031-F, BNA0036-F, BNA0037-F, BNA0045-F, BNA0052-F, BNA0053-F, BNA0054-F, BNA0055-F, BNA0057-F, BNA0064-F, BNA0065-F, BNA0066-F, BNZ0002-F, CCZ0036-F, CCZ0037-F		

evaporation and condensing trays

evaporation trays



1

Part No.	750524	Ref. No.	B01BH101
description	evaporation tray without heating element L 416mm W 103mm H 35mm		
For models:	BNA0030-F, BNA0031-F, BNA0036-F, BNA0037-F, BNA0044-F, BNA0045-F, BNA0052-F, BNA0053-F, BNA0054-F, BNA0055-F, BNA0056-F, BNA0057-F, BNA0064-F, BNA0065-F, BNA0066-F, BNB0010-F, BNB0011-F, BNB0012-F, BNB0013-F, BNB0014-F, BNB0015-F, BNZ0002-F, BNZ0004-F, BNZ0007-F, BNZ0008-F, CCZ0036-F, CCZ0037-F, VTGB2A-F, VTGB2-F, VTGB3A-F, VTGB3-F, VTGB4A-F, VTGB4-F		



unheated condensing trays



1

Part No.	750067	Ref. No.	12036623
description	condensing tray L 255mm W 127mm H 70mm		
For models:	BKZ0022-F, BKZ0023-F		



1

Part No.	750645	Ref. No.	B00BH102 B01BH102
description	evaporation tray L 298mm W 88mm H 50mm plastic		
For models:	BNA0030-F, BNA0031-F, BNA0036-F, BNA0037-F, BNA0044-F, BNA0045-F, BNA0056-F, BNA0064-F, BNA0065-F, BNA0066-F, BNZ0001-F, BNZ0002-F, BNZ0003-F, BNZ0004-F, BNZ0005-F, BNZ0006-F, BNZ0007-F, BNZ0008-F, CCZ0036-F, CCZ0037-F, VTGB2A-F, VTGB2-F, VTGB3A-F, VTGB3-F, VTGB4A-F, VTGB4-F		

transmission technology and ball bearings

chains

half links



1

Part No.	697841	Ref. No.	91410620
description	half link single DIN/ISO 08 B-1 splitting 1/2"		
For models:	CBC0001, CBC0002, CBC0003, CBC0004		

springs

torsion springs



1

Part No.	514527	Ref. No.	260.119.00
description	torsion spring \varnothing 32mm wire gauge \varnothing 5.6mm L1 195mm L2 20mm L3 30mm mounting pos. lid Qty 1 pcs for kettle		
For models:	VS7080PEI50, VS7080PG50, VS7080PGI50		



1

Part No.	692811	Ref. No.	12093685
description	torsion spring \varnothing 34mm L2 6mm wire gauge \varnothing 2mm L1 10mm L3 6mm Qty 1 pcs		
For models:	AIC0043-F, AIC0044-F, AIC0045-F, AIC0046-F, AIC0074-F, AIC0075-F, AIC0079-F, AIC0080-F		



1

Part No.	514522	Ref. No.	260.116.00
description	torsion spring \varnothing 34mm wire gauge \varnothing 6mm L1 370mm L2 22mm L3 22mm mounting pos. left Qty 1 pcs for kettle		
For models:	VS9080PEI150, VS9080PGI150		

compression springs



1

Part No.	696750	Ref. No.	927244 CMT13
description	compression spring \varnothing 20mm L 89.5mm wire gauge \varnothing 2mm windings 14 zinc-coated steel		
For models:	GLB0045, GLB0047, GLB0048, GLB0049, GLB0050, GLB0051		



1

Part No.	691090	Ref. No.	12023716
description	compression spring \varnothing 7.1mm L 25.5mm wire gauge \varnothing 0.7mm		
For models:	AIC0037-F, AIC0038-F, AIC0039-F, AIC0040-F, AIC0041-F, AIC0042-F, AIC0043-F, AIC0044-F, AIC0045-F, AIC0046-F, AIC0071-F, AIC0072-F, AIC0073-F, AIC0074-F, AIC0075-F, AIC0076-F, AIC0077-F, AIC0078-F, AIC0079-F, AIC0080-F		



1

Part No.	700765	Ref. No.	12024164
description	compression spring \varnothing 8.1mm L 20.4mm wire gauge \varnothing 1.2mm		
For models:	AIC0043-F, AIC0044-F, AIC0045-F, AIC0046-F, AIC0074-F, AIC0075-F, AIC0079-F, AIC0080-F		

gas tension springs

gas tension springs



1

Part No.	701299	Ref. No.	35070
description	gas tension spring 50N hub 150mm D1 \varnothing 15mm D2 \varnothing 6mm hole distance 365.5mm hole \varnothing 6.5mm L 380mm		
For models:	GLB0040		



roller springs

roller springs



Part No.	517449	Ref. No.	75271
description	roller spring L 95mm W 66mm		
For models:	GLB0045, GLB0047, GLB0048, GLB0049, GLB0050, GLB0051		



Part No.	517450	Ref. No.	77560
description	roller spring W 51mm ID ø 31mm lug length 90mm		
For models:	GLB0047, GLB0048, GLB0050, GLB0051		

tension springs



Part No.	517406	Ref. No.	260.120.00
description	tension spring ø 29mm total length 230mm wire gauge ø 4mm for tilting bratt pan		
For models:	VS7080BREI, VS7080BREIM, VS7080BRGI, VS7080BRGIM, VS9080BREI, VS9080BREIM, VS9080BRGI, VS9080BRGIM		



Part No.	701625	Ref. No.	260.123.00
description	tension spring ø 44mm total length 350mm wire gauge ø 5.8mm for tilting bratt pan		
For models:	VS7080BREI, VS7080BRGI		



Part No.	701617	Ref. No.	260.121.00
description	tension spring ø 65mm total length 420mm wire gauge ø 8.5mm for tilting bratt pan		
For models:	VS9080BREI, VS9080BRGI		



Part No.	517451	Ref. No.	35020
description	tension spring ø 8mm total length 150mm wire gauge ø 1mm Qty 1 pcs		
For models:	GLB0040		

manometers



Part No.	542405	Ref. No.	678.083.00
description	manometer ø 63mm pressure range 0 up to 1bar 0 up to 14.5PSI filled with glycerin thread 1/4" for kettle connection on the backside		
For models:	VS7080PEI50, VS7080PGI50, VS9080PEI150, VS9080PGI150		

hose reels and spray guns

hose reels

appliance hose reels



Part No.	542093	Ref. No.	12024800 12040977
description	hose reel complete with spray gun hose length 1.8m		
For models:	AIC0037-F, AIC0038-F, AIC0039-F, AIC0040-F, AIC0041-F, AIC0042-F, AIC0043-F, AIC0044-F, AIC0045-F, AIC0046-F		

dosing pumps

peristaltic dosing pumps

GERMAC

built-in version

with frequency control



Part No.	361795 ¹	Ref. No.	19022347
description	dosing pump GERMAC frequency control 3l/h 230VAC detergent hose ø 4x6mm hose thermoplastic type G300 3.5W 230V code 82334968 installation kit inclusive		
For models:	GLB0067-F, GLB0082		
spare parts for	361795		
	Part No.	Ref. No.	—
	mounting set detergent hose type 4x6mm hose length 2m PVC 2x hose/container filter/tank intake transparent		
	Part No.	Ref. No.	—
	dosing pump GERMAC frequency control 3l/h 230VAC detergent hose ø 4x6mm hose thermoplastic type G300 built-in version dimensions 67x72x101mm		

¹with accessories Table continues overleaf



spare parts for 361795			
	Part No.	361467	Ref. No. —
pump hose GERMAC detergent hose type thermoplastic hose ø 6x10mm for model G43/G45/G53/G54/G55/G300/G305			

SEKO

built-in version







with frequency control



1			
Part No.	361767 ¹	Ref. No.	209021
description dosing pump SEKO 3l/h 230VAC detergent hose ø 4x6mm hose type K hose Santoprene suction level 1.5m type NBR 3 8W built-in version peristaltic pump			
For models: GLB0041			
spare parts for 361767			
	Part No.	361815	Ref. No. —
pump hose detergent hose ø 6x10mm hose ø 4x6mm hose type K hose Santoprene type SEKO			

¹incl. inlet and conveyor hose



1			
Part No.	361215	Ref. No.	209016
description dosing pump SEKO frequency control 0.3-3.0l/h 230VAC detergent hose ø 4x6mm hose type K hose Santoprene suction level 1.5m type PBR protection IP55 dimensions 100x67x68mm power input 3.5W			
For models: GLB0040, GLB0041, GLB0042, GLB0043C			
spare parts for 361215			
	Part No.	361136	Ref. No. —
roller assembly for dosing pump hole ø 4.8x4mm			
	Part No.	361226	Ref. No. —
PCB L 59mm W 26mm electronic control			
	Part No.	361815	Ref. No. —
pump hose detergent hose ø 6x10mm hose ø 4x6mm hose type K hose Santoprene type SEKO			
accessories for 361215			
	Part No.	361142	Ref. No. —
mounting set detergent hose type 4x6mm hose length 2m PVC 2x hose/container filter/tank intake transparent			
	Part No.	520090	Ref. No. 143194
PVC hose ID ø 4mm ED ø 6mm L 2m thickness 1mm t.max. 60°C transparent			
	Part No.	520091	Ref. No. —
nylon hose ID ø 4mm ED ø 6mm L 2m thickness 1mm operating p. 10bar burst p. 50bar t.max. 100°C transparent			

without control



1			
Part No.	361902	Ref. No.	209039
description dosing pump SEKO 3l/h 230VAC detergent hose ø 4x6mm hose type L hose Santoprene suction level 1.5m type NPG 3			
For models: GLB0043C-60Hz			
spare parts for 361902			
	Part No.	362004	Ref. No. 143267
dosing hose SEKO detergent hose ø 6x9mm hose length 138mm hose ø 4x6mm hose type L hose Santoprene			



1			
Part No.	361929 ¹	Ref. No.	209036
description dosing pump SEKO without control 0.4l/h 230VAC rinse aid hose ø 4x6mm hose type E hose Sekobril suction level 1.5m type NPG 0.4 8W cable length 45mm built-in version with backflow preventer			
For models: GLB0043C-60Hz			
spare parts for 361929			
	Part No.	361925	Ref. No. 143266
pump hose SEKO rinse aid hose ø 3x8mm with backflow preventer hose ø 6mm hose type E hose Sekobril			

¹with accessories

spare parts



1			
Part No.	362004	Ref. No.	143267
description dosing hose SEKO detergent hose ø 6x9mm hose length 138mm hose ø 4x6mm hose type L hose Santoprene			
For models: GLB0043C-60Hz			



1			
Part No.	361925 ¹	Ref. No.	143266
description pump hose SEKO rinse aid hose ø 3x8mm with backflow preventer hose ø 6mm hose type E hose Sekobril			
For models: GLB0043C-60Hz			

¹with backflow preventer



membrane dosing pumps

self-priming with supporting pressure

SEKO



1

Part No.	362013	Ref. No.	929198
description	dosing pump type DIB P with auxiliary pressure connection for dishwashers pump rate 0-3cm ³ per stroke pressure connection ø 4x6mm suction connection ø 4x6mm auxiliary pressure connection 10mm SEKO		
For models:	GLB0040, GLB0041, GLB0042, GLB0043C		

accessories

container filters



1

Part No.	361062	Ref. No.	12011355
description	container filter hose ø 4mm		
For models:	GLB0067-F, GLB0069-F, GLB0071-F, GLB0080, GLB0081, GLB0082		



1

Part No.	361141	Ref. No.	121075
description	container filter with weight ceramic hose ø 4mm		
For models:	GLB0041, GLB0042, GLB0043C, GLB0043C-60Hz, GLB0044C		

filter weights



1

Part No.	505409	Ref. No.	12024353
description	filter weight ID ø 7.6mm ext. ø 20 L 6mm 12g SS		
For models:	GLB0067-F, GLB0069-F, GLB0071-F, GLB0080, GLB0081, GLB0082		

hoses

PVC hoses



1

Part No.	520090	Ref. No.	143194	
description	PVC hose ID ø 4mm ED ø 6mm L 2m thickness 1mm t.max. 60°C transparent			
For models:	GLB0043C-60Hz			
accessories for	520090			
	Part No.	361058	Ref. No.	—
	Part No.	361066	Ref. No.	—
	Part No.	361106	Ref. No.	—
	Part No.	361141	Ref. No.	121075
	Part No.	361230	Ref. No.	—
	Part No.	361462	Ref. No.	—
	Part No.	361728	Ref. No.	—

tank inlets



1

Part No.	361270	Ref. No.	468151
description	tank inlet SS M12 hose ø 4mm		
For models:	GLB0041, GLB0042, GLB0043C, GLB0043C-60Hz, GLB0044C		

1

Part No.	508427	Ref. No.	12024531
description	tank inlet stainless steel M10 hose ø 4mm		
For models:	GLB0067-F, GLB0071-F, GLB0080, GLB0081, GLB0082		



miscellaneous



Part No.	505228	Ref. No.	12024067
description	spacer bush ID \varnothing 4.5mm ED \varnothing 10mm L 16mm for dosing pump		
For models:	AIC0043-F, AIC0044-F, AIC0045-F, AIC0046-F, AIC0074-F, AIC0075-F, AIC0079-F, AIC0080-F		
spare parts for	505228		
	Part No.	361221	Ref. No. —
	dosing pump type N6 rinse aid pressure connection \varnothing 4x6mm suction connection \varnothing 6x8mm LANG		

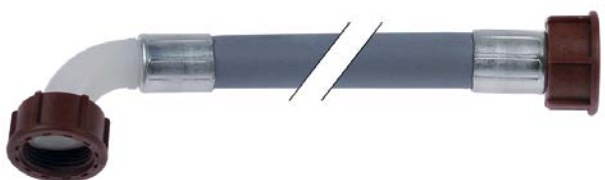

	Part No.	520012	Ref. No.	12025198
description	supply hose PVC straight-curved DN13 connections 3/4" L 2500mm operating p. 10bar burst p. 32bar t.max. 90°C approval VDE flat seal			
For models:	AIC0037-F, AIC0038-F, AIC0039-F, AIC0040-F, AIC0041-F, AIC0042-F, AIC0043-F, AIC0044-F, AIC0045-F, AIC0046-F, AIC0071-F, AIC0072-F, AIC0073-F, AIC0074-F, AIC0075-F, AIC0076-F, AIC0077-F, AIC0078-F, AIC0079-F, AIC0080-F			

hoses

supply hoses

PVC supply hoses



Part No.	520010	Ref. No.	12024115
description	supply hose PVC straight-curved DN13 connections 3/4" L 1500mm operating p. 10bar burst p. 32bar t.max. 90°C blue approval VDE flat seal		
For models:	GLB0067-F, GLB0069-F, GLB0071-F, GLB0080, GLB0081, GLB0082		
accessories for	520010		
	Part No.	520053	Ref. No. —
	screen connection 3/4" D1 \varnothing 26mm D2 \varnothing 15mm Qty 10 pcs rubber thickness 8mm		
	Part No.	520054	Ref. No. —
	flat gasket rubber ED \varnothing 23.5mm ID \varnothing 14mm thickness 2.3mm Qty 10 pcs		

drain hoses

	Part No.	505082	Ref. No.	12024473
description	drain hose DN25 L 1500mm elbow \varnothing inside 48mm elbow ext. \varnothing 58mm outer hose \varnothing 31mm			
For models:	AIC0037-F, AIC0038-F, AIC0039-F, AIC0040-F, AIC0041-F, AIC0042-F, AIC0043-F, AIC0044-F, AIC0045-F, AIC0046-F, GLB0082			

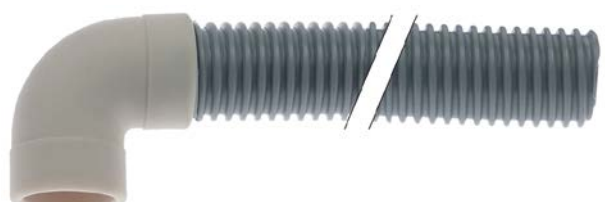
	Part No.	505402	Ref. No.	12115471
description	drain hose DN25 L 2000mm elbow \varnothing inside 27mm elbow ext. \varnothing 35mm inner hose \varnothing 25mm outer hose \varnothing 30mm plastic			
For models:	GLB0067-F			

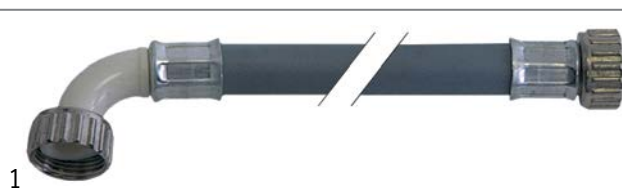

Part No.	520011	Ref. No.	929169
description	supply hose PVC straight-curved DN13 connections 3/4" L 2000mm operating p. 10bar burst p. 32bar t.max. 90°C approval VDE flat seal		
For models:	GLB0041, GLB0042, GLB0043C, GLB0043C-60Hz, GLB0044C		

	Part No.	518068	Ref. No.	143136
description	drain hose DN34 L 2000mm elbow \varnothing inside 50mm elbow ext. \varnothing 59mm inner hose \varnothing 35mm outer hose \varnothing 42mm PVC			
For models:	GLB0040, GLB0041, GLB0042			





1

Part No.	505084	Ref. No.	12023666
description	drain hose DN19 L 2000mm straight \varnothing inside 21mm straight ext. \varnothing 26mm elbow \varnothing inside 21mm elbow ext. \varnothing 27mm outer hose \varnothing 27mm		
For models:	GLB0069-F		

industrial hoses

Niplaflex hoses



1

Part No.	530561	Ref. No.	11000083
description	pressure hose ID \varnothing 10mm ED \varnothing 17mm L 5m thickness 3.5mm operating p. 10bar burst p. 30bar t.max. 110°C		
For models:	AIC0037-F, AIC0038-F, AIC0039-F, AIC0040-F, AIC0041-F, AIC0042-F, AIC0043-F, AIC0044-F, AIC0045-F, AIC0046-F, GLB0067-F, GLB0069-F, GLB0071-F, GLB0080, GLB0081, GLB0082		



1

Part No.	530562	Ref. No.	143010
description	pressure hose ID \varnothing 13mm ED \varnothing 21mm L 5m operating p. 10bar burst p. 30bar t.max. 110°C		
For models:	GLB0040, GLB0041, GLB0042, GLB0043C, GLB0043C-60Hz, GLB0044C, GLB0045, GLB0047, GLB0048, GLB0049, GLB0050, GLB0051		

pressure control hoses



1

Part No.	530560	Ref. No.	11000066 143005 143131
description	pressure control hose ID \varnothing 5mm ED \varnothing 9mm L 5m operating p. 30bar burst p. 90bar temp.-resist. 60°C		
For models:	GLB0040, GLB0041, GLB0042, GLB0043C, GLB0043C-60Hz, GLB0044C, GLB0045, GLB0047, GLB0048, GLB0049, GLB0050, GLB0051, GLB0067-F, GLB0069-F, GLB0071-F, GLB0080, GLB0081, GLB0082		

PVC hoses

PVC hoses without fabric



1

Part No.	520383	Ref. No.	H.775601
description	PVC hose ID \varnothing 4mm ED \varnothing 6mm L 2m thickness 1mm t.max. 60°C blue		
For models:	GLB0043C-60Hz		
accessories for	520383		
	Part No.	361058	Ref. No. —
	container filter with non-return valve SS hose \varnothing 4x6mm \varnothing 20mm L 56mm		
	Part No.	361066	Ref. No. —
	container filter straight SS hose \varnothing 4x6mm L 37mm non return valve ball valve		
	Part No.	361106	Ref. No. —
	container filter with weight and non-return valve SS hose \varnothing 4x6mm \varnothing 21mm L 51mm non return valve lip valve		
	Part No.	361141	Ref. No. 121075
	container filter with weight ceramic hose \varnothing 4mm		
	Part No.	361230	Ref. No. —
	container filter with weight stainless steel hose \varnothing 4x6mm		
	Part No.	361462	Ref. No. —
	container filter with weight SS hose \varnothing 4x6mm		
	Part No.	361728	Ref. No. —
	container filter with 4m 4x6 hose SS hose \varnothing 4x6mm hose length 4000mm		



1





Part No.	520090	Ref. No.	143194
description	PVC hose ID \varnothing 4mm ED \varnothing 6mm L 2m thickness 1mm t.max. 60°C transparent		
For models:	GLB0043C-60Hz		
accessories for	520090		
	Part No.	361058	Ref. No. —
	container filter with non-return valve SS hose \varnothing 4x6mm \varnothing 20mm L 56mm		
	Part No.	361066	Ref. No. —
	container filter straight SS hose \varnothing 4x6mm L 37mm non return valve ball valve		
	Part No.	361106	Ref. No. —
	container filter with weight and non-return valve SS hose \varnothing 4x6mm \varnothing 21mm L 51mm non return valve lip valve		
	Part No.	361141	Ref. No. 121075
	container filter with weight ceramic hose \varnothing 4mm		
	Part No.	361230	Ref. No. —
	container filter with weight stainless steel hose \varnothing 4x6mm		
	Part No.	361462	Ref. No. —
	container filter with weight SS hose \varnothing 4x6mm		

Table continues overleaf



accessories for	520090		
	Part No.	361728	Ref. No.
			—
	container filter with 4m 4x6 hose SS hose ø 4x6mm hose length 4000mm		

	1		
Part No.	520935	Ref. No.	H.165168
description	PVC hose ID ø 6mm ED ø 9mm L 1m transparent warewashing		
For models:	GLB0043C-60Hz		

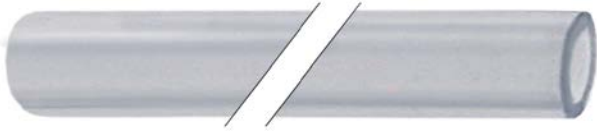
silicone hoses
without fabric

	1		
Part No.	520399 ¹	Ref. No.	11000157
description	silicone hose ID ø 18mm ED ø 26mm Lm thickness 4mm t.max. 200°C red		
For models:	AIC0037-F, AIC0038-F, AIC0039-F, AIC0040-F, AIC0041-F, AIC0042-F, AIC0043-F, AIC0044-F, AIC0045-F, AIC0046-F		

¹by the meter

	1		
Part No.	520842	Ref. No.	143253
description	silicone hose ID ø 3mm ED ø 6mm L 1m thickness 1.5mm t.max. 200°C brown		
For models:	GLB0043C-60Hz		

formed hoses

straight			
	1		
Part No.	513294	Ref. No.	41525 43149
description	formed hose hose ext. ø 20mm ID ø 13mm hose int. ø 25mm L 1350mm		
For models:	GLB0040, GLB0041, GLB0042, GLB0043C-60Hz, GLB0044C, GLB0049, GLB0050, GLB0051		

	1		
Part No.	694706	Ref. No.	12024122
description	hose ID ø 52mm ext. ø 57 L 363mm silicone discharge air steam generator red Qty 1		
For models:	AIC0037-F, AIC0038-F, AIC0039-F, AIC0040-F, AIC0041-F, AIC0042-F, AIC0043-F, AIC0044-F, AIC0045-F, AIC0046-F, AIC0071-F, AIC0072-F, AIC0073-F, AIC0074-F, AIC0075-F, AIC0076-F, AIC0077-F, AIC0078-F, AIC0079-F, AIC0080-F		

form L

	1		
Part No.	513305	Ref. No.	35603
description	formed hose end piece A ext. ø 51mm end piece A int. ø 44mm AD2 ø 42mm ø end piece B 33mm L 300mm		
For models:	GLB0040		

	1		
Part No.	513251	Ref. No.	80187
description	formed hose end piece A ext. ø 59mm end piece A int. ø 47mm AD2 ø 58mm ø end piece B 46mm warewashing L-shape equiv. no. 80187 mounting pos. upper		
For models:	GLB0045, GLB0047, GLB0048		

	1		
Part No.	513250	Ref. No.	80188
description	formed hose ID ø 48mm ED ø 60mm thickness 6mm L1 235mm L2 140mm L-shape		
For models:	GLB0040, GLB0049, GLB0050, GLB0051		





1

Part No.	513254	Ref. No.	80186
description	formed hose L 340mm warewashing L-shape equiv. no. 80186 ID ø 60mm		
For models:	GLB0040, GLB0047, GLB0048, GLB0050, GLB0051		



1

Part No.	503176	Ref. No.	127098
description	formed hose warewashing		
For models:	GLB0043C-60Hz		



1

Part No.	513135	Ref. No.	926056
description	formed hose warewashing L-shape equiv. no. 926056, DZG461		
For models:	GLB0041, GLB0042, GLB0043C, GLB0043C-60Hz, GLB0044C, GLB0045, GLB0047, GLB0048, GLB0049, GLB0050, GLB0051		



1

Part No.	513075	Ref. No.	929164
description	formed hose warewashing L-shape equiv. no. DZG60, 929164		
For models:	GLB0041, GLB0042, GLB0043C, GLB0043C-60Hz, GLB0044C, GLB0045, GLB0047, GLB0048, GLB0049, GLB0050, GLB0051		



1

Part No.	530918	Ref. No.	12039649
description	hose ID ø 30mm ED ø 40mm L 110mm for steam generator		
For models:	AIC0038-F, AIC0040-F, AIC0041-F, AIC0042-F, AIC0043-F, AIC0044-F, AIC0045-F, AIC0046-F		



1

Part No.	530919	Ref. No.	12044832
description	hose ID ø 73mm ED ø 85mm L 150mm for steam generator		
For models:	AIC0046-F		

form U



1

Part No.	513315	Ref. No.	43555
description	formed hose ext. ø 52 D1 ø 44mm L 1200mm		
For models:	GLB0043C-60Hz		



1

Part No.	513199	Ref. No.	69068
description	formed hose for drain pump warewashing		
For models:	GLB0043C-60Hz		

for dishwashers

miscellaneous



1

Part No.	530770	Ref. No.	929171
description	hose ED ø 30mm ID ø 20mm L 1050mm rubber black Qty 1		
For models:	GLB0040, GLB0041, GLB0042, GLB0043C, GLB0043C-60Hz, GLB0044C		



1

Part No.	698706	Ref. No.	127095
description	hose ED ø 31mm ID ø 25mm L 34mm plastic for rinsing		
For models:	GLB0043C-60Hz		



fittings, hose and pipe connectors

hose connectors

without screw connection



1

Part No.	505088	Ref. No.	12023511
description	Y-piece plastic hose ø 12-12-12mm L 75mm		
For models:	GLB0071-F, GLB0080, GLB0082		



1

Part No.	541109	Ref. No.	12023510
description	Y-piece plastic hose ø 8-6-8mm for pressure switch		
For models:	GLB0067-F, GLB0069-F		

hose connectors

brass



1

Part No.	513253	Ref. No.	108006
description	hose connector brass angled thread 1/4" hose ø 12mm Qty 1 pcs		
For models:	GLB0048		

nickel-plated brass



1

Part No.	520202	Ref. No.	927015
description	hose connector nickel-plated brass straight thread 3/8" hose ø 12mm Qty 1 pcs		
For models:	GLB0043C, GLB0044C, GLB0045, GLB0047, GLB0048, GLB0049, GLB0050, GLB0051		

valves and tank inlets

ball valves

universal

ball valves with butterfly handle



1

Part No.	540775	Ref. No.	678.014.00
description	ball valve connection 1" IT - 1" IT DN25 total length 68mm		
For models:	VS7040CPES, VS7040CPGS, VS7080CPES, VS7080CPGS, VS9040CPES, VS9040CPGS, VS9080CPES, VS9080CPGS		
accessories for	540775		
	Part No.	514529	Ref. No. —
	lever handle plastic/metal L 150mm for valve W 120mm H 25mm handle ø 28mm		

shut-off valves

universal



1

Part No.	520548	Ref. No.	678.065.25
description	ball valve complete with star handle H 84mm L 101mm W 26mm shaft ø 7.5mm intake tap ET 3/8"		
For models:	VS7040CPES, VS7040CPGS, VS7080CPES, VS7080CPGS, VS9040CPES, VS9040CPGS, VS9080CPES, VS9080CPGS		

inlet taps



1

Part No.	542394	Ref. No.	256.466.00
description	inlet spout connection 1/2" tube ø 25mm overall height 150mm rotation°		
For models:	VS7080BREI, VS7080BREIM, VS7080BRGI, VS7080BRGIM, VS9080BREI, VS9080BREIM, VS9080BRGI, VS9080BRGIM		

1

Part No.	542393	Ref. No.	256.313.00
description	inlet spout connection 3/8" tube ø 12mm overall height 67mm rotation°		
For models:	VS7040CPES, VS7040CPGS, VS7080CPES, VS7080CPGS, VS9040CPES, VS9040CPGS, VS9080CPES, VS9080CPGS		

water cycle components

pressure reduction valves

pressure reduction valves

universal



1

Part No.	520868	Ref. No.	927150
description	pressure reduction valve OR series PN40 connection 1/2" setting range 1-7bar p max 40bar t.max. 80°C brass		
For models:	GLB0045, GLB0047, GLB0048, GLB0049, GLB0050, GLB0051		

ancillary products

clamps

hose clamps

DIN 3017 - W2



1

Part No.	520114	Ref. No.	12010023
description	hose clamp ø 20-32mm width 9mm Qty 10 pcs DIN 3017		
For models:	AIC0037-F, AIC0038-F, AIC0039-F, AIC0040-F, AIC0041-F, AIC0042-F, AIC0043-F, AIC0044-F, AIC0045-F, AIC0046-F, GLB0069-F, GLB0071-F, GLB0080, GLB0081, GLB0082		



1

Part No.	520115	Ref. No.	12009997
description	hose clamp ø 25-40mm width 9mm Qty 10 pcs DIN 3017		
For models:	AIC0037-F, AIC0038-F, AIC0039-F, AIC0040-F, AIC0041-F, AIC0042-F, AIC0043-F, AIC0044-F, AIC0045-F, AIC0046-F, GLB0067-F, GLB0069-F, GLB0081		



1

Part No.	520118	Ref. No.	12009933
description	hose clamp ø 50-70mm width 9mm Qty 5 pcs DIN 3017		
For models:	GLB0067-F, GLB0069-F, GLB0081		



1

Part No.	520454	Ref. No.	12009914
description	hose clamp ø 70-90mm width 9mm Qty 5 pcs DIN 3017		
For models:	AIC0045-F, AIC0046-F, AIC0075-F, AIC0080-F		



1

Part No.	520117	Ref. No.	12009962
description	hose clamp stainless steel ø 40-60mm width 9mm Qty 5 pcs DIN 3017		
For models:	AIC0037-F, AIC0038-F, AIC0039-F, AIC0040-F, AIC0041-F, AIC0042-F, AIC0043-F, AIC0044-F, AIC0045-F, AIC0046-F, AIC0071-F, AIC0072-F, AIC0073-F, AIC0074-F, AIC0075-F, AIC0076-F, AIC0077-F, AIC0078-F, AIC0079-F, AIC0080-F, GLB0067-F, GLB0069-F, GLB0071-F, GLB0080, GLB0081, GLB0082		

DIN 3017 - W4



1

Part No.	520120	Ref. No.	12010036 927322
description	hose clamp SS W4 ø 12-20mm width 9mm Qty 1 pcs DIN 3017		
For models:	AIC0037-F, AIC0038-F, AIC0039-F, AIC0040-F, AIC0041-F, AIC0042-F, AIC0043-F, AIC0044-F, AIC0045-F, AIC0046-F, GLB0043C-60Hz, GLB0067-F, GLB0069-F, GLB0071-F, GLB0080, GLB0081, GLB0082		



double wire clamps



Part No.	560503	Ref. No.	CFF10073
description	hose clamp ø 8-10mm wire gauge ø 1mm Qty 1 pcs		
For models:	GLB0043C-60Hz		

blind rivet nuts hexagonal



Part No.	696427	Ref. No.	12009970
description	rivet nut thread M5 DN 4mm L 12mm SS Qty 1 pcs ø 7mm WS 6		
For models:	AIC0037-F, AIC0038-F, AIC0039-F, AIC0040-F, AIC0041-F, AIC0042-F, AIC0043-F, AIC0044-F, AIC0045-F, AIC0046-F, AIC0071-F, AIC0072-F, AIC0073-F, AIC0074-F, AIC0075-F, AIC0076-F, AIC0077-F, AIC0078-F, AIC0079-F, AIC0080-F		

tools

cleaning tools

scrapers



Part No.	705023	Ref. No.	610.272.00
description	scraper W 100mm L 420mm		
For models:	VS7040GRACQE, VS7040GRACQG, VS7080GRACQE, VS7080GRACQG, VS9040GRACQE, VS9040GRACQG, VS9080GRACQE, VS9080GRACQG		



Part No.	551034	Ref. No.	12010163
description	rivet nut thread M5 DN 7mm L 12mm Qty 10 pcs		
For models:	AIC0037-F, AIC0038-F, AIC0039-F, AIC0040-F, AIC0041-F, AIC0042-F, AIC0043-F, AIC0044-F, AIC0045-F, AIC0046-F, AIC0071-F, AIC0072-F, AIC0073-F, AIC0074-F, AIC0075-F, AIC0076-F, AIC0077-F, AIC0078-F, AIC0079-F, AIC0080-F		



Part No.	550776	Ref. No.	12010126
description	rivet nut thread M6 DN 10mm L 15mm SS Qty 1 pcs		
For models:	AIC0037-F, AIC0038-F, AIC0039-F, AIC0040-F, AIC0041-F, AIC0042-F, AIC0043-F, AIC0044-F, AIC0045-F, AIC0046-F, AIC0071-F, AIC0072-F, AIC0073-F, AIC0074-F, AIC0075-F, AIC0076-F, AIC0077-F, AIC0078-F, AIC0079-F, AIC0080-F		

fastening material

rivets/rivet nuts

blind rivets DIN 7337 - stainless steel



Part No.	560157	Ref. No.	12010065
description	blind rivet SS ø 3.2mm L 6mm Qty 50 pcs DIN 1700		
For models:	AIC0043-F, AIC0044-F, AIC0045-F, AIC0046-F, AIC0074-F, AIC0075-F, AIC0079-F, AIC0080-F		



Part No.	560049	Ref. No.	12010090
description	blind rivet SS ø 4mm L 7.5mm Qty 50 pcs		
For models:	AIC0037-F, AIC0038-F, AIC0039-F, AIC0040-F, AIC0041-F, AIC0042-F, AIC0043-F, AIC0044-F, AIC0045-F, AIC0046-F, AIC0073-F, AIC0074-F, AIC0075-F, AIC0078-F, AIC0079-F, AIC0080-F		

screws

countersunk screws





Part No.	560041	Ref. No.	12010199
description	countersunk screw thread M5 L 16mm WS 3 SS DIN 7991/ISO 10642 Qty 20 pcs intake hexagonal		
For models:	AIC0037-F, AIC0038-F, AIC0039-F, AIC0040-F, AIC0041-F, AIC0042-F, AIC0071-F, AIC0072-F, AIC0073-F, AIC0076-F, AIC0077-F, AIC0078-F		



 <p>1</p>			
Part No.	560211	Ref. No.	12010262
description	countersunk screw thread M4 L 14mm SS DIN 963/ISO 2009 Qty 20 pcs intake slotted head ø 7.5mm		
For models:	AIC0037-F, AIC0038-F, AIC0039-F, AIC0040-F, AIC0041-F, AIC0042-F, AIC0043-F, AIC0044-F, AIC0045-F, AIC0046-F, AIC0071-F, AIC0072-F, AIC0073-F, AIC0074-F, AIC0075-F, AIC0076-F, AIC0077-F, AIC0078-F, AIC0079-F, AIC0080-F		

flat-headed bolts

 <p>1</p>			
Part No.	560062	Ref. No.	12010278
description	flat-headed bolt thread M4 thread L 10mm SS DIN 7985/ISO 7045 Qty 20 pcs intake Phillips head ø 8mm head thickness 2mm		
For models:	AIC0037-F, AIC0038-F, AIC0039-F, AIC0040-F, AIC0041-F, AIC0042-F, AIC0043-F, AIC0044-F, AIC0045-F, AIC0046-F, AIC0071-F, AIC0072-F, AIC0073-F, AIC0074-F, AIC0075-F, AIC0076-F, AIC0077-F, AIC0078-F, AIC0079-F, AIC0080-F		

 <p>1</p>			
Part No.	560061	Ref. No.	12009876
description	flat-headed bolt thread M4 thread L 6mm SS DIN 7985/ISO 7045 Qty 20 pcs intake Phillips head ø 8mm head thickness 2mm		
For models:	AIC0037-F, AIC0038-F, AIC0039-F, AIC0040-F, AIC0041-F, AIC0042-F, AIC0043-F, AIC0044-F, AIC0045-F, AIC0046-F, AIC0071-F, AIC0072-F, AIC0073-F, AIC0074-F, AIC0075-F, AIC0076-F, AIC0077-F, AIC0078-F, AIC0079-F, AIC0080-F		

 <p>1</p>			
Part No.	560068	Ref. No.	12010213
description	flat-headed bolt thread M5 thread L 16mm SS DIN 7985/ISO 7045 Qty 20 pcs intake Phillips head ø 10mm head thickness 2mm		
For models:	AIC0043-F, AIC0044-F, AIC0045-F, AIC0046-F, AIC0074-F, AIC0075-F, AIC0079-F, AIC0080-F		

oval head screws

 <p>1</p>			
Part No.	560057	Ref. No.	12010242
description	oval head screw thread M5 L 13mm stainless steel intake Phillips Qty 10 pcs		
For models:	AIC0037-F, AIC0038-F, AIC0039-F, AIC0040-F, AIC0041-F, AIC0042-F, AIC0043-F, AIC0044-F, AIC0045-F, AIC0046-F, AIC0071-F, AIC0072-F, AIC0073-F, AIC0074-F, AIC0075-F, AIC0076-F, AIC0077-F, AIC0078-F, AIC0079-F, AIC0080-F, GLB0071-F, GLB0080, GLB0082		

hexagonal screws

 <p>1</p>			
Part No.	560311	Ref. No.	12010030
description	hexagonal screw thread M10 thread L 20mm SS WS 17 Qty 1 pcs DIN 933 / ISO 4017		
For models:	AIC0037-F, AIC0038-F, AIC0039-F, AIC0040-F, AIC0041-F, AIC0042-F, AIC0043-F, AIC0044-F, AIC0045-F, AIC0046-F, AIC0071-F, AIC0072-F, AIC0073-F, AIC0074-F, AIC0075-F, AIC0076-F, AIC0077-F, AIC0078-F, AIC0079-F, AIC0080-F		

 <p>1</p>			
Part No.	560081	Ref. No.	12010249
description	hexagonal screw thread M4 thread L 10mm SS WS 7 Qty 20 pcs DIN 933 / ISO 4017		
For models:	AIC0037-F, AIC0038-F, AIC0039-F, AIC0040-F, AIC0041-F, AIC0042-F, AIC0043-F, AIC0044-F, AIC0045-F, AIC0046-F, AIC0071-F, AIC0072-F, AIC0073-F, AIC0074-F, AIC0075-F, AIC0076-F, AIC0077-F, AIC0078-F, AIC0079-F, AIC0080-F		

 <p>1</p>			
Part No.	560083	Ref. No.	12010238
description	hexagonal screw thread M5 thread L 10mm SS WS 8 Qty 20 pcs DIN 933 / ISO 4017		
For models:	AIC0037-F, AIC0038-F, AIC0039-F, AIC0040-F, AIC0041-F, AIC0042-F, AIC0043-F, AIC0044-F, AIC0045-F, AIC0046-F, AIC0071-F, AIC0072-F, AIC0073-F, AIC0074-F, AIC0075-F, AIC0076-F, AIC0077-F, AIC0078-F, AIC0079-F, AIC0080-F		

 <p>1</p>			
Part No.	524118	Ref. No.	12010186
description	hexagonal screw thread M6 thread L 16mm SS WS 10 Qty 1 pcs DIN 933 / ISO 4017		
For models:	AIC0037-F, AIC0038-F, AIC0039-F, AIC0040-F, AIC0041-F, AIC0042-F, AIC0043-F, AIC0044-F, AIC0045-F, AIC0046-F, AIC0071-F, AIC0072-F, AIC0073-F, AIC0074-F, AIC0075-F, AIC0076-F, AIC0077-F, AIC0078-F, AIC0079-F, AIC0080-F		

 <p>1</p>			
Part No.	560088	Ref. No.	12010180
description	hexagonal screw thread M6 thread L 20mm SS WS 10 Qty 20 pcs DIN 933 / ISO 4017		
For models:	AIC0037-F, AIC0038-F, AIC0039-F, AIC0040-F, AIC0041-F, AIC0042-F, AIC0071-F, AIC0072-F, AIC0073-F, AIC0076-F, AIC0077-F, AIC0078-F		



			
1			
Part No.	506446	Ref. No.	12010056
description	hexagonal screw thread M8 thread L 40mm SS WS 13 Qty 1 pcs DIN 933 / ISO 4017		
For models:	AIC0037-F, AIC0038-F, AIC0039-F, AIC0040-F, AIC0041-F, AIC0042-F, AIC0043-F, AIC0044-F, AIC0045-F, AIC0046-F, AIC0071-F, AIC0072-F, AIC0073-F, AIC0074-F, AIC0075-F, AIC0076-F, AIC0077-F, AIC0078-F, AIC0079-F, AIC0080-F		

cylinder head bolts

DIN 912/ISO 4762

			
1			
Part No.	560380	Ref. No.	12010084
description	cylinder head bolt thread M6 L 40mm thread L 25mm WS 5 SS Qty 1 pcs DIN 912/ISO 4762		
For models:	AIC0038-F, AIC0040-F, AIC0042-F, AIC0044-F, AIC0046-F, AIC0076-F, AIC0077-F, AIC0078-F, AIC0079-F, AIC0080-F		

grub screws

DIN 916/ISO 4029

			
1			
Part No.	560549	Ref. No.	12010236
description	grub screw thread M6 L 15mm SS DIN 916/ISO 4029 intake internal hexagon WS 3 Qty 1 pcs		
For models:	AIC0043-F, AIC0044-F, AIC0045-F, AIC0046-F, AIC0074-F, AIC0075-F, AIC0079-F, AIC0080-F		

threaded rods

miscellaneous

			
1			
Part No.	530900	Ref. No.	941.162.00
description	threaded rod thread M12x1.5 zinc-coated steel thread L 80mm		
For models:	VS7080BREIM, VS7080BRGIM, VS9080BREIM, VS9080BRGIM		

nuts

hexagonal nuts

DIN 934 / ISO 4032/8673

			
1			
Part No.	560131	Ref. No.	12009839
description	hexagonal nut thread M4 H 3.2mm WS 7 SS DIN/ISO DIN 934 / ISO 4032/8673 Qty 20 pcs		
For models:	AIC0037-F, AIC0038-F, AIC0039-F, AIC0040-F, AIC0041-F, AIC0042-F, AIC0043-F, AIC0044-F, AIC0045-F, AIC0046-F, AIC0074-F, AIC0075-F		

			
1			
Part No.	560132	Ref. No.	12010284
description	hexagonal nut thread M5 H 4mm WS 8 SS DIN/ISO DIN 934 / ISO 4032/8673 Qty 20 pcs		
For models:	AIC0037-F, AIC0038-F, AIC0039-F, AIC0040-F, AIC0041-F, AIC0042-F, AIC0043-F, AIC0044-F, AIC0045-F, AIC0046-F, AIC0071-F, AIC0072-F, AIC0073-F, AIC0074-F, AIC0075-F, AIC0076-F, AIC0077-F, AIC0078-F, AIC0079-F, AIC0080-F		

			
1			
Part No.	511212	Ref. No.	12010255
description	hexagonal nut thread M6 H 5mm WS 10 SS DIN/ISO DIN 934 / ISO 4032/8673 Qty 1 pcs		
For models:	AIC0037-F, AIC0038-F, AIC0039-F, AIC0040-F, AIC0041-F, AIC0042-F, AIC0043-F, AIC0044-F, AIC0045-F, AIC0046-F, AIC0071-F, AIC0072-F, AIC0073-F, AIC0074-F, AIC0075-F, AIC0076-F, AIC0077-F, AIC0078-F, AIC0079-F, AIC0080-F		

			
1			
Part No.	560134	Ref. No.	12010210
description	hexagonal nut thread M8 H 6.5mm WS 13 SS DIN/ISO DIN 934 / ISO 4032/8673 Qty 20 pcs		
For models:	AIC0037-F, AIC0038-F, AIC0039-F, AIC0040-F, AIC0041-F, AIC0042-F, AIC0043-F, AIC0044-F, AIC0045-F, AIC0046-F, AIC0071-F, AIC0072-F, AIC0073-F, AIC0074-F, AIC0075-F, AIC0076-F, AIC0077-F, AIC0078-F, AIC0079-F, AIC0080-F		





hexagonal nuts metric (without norm)			
			
1			
Part No.	102382	Ref. No.	673.024.00
description	nut thread M14x1 H 3.5mm WS 18 brass Qty 1 pcs		
For models:	VS7080BRGI, VS7080BRGIM, VS9080BRGI, VS9080BRGIM		

washers

spring rings			
			
1			
Part No.	560123	Ref. No.	12009872
description	lock washer ID ø 6.3mm ED ø 11mm SS DIN127 Qty 20 pcs for thread M6		
For models:	AIC0037-F, AIC0039-F, AIC0041-F, AIC0043-F, AIC0045-F, AIC0071-F, AIC0072-F, AIC0073-F, AIC0074-F, AIC0075-F		

washers

DIN 125A			
			
1			
Part No.	560111	Ref. No.	12009987
description	plain washer ID ø 4.3mm ED ø 9mm thickness 0.8mm SS Qty 20 pcs DIN 125A for thread M4		
For models:	AIC0037-F, AIC0038-F, AIC0039-F, AIC0040-F, AIC0041-F, AIC0042-F, AIC0043-F, AIC0044-F, AIC0045-F, AIC0046-F, AIC0071-F, AIC0072-F, AIC0073-F, AIC0074-F, AIC0075-F, AIC0076-F, AIC0077-F, AIC0078-F, AIC0079-F, AIC0080-F		

			
1			
Part No.	560112	Ref. No.	12009944
description	plain washer ID ø 5.3mm ED ø 10mm thickness 1mm SS Qty 20 pcs DIN 125A for thread M5		
For models:	AIC0037-F, AIC0038-F, AIC0039-F, AIC0040-F, AIC0041-F, AIC0042-F, AIC0043-F, AIC0044-F, AIC0045-F, AIC0046-F, AIC0071-F, AIC0072-F, AIC0073-F, AIC0074-F, AIC0075-F, AIC0076-F, AIC0077-F, AIC0078-F, AIC0079-F, AIC0080-F		

			
1			
Part No.	560113	Ref. No.	12009868
description	plain washer ID ø 6.4mm ED ø 12mm thickness 1.6mm SS Qty 20 pcs DIN 125A for thread M6		
For models:	AIC0037-F, AIC0038-F, AIC0039-F, AIC0040-F, AIC0041-F, AIC0042-F, AIC0043-F, AIC0044-F, AIC0045-F, AIC0046-F, AIC0071-F, AIC0072-F, AIC0073-F, AIC0074-F, AIC0075-F, AIC0076-F, AIC0077-F, AIC0078-F, AIC0079-F, AIC0080-F		

DIN 9021			
			
1			
Part No.	560117	Ref. No.	12010267
description	plain washer ID ø 6.4mm ED ø 18mm thickness 1.5mm SS Qty 20 pcs DIN 9021 for thread M6		
For models:	AIC0037-F, AIC0038-F, AIC0039-F, AIC0040-F, AIC0041-F, AIC0042-F, AIC0043-F, AIC0044-F, AIC0045-F, AIC0046-F, AIC0071-F, AIC0072-F, AIC0073-F, AIC0074-F, AIC0076-F, AIC0077-F, AIC0078-F		

miscellaneous			
			
1			
Part No.	512509	Ref. No.	9221747.00
description	plain washer ID ø 8.4mm ED ø 40mm thickness 2mm		
For models:	VS7080BREI, VS7080BREIM, VS7080BRGI, VS7080BRGIM, VS9080BREI, VS9080BREIM, VS9080BRGI, VS9080BRGIM		

tooth lock washers

DIN 6798A			
			
1			
Part No.	560125	Ref. No.	12009928
description	tooth lock washer ID ø 4.2mm ED ø 8mm SS DIN/ISO DIN 6798A Qty 20 pcs for thread M4		
For models:	AIC0037-F, AIC0038-F, AIC0039-F, AIC0040-F, AIC0041-F, AIC0042-F, AIC0043-F, AIC0044-F, AIC0045-F, AIC0046-F, AIC0071-F, AIC0072-F, AIC0073-F, AIC0074-F, AIC0075-F, AIC0076-F, AIC0077-F, AIC0079-F, AIC0080-F		

			
1			
Part No.	560126	Ref. No.	12009890
description	tooth lock washer ID ø 5.2mm ED ø 10mm SS DIN/ISO DIN 6798A Qty 20 pcs for thread M5		
For models:	AIC0037-F, AIC0038-F, AIC0039-F, AIC0040-F, AIC0041-F, AIC0042-F, AIC0043-F, AIC0044-F, AIC0045-F, AIC0046-F, AIC0071-F, AIC0072-F, AIC0073-F, AIC0074-F, AIC0075-F, AIC0076-F, AIC0077-F, AIC0078-F, AIC0079-F, AIC0080-F		

			
1			
Part No.	560342	Ref. No.	12009882
description	tooth lock washer ID ø 6.5mm ED ø 11mm SS Qty 1 pcs for thread M6		
For models:	AIC0037-F, AIC0038-F, AIC0039-F, AIC0040-F, AIC0041-F, AIC0042-F, AIC0043-F, AIC0044-F, AIC0045-F, AIC0046-F, AIC0071-F, AIC0072-F, AIC0073-F, AIC0074-F, AIC0075-F, AIC0076-F, AIC0077-F, AIC0078-F, AIC0079-F, AIC0080-F		



fasteners

clamps

hose clamps

DIN 3017 - W2



1

Part No.	520114	Ref. No.	12010023
-----------------	--------	-----------------	----------

description hose clamp ø 20-32mm width 9mm Qty 10 pcs DIN 3017

For models: AIC0037-F, AIC0038-F, AIC0039-F, AIC0040-F, AIC0041-F, AIC0042-F, AIC0043-F, AIC0044-F, AIC0045-F, AIC0046-F, GLB0069-F, GLB0071-F, GLB0080, GLB0081, GLB0082



1

Part No.	520115	Ref. No.	12009997
-----------------	--------	-----------------	----------

description hose clamp ø 25-40mm width 9mm Qty 10 pcs DIN 3017

For models: AIC0037-F, AIC0038-F, AIC0039-F, AIC0040-F, AIC0041-F, AIC0042-F, AIC0043-F, AIC0044-F, AIC0045-F, AIC0046-F, GLB0067-F, GLB0069-F, GLB0081



1

Part No.	520118	Ref. No.	12009933
-----------------	--------	-----------------	----------

description hose clamp ø 50-70mm width 9mm Qty 5 pcs DIN 3017

For models: GLB0067-F, GLB0069-F, GLB0081



1

Part No.	520454	Ref. No.	12009914
-----------------	--------	-----------------	----------

description hose clamp ø 70-90mm width 9mm Qty 5 pcs DIN 3017

For models: AIC0045-F, AIC0046-F, AIC0075-F, AIC0080-F



1

Part No.	520117	Ref. No.	12009962
-----------------	--------	-----------------	----------

description hose clamp stainless steel ø 40-60mm width 9mm Qty 5 pcs DIN 3017

For models: AIC0037-F, AIC0038-F, AIC0039-F, AIC0040-F, AIC0041-F, AIC0042-F, AIC0043-F, AIC0044-F, AIC0045-F, AIC0046-F, AIC0071-F, AIC0072-F, AIC0073-F, AIC0074-F, AIC0075-F, AIC0076-F, AIC0077-F, AIC0078-F, AIC0079-F, AIC0080-F, GLB0067-F, GLB0069-F, GLB0071-F, GLB0080, GLB0081, GLB0082

DIN 3017 - W4



1

Part No.	520120	Ref. No.	12010036 927322
-----------------	--------	-----------------	--------------------

description hose clamp SS W4 ø 12-20mm width 9mm Qty 1 pcs DIN 3017

For models: AIC0037-F, AIC0038-F, AIC0039-F, AIC0040-F, AIC0041-F, AIC0042-F, AIC0043-F, AIC0044-F, AIC0045-F, AIC0046-F, GLB0043C-60Hz, GLB0067-F, GLB0069-F, GLB0071-F, GLB0080, GLB0081, GLB0082

double wire clamps



1

Part No.	560503	Ref. No.	CFF10073
-----------------	--------	-----------------	----------

description hose clamp ø 8-10mm wire gauge ø 1mm Qty 1 pcs

For models: GLB0043C-60Hz

retaining rings

DIN 472



1

Part No.	523106	Ref. No.	12010122
-----------------	--------	-----------------	----------

description retaining ring bore ø 28mm thickness 1.3mm steel DIN 472

For models: AIC0037-F, AIC0038-F, AIC0039-F, AIC0040-F, AIC0041-F, AIC0042-F, AIC0043-F, AIC0044-F, AIC0045-F, AIC0046-F, AIC0071-F, AIC0072-F, AIC0073-F, AIC0074-F, AIC0075-F, AIC0076-F, AIC0077-F, AIC0078-F, AIC0079-F, AIC0080-F

DIN 6799



1

Part No.	691470	Ref. No.	12010014
-----------------	--------	-----------------	----------

description retaining ring E D1 ø 8mm D2 ø 16mm SS DIN 6799 thickness 1mm for shaft ø 9-12mm

For models: AIC0037-F, AIC0038-F, AIC0039-F, AIC0040-F, AIC0041-F, AIC0042-F, AIC0043-F, AIC0044-F, AIC0045-F, AIC0046-F, AIC0071-F, AIC0072-F, AIC0073-F, AIC0074-F, AIC0075-F, AIC0076-F, AIC0077-F, AIC0078-F, AIC0079-F, AIC0080-F



roll pins



1

Part No.	691725	Ref. No.	12010273
description	roll pin ø 4.5mm L 15mm		
For models:	AIC0037-F, AIC0038-F, AIC0039-F, AIC0040-F, AIC0041-F, AIC0042-F, AIC0043-F, AIC0044-F, AIC0045-F, AIC0046-F		

cotter pins



1

Part No.	551305	Ref. No.	12010292
description	cotter pin ø 2mm L 23mm SS Qty 20 pcs		
For models:	AIC0043-F, AIC0044-F, AIC0045-F, AIC0046-F, AIC0074-F, AIC0075-F, AIC0079-F, AIC0080-F		

consumables

fuses

fine fuses



1

Part No.	358530	Ref. No.	926284
description	fine fuse size ø5x20mm 0.8A fast-acting rated 250V Qty 10 pcs		
For models:	GLB0040, GLB0041, GLB0042, GLB0043C, GLB0044C, GLB0045, GLB0047, GLB0048		



1

Part No.	358677	Ref. No.	228004
description	fine fuse size ø5x20mm 4A fast-acting rated 250V Qty 10 pcs		
For models:	GLB0040, GLB0041, GLB0042, GLB0043C, GLB0043C-60Hz, GLB0044C, GLB0047, GLB0048		



1

Part No.	358594	Ref. No.	228012
description	fine fuse size ø5x20mm 0.16A slow-acting rated 250V Qty 10 pcs		
For models:	GLB0043C-60Hz, GLB0047		



1

Part No.	358603	Ref. No.	228011
description	fine fuse size ø5x20mm 2A slow-acting rated 250V Qty 10 pcs		
For models:	GLB0043C-60Hz, GLB0047		

ø6.3x32mm 250V



1

Part No.	358760	Ref. No.	926283
description	fine fuse size ø6.3x32mm 0.315A medium lag rated 250V Qty 10 pcs		
For models:	GLB0040, GLB0041, GLB0042, GLB0043C, GLB0044C, GLB0045, GLB0047, GLB0048		

fine fuse holders



1

Part No.	550519	Ref. No.	H.228048
description	cover plate suitable fuseA ratedV connection for fuse holder		
For models:	GLB0040, GLB0041, GLB0042, GLB0043C, GLB0044C, GLB0047, GLB0048		

thermal fuses



1

Part No.	358190	Ref. No.	663.077.00
description	thermal fuse switch-off temp. 98°C		
For models:	VS9080TPET, VS9080TPFE		

GASTROPARTS.COM

