



GASTROPARTS

Vibiemme

- [EN]** Equipment
- [DE]** Geräte
- [ES]** Aparatos
- [FR]** Équipement
- [IT]** Attrezzature
- [PL]** Urządzenia
- [RU]** Оборудование

✉ gastroparts@gastroparts.com

☎ +48 56 657 00 66

📘 fb.com/gastroparts.global



GASTROPARTS.COM









heating elements



heating elements for coffee machine

 <p>1</p>			
Part No.	417081	Ref. No.	ELETRESD1422
description	heating element 1350W 230V heating circuits 1 thread 1" L 140mm W 22mm H 23mm tube ø 8.5mm connection 6.3 immersion heater flange with thread		
For models:	Domobar-Interruttore-Levetta, Domobar-Interruttore-Luminoso		
accessories for	417081		
	Part No.	Ref. No.	—
	510404		
	flat gasket fibre ED ø 44mm ID ø 34mm thickness 2mm Qty 1 pcs		
	Part No.	Ref. No.	—
	528018		
	flat gasket PTFE ED ø 41mm ID ø 33mm thickness 3mm size 1" Qty 1 pcs		



 <p>1</p>			
Part No.	417498	Ref. No.	ELETRESSM1822 UNK30335220
description	heating element 1800W 230V heating circuits 1 thread 1 1/4" L 140mm W 26mm H 26mm tube ø 8.5mm connection male faston 6.3mm immersion heater connection length 15mm coffee machine parts WS 37 copper		
For models:	Domobar-Super-Elettronica, Domobar-Super-Manuale		

 <p>1</p>			
Part No.	417030	Ref. No.	ELETRES1G1822
description	heating element 1800W 230V heating circuits 2 mounting ø 40mm hole distance 57mm L 177mm W 26mm H 53mm L1 35mm L2 60mm L3 74mm H1 24mm H2 29mm hole ø 10mm tube ø 8.5mm connection M6 immersion heater 3 hole flange suitable for BRASILIA, VIBIEMME		

 <p>1</p>			
Part No.	417150	Ref. No.	ELETRES2G2722 ELETRES2G2724
description	heating element 2700W 230V heating circuits 2 mounting ø 38.5mm hole distance 57mm L 252mm W 26mm H 65mm L1 30mm L2 42mm L3 180mm H1 24mm H2 40mm windings 3 hole ø 11mm connection M6x1 immersion heater 3 hole flange		
For models:	Minimax-Kometa-Elettronica, Minimax-Kometa-Pulsante, Minimax-Replica-Elettronica		
accessories for	417150		
	Part No.	Ref. No.	N/A
	528012		
	gasket suitable for VIBIEMME for heating element		

 <p>1</p>			
Part No.	417348	Ref. No.	ELETRES2G3522 ELETRES2G4023
description	heating element 4000W 230V heating circuits 2 mounting ø 38.5mm hole distance 57mm L 330mm W 28mm H 55mm L1 25mm L2 70mm L3 235mm H1 25mm H2 30mm windings 2 hole ø 11mm tube ø 8.5mm connection M6 immersion heater 3 hole flange		
For models:	Cubo-2gr-Elettronico, Cubo-2gr-Manuale, Evolution-2gr-elettronica-epuls, Lollo-2gruppi, Replica-elettronica-2gr, Replica-manuale-2gr, Replica-pulsante-2gr, Revolution-2gr-elettronica-epuls		
accessories for	417348		
	Part No.	Ref. No.	—
	528013		
	gasket ID ø 40mm fibre thickness 4mm hole ø 11mm hole distance 57mm for heating element coffee machine parts		

 <p>1</p>			
Part No.	417159	Ref. No.	N/A
description	heating element 4000W 380V heating circuits 2 mounting ø 40mm hole distance 57mm L 492mm W 26mm H 72mm L1 35mm L2 60mm L3 397mm H1 24mm H2 48mm windings 2 hole ø 10mm tube ø 6.3mm connection M5 immersion heater 3 hole flange suitable for VIBIEMME		
accessories for	417159		
	Part No.	Ref. No.	—
	528013		
	gasket ID ø 40mm fibre thickness 4mm hole ø 11mm hole distance 57mm for heating element coffee machine parts		

 <p>1</p>			
Part No.	417439	Ref. No.	ELETRES3G4522 ELETRES3G5023
description	heating element 5000W 230V heating circuits 2 mounting ø 39mm hole distance 57mm L 455mm W 25mm H 51mm L1 35mm L2 65mm L3 335mm H1 25mm H2 26mm windings 2		
For models:	Cubo-3gr-Elettronico, Cubo-3gr-Manuale, Evolution-3gr-elettronica-epuls, Lollo-3gruppi, Replica-elettronica-3gr, Replica-manuale-3gr, Replica-pulsante-3gr, Revolution-3gr-elettronica-epuls		
accessories for	417439		
	Part No.	Ref. No.	—
	528013		
	gasket ID ø 40mm fibre thickness 4mm hole ø 11mm hole distance 57mm for heating element coffee machine parts		

accessories

sealing washers

fibre gaskets

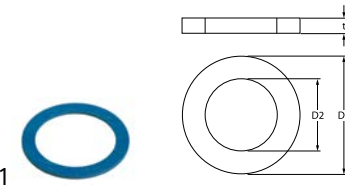
 <p>1</p>			
Part No.	510405	Ref. No.	N/A
description	flat gasket fibre ED ø 56mm ID ø 42mm thickness 2mm for thread 1 1/4" Qty 1 pcs		



PTFE gaskets

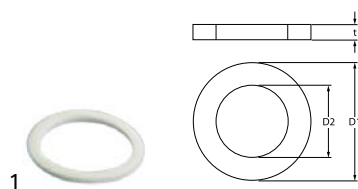

Part No.	528021	Ref. No.	GUARRESPICTEF
description	flat gasket PTFE ED ø 53mm ID ø 42.5mm thickness 3mm Qty 1 pcs equiv. no. 12001/02286 suitable for Astoria/Aurora/Brasilia/Wega		
For models:	Domobar-Super-Elettronica, Domobar-Super-Manuale, Lollo-1gruppo		

flange gaskets



Part No.	528740	Ref. No.	GUARRESTR UNK70406620
description	gasket ID ø 44mm PTFE thickness 3.5mm hole ø 9.5mm hole distance 58mm suitable for ITALCREM, VISACREM for heating element coffee machine parts		
For models:	Chimaera, Cubo-2gr-Elettronico, Cubo-2gr-Manuale, Cubo-3gr-Elettronico, Cubo-3gr-Manuale, Cubo-4gr-Elettronico, Cubo-4gr-Manuale, Evolution-2gr-elettronica-e-puls, Evolution-3gr-elettronica-e-puls, Lollo-2gruppi, Lollo-3gruppi, Minimax-Kometa-Elettronica, Minimax-Kometa-Pulsante, Minimax-Replica-Elettronica, Replica-2gr-elettronica-multiboiler, Replica-2gr-manuale-multiboiler, Replica-3gr-elettronica-multiboiler, Replica-3gr-manuale-multiboiler, Replica-elettronica-2gr, Replica-elettronica-3gr, Replica-elettronica-4gr, Replica-manuale-2gr, Replica-manuale-3gr, Replica-manuale-4gr, Replica-pulsante-2gr, Replica-pulsante-3gr, Replica-pulsante-4gr, Revolution-2gr-elettronica-epuls, Revolution-3gr-elettronica-epuls		



Part No.	528012	Ref. No.	N/A
description	gasket suitable for VIBIEMME for heating element		

thermostats

bi-metal thermostats

safety bi-metal thermostats



Part No.	390688	Ref. No.	ELETSALRESUL UNK6264978
description	bi-metal safety thermostat hole distance 39mm switch-off temp. 130°C 2NC 2-pole 10A connection male faston 3.2mm mounting ø 31mm		
For models:	Evolution-2gr-elettronica-e-puls, Evolution-3gr-elettronica-e-puls, Revolution-2gr-elettronica-epuls, Revolution-3gr-elettronica-epuls		



Part No.	390740	Ref. No.	ELETGLDOMM165
description	bi-metal thermostat hole distance mm switch-off temp. 165°C 1NC 16A connection F6.3		
For models:	Domobar-Junior-2B, Domobar-Junior-HX, Domobar-Super-2b-Pid-Elettronica, Domobar-Super-2b-Pid-Manuale		

bi-metal thermostats



Part No.	390739	Ref. No.	ELETGLDOM128
description	bi-metal thermostat hole distance 23.5mm switch-off temp. 130°C 1NC 1-pole 16A 250V connection F6.3		
For models:	Chimaera, Domobar-Super-2b-Pid-Elettronica, Domobar-Super-2b-Pid-Manuale, Replica-2gr-elettronica-multiboiler, Replica-2gr-manuale-multiboiler, Replica-3gr-elettronica-multiboiler, Replica-3gr-manuale-multiboiler		

control and safety thermostats

PRODIGY / FIRT

control thermostats



Part No.	390716	Ref. No.	ELETTEDOMJU2B
description	thermostat t.max. 55°C temperature range°C 1-pole 1CO 16A probe ø 6.5mm probe L 90mm capillary pipe 1700mm capillary pipe isolated 1500mm gland nut M14x1 shaft ø 6x4.6mm shaft L 6mm shaft position lower rotation 315° probe material copper		
For models:	Domobar-Interruttore-Levetta, Domobar-Interruttore-Luminoso, Domobar-Junior-2B		



Part No.	390626	Ref. No.	ELETTEDOM
description	thermostat t.max. 55°C temperature range°C 1-pole 1CO 16A probe ø 6mm probe L 72mm capillary pipe 700mm capillary pipe isolatedmm gland nut shaft ø 6x4.6mm shaft L 6mm shaft position upper rotation 270° probe material copper		



switches and momentary switches

rocker/momentary rocker switches

30x22mm



1

Part No.	346896 ¹	Ref. No.	ELETINTBIPSIN
description	rocker switch mounting measurements 30x22mm black 2NO 250V 16A 0-I connection male faston 6.3mm ambient temperature max. 125/55°C protection IP65		

¹non-illuminated



1

Part No.	347343	Ref. No.	ELETPULINTKOR UNK32276239
description	rocker switch mounting measurements 30x22mm white/white 1NO/NO 250V 16A cup warmer/0 connection male faston 6.3mm ambient temperature max. 85°C protection IP40		
For models:	Lollo-1gruppo, Lollo-2gruppi, Lollo-3gruppi		

push/momentary push switches

28.5x28.5mm



1

Part No.	345142	Ref. No.	ELETPULCMDOMT
description	push switch mounting measurements 28.5x28.5mm red/green 2NO 250V 16A connection male faston 6.3mm ambient temperature max. 150°C protection IP40 with indicator		
For models:	Minimax-Kometa-Elettronica, Minimax-Kometa-Pulsante		



1

Part No.	346502	Ref. No.	ELETPULCMDOM
description	push switch mounting measurements 28.5x28.5mm red/green 2NO 250V 16A connection male faston 6.3mm ambient temperature max. 150°C protection IP40 with indicator		
For models:	Replica-pulsante-2gr, Replica-pulsante-3gr, Replica-pulsante-4gr		

ø25mm



1

Part No.	346496	Ref. No.	ELETINTNLST
description	push switch mounting ø 25mm red 2NO 250V 16A connection male faston 6.3mm ambient temperature max. 85°C protection IP40		



1

Part No.	345160 ¹	Ref. No.	ELETINTGLUSE
description	push switch mounting ø 25mm red 2NO 250V 16A illuminated connection male faston 6.3mm ambient temperature max. 85°C protection IP40		
For models:	Domobar-Interruttore-Luminoso		

¹illuminated



1

Part No.	346497	Ref. No.	ELETINTVLUSE
description	push switch mounting ø 25mm red 2NO 250V 16A illuminated steam connection male faston 6.3mm ambient temperature max. 85°C protection IP40		
For models:	Domobar-Interruttore-Luminoso		



1

Part No.	346504	Ref. No.	ELETINTALUSE
description	push switch mounting ø 25mm red 2NO 250V 16A illuminated water connection male faston 6.3mm ambient temperature max. 85°C protection IP40		
For models:	Domobar-Interruttore-Luminoso		

miscellaneous



1

Part No.	347349	Ref. No.	ELETPULBIPDOR
description	push switch black 2NO 250V 16A connection male faston 6.3mm ambient temperature max. 85°C protection IP40		
For models:	Domobar-Super-Elettronica, Domobar-Super-Manuale, Evolution-2gr-elettronica-e-puls, Evolution-3gr-elettronica-e-puls, Minimax-Replica-Elettronica, Replica-2gr-elettronica-multiboiler, Replica-3gr-elettronica-multiboiler, Replica-elettronica-2gr, Replica-elettronica-3gr, Replica-elettronica-4gr, Revolution-2gr-elettronica-epuls, Revolution-3gr-elettronica-epuls		

toggle switches

M12x0.75



1

Part No.	347462	Ref. No.	ELETINTLEVMET
description	toggle switch thread M12x0.75 2CO 250V 15A ON-ON		
For models:	Domobar-Interruttore-Levetta, Domobar-Junior-2B, Domobar-Junior-HX		



microswitches

lever actuated



1

Part No.	345044	Ref. No.	ELETMICP1
description	microswitch with lever 250V 16A 1CO connection male faston 6.3mm ambient temperature max. 85°C mounting distance 25mm type C99ZP3 actuating force: 25g lever length 71mm		
For models:	Domobar-Interruttore-Levetta, Domobar-Interruttore-Luminoso, Domobar-Super-2b-Pid-Elettronica, Domobar-Super-2b-Pid-Manuale, Domobar-Super-Elettronica, Domobar-Super-Manuale		

pin-plunger actuated

M10



1

Part No.	345156	Ref. No.	ELETMICRE
description	microswitch with plunger thread M10x1 thread L 13mm 250V 16A 1CO connection male faston 6.3mm stroke 6mm mounting distance 25mm L 46mm L1 13mm ambient temperature max. 85°C type C4AZN3 actuating force: 340g		
For models:	Cubo-2gr-Manuale, Cubo-3gr-Manuale, Cubo-4gr-Elettronico, Domobar-Interruttore-Levetta, Domobar-Interruttore-Luminoso, Domobar-Super-2b-Pid-Manuale, Domobar-Super-Elettronica, Domobar-Super-Manuale, Replica-2gr-manuale-multiboiler, Replica-3gr-manuale-multiboiler, Replica-manuale-2gr, Replica-manuale-3gr, Replica-manuale-4gr, Replica-pulsante-2gr		

non-standard

1

Part No.	347463	Ref. No.	ELETMICREKIRI
description	microswitch type NR6X5		
For models:	Domobar-Junior-2B, Domobar-Junior-HX		

system switches (ROLD)



1

Part No.	347182	Ref. No.	ELETPULSUPOVD UNK80981726
description	element holder mounting measurements 20.6x16.4mm chrome-plated arched for push buttons 13x17mm		
For models:	Domobar-Super-Elettronica, Domobar-Super-Manuale, Evolution-2gr-elettronica-e-puls, Evolution-3gr-elettronica-e-puls, Minimax-Replica-Elettronica, Replica-2gr-elettronica-multiboiler, Replica-3gr-elettronica-multiboiler, Replica-elettronica-2gr, Replica-elettronica-3gr, Replica-elettronica-4gr, Revolution-2gr-elettronica-epuls, Revolution-3gr-elettronica-epuls		



1

Part No.	347181	Ref. No.	ELETPULTASCRD UNK85036766	
description	push button size 13x17mmmm chrome-plated			
For models:	Domobar-Super-Elettronica, Domobar-Super-Manuale, Evolution-2gr-elettronica-e-puls, Evolution-3gr-elettronica-e-puls, Minimax-Replica-Elettronica, Replica-2gr-elettronica-multiboiler, Replica-3gr-elettronica-multiboiler, Replica-elettronica-2gr, Replica-elettronica-3gr, Replica-elettronica-4gr, Revolution-2gr-elettronica-epuls, Revolution-3gr-elettronica-epuls			
accessories for	347181			
	Part No.	347182	Ref. No.	ELETPULSUPOVD UNK80981726
	element holder mounting measurements 20.6x16.4mm chrome-plated arched for push buttons 13x17mm			

rotary switches

BREMAS

A1600 series



1

Part No.	345145	Ref. No.	ELETCOM
description	rotary switch 0-1-2 20A shaft L 23mm connection screw clamp 3 operating positions 6-pole shaft 5x5mm		
For models:	Domobar-Super-Elettronica, Domobar-Super-Manuale, Minimax-Kometa-Elettronica, Minimax-Kometa-Pulsante, Minimax-Replica-Elettronica		

miscellaneous

1

Part No.	347464	Ref. No.	ELETCOMDOMSUP
description	rotary switch		
For models:	Domobar-Super-2b-Pid-Elettronica, Domobar-Super-2b-Pid-Manuale		





			
1			
Part No.	347453	Ref. No.	ELETCOM4STADI
description	rotary switch 4 0-1-2-3		
For models:	Chimaera, Cubo-2gr-Elettronico, Cubo-2gr-Manuale, Cubo-3gr-Elettronico, Cubo-3gr-Manuale, Cubo-4gr-Elettronico, Cubo-4gr-Manuale, Evolution-2gr-elettronica-e-puls, Evolution-3gr-elettronica-e-puls, Replica-2gr-elettronica-multiboiler, Replica-2gr-manuale-multiboiler, Replica-3gr-elettronica-multiboiler, Replica-3gr-manuale-multiboiler, Replica-elettronica-2gr, Replica-elettronica-3gr, Replica-elettronica-4gr, Replica-manuale-2gr, Replica-manuale-3gr, Replica-manuale-4gr, Replica-pulsante-2gr, Replica-pulsante-3gr, Replica-pulsante-4gr, Revolution-2gr-elettronica-epuls, Revolution-3gr-elettronica-epuls		

accessories			
knobs			
			
1			
Part No.	525172	Ref. No.	MANCOMREPLICAMANCOMREPLICA
description	knob ø 39mm L 19mm W 13mm aperture 5x5mm polished		
For models:	Chimaera, Domobar-Super-2b-Pid-Elettronica, Domobar-Super-2b-Pid-Manuale, Domobar-Super-Elettronica, Domobar-Super-Manuale, Minimax-Kometa-Elettronica, Minimax-Kometa-Pulsante, Minimax-Replica-Elettronica, Replica-2gr-elettronica-multiboiler, Replica-2gr-manuale-multiboiler, Replica-3gr-elettronica-multiboiler, Replica-3gr-manuale-multiboiler, Replica-elettronica-2gr, Replica-elettronica-3gr, Replica-elettronica-4gr, Replica-manuale-2gr, Replica-manuale-3gr, Replica-manuale-4gr, Replica-pulsante-2gr, Replica-pulsante-3gr, Replica-pulsante-4gr		

lamps

indicator lights

indicator light lenses			
ø 6mm (type SQ-20)			
			
1			
Part No.	359806	Ref. No.	ELETGEMMATRAS
description	indicator light lens clear Qty 1 pcs ø 6mm		
For models:	Domobar-Super-Elettronica, Domobar-Super-Manuale		

indicator lamps for socket type SQ			
			
1			
Part No.	359748	Ref. No.	ELETLAMNEONRO
description	indicator lamp 110-250V red connection screw ø 8.5mm		
For models:	Domobar-Super-Elettronica, Domobar-Super-Manuale, Lollo-1gruppo, Lollo-2gruppi, Lollo-3gruppi		

			
1			
Part No.	359747	Ref. No.	ELETLAMNEONVE
description	indicator lamp 250V green connection grip connection ø 8.5mm		
For models:	Domobar-Super-Elettronica, Domobar-Super-Manuale		

indicator lights (complete)			
ø10mm			
with screw socket			
			
1			
Part No.	359380	Ref. No.	ELETLAMSP22CP
description	indicator light ø 10mm 230V red connection male faston 6.3mm socket screw base		

			
1			
Part No.	359476	Ref. No.	ELETLAMSP22GC
description	indicator light ø 10mm 110/250V red connection male faston 6.3mm		
For models:	Minimax-Kometa-Elettronica, Minimax-Kometa-Pulsante, Minimax-Replica-Elettronica		

with plug-in socket			
			
1			
Part No.	359138	Ref. No.	ELETLAMSP22CF
description	indicator light ø 10mm red 230V connection male faston 6.3mm Qty 1 pcs		

			
1			
Part No.	360489	Ref. No.	ELETLAMSP22EV
description	indicator light ø 10mm 110/250V red connection with cable cable length 1400mm temp.-resist. 120°C		
For models:	Cubo-2gr-Elettronico, Cubo-2gr-Manuale, Cubo-3gr-Elettronico, Cubo-3gr-Manuale, Cubo-4gr-Elettronico, Cubo-4gr-Manuale, Evolution-2gr-elettronica-e-puls, Evolution-3gr-elettronica-e-puls, Minimax-Kometa-Elettronica, Minimax-Kometa-Pulsante, Minimax-Replica-Elettronica, Replica-elettronica-2gr, Replica-elettronica-3gr, Replica-elettronica-4gr, Replica-manuale-2gr, Replica-manuale-3gr, Replica-manuale-4gr, Replica-pulsante-2gr, Replica-pulsante-3gr, Replica-pulsante-4gr, Revolution-2gr-elettronica-epuls, Revolution-3gr-elettronica-epuls		



LED

indicator lamps

miscellaneous



1

Part No.	360490	Ref. No.	ELETLEEDBIACU
description	LED		
For models:	Cubo-2gr-Elettronico, Cubo-2gr-Manuale, Cubo-3gr-Elettronico, Cubo-3gr-Manuale, Cubo-4gr-Elettronico, Cubo-4gr-Manuale		

contactors

LOVATO

power contactors



1

Part No.	380705	Ref. No.	TELERUTTOREKW
description	power contactor resistive load 20A 230VAC (AC3/400V) 9A/4kW main contacts 3NO auxiliary contacts 1NO connection screw connection type 11BG0910A230		
For models:	Lollo-1gruppo, Lollo-2gruppi, Lollo-3gruppi		
accessories for	380705		
	Part No.	380057	Ref. No. —
	auxiliary contact contacts 1NO/1NC AC1 10A for contactors BG series connection screw type BGX1011		

solid state relays

miscellaneous



1

Part No.	402566	Ref. No.	RELESTATICODS
description	solid state relay HFS 1 phase 25A 240V 4-32VDC L 58mm W 45mm with LED screw type D-24Z25-L		
For models:	Domobar-Super-2b-Pid-Elettronica		

relays

level relays

GICAR



1

Part No.	402557	Ref. No.	ELETREGLIV
description	level controller 230V 50/60Hz 5A connection plug type RL30/1E/2C/C		
For models:	Domobar-Super-Elettronica, Domobar-Super-Manuale, Minimax-Kometa-Pulsante, Replica-2gr-manuale-multiboiler, Replica-3gr-manuale-multiboiler, Replica-manuale-2gr, Replica-manuale-3gr, Replica-manuale-4gr, Replica-pulsante-2gr, Replica-pulsante-3gr, Replica-pulsante-4gr		

1

Part No.	402875	Ref. No.	ELETDOSPIDREG
description	level controller 230V voltage AC 50/60Hz		
For models:	Domobar-Super-2b-Pid-Manuale		

transformers

toroidal core transformers



1

Part No.	402565	Ref. No.	UNK20636123
description	transformer primary 2x115V secondary 24V 75VA secondary 0.5A 50/60Hz type T075.E.003		
For models:	Chimaera		



probes

producer-specific probes

probes			
			
1			
Part No.	379452	Ref. No.	ELETSONTEMPII UNK60538522
description	temperature probe NTC cable glass fibre probe -40 up to +125°C cable -50 up to +350°C connection plug thread 1/4" probe ø3.5x20mm cable length 0.24m		
For models:	Chimaera, Domobar-Super-2b-Pid-Elettronica, Domobar-Super-2b-Pid-Manuale, Replica-2gr-elettronica-multiboiler, Replica-2gr-manuale-multiboiler, Replica-3gr-elettronica-multiboiler, Replica-3gr-manuale-multiboiler		

electronics

PCBs

			
1			
Part No.	402857	Ref. No.	ELETDOSPIDREP
description	display		
For models:	Replica-2gr-elettronica-multiboiler, Replica-3gr-elettronica-multiboiler		

			
1			
Part No.	402858	Ref. No.	ELETPULDISPID
description	display		
For models:	Replica-2gr-manuale-multiboiler, Replica-3gr-manuale-multiboiler		

			
1			
Part No.	402860	Ref. No.	ELETPULDISREP
description	display		
For models:	Chimaera		

			
1			
Part No.	402873	Ref. No.	ELEETDOSPIDELE ELETDOSPIDELE
description	display		
For models:	Domobar-Super-2b-Pid-Elettronica		

			
1			
Part No.	402442	Ref. No.	ELETPULLIDDIGK UNK69209608
description	display level ø 40mm		
For models:	Lollo-2gruppi, Lollo-3gruppi		

central units

			
1			
Part No.	402859	Ref. No.	ELETDOSRECUMP
description	central unit		
For models:	Cubo-2gr-Manuale, Cubo-3gr-Manuale, Cubo-4gr-Elettronico, Evolution-2gr-elettronica-e-puls, Evolution-3gr-elettronica-e-puls, Revolution-2gr-elettronica-epuls, Revolution-3gr-elettronica-epuls		

			
1			
Part No.	403634	Ref. No.	ELETDOSKORINE
description	central unit 230V 50/60Hz L 127mm W 105mm for VIBIEMME		
For models:	Lollo-1gruppo, Lollo-2gruppi		



1

Part No.	402161	Ref. No.	ELETDOS3D2G
description	control box 3-group 230V		



1

Part No.	402101	Ref. No.	ELETDOS3D2GSI
description	control box 3-group for coffee machine 230V type 3d 3GRCT XLC		



1

Part No.	400776	Ref. No.	ELETDOS30
description	control box for coffee machine 230/240V 50/60Hz type 30 MICRO ST./C NO SIC		
For models:	Domobar-Super-2b-Pid-Elettronica		



1

Part No.	402590	Ref. No.	ELETDOS30DOM
description	control box for coffee machine 230/240V 50/60Hz type 30 MICRO ST./C NO SIC		
For models:	Domobar-Super-Elettronica, Domobar-Super-Manuale		

dosing electronics

miscellaneous



1

Part No.	402868	Ref. No.	ELETDOSKORINE
description	dosing electronics 1-2 group 230V		

1

Part No.	402852	Ref. No.	ELETDOS3GRCTT
description	dosing electronics 230V		

For models:	Cubo-2gr-Elettronico, Cubo-3gr-Elettronico, Cubo-4gr-Manuale, Evolution-2gr-elettronica-e-puls, Evolution-3gr-elettronica-e-puls, Minimax-Kometa-Elettronica, Minimax-Replica-Elettronica, Replica-elettronica-2gr, Replica-elettronica-3gr, Replica-elettronica-4gr, Revolution-2gr-elettronica-epuls, Revolution-3gr-elettronica-epuls
--------------------	--

1

Part No.	402855	Ref. No.	ELETDOSKIMREP
description	dosing electronics 230V		

For models:	Chimaera, Replica-2gr-elettronica-multiboiler, Replica-3gr-elettronica-multiboiler
--------------------	--

1

Part No.	402856	Ref. No.	ELETDOSPID23G
description	dosing electronics 230V		

For models:	Replica-2gr-manuale-multiboiler, Replica-3gr-manuale-multiboiler
--------------------	--

1

Part No.	402869	Ref. No.	ELETDOS3GKONE
description	dosing electronics 3-group 230V		

For models:	Lollo-3gruppi
--------------------	---------------



keypads

keypad units

1			
Part No.	402861	Ref. No.	ELETPUL1LEDNE
description	keypad unit		
For models:	Evolution-2gr-elettronica-e-puls, Evolution-3gr-elettronica-e-puls, Revolution-2gr-elettronica-epuls, Revolution-3gr-elettronica-epuls		

1			
Part No.	402872	Ref. No.	ELETPULACKORN
description	keypad unit buttons 1		
For models:	Lollo-2gruppi, Lollo-3gruppi		

1			
Part No.	402871	Ref. No.	ELETPUL1LED2T
description	keypad unit buttons 2		
For models:	Lollo-1gruppo, Lollo-2gruppi, Lollo-3gruppi		

1			
Part No.	402870	Ref. No.	ELETPUL5LED5T
description	keypad unit buttons 5		
For models:	Lollo-1gruppo, Lollo-2gruppi, Lollo-3gruppi		

1			
Part No.	401455	Ref. No.	ELETPUL1LEDAL
description	keypad unit buttons 5 L 116mm W 43mm with buttons aluminium		
For models:	Domobar-Super-2b-Pid-Elettronica, Domobar-Super-Elettronica, Domobar-Super-Manuale, Minimax-Kometa-Elettronica		

1			
Part No.	401457	Ref. No.	ELETPUL1LEDKO
description	keypad unit buttons 5 L 87mm W 59mm		

1			
Part No.	402853	Ref. No.	ELETPUL6T1LDT
description	keypad unit buttons 6		
For models:	Cubo-2gr-Elettronico, Cubo-3gr-Elettronico, Cubo-4gr-Manuale, Minimax-Replica-Elettronica, Replica-elettronica-2gr, Replica-elettronica-3gr, Replica-elettronica-4gr		

1			
Part No.	402854	Ref. No.	ELETPUL6T1LTD
description	keypad unit buttons 6 with LED		
For models:	Replica-2gr-elettronica-multiboiler, Replica-3gr-elettronica-multiboiler		

solenoïd valves

solenoïd valves (water)

metal

ASCO

spare parts and accessories

O-rings

1			
Part No.	371095	Ref. No.	GUARSASTRUEV
description	O-ring Viton thickness 1.78mm ID ø 6.07mm Qty 1 pcs		
For models:	Evolution-2gr-elettronica-e-puls, Evolution-3gr-elettronica-e-puls, Minimax-Kometa-Elettronica, Minimax-Kometa-Pulsante, Revolution-2gr-elettronica-epuls, Revolution-3gr-elettronica-epuls		



PARKER

2-way

E-146 series



1

Part No.	370521	Ref. No.	ELETELE2VAU22
description	solenoid valve 2-ways 230VAC connection 1/8" DN 1.5mm t.max. 370206°C slide-on receptacle DIN -20° up to 130°C type series VE-146 coil type ZB09 membranes FKM (water) p max 40bar brass		
For models:	Cubo-2gr-Elettronico, Cubo-2gr-Manuale, Cubo-3gr-Elettronico, Cubo-3gr-Manuale, Cubo-4gr-Elettronico, Cubo-4gr-Manuale, Domobar-Super-Elettronica, Domobar-Super-Manuale, Minimax-Kometa-Elettronica, Minimax-Kometa-Pulsante, Minimax-Replica-Elettronica, Replica-2gr-elettronica-multiboiler, Replica-2gr-manuale-multiboiler, Replica-3gr-elettronica-multiboiler, Replica-3gr-manuale-multiboiler, Replica-elettronica-2gr, Replica-elettronica-3gr, Replica-elettronica-4gr, Replica-manuale-2gr, Replica-manuale-3gr, Replica-manuale-4gr, Replica-pulsante-2gr, Replica-pulsante-3gr, Replica-pulsante-4gr		
spare parts for	370521		
	Part No.	371029	Ref. No. —
	solenoid coil PARKER 230VAC 9VA coil type ZB09 seat ø 14mm H 33mm W 34mm D 43mm		



1





Part No.	370303	Ref. No.	ELETELE2AU22
description	solenoid valve 2-ways 230VAC connection 1/8" DN 3mm slide-on receptacle DIN -20° up to 130°C PARKER type series VE-146 coil type ZB09 membranes FKM (water) p max 10bar		
For models:	Domobar-Junior-2B, Domobar-Junior-HX, Domobar-Super-2b-Pid-Elettronica, Domobar-Super-2b-Pid-Manuale, Domobar-Super-Elettronica, Domobar-Super-Manuale		

3-way

VE-128 series



1

Part No.	370060	Ref. No.	ELETELE3VCAB
description	solenoid valve 3-ways 230VAC body outer cone DN 1.2mm slide-on receptacle DIN -20° up to 140°C PARKER type series VE-128 coil type YB09 with cable membranes Viton p max 10bar brass flange 32x32mm		
For models:	Chimaera, Cubo-2gr-Elettronico, Cubo-3gr-Elettronico, Cubo-4gr-Elettronico, Domobar-Super-2b-Pid-Elettronica, Domobar-Super-Elettronica, Evolution-2gr-elettronica-e-puls, Evolution-3gr-elettronica-e-puls, Lollo-1gruppo, Lollo-2gruppi, Lollo-3gruppi, Minimax-Kometa-Elettronica, Minimax-Kometa-Pulsante, Minimax-Replica-Elettronica, Replica-2gr-elettronica-multiboiler, Replica-3gr-elettronica-multiboiler, Replica-elettronica-2gr, Replica-elettronica-3gr, Replica-elettronica-4gr, Replica-pulsante-2gr, Replica-pulsante-3gr, Replica-pulsante-4gr, Revolution-2gr-elettronica-epuls, Revolution-3gr-elettronica-epuls		
spare parts for	370060		
	Part No.	370062	Ref. No. —
	solenoid valve body PARKER 3-ways outer cone		
	Part No.	371033	Ref. No. —
	solenoid coil PARKER 230VAC 9VA coil type YB09 with cable seat ø 14mm		
accessories for	370060		
	Part No.	101527	Ref. No. —
	O-ring Viton thickness 1.78mm ID ø 6.75mm Qty 1 pcs		
	Part No.	532193	Ref. No. —
	O-ring silicone thickness 1.78mm ID ø 6.75mm Qty 10 pcs		

Solenoid valve - accessories



1

Part No.	371095	Ref. No.	GUARSASTRUEV
description	O-ring Viton thickness 1.78mm ID ø 6.07mm Qty 1 pcs		
For models:	Evolution-2gr-elettronica-e-puls, Evolution-3gr-elettronica-e-puls, Minimax-Kometa-Elettronica, Minimax-Kometa-Pulsante, Revolution-2gr-elettronica-epuls, Revolution-3gr-elettronica-epuls		



pressure switches

for coffee machines

ø 38mm



1

Part No.	541783	Ref. No.	ELETPREDSUKIR XP110
description	pressure control pressure range 0.5-1.5bar connection 1/4" 21A 250V ø 38mm preset at 1.1bar		

miscellaneous





1

Part No.	541724	Ref. No.	ELETPREDOMSU
description	pressure control pressure range adjustable 0.5-1.4bar connection 1/4" 20A 3-pole type P303 coffee machine parts SIRAI		
For models:	Domobar-Junior-2B, Domobar-Junior-HX, Domobar-Super-2b-Pid-Elettronica, Domobar-Super-2b-Pid-Manuale, Domobar-Super-Elettronica, Domobar-Super-Manuale		



1

Part No.	541021	Ref. No.	ELETPRE
description	pressure control pressure range adjustable 0.5-1.4bar connection 1/4" 30A 3-pole type P302 coffee machine parts SIRAI		
For models:	Chimaera, Cubo-2gr-Elettronico, Cubo-2gr-Manuale, Cubo-3gr-Elettronico, Cubo-3gr-Manuale, Cubo-4gr-Elettronico, Cubo-4gr-Manuale, Domobar-Super-2b-Pid-Elettronica, Domobar-Super-2b-Pid-Manuale, Domobar-Super-Elettronica, Domobar-Super-Manuale, Evolution-2gr-elettronica-e-puls, Evolution-3gr-elettronica-e-puls, Lollo-1gruppo, Lollo-2gruppi, Lollo-3gruppi, Minimax-Kometa-Elettronica, Minimax-Kometa-Pulsante, Minimax-Replica-Elettronica, Replica-2gr-elettronica-multiboiler, Replica-2gr-manuale-multiboiler, Replica-3gr-elettronica-multiboiler, Replica-3gr-manuale-multiboiler, Replica-elettronica-2gr, Replica-elettronica-3gr, Replica-elettronica-4gr, Replica-manuale-2gr, Replica-manuale-3gr, Replica-manuale-4gr, Replica-pulsante-2gr, Replica-pulsante-3gr, Replica-pulsante-4gr, Revolution-2gr-elettronica-epuls, Revolution-3gr-elettronica-epuls		
accessories for	541021		
	Part No.	550262	Ref. No. —
	flat gasket copper ED ø 20mm ID ø 14mm thickness 2mm		
	Part No.	890100	Ref. No. —
	PTFE tape reel L 12m W 12mm -200 up to +260°C approval DINDVGW, KTW temperature-resistant, elastic for fine thread thickness 0.1mm		

flow meters and flow sensors

flow meters

GICAR



1

Part No.	400775	Ref. No.	ELETCONTVOLOT
description	flow meter thread 1/4" brass with LED nominal-ø 1.15mm plug-in connection		
For models:	Chimaera, Cubo-2gr-Elettronico, Cubo-3gr-Elettronico, Domobar-Super-2b-Pid-Elettronica, Domobar-Super-2b-Pid-Manuale, Domobar-Super-Elettronica, Domobar-Super-Manuale, Evolution-2gr-elettronica-e-puls, Evolution-3gr-elettronica-e-puls, Minimax-Kometa-Elettronica, Minimax-Replica-Elettronica, Replica-2gr-elettronica-multiboiler, Replica-2gr-manuale-multiboiler, Replica-3gr-elettronica-multiboiler, Replica-3gr-manuale-multiboiler, Replica-elettronica-2gr, Replica-elettronica-3gr, Revolution-2gr-elettronica-epuls, Revolution-3gr-elettronica-epuls		



1

Part No.	541750	Ref. No.	ELETCONTVODOS
description	flow meter hose ø 7mm plastic approval NSF		
For models:	Domobar-Super-Elettronica, Domobar-Super-Manuale		



pumps

booster pumps II

pump motors

clip connection



1

Part No.	500458	Ref. No.	ELETMOT22V
description	pump motor RPM type 11002778 165W 230V 50Hz connection clip L 165mm W 130mm H 140mm capacitor 10µF		
spare parts for	500458		
	Part No.	365015	Ref. No. ELETCOND
	operating capacitor capacity 10µF 400V tolerance 5%Hz ambient temperature max. -25 to +85°C ø 35.5mm L 59mm M8 plastic connection male faston 6.3mm protection		



1

Part No.	500452	Ref. No.	ELETMOTRPM304
description	pump motor RPM type C004311 100W 230V 50/60Hz connection clip L 160mm W 95mm H 140mm capacitor 5µF		
For models:	Chimaera, Cubo-2gr-Elettronico, Cubo-2gr-Manuale, Cubo-3gr-Elettronico, Cubo-3gr-Manuale, Cubo-4gr-Elettronico, Cubo-4gr-Manuale, Domobar-Super-2b-Pid-Elettronica, Domobar-Super-2b-Pid-Manuale, Domobar-Super-Elettronica, Domobar-Super-Manuale, Evolution-2gr-elettronica-e-puls, Evolution-3gr-elettronica-e-puls, Lollo-1gruppo, Lollo-2gruppi, Lollo-3gruppi, Minimax-Kometa-Elettronica, Minimax-Kometa-Pulsante, Minimax-Replica-Elettronica, Replica-2gr-elettronica-multiboiler, Replica-2gr-manuale-multiboiler, Replica-3gr-elettronica-multiboiler, Replica-3gr-manuale-multiboiler, Replica-elettronica-2gr, Replica-elettronica-3gr, Replica-elettronica-4gr, Replica-manuale-2gr, Replica-manuale-3gr, Replica-manuale-4gr, Replica-pulsante-2gr, Replica-pulsante-3gr, Replica-pulsante-4gr, Revolution-2gr-elettronica-epuls, Revoluti on-3gr-elettronica-epuls		
spare parts for	500452		
	Part No.	365066	Ref. No. ELETCONDRPM
	operating capacitor capacity 7µF 450V tolerance 5% 50/60Hz ambient temperature max. -25 to +85°C ø 31mm L 55mm M8 plastic connection male faston 2.8mm protection		

pump heads

FLUID-O-TECH



1

Part No.	499088	Ref. No.	POMPPRONOSETN
description	pump head PA074 FLUID-O-TECH L 82mm 70l/h connection 3/8" GAS with bypass brass clip connection shaft ø 10.8x4.8mm approval NSF		



1

Part No.	499056	Ref. No.	POMPPRONO UNK21572132
description	pump head PA1504 FLUID-O-TECH L 82mm 150l/h connection 3/8" GAS with bypass brass clip connection for coffee machine shaft ø 10.8x4.8mm approval NSF		
For models:	Chimaera, Cubo-2gr-Elettronico, Cubo-2gr-Manuale, Cubo-3gr-Elettronico, Cubo-3gr-Manuale, Cubo-4gr-Elettronico, Cubo-4gr-Manuale, Evolution-2gr-elettronica-e-puls, Evolution-3gr-elettronica-e-puls, Lollo-1gruppo, Lollo-2gruppi, Lollo-3gruppi, Minimax-Kometa-Elettronica, Minimax-Kometa-Pulsante, Minimax-Replica-Elettronica, Replica-2gr-elettronica-multiboiler, Replica-2gr-manuale-multiboiler, Replica-3gr-elettronica-multiboiler, Replica-3gr-manuale-multiboiler, Replica-elettronica-2gr, Replica-elettronica-3gr, Replica-elettronica-4gr, Replica-manuale-2gr, Replica-manuale-3gr, Replica-manuale-4gr, Replica-pulsante-2gr, Replica-pulsante-3gr, Replica-pulsante-4gr, Revolution-2gr-elettronica-epuls, Revoluti on-3gr-elettronica-epuls		



1

Part No.	500454	Ref. No.	POMPROCFL
description	pump head PA1504 FLUID-O-TECH L 82mm 150l/h connection 3/8" NPT with bypass brass clip connection for coffee machine shaft ø 4.8x11mm approval NSF		





PROCON			
			
1			
Part No.	500453	Ref. No.	POMPPRONOSETN
description	pump head T6495 PROCON L 82mm 100l/h connection 3/8" NPT with bypass brass clip connection for coffee machine shaft ø 4.8x11mm		
For models:	Chimaera, Cubo-2gr-Elettronico, Cubo-2gr-Manuale, Cubo-3gr-Elettronico, Cubo-3gr-Manuale, Cubo-4gr-Elettronico, Cubo-4gr-Manuale, Domobar-Super-2b-Pid-Elettronica, Domobar-Super-2b-Pid-Manuale, Domobar-Super-Elettronica, Domobar-Super-Manuale, Evolution-2gr-elettronica-e-puls, Evolution-3gr-elettronica-e-puls, Lollo-1gruppo, Lollo-2gruppi, Lollo-3gruppi, Minimax-Kometa-Elettronica, Minimax-Kometa-Pulsante, Minimax-Replica-Elettronica, Replica-2gr-elettronica-multiboiler, Replica-2gr-manuale-multiboiler, Replica-3gr-elettronica-multiboiler, Replica-3gr-manuale-multiboiler, Replica-elettronica-2gr, Replica-elettronica-3gr, Replica-elettronica-4gr, Replica-manuale-2gr, Replica-manuale-3gr, Replica-manuale-4gr, Replica-pulsante-2gr, Replica-pulsante-3gr, Replica-pulsante-4gr, Revolution-2gr-elettronica-epuls, Revoluti on-3gr-elettronica-epuls		

accessories			
			
1			
Part No.	500456	Ref. No.	TUBIP415
description	by-pass for PROCON pump		

			
1			
Part No.	365015	Ref. No.	ELETCOND
description	operating capacitor capacity 10µF 400V tolerance 5%Hz ambient temperature max. -25 to +85°C ø 35.5mm L 59mm M8 plastic connection male faston 6.3mm protection		

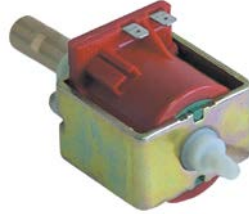
vibration pumps			
			
1			
Part No.	390698	Ref. No.	TERMPROTDOMSU
description	thermal fuse switch-off temp. 110°C suitable for ULKA pump		
For models:	Domobar-Interruttore-Levetta, Domobar-Interruttore-Luminoso, Domobar-Junior-2B, Domobar-Junior-HX, Domobar-Super-2b-Pid-Elettronica, Domobar-Super-2b-Pid-Manuale, Domobar-Super-Elettronica, Domobar-Super-Manuale		

				
1				
Part No.	500124	Ref. No.	POMPVIDDOM UNK46491381	
description	vibration pump type EX 5 230V 48W 50/60Hz inlet ø 6 outlet ø 1/8" IT flat seal ULKA brass L 123mm			
For models:	Domobar-Interruttore-Levetta, Domobar-Interruttore-Luminoso, Domobar-Junior-2B, Domobar-Junior-HX, Domobar-Super-2b-Pid-Elettronica, Domobar-Super-2b-Pid-Manuale, Domobar-Super-Elettronica, Domobar-Super-Manuale			
accessories for	500124			
	Part No.	520152	Ref. No.	—
	hose connector Santoprene grommet ø 7mm grommet length 14mm			
	Part No.	520330	Ref. No.	—
	bracket rubber dimensions 69x44x4mm			

condensators & interference suppression filters

operating capacitors

plastic			
			
1			
Part No.	365015	Ref. No.	ELETCOND
description	operating capacitor capacity 10µF 400V tolerance 5%Hz ambient temperature max. -25 to +85°C ø 35.5mm L 59mm M8 plastic connection male faston 6.3mm protection		

			
1			
Part No.	365066	Ref. No.	ELETCOND RPM
description	operating capacitor capacity 7µF 450V tolerance 5% 50/60Hz ambient temperature max. -25 to +85°C ø 31mm L 55mm M8 plastic connection male faston 2.8mm protection		
For models:	Chimaera, Cubo-2gr-Elettronico, Cubo-2gr-Manuale, Cubo-3gr-Elettronico, Cubo-3gr-Manuale, Cubo-4gr-Elettronico, Cubo-4gr-Manuale, Domobar-Super-2b-Pid-Elettronica, Domobar-Super-2b-Pid-Manuale, Domobar-Super-Elettronica, Domobar-Super-Manuale, Evolution-2gr-elettronica-e-puls, Evolution-3gr-elettronica-e-puls, Lollo-1gruppo, Lollo-2gruppi, Lollo-3gruppi, Minimax-Kometa-Elettronica, Minimax-Kometa-Pulsante, Minimax-Replica-Elettronica, Replica-2gr-elettronica-multiboiler, Replica-2gr-manuale-multiboiler, Replica-3gr-elettronica-multiboiler, Replica-3gr-manuale-multiboiler, Replica-elettronica-2gr, Replica-elettronica-3gr, Replica-elettronica-4gr, Replica-manuale-2gr, Replica-manuale-3gr, Replica-manuale-4gr, Replica-pulsante-2gr, Replica-pulsante-3gr, Replica-pulsante-4gr, Revolution-2gr-elettronica-epuls, Revoluti on-3gr-elettronica-epuls		



equipment-specific units

for espresso machines

filter holders

filter holders standard

filter holders short



Part No.	529232	Ref. No.	PORTTN
description	filter holder mounting ø 82.5mm outlet 3/8" ID ø 62mm handle M10x1.5 wedge high 9.2mm wedge position horizontal number of wedges 2 lever straight chrome-plated brass		
For models:	Chimaera, Cubo-2gr-Elettronico, Cubo-2gr-Manuale, Cubo-3gr-Elettronico, Cubo-3gr-Manuale, Cubo-4gr-Elettronico, Cubo-4gr-Manuale, Domobar-Interruttore-Levetta, Domobar-Interruttore-Luminoso, Domobar-Junior-2B, Domobar-Junior-HX, Domobar-Super-2b-Pid-Elettronica, Domobar-Super-2b-Pid-Manuale, Domobar-Super-Elettronica, Domobar-Super-Manuale, Evolution-2gr-elettronica-e-puls, Evolution-3gr-elettronica-e-puls, Lollo-1gruppo, Lollo-2gruppi, Lollo-3gruppi, Minimax-Kometa-Elettronica, Minimax-Kometa-Pulsante, Minimax-Replica-Elettronica, Replica-2gr-elettronica-multiboiler, Replica-2gr-manuale-multiboiler, Replica-3gr-elettronica-multiboiler, Replica-3gr-manuale-multiboiler, Replica-elettronica-2gr, Replica-elettronica-3gr, Replica-elettronica-4gr, Replica-manuale-2gr, Replica-manuale-3gr, Replica-manuale-4gr, Replica-pulsante-2gr, Replica-pulsante-3gr, Replica-pulsante-4gr, Revolution-2gr-elettronica-epuls, Revolution-3gr-elettronica-epuls		
accessories for	529232		
	Part No.	529233	Ref. No. PORTIMPPF
	handle ø 30mm thread M10x1.5 L1 115mm black		

handles

with external thread



Part No.	529233	Ref. No.	PORTIMPPF
description	handle ø 30mm thread M10x1.5 L1 115mm black		



Part No.	525203	Ref. No.	PORTIMPPFNEW
description	handle ø 35mm thread M10x1.5 thread L 14mm L 126mm black		
For models:	Chimaera, Cubo-2gr-Elettronico, Cubo-2gr-Manuale, Cubo-3gr-Elettronico, Cubo-3gr-Manuale, Cubo-4gr-Elettronico, Cubo-4gr-Manuale, Domobar-Interruttore-Levetta, Domobar-Interruttore-Luminoso, Domobar-Junior-2B, Domobar-Junior-HX, Domobar-Super-2b-Pid-Elettronica, Domobar-Super-2b-Pid-Manuale, Domobar-Super-Elettronica, Domobar-Super-Manuale, Evolution-2gr-elettronica-e-puls, Evolution-3gr-elettronica-e-puls, Lollo-1gruppo, Lollo-2gruppi, Lollo-3gruppi, Minimax-Kometa-Elettronica, Minimax-Kometa-Pulsante, Minimax-Replica-Elettronica, Replica-2gr-elettronica-multiboiler, Replica-2gr-manuale-multiboiler, Replica-3gr-elettronica-multiboiler, Replica-3gr-manuale-multiboiler, Replica-elettronica-2gr, Replica-elettronica-3gr, Replica-elettronica-4gr, Replica-manuale-2gr, Replica-manuale-3gr, Replica-manuale-4gr, Replica-pulsante-2gr, Replica-pulsante-3gr, Replica-pulsante-4gr, Revolution-2gr-elettronica-epuls, Revolution-3gr-elettronica-epuls		

spouts

with thread 3/8"



Part No.	529005	Ref. No.	FILTBEC1TDOM
description	filter holder spout thread 3/8" 1-way curved/short outlet distancemm		



Part No.	529008	Ref. No.	FILTBEC2TDOM
description	filter holder spout thread 3/8" 2-way curved outlet distance 33mm		

filters

for 1 cup



Part No.	529011	Ref. No.	FILT1TA
description	coffee filter ø 70mm mounting ø 60mm H 24.5mm cups 1 amount of coffee 7g perforation ø 0.4mm		
For models:	Chimaera, Cubo-2gr-Elettronico, Cubo-2gr-Manuale, Cubo-3gr-Elettronico, Cubo-3gr-Manuale, Cubo-4gr-Elettronico, Cubo-4gr-Manuale, Domobar-Interruttore-Levetta, Domobar-Interruttore-Luminoso, Domobar-Junior-2B, Domobar-Junior-HX, Domobar-Super-2b-Pid-Elettronica, Domobar-Super-2b-Pid-Manuale, Domobar-Super-Elettronica, Domobar-Super-Manuale, Evolution-2gr-elettronica-e-puls, Evolution-3gr-elettronica-e-puls, Lollo-1gruppo, Lollo-2gruppi, Lollo-3gruppi, Minimax-Kometa-Elettronica, Minimax-Kometa-Pulsante, Minimax-Replica-Elettronica, Replica-2gr-elettronica-multiboiler, Replica-2gr-manuale-multiboiler, Replica-3gr-elettronica-multiboiler, Replica-3gr-manuale-multiboiler, Replica-elettronica-2gr, Replica-elettronica-3gr, Replica-elettronica-4gr, Replica-manuale-2gr, Replica-manuale-3gr, Replica-manuale-4gr, Replica-pulsante-2gr, Replica-pulsante-3gr, Replica-pulsante-4gr, Revolution-2gr-elettronica-epuls, Revolution-3gr-elettronica-epuls		





for 2 cups			
			
1			
Part No.	529013	Ref. No.	FILT2TA
description	coffee filter ø 70mm mounting ø 60.5mm H 25.5mm cups 2 amount of coffee 14g perforation ø 0.3x0.3mm square		
For models:	Chimaera, Cubo-2gr-Elettronico, Cubo-2gr-Manuale, Cubo-3gr-Elettronico, Cubo-3gr-Manuale, Cubo-4gr-Elettronico, Cubo-4gr-Manuale, Domobar-Interruttore-Levetta, Domobar-Interruttore-Luminoso, Domobar-Junior-2B, Domobar-Junior-HX, Domobar-Super-2b-Pid-Elettronica, Domobar-Super-2b-Pid-Manuale, Domobar-Super-Elettronica, Domobar-Super-Manuale, Evolution-2gr-elettronica-e-puls, Evolution-3gr-elettronica-e-puls, Lollo-1gruppo, Lollo-2gruppi, Lollo-3gruppi, Minimax-Kometa-Elettronica, Minimax-Kometa-Pulsante, Minimax-Replica-Elettronica, Replica-2gr-elettronica-multiboiler, Replica-2gr-manuale-multiboiler, Replica-3gr-elettronica-multiboiler, Replica-3gr-manuale-multiboiler, Replica-elettronica-2gr, Replica-elettronica-3gr, Replica-elettronica-4gr, Replica-manuale-2gr, Replica-manuale-3gr, Replica-manuale-4gr, Replica-pulsante-2gr, Replica-pulsante-3gr, Replica-pulsante-4gr, Revolution-2gr-elettronica-epuls, Revolution-3gr-elettronica-epuls		

filter holder springs			
			
1			
Part No.	531243	Ref. No.	N/A
description	filter holder spring L 70mm W 60mm wire gauge ø 1.3mm for espresso filter holder Qty 20 pcs		

brewing units			
shower screens			
with upstand			
			
1			
Part No.	528417	Ref. No.	FILTDCREGR
description	shower screen ø 58mm H 19mm		
For models:	Chimaera, Cubo-2gr-Elettronico, Cubo-2gr-Manuale, Cubo-3gr-Elettronico, Cubo-3gr-Manuale, Cubo-4gr-Elettronico, Cubo-4gr-Manuale, Domobar-Interruttore-Levetta, Domobar-Interruttore-Luminoso, Domobar-Junior-2B, Domobar-Junior-HX, Domobar-Super-2b-Pid-Elettronica, Domobar-Super-2b-Pid-Manuale, Domobar-Super-Elettronica, Domobar-Super-Manuale, Evolution-2gr-elettronica-e-puls, Evolution-3gr-elettronica-e-puls, Lollo-1gruppo, Lollo-2gruppi, Lollo-3gruppi, Minimax-Kometa-Elettronica, Minimax-Kometa-Pulsante, Minimax-Replica-Elettronica, Replica-2gr-elettronica-multiboiler, Replica-2gr-manuale-multiboiler, Replica-3gr-elettronica-multiboiler, Replica-3gr-manuale-multiboiler, Replica-elettronica-2gr, Replica-elettronica-3gr, Replica-elettronica-4gr, Replica-manuale-2gr, Replica-manuale-3gr, Replica-manuale-4gr, Replica-pulsante-2gr, Replica-pulsante-3gr, Replica-pulsante-4gr, Revolution-2gr-elettronica-epuls, Revolution-3gr-elettronica-epuls		

filter holder gaskets			
flat			
standard			
			
1			
Part No.	526254	Ref. No.	GUARSOT
description	filter holder gasket D1 ø 73.6mm D2 ø 58mm H 8mm Qty 1 pcs		
For models:	Chimaera, Cubo-2gr-Elettronico, Cubo-2gr-Manuale, Cubo-3gr-Elettronico, Cubo-3gr-Manuale, Cubo-4gr-Elettronico, Cubo-4gr-Manuale, Domobar-Interruttore-Levetta, Domobar-Interruttore-Luminoso, Domobar-Junior-2B, Domobar-Junior-HX, Domobar-Super-2b-Pid-Elettronica, Domobar-Super-2b-Pid-Manuale, Domobar-Super-Elettronica, Domobar-Super-Manuale, Evolution-2gr-elettronica-e-puls, Evolution-3gr-elettronica-e-puls, Lollo-1gruppo, Lollo-2gruppi, Lollo-3gruppi, Minimax-Kometa-Elettronica, Minimax-Kometa-Pulsante, Minimax-Replica-Elettronica, Replica-2gr-elettronica-multiboiler, Replica-2gr-manuale-multiboiler, Replica-3gr-elettronica-multiboiler, Replica-3gr-manuale-multiboiler, Replica-elettronica-2gr, Replica-elettronica-3gr, Replica-elettronica-4gr, Replica-manuale-2gr, Replica-manuale-3gr, Replica-manuale-4gr, Replica-pulsante-2gr, Replica-pulsante-3gr, Replica-pulsante-4gr, Revolution-2gr-elettronica-epuls, Revolution-3gr-elettronica-epuls		

brewing units with solenoid valve			
components			
			
1			
Part No.	525170	Ref. No.	ASSTASCAUT
description	drain pipe 1/8" L 42mm WS 22		
For models:	Chimaera, Cubo-2gr-Elettronico, Cubo-3gr-Elettronico, Cubo-4gr-Elettronico, Domobar-Super-2b-Pid-Elettronica, Domobar-Super-Elettronica, Minimax-Replica-Elettronica, Replica-2gr-elettronica-multiboiler, Replica-3gr-elettronica-multiboiler, Replica-elettronica-2gr, Replica-elettronica-3gr, Replica-elettronica-4gr, Replica-pulsante-2gr, Replica-pulsante-3gr, Replica-pulsante-4gr, Revolution-2gr-elettronica-epuls, Revolution-3gr-elettronica-epuls		

			
1			
Part No.	528959	Ref. No.	RACCTASC28AUT
description	screw T1: 1/4" L 28mm		



brewing units manual

components

bushes



Part No.	525177	Ref. No.	RACCBUPRGO
description	bush D1 ø 15mm D2 ø 10mm ID ø 8mm H 28mm brass		
For models:	Cubo-2gr-Manuale, Cubo-3gr-Manuale, Cubo-4gr-Manuale, Domobar-Interruttore-Levetta, Domobar-Interruttore-Luminoso, Domobar-Junior-2B, Domobar-Junior-HX, Domobar-Super-2b-Pid-Manuale, Domobar-Super-Manuale, Replica-2gr-manuale-multiboiler, Replica-3gr-manuale-multiboiler, Replica-manuale-2gr, Replica-manuale-3gr, Replica-manuale-4gr		

gaskets



Part No.	529795	Ref. No.	GUARPI
description	gasket D1 ø 13mm D2 ø 4mm thickness 4mm coffee machine		
For models:	Chimaera, Cubo-2gr-Elettronico, Cubo-2gr-Manuale, Cubo-3gr-Elettronico, Cubo-3gr-Manuale, Cubo-4gr-Elettronico, Cubo-4gr-Manuale, Minimax-Replica-Elettronica, Replica-2gr-elettronica-multiboiler, Replica-2gr-manuale-multiboiler, Replica-3gr-elettronica-multiboiler, Replica-3gr-manuale-multiboiler, Replica-elettronica-2gr, Replica-elettronica-3gr, Replica-elettronica-4gr, Replica-manuale-2gr, Replica-manuale-3gr, Replica-manuale-4gr		

springs



Part No.	527934	Ref. No.	MOLLVAER
description	compression spring ø 14.2mm L 45mm wire gauge ø 1.5mm SS		
For models:	Cubo-2gr-Manuale, Cubo-3gr-Manuale, Cubo-4gr-Manuale, Domobar-Interruttore-Levetta, Domobar-Interruttore-Luminoso, Domobar-Junior-2B, Domobar-Junior-HX, Domobar-Super-2b-Pid-Manuale, Domobar-Super-Manuale, Replica-2gr-manuale-multiboiler, Replica-3gr-manuale-multiboiler, Replica-manuale-2gr, Replica-manuale-3gr, Replica-manuale-4gr		



camshafts



Part No.	525171	Ref. No.	RACCALCAGR
description	camshaft shaft ø 8mm shaft intake ø 6.2mm L 86.5mm W 20mm H 17mm thread M6 chrome-plated brass		
For models:	Cubo-2gr-Manuale, Cubo-3gr-Manuale, Cubo-4gr-Manuale, Domobar-Interruttore-Levetta, Domobar-Interruttore-Luminoso, Domobar-Junior-2B, Domobar-Junior-HX, Domobar-Super-2b-Pid-Manuale, Domobar-Super-Manuale, Replica-2gr-manuale-multiboiler, Replica-3gr-manuale-multiboiler, Replica-manuale-2gr, Replica-manuale-3gr, Replica-manuale-4gr		

valves



Part No.	526008	Ref. No.	ASSVALVEROG
description	valve group outflow L 54.3mm ED ø 16mm shaft ø 4.5mm brass		
For models:	Cubo-2gr-Manuale, Cubo-3gr-Manuale, Cubo-4gr-Manuale, Domobar-Interruttore-Levetta, Domobar-Interruttore-Luminoso, Domobar-Junior-2B, Domobar-Junior-HX, Domobar-Super-2b-Pid-Manuale, Domobar-Super-Manuale, Replica-2gr-manuale-multiboiler, Replica-3gr-manuale-multiboiler, Replica-manuale-2gr, Replica-manuale-3gr, Replica-manuale-4gr		
accessories for	526008		
	Part No.	526003	Ref. No. —
	compression spring ø 13.8mm L 54.5mm wire gauge ø 1.5mm windings 10 drain valve		
	Part No.	532550	Ref. No. —
	O-ring NBR 787/70 thickness 2.62mm ID ø 9.13mm Qty 10 pcs		



Part No.	525180	Ref. No.	ASSVALVSCAR
description	valve L 27mm ED ø 16mm shaft triangular brass		
For models:	Cubo-2gr-Elettronico, Cubo-2gr-Manuale, Cubo-3gr-Elettronico, Cubo-3gr-Manuale, Cubo-4gr-Elettronico, Cubo-4gr-Manuale, Domobar-Interruttore-Levetta, Domobar-Interruttore-Luminoso, Domobar-Junior-2B, Domobar-Junior-HX, Domobar-Super-2b-Pid-Manuale, Domobar-Super-Manuale, Minimax-Kometa-Elettronica, Minimax-Kometa-Pulsante, Minimax-Replica-Elettronica, Replica-2gr-manuale-multiboiler, Replica-3gr-manuale-multiboiler, Replica-elettronica-2gr, Replica-elettronica-3gr, Replica-elettronica-4gr, Replica-manuale-2gr, Replica-manuale-3gr, Replica-manuale-4gr, Replica-pulsante-2gr, Replica-pulsante-3gr, Replica-pulsante-4gr		



Part No.	525181	Ref. No.	ASSVALVINF
description	valve L 61mm ED ø 16mm shaft triangular brass		
For models:	Cubo-2gr-Manuale, Cubo-3gr-Manuale, Cubo-4gr-Manuale, Domobar-Interruttore-Levetta, Domobar-Interruttore-Luminoso, Domobar-Junior-2B, Domobar-Junior-HX, Domobar-Super-2b-Pid-Manuale, Domobar-Super-Manuale, Replica-2gr-manuale-multiboiler, Replica-3gr-manuale-multiboiler, Replica-manuale-2gr, Replica-manuale-3gr, Replica-manuale-4gr		

screw connections



Part No.	527942	Ref. No.	RACCTAPRGO
description	screw connection thread 1/2" int. ø 1 10.8mm int. ø 2 15mm L 17mm WS 22		
For models:	Cubo-2gr-Manuale, Cubo-3gr-Manuale, Cubo-4gr-Manuale, Domobar-Interruttore-Levetta, Domobar-Interruttore-Luminoso, Domobar-Junior-2B, Domobar-Junior-HX, Domobar-Super-2b-Pid-Manuale, Domobar-Super-Manuale, Replica-2gr-manuale-multiboiler, Replica-3gr-manuale-multiboiler, Replica-manuale-2gr, Replica-manuale-3gr, Replica-manuale-4gr		



components			
nozzles			
with thread			
 <p>1</p>			
Part No.	528486	Ref. No.	RACCGIES7
description	nozzle bore \varnothing 0.7mm thread M6x0.75 L 9mm WS 7		
For models:	Chimaera, Cubo-2gr-Elettronico, Cubo-2gr-Manuale, Cubo-3gr-Elettronico, Cubo-3gr-Manuale, Cubo-4gr-Elettronico, Cubo-4gr-Manuale, Domobar-Interruttore-Levetta, Domobar-Interruttore-Luminoso, Domobar-Junior-2B, Domobar-Junior-HX, Domobar-Super-2b-Pid-Elettronica, Domobar-Super-2b-Pid-Manuale, Domobar-Super-Elettronica, Domobar-Super-Manuale, Evolution-2gr-elettronica-e-puls, Evolution-3gr-elettronica-e-puls, Lollo-1gruppo, Lollo-2gruppi, Lollo-3gruppi, Minimax-Kometa-Elettronica, Minimax-Kometa-Pulsante, Minimax-Replica-Elettronica, Replica-2gr-elettronica-multiboiler, Replica-2gr-manuale-multiboiler, Replica-3gr-elettronica-multiboiler, Replica-3gr-manuale-multiboiler, Replica-elettronica-2gr, Replica-elettronica-3gr, Replica-elettronica-4gr, Replica-manuale-2gr, Replica-manuale-3gr, Replica-manuale-4gr, Replica-pulsante-2gr, Replica-pulsante-3gr, Replica-pulsante-4gr, Revolution-2gr-elettronica-epuls, Revolution-3gr-elettronica-epuls		

springs			
 <p>1</p>			
Part No.	526561	Ref. No.	MOLLPRGO
description	compression spring \varnothing 14.3mm L 21mm wire gauge \varnothing 1.8mm		
For models:	Cubo-2gr-Manuale, Cubo-3gr-Manuale, Cubo-4gr-Manuale, Domobar-Interruttore-Levetta, Domobar-Interruttore-Luminoso, Domobar-Junior-2B, Domobar-Junior-HX, Domobar-Super-2b-Pid-Manuale, Domobar-Super-Manuale, Replica-2gr-manuale-multiboiler, Replica-3gr-manuale-multiboiler, Replica-manuale-2gr, Replica-manuale-3gr, Replica-manuale-4gr		

screws			
 <p>1</p>			
Part No.	560373	Ref. No.	VITEVITBR
description	cylinder head bolt thread M4 thread L 12mm WS 3 SS Qty 1 pcs intake internal hexagon DIN 912/ISO 4762		
For models:	Chimaera, Cubo-2gr-Elettronico, Cubo-3gr-Elettronico, Cubo-4gr-Elettronico, Domobar-Super-2b-Pid-Elettronica, Domobar-Super-Elettronica, Evolution-2gr-elettronica-e-puls, Evolution-3gr-elettronica-e-puls, Lollo-1gruppo, Lollo-2gruppi, Lollo-3gruppi, Minimax-Kometa-Elettronica, Minimax-Kometa-Pulsante, Minimax-Replica-Elettronica, Replica-2gr-elettronica-multiboiler, Replica-3gr-elettronica-multiboiler, Replica-elettronica-2gr, Replica-elettronica-3gr, Replica-elettronica-4gr, Replica-pulsante-2gr, Replica-pulsante-3gr, Replica-pulsante-4gr, Revolution-2gr-elettronica-epuls, Revolution-3gr-elettronica-epuls		

water dispersions			
water dispersions			
group 2			
 <p>1</p>			
Part No.	525169	Ref. No.	RACCSPGRKO
description	water distributor \varnothing 21mm hole \varnothing 1.5mm H 12mm ET M6 grooves 6 1.3mm brass 2 holes perforation \varnothing 1.7mm		
For models:	Evolution-2gr-elettronica-e-puls, Evolution-3gr-elettronica-e-puls, Lollo-1gruppo, Lollo-2gruppi, Lollo-3gruppi, Minimax-Kometa-Elettronica, Minimax-Kometa-Pulsante		

 <p>1</p>			
Part No.	529081	Ref. No.	RACCSPGR
description	water distributor \varnothing 30mm hole \varnothing 1.5mm H 15mm ET M10x1 grooves 6 2.5mm brass		
For models:	Chimaera, Cubo-2gr-Elettronico, Cubo-2gr-Manuale, Cubo-3gr-Elettronico, Cubo-3gr-Manuale, Cubo-4gr-Elettronico, Cubo-4gr-Manuale, Domobar-Interruttore-Levetta, Domobar-Interruttore-Luminoso, Domobar-Junior-2B, Domobar-Junior-HX, Domobar-Super-2b-Pid-Elettronica, Domobar-Super-2b-Pid-Manuale, Domobar-Super-Elettronica, Domobar-Super-Manuale, Minimax-Replica-Elettronica, Replica-2gr-elettronica-multiboiler, Replica-2gr-manuale-multiboiler, Replica-3gr-elettronica-multiboiler, Replica-3gr-manuale-multiboiler, Replica-elettronica-2gr, Replica-elettronica-3gr, Replica-elettronica-4gr, Replica-manuale-2gr, Replica-manuale-3gr, Replica-manuale-4gr, Replica-pulsante-2gr, Replica-pulsante-3gr, Replica-pulsante-4gr, Revolution-2gr-elettronica-epuls, Revolution-3gr-elettronica-epuls		

safety valves			
safety valves			
1/2"			
 <p>1</p>			
Part No.	529306	Ref. No.	VALVMO
description	safety valve connection 1/2" triggering pressure 1.8bar		
For models:	Chimaera, Evolution-2gr-elettronica-e-puls, Evolution-3gr-elettronica-e-puls, Lollo-2gruppi, Lollo-3gruppi, Minimax-Kometa-Elettronica, Minimax-Kometa-Pulsante, Replica-2gr-elettronica-multiboiler, Replica-2gr-manuale-multiboiler, Replica-3gr-elettronica-multiboiler, Replica-3gr-manuale-multiboiler, Revolution-2gr-elettronica-epuls, Revolution-3gr-elettronica-epuls		



expansion valves

with hose connection



Part No.	526587	Ref. No.	ASSVALVESPEVO
description	expansion valve T1: 1/4" ET hose \varnothing 9.5mm L 42mm		
For models:	Chimaera, Evolution-2gr-elettronica-e-puls, Evolution-3gr-elettronica-e-puls, Lollo-1gruppo, Lollo-2gruppi, Lollo-3gruppi, Replica-2gr-elettronica-multiboiler, Replica-2gr-manuale-multiboiler, Replica-3gr-elettronica-multiboiler, Replica-3gr-manuale-multiboiler, Revolution-2gr-elettronica-epuls, Revolution-3gr-elettronica-epuls		

gaskets



Part No.	698775	Ref. No.	GUARSILRUDOST
description	gasket ED \varnothing 9.5mm H 5mm PTFE for espresso machine		
For models:	Domobar-Junior-2B, Domobar-Junior-HX, Domobar-Super-2b-Pid-Elettronica, Domobar-Super-2b-Pid-Manuale, Domobar-Super-Elettronica, Domobar-Super-Manuale		



Part No.	525182	Ref. No.	GUARSILRUDOMSU
description	sealing disc \varnothing 9mm thickness 5mm silicone Qty 1 pcs		
For models:	Domobar-Super-Elettronica, Domobar-Super-Manuale		

compression springs



Part No.	526474	Ref. No.	MOLLCOVANORIT MOLLCOVATNORIT UNK1479865
description	compression spring \varnothing 8mm L 31.5mm wire gauge \varnothing 0.4mm for expansion valve		
For models:	Cubo-2gr-Elettronico, Cubo-2gr-Manuale, Cubo-3gr-Elettronico, Cubo-3gr-Manuale, Cubo-4gr-Elettronico, Cubo-4gr-Manuale, Minimax-Kometa-Elettronica, Minimax-Kometa-Pulsante, Minimax-Replica-Elettronica, Replica-elettronica-2gr, Replica-elettronica-3gr, Replica-elettronica-4gr, Replica-manuale-2gr, Replica-manuale-3gr, Replica-manuale-4gr, Replica-pulsante-2gr, Replica-pulsante-3gr, Replica-pulsante-4gr		

drain pans

drain pans



Part No.	525168	Ref. No.	MATECSCSCEVOL
description	drain pan \varnothing 76mm H 36mm hole \varnothing 12mm hose \varnothing 18mm		
For models:	Evolution-2gr-elettronica-e-puls, Evolution-3gr-elettronica-e-puls, Lollo-1gruppo, Lollo-2gruppi, Lollo-3gruppi, Replica-2gr-elettronica-multiboiler, Replica-2gr-manuale-multiboiler, Replica-3gr-elettronica-multiboiler, Replica-3gr-manuale-multiboiler, Revolution-2gr-elettronica-epuls, Revolution-3gr-elettronica-epuls		



Part No.	531083	Ref. No.	MATECSCSC
description	drain pan \varnothing 76mm H 36mm hose \varnothing 18mm		
For models:	Minimax-Kometa-Elettronica, Minimax-Kometa-Pulsante, Minimax-Replica-Elettronica, Replica-elettronica-2gr, Replica-elettronica-3gr, Replica-elettronica-4gr, Replica-manuale-2gr, Replica-manuale-3gr, Replica-manuale-4gr, Replica-pulsante-2gr, Replica-pulsante-3gr, Replica-pulsante-4gr		

boilers

gaskets

unperforated



Part No.	528137	Ref. No.	N/A
description	boiler gasket D1 \varnothing 163mm D2 \varnothing 150mm thickness 4mm PTFE suitable for VIBIEMME		



steam/water taps

steam/water taps

steam/water taps



1

Part No.	531260	Ref. No.	RACCRUBVAACEV
description	steam/water tap inlet 1/4" outlet 3/8" shaft ø6mm shaft L 15mm brass		



1

Part No.	529560	Ref. No.	N/A
description	steam/water tap inlet 1/4" outlet 3/8" suitable for MERCURY		



1

Part No.	525191	Ref. No.	ASSRACCRUBLOLLO+RACCDAFISSRLO RACCRUBVAKRIN UNK1660283
description	steam/water tap mounting pos. left/right inlet 3/8" outlet 3/8" shaft M8 shaft L 25mm chrome-plated brass		
For models:	Lollo-1gruppo, Lollo-2gruppi, Lollo-3gruppi		

steam taps

steam taps (complete)



1

Part No.	525187	Ref. No.	RACCRUBVAKNEW
description	steam tap inlet 1/4" pipe length 150mm tube ø 8mm		
For models:	Evolution-2gr-elettronica-e-puls, Evolution-3gr-elettronica-e-puls, Minimax-Kometa-Elettronica, Minimax-Kometa-Pulsante, Revolution-2gr-elettronica-epuls, Revolution-3gr-elettronica-epuls		



1

Part No.	525186	Ref. No.	RACCRUBVASXKN UNK24830165
description	steam tap mounting pos. left inlet 3/8" chrome-plated brass pipe length 250mm tube ø 8mm		
For models:	Lollo-1gruppo, Lollo-2gruppi, Lollo-3gruppi		



1

Part No.	525185	Ref. No.	ASSRACCRUBLOLLO+TUBIVALFDKONW RACCRUBVADXXKN UNK54712463
description	steam tap mounting pos. right with steam pipe inlet 3/8" chrome-plated brass pipe length 250mm tube ø 8mm		
For models:	Lollo-1gruppo, Lollo-2gruppi, Lollo-3gruppi		



1

Part No.	529891	Ref. No.	RACCRUBVAMEIN RACCRUBVAMER	
description	steam tap with steam pipe			
For models:	Replica-pulsante-2gr, Replica-pulsante-3gr, Replica-pulsante-4gr			
spare parts for	529891			
	Part No.	529893	Ref. No.	TUBIVALF TUBIVALFINOX
	steam pipe IT 3/8"			



bodies



1

Part No.	525198	Ref. No.	RACCCORUVA UNK83890755
description	tap body T1: 3/8" T2: 1/2" L 76mm		
For models:	Chimaera, Cubo-2gr-Elettronico, Cubo-2gr-Manuale, Cubo-3gr-Elettronico, Cubo-3gr-Manuale, Cubo-4gr-Elettronico, Cubo-4gr-Manuale, Minimax-Replica-Elettronica, Replica-2gr-elettronica-multiboiler, Replica-2gr-manuale-multiboiler, Replica-3gr-elettronica-multiboiler, Replica-3gr-manuale-multiboiler, Replica-elettronica-2gr, Replica-elettronica-3gr, Replica-elettronica-4gr, Replica-manuale-2gr, Replica-manuale-3gr, Replica-manuale-4gr		

components

shafts



1

Part No.	525173	Ref. No.	RACCASTRUBEVO
description	shaft \varnothing 6mm D2 \varnothing 14.5mm L 100mm brass		
For models:	Evolution-2gr-elettronica-e-puls, Evolution-3gr-elettronica-e-puls, Minimax-Kometa-Elettronica, Minimax-Kometa-Pulsante, Revolution-2gr-elettronica-epuls, Revolution-3gr-elettronica-epuls		



1

Part No.	525176	Ref. No.	RACCASRUREP UNK71704633
description	shaft \varnothing 8mm L 76mm SS		
For models:	Chimaera, Cubo-2gr-Elettronico, Cubo-2gr-Manuale, Cubo-3gr-Elettronico, Cubo-3gr-Manuale, Cubo-4gr-Elettronico, Cubo-4gr-Manuale, Minimax-Replica-Elettronica, Replica-2gr-elettronica-multiboiler, Replica-2gr-manuale-multiboiler, Replica-3gr-elettronica-multiboiler, Replica-3gr-manuale-multiboiler, Replica-elettronica-2gr, Replica-elettronica-3gr, Replica-elettronica-4gr, Replica-manuale-2gr, Replica-manuale-3gr, Replica-manuale-4gr		

gaskets



1

Part No.	527960	Ref. No.	GUARSILRUBEVO
description	gasket D1 \varnothing 12mm thickness 6mm for steam-/water-tap		
For models:	Evolution-2gr-elettronica-e-puls, Evolution-3gr-elettronica-e-puls, Minimax-Kometa-Elettronica, Minimax-Kometa-Pulsante, Revolution-2gr-elettronica-epuls, Revolution-3gr-elettronica-epuls		



1

Part No.	529795	Ref. No.	GUARPI
description	gasket D1 \varnothing 13mm D2 \varnothing 4mm thickness 4mm coffee machine		
For models:	Chimaera, Cubo-2gr-Elettronico, Cubo-2gr-Manuale, Cubo-3gr-Elettronico, Cubo-3gr-Manuale, Cubo-4gr-Elettronico, Cubo-4gr-Manuale, Minimax-Replica-Elettronica, Replica-2gr-elettronica-multiboiler, Replica-2gr-manuale-multiboiler, Replica-3gr-elettronica-multiboiler, Replica-3gr-manuale-multiboiler, Replica-elettronica-2gr, Replica-elettronica-3gr, Replica-elettronica-4gr, Replica-manuale-2gr, Replica-manuale-3gr, Replica-manuale-4gr		

gasket supports



1

Part No.	525175	Ref. No.	RACCVARU UNK60394520
description	valve \varnothing hexagon 16mm L 14mm brass		
For models:	Chimaera, Cubo-2gr-Elettronico, Cubo-2gr-Manuale, Cubo-3gr-Elettronico, Cubo-3gr-Manuale, Cubo-4gr-Elettronico, Cubo-4gr-Manuale, Minimax-Replica-Elettronica, Replica-2gr-elettronica-multiboiler, Replica-2gr-manuale-multiboiler, Replica-3gr-elettronica-multiboiler, Replica-3gr-manuale-multiboiler, Replica-elettronica-2gr, Replica-elettronica-3gr, Replica-elettronica-4gr, Replica-manuale-2gr, Replica-manuale-3gr, Replica-manuale-4gr, Replica-pulsante-2gr, Replica-pulsante-3gr, Replica-pulsante-4gr		

springs



1

Part No.	527958	Ref. No.	MOLLAASTAREVO
description	compression spring \varnothing 10.5mm L 32mm wire gauge \varnothing 1.3mm for steam-/water-tap		
For models:	Evolution-2gr-elettronica-e-puls, Evolution-3gr-elettronica-e-puls, Minimax-Kometa-Elettronica, Minimax-Kometa-Pulsante, Revolution-2gr-elettronica-epuls, Revolution-3gr-elettronica-epuls		

tap bodies



1

Part No.	527962	Ref. No.	CORPORUACVAEV
description	body T1: M16x1 T2: 3/8" T3: 1/4" L 49mm		
For models:	Evolution-2gr-elettronica-e-puls, Evolution-3gr-elettronica-e-puls, Minimax-Kometa-Elettronica, Minimax-Kometa-Pulsante, Revolution-2gr-elettronica-epuls, Revolution-3gr-elettronica-epuls		



1

Part No.	529898	Ref. No.	RACCCORUACVA
description	tap body L 63mm		
For models:	Replica-manuale-2gr, Replica-manuale-3gr, Replica-manuale-4gr, Replica-pulsante-2gr, Replica-pulsante-3gr, Replica-pulsante-4gr		

washers



1

Part No.	560382	Ref. No.	RACCROBLMAEVO
description	washer D1 ø 6mm D2 ø 20mm thickness 1.5mm steam/water tap		
For models:	Evolution-2gr-elettronica-e-puls, Evolution-3gr-elettronica-e-puls, Minimax-Kometa-Elettronica, Minimax-Kometa-Pulsante, Revolution-2gr-elettronica-epuls, Revolution-3gr-elettronica-epuls		

screw connections



1

Part No.	525174	Ref. No.	RACCGUIASTEVO
description	screw connection T1: M16x1 T2: 1/2" L 62mm ID ø 11mm WS 26 brass		
For models:	Evolution-2gr-elettronica-e-puls, Evolution-3gr-elettronica-e-puls, Minimax-Kometa-Elettronica, Minimax-Kometa-Pulsante, Revolution-2gr-elettronica-epuls, Revolution-3gr-elettronica-epuls		

water taps

knobs



1

Part No.	111055	Ref. No.	MANPRUACVP
description	knob ø 50mm shaft ø 8x7mm black		
For models:	Replica-pulsante-2gr, Replica-pulsante-3gr, Replica-pulsante-4gr		

water taps



1

Part No.	529897	Ref. No.	RACCRUBACREP	
description	water tap inlet 1/4" outlet 3/8" thread 3/8" shaft 6.6mm			
For models:	Replica-manuale-2gr, Replica-manuale-3gr, Replica-manuale-4gr			
accessories for	529897			
	Part No.	111028	Ref. No.	MANPRUVAACRE UNK90878825
	star handle shaft 7x7mm ø 64mm L 24mm black			



1



Part No.	525188	Ref. No.	RACCRUBACKNEW
description	water tap inlet 1/4" pipe length 80mm tube ø 8mm		
For models:	Evolution-2gr-elettronica-e-puls, Evolution-3gr-elettronica-e-puls, Minimax-Kometa-Elettronica, Minimax-Kometa-Pulsante, Revolution-2gr-elettronica-epuls, Revolution-3gr-elettronica-epuls		



1

Part No.	525189	Ref. No.	RACCRUBDOACCR
description	water tap inlet 1/4" pipe length 80mm tube ø 8mm		
For models:	Domobar-Junior-2B, Domobar-Junior-HX, Domobar-Super-2b-Pid-Elettronica, Domobar-Super-2b-Pid-Manuale, Domobar-Super-Elettronica, Domobar-Super-Manuale		



Part No.	529890	Ref. No.	RACCRUBACMEIN RACCRUBACMER
description	water tap with water pipe		
For models:	Replica-pulsante-2gr, Replica-pulsante-3gr, Replica-pulsante-4gr		
spare parts for	529890		
	Part No.	529892	Ref. No. TUBIACSF
	water pipe thread 3/8"		
accessories for	529890		
	Part No.	111055	Ref. No. MANPRUACVP
	knob ø 50mm shaft ø 8x7mm black		

steam/water pipes

steam pipes



Part No.	529893	Ref. No.	TUBIVALF TUBIVALFINOX
description	steam pipe IT 3/8"		
For models:	Replica-pulsante-2gr, Replica-pulsante-3gr, Replica-pulsante-4gr		



Part No.	525192	Ref. No.	TUBILADOMSU
description	steam pipe mounting pos. left thread 3/8" H 180mm tube ø 8mm chrome-plated brass		
For models:	Domobar-Junior-2B, Domobar-Junior-HX, Domobar-Super-2b-Pid-Elettronica, Domobar-Super-2b-Pid-Manuale, Domobar-Super-Elettronica, Domobar-Super-Manuale		



Part No.	529819	Ref. No.	TUBILANCVASX UNK88470801
description	steam pipe mounting pos. left thread 3/8" H 200mm tube ø 8mm chrome-plated brass		
For models:	Cubo-2gr-Elettronico, Cubo-2gr-Manuale, Cubo-3gr-Elettronico, Cubo-3gr-Manuale, Cubo-4gr-Elettronico, Cubo-4gr-Manuale, Minimax-Replica-Elettronica, Replica-2gr-elettronica-multiboiler, Replica-2gr-manuale-multiboiler, Replica-3gr-elettronica-multiboiler, Replica-3gr-manuale-multiboiler, Replica-elettronica-2gr, Replica-elettronica-3gr, Replica-elettronica-4gr, Replica-manuale-2gr, Replica-manuale-3gr, Replica-manuale-4gr		



Part No.	525195	Ref. No.	TUBILANVASXKI
description	steam pipe mounting pos. left thread 3/8" H 250mm tube ø 8mm chrome-plated brass		
For models:	Lollo-1gruppo, Lollo-2gruppi, Lollo-3gruppi		

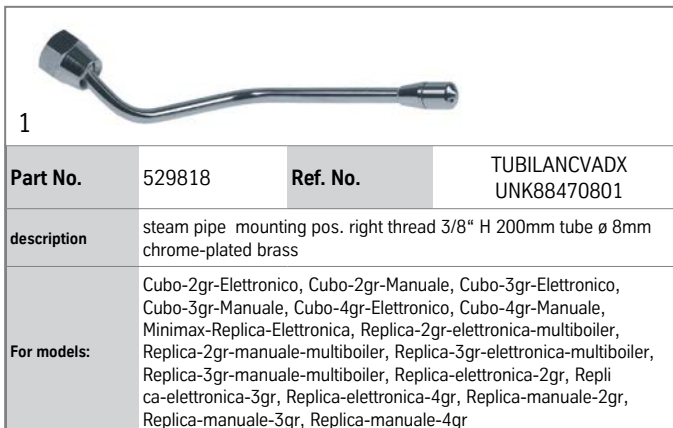

Part No.	529818	Ref. No.	TUBILANCVADX UNK88470801
description	steam pipe mounting pos. right thread 3/8" H 200mm tube ø 8mm chrome-plated brass		
For models:	Cubo-2gr-Elettronico, Cubo-2gr-Manuale, Cubo-3gr-Elettronico, Cubo-3gr-Manuale, Cubo-4gr-Elettronico, Cubo-4gr-Manuale, Minimax-Replica-Elettronica, Replica-2gr-elettronica-multiboiler, Replica-2gr-manuale-multiboiler, Replica-3gr-elettronica-multiboiler, Replica-3gr-manuale-multiboiler, Replica-elettronica-2gr, Replica-elettronica-3gr, Replica-elettronica-4gr, Replica-manuale-2gr, Replica-manuale-3gr, Replica-manuale-4gr		

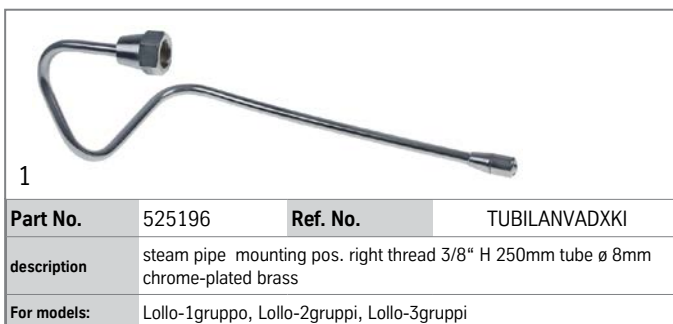

Part No.	525196	Ref. No.	TUBILANVADXKI
description	steam pipe mounting pos. right thread 3/8" H 250mm tube ø 8mm chrome-plated brass		
For models:	Lollo-1gruppo, Lollo-2gruppi, Lollo-3gruppi		



1 

Part No.	531082	Ref. No.	TUBILAVACOMEV TUBIVALFREVEV
description	steam pipe thread 3/8" H 190mm L 80mm tube ø 8mm		
For models:	Evolution-2gr-elettronica-e-puls, Evolution-3gr-elettronica-e-puls, Minimax-Kometa-Elettronica, Minimax-Kometa-Pulsante, Revolution-2gr-elettronica-epuls, Revolution-3gr-elettronica-epuls		

water pipes

1 

Part No.	529892	Ref. No.	TUBIACSF
description	water pipe thread 3/8"		
For models:	Replica-pulsante-2gr, Replica-pulsante-3gr, Replica-pulsante-4gr		

1 

Part No.	525194	Ref. No.	TUBIP727
description	water pipe thread 3/8" L 90mm tube ø 8mm WS 24 chrome-plated brass		
For models:	Domobar-Junior-2B, Domobar-Junior-HX, Domobar-Super-2b-Pid-Elettronica, Domobar-Super-2b-Pid-Manuale, Domobar-Super-Elettronica, Domobar-Super-Manuale, Lollo-1gruppo, Lollo-2gruppi, Lollo-3gruppi, Replica-manuale-2gr, Replica-manuale-3gr, Replica-manuale-4gr		

accessories

bushes

1 

Part No.	527971	Ref. No.	RACCBUIASF RACCBULASF
description	bush D1 ø 7.8mm D2 ø 15mm H 21.5mm brass ID ø 6mm		
For models:	Chimaera, Cubo-2gr-Elettronico, Cubo-2gr-Manuale, Cubo-3gr-Elettronico, Cubo-3gr-Manuale, Cubo-4gr-Elettronico, Cubo-4gr-Manuale, Domobar-Junior-2B, Domobar-Junior-HX, Domobar-Super-2b-Pid-Elettronica, Domobar-Super-2b-Pid-Manuale, Domobar-Super-Elettronica, Domobar-Super-Manuale, Evolution-2gr-elettronica-e-puls, Evolution-3gr-elettronica-e-puls, Lollo-1gruppo, Lollo-2gruppi, Lollo-3gruppi, Minimax-Kometa-Elettronica, Minimax-Kometa-Pulsante, Minimax-Replica-Elettronica, Replica-2gr-elettronica-multiboiler, Replica-2gr-manuale-multiboiler, Replica-3gr-elettronica-multiboiler, Replica-3gr-manuale-multiboiler, Replica-elettronica-2gr, Replica-elettronica-3gr, Replica-elettronica-4gr, Replica-manuale-2gr, Replica-manuale-3gr, Replica-manuale-4gr, Replica-pulsante-2gr, Replica-pulsante-3gr, Replica-pulsante-4gr, Revolution-2gr-elettronica-epuls, Revolution-3gr-elettronica-epuls		

1 

Part No.	529705	Ref. No.	RACCRUSASREVO
description	bush D1 ø 8.3mm D2 ø 12mm H 6mm brass ID ø 7mm		
For models:	Evolution-2gr-elettronica-e-puls, Evolution-3gr-elettronica-e-puls, Minimax-Kometa-Elettronica, Minimax-Kometa-Pulsante, Revolution-2gr-elettronica-epuls, Revolution-3gr-elettronica-epuls		

tube handles

1 

Part No.	528625	Ref. No.	GOMMALANCIAVA UNK60613522
description	tube handle L 35mm rubber ID ø 8mm		
For models:	Chimaera, Cubo-2gr-Elettronico, Cubo-2gr-Manuale, Cubo-3gr-Elettronico, Cubo-3gr-Manuale, Cubo-4gr-Elettronico, Cubo-4gr-Manuale, Minimax-Replica-Elettronica, Replica-2gr-elettronica-multiboiler, Replica-2gr-manuale-multiboiler, Replica-3gr-elettronica-multiboiler, Replica-3gr-manuale-multiboiler, Replica-elettronica-2gr, Replica-elettronica-3gr, Replica-elettronica-4gr, Replica-manuale-2gr, Replica-manuale-3gr, Replica-manuale-4gr, Replica-pulsante-2gr, Replica-pulsante-3gr, Replica-pulsante-4gr		

fine filters

fine filters

1 

Part No.	529979	Ref. No.	FILTGIGLEUR
description	fine filter ø 8.8mm H 22mm		
For models:	Chimaera, Cubo-2gr-Elettronico, Cubo-3gr-Elettronico, Cubo-4gr-Elettronico, Domobar-Super-2b-Pid-Elettronica, Domobar-Super-Elettronica, Evolution-2gr-elettronica-e-puls, Evolution-3gr-elettronica-e-puls, Lollo-1gruppo, Lollo-2gruppi, Lollo-3gruppi, Minimax-Kometa-Elettronica, Minimax-Kometa-Pulsante, Minimax-Replica-Elettronica, Replica-2gr-elettronica-multiboiler, Replica-3gr-elettronica-multiboiler, Replica-elettronica-2gr, Replica-elettronica-3gr, Replica-elettronica-4gr, Replica-pulsante-2gr, Replica-pulsante-3gr, Replica-pulsante-4gr, Revolution-2gr-elettronica-epuls, Revolution-3gr-elettronica-epuls		

intake valves

intake valves

1 

Part No.	529533	Ref. No.	ASSRUBCAAMER
description	intake valve brass L 105mm		



			
1			
Part No.	525197	Ref. No.	RACCRUBCARNEW
description	intake valve with expansion valve inlet 3/8" conical seal outlet 3/8"		
For models:	Evolution-2gr-elettronica-e-puls, Evolution-3gr-elettronica-e-puls, Revolution-2gr-elettronica-epuls, Revolution-3gr-elettronica-epuls		

			
1			
Part No.	525184	Ref. No.	RACCRUBCARLOL
description	intake valve with expansion valve inlet 3/8" outlet 3/8"-1/8"		
For models:	Chimaera, Evolution-2gr-elettronica-e-puls, Evolution-3gr-elettronica-e-puls, Lollo-1gruppo, Lollo-2gruppi, Lollo-3gruppi, Replica-2gr-elettronica-multiboiler, Replica-2gr-manuale-multiboiler, Replica-3gr-elettronica-multiboiler, Replica-3gr-manuale-multiboiler, Revolution-2gr-elettronica-epuls		

accessories

gaskets





			
1			
Part No.	531096	Ref. No.	GUARASRUMER
description	gasket		
For models:	Cubo-2gr-Elettronico, Cubo-2gr-Manuale, Cubo-3gr-Elettronico, Cubo-3gr-Manuale, Cubo-4gr-Elettronico, Cubo-4gr-Manuale, Minimax-Kometa-Elettronica, Minimax-Kometa-Pulsante, Minimax-Replica-Elettronica, Replica-elettronica-2gr, Replica-elettronica-3gr, Replica-elettronica-4gr, Replica-manuale-2gr, Replica-manuale-3gr, Replica-manuale-4gr, Replica-pulsante-2gr, Replica-pulsante-3gr, Replica-pulsante-4gr		

miscellaneous

			
1			
Part No.	531097	Ref. No.	VITERON31MER VITERON3IMER
description	plain washer		
For models:	Cubo-2gr-Elettronico, Cubo-2gr-Manuale, Cubo-3gr-Elettronico, Cubo-3gr-Manuale, Cubo-4gr-Elettronico, Cubo-4gr-Manuale, Minimax-Kometa-Elettronica, Minimax-Kometa-Pulsante, Minimax-Replica-Elettronica, Replica-elettronica-2gr, Replica-elettronica-3gr, Replica-elettronica-4gr, Replica-manuale-2gr, Replica-manuale-3gr, Replica-manuale-4gr, Replica-pulsante-2gr, Replica-pulsante-3gr, Replica-pulsante-4gr		

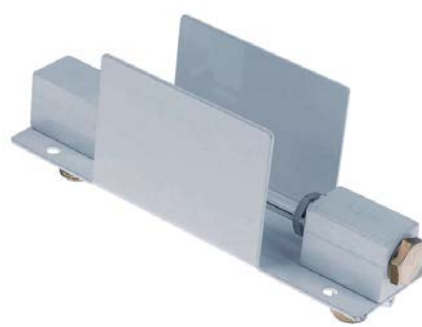
valves			
			
1			
Part No.	531100	Ref. No.	ASSVALVNONRIT
description	valve for filling valve		
For models:	Cubo-2gr-Elettronico, Cubo-2gr-Manuale, Cubo-3gr-Elettronico, Cubo-3gr-Manuale, Cubo-4gr-Elettronico, Cubo-4gr-Manuale, Minimax-Kometa-Elettronica, Minimax-Kometa-Pulsante, Minimax-Replica-Elettronica, Replica-elettronica-2gr, Replica-elettronica-3gr, Replica-elettronica-4gr, Replica-manuale-2gr, Replica-manuale-3gr, Replica-manuale-4gr, Replica-pulsante-2gr, Replica-pulsante-3gr, Replica-pulsante-4gr		

level glasses			
level glasses			
pressure rings			
			
1			
Part No.	525201	Ref. No.	RACCP224
description	press ring D1 ø 14.5mm D2 ø 11.5mm thickness 3.5mm inner cone brass		
For models:	Cubo-2gr-Elettronico, Cubo-2gr-Manuale, Cubo-3gr-Elettronico, Cubo-3gr-Manuale, Cubo-4gr-Elettronico, Cubo-4gr-Manuale, Evolution-2gr-elettronica-e-puls, Evolution-3gr-elettronica-e-puls, Minimax-Kometa-Elettronica, Minimax-Kometa-Pulsante, Minimax-Replica-Elettronica, Replica-elettronica-2gr, Replica-elettronica-3gr, Replica-elettronica-4gr, Replica-manuale-2gr, Replica-manuale-3gr, Replica-manuale-4gr, Replica-pulsante-2gr, Replica-pulsante-3gr, Replica-pulsante-4gr, Revolution-2gr-elettronica-epuls, Revolution-3gr-elettronica-epuls		

level glasses (complete)				
				
1				
Part No.	529235	Ref. No.	ASSLIVUNIFMN	
description	water level tube L 200mm W 55mm complete thread 3/8"			
accessories for	529235			
	Part No.	529393	Ref. No.	MATECVEL140
	water level tube ø 11mm H 140mm ID ø 8mm marking Min/Max			
	Part No.	529396	Ref. No.	—
	press ring D1 ø 11.3mm D2 ø 14.6mm thickness 3mm			
	Part No.	529397	Ref. No.	—
	union screw thread 3/8" hole ø 12.5mm H 12mm WS 17 brass			
	Part No.	529412	Ref. No.	GUAROR113
	O-ring EPDM thickness 2.62mm ID ø 10.78mm Qty 1 pcs			





 <p>1</p>			
Part No.	529236	Ref. No.	ASSLIVUNIF
description	water level tube L 200mm W 55mm complete thread 3/8"		
For models:	Cubo-2gr-Elettronico, Cubo-2gr-Manuale, Cubo-3gr-Elettronico, Cubo-3gr-Manuale, Cubo-4gr-Elettronico, Cubo-4gr-Manuale, Evolution-2gr-elettronica-e-puls, Evolution-3gr-elettronica-e-puls, Minimax-Kometa-Elettronica, Minimax-Kometa-Pulsante, Minimax-Replica-Elettronica, Replica-elettronica-2gr, Replica-elettronica-3gr, Replica-elettronica-4gr, Replica-manuale-2gr, Replica-manuale-3gr, Replica-manuale-4gr, Replica-pulsante-2gr, Replica-pulsante-3gr, Replica-pulsante-4gr, Revolution-2gr-elettronica-epuls, Revolution-3gr-elettronica-epuls		
accessories for	529236		
	Part No.	529393	Ref. No. MATECVELI140
	 <p>water level tube ø 11mm H 140mm ID ø 8mm marking Min/Max</p>		
	Part No.	529396	Ref. No. —
	 <p>press ring D1 ø 11.3mm D2 ø 14.6mm thickness 3mm</p>		
	Part No.	529397	Ref. No. —
	 <p>union screw thread 3/8" hole ø 12.5mm H 12mm WS 17 brass</p>		
	Part No.	529412	Ref. No. GUAROR113
	 <p>O-ring EPDM thickness 2.62mm ID ø 10.78mm Qty 1 pcs</p>		

<p>level glass pipes</p>			
 <p>1</p>			
Part No.	529393	Ref. No.	MATECVELI140
description	water level tube ø 11mm H 140mm ID ø 8mm marking Min/Max		
For models:	Cubo-2gr-Elettronico, Cubo-2gr-Manuale, Cubo-3gr-Elettronico, Cubo-3gr-Manuale, Cubo-4gr-Elettronico, Cubo-4gr-Manuale, Evolution-2gr-elettronica-e-puls, Evolution-3gr-elettronica-e-puls, Minimax-Kometa-Elettronica, Minimax-Kometa-Pulsante, Minimax-Replica-Elettronica, Replica-elettronica-2gr, Replica-elettronica-3gr, Replica-elettronica-4gr, Replica-manuale-2gr, Replica-manuale-3gr, Replica-manuale-4gr, Replica-pulsante-2gr, Replica-pulsante-3gr, Replica-pulsante-4gr, Revolution-2gr-elettronica-epuls, Revolution-3gr-elettronica-epuls		

<p>screw connections</p>			
 <p>1</p>			
Part No.	526676	Ref. No.	RACCP227
description	union screw thread 3/8" hole ø 12mm H 12mm WS 17 chrome-plated brass		
For models:	Cubo-2gr-Elettronico, Cubo-2gr-Manuale, Cubo-3gr-Elettronico, Cubo-3gr-Manuale, Cubo-4gr-Elettronico, Cubo-4gr-Manuale, Evolution-2gr-elettronica-e-puls, Evolution-3gr-elettronica-e-puls, Minimax-Kometa-Elettronica, Minimax-Kometa-Pulsante, Minimax-Replica-Elettronica, Replica-elettronica-2gr, Replica-elettronica-3gr, Replica-elettronica-4gr, Replica-manuale-2gr, Replica-manuale-3gr, Replica-manuale-4gr, Replica-pulsante-2gr, Replica-pulsante-3gr, Replica-pulsante-4gr, Revolution-2gr-elettronica-epuls, Revolution-3gr-elettronica-epuls		

<p>knobs</p>			
<p>steam/water taps</p>			
<p>steam/water taps</p>			
 <p>1</p>			
Part No.	111055	Ref. No.	MANPRUACVP
description	knob ø 50mm shaft ø 8x7mm black		
For models:	Replica-pulsante-2gr, Replica-pulsante-3gr, Replica-pulsante-4gr		

 <p>1</p>			
Part No.	111351	Ref. No.	MANPRSC MANPRUSC
description	turning handle ø 40mm shaft 6x6mm black		
For models:	Domobar-Interruttore-Levetta, Domobar-Interruttore-Luminoso, Domobar-Junior-2B, Domobar-Junior-HX, Domobar-Super-2b-Pid-Elettronica, Domobar-Super-2b-Pid-Manuale, Domobar-Super-Elettronica, Domobar-Super-Manuale		

 <p>1</p>			
Part No.	111355	Ref. No.	MANPRUACUPEVO
description	turning handle ø 42mm L 49mm black		
For models:	Evolution-2gr-elettronica-e-puls, Evolution-3gr-elettronica-e-puls, Minimax-Kometa-Elettronica, Minimax-Kometa-Pulsante, Revolution-2gr-elettronica-epuls, Revolution-3gr-elettronica-epuls		

 <p>1</p>			
Part No.	111352	Ref. No.	MANPRUSCDOMSA UNK57161488
description	turning handle ø 50mm shaft 6x6mm black		
For models:	Domobar-Junior-2B, Domobar-Junior-HX, Domobar-Super-2b-Pid-Elettronica, Domobar-Super-2b-Pid-Manuale, Domobar-Super-Elettronica, Domobar-Super-Manuale		



accessories



Part No.	111028	Ref. No.	MANPRUVAACRE UNK90878825
description	star handle shaft 7x7mm ø 64mm L 24mm black		
For models:	Chimaera, Cubo-2gr-Elettronico, Cubo-2gr-Manuale, Cubo-3gr-Elettronico, Cubo-3gr-Manuale, Cubo-4gr-Elettronico, Cubo-4gr-Manuale, Minimax-Replica-Elettronica, Replica-2gr-elettronica-multiboiler, Replica-2gr-manuale-multiboiler, Replica-3gr-elettronica-multiboiler, Replica-3gr-manuale-multiboiler, Replica-elettronica-2gr, Replica-elettronica-3gr, Replica-elettronica-4gr, Replica-manuale-2gr, Replica-manuale-3gr, Replica-manuale-4gr		



Part No.	530293	Ref. No.	GUAROR108 UNK43672353
description	O-ring EPDM thickness 1.78mm ID ø 8.73mm Qty 1 pcs		
For models:	Cubo-2gr-Elettronico, Cubo-2gr-Manuale, Cubo-3gr-Elettronico, Cubo-3gr-Manuale, Cubo-4gr-Elettronico, Cubo-4gr-Manuale, Minimax-Kometa-Elettronica, Minimax-Kometa-Pulsante, Minimax-Replica-Elettronica, Replica-elettronica-2gr, Replica-elettronica-3gr, Replica-elettronica-4gr, Replica-manuale-2gr, Replica-manuale-3gr, Replica-manuale-4gr, Replica-pulsante-2gr, Replica-pulsante-3gr, Replica-pulsante-4gr		

handles and hand wheels

cone handles



Part No.	111092	Ref. No.	MANPPOLE
description	cone handle thread M8 ø 25mm L 41mm black		
For models:	Cubo-2gr-Manuale, Cubo-3gr-Manuale, Cubo-4gr-Manuale, Domobar-Interruttore-Levetta, Domobar-Interruttore-Luminoso, Domobar-Junior-2B, Domobar-Junior-HX, Domobar-Super-2b-Pid-Manuale, Domobar-Super-Manuale, Lollo-1gruppo, Lollo-2gruppi, Lollo-3gruppi, Replica-2gr-manuale-multiboiler, Replica-3gr-manuale-multiboiler, Replica-manuale-2gr, Replica-manuale-3gr, Replica-manuale-4gr		

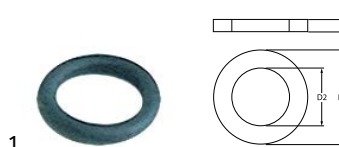

Part No.	529412	Ref. No.	GUAROR113
description	O-ring EPDM thickness 2.62mm ID ø 10.78mm Qty 1 pcs		
For models:	Chimaera, Cubo-2gr-Elettronico, Cubo-2gr-Manuale, Cubo-3gr-Elettronico, Cubo-3gr-Manuale, Cubo-4gr-Elettronico, Cubo-4gr-Manuale, Domobar-Junior-2B, Domobar-Junior-HX, Domobar-Super-2b-Pid-Elettronica, Domobar-Super-2b-Pid-Manuale, Domobar-Super-Elettronica, Domobar-Super-Manuale, Evolution-2gr-elettronica-e-puls, Evolution-3gr-elettronica-e-puls, Lollo-1gruppo, Lollo-2gruppi, Lollo-3gruppi, Minimax-Kometa-Elettronica, Minimax-Kometa-Pulsante, Minimax-Replica-Elettronica, Replica-2gr-elettronica-multiboiler, Replica-2gr-manuale-multiboiler, Replica-3gr-elettronica-multiboiler, Replica-3gr-manuale-multiboiler, Replica-elettronica-2gr, Replica-elettronica-3gr, Replica-elettronica-4gr, Replica-manuale-2gr, Replica-manuale-3gr, Replica-manuale-4gr, Replica-pulsante-2gr, Replica-pulsante-3gr, Replica-pulsante-4gr, Revolution-2gr-elettronica-epuls, Revolution-3gr-elettronica-epuls		

gaskets

O-rings

EPDM



Part No.	510177	Ref. No.	GUARR6
description	O-ring EPDM thickness 1.78mm ID ø 7.66mm Qty 1 pcs		
For models:	Chimaera, Cubo-2gr-Elettronico, Cubo-2gr-Manuale, Cubo-3gr-Elettronico, Cubo-3gr-Manuale, Cubo-4gr-Elettronico, Cubo-4gr-Manuale, Domobar-Interruttore-Levetta, Domobar-Interruttore-Luminoso, Domobar-Junior-2B, Domobar-Junior-HX, Domobar-Super-2b-Pid-Elettronica, Domobar-Super-2b-Pid-Manuale, Domobar-Super-Elettronica, Domobar-Super-Manuale, Evolution-2gr-elettronica-e-puls, Evolution-3gr-elettronica-e-puls, Lollo-1gruppo, Lollo-2gruppi, Lollo-3gruppi, Minimax-Kometa-Elettronica, Minimax-Kometa-Pulsante, Minimax-Replica-Elettronica, Replica-2gr-elettronica-multiboiler, Replica-2gr-manuale-multiboiler, Replica-3gr-elettronica-multiboiler, Replica-3gr-manuale-multiboiler, Replica-elettronica-2gr, Replica-elettronica-3gr, Replica-elettronica-4gr, Replica-manuale-2gr, Replica-manuale-3gr, Replica-manuale-4gr, Replica-pulsante-2gr, Replica-pulsante-3gr, Replica-pulsante-4gr, Revolution-2gr-elettronica-epuls, Revolution-3gr-elettronica-epuls		

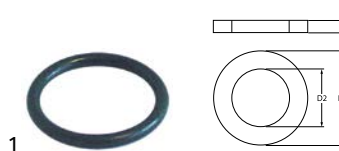

Part No.	505073	Ref. No.	GUAROR128
description	O-ring EPDM thickness 2.62mm ID ø 20.63mm Qty 1 pcs		
For models:	Cubo-2gr-Manuale, Cubo-3gr-Manuale, Cubo-4gr-Manuale, Domobar-Interruttore-Levetta, Domobar-Interruttore-Luminoso, Domobar-Junior-2B, Domobar-Junior-HX, Domobar-Super-2b-Pid-Manuale, Domobar-Super-Manuale, Replica-2gr-manuale-multiboiler, Replica-3gr-manuale-multiboiler, Replica-manuale-2gr, Replica-manuale-3gr, Replica-manuale-4gr		

Viton

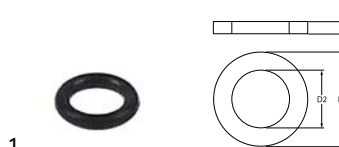

Part No.	371095	Ref. No.	GUARASTRUEV
description	O-ring Viton thickness 1.78mm ID ø 6.07mm Qty 1 pcs		
For models:	Evolution-2gr-elettronica-e-puls, Evolution-3gr-elettronica-e-puls, Minimax-Kometa-Elettronica, Minimax-Kometa-Pulsante, Revolution-2gr-elettronica-epuls, Revolution-3gr-elettronica-epuls		



sealing washers

fibre gaskets



Part No.	510405	Ref. No.	N/A
description	flat gasket fibre ED ø 56mm ID ø 42mm thickness 2mm for thread 1¼" Qty 1 pcs		

copper gaskets

DIN-7603-A



Part No.	526461	Ref. No.	RACCRONRARVEV
description	flat gasket copper ED ø 22mm ID ø 17mm thickness 2mm Qty 1 pcs		
For models:	Evolution-2gr-elettronica-e-puls, Evolution-3gr-elettronica-e-puls, Minimax-Kometa-Elettronica, Minimax-Kometa-Pulsante, Revolution-2gr-elettronica-epuls, Revolution-3gr-elettronica-epuls		

PTFE gaskets



Part No.	526554	Ref. No.	VITERON6TEFLO
description	flat gasket PTFE ED ø 10mm ID ø 6mm thickness 1mm Qty 1 pcs		
For models:	Chimaera, Cubo-2gr-Elettronico, Cubo-2gr-Manuale, Cubo-3gr-Elettronico, Cubo-3gr-Manuale, Cubo-4gr-Elettronico, Cubo-4gr-Manuale, Domobar-Interruttore-Levetta, Domobar-Interruttore-Luminoso, Domobar-Junior-2B, Domobar-Junior-HX, Domobar-Super-2b-Pid-Elettronica, Domobar-Super-2b-Pid-Manuale, Domobar-Super-Elettronica, Domobar-Super-Manuale, Evolution-2gr-elettronica-e-puls, Evolution-3gr-elettronica-e-puls, Lollo-1gruppo, Lollo-2gruppi, Lollo-3gruppi, Minimax-Kometa-Elettronica, Minimax-Kometa-Pulsante, Minimax-Replica-Elettronica, Replica-2gr-elettronica-multiboiler, Replica-2gr-manuale-multiboiler, Replica-3gr-elettronica-multiboiler, Replica-3gr-manuale-multiboiler, Replica-elettronica-2gr, Replica-elettronica-3gr, Replica-elettronica-4gr, Replica-manuale-2gr, Replica-manuale-3gr, Replica-manuale-4gr, Replica-pulsante-2gr, Replica-pulsante-3gr, Replica-pulsante-4gr, Revolution-2gr-elettronica-epuls, Revolution-3gr-elettronica-epuls		



Part No.	526661	Ref. No.	VITERONTPP189
description	flat gasket PTFE ED ø 17mm ID ø 13mm thickness 2mm Qty 1 pcs		
For models:	Cubo-2gr-Elettronico, Cubo-2gr-Manuale, Cubo-3gr-Elettronico, Cubo-3gr-Manuale, Cubo-4gr-Elettronico, Cubo-4gr-Manuale, Evolution-2gr-elettronica-e-puls, Evolution-3gr-elettronica-e-puls, Minimax-Kometa-Elettronica, Minimax-Kometa-Pulsante, Minimax-Replica-Elettronica, Replica-elettronica-2gr, Replica-elettronica-3gr, Replica-elettronica-4gr, Replica-manuale-2gr, Replica-manuale-3gr, Replica-manuale-4gr, Replica-pulsante-2gr, Replica-pulsante-3gr, Replica-pulsante-4gr, Revolution-2gr-elettronica-epuls, Revolution-3gr-elettronica-epuls		

Part No.	525611	Ref. No.	GUARTE
description	flat gasket PTFE ED ø 22mm ID ø 17mm thickness 2mm Qty 1 pcs		
For models:	Cubo-2gr-Elettronico, Cubo-2gr-Manuale, Cubo-3gr-Elettronico, Cubo-3gr-Manuale, Cubo-4gr-Elettronico, Cubo-4gr-Manuale, Domobar-Interruttore-Levetta, Domobar-Interruttore-Luminoso, Domobar-Junior-2B, Domobar-Junior-HX, Domobar-Super-2b-Pid-Manuale, Domobar-Super-Manuale, Evolution-2gr-elettronica-e-puls, Evolution-3gr-elettronica-e-puls, Lollo-1gruppo, Lollo-2gruppi, Lollo-3gruppi, Minimax-Kometa-Elettronica, Minimax-Kometa-Pulsante, Minimax-Replica-Elettronica, Replica-2gr-manuale-multiboiler, Replica-3gr-manuale-multiboiler, Replica-elettronica-2gr, Replica-elettronica-3gr, Replica-elettronica-4gr, Replica-manuale-2gr, Replica-manuale-3gr, Replica-manuale-4gr, Replica-pulsante-2gr, Replica-pulsante-3gr, Replica-pulsante-4gr		

Part No.	525199	Ref. No.	GUARCASUTEPI
description	flat gasket PTFE ED ø 25.5mm ID ø 21mm thickness 5.5mm Qty 1 pcs		
For models:	Chimaera, Cubo-2gr-Elettronico, Cubo-2gr-Manuale, Cubo-3gr-Elettronico, Cubo-3gr-Manuale, Cubo-4gr-Elettronico, Cubo-4gr-Manuale, Domobar-Interruttore-Levetta, Domobar-Interruttore-Luminoso, Domobar-Junior-2B, Domobar-Junior-HX, Domobar-Super-2b-Pid-Elettronica, Domobar-Super-2b-Pid-Manuale, Domobar-Super-Elettronica, Domobar-Super-Manuale, Minimax-Replica-Elettronica, Replica-2gr-elettronica-multiboiler, Replica-2gr-manuale-multiboiler, Replica-3gr-elettronica-multiboiler, Replica-3gr-manuale-multiboiler, Replica-elettronica-2gr, Replica-elettronica-3gr, Replica-elettronica-4gr, Replica-manuale-2gr, Replica-manuale-3gr, Replica-manuale-4gr, Replica-pulsante-2gr, Replica-pulsante-3gr, Replica-pulsante-4gr, Revolution-2gr-elettronica-epuls, Revolution-3gr-elettronica-epuls		

Part No.	528683	Ref. No.	GUARTACHGR
description	flat gasket PTFE ED ø 26mm ID ø 21mm thickness 2mm Qty 1 pcs suitable for GAGGIA, SPAZIALE		
For models:	Chimaera, Cubo-2gr-Elettronico, Cubo-2gr-Manuale, Cubo-3gr-Elettronico, Cubo-3gr-Manuale, Cubo-4gr-Elettronico, Cubo-4gr-Manuale, Domobar-Interruttore-Levetta, Domobar-Interruttore-Luminoso, Domobar-Junior-2B, Domobar-Junior-HX, Domobar-Super-2b-Pid-Elettronica, Domobar-Super-2b-Pid-Manuale, Domobar-Super-Elettronica, Domobar-Super-Manuale, Evolution-2gr-elettronica-e-puls, Evolution-3gr-elettronica-e-puls, Lollo-1gruppo, Lollo-2gruppi, Lollo-3gruppi, Minimax-Kometa-Elettronica, Minimax-Kometa-Pulsante, Minimax-Replica-Elettronica, Replica-2gr-elettronica-multiboiler, Replica-2gr-manuale-multiboiler, Replica-3gr-elettronica-multiboiler, Replica-3gr-manuale-multiboiler, Replica-elettronica-2gr, Replica-elettronica-3gr, Replica-elettronica-4gr, Replica-manuale-2gr, Replica-manuale-3gr, Replica-manuale-4gr, Replica-pulsante-2gr, Replica-pulsante-3gr, Replica-pulsante-4gr, Revolution-2gr-elettronica-epuls, Revolution-3gr-elettronica-epuls		

mechanical components,
equipment accessories
1



			
1			
Part No.	526014	Ref. No.	GUARCAINGRTE
description	flat gasket PTFE ED ø 35mm ID ø 30mm thickness 2mm Qty 1 pcs		
For models:	Chimaera, Cubo-2gr-Elettronico, Cubo-2gr-Manuale, Cubo-3gr-Elettronico, Cubo-3gr-Manuale, Cubo-4gr-Elettronico, Cubo-4gr-Manuale, Domobar-Interruttore-Levetta, Domobar-Interruttore-Luminoso, Domobar-Junior-2B, Domobar-Junior-HX, Domobar-Super-2b-Pid-Elettronica, Domobar-Super-2b-Pid-Manuale, Domobar-Super-Elettronica, Domobar-Super-Manuale, Evolution-2gr-elettronica-e-puls, Evolution-3gr-elettronica-e-puls, Lollo-1gruppo, Lollo-2gruppi, Lollo-3gruppi, Minimax-Kometa-Elettronica, Minimax-Kometa-Pulsante, Minimax-Replica-Elettronica, Replica-2gr-elettronica-multiboiler, Replica-2gr-manuale-multiboiler, Replica-3gr-elettronica-multiboiler, Replica-3gr-manuale-multiboiler, Replica-elettronica-2gr, Replica-elettronica-3gr, Replica-elettronica-4gr, Replica-manuale-2gr, Replica-manuale-3gr, Replica-manuale-4gr, Replica-pulsante-2gr, Replica-pulsante-3gr, Replica-pulsante-4gr, Revolution-2gr-elettronica-epuls, Revolution-3gr-elettronica-epuls		

			
2			
Part No.	528021	Ref. No.	GUARRESPICTEF
description	flat gasket PTFE ED ø 53mm ID ø 42.5mm thickness 3mm Qty 1 pcs equiv. no. 12001/02286 suitable for Astoria/Aurora/Brasilia/Wega		
For models:	Domobar-Super-Elettronica, Domobar-Super-Manuale, Lollo-1gruppo		

special gaskets

sealing discs

			
1			
Part No.	525182	Ref. No.	GUARSILRUDOMSU
description	sealing disc ø 9mm thickness 5mm silicone Qty 1 pcs		
For models:	Domobar-Super-Elettronica, Domobar-Super-Manuale		

group gaskets

			
1			
Part No.	528165	Ref. No.	GUARGR
description	group gasket L 76mm W 72mm thickness 2.5mm aperture 26x64mm hole distance 55mm		
For models:	Chimaera, Cubo-2gr-Elettronico, Cubo-2gr-Manuale, Cubo-3gr-Elettronico, Cubo-3gr-Manuale, Cubo-4gr-Elettronico, Cubo-4gr-Manuale, Domobar-Interruttore-Levetta, Domobar-Interruttore-Luminoso, Domobar-Junior-2B, Domobar-Junior-HX, Domobar-Super-2b-Pid-Elettronica, Domobar-Super-2b-Pid-Manuale, Domobar-Super-Elettronica, Domobar-Super-Manuale, Minimax-Replica-Elettronica, Replica-2gr-elettronica-multiboiler, Replica-2gr-manuale-multiboiler, Replica-3gr-elettronica-multiboiler, Replica-3gr-manuale-multiboiler, Replica-elettronica-2gr, Replica-elettronica-3gr, Replica-elettronica-4gr, Replica-manuale-2gr, Replica-manuale-3gr, Replica-manuale-4gr, Replica-pulsante-2gr, Replica-pulsante-3gr, Replica-pulsante-4gr, Revolution-2gr-elettronica-epuls, Revolution-3gr-elettronica-epuls		

			
1			
Part No.	525183	Ref. No.	GUARGRKO
description	group gasket L 72mm W 64mm thickness 2mm hole distance 56mm		
For models:	Evolution-2gr-elettronica-e-puls, Evolution-3gr-elettronica-e-puls, Lollo-1gruppo, Lollo-2gruppi, Lollo-3gruppi, Minimax-Kometa-Elettronica, Minimax-Kometa-Pulsante		

springs

compression springs

			
1			
Part No.	531094	Ref. No.	MOLLSF
description	compression spring		
For models:	Chimaera, Cubo-2gr-Elettronico, Cubo-2gr-Manuale, Cubo-3gr-Elettronico, Cubo-3gr-Manuale, Cubo-4gr-Elettronico, Cubo-4gr-Manuale, Minimax-Kometa-Elettronica, Minimax-Kometa-Pulsante, Minimax-Replica-Elettronica, Replica-2gr-elettronica-multiboiler, Replica-2gr-manuale-multiboiler, Replica-3gr-elettronica-multiboiler, Replica-3gr-manuale-multiboiler, Replica-elettronica-2gr, Replica-elettronica-3gr, Replica-elettronica-4gr, Replica-manuale-2gr, Replica-manuale-3gr, Replica-manuale-4gr, Replica-pulsante-2gr, Replica-pulsante-3gr, Replica-pulsante-4gr		

			
1			
Part No.	531095	Ref. No.	MOLLASRUBMER
description	compression spring		
For models:	Cubo-2gr-Elettronico, Cubo-2gr-Manuale, Cubo-3gr-Elettronico, Cubo-3gr-Manuale, Cubo-4gr-Elettronico, Cubo-4gr-Manuale, Minimax-Kometa-Elettronica, Minimax-Kometa-Pulsante, Minimax-Replica-Elettronica, Replica-elettronica-2gr, Replica-elettronica-3gr, Replica-elettronica-4gr, Replica-manuale-2gr, Replica-manuale-3gr, Replica-manuale-4gr, Replica-pulsante-2gr, Replica-pulsante-3gr, Replica-pulsante-4gr		

			
1			
Part No.	527958	Ref. No.	MOLLAASTAREVO
description	compression spring ø 10.5mm L 32mm wire gauge ø 1.3mm for steam-/water-tap		
For models:	Evolution-2gr-elettronica-e-puls, Evolution-3gr-elettronica-e-puls, Minimax-Kometa-Elettronica, Minimax-Kometa-Pulsante, Revolution-2gr-elettronica-epuls, Revolution-3gr-elettronica-epuls		



 <p>1</p>			
Part No.	528916	Ref. No.	MOLTUVARUBEVO
description	compression spring ø 10.9mm L 26mm wire gauge ø 1.5mm		
For models:	Evolution-2gr-elettronica-e-puls, Evolution-3gr-elettronica-e-puls, Minimax-Kometa-Elettronica, Minimax-Kometa-Pulsante, Revolution-2gr-elettronica-epuls, Revolution-3gr-elettronica-epuls		

 <p>1</p>			
Part No.	525202	Ref. No.	MOLLVAIN
description	compression spring ø 13.8mm L 54.5mm wire gauge ø 1.5mm windings 16		
For models:	Cubo-2gr-Manuale, Cubo-3gr-Manuale, Cubo-4gr-Manuale, Domobar-Interruttore-Levetta, Domobar-Interruttore-Luminoso, Domobar-Junior-2B, Domobar-Junior-HX, Domobar-Super-2b-Pid-Manuale, Domobar-Super-Manuale, Replica-2gr-manuale-multiboiler, Replica-3gr-manuale-multiboiler, Replica-manuale-2gr, Replica-manuale-3gr, Replica-manuale-4gr		

 <p>1</p>			
Part No.	527934	Ref. No.	MOLLVAER
description	compression spring ø 14.2mm L 45mm wire gauge ø 1.5mm SS		
For models:	Cubo-2gr-Manuale, Cubo-3gr-Manuale, Cubo-4gr-Manuale, Domobar-Interruttore-Levetta, Domobar-Interruttore-Luminoso, Domobar-Junior-2B, Domobar-Junior-HX, Domobar-Super-2b-Pid-Manuale, Domobar-Super-Manuale, Replica-2gr-manuale-multiboiler, Replica-3gr-manuale-multiboiler, Replica-manuale-2gr, Replica-manuale-3gr, Replica-manuale-4gr		

 <p>1</p>			
Part No.	526561	Ref. No.	MOLLPRGO
description	compression spring ø 14.3mm L 21mm wire gauge ø 1.8mm		
For models:	Cubo-2gr-Manuale, Cubo-3gr-Manuale, Cubo-4gr-Manuale, Domobar-Interruttore-Levetta, Domobar-Interruttore-Luminoso, Domobar-Junior-2B, Domobar-Junior-HX, Domobar-Super-2b-Pid-Manuale, Domobar-Super-Manuale, Replica-2gr-manuale-multiboiler, Replica-3gr-manuale-multiboiler, Replica-manuale-2gr, Replica-manuale-3gr, Replica-manuale-4gr		

 <p>1</p>			
Part No.	528475	Ref. No.	MOLLSC
description	compression spring ø 14.7mm L 33mm wire gauge ø 2mm		
For models:	Cubo-2gr-Elettronico, Cubo-2gr-Manuale, Cubo-3gr-Elettronico, Cubo-3gr-Manuale, Cubo-4gr-Elettronico, Cubo-4gr-Manuale, Domobar-Interruttore-Levetta, Domobar-Interruttore-Luminoso, Domobar-Junior-2B, Domobar-Junior-HX, Domobar-Super-2b-Pid-Manuale, Domobar-Super-Manuale, Minimax-Kometa-Elettronica, Minimax-Kometa-Pulsante, Minimax-Replica-Elettronica, Replica-2gr-manuale-multiboiler, Replica-3gr-manuale-multiboiler, Replica-elettronica-2gr, Replica-elettronica-3gr, Replica-elettronica-4gr, Replica-manuale-2gr, Replica-manuale-3gr, Replica-manuale-4gr, Replica-pulsante-2gr, Replica-pulsante-3gr, Replica-pulsante-4gr		

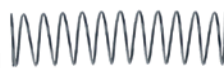
 <p>1</p>			
Part No.	526474	Ref. No.	MOLLCOVANORIT MOLLCOVATNORIT UNK1479865
description	compression spring ø 8mm L 31.5mm wire gauge ø 0.4mm for expansion valve		
For models:	Cubo-2gr-Elettronico, Cubo-2gr-Manuale, Cubo-3gr-Elettronico, Cubo-3gr-Manuale, Cubo-4gr-Elettronico, Cubo-4gr-Manuale, Minimax-Kometa-Elettronica, Minimax-Kometa-Pulsante, Minimax-Replica-Elettronica, Replica-elettronica-2gr, Replica-elettronica-3gr, Replica-elettronica-4gr, Replica-manuale-2gr, Replica-manuale-3gr, Replica-manuale-4gr, Replica-pulsante-2gr, Replica-pulsante-3gr, Replica-pulsante-4gr		

 <p>1</p>			
Part No.	802103	Ref. No.	MISURINO
description	coffee spoon amount of coffee 7g plastic		
For models:	Chimaera, Cubo-2gr-Elettronico, Cubo-2gr-Manuale, Cubo-3gr-Elettronico, Cubo-3gr-Manuale, Cubo-4gr-Elettronico, Cubo-4gr-Manuale, Domobar-Interruttore-Levetta, Domobar-Interruttore-Luminoso, Domobar-Junior-2B, Domobar-Junior-HX, Domobar-Super-2b-Pid-Elettronica, Domobar-Super-2b-Pid-Manuale, Domobar-Super-Elettronica, Domobar-Super-Manuale, Evolution-2gr-elettronica-e-puls, Evolution-3gr-elettronica-e-puls, Lollo-1gruppo, Lollo-2gruppi, Lollo-3gruppi, Minimax-Kometa-Elettronica, Minimax-Kometa-Pulsante, Minimax-Replica-Elettronica, Replica-2gr-elettronica-multiboiler, Replica-2gr-manuale-multiboiler, Replica-3gr-elettronica-multiboiler, Replica-3gr-manuale-multiboiler, Replica-elettronica-2gr, Replica-elettronica-3gr, Replica-elettronica-4gr, Replica-manuale-2gr, Replica-manuale-3gr, Replica-manuale-4gr, Replica-pulsante-2gr, Replica-pulsante-3gr, Replica-pulsante-4gr, Revolution-2gr-elettronica-epuls, Revolution-3gr-elettronica-epuls		

coffee tampers

 <p>1</p>			
Part No.	802104	Ref. No.	PRESSINO
description	coffee press plastic ø 49/53mm		
For models:	Chimaera, Cubo-2gr-Elettronico, Cubo-2gr-Manuale, Cubo-3gr-Elettronico, Cubo-3gr-Manuale, Cubo-4gr-Elettronico, Cubo-4gr-Manuale, Domobar-Interruttore-Levetta, Domobar-Interruttore-Luminoso, Domobar-Junior-2B, Domobar-Junior-HX, Domobar-Super-2b-Pid-Elettronica, Domobar-Super-2b-Pid-Manuale, Domobar-Super-Elettronica, Domobar-Super-Manuale, Evolution-2gr-elettronica-e-puls, Evolution-3gr-elettronica-e-puls, Lollo-1gruppo, Lollo-2gruppi, Lollo-3gruppi, Minimax-Kometa-Elettronica, Minimax-Kometa-Pulsante, Minimax-Replica-Elettronica, Replica-2gr-elettronica-multiboiler, Replica-2gr-manuale-multiboiler, Replica-3gr-elettronica-multiboiler, Replica-3gr-manuale-multiboiler, Replica-elettronica-2gr, Replica-elettronica-3gr, Replica-elettronica-4gr, Replica-manuale-2gr, Replica-manuale-3gr, Replica-manuale-4gr, Replica-pulsante-2gr, Replica-pulsante-3gr, Replica-pulsante-4gr, Revolution-2gr-elettronica-epuls, Revolution-3gr-elettronica-epuls		



manometers



1

Part No.	541233	Ref. No.	N/A
description	manometer double scale ø 60mm pressure range 0-2.5 / 0-15bar connection on the backside thread 1/8"		



1

Part No.	541287	Ref. No.	N/A
description	manometer double scale ø 60mm pressure range 0-2.5 / 0-15bar connection on the backside thread 1/8"		



1

Part No.	541410	Ref. No.	N/A
description	manometer double scale ø 60mm pressure range 0-2.5 / 0-15bar connection on the backside thread 1/8"		



1

Part No.	541512	Ref. No.	MANMDOTNVBM
description	manometer double scale ø 60mm pressure range 0-2.5 / 0-15bar connection on the backside thread 1/8"		
For models:	Minimax-Kometa-Elettronica, Minimax-Kometa-Pulsante		



1

Part No.	541222	Ref. No.	N/A
description	manometer double scale ø 60mm pressure range 0-2.5 / 0-16bar connection on the backside thread 1/8"		



1

Part No.	541226	Ref. No.	N/A
description	manometer double scale ø 60mm pressure range 0-2.5 / 0-16bar connection on the backside thread 1/8"		



1

Part No.	541227	Ref. No.	N/A
description	manometer double scale ø 60mm pressure range 0-2.5 / 0-16bar connection on the backside thread 1/8"		



1

Part No.	541513	Ref. No.	MANMKO UNK35164268
description	manometer double scale ø 63mm pressure range 0-2.5 / 0-16bar connection on the backside thread 1/8"		
For models:	Evolution-2gr-elettronica-e-puls, Evolution-3gr-elettronica-e-puls, Revolution-2gr-elettronica-epuls, Revolution-3gr-elettronica-epuls		



1

Part No.	541752	Ref. No.	MANMDOE40016
description	manometer ø 40mm pressure range 0-16bar thread 1/8" connection on the backside with capillary pipe		
For models:	Domobar-Junior-2B, Domobar-Junior-HX, Domobar-Super-2b-Pid-Elettronica, Domobar-Super-2b-Pid-Manuale, Domobar-Super-Elettronica, Domobar-Super-Manuale, Minimax-Replica-Elettronica		





1

Part No.	541751	Ref. No.	MANMDOE40025
description	manometer ø 40mm pressure range 0-4bar thread 1/8" connection on the backside with capillary pipe		
For models:	Domobar-Junior-2B, Domobar-Junior-HX, Domobar-Super-2b-Pid-Elettronica, Domobar-Super-2b-Pid-Manuale, Domobar-Super-Elettronica, Domobar-Super-Manuale, Minimax-Replica-Elettronica		



			
1			
Part No.	541511	Ref. No.	MANMSEM MANMSEM42025
description	manometer ø 41mm pressure range 0 up to 2.5bar thread 1/8" marking 1.1		

			
1			
Part No.	541753	Ref. No.	MANM49016GHIR UNK1204937
description	manometer ø 50mm pressure range 0-16bar thread 1/8" marking 8-10 connection on the backside with capillary pipe		
For models:	Lollo-2gruppi, Lollo-3gruppi		

			
1			
Part No.	541756	Ref. No.	MANM49016GHI UNK55184468
description	manometer ø 50mm pressure range 0-16bar thread 1/8" marking 8-10 connection on the backside with capillary pipe		
For models:	Evolution-2gr-elettronica-e-puls, Evolution-3gr-elettronica-e-puls, Replica-2gr-elettronica-multiboiler, Replica-2gr-manuale-multiboiler, Replica-3gr-elettronica-multiboiler, Replica-3gr-manuale-multiboiler, Replica-elettronica-2gr, Replica-elettronica-3gr, Replica-elettronica-4gr, Replica-manuale-2gr, Replica-manuale-3gr, Replica-manuale-4gr, Replica-pulsante-2gr, Replica-pulsante-3gr, Replica-pulsante-4gr, Revolution-2gr-elettronica-epuls, Revolution-3gr-elettronica-epuls		

			
1			
Part No.	541755	Ref. No.	MANM49025GHIR UNK41655333
description	manometer ø 50mm pressure range 0-2.5bar thread 1/8" marking 1.3-1.6 connection on the backside with capillary pipe		
For models:	Lollo-2gruppi, Lollo-3gruppi		

			
1			
Part No.	541757	Ref. No.	MANM49025GHI UNK29708214
description	manometer ø 50mm pressure range 0-2.5bar thread 1/8" marking 1.3-1.6 connection on the backside with capillary pipe		
For models:	Chimaera, Evolution-2gr-elettronica-e-puls, Evolution-3gr-elettronica-e-puls, Replica-2gr-elettronica-multiboiler, Replica-2gr-manuale-multiboiler, Replica-3gr-elettronica-multiboiler, Replica-3gr-manuale-multiboiler, Replica-elettronica-2gr, Replica-elettronica-3gr, Replica-elettronica-4gr, Replica-manuale-2gr, Replica-manuale-3gr, Replica-manuale-4gr, Replica-pulsante-2gr, Replica-pulsante-3gr, Replica-pulsante-4gr, Revolution-2gr-elettronica-epuls, Revolution-3gr-elettronica-epuls		

fastening material

screws

hexagonal screws

			
1			
Part No.	506175	Ref. No.	UNK79513711 VITETEM8X14
description	hexagonal screw thread M8 thread L 14mm SS WS 13 Qty 20 pcs head thickness 3mm DIN 933 / ISO 4017		
For models:	Chimaera, Cubo-2gr-Elettronico, Cubo-2gr-Manuale, Cubo-3gr-Elettronico, Cubo-3gr-Manuale, Cubo-4gr-Elettronico, Cubo-4gr-Manuale, Domobar-Interruttore-Levetta, Domobar-Interruttore-Luminoso, Domobar-Junior-2B, Domobar-Junior-HX, Domobar-Super-2b-Pid-Elettronica, Domobar-Super-2b-Pid-Manuale, Domobar-Super-Elettronica, Domobar-Super-Manuale, Evolution-2gr-elettronica-e-puls, Evolution-3gr-elettronica-e-puls, Lollo-1gruppo, Lollo-2gruppi, Lollo-3gruppi, Minimax-Kometa-Elettronica, Minimax-Kometa-Pulsante, Minimax-Replica-Elettronica, Replica-2gr-elettronica-multiboiler, Replica-2gr-manuale-multiboiler, Replica-3gr-elettronica-multiboiler, Replica-3gr-manuale-multiboiler, Replica-elettronica-2gr, Replica-elettronica-3gr, Replica-elettronica-4gr, Replica-manuale-2gr, Replica-manuale-3gr, Replica-manuale-4gr, Replica-pulsante-2gr, Replica-pulsante-3gr, Replica-pulsante-4gr, Revolution-2gr-elettronica-epuls, Revolution-3gr-elettronica-epuls		

cylinder head bolts

DIN 912/ISO 4762

			
1			
Part No.	560373	Ref. No.	VITEVITBR
description	cylinder head bolt thread M4 thread L 12mm WS 3 SS Qty 1 pcs intake internal hexagon DIN 912/ISO 4762		
For models:	Chimaera, Cubo-2gr-Elettronico, Cubo-3gr-Elettronico, Cubo-4gr-Elettronico, Domobar-Super-2b-Pid-Elettronica, Domobar-Super-Elettronica, Evolution-2gr-elettronica-e-puls, Evolution-3gr-elettronica-e-puls, Lollo-1gruppo, Lollo-2gruppi, Lollo-3gruppi, Minimax-Kometa-Elettronica, Minimax-Kometa-Pulsante, Minimax-Replica-Elettronica, Replica-2gr-elettronica-multiboiler, Replica-3gr-elettronica-multiboiler, Replica-elettronica-2gr, Replica-elettronica-3gr, Replica-elettronica-4gr, Replica-pulsante-2gr, Replica-pulsante-3gr, Replica-pulsante-4gr, Revolution-2gr-elettronica-epuls, Revolution-3gr-elettronica-epuls		



1

Part No.	560031	Ref. No.	VITEBR6MA
description	cylinder head bolt thread M6 thread L 10mm WS 5 SS Qty 20 pcs DIN 912/ISO 4762		
For models:	Chimaera, Cubo-2gr-Elettronico, Cubo-2gr-Manuale, Cubo-3gr-Elettronico, Cubo-3gr-Manuale, Cubo-4gr-Elettronico, Cubo-4gr-Manuale, Domobar-Interruttore-Levetta, Domobar-Interruttore-Luminoso, Domobar-Junior-2B, Domobar-Junior-HX, Domobar-Super-2b-Pid-Elettronica, Domobar-Super-2b-Pid-Manuale, Domobar-Super-Elettronica, Domobar-Super-Manuale, Minimax-Replica-Elettronica, Replica-2gr-elettronica-multiboiler, Replica-2gr-manuale-multiboiler, Replica-3gr-elettronica-multiboiler, Replica-3gr-manuale-multiboiler, Replica-elettronica-2gr, Replica-elettronica-3gr, Replica-elettronica-4gr, Replica-manuale-2gr, Replica-manuale-3gr, Replica-manuale-4gr, Replica-pulsante-2gr, Replica-pulsante-3gr, Replica-pulsante-4gr, Revolution-2gr-elettronica-epuls, Revolution-3gr-elettronica-epuls		



1

Part No.	527170	Ref. No.	VITEBR6MACO
description	cylinder head bolt thread M6 thread L 8mm WS 5 SS Qty 1 pcs DIN 912/ISO 4762		
For models:	Chimaera, Cubo-2gr-Elettronico, Cubo-2gr-Manuale, Cubo-3gr-Elettronico, Cubo-3gr-Manuale, Cubo-4gr-Elettronico, Cubo-4gr-Manuale, Domobar-Interruttore-Levetta, Domobar-Interruttore-Luminoso, Domobar-Junior-2B, Domobar-Junior-HX, Domobar-Super-2b-Pid-Elettronica, Domobar-Super-2b-Pid-Manuale, Domobar-Super-Elettronica, Domobar-Super-Manuale, Evolution-2gr-elettronica-e-puls, Evolution-3gr-elettronica-e-puls, Lollo-1gruppo, Lollo-2gruppi, Lollo-3gruppi, Minimax-Kometa-Elettronica, Minimax-Kometa-Pulsante, Minimax-Replica-Elettronica, Replica-2gr-elettronica-multiboiler, Replica-2gr-manuale-multiboiler, Replica-3gr-elettronica-multiboiler, Replica-3gr-manuale-multiboiler, Replica-elettronica-2gr, Replica-elettronica-3gr, Replica-elettronica-4gr, Replica-manuale-2gr, Replica-manuale-3gr, Replica-manuale-4gr, Replica-pulsante-2gr, Replica-pulsante-3gr, Replica-pulsante-4gr, Revolution-2gr-elettronica-epuls, Revolution-3gr-elettronica-epuls		

nuts

cap nuts



1

Part No.	560137	Ref. No.	VITEDACE6MAIN
description	cap nuts thread M6 WS 10 SS Qty 20 pcs DIN/ISO DIN 1587		
For models:	Cubo-2gr-Manuale, Cubo-3gr-Manuale, Cubo-4gr-Manuale, Domobar-Interruttore-Levetta, Domobar-Interruttore-Luminoso, Domobar-Junior-2B, Domobar-Junior-HX, Domobar-Super-2b-Pid-Manuale, Domobar-Super-Manuale, Replica-2gr-manuale-multiboiler, Replica-3gr-manuale-multiboiler, Replica-manuale-2gr, Replica-manuale-3gr, Replica-manuale-4gr		

fasteners

cotter pins



1

Part No.	695209	Ref. No.	COPPASTRUBEVO
description	cotter pin ø 2mm L 20mm SS		
For models:	Evolution-2gr-elettronica-e-puls, Evolution-3gr-elettronica-e-puls, Minimax-Kometa-Elettronica, Minimax-Kometa-Pulsante, Revolution-2gr-elettronica-epuls, Revolution-3gr-elettronica-epuls		

GASTROPARTS.COM

