



**GASTROPARTS**

# VEMA

- [EN]** Equipment
- [DE]** Geräte
- [ES]** Aparatos
- [FR]** Équipement
- [IT]** Attrezzature
- [PL]** Urządzenia
- [RU]** Оборудование

✉ [gastroparts@gastroparts.com](mailto:gastroparts@gastroparts.com)

☎ +48 56 657 00 66

📘 [fb.com/gastroparts.global](https://fb.com/gastroparts.global)

**GASTROPARTS.COM**





## heating elements

### heating elements for crepes makers



1

<b>Part No.</b>	418612	<b>Ref. No.</b>	XRCR6
<b>description</b>	heating element 1400W 230V H 85mm tube ø 8.5mm connection male faston 6.3mm connection distance 100mm heating circuits 1 ED ø 258mm crepes maker		



1

<b>Part No.</b>	418617	<b>Ref. No.</b>	XRPV2 XRPV6
<b>description</b>	heating element 630W 230V L 200mm W 190mm L1 15mm L2 185mm W1 135mm W2 55mm tube ø 6.3mm connection distance 130mm connection male faston 6.3mm dry heating element		

### heating elements for contact grills

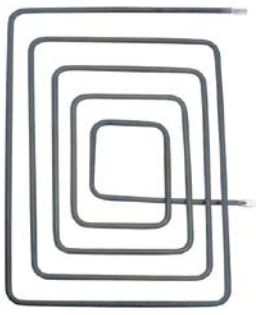

1

<b>Part No.</b>	418618	<b>Ref. No.</b>	XRPV25
<b>description</b>	heating element 1050W 230V L 235mm W 330mm L1 12mm L2 223mm W1 115mm W2 215mm tube ø 6.5mm		

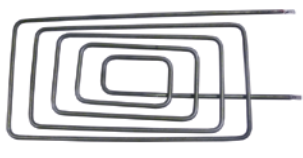

1

<b>Part No.</b>	418608	<b>Ref. No.</b>	XRFOPV2
<b>description</b>	heating element 1200W 230V heating circuits 1 L 417mm W 185mm L1 60mm L2 358mm W1 65mm W2 120mm tube ø 6.3mm connection distance 114mm connection male faston 6.3mm dry heating element		



1

<b>Part No.</b>	418610	<b>Ref. No.</b>	XR PV6 XRPV2
<b>description</b>	heating element 630W 230V heating circuits 1 L 200mm W 195mm L1 15mm L2 185mm W1 125mm W2 70mm tube ø 6mm connection length 15mm connection distance 119mm		

### heating elements for salamanders/toast-







1

<b>Part No.</b>	419029	<b>Ref. No.</b>	XRF04
<b>description</b>	heating element 480W 115V L 460mm thread 1/4" tube ø 8.5mm connection male faston 6.3mm heating circuits 1 dry heating element 2 hole fixing		



1

<b>Part No.</b>	418607	<b>Ref. No.</b>	XRF04
<b>description</b>	heating element 500W 115V L 460mm thread 1/4" connection length 52mm tube ø 8.5mm connection male faston 6.3mm heating circuits 1 dry heating element 2 hole fixing		
<b>accessories for</b>	418607		
	<b>Part No.</b>	361182	<b>Ref. No.</b> —
	nut thread 1/4" H 5mm nickel-plated brass WS 17 Qty 1 pcs		
	<b>Part No.</b>	510417	<b>Ref. No.</b> —
	flat gasket fibre ED ø 20mm ID ø 14mm thickness 2mm Qty 1 pcs		
	<b>Part No.</b>	520228	<b>Ref. No.</b> —
	tooth lock washer ID ø 15.3mm ED ø 24mm steel Qty 1 pcs for thread M14		
	<b>Part No.</b>	550262	<b>Ref. No.</b> —
	flat gasket copper ED ø 20mm ID ø 14mm thickness 2mm		



1

<b>Part No.</b>	418606	<b>Ref. No.</b>	XRTP2 XRTP2SX
<b>description</b>	hot plate 275W 110V L 145mm W 150mm cable length 200mm mounting pos. left toaster		



<b>Part No.</b>	418605	<b>Ref. No.</b>	X RTP2 XRTP2DX
<b>description</b>	hot plate 275W 110V L 145mm W 150mm cable length 200mm mounting pos. right toaster		



## immersion heating elements

## miscellaneous



<b>Part No.</b>	418613	<b>Ref. No.</b>	XRCU13
<b>description</b>	heating element 1850W 230V heating circuits 1 L 170mm W 98mm H 200mm rectangular flange hole distance 56mm hole $\varnothing$ M3mm L1 33mm W1 33mm W2 32mm connection male faston 6.3mm flange length 70mm flange width 22mm tube $\varnothing$ 8.5mm immersion heater		

## accessories for 418613

	<b>Part No.</b>	527169	<b>Ref. No.</b>	—
	hexagonal nut thread M3 H 2.8mm WS 5.5 brass Qty 1 pcs			
	<b>Part No.</b>	560110	<b>Ref. No.</b>	—
	plain washer ID $\varnothing$ 3.2mm ED $\varnothing$ 7mm thickness 0.5mm SS Qty 20 pcs DIN 125A for thread M3			
	<b>Part No.</b>	560130	<b>Ref. No.</b>	—
	hexagonal nut thread M3 H 2.4mm WS 5.5 SS DIN/ISO DIN 934 / ISO 4032/8673 Qty 20 pcs			

## hot plates

## round

## ring shaped



<b>Part No.</b>	490155	<b>Ref. No.</b>	XRCI33
<b>description</b>	hot plate $\varnothing$ 160mm 1000W 230V 7-position ring shaped		

## thermostats

## control and safety thermostats

## IMIT / TEMPOMATIC / AR THERMO

## control thermostats

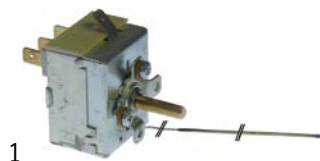

<b>Part No.</b>	375848	<b>Ref. No.</b>	XRPV3
<b>description</b>	thermostat t.max. 310°C temperature range°C 1-pole 1CO 16A probe $\varnothing$ 3mm probe L 200mm capillary pipe 1540mm capillary pipe isolatedmm gland nut shaft $\varnothing$ 6x4.6mm shaft L 19mm shaft position +135° rotation 270° 250V		



<b>Part No.</b>	375847	<b>Ref. No.</b>	XRCU20
<b>description</b>	thermostat t.max. 90°C temperature range 0-90°C 1-pole 1CO 15A probe $\varnothing$ 6.5mm probe L 100mm capillary pipe 1500mm capillary pipe isolatedmm gland nut shaft $\varnothing$ 6x4.6mm shaft L 18mm shaft position +135° rotation 270° 250V		

## FANTINI COSMI



<b>Part No.</b>	375852	<b>Ref. No.</b>	XRCI35
<b>description</b>	thermostat t.max. 310°C temperature range 50-300°C 1-pole 1CO probe $\varnothing$ 5mm probe L 80mm probe material copper		

## various

## control thermostats



<b>Part No.</b>	401642	<b>Ref. No.</b>	XRCI13
<b>description</b>	thermostat		



## switches and momentary switches

### rocker/momentary rocker switches

30x11mm



<b>Part No.</b>	346918	<b>Ref. No.</b>	XRF01
<b>description</b>	rocker switch mounting measurements 30x11mm red 1NO/indicator light 250V 16A 0-I connection male faston 6.3mm ambient temperature max. 85°C/145°C protection IP65 with cover cap		

<b>accessories for</b>	346918
	Part No. 301035 Ref. No. —
	protective cover mounting measurements 30x11mm

30x22mm



<b>Part No.</b>	301133	<b>Ref. No.</b>	CEPURIG
<b>description</b>	momentary rocker switch mounting measurements 30x22mm orange 2NO 250V 16A illuminated regeneration connection male faston 6.3mm ambient temperature max. 85/125°C protection IP40		

with symbol



<b>Part No.</b>	346867	<b>Ref. No.</b>	XRFR 22
<b>description</b>	rocker switch mounting measurements 30x22mm white 2CO 250V 16A with neutral position I O II connection male faston 6.3mm ambient temperature max. 100/55°C protection IP65 with cover cap		

<b>accessories for</b>	346867
	Part No. 301036 Ref. No. —
	protective cover internal size 30x22mm for rocker switch mounting measurementsmm



<b>Part No.</b>	346920	<b>Ref. No.</b>	XRCI4
<b>description</b>	rocker switch mounting measurements 30x22mm red 1NO/NO 250V 16A illuminated connection male faston 6.3mm ambient temperature max. 125/55°C protection IP65 with cover cap		

<b>accessories for</b>	346920
	Part No. 301036 Ref. No. —
	protective cover internal size 30x22mm for rocker switch mounting measurementsmm

### push/momentary push switches

28.5x52.6mm



<b>Part No.</b>	346919	<b>Ref. No.</b>	XRPV1
<b>description</b>	switch combination mounting measurements 28.5x52.6mm red/yellow 2NO/indicator light 250V 16A with indicator green/red connection male faston 6.3mm ambient temperature max. 85°C protection IP40		

### toggle switches

M12x0.75



<b>Part No.</b>	346520	<b>Ref. No.</b>	XRFR 33
<b>description</b>	toggle switch thread M12x0.75 2CO 250V 15A ON-OFF-ON male faston 6.3mm with neutral position t.max. 85/55°C		

### microswitches

lever actuated



<b>Part No.</b>	347480	<b>Ref. No.</b>	XRCE31
<b>description</b>	microswitch with lever 250V 3A 1CO connection cable 300mm ambient temperature max. 85°C mounting distance 22mm lever length 35mm		

### lamps

#### indicator lights

indicator lights (complete)

ø10mm

with screw socket



<b>Part No.</b>	359387	<b>Ref. No.</b>	XRTR11
<b>description</b>	indicator light ø 10mm 230V red cable length 250mm		



## timers

## mechanical timers



1

<b>Part No.</b>	350113	<b>Ref. No.</b>	XRCU18
<b>description</b>	timer G 2-pole operation time 30min impulse mechanical 2NO at 250V 16A permanent position no shaft $\varnothing$ 3.5x3.5mm shaft 3.5x3.5mm shaft L 17mm mounting distance 28mm connection lateral		



1

<b>Part No.</b>	350179	<b>Ref. No.</b>	XRTP3
<b>description</b>	timer G 2-pole operation time 5min impulse mechanical 2NO at 250V 16A permanent position no shaft $\varnothing$ 3.5x3.5mm shaft 3.5 x 3.5mm shaft L 17mm mounting distance 28mm connection lateral		

## accessories for 350179



<b>Part No.</b>	110365	<b>Ref. No.</b>	—
<b>description</b>	knob switch zero mark t.max.°C $\varnothing$ 44mm shaft $\varnothing$ 3.5x3.5mm shaft flat black		



<b>Part No.</b>	112913	<b>Ref. No.</b>	—
<b>description</b>	dial plate graduation 5min permanent position no rotation 30-330° $\varnothing$ 60mm suitable for timers $\varnothing$ 60mm		



1

<b>Part No.</b>	350032	<b>Ref. No.</b>	XRF05
<b>description</b>	timer M2 2-pole operation time 15min impulse mechanical 2NO at 250V 16A permanent position no shaft $\varnothing$ 6x4.6mm shaft 6x4.6mm shaft L 18mm mounting distance 28mm connection rear		

## accessories for 350032



<b>Part No.</b>	110366	<b>Ref. No.</b>	—
<b>description</b>	knob switch zero mark t.max.°C $\varnothing$ 44mm shaft $\varnothing$ 6x4.6mm shaft flat upper black		



<b>Part No.</b>	110371	<b>Ref. No.</b>	—
<b>description</b>	dial plate graduation 15min permanent position no rotation 30-330° $\varnothing$ 60mm timers knob $\varnothing$ 45mm		

## solid state relays

## accessories

## diodes

## diodes



<b>Part No.</b>	651014	<b>Ref. No.</b>	XRFR54
<b>description</b>	diode		

## motors

## gear motors

## miscellaneous



1

<b>Part No.</b>	500921	<b>Ref. No.</b>	XRCI21
<b>description</b>	gear motor TRIAL shaft $\varnothing$ 18mm L 115mm W 80mm H 150mm for chocolatiere		



1

<b>Part No.</b>	500920	<b>Ref. No.</b>	XRCI20
<b>description</b>	gear motor TRIAL shaft $\varnothing$ 6x8mm L 100mm W 70mm H 120mm for chocolatiere		

## motors

## for bar blender



1

<b>Part No.</b>	500790	<b>Ref. No.</b>	XRFR50
<b>description</b>	motor for bar blender		

1

<b>Part No.</b>	500791	<b>Ref. No.</b>	XRFR49
<b>description</b>	motor for bar blender 230V 200W 50Hz shaft ø 7mm H 90mm L 130mm W 90mm		



1

<b>Part No.</b>	651057	<b>Ref. No.</b>	XR FR 41
<b>description</b>	guard		

for citrus juicers



1

<b>Part No.</b>	501424	<b>Ref. No.</b>	XRSP7
<b>description</b>	motor shaft ø 16mm shaft length 85mm flange ø 74mm ø 130mm L 250mm mounting distance 62mm capacitor 6.3µF SP2072 Vema		

lids



1

<b>Part No.</b>	651001	<b>Ref. No.</b>	XRFR3
<b>description</b>	lid ø 129mm plastic nominal-ø 109mm		

## equipment-specific units

- for bar blender
- blenders
- jar components
- jars



1

<b>Part No.</b>	651002	<b>Ref. No.</b>	XRFR19
<b>description</b>	lid ø 129mm plastic nominal-ø 109mm hole ø 28mm		



1

<b>Part No.</b>	651003	<b>Ref. No.</b>	XRFR1	
<b>description</b>	blender jar plastic 1200ml			
<b>accessories for</b>	651003			
	Part No.	651057	Ref. No.	XR FR 41
	guard			

gaskets



1

<b>Part No.</b>	651010	<b>Ref. No.</b>	XRFR21
<b>description</b>	gasket D1 ø 115mm D2 ø 85mm thickness 2mm Qty 1 pcs		



1

<b>Part No.</b>	651007	<b>Ref. No.</b>	XRFR20
<b>description</b>	gasket ED ø 75mm ID ø 55mm thickness 3mm Qty 1 pcs		





## holders



1

<b>Part No.</b>	651040	<b>Ref. No.</b>	XRFR28 XRFR28 (4 denti)
-----------------	--------	-----------------	----------------------------

**description** bracket for jar with coupling 4 teeth  $\varnothing$  100mm nominal- $\varnothing$  78mm plastic

**accessories for** 651040



<b>Part No.</b>	651004	<b>Ref. No.</b>	XRFR15
-----------------	--------	-----------------	--------

knife set 3-piece W 52mm H 50mm hole  $\varnothing$  6.5x8mm stainless steel



1

<b>Part No.</b>	651006	<b>Ref. No.</b>	XRFR28 XRFR28 (8 denti)
-----------------	--------	-----------------	----------------------------

**description** bracket for jar with coupling 8 teeth  $\varnothing$  100mm nominal- $\varnothing$  78mm plastic

## blades

## spare blades



1

<b>Part No.</b>	651004	<b>Ref. No.</b>	XRFR15
-----------------	--------	-----------------	--------

**description** knife set 3-piece W 52mm H 50mm hole  $\varnothing$  6.5x8mm stainless steel

## mixer discs



1

<b>Part No.</b>	651015	<b>Ref. No.</b>	XRFR14
-----------------	--------	-----------------	--------

**description** mixer disc  $\varnothing$  54mm hole  $\varnothing$  6.5x8mm H 27mm plastic

## miscellaneous



1

<b>Part No.</b>	651016	<b>Ref. No.</b>	XRFR42
-----------------	--------	-----------------	--------

**description** nut thread M6L H 5mm WS 10 SS DIN/ISO DIN 934 / ISO 4032/8673 Qty 1 pcs

## holders



1

<b>Part No.</b>	651005	<b>Ref. No.</b>	XRFR35
-----------------	--------	-----------------	--------

**description** bracket for jar  $\varnothing$  117mm int.  $\varnothing$  1 35.5mm int.  $\varnothing$  2 81mm H 55mm

## actuators

## group 1



1

<b>Part No.</b>	651008	<b>Ref. No.</b>	XRFR16
-----------------	--------	-----------------	--------

**description** mixer coupling for jar  $\varnothing$  27mm H 12mm IT M6L teeth 8 plastic



1

<b>Part No.</b>	651009	<b>Ref. No.</b>	XRFR9
-----------------	--------	-----------------	-------

**description** mixer coupling for jar  $\varnothing$  27mm H 14mm IT M6L teeth 4 plastic



group 2



1

<b>Part No.</b>	651012	<b>Ref. No.</b>	XRFR24
<b>description</b>	mixer coupling for motor ø 28mm H 14mm teeth 4 rubber		



1

<b>Part No.</b>	651011	<b>Ref. No.</b>	XRFR17
<b>description</b>	mixer coupling for motor ø 28mm H 14mm teeth 8 plastic		

group 3



1

<b>Part No.</b>	651013	<b>Ref. No.</b>	XRFR18
<b>description</b>	mixer coupling ø 64mm H 33mm IT M7L ID ø 28mm plastic		

mixers

holders



1

<b>Part No.</b>	697905	<b>Ref. No.</b>	XRGR8
<b>description</b>	bracket 4 hole for jar W 72mm H 105mm GR/TR		



1

<b>Part No.</b>	651039	<b>Ref. No.</b>	XRFL12
<b>description</b>	bracket for jar H 76mm ø 110mm		

for juicers/centrifuges

holders



1

<b>Part No.</b>	697906	<b>Ref. No.</b>	XRCE10
<b>description</b>	bracket for microswitch L 42mm W 23mm H 20mm		

centrifuge baskets

grating discs

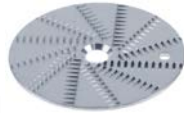

1

<b>Part No.</b>	696405	<b>Ref. No.</b>	XRCE2
<b>description</b>	grating disc for juicer ø 91mm seat ø 11.5mm		

accessories



1

<b>Part No.</b>	697904	<b>Ref. No.</b>	XRCE3
<b>description</b>	screw bolt for centrifuge basket thread M10L ø 16mm L 30mm		





for ice-cube maker

gearboxes



1

<b>Part No.</b>	500922	<b>Ref. No.</b>	XRCI11
<b>description</b>	gearbox		

for ice crusher

wipers



1

<b>Part No.</b>	698647	<b>Ref. No.</b>	XRSG8
<b>description</b>	wiper L 70mm W 47mm plastic		

blades



1

<b>Part No.</b>	697907	<b>Ref. No.</b>	XRTR1
<b>description</b>	knife W 45mm thickness 2.5mm mounting distance 15mm		

for contact grills

miscellaneous



1

<b>Part No.</b>	691245	<b>Ref. No.</b>	XRPV23
<b>description</b>	bush for pull handle		



1

<b>Part No.</b>	691246	<b>Ref. No.</b>	XRPV29
<b>description</b>	plain washer ID ø 8.2mm ED ø 20mm Qty 1 pcs for pull handle		

for chocolate dispensers

drain taps

drain taps



1

<b>Part No.</b>	691237	<b>Ref. No.</b>	XRCI6
<b>description</b>	outlet tap for chocolate dispenser connection 3/4" ET		

<b>accessories for</b>	691237			
	<b>Part No.</b>	691238	<b>Ref. No.</b>	XRCI16
	gasket for drain tap			

lids



1

<b>Part No.</b>	691235	<b>Ref. No.</b>	XRCI19
<b>description</b>	lid for chocolate dispenser ø 210mm		



1

<b>Part No.</b>	691236	<b>Ref. No.</b>	XRCI5
<b>description</b>	lid for chocolate dispenser ø 250mm		



1

<b>Part No.</b>	691243	<b>Ref. No.</b>	XRCI31
<b>description</b>	agitating arm complete for chocolate dispenser		

**gaskets**



1

<b>Part No.</b>	691238	<b>Ref. No.</b>	XRCI16
<b>description</b>	gasket for drain tap		

**accessories**



1

<b>Part No.</b>	691241	<b>Ref. No.</b>	XRCI24
<b>description</b>	bush for agitating arm		

**paddles**

**paddles**



1

<b>Part No.</b>	691240	<b>Ref. No.</b>	XRCI9
<b>description</b>	agitating arm complete for chocolate dispenser		



1

<b>Part No.</b>	691242	<b>Ref. No.</b>	XRCI32
<b>description</b>	scraper for agitating arm		



1

<b>Part No.</b>	691239	<b>Ref. No.</b>	XRCI7
<b>description</b>	scraper for agitating arm with spring		

**miscellaneous**



1

<b>Part No.</b>	691244	<b>Ref. No.</b>	XRCI14
<b>description</b>	pinion for gear motor		



## for toasters

## pliers

## accessories



<b>Part No.</b>	691210	<b>Ref. No.</b>	XRTP4
<b>description</b>	handle for plier black Qty 1 pcs		



<b>Part No.</b>	691208	<b>Ref. No.</b>	XRF07
<b>description</b>	handle protection for plier black Qty 2 pcs		

## pliers



<b>Part No.</b>	691206	<b>Ref. No.</b>	XRF03
<b>description</b>	plier for toaster		



<b>Part No.</b>	691209	<b>Ref. No.</b>	XRTP1
<b>description</b>	plier H 130mm toaster total length 195mm		

## knobs

## producer-specific knobs

## VEMA



<b>Part No.</b>	112198	<b>Ref. No.</b>	XRPV16
<b>description</b>	knob thermostat t.max. 300°C ø 42mm shaft ø 6x4.6mm shaft flat -135° temperature range 50-300°C with rosette		



<b>Part No.</b>	112197	<b>Ref. No.</b>	XRCI18
<b>description</b>	knob thermostat t.max. 90°C ø 42mm shaft ø 6x4.6mm temperature range 0-90°C with rosette		

## handles and hand wheels

## cylindrical handles

## fixed



<b>Part No.</b>	691210	<b>Ref. No.</b>	XRTP4
<b>description</b>	handle for plier black Qty 1 pcs		

## folding grill handles



<b>Part No.</b>	691219	<b>Ref. No.</b>	XRPV5
<b>description</b>	folding grill handle Qty 2 pcs		



miscellaneous



1

<b>Part No.</b>	691215	<b>Ref. No.</b>	XRCU17
<b>description</b>	handle		

baskets

miscellaneous



1

<b>Part No.</b>	691216	<b>Ref. No.</b>	XRCU16
<b>description</b>	egg basket ø 54mm L 160mm W 54mm H 35mm set 4-piece for egg cooker stainless steel		

gaskets

sealing washers

silicone gaskets



1

<b>Part No.</b>	651007	<b>Ref. No.</b>	XRFR20
<b>description</b>	gasket ED ø 75mm ID ø 55mm thickness 3mm Qty 1 pcs		

transmission technology and ball bearings

ball bearings

miscellaneous



1

<b>Part No.</b>	523545	<b>Ref. No.</b>	XRFR45
<b>description</b>	ball bearing type 6000-2Z/608-Z shaft ø 10/8mm ED ø 26/22mm W 8/7mm set 2-piece		

springs

torsion springs



1

<b>Part No.</b>	691217	<b>Ref. No.</b>	XRPV13
<b>description</b>	torsion spring ø 19mm wire gauge ø 3.5mm right		



1

<b>Part No.</b>	691218	<b>Ref. No.</b>	XRPV28
<b>description</b>	torsion spring ø 20.2mm wire gauge ø 3.8mm left		



1

<b>Part No.</b>	692167	<b>Ref. No.</b>	XRPV13
<b>description</b>	torsion spring set ø 19mm L2 45mm wire gauge ø 3.5mm L1 38mm L3 38mm Qty 1 pcs		

fastening material

nuts

hexagonal nuts

DIN 934 / ISO 4032/8673



1

<b>Part No.</b>	651016	<b>Ref. No.</b>	XRFR42
<b>description</b>	nut thread M6L H 5mm WS 10 SS DIN/ISO DIN 934 / ISO 4032/8673 Qty 1 pcs		



washers

washers

miscellaneous



1

<b>Part No.</b>	691246	<b>Ref. No.</b>	XRPV29
<b>description</b>	plain washer ID ø 8.2mm ED ø 20mm Qty 1 pcs for pull handle		

**GASTRO**PARTS.COM

