



GASTROPARTS

Unox

- [EN]** Equipment
- [DE]** Geräte
- [ES]** Aparatos
- [FR]** Équipement
- [IT]** Attrezzature
- [PL]** Urządzenia
- [RU]** Оборудование

✉ gastroparts@gastroparts.com

☎ +48 56 657 00 66

📘 fb.com/gastroparts.global

GASTROPARTS.COM







heating elements

heating elements for ovens

 <p>1</p>			
Part No.	417566	Ref. No.	RS1261A0
description	heating element 122W 105V heating circuits 1 L 85mm W 31mm flange length 70mm flange width 22mm hole distance 56mm hole ø 5mm tube ø 6.25mm connection male faston 6.3mm connection length 87mm rectangular flange dry heating element		
For models:	XB693, XB695, XB893, XB895, XV593		

 <p>1</p>			
Part No.	417565	Ref. No.	KRS1261A
description	heating element 122W 105V heating circuits 1 L 85mm W 31mm flange length 70mm flange width 22mm hole distance 56mm hole ø 5mm tube ø 6.25mm connection male faston 6.3mm connection length 87mm rectangular flange dry heating element with gasket and silicone		

 <p>1</p>			
Part No.	417549	Ref. No.	RS1215A0
description	heating element 147W 105V heating circuits 1 L 88mm W 30.5mm flange length 78mm flange width 28mm hole distance 55mm tube ø 6.3mm connection Faston 6.3mm connection length 85mm		
For models:	XBC1005, XBC605, XBC805, XBC815G, XVC1005P, XVC1015G, XVC105, XVC205, XVC305, XVC315G, XVC505, XVC515G, XVC705, XVC715G, XVC905P		

 <p>1</p>			
Part No.	417548	Ref. No.	KRS1215A
description	heating element 147W 105V heating circuits 1 L 88mm W 30.5mm flange length 78mm flange width 28mm hole distance 55mm tube ø 6.3mm connection Faston 6.3mm connection length 85mm with gasket and silicone		

quartz heating elements

 <p>1</p>			
Part No.	417740	Ref. No.	KRS0105A RS105
description	quartz heating element 500W 112.5V L 370mm ø 12mm connection male faston 4.8mm		
For models:	XT010, XT020		

heating elements for convection

 <p>1</p>			
Part No.	420192	Ref. No.	RS090
description	heating element 1260W 230V heating circuits 1 ID ø 178mm ED ø 190mm L 244mm H 31mm L1 47mm W1 31mm H1 6mm H2 25mm flange length 70mm flange width 22mm hole distance 56mm connection male faston 6.3mm tube ø 6.3mm convection heating element hole ø 5mm flange connection		
For models:	XF030, XF030-TG, XF040, XF050, XF065		

 <p>1</p>			
Part No.	417608	Ref. No.	KRS0090A KRS011
description	heating element 1260W 230V heating circuits 1 ID ø 178mm ED ø 190mm L 244mm H 31mm L1 47mm W1 31mm H1 6mm H2 25mm flange length 70mm flange width 22mm hole distance 56mm connection male faston 6.3mm tube ø 6.3mm convection heating element hole ø 5mm flange connection with gasket and silicone		

 <p>1</p>			
Part No.	417558	Ref. No.	KRS1240A
description	heating element 147/1300W 105/230V heating circuits 2 ID ø 218mm ED ø 236mm L 240mm H 15mm W1 70mm H1 5mm flange length 110mm flange width 22mm hole distance 18mm connection male faston 6.3mm with gasket and silicone		





			
1			
Part No.	417563	Ref. No.	RS1240A0
description	heating element 147/1300W 105/230V heating circuits 2 ID ø 220mm ED ø 236mm L 242mm H 96mm W1 74mm H1 5mm H2 26mm flange length 110mm flange width 22mm hole distance 94mm connection male faston 6.3mm		
For models:	XVC2015G		

			
1			
Part No.	417561	Ref. No.	KRS0023A
description	heating element 2560W 230V heating circuits 1 ID ø 220mm ED ø 235mm L 255mm H 45mm L1 20mm W1 30mm H1 8mm H2 30mm flange length 99mm flange width 21mm hole distance 86mm connection male faston 6.3mm connection length 60mm tube ø 6.3mm convection heating element hole ø 5mm rectangular flange with gasket and silicone		

			
1			
Part No.	417562	Ref. No.	RS0023A0
description	heating element 2560W 230V heating circuits 1 ID ø 220mm ED ø 235mm L 265mm H 45mm L1 30mm W1 30mm H1 8mm H2 32mm flange length 100mm flange width 22mm hole distance 86mm connection male faston 6.3mm connection length 60mm tube ø 6.3mm convection heating element hole ø 5mm rectangular flange		

			
1			
Part No.	418746	Ref. No.	KRS020 KRS1130A RS1130A0
description	heating element 2900W 230V heating circuits 1 ID ø 220mm ED ø 235mm L 268mm H 40mm L1 35mm W1 30mm H1 11mm H2 32mm flange length 99mm flange width 21mm hole distance 86mm connection male faston 6.3mm connection length 60mm tube ø 6.3mm convection heating element hole ø 5mm rectangular flange		
For models:	XF023, XF100, XF103, XF110, XF113, XF115, XF119, XF130, XF133, XF135		

				
1				
Part No.	418745	Ref. No.	KRS016 KRS1090A RS1090A0 RS1090A1	
description	heating element 2900W 230V heating circuits 1 ID ø 220mm ED ø 235mm L 268mm H 75mm L1 35mm W1 30mm H1 11mm H2 32mm flange length 99mm flange width 21mm hole distance 86mm connection male faston 6.3mm connection length 60mm tube ø 6.3mm convection heating element hole ø 5mm rectangular flange			
For models:	XF183, XF185, XF190, XF193, XF195, XVC054, XVC104			
accessories for	418745			
	Part No.	550986	Ref. No.	GN1280 GN1327A0 GN224
	gasket L 100mm W 22mm 7 holes graphite thickness 1mm for heating element			

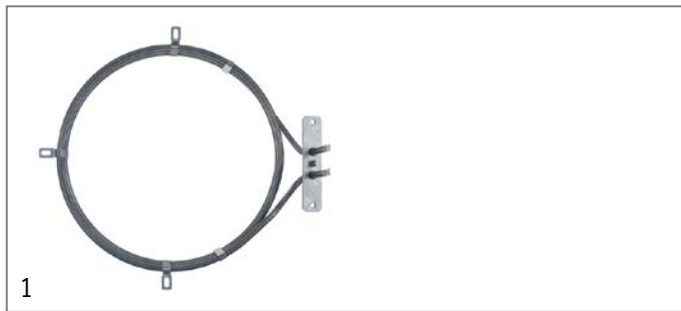

1			
Part No.	419142	Ref. No.	KRS003 KRS1026 KRS1026 + GN 1280 KRS1026A RS026A
description	heating element 3100W 230V heating circuits 1 ID \varnothing 220mm ED \varnothing 235mm H 45mm L1 25mm W1 25mm H1 8mm H2 30mm flange length 99mm flange width 21mm hole distance 86mm connection male faston 6.3mm connection length 60mm tube \varnothing 6.3mm convection heating element hole \varnothing 5mm rectangular flange		
For models:	XF090P		
accessories for	419142		
	Part No.	550986	Ref. No. GN1280 GN1327A0 GN224
	gasket L 100mm W 22mm 7 holes graphite thickness 1mm for heating element		

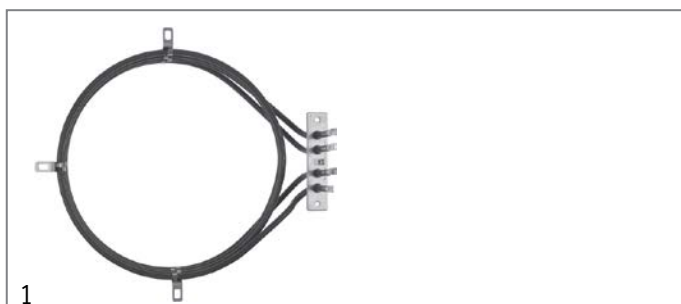

1			
Part No.	419111	Ref. No.	RS076 RS1040A0
description	heating element 4250W 230V heating circuits 2 ID \varnothing 220mm ED \varnothing 235mm L 265mm H 50mm L1 25mm W1 53mm H1 5mm H2 45mm flange length 100mm flange width 22mm hole distance 87mm connection male faston 6.3mm tube \varnothing 6.3mm		
For models:	XB403, XB403G, XB603, XB603G, XBT160, XF188, XV301, XV301E, XV401E		
accessories for	419111		
	Part No.	550986	Ref. No. GN1280 GN1327A0 GN224
	gasket L 100mm W 22mm 7 holes graphite thickness 1mm for heating element		

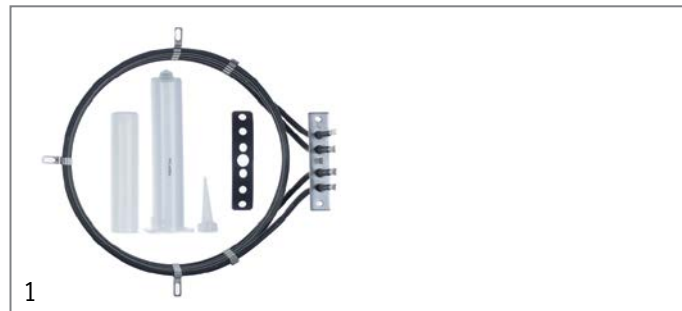

1			
Part No.	418906	Ref. No.	KRS012 KRS1040A
description	heating element 4250W 230V heating circuits 2 ID \varnothing 220mm ED \varnothing 235mm L 265mm H 50mm L1 25mm W1 53mm H1 5mm H2 45mm flange length 100mm flange width 22mm hole distance 87mm connection male faston 6.3mm tube \varnothing 6.3mm with gasket and silicone		



1			
Part No.	420417	Ref. No.	RS1115A0
description	heating element 4350W 230V heating circuits 2 ID \varnothing 224mm ED \varnothing 235mm L 270mm H 65mm L1 25mm W1 60mm H1 12mm H2 55mm flange length 100mm flange width 22mm hole distance 86mm connection Faston 6.3mm connection length 60mm tube \varnothing 6.3mm convection heating element hole \varnothing 5mm rectangular flange		

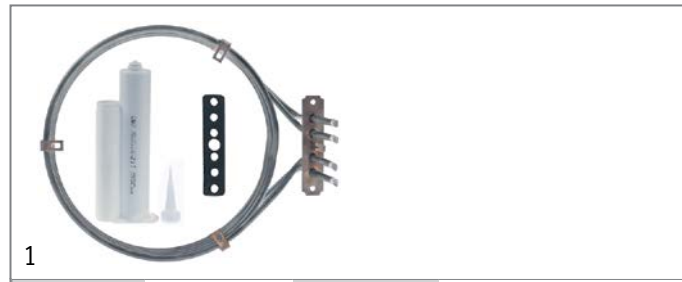

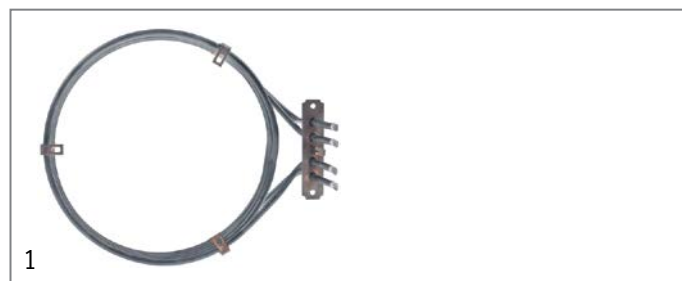

1			
Part No.	420416	Ref. No.	KRS1115A
description	heating element 4350W 230V heating circuits 2 ID \varnothing 224mm ED \varnothing 235mm L 270mm H 65mm L1 25mm W1 60mm H1 12mm H2 55mm flange length 100mm flange width 22mm hole distance 86mm connection Faston 6.3mm connection length 60mm tube \varnothing 6.3mm convection heating element hole \varnothing 5mm rectangular flange with gasket and silicone		





1			
Part No.	420414	Ref. No.	RS085A
description	heating element 4400W 225V heating circuits 2 ID \varnothing 224mm ED \varnothing 235mm L 270mm H 55mm L1 25mm W1 60mm H1 12mm H2 45mm flange length 100mm flange width 22mm hole distance 86mm connection Faston 6.3mm connection length 60mm tube \varnothing 6.3mm convection heating element hole \varnothing 5mm rectangular flange		





			
1			
Part No.	420399	Ref. No.	KRS0085A KRS010
description	heating element 4400W 225V heating circuits 2 ID \varnothing 224mm ED \varnothing 235mm L 270mm H 65mm L1 25mm W1 60mm H1 12mm H2 55mm flange length 100mm flange width 22mm hole distance 86mm connection Faston 6.3mm connection length 60mm tube \varnothing 6.3mm convection heating element hole \varnothing 5mm rectangular flange with gasket and silicone		

			
1			
Part No.	417556	Ref. No.	KRS032 KRS1150A
description	heating element 4900W 230V heating circuits 2 ID \varnothing 224mm ED \varnothing 235mm L 270mm H 70mm L1 30mm W1 60mm H1 12mm H2 60mm flange length 100mm flange width 22mm hole distance 86mm connection Faston 6.3mm connection length 85mm tube \varnothing 6.3mm convection heating element hole \varnothing 5mm rectangular flange with gasket and silicone		

			
1			
Part No.	417551	Ref. No.	RS1225A
description	heating element 4700W 230V heating circuits 3 ID \varnothing 224mm ED \varnothing 235mm L 270mm H 97mm L1 15mm W1 103mm H1 15mm H2 85mm flange length 148mm flange width 31mm hole distance 17mm connection Faston 6.3mm connection length 85mm tube \varnothing 6.3mm convection heating element hole \varnothing 4.5mm rectangular flange		
For models:	XBC405E, XBC605E, XBC805E, XVC055E, XVC105E, XVC105EP, XVC205E, XVC505E, XVC505EP		
accessories for	417551		
	Part No.	531259	Ref. No. GN1085A KGN1085A
	gasket L 141mm W 22mm D1 \varnothing 8mm D2 \varnothing 9mm 9 holes graphite thickness 1mm suitable for UNOX		

			
1			
Part No.	417557	Ref. No.	RS1150A0
description	heating element 4900W 230V heating circuits 2 ID \varnothing 224mm ED \varnothing 235mm L 270mm H 75mm L1 30mm W1 60mm H1 12mm H2 60mm flange length 100mm flange width 22mm hole distance 86mm connection Faston 6.3mm connection length 65mm tube \varnothing 6.3mm convection heating element hole \varnothing 5mm rectangular flange		
For models:	XB693, XB695, XB893, XB895, XBC404, XBC604, XBC804, XF043, XV593, XVC204, XVC304, XVC504, XVC704		

			
1			
Part No.	417550	Ref. No.	KRS1225A
description	heating element 4700W 230V heating circuits 3 ID \varnothing 224mm ED \varnothing 235mm L 270mm H 97mm L1 15mm W1 103mm H1 15mm H2 85mm flange length 148mm flange width 31mm hole distance 17mm connection Faston 6.3mm connection length 85mm tube \varnothing 6.3mm convection heating element hole \varnothing 4.5mm rectangular flange with gasket and silicone		

			
1			
Part No.	419144	Ref. No.	RS1000A0 RS1050A0
description	heating element 5000W 230V heating circuits 2 ID \varnothing 223mm ED \varnothing 236mm L 265mm H 65mm L1 25mm W1 55/25mm H1 6mm H2 59mm flange length 100mm flange width 22mm hole distance 86mm connection male faston 6.3mm tube \varnothing 6.5mm hole \varnothing 5mm		
For models:	XB803, XB803G, XBT146, XV203G, XV303G, XV703G, XVT203G		
accessories for	419144		
	Part No.	550986	Ref. No. GN1280 GN1327A0 GN224
	gasket L 100mm W 22mm 7 holes graphite thickness 1mm for heating element		

1

Part No.	419017	Ref. No.	KRS013 KRS1050A
description	heating element 5000W 230V heating circuits 2 ID \varnothing 223mm ED \varnothing 236mm L 265mm H 65mm L1 25mm W1 55/25mm H1 6mm H2 59mm flange length 100mm flange width 22mm hole distance 86mm connection male faston 6.3mm tube \varnothing 6.5mm hole \varnothing 5mm with gasket and silicone		
spare parts for	419017		
	Part No.	550986	Ref. No. GN1280 GN1327A0 GN224
	gasket L 100mm W 22mm 7 holes graphite thickness 1mm for heating element		



1

Part No.	417553	Ref. No.	RS1205A0
description	heating element 5600W 230V heating circuits 3 ID \varnothing 224mm ED \varnothing 235mm L 270mm H 97mm L1 15mm W1 103mm H1 15mm H2 85mm flange length 148mm flange width 31mm hole distance 17mm connection Faston 6.3mm connection length 85mm tube \varnothing 6.3mm convection heating element hole \varnothing 4.5mm rectangular flange		
For models:	XBC1005, XVC1005P, XVC305, XVC705, XVC905P		



1

Part No.	417552	Ref. No.	KRS1205A
description	heating element 5600W 230V heating circuits 3 ID \varnothing 224mm ED \varnothing 235mm L 270mm H 97mm L1 15mm W1 103mm H1 15mm H2 85mm flange length 148mm flange width 31mm hole distance 17mm connection Faston 6.3mm connection length 85mm tube \varnothing 6.3mm convection heating element hole \varnothing 4.5mm rectangular flange with gasket and silicone		



1

Part No.	417560	Ref. No.	KRS1180A
description	heating element 9000W 230V heating circuits 3 ID \varnothing 220mm ED \varnothing 238mm L 282mm H 100mm L1 30mm W1 104mm H1 10mm H2 85mm flange length 147mm flange width 31mm hole distance 62mm connection Faston 6.3mm connection length 85mm tube \varnothing 8.5mm convection heating element hole \varnothing 4.5mm rectangular flange with gasket and silicone		



1

Part No.	417564	Ref. No.	RS1180A0
description	heating element 9000W 230V heating circuits 3 ID \varnothing 220mm ED \varnothing 238mm L 282mm H 100mm L1 30mm W1 104mm H1 10mm H2 85mm flange length 147mm flange width 31mm hole distance 63mm connection Faston 6.3mm connection length 85mm tube \varnothing 8.5mm convection heating element hole \varnothing 4.5mm rectangular flange		
For models:	XVC1004P, XVC1204P		



1

Part No.	417555	Ref. No.	KRS1020A RS1020A0
description	heating element 9000W 230V heating circuits 3 ID \varnothing 240mm ED \varnothing 257mm L 300mm H 100mm L1 38mm W1 104mm H1 8.5mm H2 85mm flange length 142mm flange width 25mm hole distance 126mm connection Faston 6.3mm connection length 85mm tube \varnothing 8.5mm convection heating element hole \varnothing 6.2mm rectangular flange INCOLOY-800		
For models:	XV1003G		



1

Part No.	417547	Ref. No.	KRS1100A RS1100A0
description	heating element 90W 110V heating circuits 1 L 155mm W 31mm flange length 70mm flange width 22mm hole distance 56mm connection length 32mm connection male faston 6.3mm tube \varnothing 6.35mm hole \varnothing 5mm rectangular flange dry heating element		
For models:	XC595		



radiation heaters

square



1

Part No.	417723	Ref. No.	KRS1235A RS0125A
description	radiation heater L 225mm W 225mm 500W 230V heating circuits 1 connections 2 connection type porcelain terminals		



1

Part No.	417722	Ref. No.	KRS1258A RS1005A
description	radiation heater L 225mm W 225mm 750W 230V heating circuits 1 connections 2 connection type porcelain terminals		
For models:	XP010E, XP010ER, XP010ET		

energy regulators

EGO

1-circuit



1

Part No.	380019	Ref. No.	KVE009 VE023
description	energy regulator 240V 13A single-circuit turn direction right shaft \varnothing 6x4.6mm shaft L 23mm mounting thread M4 power release 6-100% no. 50.57071.010		



1

Part No.	381243	Ref. No.	EX-VE023 KVE1556A
description	energy regulator 240V 13A single-circuit turn direction right shaft \varnothing 6x4.6mm shaft L 23mm power release 6-100% with knob set		
For models:	XB1083, XB613G, XB693, XB813G, XB893, XF030, XF040, XF050, XF065, XV1093, XV201, XV202, XV301, XV393, XV401, XV501, XV513G, XV593, XV813G, XV893		

thermostats

control and safety thermostats

EGO

control thermostats

55.10/19_ series



1

Part No.	390982	Ref. No.	KTR1141A TR022
description	thermostat 1NO probe \varnothing 3.9mm probe L 127mm capillary pipe 1500mm shaft \varnothing 6mm shaft L 23mm rotation 270°		
For models:	XL041, XL051, XL091, XL503		

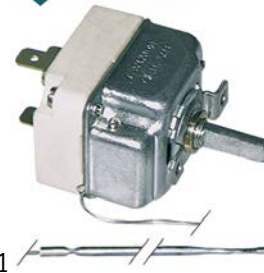

1

Part No.	390943	Ref. No.	KTR1100A TR1100A0
description	thermostat t.max. 269°C 1-pole 1NO 16A probe \varnothing 3mm probe L 225mm capillary pipe 900mm capillary pipe isolated 800mm gland nut shaft \varnothing 6x4.6mm shaft L 23mm shaft position upper rotation 270°		
For models:	XB693, XB893, XV593		



 			
Part No.	375894	Ref. No.	KTR001 KTR009 KTR012 KTR1130A TR006
description	thermostat t.max. 293°C temperature range 55-293°C 1-pole 1N0 16A probe ø 3.1mm probe L 226mm capillary pipe 870mm capillary pipe isolated 350mm gland nut shaft ø 4.0-6.0mm shaft L 23mm rotation 270°		
For models:	XF003, XF006, XF011, XF016, XF023, XF030, XF030-TG, XF043, XF065, XF090P, XF113, XF133, XF183, XF193, XV202, XV301, XV401, XV501		

 			
Part No.	376024	Ref. No.	KTR006 KTR1131A TR016 TR017
description	thermostat t.max. 355°C temperature range 60-355°C 1-pole 1N0 16A probe ø 4mm probe L 228mm capillary pipe 900mm capillary pipe isolated 600mm gland nut shaft ø 6x4.6mm shaft L 23mm shaft position upper rotation°		
For models:	XP010P, XP010PR, XP010PT, XP010R, XP020, XP020P, XP020PR, XP020PT, XP020R, XP020T, XP250		

safety thermostats			
55.32_ series			
 			
Part No.	390999	Ref. No.	KTR1140A TR007 TR008
description	safety thermostat switch-off temp. 350°C temperature range°C 2-pole NC 20A probe ø 3mm probe L 187mm capillary pipe 690mm capillary pipe isolated 680mm gland nut shaft ømm probe SS		
For models:	XF010, XF020, XF020R, XF030, XF040, XF043, XF050, XF065, XFT110, XFT113, XFT115, XFT119, XFT130, XFT133, XFT135, XFT140, XFT180, XFT183, XFT185, XV201		

CAEM			
safety thermostats			
			
Part No.	375456	Ref. No.	KTR1134A KTR254 TR240 TR250
description	safety thermostat switch-off temp. 335°C 2-pole 20A probe ø 3mm probe L 200mm capillary pipe 1050mm capillary pipe isolated 650mm gland nut probe SS at 250V 20A at 400V 10A		
For models:	XCH030, XF003, XF006, XF010, XF011, XF016, XF020, XF020R, XF023, XF030, XF030-TG, XF040, XF043, XF050, XF065, XF090P, XF100, XF103, XF110, XF113, XF115, XF119, XF130, XF133, XF135, XF183, XP010P, XP010PR, XP010PT, XP010R, XP020, XP020P, XP020PR, XP020PT, XP020R, XP020T, XV201, XV202, XV202E, XV301, XV301E, XV401, XV401E, XV501, XV501E, XVC054, XVC104		

CAMPINI			
safety thermostats			
			
Part No.	376080	Ref. No.	KTR1136A TR255B
description	safety thermostat kit switch-off temp. 318°C 1-pole 16A probe ø 3mm probe L 137mm capillary pipe 1260mm capillary pipe isolated 710mm gland nut probe SS type Ty 95-H		
For models:	XB403, XB403G, XB603, XB603G, XB803, XB803G, XBC404, XBC604, XBC605, XBC804, XBC805, XBC815G, XBT146, XBT160, XF185, XF188, XF190, XF193, XF195, XG413G, XG613, XG613G, XG813, XV1003G, XV203G, XV303G, XV703G, XVC1004P, XVC105, XVC1204P, XVC204, XVC304, XVC305, XVC504, XVC505, XVC514G, XVC515G, XVC704, XVC705, XVC715G, XVT203G		



switches and momentary switches

push/momentary push switches

20.6x16.4mm



1

Part No.	301306	Ref. No.	KVE0106A VE0106A0
description	momentary push switch mounting ø 20.6x16.4mm silver 1NO 250V 16A connection male faston 6.3mm reset ambient temperature max. 150°C protection IP40		



1

Part No.	348186	Ref. No.	KVE0108A
description	push switch 2NO		

microswitches

pin-plunger actuated

M10



1

Part No.	347945 ¹	Ref. No.	KVE1295A MF09 VE086 VE086B
description	microswitch with plunger thread M10x0.75 thread L 13mm 250V 5A 1CO connection male faston 6.3mm stroke 6mm mounting distance 25mm L 49mm L1 13mm ambient temperature max. 85°C IP65 type MKH12D09 actuating force: 340g		
For models:	XF043, XF090P, XF100, XF110, XF115, XF130, XF135, XF183, XF185, XF188, XF190, XF193, XF195, XV201, XV202, XV202E, XV301, XV301E, XV401, XV401E, XV501, XV501E, XVC054, XVC104		

¹protection class IP65

system switches (ROLD)



1

Part No.	345627	Ref. No.	VE1170A0
description	element holder mounting measurements 20.6x16.4mm black arched for push buttons 13x17mm		
For models:	XF003, XF103, XF113, XF133, XF183, XF193, XP010P, XP010PR, XP010PT, XP020, XP020P, XP020PR, XP020PT, XP020R, XP020T, XV593		



1

Part No.	345537	Ref. No.	VE161
description	element holder mounting measurements 20.6x16.4mm grey arched for push buttons 13x17mm		
For models:	XC110, XF006, XF011, XF016, XF030, XF030-TG, XF065, XF090P, XG413, XG413G, XG613, XG613G, XG813, XG813G, XL041, XL051, XL091, XL503, XP010P, XP010PR, XP010PT, XP010R, XP020, XP020P, XP020PR, XP020PT, XP020R, XP020T, XT010, XT020, XV202, XV301, XV401, XV501		



1

Part No.	357224	Ref. No.	KVM2009A VM2009A0
description	element holder mounting measurements 20.6x16.4mm silver arched for push buttons 13x17mm		
For models:	XB693, XB893		



1

Part No.	345601	Ref. No.	KVM1762A VE162 VM1762A0
description	indicator lamp holder V ø 11mm		
For models:	XB1083, XB613G, XB693, XB813G, XB893, XC110, XF003, XF006, XF011, XF016, XF030, XF030-TG, XF065, XF090P, XF103, XF113, XF133, XF183, XF193, XFT113, XFT133, XFT183, XFT193, XG413, XG413G, XG613, XG613G, XG813, XG813G, XL041, XL051, XL091, XL413, XL503, XP010E, XP010ER, XP010ET, XP010P, XP010PR, XP010PT, XP010R, XP020, XP020E, XP020ER, XP020ET, XP020P, XP020PR, XP020PT, XP020R, XP020T...(Other models you can see in the webshop)		



1

Part No.	301308	Ref. No.	KVE0007A
description	indicator lamps set 230V green/white connection male faston 6.3mm mounting measurements 20.6x16.4mm		

1

Part No.	301307	Ref. No.	KLP1014A
description	indicator lamps set 230V white connection male faston 6.3mm mounting measurements 20.6x16.4mm		



1

Part No.	357120	Ref. No.	KVE008
description	indicator lamps set mounting measurements 20.6x16.4mm 230V		





1

Part No.	357012	Ref. No.	KVE007
description	indicator lamps set mounting measurements 20.6x16.4mm green 230V connection male faston 6.3mm ø 20.6x16.4mm socket male faston 6.3mm		



1

Part No.	360598	Ref. No.	KVE1535A VE1535A0 VE177
description	indicator light LED white connection male faston 6.3mm 250V ø 11mm voltage AC		
For models:	XB693, XB893, XC110, XF003, XF006, XF011, XF016, XF030, XF030-TG, XF065, XF090P, XF103, XF113, XF133, XF183, XF193, XG413, XG413G, XG613, XG613G, XG813, XG813G, XL041, XL051, XL091, XL503, XP010P, XP010PR, XP010PT, XP010R, XP020, XP020P, XP020PR, XP020PT, XP020R, XP020T, XV202, XV301, XV401, XV501, XV593		
accessories for	360598		
	Part No.	345601	Ref. No. KVM1762A VE162 VM1762A VM1762A0
indicator lamp holder V ø 11mm			



1

Part No.	357223	Ref. No.	VE1585A0
description	indicator light lens size 17x13mm blue Sinus gold		
For models:	XB693, XB893, XV593		



1

Part No.	357226	Ref. No.	VE1530A0
description	indicator light lens size 17x13mm blue thermometer gold		
For models:	XB693, XB893, XP010P, XP010PR, XP010PT, XP020, XP020P, XP020PR, XP020PT, XP020R, XP020T, XV593		



1

Part No.	346811	Ref. No.	VE163
description	indicator light lens size 17x13mm green		
For models:	XC110, XF065		



1

Part No.	347749	Ref. No.	VE167
description	indicator light lens size 17x13mm green crossed out flame gold		
For models:	XG413, XG413G, XG613, XG613G, XG813, XG813G		



1

Part No.	347748	Ref. No.	VE165
description	indicator light lens size 17x13mm green Sinus gold		
For models:	XF011, XF030, XF030-TG, XF065, XF090P, XV202, XV301, XV401, XV501		



1

Part No.	347747	Ref. No.	VE166
description	indicator light lens size 17x13mm green steam gold		
For models:	XF090P, XV202, XV301, XV401, XV501		



1

Part No.	347746	Ref. No.	VE164
description	indicator light lens size 17x13mm green thermometer gold		
For models:	XF003, XF006, XF011, XF016, XF030, XF030-TG, XF065, XF090P, XF103, XF113, XF133, XF183, XF193, XL041, XL051, XL091, XL503, XP010P, XP010PR, XP010PT, XP010R, XP020, XP020P, XP020PR, XP020PT, XP020R, XP020T, XV202, XV301, XV401, XV501		



			
1			
Part No.	347193	Ref. No.	VE169
description	momentary switch unit 1NO 250V 16A connection male faston 6.3mm		
For models:	XF090P, XF113, XF133, XG413, XG413G, XG613, XG613G, XG813, XG813G, XL041, XL091, XL503		

			
1			
Part No.	347751	Ref. No.	VE176
description	push button size 17x13mm silver 0-l gold		
For models:	XC110, XL041, XL051, XL091, XL503, XP010P, XP010PR, XP010PT, XP010R, XP020, XP020P, XP020PR, XP020PT, XP020R, XP020T, XT010, XT020		

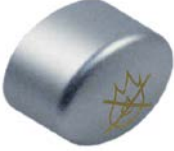
			
1			
Part No.	347752	Ref. No.	VE174
description	push button size 17x13mm silver crossed out flame gold		
For models:	XG413, XG413G, XG613, XG613G, XG813, XG813G		

			
1			
Part No.	348032	Ref. No.	KVM2007A VM2007A0
description	push button size 17x13mm silver fan speed black		
For models:	XB693, XB893, XV593		

			
1			
Part No.	347750	Ref. No.	VE175
description	push button size 17x13mm silver steam gold		
For models:	XF090P, XF113, XF133, XL041, XL091, XL503		

			
1			
Part No.	345720	Ref. No.	VE168
description	switch 2NO 250V 16A connection male faston 6.3mm		
For models:	XC110, XL041, XL051, XL091, XL503, XP010P, XP010PR, XP010PT, XP010R, XP020, XP020P, XP020PR, XP020PT, XP020R, XP020T, XT010, XT020		



cam switches

operation switches

			
1			
Part No.	300251	Ref. No.	KVE0024A VE024
description	cam switch 6 operating positions 2NO/1CO 16A sequence 0-1-2-3-4-5 shaft ø 6x4.6mm shaft L 24mm connection male faston 6.3mm plastic 3-pole		
For models:	XF030, XF040, XF050, XF065		

magnetic switches

M10x0.75

			
1			
Part No.	348006	Ref. No.	KVE002 KVE1020A KVE1020B VE1020A0 VE1020A1
description	Read switch kit thread M10x0.75 1NO 250V 0.04A connection male faston 6.3mm cable length 1200mm type D10P 1V DA F 120 with magnet		
For models:	XB403, XB403G, XB603, XB603G, XB803, XB803G, XBC1005, XBC404, XBC604, XBC605, XBC804, XBC805, XBC815G, XBT146, XBT160, XG413, XG413G, XG613, XG613G, XG813, XG813G, XK304, XV1003G, XV203G, XV303G, XV703G, XVC1004P, XVC1005P, XVC1015G, XVC1204P, XVC2015G, XVC204, XVC205, XVC304, XVC305, XVC315G, XVC504, XVC505, XVC514G, XVC515G, XVC704, XVC705, XVC715G, XVC905P, XVT203G		
spare parts for	348006		
	Part No.	348005	Ref. No. —
	magnetic switch thread M10x0.75 1NO 250V 0.04A P max. 10W connection male faston 6.3mm cable length 1200mm type D10P 1V DA F 120		



accessories

magnets



1

Part No.	348007	Ref. No.	VE1030A1
description	magnet ø 23mm Lmm H 10mm Wmm ID ø 4.5mm ED ø 23mm M3 hole ø 4.5mm		
For models:	XB403, XB403G, XB603, XB603G, XB803, XB803G, XB895, XBC1005, XBC404, XBC604, XBC605, XBC804, XBC805, XBC815G, XBT146, XBT160, XG413G, XG613, XG613G, XG813, XV1003G, XV203G, XV303G, XV703G, XVC1004P, XVC1005P, XVC1015G, XVC1204P, XVC2015G, XVC204, XVC205, XVC304, XVC305, XVC315G, XVC504, XVC505, XVC514G, XVC515G, XVC704, XVC705, XVC715G, XVC905P		

lamps

indicator lights

indicator lights (complete)

20.6x16.4mm



1

Part No.	348031	Ref. No.	KLP1012A
description	indicator light mounting measurements 20.6x16.4mm blue 230V connection male faston 6.3mm oval Qty 2 temp.-resist. 150°C temperature		

miscellaneous



1

Part No.	301308	Ref. No.	KVE0007A
description	indicator lamps set 230V green/white connection male faston 6.3mm mounting measurements 20.6x16.4mm		



1

Part No.	301307	Ref. No.	KLP1014A
description	indicator lamps set 230V white connection male faston 6.3mm mounting measurements 20.6x16.4mm		



1

Part No.	357120	Ref. No.	KVE008
description	indicator lamps set mounting measurements 20.6x16.4mm 230V		



1

Part No.	357012	Ref. No.	KVE007
description	indicator lamps set mounting measurements 20.6x16.4mm green 230V connection male faston 6.3mm ø 20.6x16.4mm socket male faston 6.3mm		

LED

LED bars



1

Part No.	357231	Ref. No.	KLP1001B
description	LED bar L 300mm W 18mm H 19mm		
For models:	XBC405E, XVC305E, XVC305EP, XVC315EG		

screw-on/push-on fit

halogen lamp

for socket G4 / G6.35 / G9



1

Part No.	359946	Ref. No.	VE1005A1
description	halogen lamp socket G9 230V 40W temp.-resist. 300°C		
For models:	XB403, XB403G, XB603, XB603G, XB803, XB803G, XBC404, XBC604, XBC804, XBT146, XBT160, XF100, XF110, XF113, XF119, XF130, XF135, XF183, XF185, XF188, XF190, XF193, XF195, XG413G, XG613G, XG813, XV1003G, XV203G, XV303G, XV703G, XVC054, XVC104, XVC204, XVC304, XVC504, XVC704		



oven lamps

universal oven lamps

mounting diameter 35.5mm





1

Part No.	357119	Ref. No.	KVE028 VE030
description	oven lamp mounting ø 35.5mm 230V 15W socket E14 round temp.-resist. 300°C no lens nipple		
For models:	XF010, XF011, XF020, XF020R, XF030, XF030-TG, XF040, XF050, XF065, XF090P, XF103, XV202, XV202E, XV301, XV301E, XV401, XV401E, XV501, XV501E		



1

Part No.	359718	Ref. No.	KLP0030A
description	oven lamp mounting ø 35.5mm 230V 15W socket E14 temp.-resist. 300°C connection male faston 6.3mm hard glas		
spare parts for	359718		
	Part No.	359701	Ref. No. VE1015
	lamp socket socket E14 220-230V mounting ø 35.5mm connection male faston 6.3mm 15W		
	Part No.	359740	Ref. No. —
	light bulb t.max. 300°C socket E14 15W 230V ø 22mm L 48mm lens L 20mm for oven lamp IMPORT		







1

Part No.	360753	Ref. No.	KVE1480A KVT1235A VT1200A
description	oven lamp mounting ø 35mm 230V 25W socket G9		



1

Part No.	359701	Ref. No.	VE1015
description	lamp socket socket E14 220-230V mounting ø 35.5mm connection male faston 6.3mm 15W		
accessories for	359701		
	Part No.	359705	Ref. No. VE1010A1
	oven lamp glass thr.ø 33.5mm ø 52mm hard glas temp.-resist. 350°C		
	Part No.	359709	Ref. No. VE036
	oven lamp glass thr.ø 33.5mm ø 42mm hard glas temp.-resist. 350°C		

accessories for	359701		
	Part No.	359721	Ref. No. —
	gasket silicone ED ø 48mm ID ø 39.5mm thickness 5mm Qty 1 pcs		
	Part No.	359942	Ref. No. —
	oven lamp glass thr.ø 33.5mm ø 41mm hard glas temp.-resist. 350°C		



1

Part No.	357160	Ref. No.	KVE1015A VE1015A0 VE1015A1
description	lamp socket socket G9 220-230V mounting ø 35.5mm connection cable 100mm		
For models:	XB403, XB403G, XB603, XB603G, XB693, XB695, XB803, XB803G, XB893, XB895, XBC404, XBC604, XBC804, XBT146, XBT160, XF100, XF110, XF113, XF115, XF119, XF130, XF133, XF135, XF183, XF185, XF188, XF190, XF193, XF195, XG413, XG413G, XG613, XG613G, XG813, XG813G, XV1003G, XV203G, XV303G, XV593, XV703G, XVC054, XVC104, XVC1204P, XVC204, XVC304, XVC504, XVC514G, XVC704, XVT203G		







1

Part No.	359709	Ref. No.	VE036
description	oven lamp glass thr.ø 33.5mm ø 42mm hard glas temp.-resist. 350°C		
For models:	XF010, XF020, XF020R, XF030, XF040, XF050, XF065, XF183, XF193, XV201		



1





Part No.	359705	Ref. No.	VE1010A1
description	oven lamp glass thr.ø 33.5mm ø 52mm hard glas temp.-resist. 350°C		
For models:	XB603, XBC404, XBC604, XBC804, XF090P, XF113, XG813, XV1003G, XVC304, XVC504, XVC514G		

accessories for	359705		
	Part No.	359610	Ref. No. —
	light bulb t.max. 300°C socket E14 15W 230V ø 22mm L 47mm lens L 20mm for oven lamp type Philips		
	Part No.	359700	Ref. No. —
	gasket for pizza oven fibre glass ID ø 32.5mm ED ø 55mm thickness 5mm		
	Part No.	359721	Ref. No. —
	gasket silicone ED ø 48mm ID ø 39.5mm thickness 5mm Qty 1 pcs		
	Part No.	359837	Ref. No. —
	gasket ID ø 33mm ED ø 46mm thickness 1mm graphite		
	Part No.	359838	Ref. No. —
	gasket ID ø 33mm ED ø 45mm		



			
1			
Part No.	358135 ¹	Ref. No.	GN1065+GN1055 GN1065A GN1065A1 KGN1065A KGN1065A1
description	gasket for oven lamp PTFE ID ø 44mm ED ø 53mm thickness 3mm with silicone O-ring		
For models:	XB603, XB613G, XB693, XB695, XB813G, XB893, XB895, XBC404, XBC604, XBC804, XBC815G, XF113, XF119, XF133, XF135, XFT110, XFT113, XFT115, XFT119, XFT130, XFT133, XFT135, XFT140, XFT180, XFT183, XFT185, XFT188, XFT190, XFT193, XFT195, XFT199, XFT200, XG413G, XG813, XV1003G, XV393, XV513G, XV593, XV813G, XV893, XVC054, XVC104, XVC1204P, XVC204, XVC304, XVC504, XVC514G, XVC704		

¹with silicone O-ring

			
1			
Part No.	358191	Ref. No.	KVE1005A
description	repair kit ID ø 44mm ED ø 53mm thickness 3mm for oven lamp		
For models:	XB613G, XB693, XB695, XB813G, XB893, XB895, XFT110, XFT113, XFT115, XFT119, XFT130, XFT133, XFT135, XFT140, XFT180, XFT183, XFT185, XFT188, XFT190, XFT193, XFT195, XFT199, XFT200, XV393, XV513G, XV593, XV813G, XV893		
spare parts for	358191		
	Part No.	357195	Ref. No. —
	halogen lamp socket G9 230V 25W temp.-resist. 300°C OSRAM HALOPIN OVEN		
	Part No.	358135	Ref. No.
	gasket for oven lamp PTFE ID ø 44mm ED ø 53mm thickness 3mm with silicone O-ring		





			
1			
Part No.	358136	Ref. No.	GN1005 KVE005 KVT1195A VE1010A0
description	repair kit ø 35.5mm for oven lamp		
For models:	XB403, XB403G, XB603, XB603G, XB803, XB803G, XBT146, XBT160, XF100, XF110, XF115, XF119, XF130, XF135, XF185, XF188, XF190, XF195, XG413, XG413G, XG613, XG613G, XG813, XG813G, XV1003G, XV203G, XV303G, XV703G, XVC054, XVC1004P, XVC104, XVC204, XVC304, XVC504, XVC704, XVT203G		

lamps

halogen lamps

for socket G4 / G6.35 / G9

			
1			
Part No.	359946	Ref. No.	VE1005A1
description	halogen lamp socket G9 230V 40W temp.-resist. 300°C		
For models:	XB403, XB403G, XB603, XB603G, XB803, XB803G, XBC404, XBC604, XBC804, XBT146, XBT160, XF100, XF110, XF113, XF119, XF130, XF135, XF183, XF185, XF188, XF190, XF193, XF195, XG413G, XG613G, XG813, XV1003G, XV203G, XV303G, XV703G, XVC054, XVC104, XVC204, XVC304, XVC504, XVC704		

			
1			
Part No.	358191	Ref. No.	KVE1005A
description	repair kit ID ø 44mm ED ø 53mm thickness 3mm for oven lamp		
For models:	XB613G, XB693, XB695, XB813G, XB893, XB895, XFT110, XFT113, XFT115, XFT119, XFT130, XFT133, XFT135, XFT140, XFT180, XFT183, XFT185, XFT188, XFT190, XFT193, XFT195, XFT199, XFT200, XV393, XV513G, XV593, XV813G, XV893		
spare parts for	358191		
	Part No.	357195	Ref. No. —
	halogen lamp socket G9 230V 25W temp.-resist. 300°C OSRAM HALOPIN OVEN		
	Part No.	358135	Ref. No.
	gasket for oven lamp PTFE ID ø 44mm ED ø 53mm thickness 3mm with silicone O-ring		

timers

programme timers

			
1			
Part No.	360703	Ref. No.	KVE1555A
description	timer CDC 8802F1 engines 1 chambers 2 operation time 4min 230V 50Hz shaft ømm shaft Lmm manuf. no. 8802F10AGE000.0010 motor type M48R 230V		

			
1			
Part No.	360413	Ref. No.	KVE1555A KVN032
description	timer FIBER P19 engines 1 chambers 2 operation time 4min 230V 50Hz shaft ømm shaft Lmm		
For models:	XF043, XF090P, XF193, XV202, XV301, XV401, XV501, XV501E		



mechanical timers



1

Part No.	350134 ¹	Ref. No.	KTM001 KTM0023A
description	time switch kit M2 2-pole operation time 120min impulse mechanical 2CO at 250V 16A permanent position yes shaft ø 6x4.6mm shaft 6x4.6mm shaft L 22mm mounting distance 28mm ambient temperature max. 125°C with knob		

¹incl. knob and symbol

1

Part No.	350184	Ref. No.	KTM003
description	timer M2 2-pole operation time 120min impulse mechanical 2CO at 250V 16A permanent position yes shaft ø 6x4.6mm shaft 6x4.6mm shaft L 23mm mounting distance 28mm		



1

Part No.	350186	Ref. No.	MIN042 TM023
description	timer M2 2-pole operation time 120min impulse mechanical 2CO at 250V 16A permanent position yes shaft ø 6x4.6mm shaft 6x4.6mm shaft L 23mm mounting distance 28mm		
For models:	XF006, XF011, XF016, XF030, XF030-TG, XF090P, XF103, XF113, XF133, XF183, XF193		
accessories for	350186		
	Part No.	112627	Ref. No. MN1000A + MN1050A MN1000AO
	knob time 120min ø 58mm shaft ø 6x4.6mm shaft flat lower		



1

Part No.	350185 ¹	Ref. No.	KTM005
description	timer M2 2-pole operation time 60min impulse mechanical 2CO at 250V 16A permanent position yes shaft 6x4.6mm shaft L 23mm mounting distance 28mm		

¹incl. knob

1

Part No.	350187	Ref. No.	KTM004 KTM005 KTM1005A TM1005AO
description	timer M2 2-pole operation time 60min impulse mechanical 2CO at 250V 16A permanent position yes shaft ø 6x4.6mm shaft 6x4.6mm shaft L 23mm mounting distance 28mm		
For models:	XB1083, XB613G, XB693, XB813G, XB893, XF003, XF023, XF043, XF113, XF133, XFT113, XFT133, XFT183, XFT193, XV1093, XV393, XV513G, XV593, XV813G, XV893		

alarm devices

buzzer boards



1

Part No.	401062	Ref. No.	KTM0012B
description	buzzer board 230VAC L 48mm W 45mm connection Faston 6.3mm		



1

Part No.	403761	Ref. No.	VE1070A VE1070AO
description	buzzer board 230VAC L 54mm W 31mm connection Faston 6.3mm suitable for UNOX		
For models:	XG413, XG413G, XG613, XG613G, XG813, XG813G		



1

Part No.	350210	Ref. No.	KTM1001C TM1001CO
description	buzzer board L 54mm W 48mm connection male faston 6.3mm		



contactors

GENERAL ELECTRIC (AEG)

power contactors



1			
Part No.	381242	Ref. No.	KVE1115A VE1115A0
description	power contactor resistive load 20A 230VAC (AC3/400V) 8.4A/4kW main contacts 4NO connection screw connection type AEG LS05 400A type GE MC1A 400A with mounting clips		
For models:	XB1083, XB613G, XB693, XB813G, XB893, XBC1005, XBC1005E, XBC1005EL, XBC1015EG, XBC1015EGL, XBC405E, XBC605, XBC605E, XBC805, XBC805E, XBC905E, XBC905EL, XBC915EG, XBC915EGL, XF043, XF100, XF103, XF110, XF115, XF119, XF130, XF135, XFT110, XFT113, XFT115, XFT119, XFT130, XFT135, XFT140, XFT180, XFT183, XFT185, XFT188, XFT190, XFT193, XFT195, XFT199, XFT200, XV1093, XV393, XV513G, XV593, XV813G, XV893, XVC054...(Other models you can see in the webshop)		



1			
Part No.	381095	Ref. No.	KVE019 KVE1095A VE1095A0
description	power contactor resistive load 25A 230VAC (AC3/400V) 12A/5.5kW main contacts 3NO auxiliary contacts 1NO connection screw connection type AEG type GE CL01A400T6		
For models:	XB403, XB403G, XB603, XB603G, XB693, XB695, XB803, XB803G, XB893, XB895, XBC404, XBC604, XBC804, XBT146, XBT160, XF183, XF185, XF188, XF190, XF193, XF195, XV1003G, XV203G, XV303G, XV593, XV703G, XVC1004P, XVC1204P, XVC204, XVC304, XVC504, XVC704, XVT203G		

SIEMENS

power contactors



1			
Part No.	380526	Ref. No.	VE208
description	power contactor resistive load 20A 230VAC (AC3/400V) 8.4A/4kW main contacts 4NO auxiliary contacts connection screw connection type 3TG10-10-0A2L2		
For models:	XB403, XB403G, XB603, XB603G, XB803, XB803G, XF090P, XV202, XV202E, XV203G, XV301, XV301E, XV303G, XV401, XV401E, XV501, XV501E, XV703G		

miscellaneous

accessories



1			
Part No.	381096	Ref. No.	KVM1075A VM1075A0 VM1075A1
description	clip for contactor		
For models:	XB693, XB695, XB893, XB895, XBC1005, XBC404, XBC604, XBC605, XBC804, XF043, XF119, XF135, XF183, XF185, XF190, XF193, XVC054, XVC1005P, XVC1015G, XVC104, XVC105, XVC1204P, XVC2015G, XVC204, XVC205, XVC304, XVC305, XVC504, XVC505, XVC704, XVC705, XVC905P		

transformers

open transformers

with clamp terminal



1			
Part No.	403470	Ref. No.	KVE1360A VE1360A0
description	transformer primary 120/240VAC secondary 12VAC 60VA secondary 5A connection Faston 6.3mm 50-60Hz		
For models:	XBC1005, XBC605, XBC805, XBC815G, XVC1005P, XVC2015G, XVC205, XVC305, XVC505, XVC705, XVC715G, XVC905P		

encapsulated transformers

PMA



1			
Part No.	379054	Ref. No.	TR102
description	transformer primary 230VAC secondary 12VAC 3VA secondary 0.25A H 40mm L 45mm W 50mm connection screw 50/60Hz type 153/M		



electronic controllers

SHANGFANG

accessories



1

Part No.	379054	Ref. No.	TR102
description	transformer primary 230VAC secondary 12VAC 3VA secondary 0.25A H 40mm L 45mm W 50mm connection screw 50/60Hz type 153/M		

probes

producer-specific probes

probes



1

Part No.	379741	Ref. No.	KTR007 KTR1095A TR1015A0
description	temperature probe kit NTC cable glass fibre probe -40 up to +125°C cable -50 up to +350°C connection coded plug thread probe ø4x-19mm cable length 1m		
For models:	XC314, XC595, XCH030, XF100, XF110, XF115, XF119, XF130, XF135, XF185, XF188, XF190, XF195, XL135, XL195, XL314, XL404		
accessories for	379741		
	Part No.	890034	Ref. No. —
	silicone adhesive TOMABOND TB77 cartridge 80ml anthracite		

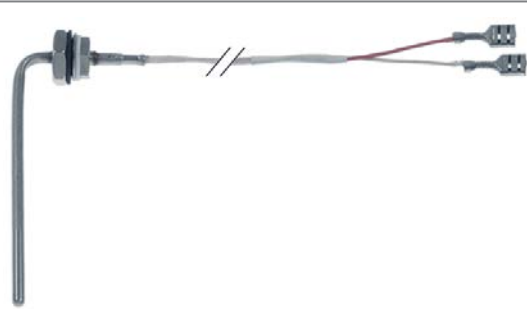

1

Part No.	378543	Ref. No.	KTR004 KTR1005A TR1005/KTR004
description	temperature probe Pt100 cable glass fibre probe -40 up to +350°C cable -40 up to +260°C connection male faston 6.3mm thread M10x1 probe ø4x14-100mm cable length 0.65m		



1

Part No.	378542	Ref. No.	TR0110A TR110
description	temperature probe Pt100 cable PTFE probe -100 up to 450°C cable -40 up to +250°C connection plug thread probe ø3x70mm cable length 1.4m		
For models:	XV202E, XV301E, XV401E, XV501E		



1

Part No.	378372	Ref. No.	KTR005 TR110A
description	temperature probe PTC cable PTFE probe -50 up to +150°C cable -40 up to +250°C connection 2-wire thread probe ø3x70mm cable length 0.15m		
For models:	XB403, XB403G, XB603, XB603G, XB803, XB803G, XG413, XG613, XG813G, XL146, XL504, XL505, XV203G, XV303G, XV703G		

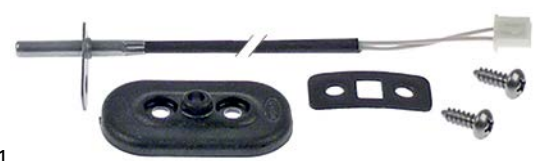

1

Part No.	378374 ¹	Ref. No.	KTR1105A TR1105A0
description	temperature probe PTC cable silicone probe -50 up to +150°C cable -50 up to +180°C connection coded plug thread probe ø4x16mm cable length 1m		
For models:	XBC605, XBC805, XBC815G, XL405, XVC105, XVC205, XVC305, XVC315G, XVC505, XVC515G, XVC705, XVC715G		

¹incl. silicone gasket

1

Part No.	378415	Ref. No.	KTR1110A
description	temperature probe thermocouple K (NiCr-Ni) cable PTFE probe -50 up to 1150°C cable -40 up to +250°C connection plug thread probe ø6x180mm cable length 2m		



Part No.	378660	Ref. No.	KTR1106A
description	temperature probe kit for cavity probe \varnothing 4x25mm cable length 2m flange 20x12mm with mounting kit silicone adhesive C67		
For models:	XBC1005E, XBC1005EL, XBC1015EG, XBC1015EGL, XBC405E, XBC605E, XBC615EG, XBC805E, XBC815EG, XBC905E, XBC905EL, XBC915EG, XBC915EGL, XVC1005EP, XVC1005EPL, XVC1015EG, XVC1015EGL, XVC1205EP, XVC1215EG, XVC2005EP, XVC2015EG, XVC315EG, XVC4005EP, XVC4005EPL, XVC4015EG, XVC4015EGL, XVC515EG, XVC715EG, XVC905EP, XVC905EPL, XVC915EG, XVC915EGL		
spare parts for	378660		
	Part No.	890034	Ref. No. —
	silicone adhesive TOMABOND TB77 cartridge 80ml anthracite		



Part No.	378366	Ref. No.	KTR1045A TR1045A0
description	temperature probe kit NTC cable glass fibre probe -40 up to +125°C cable -50 up to +350°C connection plug thread probe \varnothing 4x19mm cable length 1m		
For models:	XBC404, XBC604, XBC804, XVC054, XVC1004P, XVC104, XVC204, XVC304, XVC504, XVC704		



Part No.	378297	Ref. No.	TR1005A TR1005A0
description	temperature probe kit Pt100 cable glass fibre probe -100 up to 450°C cable -100 up to 450°C connection F6.3 thread M10 probe \varnothing 4x14-100mm cable length 0.65m		
For models:	XBT146, XBT160, XG413, XG413G, XG613, XG613G, XG813, XG813G, XV1003G, XVT203G		



Part No.	378371 ¹	Ref. No.	KTR0110A
description	temperature probe kit Pt100 cable PTFE probe -100 up to 450°C cable -40 up to +250°C connection plug thread probe \varnothing 3x70mm cable length 1.4m		

¹incl. silicone gasket

core probes

Part No.	378417	Ref. No.	KSN1002A SN1002A0
description	core temperature probe Pt100 cable PTFE probe -40 up to +250°C cable -40 up to +250°C connection 5-wire probe \varnothing 4x100mm thread M10 cable length 2m handle \varnothing 12mm handle length 52mm		
For models:	XVC1015G, XVC2015G		

Part No.	379709	Ref. No.	KTR003 KTR1000A TR1000A3 TR123
description	core temperature probe Pt100 cable PTFE probe -40 up to +250°C cable -40 up to +250°C connection male faston 6.3mm probe \varnothing 4x100mm thread M10 cable length 1.4m handle \varnothing 12mm handle length 85mm		
For models:	XB403G, XB603G, XB803G, XCH030, XG413G, XG613G, XG813G, XV203G, XV303G, XV703G, XVT203G		



			
1			
Part No.	378373	Ref. No.	KSN1000A SN1000A0
description	core temperature probe Pt100 cable PTFE probe -40 up to +250°C cable -40 up to +250°C connection plug probe ø4x100mm thread M10 cable length 1.5m handle ø 12mm handle length 52mm		
For models:	XVC315G		

			
1			
Part No.	379705	Ref. No.	KTR1040A TR1040A0 TR1040A1
description	core temperature probe Pt100 cable PVC probe -40 up to +120°C cable -10 up to 100°C connection plug probe ø4x100mm thread M10x1.5 cable length 1.28m		
For models:	XBC404, XVC054, XVC104, XVC105, XVC204, XVC205, XVC304, XVC305		

			
1			
Part No.	378365	Ref. No.	KTR1041A TR1041A2
description	core temperature probe Pt100 cable PVC probe -40 up to +120°C cable -40 up to +120°C connection plug probe ø4x100mm thread M10x1.5 cable length 2m handle length 44mm		

Hall sensors

			
1			
Part No.	403435	Ref. No.	KPE1710A KPE1710B PE1710A1
description	Hall sensor L 38mm W 8mm H 4mm mounting distance 34mm cable length 1000mm		
For models:	XVC1015G, XVC315G		

accessories

fasteners

			
1			
Part No.	378418	Ref. No.	VI1515A1
description	bracket for core temperature probe L 30mm W 30mm H 15mm SS 18/10		
For models:	XB403G, XB603G, XB803G, XBC1005, XBC404, XBC604, XBC804, XCH030, XG413G, XG613G, XV1003G, XV203G, XV303G, XV703G, XVC054, XVC1004P, XVC1005P, XVC1015G, XVC104, XVC105, XVC1204P, XVC2015G, XVC204, XVC304, XVC504, XVC704, XVC905P, XVT203G		

plugs/bushes

			
1			
Part No.	378375	Ref. No.	TR121 TR21
description	female connector 2-pole for core temperature probe		
For models:	XV202E, XV301E, XV401E, XV501E		

			
1			
Part No.	378376	Ref. No.	TR122 TR22
description	lid for plug contact		
For models:	XV202E, XV301E, XV401E, XV501E		

electronics

PCBs

			
1			
Part No.	403434	Ref. No.	KPE1730B PE1730B0
description	control PCB combi-steamer XVC1015G L 107mm W 60mm suitable for UNOX H 40mm		
For models:	XBC815G, XVC1015G, XVC2015G, XVC315G, XVC515G, XVC715G		

			
1			
Part No.	403758	Ref. No.	KPE1105A
description	control PCB convection oven suitable for UNOX with control panel		

			
1			
Part No.	403760	Ref. No.	KPE1195C PE1195B0 PE1195C1
description	control PCB L 290mm W 27mm suitable for UNOX		
For models:	XF115, XF135, XF185, XF188, XF195		



			
1			
Part No.	403757	Ref. No.	KPE1740A KPE1740C PE1740A0
description	display PCB convection oven XBC/XVC suitable for UNOX		
For models:	XBC1005, XBC1005E, XBC1005EL, XBC1015EG, XBC1015EGL, XBC405E, XBC605, XBC605E, XBC615EG, XBC805, XBC805E, XBC815EG, XBC815G, XBC905E, XBC905EL, XBC915EG, XBC915EGL, XVC055E, XVC1005EP, XVC1005EPL, XVC1005P, XVC1015EG, XVC1015EGL, XVC1015G, XVC105, XVC105E, XVC105EP, XVC1205EP, XVC1215EG, XVC2005EP, XVC2015EG, XVC2015G, XVC205, XVC205E, XVC305, XVC305E, XVC305EP, XVC315EG, XVC315G, XVC4005EP, XVC4005EPL, XVC4015EG, XVC4015EGL, XVC505, XVC505E, XVC505EP, XVC515EG, XVC705, XVC705E, XVC705EP...(Other models you can see in the webshop)		

			
1			
Part No.	401699	Ref. No.	KPE006 KPE009 KPE1355D PE1355DO
description	keypad PCB suitable for UNOX		
For models:	XVC054, XVC104, XVC204, XVC304, XVC504, XVC704		

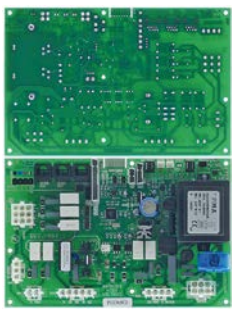
			
1			
Part No.	401700	Ref. No.	KPE005 KPE1365C PE1365C0 PE1365C0+KPE005 PE1365C2
description	main PCB for combi-steamer L 220mm W 145mm suitable for UNOX with mounting accessories		
For models:	XVC054, XVC104, XVC1204P, XVC204, XVC304, XVC504, XVC514G, XVC704		

			
1			
Part No.	402077	Ref. No.	PE1510B0
description	PCB		

			
1			
Part No.	403848	Ref. No.	KPE1010A PE1010A2
description	PCB for combi-steamer Cheflux-Bakerlux L 250mm W 86mm suitable for UNOX with mounting accessories		
For models:	XB403, XB403G, XB603, XB603G, XB803, XB803G, XG413, XG613, XG813G, XV203G, XV303G, XV703G		

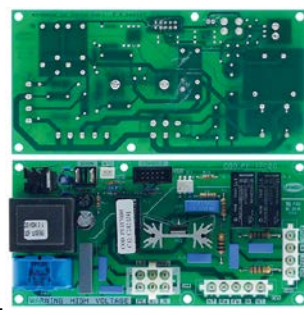
			
1			
Part No.	403850	Ref. No.	KPE1170B PE1170B0
description	PCB for combi-steamer LINE MISS CLASSIC L 155mm W 77mm suitable for UNOX with mounting accessories		
For models:	XF100, XF110, XF130, XF190		

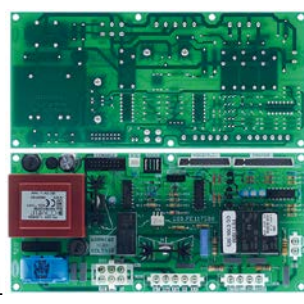
			
1			
Part No.	403849	Ref. No.	KPE004 KPE1175B PE1175B0
description	PCB for combi-steamer LINE MISS DYNAMIC L 200mm W 95mm suitable for UNOX with mounting accessories		
For models:	XF115, XF119, XF135, XF185, XF188, XF195		

			
1			
Part No.	403847	Ref. No.	KPE1010B PE1010B1
description	PCB for combi-steamer XB-XV-XG L 304mm W 95mm suitable for UNOX with mounting accessories		
For models:	XB403, XB403G, XB603, XB603G, XB803, XB803G, XBT146, XBT160, XG413G, XG613, XG613G, XG813, XV1003G, XV203G, XV303G, XV703G		



central units



1

Part No.	402171	Ref. No.	MG307
description	control box for coffee machine 230V type MFC2SG		

keypads

front foils



1

Part No.	403756	Ref. No.	KPE1210A
description	keypad foil grey suitable for UNOX L 485mm W 97mm		

1



Part No.	403879	Ref. No.	KPE1255A PE1255A0
description	keypad foil suitable for UNOX for LINE MISS DYNAMIC L 655mm W 35mm		
For models:	XF185, XF188, XF195		

1



Part No.	403759	Ref. No.	KPE1330A PE1330A0
description	keypad foil suitable for UNOX for model XF180/190 L 655mm W 35mm		
For models:	XF190		

1



Part No.	403755	Ref. No.	KMS1005A
description	keypad foil suitable for UNOX L 655mm W 35mm		



1

Part No.	403880	Ref. No.	PE1215A PE1215A0
description	keypad foil yellow suitable for UNOX for XB-series until April 2004 L 485mm W 97mm		

control panel

1



Part No.	508425	Ref. No.	KPE1315A PE1315A0
description	control panel convection oven L 800mm mounting pos. lower grey plastic suitable for LINE MISS UNOX		
For models:	XF185, XF188, XF190, XF195		

solenoid valves

solenoid valves (water)

RPE

JOHN GUEST

1



Part No.	374091	Ref. No.	EL1310A KEL1310A
description	solenoid valve 230VAC inlet 1/2" (tube ø 8mm) outlet 1/2" (tube ø 8mm) plastic		

solenoid valves with reducers

single

1





Part No.	374058	Ref. No.	EL1411A0 KEL1411A
description	solenoid valve 230VAC inlet JG 8 outlet JG 8 t.max. 60°C RPE flow regulating valve outlet white output A 1-1.25l/min		





			
1			
Part No.	374009	Ref. No.	EL029 EL1011 EL1041A0 EL1085A0 KEL1085A
description	solenoid valve single straight 220-240VAC inlet 3/4" outlet JG 8 input 10-12l/min output 0.07-0.14l/min t.max. 60°C duty cycle 100% RPE plastic flow regulating valve outlet brown flow regulating valve inlet white 1-ways medium temp max. 25°C		
For models:	XBT146, XF090P, XF185, XF188, XF195, XG413, XG413G, XG613, XL041, XV202, XV202E, XV203G, XV301, XV301E, XV303G, XVT203G		

			
1			
Part No.	374029	Ref. No.	KEL1155A KEL1155A0
description	solenoid valve single straight 220-240VAC inlet 3/4" outlet JG 8 input 10-12l/min output 0.2-0.33l/min t.max. 60°C duty cycle 100% RPE plastic flow regulating valve outlet red flow regulating valve inlet white 1-ways medium temp max. 25°C		

			
1			
Part No.	374040	Ref. No.	EL125A0 KEL1252A
description	solenoid valve single straight 230VAC inlet JG 8 outlet JG 10 output 0.45l/min t.max. 60°C duty cycle 100% flow regulating valve outlet green 2-ways with quick release connection		

			
1			
Part No.	370481	Ref. No.	EL1250A0 EL1251A0 KEL1250A KEL1251A
description	solenoid valve single straight 230VAC inlet JG 8 outlet JG 10 t.max. 60°C duty cycle 100% flow regulating valve outlet light brown output A 0.12l/min		
For models:	XBC404, XBC604, XBC804, XVC054, XVC1004P, XVC104, XVC204, XVC304, XVC504, XVC514G, XVC704		

			
1			
Part No.	374037	Ref. No.	EL025 EL1160A0 KEL1160A
description	solenoid valve double straight 220-240VAC inlet 3/4" outlet JG 8 input 10-12l/min t.max. 60°C duty cycle 100% RPE plastic flow regulating valve inlet white output A 0.2-0.33l/min output B 0.2-0.33l/min flow regulating valve outlet A red flow regulating valve outlet B red output A John Guest 8mm output B John Guest 8mm		
For models:	XB403, XB403G, XB603, XB603G, XBT160, XG613G, XL503, XV201, XV401, XV401E, XV703G		

			
1			
Part No.	374038	Ref. No.	EL1360A0 EL1360A1 KEL1360A KEL1361A
description	solenoid valve special 220-240VAC inlet JG 8 outlet JG 10 t.max. 60°C RPE UNOX plastic		
For models:	XBC1005, XBC605, XBC805, XBC815G, XVC1005P, XVC105, XVC2015G, XVC205, XVC305, XVC505, XVC515G, XVC705, XVC715G, XVC905P		

			
1			
Part No.	371299 ¹	Ref. No.	EL026 EL1050A0 KEL1050A
description	solenoid valve triple straight 220-240VAC inlet 3/4" outlet 10mm t.max. 90°C duty cycle 100% RPE output A 0.07-0.14l/min output B 0.07-0.14l/min output C 0.07-0.14l/min		
For models:	XB803, XB803G, XG813, XG813G, XV501, XV501E		

¹cylindrical outlet

			
1			
Part No.	374036 ¹	Ref. No.	EL1150A0 EL1165A0 KEL1165A
description	solenoid valve triple straight 220-240VAC inlet 3/4" outlet 8mm input 10-12l/min t.max. 60°C duty cycle 100% RPE plastic flow regulating valve inlet white output A 0.2-0.33l/min output B 0.2-0.33l/min output C 0.2-0.33l/min flow regulating valve outlet A red flow regulating valve outlet B red flow regulating valve outlet C red		
For models:	XB803, XB803G, XG813, XV1003G		

¹cylindrical outlet



various



Part No.	374101	Ref. No.	KVE1135A
description	solenoid valve UNOX 230VAC inlet 28mm outlet 16mm RPE plastic		



Part No.	374039	Ref. No.	KTB1500A VE1135A0
description	solenoid valve UNOX angled outlet 30mm RPE plastic 2-ways inlet 15.5mm 50/60Hz Faston 6.3mm		
For models:	XB403, XB403G, XB603, XB603G, XB803, XB803G, XBC1005, XBC404, XBC604, XBC605, XBC804, XBC805, XBC815G, XBT146, XBT160, XG413G, XG613G, XG813, XV1003G, XV203G, XV303G, XV703G, XVC054, XVC1015G, XVC104, XVC105, XVC1204P, XVC204, XVC304, XVC305, XVC315G, XVC504, XVC505, XVC514G, XVC515G, XVC704, XVC705, XVC715G		

fans

axial fans



Part No.	601937	Ref. No.	KVN1120B VN1120B1
description	axial fan L 119mm W 119mm H 32mm 12VDC connection plug cable length 2000mm plastic fan wheel ø 110mm		
For models:	XB695, XB895, XV593		

hot air motors

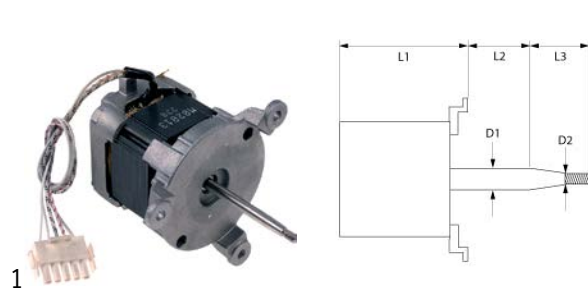

Part No.	601491	Ref. No.	KVN010 VN1035A0
description	fan motor		
For models:	XF010, XF020, XF020R, XF030, XF040, XF050, XF065, XF100, XF103, XF110, XF113, XF115, XF119, XF130, XF133, XF135		



Part No.	601965	Ref. No.	KVN1036A VN1036A0
description	fan motor 230V 1 phase 50/60Hz L1 110mm L2 50mm L3 12mm D1 ø 8mm D2 ø 6mm mounting thread M6		

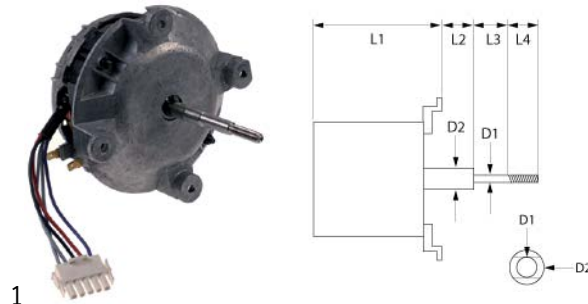

Part No.	601493	Ref. No.	KVN003 KVN1000B VN1000A0 VN1000B0 VN1000B1
description	fan motor 230V 3 phase 50HzkW speeds 1 L1 85mm L2 32mm L3 28mm L4 29mm D1 ø 8mm D2 ø 12mm		
For models:	XB403, XB403G, XB603, XB603G, XB803, XB803G, XBC404, XBC604, XBC804, XBT146, XBT160, XF043, XF183, XF185, XF188, XF190, XF193, XF195, XG413, XG413G, XG613, XG613G, XG813, XG813G, XV1003G, XV203G, XV303G, XV703G, XVC054, XVC1004P, XVC104, XVC1204P, XVC204, XVC304, XVC504, XVC514G, XVC704, XVT203G		



1

Part No.	601492	Ref. No.	KVN017 KVN1035B VN1035B0
description	fan motor L1 130mm L2 18mm L3 23mm D1 ø 8mm D2 ø 7mm mounting thread M6R ET		
For models:	XF003, XF023, XF113, XF133		

1

Part No.	601945	Ref. No.	KVN009 KVN1030A VN1030A0 VN1030A2 VN1030A3 VN1030A4
description	fan wheel D1 ø 196mm H1 81mm blades 39 D2 ø 10mm D3 ø 10mm H2 18mm		
For models:	XB693, XB695, XB893, XB895, XBC1005, XBC404, XBC604, XBC605, XBC804, XBC805, XBC815G, XG413G, XG813, XV1003G, XV593, XVC1004P, XVC1005P, XVC1015G, XVC105, XVC1204P, XVC2015G, XVC205, XVC305, XVC315G, XVC505, XVC514G, XVC515G, XVC705, XVC715G, XVC905P		

1

Part No.	601487	Ref. No.	KVN008 KVN1025A VN1005A0 VN1025A0 VN1025A2
description	fan wheel D1 ø 196mm H1 61mm blades 39 D2 ø 10/8mm D3 ø 10mm H2 32mm		
For models:	XB403, XB403G, XB603, XB603G, XB803, XB803G, XBT146, XBT160, XF043, XF183, XF185, XF188, XF190, XF193, XF195, XG413, XG413G, XG613, XG613G, XG813, XG813G, XV203G, XV303G, XV703G, XVC054, XVC104, XVC204, XVC304, XVC504, XVC704, XVT203G		

1

Part No.	601489	Ref. No.	KVN011 KVN1050A VN1050A0
description	fan wheel D1 ø 197mm H1 32mm blades 39 D2 ø 8mm D3 ø 8mm H2 12mm		
For models:	XF100, XF103, XF110, XF113, XF115, XF130, XF133, XF135		

1

Part No.	602124	Ref. No.	VN043
description	fan wheel D1 ø 196mm H1 61mm blades 39 D2 ø 8mm D3 ø 8x6.5mm H2 27mm		
For models:	XV501, XV501E		

1



Part No.	601776	Ref. No.	KVN1020A VN007 VN041
description	fan wheel D1 ø 197mm H1 43mm blades 39 D2 ø 8mm D3 ø 8x6.5mm H2 28mm		
For models:	XV202, XV202E, XV301, XV301E, XV401, XV401E, XV501		



			
1			
Part No.	551100	Ref. No.	GN1140 GN1140A0 GN1140A1 KGN1140A
description	gasket for fan motor ID \varnothing 10mm ED \varnothing 40mm thickness 0.8mm		
For models:	XB403, XB403G, XB603, XB603G, XB693, XB695, XB803, XB803G, XB893, XB895, XBC1005, XBC404, XBC604, XBC605, XBC804, XBC805, XBC815G, XBT146, XBT160, XG413G, XG613G, XG813, XV1003G, XV203G, XV303G, XV593, XV703G, XVC054, XVC1004P, XVC1005P, XVC104, XVC105, XVC1204P, XVC2015G, XVC204, XVC205, XVC304, XVC305, XVC504, XVC505, XVC514G, XVC515G, XVC704, XVC705, XVC715G, XVC905P		

hot air fans

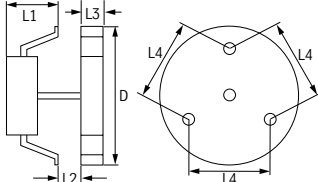
miscellaneous

			
1			
			
Part No.	601125	Ref. No.	VN050
description	hot air fan 220-240V 45W 50/60Hz L1 70mm L2 11mm L3 25mm L4 87mm fan wheel \varnothing 150mm FIME type C30R0479CLF		
For models:	XF006, XF010, XF011, XF020, XF020R, XF030, XF030-TG, XF040, XF050, XF065		
accessories for	601125		
	Part No.	550879	Ref. No. —
	insulation \varnothing 130mm thickness 3mm hole \varnothing 20mm for hot air fan		

accessories

miscellaneous

			
1			
Part No.	551279	Ref. No.	OH4305A1 KOH4305A KOH4305A OH4305A1
description	cover \varnothing 71mm thickness 1.2mm hole \varnothing 18mm shaft sealing		
For models:	XB693, XB695, XB893, XB895, XBC1005, XBC605, XBC805, XV593, XVC1005P, XVC1015G, XVC105, XVC205, XVC305, XVC315G, XVC505, XVC515G, XVC705, XVC715G, XVC905P		

			
1			
Part No.	551280	Ref. No.	OH3020 OH3020A0 OH3020A1
description	cover \varnothing 75mm thickness 1mm hole \varnothing 18mm shaft sealing		
For models:	XBC404, XBC604, XBC804, XF113, XF133, XVC054, XVC1004P, XVC104, XVC1204P, XVC204, XVC304, XVC504, XVC514G, XVC704		

radial fans

miscellaneous

			
1			
Part No.	601939	Ref. No.	KVN1055A VN1055A0
description	radial fan 230V voltage AC 50/60Hz 190W D1 \varnothing 133mm with heating element		
For models:	XC595		



motors

motors

for combi-steamers



Part No.	601948	Ref. No.	KVN002 KVN0027A VN026
description	motor 120W 230V 50-60Hz 1 phase shaft ø 8mm shaft length 67mm flange ø 165mm ø 165mm H 150mm mounting distance 140mm SISME 0.12kW		
For models:	XV202, XV202E, XV301, XV301E, XV401, XV401E, XV501, XV501E		



Part No.	403419	Ref. No.	KVN1130A VN1130A0
description	motor UNOX XBC/XVC SISME		
For models:	XB693, XB695, XB893, XB895, XBC1005, XBC605, XBC805, XV593, XVC1005P, XVC1015G, XVC105, XVC2015G, XVC205, XVC305, XVC315G, XVC505, XVC515G, XVC705, XVC715G, XVC905P		

pumps

booster pumps II

accessories



Part No.	365017	Ref. No.	VE1145A0
description	operating capacitor capacity 5µF 450V tolerance 5% 50/60Hz ambient temperature max. -25 to +85°C ø 28mm L 54mm M8 plastic connection male faston 6.3mm 16.10.08 protection		
For models:	XF003, XF023, XF100, XF103, XF110, XF113, XF115, XF119, XF130, XF133, XF135		

vibration pumps



Part No.	499360	Ref. No.	XC665
description	vibration pump kit type NME Typ1C 230-240V 16W 50Hz inlet ø 5 outlet ø 8 ULKA L 90mm		



Part No.	499350	Ref. No.	KVL0009A KVL1038A
description	vibration pump type MPP1.01.066.2/ST/S 230V 28W 50Hz inlet ø 6 outlet ø 8 kit L 111mm		



Part No.	499169	Ref. No.	EL070
description	vibration pump type NME Typ1C 230-240V 16W 50Hz inlet ø 5 outlet ø 8 ULKA L 90mm with holder		
For models:	XF113, XF133, XF135		

condensators & interference suppression filters

operating capacitors

plastic



Part No.	365017	Ref. No.	VE1145A0
description	operating capacitor capacity 5µF 450V tolerance 5% 50/60Hz ambient temperature max. -25 to +85°C ø 28mm L 54mm M8 plastic connection male faston 6.3mm 16.10.08 protection		
For models:	XF003, XF023, XF100, XF103, XF110, XF113, XF115, XF119, XF130, XF133, XF135		

metal



Part No.	365219	Ref. No.	CN1003A KCN1003A
description	operating capacitor capacity 6.3µF 400V tolerance 5% 50-60Hz ambient temperature max. -25 up to +70°C ø 35mm L 59.5mm M8 aluminium connection male faston 6.3mm		
For models:	XBC1005E, XBC1005EL, XBC1015EG, XBC1015EGL, XBC405E, XBC605E, XBC615EG, XBC805E, XBC905E, XBC905EL, XBC915EG, XBC915EGL, XV393, XVC055E, XVC1005EP, XVC1005EPL, XVC1015EG, XVC1015EGL, XVC105E, XVC105EP, XVC1205EP, XVC2005EP, XVC205E, XVC305E, XVC305EP, XVC315EG, XVC4005EP, XVC4005EPL, XVC4015EG, XVC4015EGL, XVC505E, XVC505EP, XVC515EG, XVC705E, XVC705EP, XVC715EG, XVC905EP, XVC905EPL, XVC915EG, XVC915EGL		



Part No.	551267	Ref. No.	CE119 MR1006A0
description	power lead CEE7/7 type E+F 3-pole contacts P+N+E max. 16A max 250V 1.5m H07 RN-F with power terminal block countries D/F/B/I black		
For models:	XF183, XF185, XF188		

ribbon cables

group 1

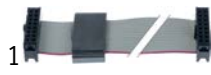

Part No.	403857	Ref. No.	CE1100A0 CE1100A1 KCE1100A
description	ribbon cable 16-pole L 1005mm plug type FC-16P raster size 2.54mm		



Part No.	403846	Ref. No.	CE1110A1 CE118
description	ribbon cable 20-pole L 1210mm plug type FC-20P raster size 2.54mm		
For models:	XV202E, XV401E		

connection cables



Part No.	403469	Ref. No.	IE1820A0 KIE1820A
description	connection cable L 1100mm 2-pole suitable for UNOX connection plug		
For models:	XVC1004P		

terminals

connection terminals with screw/faston connections



Part No.	551278	Ref. No.	CE1575A0
description	power terminal block 3-pole max. 40A max 450V connection M6/ male faston 6.3mm temp.-resist. 150°C cross section 6mm ²		
For models:	XVC1015G		

fuses

fine fuses



Part No.	358373	Ref. No.	VG1001A0
description	fine fuse size ø5x20mm 1.6A fast-acting rated 250V		
For models:	XVC1015G, XVC315G		

fine fuse holders



Part No.	358177	Ref. No.	KVG1000A VE301
description	fuse holder suitable fuse ø5x20mm ø 16mm mounting ø 13mm 1-pole 6.3A rated 250V L 54mm connection Faston 6.3mm		
For models:	XG413G, XG613, XG613G, XG813, XG813G		

electric accessories

cables

power supply cables





Part No.	551263	Ref. No.	CE116 KMR1000A MR1000A0
description	power lead CEE7/7 type E+F 3-pole contacts P+N+E max. 16A max 250V 1.5m H07 RN-F with power terminal block countries D/F/B/I black		
For models:	XC110, XC111, XC224, XC314, XC400, XC503, XC595, XCH030, XF003, XF006, XF010, XF011, XF016, XF020, XF020R, XF023, XF030, XF030-TG, XF040, XF050, XF065, XF100, XF103, XF110, XF113, XF115, XF119, XF130, XF133, XF135, XG413, XG413G, XG613, XG613G, XG813, XG813G, XK304, XL041, XL051, XL091, XL135, XL146, XL195, XL314, XL404, XL405, XL503, XL504, XL505, XP010P...(Other models you can see in the webshop)		



			
1			
Part No.	551266	Ref. No.	CE211
description	power terminal block 6-pole max. 40A max 450V connection M5/ male faston 6.3mm temp.-resist. 150°C		
For models:	XV301, XV301E, XV401, XV401E		

			
1			
Part No.	551260	Ref. No.	CE212 KMR1004A MR1004A0
description	power terminal block 7-pole max. 40A max 450V connection M5/ male faston 6.3mm temp.-resist. 150°C		
For models:	XB403, XB403G, XB603, XB603G, XB693, XB695, XB803, XB803G, XB893, XB895, XBC404, XBC604, XBC605, XBC804, XBC805, XBT146, XBT160, XV1003G, XV203G, XV303G, XV501, XV501E, XV593, XV703G, XVC2015G, XVC204, XVC205, XVC304, XVC305, XVC504, XVC505, XVC704, XVC705, XVT203G		

connection terminals with screw connection			
			
1			
Part No.	551274	Ref. No.	CE1420A0
description	distribution terminal block 8-pole temp.-resist. 85°C cross section 16/6mm ²		
For models:	XBC1005, XVC1004P, XVC1005P, XVC905P		

various			
			
1			
Part No.	550987	Ref. No.	CE1130A0
description	power terminal block 5-pole with cable cable length 1400mm		
For models:	XF190, XF193, XF195		

			
1			
Part No.	693955	Ref. No.	VM250
description	terminal grounding cable		
For models:	XB603, XBC404, XBC604, XBC605, XBC804, XBC805, XBC815G, XBT146, XBT160, XC111, XC114, XC314, XC400, XC503, XC595, XCH030, XF003, XF006, XF011, XF016, XF023, XF030, XF030-TG, XF043, XF065, XF090P, XF100, XF103, XF110, XF113, XF115, XF119, XF130, XF133, XF135, XF183, XF185, XF188, XF190, XF193, XF195, XG413, XG413G, XG613, XG613G, XG813, XG813G, XK304, XL041, XL051...(Other models you can see in the webshop)		

gas valves and ignition boxes

gas control valves

HONEYWELL

			
1			
Part No.	107579	Ref. No.	EL1080A0
description	gas valve type VK4105A 1100 4 220/240V 50/60Hz gas inlet 3/4" gas outlet 3/4" pressure range 15-60mbar max 60mbar HONEYWELL		
For models:	XG413G, XG613, XG613G, XG813, XG813G		

SIT

SIGMA

			
1			
Part No.	101989	Ref. No.	EL014
description	gas valve 230V 50Hz gas inlet 3/4" gas outlet 3/4" SIT pressure range 2-50mbar equiv. no. 0.840.016		
spare parts for	101989		
	Part No.	106214	Ref. No.
			—
	solenoid coil 230V 50Hz Sigma		
accessories for	101989		
	Part No.	107222	Ref. No.
			—
	plug for solenoid valve 3-pole cable length 1070mm		



TANDEM



1			
Part No.	101684	Ref. No.	EL015
description	gas valve 230V 50Hz gas inlet 1/2" gas outlet 1/2" pilot connection level slow ignition standard ignition time 3-7s pressure range 3-50mbar power supply for modulator type SIT equiv. no. 0.830.034		
spare parts for	101684		
	Part No.	101379	Ref. No. —
	solenoid coil 230V 50Hz suitable for Tandem		
accessories for	101684		
	Part No.	101274	Ref. No. —
	olive for pipe ø 16mm Qty 1 pcs		
	Part No.	101275	Ref. No. —
	union screw thread 1/2" for pipe ø 16mm Qty 1 pcs		
	Part No.	102845	Ref. No. —
	gas connection angled 1/2" flange 32x32mm hole distance 24x24mm Tandem		
	Part No.	102846	Ref. No. —
	gas connection straight 1/2" flange 32x32mm hole distance 24x24mm suitable for Tandem		
	Part No.	102847	Ref. No. —
	O-ring		

ignition boxes

HONEYWELL



1			
Part No.	103197	Ref. No.	KVE1055A VE1055A0 VE1055A1
description	ignition box HONEYWELL type S4565C 3116B electrodes 2 waiting times safety time 5s 220-240V 4VA 50/60Hz		
For models:	XB613G, XB813G, XBC1015EG, XBC1015EGL, XBC615EG, XBC815EG, XBC815G, XBC915EG, XBC915EGL, XG413G, XG613, XG613G, XG813, XG813G, XV513G, XV813G, XVC1015EG, XVC1015EGL, XVC1015G, XVC1215EG, XVC2015EG, XVC2015G, XVC315EG, XVC4015EG, XVC4015EGL, XVC515EG, XVC515G, XVC715EG, XVC715G, XVC915EG, XVC915EGL		

SIT



1			
Part No.	102306	Ref. No.	KVE001 VE045A
description	ignition box SIT type 503EFD electrodes 1 waiting time 1.5s safety time 5s 220/240V 10VA 50-60Hz protection IP40		

ignition parts

electrodes



1			
Part No.	107578	Ref. No.	BR1010A0 BR1010A1 BR1010B1
description	ignition electrode flange length 38mm flange width 17mm D1 ø 9.3mm L1 24mm L2 24mm BL1 70mm BL2 25mm connection 6		
For models:	XG413G, XG613, XG613G, XG813, XG813G		



1			
Part No.	107824	Ref. No.	BR1310A0 KBR1310A
description	ignition electrode flange length 64mm flange width 23mm D1 ø 9.4mm L1 20mm L2 15mm BL1 22mm BL2 26mm connection ø 6mm		
For models:	XBC815G, XVC1015G, XVC2015G, XVC515G, XVC715G		



1

Part No.	106924	Ref. No.	BR1015A0 KBR1015A
description	monitoring electrode flange length 38mm D1 ø 9.5mm flange width 17mm L1 25mm L2 21mm BL1 70mm BL2 24mm connection 6 mounting distance 28mm with flange		
For models:	XG413G, XG613, XG613G, XG813, XG813G		

ignition units

1

Part No.	102485	Ref. No.	VE1065A0
description	ignition unit outputs 2 220-240VAC 0.6VA 50-60Hz		
For models:	XG413G, XG613, XG613G, XG813, XG813G, XVC1015G, XVC2015G, XVC515G, XVC715G		

1

Part No.	101002	Ref. No.	KVE1065A
description	ignition unit outputs 2 230VAC dimensions 88x23x34mm mounting distance 73mm inlet F6.3x0.8 outlet F2.8x0.8 0.6VA 50/60Hz		

1

Part No.	103348	Ref. No.	KVE0009B
description	ignition unit outputs 2 dimensions 85x62x38mm mounting distance 58/77mm set 4-piece 50/60Hz primary 230/240V secondary 28KV		

gas burners

burners for convection ovens

1

Part No.	107585	Ref. No.	BR1000C0 BR1000D0 KBR1000D
description	burner for oven L 610mm		
For models:	XG413G, XG613, XG613G, XG813		
spare parts for	107585		
Part No.	106924	Ref. No.	BR1015A0 KBR1015A
description	monitoring electrode flange length 38mm D1 ø 9.5mm flange width 17mm L1 25mm L2 21mm BL1 70mm BL2 24mm connection 6 mounting distance 28mm with flange		

1

Part No.	107583	Ref. No.	BR1305A0 KBR1305A
description	burner oven L 510mm W 200mm UNOX		
For models:	XBC815G, XVC2015G, XVC515G, XVC715G		

equipment-specific units

for proving cabinets

doors

magnets

1

Part No.	692817	Ref. No.	KVE1607A
description	door magnet 2 pieces ø 22mm thread M6 thread L 14.5mm rubber with plain washer		
For models:	XL413		



for convection ovens/combi-steamers



Part No.	692827	Ref. No.	KVI0540A KVM2003A RC540 VI0540A0
description	bushing mounting pos. door hinge ø 20mm ID ø 10mm for hot air oven plastic		
For models:	XFT119, XFT140, XFT199, XFT200		

flow controllers



Part No.	103347	Ref. No.	EL033
description	flow controller for hot air oven RFL-U connection 1/8" thread M12x1 hose ø 10mm		
For models:	XV301, XV301E, XV401, XV401E, XV501, XV501E		

spare parts and accessories



Part No.	694497	Ref. No.	KVM1235A VM1235A0
description	clip for door		
For models:	XBC404, XBC604, XBC605, XBC804, XBC805, XBC815G, XVC1204P, XVC2015G, XVC204, XVC205, XVC304, XVC305, XVC315G, XVC504, XVC505, XVC514G, XVC515G, XVC704, XVC705, XVC715G, XVC905P		



Part No.	694983	Ref. No.	CR1086A KCR1086A
description	hinge inner door with mounting kit mounting pos. lower		
For models:	XB613G, XB693, XB695, XB813G, XB893, XB895, XBC405E, XBC605E, XBC615EG, XBC805E, XBC815EG, XBC905E, XBC905EL, XBC915EG, XBC915EGL, XV393, XV513G, XV593, XV813G, XV893, XVC1205EP, XVC1215EG, XVC2005EP, XVC2015EG, XVC205E, XVC305E, XVC305EP, XVC315EG, XVC505E, XVC505EP, XVC515EG, XVC705E, XVC705EP, XVC715EG, XVC905EP, XVC905EPL, XVC915EG, XVC915EGL		



Part No.	694982	Ref. No.	CR1085A CR1085A + GN1181A KCR1085A
description	hinge inner door with mounting kit mounting pos. upper		
For models:	XB613G, XB693, XB695, XB813G, XB893, XB895, XBC405E, XBC605E, XBC615EG, XBC805E, XBC815EG, XBC905E, XBC905EL, XBC915EG, XBC915EGL, XV393, XV513G, XV593, XV813G, XV893, XVC1205EP, XVC1215EG, XVC2005EP, XVC2015EG, XVC205E, XVC305E, XVC305EP, XVC315EG, XVC505E, XVC505EP, XVC515EG, XVC705E, XVC705EP, XVC715EG, XVC905EP, XVC905EPL, XVC915EG, XVC915EGL		



Part No.	692804	Ref. No.	CR005 CR1080A CR1081A KCR1080A
description	hinge kit for inner door mounting pos. upper/lower		
For models:	XL413		



Part No.	694984	Ref. No.	GN1180A0 KGN1180A
description	protector hinge L 95mm W 65mm Qty 4 pcs		
For models:	XB693, XB695, XBC404, XBC604, XBC605, XBC804, XBC805, XBC815G, XV593, XVC1204P, XVC2015G, XVC204, XVC205, XVC304, XVC305, XVC315G, XVC504, XVC505, XVC514G, XVC515G, XVC704, XVC705, XVC715G, XVC905P		

front panels



Part No.	508425	Ref. No.	KPE1315A PE1315A0
description	control panel convection oven L 800mm mounting pos. lower grey plastic suitable for LINE MISS UNOX		
For models:	XF185, XF188, XF190, XF195		

housing and bezels





Part No.	691524	Ref. No.	KVM1116A VM1116A0
description	cover left		
For models:	XF103, XF113, XF133, XF183, XF193		





			
1			
Part No.	691522	Ref. No.	VM1046A0
description	cover mounting pos. left		
For models:	XF100, XF103, XF110, XF113, XF115, XF130, XF133, XF135, XF183, XF185, XF188, XF190, XF193, XF195		

			
1			
Part No.	691523	Ref. No.	VM1045A0
description	cover right		
For models:	XF100, XF103, XF110, XF113, XF115, XF130, XF133, XF135, XF183, XF185, XF188, XF190, XF193, XF195		

			
1			
Part No.	691525	Ref. No.	VM1115A0
description	cover right		
For models:	XF103, XF113, XF133, XF183, XF193		

cleaning system			
cleaning system assembly			
			
1			
Part No.	520999	Ref. No.	KVL0005A
description	cleaning system assembly group suitable for UNOX combi-steamer		

			
1			
Part No.	521181	Ref. No.	KVL1044B
description	cleaning system suitable for UNOX combi-steamer		
For models:	XVC055E, XVC105E, XVC105EP, XVC205E, XVC305E, XVC305EP, XVC505E, XVC505EP, XVC705E, XVC705EP		

cleaning arms			
			
1			
Part No.	542410	Ref. No.	KVL1037A VM1955A VM1955A0
description	cleaning arm suitable for UNOX combi-steamer		
For models:	XBC1005E, XBC1005EL, XBC405E, XBC605E, XBC615EG, XBC805E, XBC815EG, XBC905E, XBC905EL, XVC1005EP, XVC1005EPL, XVC1205EP, XVC1215EG, XVC2005EP, XVC2015EG, XVC305E, XVC305EP, XVC315EG, XVC4005EP, XVC4005EPL, XVC4015EG, XVC4015EGL, XVC505E, XVC505EP, XVC515EG, XVC705E, XVC705EP, XVC715EG, XVC905EP, XVC905EPL		

pipes			
			
1			
Part No.	699467	Ref. No.	KVM1015A KVM1015A0 VM1015A1
description	pipe stainless steel ED ø 30mm 90°		

drip water trays			
			
1			
Part No.	699456	Ref. No.	KVM1216B
description	drip tray L 747mm W 132mm H 24mm for combi-steamer UNOX		

			
1			
Part No.	699457	Ref. No.	KVM1220A KVM1220A0
description	mounting set for drip pan combi-steamer UNOX 4-fold		
For models:	XBC404, XBC405E, XBC604, XBC605, XBC605E, XBC615EG, XBC804, XBC805, XBC805E, XBC815EG, XBC815G, XBC905E, XBC905EL, XVC054, XVC055E, XVC104, XVC105, XVC105E, XVC105EP, XVC1204P, XVC1205EP, XVC1215EG, XVC2005EP, XVC2015EG, XVC2015G, XVC204, XVC205, XVC205E, XVC304, XVC305, XVC305E, XVC305EP, XVC315EG, XVC315G, XVC504, XVC505, XVC505E, XVC505EP, XVC514G, XVC515EG, XVC515G, XVC704, XVC705, XVC705E, XVC705EP, XVC715EG, XVC715G, XVC905EP, XVC905EPL		

1 mechanical components, equipment accessories



door mechanics

miscellaneous



Part No.	692827	Ref. No.	KVI0540A KVM2003A RC540 VI0540A0
description	bushing mounting pos. door hinge ø 20mm ID ø 10mm for hot air oven plastic		
For models:	XFT119, XFT140, XFT199, XFT200		



Part No.	694987	Ref. No.	KVM1490A
description	cover for screws door handle for combi-steamer 2 pieces with screws		
For models:	XB613G, XB693, XB695, XB813G, XB893, XB895, XBC1005E, XBC1005EL, XBC1015EG, XBC1015EGL, XBC405E, XBC605E, XBC615EG, XBC805E, XBC815EG, XBC905E, XBC905EL, XBC915EG, XBC915EGL, XV513G, XV593, XV813G, XV893, XVC1005EP, XVC1005EPL, XVC1015EG, XVC1015EGL, XVC1205EP, XVC1215EG, XVC2005EP, XVC2015EG, XVC205E, XVC305E, XVC305EP, XVC315EG, XVC4005EP, XVC4005EPL, XVC4015EG, XVC4015EGL, XVC505E, XVC505EP, XVC515EG, XVC705E, XVC705EP, XVC715EG, XVC905EP, XVC905EPL, XVC915EG, XVC915EGL		

vibration pumps



Part No.	499350	Ref. No.	KVL0009A KVL1038A
description	vibration pump type MPP1.01.066.2/ST/S 230V 28W 50Hz inlet ø 6 outlet ø 8 kit L 111mm		

knobs

producer-specific knobs

UNOX



Part No.	112721	Ref. No.	KMN1050A MN1050A0 MN140
description	dial plate 0-120min t.max. °C for timer ø 58mm		
For models:	XF006, XF011, XF016, XF030, XF030-TG, XF090P		



Part No.	112761	Ref. No.	MN1005A0 MN110 MN130
description	dial plate t.max. 70°C 30-70°C ø 58mm shaft ø 15mm black		
For models:	XL041, XL051, XL091, XL503		



Part No.	111495	Ref. No.	KMN1065A MN042 MN1065A0
description	dial plate thermostat 80-300°C ø 58/42.5mm black t.max. 300°C		
For models:	XF006, XF016, XF030, XF030-TG, XF090P, XV202, XV301, XV401, XV501		



Part No.	112715	Ref. No.	KMN0046B MN046
description	dial plate thermostat t.max. 300°C 80-300°C ø 58mm hole distance 29mm		
For models:	XF065		
accessories for	112715		



Part No.	112714	Ref. No.	MN045
description	dial plate top heat t.max. °C ø 58mm hole distance 29mm		

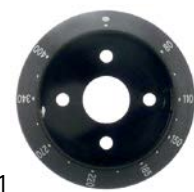

Part No.	112718	Ref. No.	MN043
description	dial plate thermostat t.max. 400°C 80-400°C ø 58mm black		
For models:	XP010P, XP010PR, XP010PT, XP010R, XP020, XP020P, XP020PR, XP020PT, XP020R, XP020T		

1

Part No.	112714	Ref. No.	MN045
description	dial plate top heat t.max. °C ø 58mm hole distance 29mm		
For models:	XF065		
accessories for	112714		
	Part No.	112715	Ref. No. KMN0046B MN046
	dial plate thermostat t.max. 300°C 80-300°C ø 58mm hole distance 29mm		



1

Part No.	112723	Ref. No.	KMN1113A MN1113A0
description	knob steaming t.max. 260°C 80-260°C ø 55mm shaft ø 6mm shaft flat lower silver		
For models:	XB693, XB893, XV593		



1

Part No.	112846	Ref. No.	KMN1091A
description	knob temperature t.max. 300°C 80-300°C ø 40.5mm shaft ø 6x4.6mm shaft flat lower silver		



1

Part No.	112722	Ref. No.	KMN1111A MN1111A0
description	knob thermostat t.max. 260°C 80-260°C ø 55mm shaft ø 6x4.6mm shaft flat lower silver		
For models:	XB693, XB893, XV593		



1

Part No.	112668	Ref. No.	KMN1091B
description	knob thermostat t.max. 260°C ø 41mm shaft ø 6x4.6mm shaft flat lower silver		



1

Part No.	112543	Ref. No.	MN1101A0 MN1101B0
description	knob thermostat t.max. 260°C ø 45mm shaft ø 6x4.6mm shaft flat lower silver temperature range 80-260°C rotation 270°		
For models:	XF003, XF023		



1

Part No.	112540	Ref. No.	MN1091A0
description	knob thermostat t.max. 300°C ø 41mm shaft ø 6x4.6mm shaft flat lower silver temperature range 80-300°C rotation 270°		
For models:	XF103, XF113, XF133, XF183, XF193		



1

Part No.	112627	Ref. No.	MN1000A + MN1050A MN1000A0
description	knob time 120min ø 58mm shaft ø 6x4.6mm shaft flat lower		



1

Part No.	112539	Ref. No.	KMN1090A MN1090A0
description	knob time 120min t.max. °C ø 41mm shaft ø 6x4.6mm shaft flat lower silver		
For models:	XF103, XF113, XF133, XF183, XF193		



			
1			
Part No.	112542	Ref. No.	KMN1100A MN1100A0
description	knob time 60min t.max. °C°C ø 45mm shaft ø 6x4.6mm shaft flat lower gold		
For models:	XF003, XF023, XF043		

			
1			
Part No.	112794	Ref. No.	KMN1090B
description	knob time range 0-60min shaft ø 6x4.6mm shaft flat lower		
For models:	XFT113, XFT133, XFT183, XFT193		

			
1			
Part No.	112726	Ref. No.	KMN1112A MN1112A0
description	knob timer t.max. °C 0-60min°C ø 55mm shaft ø 6mm shaft flat upper silver		
For models:	XB693, XB893, XV593		



			
1			
Part No.	112853	Ref. No.	KMN1105A
description	knob kit thermostat t.max. 400°C 120-400°C ø 55mm shaft ø 6x4.6mm shaft flat lower gold		



			
1			
Part No.	112760	Ref. No.	KOH4969A MN048
description	knob kit zero mark t.max. 70°C 30-70°C ø 58mm shaft ø 6mm shaft flat 4.5 black incl. zero mark knob		
For models:	XL041, XL051, XL091, XL146, XL503, XL504, XL505		

accessories

fascias

			
1			
Part No.	112721	Ref. No.	KMN1050A MN1050A0 MN140
description	dial plate 0-120min t.max. °C°C for timer ø 58mm		
For models:	XF006, XF011, XF016, XF030, XF030-TG, XF090P		

				
1				
Part No.	112715	Ref. No.	KMN0046B MN046	
description	dial plate thermostat t.max. 300°C 80-300°C ø 58mm hole distance 29mm			
For models:	XF065			
accessories for	112715			
	Part No.	112714	Ref. No.	MN045
dial plate top heat t.max. °C°C ø 58mm hole distance 29mm				

				
1				
Part No.	112714	Ref. No.	MN045	
description	dial plate top heat t.max. °C°C ø 58mm hole distance 29mm			
For models:	XF065			
accessories for	112714			
	Part No.	112715	Ref. No.	KMN0046B MN046
dial plate thermostat t.max. 300°C 80-300°C ø 58mm hole distance 29mm				

knob adaptors

			
1			
Part No.	696692	Ref. No.	KVI1520A
description	shaft shaft ø 12mm center grooved pin 6x55 shaft flat 4.5		

rosettes

			
1			
Part No.	112541	Ref. No.	KMN1095A MN1095A0
description	rosette for knob up to ø 41mm		
For models:	XF103, XF113, XF133, XF183, XF193		



handles and hand wheels

handle bars

handle bars



1

Part No.	692803	Ref. No.	2H060
description	handle rod tube ø 15mm thickness 1mm L 755mm SS Qty 1 pcs		
For models:	XF090P		



1

Part No.	691516	Ref. No.	0H3195A0
description	handle rod tube ø 18mm thickness 1mm L 508mm		
For models:	XF023		



1

Part No.	691515	Ref. No.	0H1925A0
description	handle rod tube ø 18mm thickness 1mm L 518mm		
For models:	XF110, XF113, XF115, XF130, XF133, XF135		



1

Part No.	691514	Ref. No.	0H1930A0
description	handle rod tube ø 18mm thickness 1mm L 718mm		
For models:	XF183, XF185, XF188, XF190, XF193, XF195		

consoles



1

Part No.	692217	Ref. No.	KMG1015B MG1015B0
description	console for handle rod H 43mm kit mounting pos. left/right		
For models:	XF003, XF043, XF113, XF133, XL405, XVC105		



1

Part No.	690769	Ref. No.	KMG0119A MG0119A0 MG119
description	console for handle rod tube ø 13mm H 41mm plastic Qty 2 pcs		
For models:	XF006, XF011, XF016, XF030, XF030-TG, XF065, XF090P		



1

Part No.	691517	Ref. No.	MG1015A0
description	console for handle rod tube ø 18mm		
For models:	XF003, XF023, XF100, XF103, XF110, XF113, XF115, XF119, XF130, XF133, XF135, XF183, XF185, XF188, XF190, XF193, XF195, XVC054, XVC104		



door handles

door handles



1

Part No.	692710	Ref. No.	KMG1035A MG1035A1
description	door handle suitable for UNOX L 200mm W 24mm model XL SS		
For models:	XL404		

locks

handle latches

producer-specific

UNOX

locks





1

Part No.	694985	Ref. No.	KMG003 KMG1030B
description	door handle H 45mm L 180mm W 45mm UNOX mounting measurements 34x34mm		





1

Part No.	694691	Ref. No.	KMG0420A	
description	door handle heated units with door catch L 165mm W 40mm H 62mm mounting distance 60mm bolt \varnothing 16mm bolt 70mm flange 79x40mm UNOX			
spare parts for	694691			
	Part No.	694734	Ref. No.	—
	door handle L 165mm W 40mm H 25mm black			
	Part No.	694735	Ref. No.	—
	cap \varnothing 32mm black			



1

Part No.	694350	Ref. No.	KMG001 KMG1000A MG1000AO	
description	door handle heated units with door catch L 165mm W 40mm H 62mm mounting distance 60mm bolt \varnothing 16mm bolt 85mm flange 79x40mm UNOX			
For models:	XB403, XB403G, XB603, XB603G, XB803, XB803G, XBT146, XBT160, XG413, XG413G, XG613, XG613G, XG813, XG813G, XV1003G, XV203G, XV303G, XV703G, XVT203G			
spare parts for	694350			
	Part No.	694734	Ref. No.	—
	door handle L 165mm W 40mm H 25mm black			
	Part No.	694735	Ref. No.	—
	cap \varnothing 32mm black			

espagnolette locks

universal



1

Part No.	690040	Ref. No.	MG309
description	door catch with roller H 42mm L 40mm W 40mm zinc die cast mounting distance 26mm type 0751 series		

hinges

oven hinges

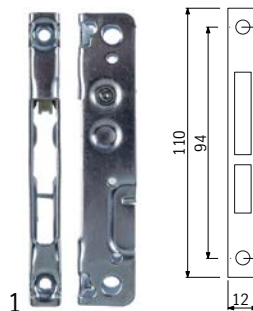

1

Part No.	693045	Ref. No.	CR100
description	opposite support L 110mm W 12mm mounting distance 94mm		
For models:	XF006, XF011, XF016, XF030, XF030-TG, XF065, XF090P		

1

Part No.	701559	Ref. No.	CR1000A CR1000A0 KCR1000A
description	opposite support mounting distance 81mm L 134mm W 10mm		
For models:	XF100, XF103, XF110, XF113, XF115, XF130, XF133, XF135, XF183, XF185, XF188, XF190, XF193, XF195, XFT110, XFT113, XFT115, XFT130, XFT133, XFT135, XFT180, XFT183, XFT185, XFT188, XFT190, XFT193, XFT195, XVC054, XVC104, XVC105		



1

Part No.	701552	Ref. No.	CR1070A KCR1070A
description	opposite support mounting distance 94mm L 112mm W 10mm		
For models:	XF023, XF043		



1

Part No.	701169 ¹	Ref. No.	KCR0020A KCR003
description	oven hinge kit mounting distance 118mm lug mounting 13mm lever length 117mm groove distance 7mm spring thickness 2.7mm mounting ear position left/right spring length 58mm L 155mm W 20mm suitable for UNOX		

¹with opposite support

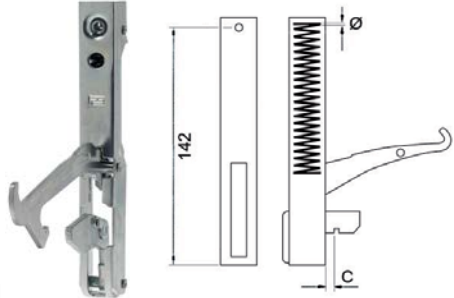

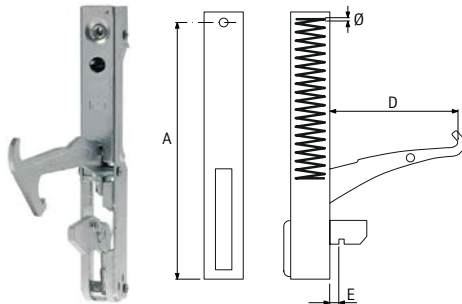

1

Part No.	700459	Ref. No.	CR070
description	oven hinge mounting distance 142mm mounting distance 2mm lug mountingmm lever length 117mm groove distance 7mm spring thickness 3.5mm mounting ear position spring length 58mm L 156mm W 22mm		
For models:	XF030, XF030-TG, XF065		
accessories for	700459		
	Part No.	693045	Ref. No. CR100
	opposite support L 110mm W 12mm mounting distance 94mm		



1

Part No.	700000	Ref. No.	CR065
description	oven hinge mounting distance 142mm mounting distance 2mm lug mountingmm lever length 127mm groove distance 10mm spring thickness 3.7mm mounting ear position L 155mm mounting pos. left/right		
For models:	XF090P		
accessories for	700000		
	Part No.	693045	Ref. No. CR100
	opposite support L 110mm W 12mm mounting distance 94mm		
	Part No.	700707	Ref. No. —
	opposite support mounting distance 94mm L 140mm mounting pos. left W 13mm with welded metal sheet H 110mm for hinge		







1

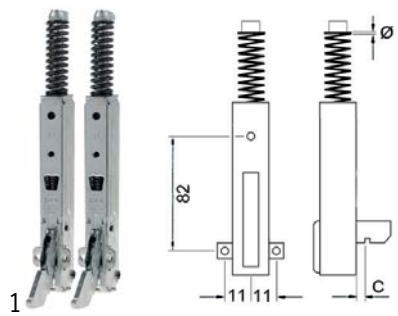

Part No.	701544	Ref. No.	KCR012 KCR1025A
description	oven hinge mounting distance 82mm spring thickness 3mm spring length 57mm L 155mm code A1 left/right Qty 2 pcs		



			
1			
Part No.	701545	Ref. No.	KCR1020A0 KCR1020B
description	oven hinge mounting distance 82mm spring thickness 3mm spring length 57mm L 155mm code A2 left/right Qty 2 pcs		

				
1				
Part No.	700759	Ref. No.	CR1015A KCR013 KCR1015A	
description	oven hinge mounting distance 82mm spring thickness 3mm spring length 57mm L 155mm code A3 left/right Qty 2 pcs			
For models:	XFT130, XFT133, XFT135			
accessories for	700759			
	Part No.	701559	Ref. No.	CR1000A CR1000A0 KCR1000A
opposite support mounting distance 81mm L 134mm W 10mm				

				
1				
Part No.	701326	Ref. No.	CR1075A CR1075A0 CR1075B0 KCR1075A KCR1075B	
description	oven hinge mounting distance 87mm spring thickness 3.2mm L 150mm left/right C 10mm suitable for UNOX Qty 2 pcs			
For models:	XF043			
accessories for	701326			
	Part No.	701552	Ref. No.	CR1070A KCR1070A
opposite support mounting distance 94mm L 112mm W 10mm				

				
1				
Part No.	700760	Ref. No.	CR1065A0 KCR020 KCR1065A	
description	oven hinge mounting distance 87mm spring thickness 3mm L 150mm left/right Qty 2 pcs			
For models:	XF023			
accessories for	700760			
	Part No.	701552	Ref. No.	CR1070A KCR1070A
opposite support mounting distance 94mm L 112mm W 10mm				

			
1			
Part No.	440012	Ref. No.	CR025 KCR0025A
description	oven hinge set		
For models:	XF006, XF010, XF011, XF020, XF020R		

			
1			
Part No.	694558	Ref. No.	2xCR065+2xCR100 KCR0065A
description	oven hinge set lever length 125mm L 156mm suitable for UNOX		

			
1			
Part No.	700994	Ref. No.	KCR0070A KCR008
description	oven hinge set lever length 125mm L 156mm suitable for UNOX ARIANNA, ELENA		

			
1			
Part No.	701314	Ref. No.	CR1010A0 KCR014
description	oven hinge set mounting distance 82mm spring thickness 2.8mm L 155mm left/right windings 16 Qty 2 pcs		
For models:	XF110, XF113, XF115		





1

Part No.	701410	Ref. No.	CR1050A KCR016 KCR1050A
description	oven hinge set mounting distance 82mm spring thickness 3.4mm L 155mm left/right windings 13 Qty 2 pcs		
For models:	XFT190, XFT193, XFT195, XVC055E, XVC105E, XVC105EP		
accessories for	701410		



Part No.	701559	Ref. No.	CR1000A CR1000A0 KCR1000A
description	opposite support mounting distance 81mm L 134mm W 10mm		



1

Part No.	701411	Ref. No.	KVM1236A VM1236A0
description	hinge block L 28mm W 31mm mounting pos. lower UNOX		
For models:	XBC404, XBC604, XBC605, XBC804, XBC805, XBC815G, XVC1204P, XVC2015G, XVC204, XVC205, XVC304, XVC305, XVC315G, XVC504, XVC505, XVC514G, XVC515G, XVC704, XVC705, XVC715G		

door bearing



1

Part No.	692827	Ref. No.	KVI0540A KVM2003A RC540 VI0540A0
description	bushing mounting pos. door hinge ø 20mm ID ø 10mm for hot air oven plastic		
For models:	XFT119, XFT140, XFT199, XFT200		



1

Part No.	701409	Ref. No.	EVM0012A KVM0012A KVM1230A KVM1231A VM1231A0
description	mounting set for inner door UNOX		
For models:	XB693, XB893, XBC404, XBC604, XBC605, XBC804, XBC805, XBC815G, XV593, XVC1204P, XVC2015G, XVC204, XVC205, XVC304, XVC305, XVC315G, XVC504, XVC505, XVC514G, XVC515G, XVC704, XVC705, XVC715G, XVC905P		
spare parts for	701409		



Part No.	694984	Ref. No.	GN1180A0 KGN1180A
description	protector hinge L 95mm W 65mm Qty 4 pcs		

equipment feet and end caps

screw-in feet



1

Part No.	701407	Ref. No.	KVM15230A VM1230A0
description	door hinge L 60mm W 16mm H 60mm mounting pos. upper UNOX		
For models:	XB693, XB695, XB895, XBC404, XBC604, XBC605, XBC804, XBC805, XBC815G, XVC1204P, XVC2015G, XVC204, XVC205, XVC304, XVC305, XVC315G, XVC504, XVC505, XVC514G, XVC515G, XVC704, XVC705, XVC715G, XVC905P		



1

Part No.	701317	Ref. No.	D35 KPD1052A PD061 PD1052A0
description	equipment feet kit thread M10 ø 35mm H 20mm Qty 4 pcs UNOX		
For models:	XB403, XB403G, XB603, XB603G, XB803, XB803G, XL041, XL051, XL091, XV203G, XV303G, XV703G		



1

Part No.	701626	Ref. No.	KVM1165B VM1165A0 VM1165B0
description	hinge mounting pos. upper door		
For models:	XB1083, XB613G, XB693, XB695, XB813G, XB893, XB895, XBC1005E, XBC1005EL, XBC1015EG, XBC1015EGL, XBC404, XBC405E, XBC604, XBC605E, XBC615EG, XBC804, XBC805E, XBC815EG, XBC905E, XBC905EL, XBC915EG, XBC915EGL, XV1093, XV393, XV513G, XV593, XV813G, XV893, XVC1004P, XVC1005EP, XVC1005EPL, XVC1015EG, XVC1015EGL, XVC1204P, XVC1205EP, XVC1215EG, XVC2005EP, XVC2015EG, XVC204, XVC205E, XVC304, XVC305E, XVC305EP, XVC315EG, XVC315G, XVC4005EP, XVC4005EPL, XVC4015EG, XVC4015EGL...(Other models you can see in the webshop)		



1

Part No.	696596	Ref. No.	PD031 PD1051A0
description	equipment foot thread L 22mm ø 35mm H 20mm WS Qty 1 pcs suitable for UNOX		
For models:	XF010, XF011, XF020, XF020R, XF030, XF030-TG, XF040, XF050, XF065, XF090P, XP010P, XP010PR, XP010PT, XP010R, XP020, XP020P, XP020PR, XP020PT, XP020R, XP020T, XV201, XV202, XV202E, XV301, XV301E, XV401, XV401E		



bolting feet



1

Part No.	691521	Ref. No.	KPD1001A PD1000A0 PD1001A0
description	equipment foot ømm L 35mm W 35mm H 37mm bore ø 8mm mounting distancemm Qty 4 pcs		
For models:	XBC404, XBC604, XBC605, XBC804, XBC805, XBC815G, XC224, XC314, XF003, XF023, XF043, XF100, XF103, XF110, XF113, XF115, XF119, XF130, XF133, XF135, XF183, XF185, XF188, XF190, XF193, XF195, XP010P, XP010PR, XP010PT, XP020, XP020P, XP020PR, XP020PT, XP020R, XP020T, XVC054, XVC104, XVC105, XVC204, XVC205, XVC304, XVC305, XVC315G, XVC504, XVC505, XVC514G, XVC515G, XVC704, XVC705, XVC715G		

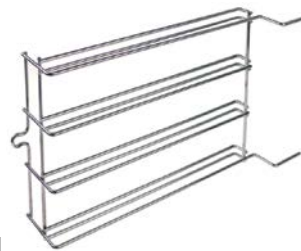

1

Part No.	691519	Ref. No.	GRL1025A0
description	rack support L 570mm H 230mm mounting pos. left/right		
For models:	XF190, XF193, XF195		

gaskets

gaskets for heated units

window seals

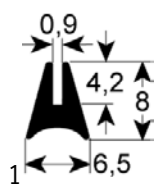

1

Part No.	901306	Ref. No.	GN102
description	window gasket profile 1515 Qty supplied by meter		
For models:	XB403, XB403G, XB603, XB603G, XB803, XB803G, XBT146, XBT160, XG413, XG413G, XG613, XG613G, XG813, XG813G, XV1003G, XV203G, XV303G, XV703G, XVT203G		

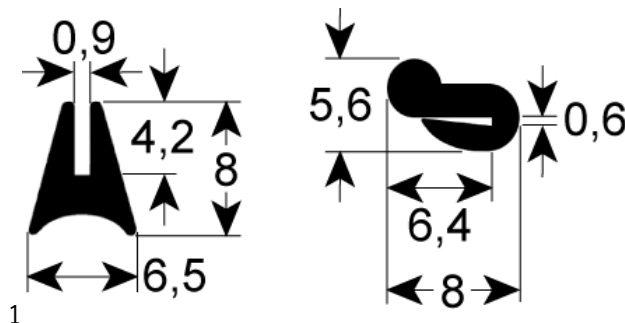

1

Part No.	901280	Ref. No.	KGN1380A
description	window gasket profile 1625/1876 suitable for UNOX L 2x4m		

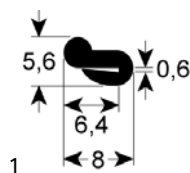

1

Part No.	901305	Ref. No.	GN100
description	window gasket profile 1876 Qty supplied by meter		
For models:	XB403, XB403G, XB603, XB603G, XB803, XB803G, XBT146, XBT160, XG413, XG413G, XG613, XG613G, XG813, XG813G, XV1003G, XV203G, XV303G, XV703G, XVT203G		

shelves and shelf rails

grid attachments

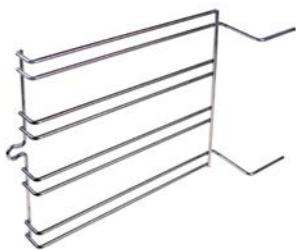

1

Part No.	691518	Ref. No.	GRL1010A0 GRL1010A1 KGRL1010A
description	rack support L 310mm H 250mm mounting pos. left/right		
For models:	XF130, XF133, XF135		

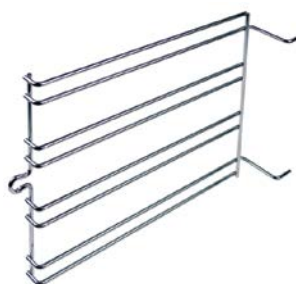

1

Part No.	691520	Ref. No.	GRL1090A0 KGRL1090A
description	rack support L 320mm H 235mm mounting pos. left/right		
For models:	XF023		



door seals

1

Part No.	901775	Ref. No.	GN1342B0 GN1343B0 KGN0017A KGN1392C
description	door seal profile 2716 Qty 4.45m		
For models:	XB693, XB695, XB893, XB895, XV593		

1

Part No.	901774	Ref. No.	GN1006A
description	door seal profile 2716 Qty supplied by meter		
For models:	XFT140, XFT200		

1

Part No.	902020	Ref. No.	KGN1342C
description	door seal profile 2766		

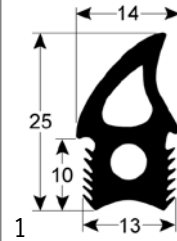

Part No.	902478	Ref. No.	GN1389B GN1389C KGN1389C
description	door seal profile 2766 L 1855mm Qty 1		
For models:	XVC305E, XVC305EP, XVC315EG		

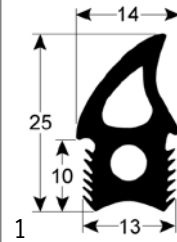

Part No.	902479	Ref. No.	GN1390C KGN1390C
description	door seal profile 2766 L 2250mm Qty 1		
For models:	XVC505E, XVC505EP, XVC515EG		

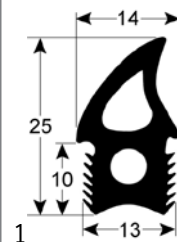

Part No.	902482	Ref. No.	GN1391C KGN1391C
description	door seal profile 2766 L 2520mm Qty 1		
For models:	XVC705E, XVC705EP, XVC715EG		

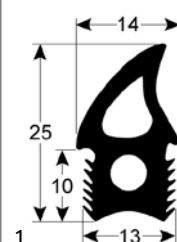

Part No.	902477	Ref. No.	GN1343C KGN1343C
description	door seal profile 2766 L 3070mm Qty 1		
For models:	XBC805E, XBC815EG, XVC2005EP, XVC2015EG		

1

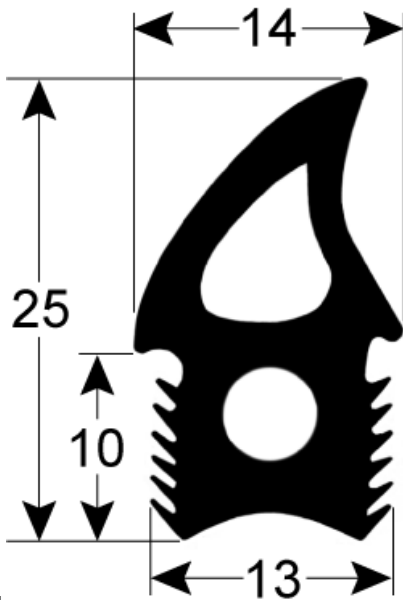

1

Part No.	901843	Ref. No.	GN1250A0 KGN0015A KGN1388C
description	door seal profile 2766 Qty 2.7m		
For models:	XVC1004P		

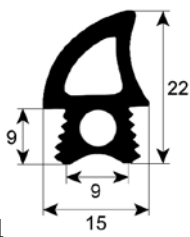

1

Part No.	901294	Ref. No.	GN1000B0
description	door seal profile 2767 Qty supplied by meter		
For models:	XB403, XB403G, XB603, XB603G, XB803, XB803G, XBC1005, XBC404, XBC604, XBC605, XBC804, XBC805, XBC815G, XBT146, XBT160, XG413G, XG613, XG613G, XG813, XV1003G, XV203G, XV303G, XV703G, XVC1005P, XVC1015G, XVC1204P, XVC2015G, XVC204, XVC205, XVC304, XVC305, XVC504, XVC505, XVC514G, XVC515G, XVC704, XVC705, XVC715G, XVC905P, XVT203G		

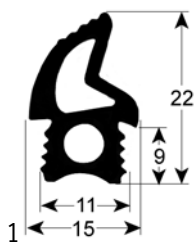

1

Part No.	902476	Ref. No.	GN1356B KGN1356B
description	door seal profile 2769 L 1370mm Qty 1		
For models:	XVC055E		

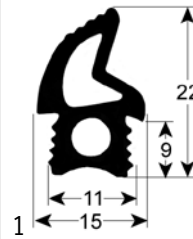

1

Part No.	902327	Ref. No.	KGN1352A
description	door seal profile 2769 L 1600mm Qty 1		

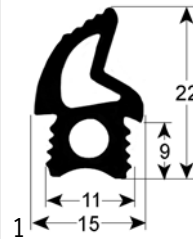

1

Part No.	902475	Ref. No.	GN1036B KGN1036B
description	door seal profile 2769 L 1720mm Qty 1		

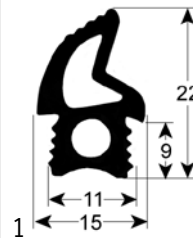

1

Part No.	902328	Ref. No.	KGN1353A
description	door seal profile 2769 L 1900mm Qty 1		

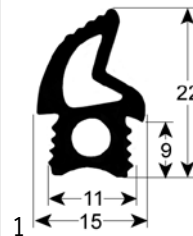

1

Part No.	902217	Ref. No.	GN1354A KGN1354A
description	door seal profile 2769 L 2030mm Qty 1		
For models:	XFT190, XFT193, XFT195, XFT199, XFT200		

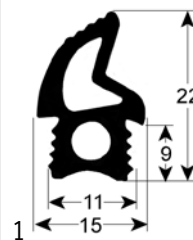

1

Part No.	900802	Ref. No.	GN1110A2
description	door seal profile 2769 L 2200mm Qty 1		
For models:	XF113, XF119, XF133, XF135, XF183, XF193, XL405, XVC054, XVC104, XVC105		



Part No.	900804	Ref. No.	GN1110A0
description	door seal profile 2769 L 2500mm		
For models:	XCH030, XF100, XF103, XF110, XF115, XF130, XF135, XF185, XF188, XF190, XF195		

Part No.	900805	Ref. No.	GN0003A KGN0003A N/A
description	door seal profile 2769 Qty supplied by meter		

door seals with fixing hook

Part No.	902474	Ref. No.	GN1225A KGN1225A
description	door seal L 330mm W 230mm with 4 mounting clips		

Part No.	901373	Ref. No.	GN011 KGN011B
description	door seal L 340mm W 270mm with 6 mounting clips		
For models:	XF011		

Part No.	902330	Ref. No.	GN010
description	door seal L 350mm W 280mm with 4 mounting clips		
For models:	XF010, XF020, XF020R		

Part No.	902329	Ref. No.	KGN072
description	door seal L 360mm W 220mm with 6 mounting clips		

Part No.	901846	Ref. No.	GN007A KGN007A KGN007B
description	door seal L 420mm W 790mm 3-sided with mounting clip		

Part No.	901319	Ref. No.	GN021 GN021A GN021D KGN021D
description	door seal L 450mm W 350mm with 8 mounting clips		
For models:	XF030, XF030-TG, XF040, XF050, XF065, XV201, XV202, XV202E		

Part No.	902396	Ref. No.	GN1230A GN1230A0 KGN1230A
description	door seal L 460mm W 250mm with 6 mounting clips mounting distance 450x230mm suitable for UNOX		





			
1			
Part No.	900803	Ref. No.	GN1235A GN1235A0 KGN1235A
description	door seal L 480mm W 320mm to be hooked in external size		
For models:	XF023		

			
1			
Part No.	902397	Ref. No.	GN025A KGN025A
description	door seal L 550mm W 350mm with 6 mounting clips mounting distance 520x310mm suitable for UNOX		

			
1			
Part No.	901307	Ref. No.	KGN1260A KGN1260AO
description	door seal L 640mm W 290mm with mounting clip		

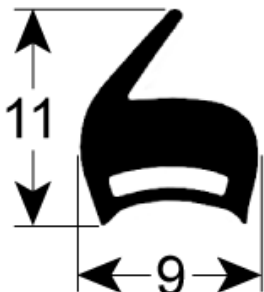
			
1			
Part No.	901321	Ref. No.	GN036 GN036C GN036D KGN036D
description	door seal L 650mm W 350mm with 8 mounting clips		
For models:	XF090P		

			
1			
Part No.	901848	Ref. No.	KGN070
description	door seal W 460mm 4-sided with mounting clip H 210mm		

			
1			
Part No.	901844	Ref. No.	GN008B GN008C KGN0008C KGN0008D
description	door seal W 640mm 3-sided with mounting clip H 610mm		

			
1			
Part No.	901505	Ref. No.	GN055 GN055B KGN055B
description	door seal W 650mm with 16 mounting clips H 800mm		
For models:	XV501, XV501E		

			
1			
Part No.	901847	Ref. No.	GN060 GN060D KGN060D
description	door seal W 660mm 4-sided with mounting clip H 230mm		

			
1			
Part No.	901634	Ref. No.	GN046 GN046D KGN046D
description	door seal W 660mm with 12 mounting clips H 420mm		
For models:	XV401, XV401E		

Part No.	901845	Ref. No.	KG1245A
description	door seal W 670mm 3-sided with mounting clip H 520mm		

special gaskets

miscellaneous



Part No.	511939	Ref. No.	GN1240A0
description	gasket external weith 9mm UNOX silicone		
For models:	XF003, XF023, XF043		



Part No.	504474	Ref. No.	GN1190A0
description	gasket suitable for UNOX probes L 40mm W 13mm graphite thickness 1mm		
For models:	XBC404, XBC604, XBC804, XVC054, XVC1004P, XVC104, XVC204, XVC304, XVC504, XVC704		

springs

torsion springs



Part No.	371322	Ref. No.	KML0039A RC039
description	spring kit ø 24mm wire gauge ø 3.5mm		
For models:	XP010P, XP010PR, XP010PT, XP010R, XP020, XP020P, XP020PR, XP020PT, XP020R, XP020T		



Part No.	692524	Ref. No.	KML1000A0 RC039A VI093
description	torsion spring set ø 24mm wire gauge ø 3.1mm L1 44mm Qty 1 pcs		
For models:	XP010P, XP010PR, XP010PT, XP010R, XP020, XP020P, XP020PR, XP020PT, XP020R, XP020T		

hoses

industrial hoses

PE hoses



Part No.	521186	Ref. No.	KTB2529A TB008 TB1815A0
description	hose 0.187" ext. ø 5/16" L 2m operating p. 8-16bar t.max. 65°C LLDPE white ID ø 4.7mm ED ø 8mm John Guest		
For models:	XB403, XB403G, XB603, XB603G, XB803, XB803G, XBC1005, XBC404, XBC604, XBC605, XBC804, XBC805, XBC815G, XBT146, XBT160, XC110, XC111, XC224, XC314, XC400, XC404, XC595, XF113, XF115, XF119, XF133, XF135, XF185, XF188, XF195, XG413, XG413G, XG613, XG613G, XG813, XG813G, XL091, XL314, XL404, XL405, XL504, XL505, XV1003G, XV203G, XV303G, XV703G, XVC054, XVC1004P, XVC1005P, XVC1015G... (Other models you can see in the webshop)		

fittings, hose and pipe connectors

push-in fittings

JOHN GUEST



Part No.	440015	Ref. No.	RC1002A
description	push-in fitting John Guest straight pipe connection ø8mm grommet ø 10mm		
For models:	XB613G, XB813G, XB893, XB895, XFT183, XFT185, XFT188, XFT193, XFT195, XFT199, XV513G, XV813G, XV893		
accessories for	440015		
Part No.	520972	Ref. No.	—
description	hose John Guest thickness 1mm LLDPE blue ID ø 6mm ED ø 8mm		



Part No.	440885	Ref. No.	KEL1195B
description	push-in fitting DMfit pipe connection ø 8mm grommet ø 8mm		
accessories for	440885		
Part No.	520972	Ref. No.	—
description	hose John Guest thickness 1mm LLDPE blue ID ø 6mm ED ø 8mm		

mechanical components,
equipment accessories
1

1

Part No.	440671	Ref. No.	EL1195A EL1195A0 KEL1195A KEL1195A0
description	push-in fitting John Guest angled pipe connection ø8mm grommet ø 8mm		
For models:	XB693, XB695, XB893, XB895, XBC1005, XBC404, XBC604, XBC605, XBC804, XBC805, XBC815G, XC314, XF185, XF188, XF195, XFT183, XFT185, XFT188, XFT193, XFT195, XFT199, XL195, XL404, XL405, XV593, XV893, XVC054, XVC1004P, XVC1005P, XVC1015G, XVC104, XVC105, XVC1204P, XVC2015G, XVC204, XVC205, XVC304, XVC305, XVC315G, XVC504, XVC505, XVC514G, XVC515G, XVC704, XVC705, XVC715G, XVC905P		
accessories for	440671		
	Part No.	520972	Ref. No. —
	hose John Guest thickness 1mm LLDPE blue ID ø 6mm ED ø 8mm		



1

Part No.	440592	Ref. No.	EL1185A EL1185A0 KEL1185B
description	push-in fitting John Guest angled pipe connection ø8mm - ø8mm		
For models:	XB693, XB695, XB893, XB895, XBC404, XBC405E, XBC604, XBC605, XBC605E, XBC804, XBC805, XBC815G, XC224, XF113, XF119, XF133, XF135, XFT113, XFT115, XFT119, XFT133, XFT135, XV593, XV893, XVC054, XVC1004P, XVC1015G, XVC104, XVC105, XVC1204P, XVC2015G, XVC204, XVC205, XVC304, XVC305, XVC315G, XVC504, XVC505, XVC514G, XVC515G, XVC704, XVC705, XVC715G, XVC905P		
accessories for	440592		
	Part No.	520972	Ref. No. —
	hose John Guest thickness 1mm LLDPE blue ID ø 6mm ED ø 8mm		



1

Part No.	440608	Ref. No.	D0063
description	push-in fitting John Guest straight thread 1/2" BSP stub ø 10mm		
accessories for	440608		
	Part No.	520973	Ref. No. —
	hose John Guest thickness 1.5mm LLDPE blue ID ø 7mm ED ø 10mm		



1

Part No.	440014	Ref. No.	EL1125A0
description	push-in fitting John Guest straight thread 1/2" BSP pipe connection ø8mm - ø8mm bulkhead connector		
For models:	XB403, XB403G, XB603, XB603G, XB803, XB803G, XBT146, XBT160, XG413G, XG613, XG613G, XG813, XL135, XL195, XL314, XL404, XL405, XV1003G, XV203G, XV303G, XV703G		
accessories for	440014		
	Part No.	520972	Ref. No. —
	hose John Guest thickness 1mm LLDPE blue ID ø 6mm ED ø 8mm		



1

Part No.	440551	Ref. No.	EL1210A0 KEL1210A
description	push-in fitting John Guest straight thread 1/4" BSP T pipe connection ø8mm		
For models:	XBC1005, XBC605, XBC805, XBC815G, XC404, XC595, XVC1005P, XVC1015G, XVC105, XVC205, XVC305, XVC315G, XVC505, XVC514G, XVC515G, XVC705, XVC715G, XVC905P		



1

Part No.	440028	Ref. No.	KRC1365A RC1210A1
description	push-in fitting UNOX straight Qty 1 pcs thread 3/4" pipe connection ø8 sealing flat seal		
For models:	XB1083, XB613G, XB693, XB695, XB813G, XB893, XB895, XBC1005, XBC1005E, XBC1005EL, XBC1015EG, XBC1015EGL, XBC605, XBC615EG, XBC805, XBC805E, XBC815EG, XBC815G, XBC905E, XBC905EL, XBC915EG, XBC915EGL, XFT140, XFT183, XFT185, XFT188, XFT193, XFT195, XFT199, XFT200, XV1093, XV393, XV513G, XV593, XV813G, XV893, XVC055E, XVC1005EP, XVC1005EPL, XVC1005P, XVC1015EG, XVC1015EGL, XVC1015G, XVC105, XVC105E, XVC105EP, XVC1204P, XVC1205EP, XVC1215EG, XVC2005EP...(Other models you can see in the webshop)		

DMfit



1

Part No.	440857	Ref. No.	D0064 ELO22 EL1055A0 KEL1055A
description	push-in fitting DMfit straight pipe connection ø8mm - ø10mm		
For models:	XB403, XB403G, XB603, XB603G, XB803, XB803G, XBC404, XBC604, XBC605, XBC804, XBC805, XBC815G, XBT146, XBT160, XC110, XC111, XF090P, XF113, XF115, XF119, XF133, XF135, XF185, XF188, XF195, XG413, XG413G, XG613, XG613G, XG813, XG813G, XL041, XL091, XL503, XV1003G, XV202, XV202E, XV203G, XV301, XV301E, XV303G, XV401, XV401E, XV501, XV501E, XV703G, XVC054, XVC104, XVC105, XVC1204P...(Other models you can see in the webshop)		



1

Part No.	440822	Ref. No.	EL1020A0 KEL1020A
description	push-in fitting DMfit T-piece pipe connection ø8mm - ø8mm - ø8mm		
For models:	XBC404, XBC604, XBC605, XBC804, XBC805, XBC815G, XL405, XVC1204P, XVC2015G, XVC205, XVC305, XVC505, XVC515G, XVC705, XVC715G		

water filters

miscellaneous



1

Part No.	530438	Ref. No.	KVL1034A VL1034A0
description	water filter operation p max 11bar water temperature 65°C for external tube ø (A) 8mm (B) 8mm		



1

Part No.	530439	Ref. No.	VL1034A
description	water filter type ADMF1010M operation p max 10bar water temperature 65°C for external tube ø (A) 10mm (B) 10mm		
For models:	XB1083, XB613G, XB693, XB695, XB813G, XB893, XB895, XBC1005E, XBC1005EL, XBC1015EG, XBC1015EGL, XBC405E, XBC605E, XBC615EG, XBC805E, XBC815EG, XBC905E, XBC905EL, XBC915EG, XBC915EGL, XFT140, XFT200, XV1093, XV513G, XV593, XV813G, XV893, XVC055E, XVC1005EP, XVC1005EPL, XVC1015EG, XVC1015EGL, XVC105E, XVC105EP, XVC1205EP, XVC1215EG, XVC2005EP, XVC2015EG, XVC205E, XVC305E, XVC305EP, XVC315EG, XVC4005EP, XVC4005EPL, XVC4015EG, XVC4015EGL, XVC505E, XVC505EP, XVC515EG, XVC705E...(Other models you can see in the webshop)		

beverage technology

valves

non-return valves



1

Part No.	440729	Ref. No.	KEL1180A
description	non-return valve John Guest pipe connection 5/16" - 5/16" operating pressure at 20°C 10bar opening pressure 0.02bar POM		

water cycle components

pressure reduction valves

pressure reduction valves

universal



1

Part No.	520890	Ref. No.	D0061
description	pressure reduction valve Caleffi series 5330 connection 1/2" default setting 2bar setting range 1-6bar p max 16bar t.max. 40°C angle seat chrome-plated brass WRAS/ACS		



1

Part No.	520889 ¹	Ref. No.	EL1370A0 KEL1370A
description	pressure reduction valve Caleffi series 5330 connection 1/2" default setting 2bar setting range 1-6bar p max 16bar t.max. 40°C set chrome-plated brass WRAS/ACS		
For models:	XBC1005, XBC605, XBC805, XBC815G, XVC1005P, XVC1015G, XVC105, XVC2015G, XVC205, XVC305, XVC315G, XVC505, XVC514G, XVC515G, XVC705, XVC715G, XVC905P		

¹incl. 2x John Guest hose connectors 10mm and 2x John Guest push-in fittings



producer-specific



1	Part No.	520998	Ref. No.	KVL1014A
description	pressure reduction valve connection John Guest 8mm 90° p max 2.30bar T-piece plastic connection 1: 8 plug-in connectionmm connection 2: 10 plug-in connectionmm black			
For models:	XB1083, XBC1005E, XBC1005EL, XBC1015EG, XBC1015EGL, XBC405E, XBC605E, XBC615EG, XBC805E, XBC815EG, XBC905E, XBC905EL, XBC915EG, XBC915EGL, XFT140, XFT200, XV1093, XVC055E, XVC1005EP, XVC1005EPL, XVC1015EG, XVC1015EGL, XVC105E, XVC105EP, XVC1205EP, XVC1215EG, XVC2005EP, XVC2015EG, XVC205E, XVC305E, XVC305EP, XVC315EG, XVC4005EP, XVC4005EPL, XVC4015EG, XVC4015EGL, XVC505E, XVC505EP, XVC515EG, XVC705E, XVC705EP, XVC715EG, XVC905EP, XVC905EPL, XVC915EG, XVC915EGL			



1	Part No.	520997	Ref. No.	KVL0010A
description	pressure reduction valve connection John Guest 8mm p max 2.30bar plastic black			

tools

cleaning tools

scrapers



1	Part No.	890049	Ref. No.	KVM1000A
description	scraper for ceramic hobs			
spare parts for	890049			
	Part No.	890052	Ref. No.	—
	spare blades for scraper Qty 10 pcs			



1	Part No.	890240	Ref. No.	VM1000A0 VM100A0
description	scraper for ceramic hobs			
For models:	XP010P, XP010PR, XP010PT, XP020, XP020P, XP020PR, XP020PT, XP020R, XP020T			
spare parts for	890240			
	Part No.	890241	Ref. No.	—
	spare blades for scraper Qty 5 pcs			

fastening material

screws

grub screws

DIN 914/ISO 4027



1	Part No.	504868	Ref. No.	KVI1740A KVI1740AO
description	grub screw thread M4 L 6mm stainless steel DIN 914 intake hexagonal WS 2 Qty 20 pcs			

nuts

hexagonal nuts

DIN 985



1	Part No.	560142	Ref. No.	KVI0001A
description	hexagonal nut thread M6 H 6mm SS WS 10 Qty 20 pcs DIN/ISO DIN 985 self-locking			



consumables

sealants and adhesives

high temperature silicone



1

Part No.	890050	Ref. No.	KSL1170A
description	high temperature silicone NOVASIL S76 acetoxy-curing -40 up to +265°C t.max. 280°C anthracite cartridge 310ml		
description	Novasil S56 - cartridge 310ml - anthracite - Developed for applications in the home appliance industry: - Gluing of oven door seals - Gluing of mounting brackets for cooker fascias, oven door seals and handles - Attachment of elastic seals, e.g. to oven doors Temperature resistance: -40°C to +265°C		

cleaning agents

combi-steamer detergents/descalers

Notice: Articles labelled 'DANGEROUS GOODS' are delivered by road through a forwarder for reasons of safety and are charged separately!



1

Part No.	802096	Ref. No.	DB1011A0 DB1016A0
description	detergent for combi-steamer UNOX.Det&Rinse For Rotor.KLEAN 2x5l		

fuses

fine fuses



1

Part No.	358373	Ref. No.	VG1001A0
description	fine fuse size ø5x20mm 1.6A fast-acting rated 250V		
For models:	XVC1015G, XVC315G		

fine fuse holders

1

Part No.	358177	Ref. No.	KVG1000A VE301
description	fuse holder suitable fuse ø5x20mm ø 16mm mounting ø 13mm 1-pole 6.3A rated 250V L 54mm connection Faston 6.3mm		
For models:	XG413G, XG613, XG613G, XG813, XG813G		

GASTROPARTS.COM

