



GASTROPARTS

Universo

[EN] Equipment

[DE] Geräte

[ES] Aparatos

[FR] Équipement

[IT] Attrezzature

[PL] Urządzenia

[RU] Оборудование

✉ gastroparts@gastroparts.com

☎ +48 56 657 00 66

📘 fb.com/gastroparts.global





GASTROPARTS.COM







heating elements



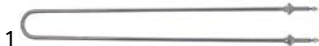

heating elements for chicken rotisseries

			
Part No.	416016	Ref. No.	0A0344
description	heating element 1700W 230V 2 hole fixing thread 1/4" L 741mm W 62mm heating circuits 1 connection M6 dry heating element tube ø 8.4mm mounting distance 54mm connection length 28mm chicken rotisserie		
For models:	GE312, GS312		
accessories for	416016		
	Part No.	361182	Ref. No. —
	nut thread 1/4" H 5mm nickel-plated brass WS 17 Qty 1 pcs		
	Part No.	510417	Ref. No. —
	flat gasket fibre ED ø 20mm ID ø 14mm thickness 2mm Qty 1 pcs		
	Part No.	520228	Ref. No. —
	tooth lock washer ID ø 15.3mm ED ø 24mm steel Qty 1 pcs for thread M14		
	Part No.	550262	Ref. No. —
	flat gasket copper ED ø 20mm ID ø 14mm thickness 2mm		

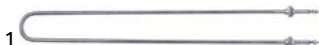
			
Part No.	416026	Ref. No.	0A0353
description	heating element 2100W 230V 2 hole fixing thread 3/8" L 745mm W 86mm heating circuits 1 connection M6 dry heating element tube ø 10mm mounting distance 76mm connection length 25mm chicken rotisserie		
For models:	GE416		
spare parts for	416026		
	Part No.	521137	Ref. No. —
	flat gasket fibre ED ø 20mm ID ø 18mm thickness 1.5mm for thread 3/8" Qty 1 pcs		
accessories for	416026		
	Part No.	361183	Ref. No. —
	nut thread 3/8" H 6mm nickel-plated brass WS 20 Qty 1 pcs		

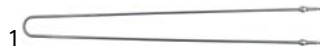
			
Part No.	416017	Ref. No.	0A0352
description	heating element 2400W 220V edition up to serial no. 5350 2 hole fixing thread 3/8" L 735mm W 80mm heating circuits 1 connection M6x1 dry heating element tube ø 10mm mounting distance 86mm chicken rotisserie		
For models:	GE246		

			
Part No.	419206	Ref. No.	0A0352B
description	heating element 2400W 230V edition from serial no. 5350 12 hole fixing thread 3/8" L 738mm W 83mm heating circuits 1 connection M6 dry heating element tube ø 10.3mm INCOLOY-800		

			
Part No.	416025	Ref. No.	A0351B
description	heating element 3000W 230V edition from serial no. 5350 2 hole fixing thread 3/8" L 1035mm W 77mm heating circuits 1 connection M6 dry heating element tube ø 10mm mounting distance 67mm connection length 23mm chicken rotisserie		
accessories for	416025		
	Part No.	361183	Ref. No. —
	nut thread 3/8" H 6mm nickel-plated brass WS 20 Qty 1 pcs		
	Part No.	521137	Ref. No. —
	flat gasket fibre ED ø 20mm ID ø 18mm thickness 1.5mm for thread 3/8" Qty 1 pcs		
	Part No.	692547	Ref. No. —
	adapter for heating element L 235mm W 40mm H 25mm steel		

switches and momentary switches



rocker/momentary rocker switches

30x22mm

blank

			
Part No.	345649	Ref. No.	GES20019
description	momentary rocker switch mounting measurements 30x22mm orange 2NO 230V 16A illuminated connection male faston 6.3mm ambient temperature max. 125/55°C protection IP65 with cover cap		
For models:	GE312, GS312		

labelled

			
Part No.	345981	Ref. No.	GES20018
description	rocker switch mounting measurements 30x22mm green 2NO 250V 16A illuminated 0-I connection male faston 6.3mm ambient temperature max. 125/55°C protection IP65 with cover cap		
For models:	GE312, GS312		
accessories for	345981		
	Part No.	301036	Ref. No. —
	protective cover internal size 30x22mm for rocker switch mounting measurementsmm		



1

Part No.	345576	Ref. No.	GES20017
description	rocker switch mounting measurements 30x22mm orange 2NO 250V 16A 0-1 connection male faston 6.3mm ambient temperature max. 100/55°C protection IP65 with cover cap		
For models:	GE246, GE312, GE366, GE416, GE960, GS246, GS312, GS366, GS416, GS488, GS960		
accessories for	345576		
	Part No.	301036	Ref. No. —
	protective cover internal size 30x22mm for rocker switch mounting measurementsmm		



1

Part No.	345648	Ref. No.	GES20016
description	rocker switch mounting measurements 30x22mm white 2NO 250V 16A illuminated 0-1 connection male faston 6.3mm ambient temperature max. 100/55°C protection IP65 with cover cap		
accessories for	345648		
	Part No.	301036	Ref. No. —
	protective cover internal size 30x22mm for rocker switch mounting measurementsmm		

rotary switches

miscellaneous



1

Part No.	345424	Ref. No.	0A0367
description	rotary switch 0-1-2-3 type I-8801 400V 25A connection screw 4 operating positions		



1

Part No.	347660	Ref. No.	0A0367 A0367B
description	rotary switch sets of contacts 4 4 0-1-2-3 type T225-I-8801GA 440V 32A shaft \varnothing 7.5mm shaft L 10mm shaft round connection screw		
For models:	GE246, GE366, GE416, GE960		

control equipment

SIEMENS

3SB series \varnothing 22mm new

push buttons



1

Part No.	345671	Ref. No.	0A0341 Start schwarz
description	push button mounting measurements \varnothing 22mm black		
For models:	GE246, GE960, GS246, GS366, GS416, GS488, GS960		



1

Part No.	345672	Ref. No.	0A0341 Stop rot
description	push button mounting measurements \varnothing 22mm red		
For models:	GE246, GE960, GS246, GS366, GS416, GS488, GS960		



1

Part No.	345669	Ref. No.	0A0330
description	contact block 1NC/1NO		
For models:	GE246, GE366, GE416, GE960, GS246, GS366, GS416, GS488, GS960		

rotary switches



1







Part No.	345674	Ref. No.	0A0358A
description	rotary selector mounting measurements \varnothing 22mm black latching sequence 0-1		
For models:	GE246, GE366, GE416, GE960, GS246, GS366, GS416, GS488, GS960		
accessories for	345674		
	Part No.	346602	Ref. No. —
	contact block SIEMENS 3SB3400-0D 2NO max 400V 10A black		
	Part No.	346603	Ref. No. —
	contact block SIEMENS 3SB3400-0E 2NC max 400V 10A black		
	Part No.	346630	Ref. No. —
	contact block SIEMENS 3SB3400-0B 1NO max 400V 10A black		
	Part No.	346631	Ref. No. —
	contact block SIEMENS 3SB3400-0C 1NC max 400V 10A black		

Table continues overleaf



accessories for	345674			
	Part No.	346632	Ref. No.	—
	contact block SIEMENS 3SB3400-0D 1NC/1NO max 400V 10A black			

			
1			
Part No.	345673	Ref. No.	OA0358B
description	rotary selector mounting measurements ø22mm black latching sequence 1-0-2		
For models:	GE246, GE366, GE416, GE960, GS246, GS366, GS416, GS488, GS960		

lamps

oven lamps

universal oven lamps

mounting diameter 35.5mm

				
1				
Part No.	359259	Ref. No.	OA0339	
description	oven lamp mounting ø 35.5mm 230V 40W socket G9 temp.-resist. 300°C connection cable 380mm hard glas			
For models:	GE246, GE312, GE366, GE416, GE960, GS246, GS312, GS366, GS416, GS488, GS960			
spare parts for	359259			
	Part No.	357161	Ref. No.	—
	lamp socket socket G9 220-230V mounting ø 35.5mm connection cable 380mm			
	Part No.	358128	Ref. No.	—
	gasket for oven lamp silicone ID ø 30mm ED ø 38mm thickness 2mm			
	Part No.	359942	Ref. No.	—
	oven lamp glass thr. ø 33.5mm ø 41mm hard glas temp.-resist. 350°C			
	Part No.	359946	Ref. No.	—
	halogen lamp socket G9 230V 40W temp.-resist. 300°C			

relays

power relays

with male contacts

bullet connectors, 8 contacts

				
1				
Part No.	380134	Ref. No.	GES20022	
description	power relays Italiana Relè 230VAC 10A 2CO connection plug-in connection round 8-pole manif. no. C42-230VAC 90.26/ZVE8 250V			
For models:	GE312, GS312			
accessories for	380134			
	Part No.	380137	Ref. No.	—
	relay socket 8-pole connection plug-in connection round 8-pole dimensions 65x28x40mm 380V voltage AC 10A Italiana Relè manif. no. ZVE8			
	Part No.	380638	Ref. No.	—
	relay socket 8-pole dimensions 51x41x23mm 250V 10A FINDER manif. no. 90.26			

motors

gear motors

for grills

			
1			
Part No.	501555	Ref. No.	GES20026+GES20032
description	gear motor MECHTEX type M14 A MSE 30 shaft ø 25mm		
			
1			
Part No.	500499	Ref. No.	GES20026
description	gear motor TRIAL type MR5 230V 50/60Hz shaft ø 5/8mm for chicken rotisserie		
For models:	GE312, GS312		





gas taps





PEL

22S/O series



1

Part No.	101086	Ref. No.	GSP041
description	gas tap PEL type 22S/O gas inlet M20x1.5 (tube \varnothing 12mm) bypass nozzle \varnothing 0.35mm gas outlet M20x1.5 (tube \varnothing 12/10mm) thermocouple connection M9x1 pilot connection M10x1 shaft \varnothing 10x8mm shaft L 25/17mm shaft flat lower		
For models:	GS246, GS366, GS488		
spare parts for	101086		
	Part No.	100259	Ref. No. —
	bypass nozzle type PEL22 bore \varnothing 0.35mm thread M6x0.5		
	Part No.	101058	Ref. No. —
	magnet unit L 39mm D1 \varnothing 15.4mm D2 \varnothing 13.5mm suitable for PEL22/EGA24197 standard		
	Part No.	101201	Ref. No. —
	gas tap front part shaft \varnothing 10x8mm shaft L 25/17mm shaft flat upper/lower suitable for PEL22		
	Part No.	101231	Ref. No. —
	thermocouple nut T1: M9x1 T2: M18x1		
	Part No.	101240	Ref. No. —
	gas connection thread M20x1.5 tube \varnothing 12/10mm for PEL gas taps with gasket and screws horizontal		
	Part No.	101460	Ref. No. —
	O-ring \varnothing 12.37mm D1 \varnothing 2.62mm suitable for PEL22		
	Part No.	101461	Ref. No. —
	screw kit suitable for PEL22 Qty 4 pcs		
accessories for	101086		
	Part No.	100908	Ref. No. —
	union screw thread M10x1 for pipe \varnothing 4mm Qty 1 pcs		
	Part No.	100909	Ref. No. —
	union screw thread M10x1 for pipe \varnothing 6mm Qty 1 pcs		
	Part No.	101241	Ref. No. —
	gas connection thread M20x1.5 tube \varnothing 12/10mm for PEL gas taps vertical		
	Part No.	101246	Ref. No. —
	olive for pipe \varnothing 4mm Qty 1 pcs		
	Part No.	101248	Ref. No. —
	olive for pipe \varnothing 12mm Qty 1 pcs suitable for PEL		
	Part No.	101249	Ref. No. —
	olive for pipe \varnothing 10mm Qty 1 pcs		
	Part No.	101250	Ref. No. —
	union nut thread M20x1.5 for pipe \varnothing 10mm		

accessories for	101086		
	Part No.	101251	Ref. No. —
	union nut thread M20x1.5 for pipe \varnothing 12mm		
	Part No.	101286	Ref. No. —
	olive ID \varnothing 6mm Qty 1 pcs		
	Part No.	110080	Ref. No. A0377 PLX20010
	knob \varnothing 70mm shaft \varnothing 10x8mm shaft flat universal		
	Part No.	112206	Ref. No. —
	knob dial plate silver gas tap PEL21/22/23 t.max.°C ED \varnothing 63mm ID \varnothing 45.5mm		

22S/V series



1

Part No.	101087	Ref. No.	PLX20009
description	gas tap PEL type 22S/V gas inlet M20x1.5 (tube \varnothing 12mm) bypass nozzle \varnothing 0.35mm gas outlet M20x1.5 (tube \varnothing 12/10mm) thermocouple connection M9x1 pilot connection M10x1 shaft \varnothing 10x8mm shaft L 25/17mm shaft flat upper		
For models:	GE312, GS312, PLX124 M, PLX47, PLX47 M, PLX60, PLX60 M, PLX80, PLX80 M		
spare parts for	101087		
	Part No.	100259	Ref. No. —
	bypass nozzle type PEL22 bore \varnothing 0.35mm thread M6x0.5		
	Part No.	101058	Ref. No. —
	magnet unit L 39mm D1 \varnothing 15.4mm D2 \varnothing 13.5mm suitable for PEL22/EGA24197 standard		
	Part No.	101201	Ref. No. —
	gas tap front part shaft \varnothing 10x8mm shaft L 25/17mm shaft flat upper/lower suitable for PEL22		
	Part No.	101231	Ref. No. —
	thermocouple nut T1: M9x1 T2: M18x1		
	Part No.	101241	Ref. No. —
	gas connection thread M20x1.5 tube \varnothing 12/10mm for PEL gas taps vertical		
	Part No.	101460	Ref. No. —
	O-ring \varnothing 12.37mm D1 \varnothing 2.62mm suitable for PEL22		
	Part No.	101461	Ref. No. —
	screw kit suitable for PEL22 Qty 4 pcs		
accessories for	101087		
	Part No.	100908	Ref. No. —
	union screw thread M10x1 for pipe \varnothing 4mm Qty 1 pcs		
	Part No.	100909	Ref. No. —
	union screw thread M10x1 for pipe \varnothing 6mm Qty 1 pcs		
	Part No.	101240	Ref. No. —
	gas connection thread M20x1.5 tube \varnothing 12/10mm for PEL gas taps with gasket and screws horizontal		

Table continues overleaf



accessories for		101087		
	Part No.	101246	Ref. No.	—
	olive for pipe ø 4mm Qty 1 pcs			
	Part No.	101248	Ref. No.	—
	olive for pipe ø 12mm Qty 1 pcs suitable for PEL			
	Part No.	101249	Ref. No.	—
	olive for pipe ø 10mm Qty 1 pcs			
	Part No.	101250	Ref. No.	—
	union nut thread M20x1.5 for pipe ø 10mm			
	Part No.	101251	Ref. No.	—
	union nut thread M20x1.5 for pipe ø 12mm			
	Part No.	101286	Ref. No.	—
	olive ID ø 6mm Qty 1 pcs			
	Part No.	110080	Ref. No.	A0377 PLX20010
	knob ø 70mm shaft ø 10x8mm shaft flat universal			
	Part No.	112206	Ref. No.	—
	knob dial plate silver gas tap PEL21/22/23 t.max.°C ED ø 63mm ID ø 45.5mm			

ignition parts

pilot burners

SIT

100 series



1

Part No.	106906	Ref. No.	PLX20004	
description	pilot burner SIT type 100 series 3 flames nozzle ø 0.2mm gas connection 6mm			
spare parts for	106906			
	Part No.	100245	Ref. No.	—
	pilot burner nozzle LPG code 20 bore ø 0.2mm Qty 1 pcs thread M8x0.75			
	Part No.	100855	Ref. No.	—
	pilot burner bracket triple			
	Part No.	100885	Ref. No.	—
	air mixing sleeve for pilot burner Qty 1 pcs			
	Part No.	100916	Ref. No.	—
	compression spring for pilot burner Qty 1 pcs			
	Part No.	100917	Ref. No.	—
	gasket for pilot burner Qty 1 pcs aluminium			
	Part No.	100918	Ref. No.	—
	screw for pilot burner			

spare parts for		106906		
	Part No.	107162	Ref. No.	—
	pilot burner cap SIT 3 flames Hmm Lmm Qty 1 pcs			
	Part No.	107701	Ref. No.	—
	pilot burner bottom part SIT 100 series nozzle ø 0.2mm			
accessories for	106906			
	Part No.	100245	Ref. No.	—
	pilot burner nozzle LPG code 20 bore ø 0.2mm Qty 1 pcs thread M8x0.75			
	Part No.	100246	Ref. No.	—
	pilot burner nozzle natural gas bore ø 0.35mm Qty 1 pcs thread M8x0.75			
	Part No.	100904	Ref. No.	—
	locking screw M10x1 for pipe ø 4mm Qty 1 pcs			
	Part No.	100905	Ref. No.	—
	locking screw M10x1 for pipe ø 6mm Qty 1 pcs			
	Part No.	102110	Ref. No.	—
	pilot tube copper pipe ø 4mm thickness 1mm L 3000mm			
	Part No.	102111	Ref. No.	—
	pilot tube copper pipe ø 6mm thickness 1mm L 3000mm			
	Part No.	107171	Ref. No.	—
	pilot burner nozzle SIT natural/liquid gas bore ø 0.25mm Qty 1 pcs			
	Part No.	107700	Ref. No.	—
	pilot burner bottom part SIT 100 series nozzle ø 0.25mm			
	Part No.	107702	Ref. No.	—
	pilot burner bottom part SIT 100 series nozzle ø 0.35mm			

POLIDORO

pilot burners















1

Part No.	100079	Ref. No.	GS20030	
description	pilot burner POLIDORO 3 flames code gas connectionmm			
For models:	GE312, GS246, GS312, GS366, GS416, GS488, GS960			
accessories for	100079			
	Part No.	100000	Ref. No.	—
	pilot burner nozzle POLIDORO LPG code 22 bore ø 0.22mm Qty 1 pcs			
	Part No.	100208	Ref. No.	—
	pilot burner nozzle POLIDORO LPG code 20 bore ø 0.2mm Qty 1 pcs			
	Part No.	100209	Ref. No.	—
	pilot burner nozzle POLIDORO natural gas code 40 bore ø 0.4mm Qty 1 pcs			
	Part No.	100701	Ref. No.	GS20038
	ignition electrode connection M4 Qty 1 pcs			

Table continues overleaf



accessories for		100079	
Part No.	Ref. No.	Part No.	Ref. No.
	100906	—	—
screw connection thread M10x1 for ignition electrode brass Qty 1 pcs WS 10			
	100907	—	—
screw connection thread M10x1 Qty 1 pcs type SEF 1 ømm for thermocouple			
	100908	—	—
union screw thread M10x1 for pipe ø 4mm Qty 1 pcs			
	100909	—	—
union screw thread M10x1 for pipe ø 6mm Qty 1 pcs			
	102110	—	—
pilot tube copper pipe ø 4mm thickness 1mm L 3000mm			
	102111	—	—
pilot tube copper pipe ø 6mm thickness 1mm L 3000mm			
	102699	—	—
pilot burner nozzle POLIDORO natural gas code 25.2 bore ø 2x0.25mm Qty 1 pcs 2 bores			
	102795	—	—
olive for pipe ø 4mm Qty 1 pcs			
	102797	—	—
olive for pipe ø 6mm Qty 1 pcs			
	106703	—	—
pilot burner nozzle POLIDORO natural gas code 27.2 bore ø 2x0.27mm Qty 1 pcs			
	106704	—	—
pilot burner nozzle POLIDORO LPG code 16.2 bore ø 2x0.16mm Qty 1 pcs			
	106763	—	—
pilot burner nozzle POLIDORO natural gas code 27.2A bore ø 2x 0.27mm Qty 1 pcs			
	106859	—	—
pilot burner nozzle POLIDORO LPG code 24 bore ø 0.24mm Qty 1 pcs			

electrodes

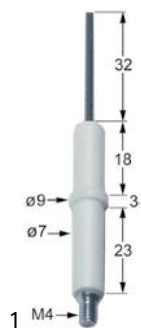

Part No.	100701	Ref. No.	GS20038
description	ignition electrode connection M4 Qty 1 pcs		
For models:	GE312, GS246, GS312, GS366, GS416, GS488, GS960		
accessories for	100701		
	Part No.	100906	Ref. No. —
screw connection thread M10x1 for ignition electrode brass Qty 1 pcs WS 10			

ignition cables

pre-assembled cables



Part No.	100018	Ref. No.	PLX20008
description	ignition cable cable length 600mm connection ø2.4mm / ø4mm permanent temperature 200°C		
For models:	GE312, GS246, GS312, GS366, GS416, GS488, PLX124 M, PLX47, PLX47 M, PLX60, PLX60M, PLX80, PLX80 M		

piezoelectric igniters

mounting diameter 18mm



Part No.	100003	Ref. No.	PLX20001
description	piezoelectric igniter body metal blowing mounting ø 18mm connection F2.8x0.8		
For models:	GE312, GS246, GS312, GS366, GS416, GS488, GS960, PLX124 M, PLX47, PLX47 M, PLX60, PLX60M, PLX80, PLX80 M		

thermocouples

plug-in thermocouples

plug-in thermocouples standard

with barrel socket ø6(6.5)mm

thermocouples SIT

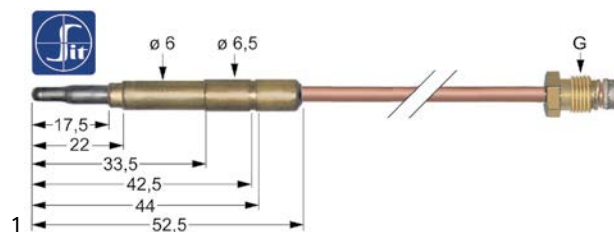

Part No.	107609	Ref. No.	PLX20039
description	thermocouple SIT M9x1 L 600mm plug connection ø6.0(6.5)mm		
For models:	GE312, GS246, GS312, GS366, GS416, GS488, GS960, PLX124 M, PLX47, PLX47 M, PLX60, PLX60M, PLX80, PLX80 M		



gas burners

bar burners

bar burners



1

Part No.	105421	Ref. No.	PLX20002
description	bar burner 3 row L 480mm W 305mm ømm H 50mm chargrill		
For models:	PLX47, PLX47 M, PLX80, PLX80 M		



1

Part No.	105422	Ref. No.	PLX20003
description	bar burner 4 row L 480mm W 450mm ømm chargrill		
For models:	PLX124 M, PLX60, PLX60M		



1

Part No.	105429	Ref. No.	GSP080
description	bar burner angled L 1220mm W 403mm ømm Hmm chicken rotisserie		
For models:	GS366, GS488		



1

Part No.	105428	Ref. No.	GS20032
description	bar burner angled L 880mm W 330mm ømm Hmm chicken rotisserie		
For models:	GE312, GS246, GS312, GS416		



1

Part No.	211013	Ref. No.	PLX20030
description	lava rock grid L 450mm W 230mm H 20mm		
For models:	PLX124 M, PLX60, PLX60 M		



1

Part No.	105341	Ref. No.	PLX20029
description	lava rock grid L 450mm W 330mm		
For models:	PLX47, PLX47 M, PLX80, PLX80 M		

lava rock grids



1

Part No.	211013	Ref. No.	PLX20030
description	lava rock grid L 450mm W 230mm H 20mm		
For models:	PLX124 M, PLX60, PLX60 M		



1

Part No.	105341	Ref. No.	PLX20029
description	lava rock grid L 450mm W 330mm		
For models:	PLX47, PLX47 M, PLX80, PLX80 M		

gas nozzles

main nozzles

gas nozzles M13x1



1

Part No.	102780	Ref. No.	PLX20012 115
description	gas injector thread M13x1 bore ø 1.15mm WS 13		



1

Part No.	102471	Ref. No.	PLX20012 230
description	gas injector thread M13x1 bore ø 2.3mm WS 13		



1

Part No.	102790	Ref. No.	
description	gas injector thread M13x1 bore ø 2.55mm WS 13		



1

Part No.	102470	Ref. No.	PLX20012 200
description	gas injector thread M13x1 bore ø 2mm WS 13		

gas nozzles sets



1

Part No.	102469	Ref. No.	SET PLX80 G30
description	gas injector set LPG PLX80 UNIVERSO		



1

Part No.	102475	Ref. No.	SET PLX106 G20
description	gas injector set natural gas PLX106 UNIVERSO		



1

Part No.	102472	Ref. No.	SET PLX47 G20
description	gas injector set natural gas PLX47 UNIVERSO		



1

Part No.	102473	Ref. No.	SET PLX60 G20
description	gas injector set natural gas PLX60 UNIVERSO		



1

Part No.	102474	Ref. No.	SET PLX80 G20
description	gas injector set natural gas PLX80 UNIVERSO		

equipment-specific units

for chicken rotisserie

skewer intakes



1

Part No.	690508	Ref. No.	GES20032
description	skewer intake		
For models:	GE312, GS312		



1

Part No.	690690	Ref. No.	BV18
description	skewer intake thread M16x1.5 D1 ø 25mm D2 ø 12.5mm L 71mm		

skewers



1

Part No.	693794	Ref. No.	GSP031
description	skewer chicken rotisserie L 785mm complete W 120mm		
For models:	GS246		



1

Part No.	689997	Ref. No.	A086 GES30030
description	skewer with skewer clamps for chicken rotisserie L 800mm thickness 10x10mm stainless steel		

spit clamp



1

Part No.	689998	Ref. No.	A.048
description	skewer clamp double for chicken rotisserie mounting pos. centre skewer 12x12mm		



miscellaneous



1

Part No.	689999	Ref. No.	GE20015
description	bracket for heating element L 75mm W 43mm H 18mm stainless steel		

handles and hand wheels

cylindrical handles

fixed



1

Part No.	698652	Ref. No.	PLX20011
description	cylindrical handle thread M10 ø 27.5mm L 90.5mm plastic black		

GASTROPARTS.COM

