



**GASTROPARTS**

# Univer-Bar

- [EN]** Equipment
- [DE]** Geräte
- [ES]** Aparatos
- [FR]** Équipement
- [IT]** Attrezzature
- [PL]** Urządzenia
- [RU]** Оборудование

✉ [gastroparts@gastroparts.com](mailto:gastroparts@gastroparts.com)

☎ +48 56 657 00 66

📘 [fb.com/gastroparts.global](https://fb.com/gastroparts.global)

**GASTROPARTS.COM**









# heating elements

## immersion heating elements

### 3 hole flange ø47.5mm



<b>Part No.</b>	416318	<b>Ref. No.</b>	3010
<b>description</b>	heating element 3000W 230V mounting ø 47.5mm heating circuits 3 L 265mm W 32mm H 33mm number of thermostat sleeves 1 thermostat sleeves ø 6.5mm length thermostat sleeves 235mm thermostat sleeve eccentric, non clinging tube ø 6.5mm connection M4		
<b>accessories for</b>	416318		
	<b>Part No.</b>	<b>Ref. No.</b>	4011
	510408		
	O-ring EPDM thickness 5.34mm ID ø 47mm Qty 1 pcs		
	<b>Part No.</b>	<b>Ref. No.</b>	—
	510562		
	O-ring silicone thickness 5.34mm ID ø 47mm Qty 1 pcs		



<b>Part No.</b>	416329	<b>Ref. No.</b>	3371
<b>description</b>	heating element 4500W 230V mounting ø 47.5mm heating circuits 3 L 370mm W 33mm H 37mm number of thermostat sleeves 1 thermostat sleeves ø 7mm length thermostat sleeves 235mm thermostat sleeve eccentric, non clinging tube ø 6.5mm connection M4 3 hole flange		
<b>spare parts for</b>	416329		
	<b>Part No.</b>	<b>Ref. No.</b>	4011
	510408		
	O-ring EPDM thickness 5.34mm ID ø 47mm Qty 1 pcs		

### with compression flange 62 x 26mm









<b>Part No.</b>	415266	<b>Ref. No.</b>	2011
<b>description</b>	heating element 2000W 230V heating circuits 1 compression flange flange 62x26mm L 300mm W 41mm Hmm connection male faston 6.3mm tube ø 6.3mm immersion heater		



<b>Part No.</b>	416307	<b>Ref. No.</b>	1532
<b>description</b>	heating element 2000W 230V heating circuits 1 flange 62x26mm L 270mm W 42mm H 27mm tube ø 6mm connection male faston 6.3mm		

### with round flange ø47.5mm



<b>Part No.</b>	416306	<b>Ref. No.</b>	2010
<b>description</b>	heating element 2000W 220V heating circuits 1 mounting ø 47.5mm L 270mm W 38mm H 22mm connection M4 tube ø 6mm thermostat sleeves ø 7.5mm number of thermostat sleeves 1 length thermostat sleeves 200mm thermostat sleeve eccentric, non clinging		
<b>accessories for</b>	416306		
	<b>Part No.</b>	<b>Ref. No.</b>	4011
	510408		
	O-ring EPDM thickness 5.34mm ID ø 47mm Qty 1 pcs		
	<b>Part No.</b>	<b>Ref. No.</b>	—
	510562		
	O-ring silicone thickness 5.34mm ID ø 47mm Qty 1 pcs		
	<b>Part No.</b>	<b>Ref. No.</b>	—
	520235		
	3 hole flange hole distance 70.5mm perforation ø 6.5mm ID ø 53.5mm		
	<b>Part No.</b>	<b>Ref. No.</b>	—
	520236		
	flange for heating element ID ø 50mm ED ø 90mm hole ø 6.5mm 3 holes		
	<b>Part No.</b>	<b>Ref. No.</b>	3136
	550002		
	tension strap H 10mm L 21mm W 10mm hole ø 6.5mm for heating element		
	<b>Part No.</b>	<b>Ref. No.</b>	—
	550362		
	blind flange ø 64mm mounting ø 47.5mm		























<b>Part No.</b>	416319	<b>Ref. No.</b>	4599
<b>description</b>	heating element 2000W 230V heating circuits 1 mounting ø 47.5mm L 275mm W 39mm H 35mm connection M4 H1 21mm H2 14mm		
<b>spare parts for</b>	416319		
	<b>Part No.</b>	<b>Ref. No.</b>	4011
	510408		
	O-ring EPDM thickness 5.34mm ID ø 47mm Qty 1 pcs		
<b>accessories for</b>	416319		
	<b>Part No.</b>	<b>Ref. No.</b>	—
	510562		
	O-ring silicone thickness 5.34mm ID ø 47mm Qty 1 pcs		
	<b>Part No.</b>	<b>Ref. No.</b>	—
	520235		
	3 hole flange hole distance 70.5mm perforation ø 6.5mm ID ø 53.5mm		
	<b>Part No.</b>	<b>Ref. No.</b>	—
	520236		
	flange for heating element ID ø 50mm ED ø 90mm hole ø 6.5mm 3 holes		

Table continues overleaf



<b>accessories for</b>	416319		
	Part No.	550002	Ref. No. 3136
	tension strap H 10mm L 21mm W 10mm hole $\varnothing$ 6.5mm for heating element		
	Part No.	550362	Ref. No. —
	blind flange $\varnothing$ 64mm mounting $\varnothing$ 47.5mm		

<b>1</b>			
<b>Part No.</b>	416327	<b>Ref. No.</b>	4552
<b>description</b>	heating element 3000W 230V heating circuits 3 mounting $\varnothing$ 47.5mm L 280mm W 28mm H 60mm connection M4 tube $\varnothing$ 6.25mm H1 24mm H2 36mm		
<b>accessories for</b>	416327		
	Part No.	510408	Ref. No. 4011
	O-ring EPDM thickness 5.34mm ID $\varnothing$ 47mm Qty 1 pcs		
	Part No.	510562	Ref. No. —
	O-ring silicone thickness 5.34mm ID $\varnothing$ 47mm Qty 1 pcs		
	Part No.	520235	Ref. No. —
	3 hole flange hole distance 70.5mm perforation $\varnothing$ 6.5mm ID $\varnothing$ 53.5mm		
	Part No.	520236	Ref. No. —
	flange for heating element ID $\varnothing$ 50mm ED $\varnothing$ 90mm hole $\varnothing$ 6.5mm 3 holes		
	Part No.	550002	Ref. No. 3136
	tension strap H 10mm L 21mm W 10mm hole $\varnothing$ 6.5mm for heating element		
	Part No.	550362	Ref. No. —
	blind flange $\varnothing$ 64mm mounting $\varnothing$ 47.5mm		

<b>1</b>			
<b>Part No.</b>	416317	<b>Ref. No.</b>	4551
<b>description</b>	heating element 6000W 230V heating circuits 3 mounting $\varnothing$ 47.5mm L 400mm W 36mm H 36mm connection M4 tube $\varnothing$ 6.2mm thermostat sleeves $\varnothing$ 7mm number of thermostat sleeves 1 length thermostat sleeves 235mm thermostat sleeve eccentric, non clinging		
<b>spare parts for</b>	416317		
	Part No.	510408	Ref. No. 4011
	O-ring EPDM thickness 5.34mm ID $\varnothing$ 47mm Qty 1 pcs		
<b>accessories for</b>	416317		
	Part No.	510562	Ref. No. —
	O-ring silicone thickness 5.34mm ID $\varnothing$ 47mm Qty 1 pcs		
	Part No.	520235	Ref. No. —
	3 hole flange hole distance 70.5mm perforation $\varnothing$ 6.5mm ID $\varnothing$ 53.5mm		
	Part No.	520236	Ref. No. —
	flange for heating element ID $\varnothing$ 50mm ED $\varnothing$ 90mm hole $\varnothing$ 6.5mm 3 holes		
	Part No.	550002	Ref. No. 3136
	tension strap H 10mm L 21mm W 10mm hole $\varnothing$ 6.5mm for heating element		
	Part No.	550362	Ref. No. —
	blind flange $\varnothing$ 64mm mounting $\varnothing$ 47.5mm		

## accessories

## sealing washers

## O-rings

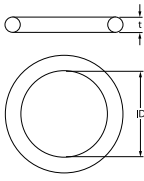
<b>1</b>			
			
<b>Part No.</b>	510408	<b>Ref. No.</b>	4011
<b>description</b>	O-ring EPDM thickness 5.34mm ID $\varnothing$ 47mm Qty 1 pcs		

## flange gaskets

## counterflanges

<b>1</b>			
<b>Part No.</b>	550002	<b>Ref. No.</b>	3136
<b>description</b>	tension strap H 10mm L 21mm W 10mm hole $\varnothing$ 6.5mm for heating element		

<b>1</b>			
<b>Part No.</b>	550002	<b>Ref. No.</b>	3136
<b>description</b>	tension strap H 10mm L 21mm W 10mm hole $\varnothing$ 6.5mm for heating element		

## thermostats

## bi-metal thermostats

## safety bi-metal thermostats

<b>1</b>			
<b>Part No.</b>	390455	<b>Ref. No.</b>	4751
<b>description</b>	bi-metal safety thermostat hole distance 40mm switch-off temp. 100°C 2NC 2-pole 16A connection F6.3 2 hole fixing		



control and safety thermostats

IMIT / TEMPOMATIC / ARTHERMO

control thermostats

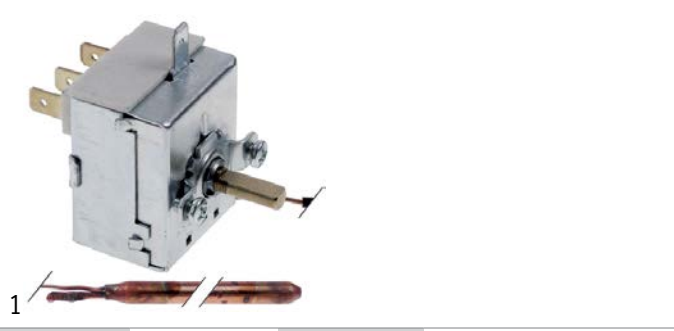

<b>Part No.</b>	375920	<b>Ref. No.</b>	4044
<b>description</b>	thermostat t.max. 90°C temperature range 0-90°C 1-pole 1CO 16A probe ø 6.5mm probe L 98mm capillary pipe 1030mm capillary pipe isolated 970mm gland nut shaft ø 6x4.6mm shaft L 16mm rotation 270° probe material copper 250V		

accessories

plunger sockets



<b>Part No.</b>	507462	<b>Ref. No.</b>	1503
<b>description</b>	thermowell thread M10x1 ID ø 7.7mm L 115mm for probe 100mm for probe ø 7mm		

switches and momentary switches

rocker/momentary rocker switches

30x22mm



<b>Part No.</b>	345317	<b>Ref. No.</b>	1519 1520
<b>description</b>	momentary rocker switch mounting measurements 30x22mm green 2NO 230V 16A illuminated connection male faston 6.3mm ambient temperature max. 125/55°C protection IP65 with rubber collar		



<b>Part No.</b>	347531	<b>Ref. No.</b>	4069
<b>description</b>	rocker switch mounting measurements 30x22mm green 2NO 250V 20A illuminated 0-I connection male faston 6.3mm ambient temperature max. 125/55°C protection IP65 with rubber collar		



<b>Part No.</b>	346474	<b>Ref. No.</b>	4671
<b>description</b>	dummy element external size 30x22mm suitable for rocker switch		

blank



<b>Part No.</b>	345982	<b>Ref. No.</b>	1521
<b>description</b>	rocker switch mounting measurements 30x22mm green 2CO 250V 16A illuminated connection male faston 6.3mm ambient temperature max. 125/55°C protection IP65 with cover cap		

<b>accessories for</b>	345982	<b>Part No.</b>	301036	<b>Ref. No.</b>	—
	protective cover internal size 30x22mm for rocker switch mounting measurementsmm				

labelled

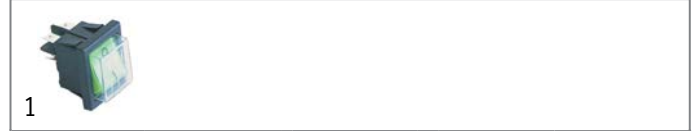

<b>Part No.</b>	300125	<b>Ref. No.</b>	4070
<b>description</b>	rocker switch mounting measurements 30x22mm green 2NO 230V 16A 0-I connection male faston 6.3mm ambient temperature max. 125/55°C protection IP65 with cover cap		

<b>accessories for</b>	300125	<b>Part No.</b>	301036	<b>Ref. No.</b>	—
	protective cover internal size 30x22mm for rocker switch mounting measurementsmm				

microswitches

lever actuated





<b>Part No.</b>	346067	<b>Ref. No.</b>	4074
<b>description</b>	microswitch with lever 250V 16A 1CO connection male faston 6.3mm ambient temperature max. 125°C lever length 30mm		



<b>Part No.</b>	345257	<b>Ref. No.</b>	4095
<b>description</b>	microswitch with lever 250V 16A 1CO connection male faston 6.3mm L 29mm L1 33mm ambient temperature max. 120°C mounting distance 22mm actuating force: 130g lever length 31.5mm		

			
1			
<b>Part No.</b>	347607	<b>Ref. No.</b>	4780
<b>description</b>	microswitch with lever 250V 16A 1CO connection male faston 6.3mm L 77mm ambient temperature max. 85°C lever length 48mm		

			
1			
<b>Part No.</b>	346064	<b>Ref. No.</b>	4762
<b>description</b>	microswitch with lever 250V 16A 3CO connection male faston 6.3mm ambient temperature max. 125°C lever length 75mm		

			
1			
<b>Part No.</b>	360415	<b>Ref. No.</b>	1507
<b>description</b>	timer CROUZET engines 1 chambers 4 operation time 120s 230V shaft ømm shaft Lmm manuf. no. 642/5180 motor type 82340		

**lamps**

indicator lights

indicator lights (complete)

ø 6mm

			
1			
<b>Part No.</b>	359434	<b>Ref. No.</b>	1513
<b>description</b>	indicator light ø 6mm 230V green		

**timers**

programme timers

			
1			
<b>Part No.</b>	360432	<b>Ref. No.</b>	4516
<b>description</b>	timer CDC 7802DV engines 2 chambers 2 operation time 1min / 2min 230V shaft ømm shaft Lmm motor type M37RN/M37LN		

			
1			
<b>Part No.</b>	360416	<b>Ref. No.</b>	1912 4090
<b>description</b>	timer CROUZET engines 1 chambers 2 operation time 120s 230V shaft ø 6x4.6mm shaft L 20mm manuf. no. 627/5280 motor type 82340		

**contactors**

ALLEN BRADLEY

power contactors

			
1			
<b>Part No.</b>	380468	<b>Ref. No.</b>	3045
<b>description</b>	power contactor resistive load 20A 230VAC (AC3/400V) 9A/4kW main contacts 4NO connection screw connection type 100-K09*400		

**relays**

power relays

with flange mounting

			
1			
<b>Part No.</b>	380020	<b>Ref. No.</b>	4360
<b>description</b>	power relays FINDER 230VAC 15A 2NO connection male faston 6.3mm manuf. no. 62.82.8.230.0300+062.10 2-pole		



with bracket mounting



1			
<b>Part No.</b>	380815	<b>Ref. No.</b>	4637
<b>description</b>	power relays 230VAC 16A 2NO connection male faston 6.3mm flange dimensions 36x38x68mm		

electronics

PCBs



1			
<b>Part No.</b>	403894	<b>Ref. No.</b>	3845
<b>description</b>	electronic timer L 125mm W 85mm		



1			
<b>Part No.</b>	403895	<b>Ref. No.</b>	4851
<b>description</b>	PCB L 135mm W 85mm		



1			
<b>Part No.</b>	692214	<b>Ref. No.</b>	4850
<b>description</b>	PCB warewashing MID15/COSMO/ERGON L 133mm W 84mm 50/60Hz voltage input 230/240 VacV 230V 17A		

solenoid valves

solenoid valves (water)

TP





1			
<b>Part No.</b>	370021	<b>Ref. No.</b>	4076
<b>description</b>	solenoid valve double straight 230VAC inlet 3/4" outlet 11.5mm DN10 TP flow regulating valve inlet white		
<b>spare parts for</b>	370021		
	<b>Part No.</b>	371013	<b>Ref. No.</b>
			—
	solenoid coil TP 230VAC 50/60Hz		

accessories for		370021	
Part No.		371220	Ref. No.
	reducer TP flow rate 3l/min red tolerance ±15%		—
	reducer TP flow rate 5.5l/min yellow tolerance ±15%		—
	reducer TP flow rate 6l/min grey tolerance ±15%		—
	reducer TP flow rate 10l/min white tolerance ±15%		—
	reducer TP flow rate 12l/min bronze tolerance ±15%		—
	reducer TP flow rate 16l/min light brown tolerance ±15%		—
	reducer TP flow rate 20l/min red tolerance ±15%		—
	reducer TP flow rate 0.25l/min red tolerance ±25%		—
	reducer TP flow rate 0.35l/min violet tolerance ±25%		—
	reducer TP flow rate 0.5l/min orange tolerance ±25%		—
	reducer TP flow rate 0.8l/min white tolerance ±25%		—
	reducer TP flow rate 1l/min light blue tolerance ±25%		—
	reducer TP flow rate 1.2l/min brown tolerance ±25%		—
	reducer TP flow rate 1.5l/min light brown tolerance ±25%		—
	reducer TP flow rate 2.5l/min yellow tolerance ±25%		—
	reducer TP flow rate 3.4l/min dark green tolerance ±25%		—
	reducer TP flow rate 5l/min black tolerance ±25%		—
	reducer TP flow rate 8l/min blue tolerance ±20%		—



			
			
<b>Part No.</b>	370017	<b>Ref. No.</b>	4075
<b>description</b>	solenoid valve single straight 230VAC inlet 3/4" outlet 11.5mm DN10 TP p max 10bar		
<b>spare parts for</b>	370017		
	Part No.	371013	Ref. No. —
solenoid coil TP 230VAC 50/60Hz			
<b>accessories for</b>	370017		
	Part No.	371220	Ref. No. —
reducer TP flow rate 3l/min red tolerance ±15%			
	Part No.	371221	Ref. No. —
reducer TP flow rate 5.5l/min yellow tolerance ±15%			
	Part No.	371222	Ref. No. —
reducer TP flow rate 6l/min grey tolerance ±15%			
	Part No.	371223	Ref. No. —
reducer TP flow rate 10l/min white tolerance ±15%			
	Part No.	371224	Ref. No. —
reducer TP flow rate 12l/min bronze tolerance ±15%			
	Part No.	371225	Ref. No. —
reducer TP flow rate 16l/min light brown tolerance ±15%			
	Part No.	371226	Ref. No. —
reducer TP flow rate 20l/min red tolerance ±15%			
	Part No.	371230	Ref. No. —
reducer TP flow rate 0.25l/min red tolerance ±25%			
	Part No.	371231	Ref. No. —
reducer TP flow rate 0.35l/min violet tolerance ±25%			
	Part No.	371232	Ref. No. —
reducer TP flow rate 0.5l/min orange tolerance ±25%			
	Part No.	371233	Ref. No. —
reducer TP flow rate 0.8l/min white tolerance ±25%			
	Part No.	371234	Ref. No. —
reducer TP flow rate 1l/min light blue tolerance ±25%			
	Part No.	371235	Ref. No. —
reducer TP flow rate 1.2l/min brown tolerance ±25%			
	Part No.	371236	Ref. No. —
reducer TP flow rate 1.5l/min light brown tolerance ±25%			
	Part No.	371237	Ref. No. —
reducer TP flow rate 2.5l/min yellow tolerance ±25%			

<b>accessories for</b>	370017		
	Part No.	371238	Ref. No. —
reducer TP flow rate 3.4l/min dark green tolerance ±25%			
	Part No.	371239	Ref. No. —
reducer TP flow rate 5l/min black tolerance ±25%			
	Part No.	371240	Ref. No. —
reducer TP flow rate 8l/min blue tolerance ±20%			















			
			
<b>Part No.</b>	370016	<b>Ref. No.</b>	4078
<b>description</b>	solenoid valve single angled 230VAC inlet 3/4" outlet 14mm DN10 TP		
<b>spare parts for</b>	370016		
	Part No.	371013	Ref. No. —
solenoid coil TP 230VAC 50/60Hz			
<b>accessories for</b>	370016		
	Part No.	371220	Ref. No. —
reducer TP flow rate 3l/min red tolerance ±15%			
	Part No.	371221	Ref. No. —
reducer TP flow rate 5.5l/min yellow tolerance ±15%			
	Part No.	371222	Ref. No. —
reducer TP flow rate 6l/min grey tolerance ±15%			
	Part No.	371223	Ref. No. —
reducer TP flow rate 10l/min white tolerance ±15%			
	Part No.	371224	Ref. No. —
reducer TP flow rate 12l/min bronze tolerance ±15%			
	Part No.	371225	Ref. No. —
reducer TP flow rate 16l/min light brown tolerance ±15%			
	Part No.	371226	Ref. No. —
reducer TP flow rate 20l/min red tolerance ±15%			
	Part No.	371230	Ref. No. —
reducer TP flow rate 0.25l/min red tolerance ±25%			
	Part No.	371231	Ref. No. —
reducer TP flow rate 0.35l/min violet tolerance ±25%			
	Part No.	371232	Ref. No. —
reducer TP flow rate 0.5l/min orange tolerance ±25%			
	Part No.	371233	Ref. No. —
reducer TP flow rate 0.8l/min white tolerance ±25%			

Table continues overleaf



accessories for		370016		
Part No.	Ref. No.	Part No.	Ref. No.	—
	371234	371234	Ref. No.	—
reducer TP flow rate 1l/min light blue tolerance ±25%				
	371235	371235	Ref. No.	—
reducer TP flow rate 1.2l/min brown tolerance ±25%				
	371236	371236	Ref. No.	—
reducer TP flow rate 1.5l/min light brown tolerance ±25%				
	371237	371237	Ref. No.	—
reducer TP flow rate 2.5l/min yellow tolerance ±25%				
	371238	371238	Ref. No.	—
reducer TP flow rate 3.4l/min dark green tolerance ±25%				
	371239	371239	Ref. No.	—
reducer TP flow rate 5l/min black tolerance ±25%				
	371240	371240	Ref. No.	—
reducer TP flow rate 8l/min blue tolerance ±20%				
	503139	503139	Ref. No.	—
solenoid valve filter ø 19.5mm H 16mm				

solenoid valves with reducers

1			
Part No.	Ref. No.	Part No.	Ref. No.
370142	1542	370142	1542
description solenoid valve double straight 230VAC inlet 3/4" outlet 11.5mm output B 0.6l/min			

pressure switches

for warewashing

ø 58mm with male faston 6.3mm

with connection horizontal

1			
Part No.	Ref. No.	Part No.	Ref. No.
541140	4054	541140	4054
description pressure control pressure range 55/30mbar connection 6mm ø 58mm pressure connection horizontal warewashing			

R404a/R507

LBP monophase

Lower evaporation temperature below -20°C



Part No.	Ref. No.	Part No.	Ref. No.
605056	T2178GK	605056	T2178GK
description compressor coolant R404a/R507 type SC18CLX.2 220-240V 50Hz LBP fully hermetic 13.7kg 5/8HP cylinder capacity 17.69cm³ CSR H 219mm 562W 691W 881W 1095W 1332W 1593WWWW test method ASHRAE			
spare parts for 605056			
Part No.	381548	Ref. No.	—
start relay DANFOSS			

pumps

wash and rinse pumps

FIR

pumps





Part No.	Ref. No.	Part No.	Ref. No.
500457	3823	500457	3823
description pump inlet ø 28mm outlet ø 26mm type 2213.1417 230V 50Hz 1 phase 0.15kW 0.2HP L 198mm rotation direction left capacitor 6.3µF FIR			
spare parts for 500457			
Part No.	365012	Ref. No.	—
operating capacitor capacity 6.3µF 450V tolerance 5% 50Hz ambient temperature max. -25 to +85°C ø 30mm L 61mm M8 plastic connection male faston 6.3mm protection			

Table continues overleaf





<b>spare parts for</b>	500457		
	Part No.	510384	Ref. No. —
	pump cover inlet ø 28mm outlet ø 26mm ø 100mm ID ø 76mm		
	Part No.	510695	Ref. No. —
	mechanical shaft seal height counter ring 5.5mm ID ø 11mm		
	Part No.	521703	Ref. No. —
	pump cover gasket EPDM thickness 2.5mm ID ø 75mm Qty 1 pcs		



1

<b>Part No.</b>	500683	<b>Ref. No.</b>	4718
<b>description</b>	pump inlet ø 60mm outlet ø 50mm type 2223.U150 230V 50Hz 1 phase 0.89kW 1.2HP L 260mm rotation direction right capacitor 16µF FIR		
<b>spare parts for</b>	500683		
	Part No.	365021	Ref. No. —
	operating capacitor capacity 16µF 425V tolerance 5% 50/60Hz ambient temperature max. -25 to +85°C ø 35mm L 73mm single M8 plastic connection male faston 6.3mm 416.10.99 protection		
	Part No.	510552	Ref. No. —
	pump cover gasket pump type 1292-2/3942/3981/3911/3983		
	Part No.	510600	Ref. No. —
	impeller ø 102mm H 29mm shaft intake ø 9/8mm rotation direction right blades 6		
	Part No.	510692	Ref. No. —
	mechanical shaft seal for shaft ø 11mm slide ring ext. ø 24mm slide ring H 13mm counter ring mounting ø 26mm height counter ring 8mm counter ring int. ø 14mm		
	Part No.	521511	Ref. No. —
	pump cover inlet ø 60mm outlet ø 50/30mm supporting pressure M12x1.75 supporting pressure open pump type 2233 turn direction right ø 160mm ID ø 120mm inner height 23mm		

OLYMPIA pumps



1

<b>Part No.</b>	500000	<b>Ref. No.</b>	4112
<b>description</b>	pump inlet ø 29mm outlet ø 28mm type T 4 230V 50Hz 1 phase 0.29kW 0.39HP L 202mm rotation direction left capacitor 8µF OLYMPIA		
<b>spare parts for</b>	500000		
	Part No.	365013	Ref. No. —
	operating capacitor capacity 8µF 400V tolerance 5%Hz ambient temperature max. -25 to +85°C ø 31.5mm L 55mm M8 plastic connection male faston 6.3mm protection		
	Part No.	510554	Ref. No. —
	O-ring EPDM thickness 2mm ID ø 120mm Qty 1 pcs		
	Part No.	510693	Ref. No. —
	mechanical shaft seal for shaft ø 12mm slide ring ext. ø 24mm slide ring H 15.5mm slide ring int. ø 11mm counter ring mounting ø 24mm height counter ring 8mm counter ring int. ø 13.5mm		
	Part No.	521176	Ref. No. —
	pump cover OLYMPIA inlet ø 1"mm outlet ø 28mm pump type T 4		
	Part No.	521257	Ref. No. —
	impeller ø 80mm H 12mm rotation direction left thread M10R shaft ø 12mm shaft length 7.5mm blades 6		

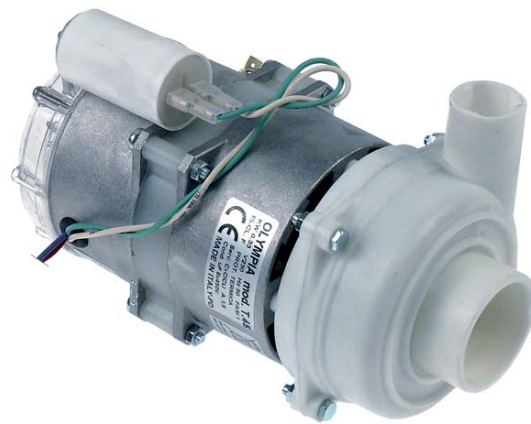

1









<b>Part No.</b>	500476	<b>Ref. No.</b>	1808
<b>description</b>	pump inlet ø 50mm outlet ø 30mm type T45 230V 50Hz 1 phase 0.33kW 0.45HP L 215mm rotation direction left capacitor 8µF OLYMPIA		
<b>spare parts for</b>	500476		
	Part No.	365013	Ref. No. —
	operating capacitor capacity 8µF 400V tolerance 5%Hz ambient temperature max. -25 to +85°C ø 31.5mm L 55mm M8 plastic connection male faston 6.3mm protection		

Table continues overleaf



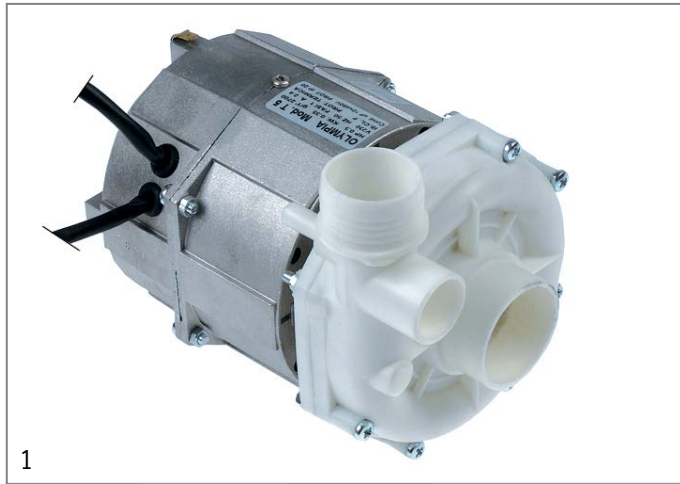

spare parts for 500476			
	Part No.	501312	Ref. No. —
O-ring EPDM thickness 1.78mm ID ø 88.62mm Qty 1 pcs			
	Part No.	510693	Ref. No. —
mechanical shaft seal for shaft ø 12mm slide ring ext. ø 24mm slide ring H 15.5mm slide ring int. ø 11mm counter ring mounting ø 24mm height counter ring 8mm counter ring int. ø 13.5mm			
	Part No.	521258	Ref. No. —
impellor ø 80mm H 13mm thread M10R shaft ø 12mm shaft length 7.5mm blades 6			



1			
Part No.	500477	Ref. No.	3730
description pump inlet ø 50mm outlet ø 40mm type T5 230V 50Hz 1 phase 0.35kW 0.48HP L 200mm rotation direction right capacitor 10µF OLYMPIA inlet ø 50mm outlet ø 40mm			
spare parts for 500477			
	Part No.	365015	Ref. No. —
operating capacitor capacity 10µF 400V tolerance 5%Hz ambient temperature max. -25 to +85°C ø 35.5mm L 59mm M8 plastic connection male faston 6.3mm protection			
	Part No.	507458	Ref. No. 3731
impellor ø 90mm H 12mm rotation direction right thread M10L blades 8			
	Part No.	510554	Ref. No. —
O-ring EPDM thickness 2mm ID ø 120mm Qty 1 pcs			
	Part No.	510693	Ref. No. —
mechanical shaft seal for shaft ø 12mm slide ring ext. ø 24mm slide ring H 15.5mm slide ring int. ø 11mm counter ring mounting ø 24mm height counter ring 8mm counter ring int. ø 13.5mm			



1			
Part No.	500475	Ref. No.	3350
description pump inlet ø 50mm outlet ø 48mm type T75 230V 50Hz 1 phase 0.55kW 0.75HP L 237mm rotation direction right capacitor 12.5µF OLYMPIA			
spare parts for 500475			
	Part No.	365014	Ref. No. —
operating capacitor capacity 12.5µF 450V tolerance 5%Hz ambient temperature max. -25 to +85°C ø 35mm L 70mm M8 plastic connection male faston 6.3mm 45S.C3DS.12.5 protection			
	Part No.	510693	Ref. No. —
mechanical shaft seal for shaft ø 12mm slide ring ext. ø 24mm slide ring H 15.5mm slide ring int. ø 11mm counter ring mounting ø 24mm height counter ring 8mm counter ring int. ø 13.5mm			
	Part No.	521161	Ref. No. —
pump cover OLYMPIA inlet ø 50mm outlet ø 48/31mm auxiliary pressure connection 10mm pump type T75			
	Part No.	521162	Ref. No. —
impellor ø 106mm H 22mm pump type T75 thread M10L			
	Part No.	521727	Ref. No. —
pump cover gasket EPDM thickness 1.78mm ID ø 145mm Qty 1 pcs			

drain pumps

ASKOLL



1			
Part No.	500054	Ref. No.	3385
description drain pump inlet ø 24mm outlet ø 22mm 230V 40W 50Hz ASKOLL type R113			



## electric accessories

## terminals

## connection boxes



1

<b>Part No.</b>	550300	<b>Ref. No.</b>	4752
<b>description</b>	power terminal block 3-pole contacts P+N+E		

## equipment-specific units

## for dishwashers

## drain and intake components

## UNIVERBAR

## drain /intake bodies



1

<b>Part No.</b>	507449	<b>Ref. No.</b>	1536
<b>description</b>	drain fitting thread 1" hose ø 30mm		



1

<b>Part No.</b>	507460	<b>Ref. No.</b>	4621
<b>description</b>	drain fitting thread 1 1/2" ED ø 78mm ID ø 50mm		

## overflow pipes



1

<b>Part No.</b>	507466	<b>Ref. No.</b>	1534
<b>description</b>	overflow pipe L 107mm ø 28mm		



1

<b>Part No.</b>	517178	<b>Ref. No.</b>	2112
<b>description</b>	overflow pipe L 121mm ø 28mm		



1

<b>Part No.</b>	517606	<b>Ref. No.</b>	1201
<b>description</b>	overflow pipe L 149mm ø 51mm		



1

<b>Part No.</b>	507500	<b>Ref. No.</b>	3266
<b>description</b>	overflow pipe L 88mm ø 28mm		

## containers

## salt tanks



1

<b>Part No.</b>	510929	<b>Ref. No.</b>	4333
<b>description</b>	salt tank ø 120mm H 117mm hose ø 10mm mounting ø 70mm overall height 157mm		

spare parts for 510929



<b>Part No.</b>	506015	<b>Ref. No.</b>	—
<b>description</b>	O-ring EPDM thickness 3.53mm ID ø 39.69mm Qty 1 pcs		





<b>Part No.</b>	510018	<b>Ref. No.</b>	—
<b>description</b>	nut ø 92mm H 10.5mm for salt tank ID ø 64mm		







<b>Part No.</b>	524177	<b>Ref. No.</b>	—
<b>description</b>	lid ø 69mm H 20mm for salt tank ID ø 50mm		

Table continues overleaf



<b>accessories for</b>	510929		
	Part No.	510071	Ref. No. —
	flat gasket rubber ED ø 81mm ID ø 68mm thickness 3mm for salt tank Qty 1 pcs		
	Part No.	510654	Ref. No. —
	gasket H 6mm D1 ø 82mm D2 ø 68mm		
	Part No.	510883	Ref. No. —
	gasket rubber ED ø 86mm ID ø 66mm thickness 2mm for salt tank Qty 1 pcs		



<b>Part No.</b>	504045	<b>Ref. No.</b>	4337
<b>description</b>	salt tank ø 123mm H 90mm		
<b>spare parts for</b>	504045		
	Part No.	510018	Ref. No. —
	nut ø 92mm H 10.5mm for salt tank ID ø 64mm		
	Part No.	524148	Ref. No. —
	O-ring EPDM thickness 3.53mm ID ø 40.86mm Qty 1 pcs		
	Part No.	524177	Ref. No. —
	lid ø 69mm H 20mm for salt tank ID ø 50mm		
<b>accessories for</b>	504045		
	Part No.	510654	Ref. No. —
	gasket H 6mm D1 ø 82mm D2 ø 68mm		
	Part No.	510883	Ref. No. —
	gasket rubber ED ø 86mm ID ø 66mm thickness 2mm for salt tank Qty 1 pcs		

boilers

boilers for dishwashers

	1		
<b>Part No.</b>	507465	<b>Ref. No.</b>	3326
<b>description</b>	boiler without heating element ø 150mm L 415mm inlet ø 12mm outlet ø 2x 10mm		

softener cartridges

softening columns

	1		
<b>Part No.</b>	530000	<b>Ref. No.</b>	4331
<b>description</b>	softener 4-fold L 380mm W 180mm		

air traps

	1		
<b>Part No.</b>	507504	<b>Ref. No.</b>	4032 40321
<b>description</b>	air trap ø 39mm H 35mm thread M8 hose ø 6mm plastic		
<b>accessories for</b>	507504		
	Part No.	507447	Ref. No. 2017
	flat gasket PTFE ED ø 14mm ID ø 8mm thickness 2mm Qty 1 pcs		
	Part No.	507448	Ref. No. 2018
	nut thread M8 H 8mm SS WS 13 Qty 1 pcs		

	1		
<b>Part No.</b>	507505	<b>Ref. No.</b>	1360
<b>description</b>	air trap ø 39mm H 90mm thread M8 hose ø 6mm plastic		

backflow preventers

backflow preventers

	1		
<b>Part No.</b>	516101	<b>Ref. No.</b>	4221
<b>description</b>	backflow preventer dishwasher hose ø 12mm		
<b>spare parts for</b>	516101		
	Part No.	506367	Ref. No. —
	flat gasket rubber ED ø 40mm ID ø 28mm thickness 1.8mm Qty 1 pcs		



## door mechanics

## miscellaneous



1

<b>Part No.</b>	504428	<b>Ref. No.</b>	3282
<b>description</b>	bush for door brass ED ø 10/12mm ID ø 8mm H 5mm		



1

<b>Part No.</b>	507450	<b>Ref. No.</b>	1598
<b>description</b>	spring for door		

## washing and rinsing systems



1

<b>Part No.</b>	517609	<b>Ref. No.</b>	2528
<b>description</b>	bush for rinse arm PTFE L 10.6mm D1 ø 14mm D2 ø 16.5mm ID ø 10mm		

## washing and rinsing systems (sorted by producer)

## UNIVERBAR



1

<b>Part No.</b>	507502	<b>Ref. No.</b>	2540
<b>description</b>	wash and rinse arm wash arm L 385mm rinse arm L 385mm w. jets 12 r. jets 4 mounting ø 10/32mm mounting pos. upper/lower L 390mm W 390mm		



1

<b>Part No.</b>	507581	<b>Ref. No.</b>	2541
<b>description</b>	wash and rinse arm wash arm L 430mm rinse arm L 425mm w. jets 12 r. jets 5		
<b>spare parts for</b>	507581		



<b>Part No.</b>	505045	<b>Ref. No.</b>	—
<b>description</b>	O-ring EPDM thickness 1.78mm ID ø 5.28mm Qty 1 pcs		

## spare parts for 507581

	<b>Part No.</b>	510893	<b>Ref. No.</b>	—
	<b>Part No.</b>	517092	<b>Ref. No.</b>	—
	<b>Part No.</b>	517101	<b>Ref. No.</b>	—
	<b>Part No.</b>	517102	<b>Ref. No.</b>	—
	<b>Part No.</b>	517103	<b>Ref. No.</b>	—
	<b>Part No.</b>	517104	<b>Ref. No.</b>	—
	<b>Part No.</b>	517408	<b>Ref. No.</b>	—
	<b>Part No.</b>	517609	<b>Ref. No.</b>	2528
	<b>Part No.</b>	560536	<b>Ref. No.</b>	2535



1

<b>Part No.</b>	507507	<b>Ref. No.</b>	3342
<b>description</b>	wash and rinse arm wash arm L 503mm rinse arm L 475mm w. jets 10 r. jets 6 mounting ø 10/32mm mounting pos. upper/lower		



1

<b>Part No.</b>	507468	<b>Ref. No.</b>	4080
<b>description</b>	end cap for rinse arm thread M10x1 H 8mm chrome-plated brass		



1

<b>Part No.</b>	503317	<b>Ref. No.</b>	4022
<b>description</b>	rinse jet H 13mm thread M6x1 WS 10 conical seal		





1

<b>Part No.</b>	507446	<b>Ref. No.</b>	2530
<b>description</b>	wash arm boss		





			
1			
<b>Part No.</b>	507506	<b>Ref. No.</b>	3105
<b>description</b>	wash and rinse arm wash arm L 485mm rinse arm L 470mm w. jets 6 r. jets 6 mounting ø 10/43mm mounting pos. upper/lower		

			
1			
<b>Part No.</b>	507468	<b>Ref. No.</b>	4080
<b>description</b>	end cap for rinse arm thread M10x1 H 8mm chrome-plated brass		

			
1			
<b>Part No.</b>	503317	<b>Ref. No.</b>	4022
<b>description</b>	rinse jet H 13mm thread M6x1 WS 10 conical seal		

			
1			
<b>Part No.</b>	517607	<b>Ref. No.</b>	3109
<b>description</b>	wash arm boss mounting ø 10mm ø 28mm L 77mm W 70mm H 49mm		

				
1				
<b>Part No.</b>	507501	<b>Ref. No.</b>	3259	
<b>description</b>	rinse arm L 375mm nozzles 4 mounting ø 10mm mounting pos. upper			
<b>spare parts for</b>	507501			
	<b>Part No.</b>	503317	<b>Ref. No.</b>	4022
	rinse jet H 13mm thread M6x1 WS 10 conical seal			
	<b>Part No.</b>	507468	<b>Ref. No.</b>	4080
	end cap for rinse arm thread M10x1 H 8mm chrome-plated brass			

			
1			
<b>Part No.</b>	507468	<b>Ref. No.</b>	4080
<b>description</b>	end cap for rinse arm thread M10x1 H 8mm chrome-plated brass		

			
1			
<b>Part No.</b>	503317	<b>Ref. No.</b>	4022
<b>description</b>	rinse jet H 13mm thread M6x1 WS 10 conical seal		

			
1			
<b>Part No.</b>	517608	<b>Ref. No.</b>	3336
<b>description</b>	wash arm support complete mounting pos. lower thread M8x1.25 ø 35mm H 360mm		

			
1			
<b>Part No.</b>	507503	<b>Ref. No.</b>	1918
<b>description</b>	wash arm support mounting pos. lower		

			
1			
<b>Part No.</b>	507467	<b>Ref. No.</b>	4745
<b>description</b>	wash arm support mounting pos. lower ø 35mm H 235mm hose ø 33mm		

## knobs

### producer-specific knobs

#### UNIVERBAR

			
1			
<b>Part No.</b>	110949	<b>Ref. No.</b>	3321
<b>description</b>	knob thermostat t.max. 90°C 0-90°C ø 42mm shaft ø 6x4.6mm shaft flat upper black		



## accessories

### rosettes



<b>Part No.</b>	112195	<b>Ref. No.</b>	3322
<b>description</b>	rosette knob knob ø 42mm ø 56mm		

## sealing washers

### rubber gaskets



<b>Part No.</b>	517181	<b>Ref. No.</b>	1535
<b>description</b>	flat gasket rubber ED ø 44mm ID ø 32mm thickness 3mm Qty 1 pcs		

## gaskets

### O-rings

#### EPDM

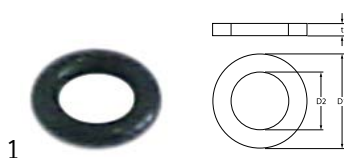

<b>Part No.</b>	517035	<b>Ref. No.</b>	3285
<b>description</b>	O-ring EPDM thickness 1.78mm ID ø 4.48mm Qty 1 pcs		

### PTFE gaskets



<b>Part No.</b>	507447	<b>Ref. No.</b>	2017
<b>description</b>	flat gasket PTFE ED ø 14mm ID ø 8mm thickness 2mm Qty 1 pcs		

## dosing pumps

### peristaltic dosing pumps

#### SEKO

#### wall-mounted version

#### with speed control



<b>Part No.</b>	361156 <sup>1</sup>	<b>Ref. No.</b>	4801
<b>description</b>	dosing pump SEKO speed control 0.6-4l/h 230VAC detergent hose ø 4x6mm hose type K hose Santoprene suction level 1.5m type PR wall-mounted version dimensions 103x82x92mm		

#### spare parts for 361156

	<b>Part No.</b>	361136	<b>Ref. No.</b>	—
		roller assembly for dosing pump hole ø 4.8x4mm		

	<b>Part No.</b>	361815	<b>Ref. No.</b>	—
		pump hose detergent hose ø 6x10mm hose ø 4x6mm hose type K hose Santoprene type SEKO		

#### accessories for 361156

	<b>Part No.</b>	361142	<b>Ref. No.</b>	—
		mounting set detergent hose type 4x6mm hose length 2m PVC 2x hose/container filter/tank intake transparent		

	<b>Part No.</b>	361891	<b>Ref. No.</b>	—
		mounting set detergent hose type 4x6mm hose length 2m PVC 2x hose/container filter/tank intake transparent		

	<b>Part No.</b>	520090	<b>Ref. No.</b>	—
		PVC hose ID ø 4mm ED ø 6mm L 2m thickness 1mm t.max. 60°C transparent		

	<b>Part No.</b>	520091	<b>Ref. No.</b>	—
		nylon hose ID ø 4mm ED ø 6mm L 2m thickness 1mm operating p. 10bar burst p. 50bar t.max. 100°C transparent		

<sup>1</sup>with accessories

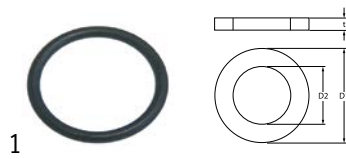

<b>Part No.</b>	510408	<b>Ref. No.</b>	4011
<b>description</b>	O-ring EPDM thickness 5.34mm ID ø 47mm Qty 1 pcs		





<b>Part No.</b>	511511	<b>Ref. No.</b>	3154
<b>description</b>	O-ring EPDM thickness 2.62mm ID ø 17.13mm Qty 10 pcs		









<b>Part No.</b>	505192	<b>Ref. No.</b>	3337
<b>description</b>	O-ring EPDM thickness 2.62mm ID ø 39.34mm Qty 1 pcs		



built-in version			
with frequency control			
			
1			
<b>Part No.</b>	361767 <sup>1</sup>	<b>Ref. No.</b>	1916
<b>description</b>	dosing pump SEKO 3l/h 230VAC detergent hose ø 4x6mm hose type K hose Santoprene suction level 1.5m type NBR 3 8W built-in version peristaltic pump		
<b>spare parts for</b>	361767		
	<b>Part No.</b>	<b>Ref. No.</b>	—
	361815		
	pump hose detergent hose ø 6x10mm hose ø 4x6mm hose type K hose Santoprene type SEKO		

<sup>1</sup>incl. inlet and conveyor hose









<b>accessories for</b>	361535		
	<b>Part No.</b>	<b>Ref. No.</b>	—
	361701		
	hose connector thread M10x1 grommet ø 7.5mm		
	<b>Part No.</b>	<b>Ref. No.</b>	—
	361703		
	hose connector thread M10x1 brass pipe connection ø 4x6mmmm		
	<b>Part No.</b>	<b>Ref. No.</b>	—
	361704		
	hose connector brass straight thread M12x1 hose ø 11mm Qty 1 pcs		
	<b>Part No.</b>	<b>Ref. No.</b>	—
	510296		
	membrane silicone		
	<b>Part No.</b>	<b>Ref. No.</b>	—
	520090		
	PVC hose ID ø 4mm ED ø 6mm L 2m thickness 1mm t.max. 60°C transparent		
	<b>Part No.</b>	<b>Ref. No.</b>	—
	520091		
	nylon hose ID ø 4mm ED ø 6mm L 2m thickness 1mm operating p. 10bar burst p. 50bar t.max. 100°C transparent		

## membrane dosing pumps

### self-priming with supporting pressure

#### GERMAC

#### type 2000

			
1			
<b>Part No.</b>	361535	<b>Ref. No.</b>	4096
<b>description</b>	dosing pump type 2000 rinse aid inlet 4x6mm outlet M10x1 suction connection ø 4x6mm supporting pressure 11mm rebound ball PTFE 1mm GERMAC CODE VNR/U3		
<b>spare parts for</b>	361535		
	<b>Part No.</b>	<b>Ref. No.</b>	—
	361550		
	hose connector hose ø 4x6mm		
	<b>Part No.</b>	<b>Ref. No.</b>	—
	361551		
	compression spring wire gauge ø 1mm		
	<b>Part No.</b>	<b>Ref. No.</b>	—
	361702		
	hose connector brass hose ø 4x6mm		
	<b>Part No.</b>	<b>Ref. No.</b>	—
	361705		
	gasket for hose connector M12x1		
	<b>Part No.</b>	<b>Ref. No.</b>	—
	510298		
	lip valve dosing pump suitable for DB2/DS5		
<b>accessories for</b>	361535		
	<b>Part No.</b>	<b>Ref. No.</b>	—
	361142		
	mounting set detergent hose type 4x6mm hose length 2m PVC 2x hose/container filter/tank intake transparent		
	<b>Part No.</b>	<b>Ref. No.</b>	—
	361553		
	membrane EPDM		
	<b>Part No.</b>	<b>Ref. No.</b>	—
	361700		
	hose connector rotary hose ø 4x6mm plastic connection M10x1		

## accessories



### container filters

			
1			
<b>Part No.</b>	361905	<b>Ref. No.</b>	1040
<b>description</b>	container filter plastic hose ø 5mm detergent		

## hoses

### supply hoses

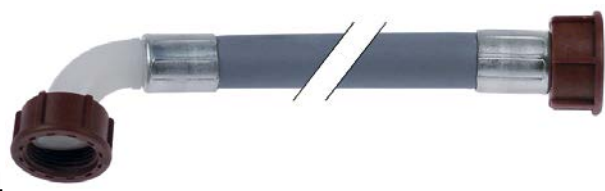
#### PVC supply hoses

			
1			
<b>Part No.</b>	520010	<b>Ref. No.</b>	3204
<b>description</b>	supply hose PVC straight-curved DN13 connections 3/4" L 1500mm operating p. 10bar burst p. 32bar t.max. 90°C blue approval VDE flat seal		
<b>accessories for</b>	520010		
	<b>Part No.</b>	<b>Ref. No.</b>	—
	520053		
	screen connection 3/4" D1 ø 26mm D2 ø 15mm Qty 10 pcs rubber thickness 8mm		
	<b>Part No.</b>	<b>Ref. No.</b>	—
	520054		
	flat gasket rubber ED ø 23.5mm ID ø 14mm thickness 2.3mm Qty 10 pcs		





drain hoses

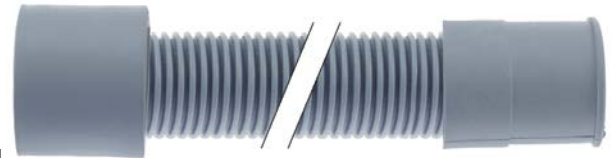

1

<b>Part No.</b>	511205	<b>Ref. No.</b>	1604
<b>description</b>	drain hose DN19 L 1500mm A int. ø 23mm A ext. ø 29mm B int. ø 29mm outer hose ø 29mm B ext. ø 35mm		



1

<b>Part No.</b>	530574	<b>Ref. No.</b>	4717
<b>description</b>	drain hose DN31 L 2000mm A int. ø 31mm A ext. ø 35mm B int. ø 40mm B ext. ø 46mm outer hose ø 38mm		

measuring equipment

thermometers

built-in thermometers



1

<b>Part No.</b>	541086	<b>Ref. No.</b>	4507
<b>description</b>	thermometer mounting measurements 58x25.5mm 0 up to +120°C capillary pipe 2000mm probe ø 6mm probe L 23mm		

fastening material

screws

knurled screws



1

<b>Part No.</b>	560536	<b>Ref. No.</b>	2535
<b>description</b>	Thumb screw thread M8 thread L 5mm ø 20mm H 10mm SS Qty 1 pcs		

nuts

hexagonal nuts

DIN 6923 / ISO 4161



1

<b>Part No.</b>	507448	<b>Ref. No.</b>	2018
<b>description</b>	nut thread M8 H 8mm SS WS 13 Qty 1 pcs		

hexagonal nuts metric (without norm)



1

<b>Part No.</b>	507461	<b>Ref. No.</b>	1505
<b>description</b>	hexagonal nut thread M10x1 H 3mm WS 17 SS Qty 1 pcs		

hexagonal nuts inch thread



1

<b>Part No.</b>	507459	<b>Ref. No.</b>	1533
<b>description</b>	nut thread 1" H 5mm WS 36 SS Qty 1 pcs		

**GASTRO**PARTS.COM

