



GASTROPARTS

Ubert

- [EN]** Equipment
- [DE]** Geräte
- [ES]** Aparatos
- [FR]** Équipement
- [IT]** Attrezzature
- [PL]** Urządzenia
- [RU]** Оборудование

✉ gastroparts@gastroparts.com

☎ +48 56 657 00 66

📘 fb.com/gastroparts.global

GASTROPARTS.COM











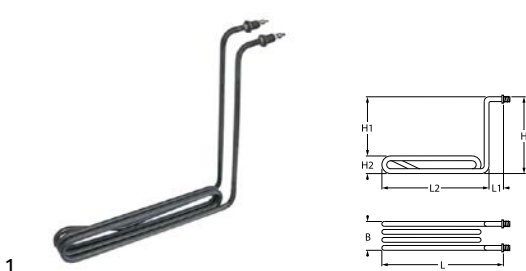

heating elements

heating elements for bain maries

			
Part No.	415567	Ref. No.	343102
description	heating element 2000W 230V heating circuits 1 L 425mm W 145mm connection M4 tube ø 8.5mm 2 hole fixing thread M14x1.5 dry heating element L1 30mm L2 115mm W1 92mm W2 56mm mounting distance 48mm		

heating elements for fryers

2 hole fixing



			
Part No.	415566	Ref. No.	343104 MS0100E
description	heating element 2000W 230V heating circuits 1 L 325mm W 42mm H 275mm L1 35mm L2 290mm H1 235mm H2 40mm thread M12x1 mounting distance 31mm tube ø 8.5mm 2 hole fixing connection M4 fryer heaters windings 3		
spare parts for	415566		
	Part No.	521110	Ref. No. —
	flat gasket fibre ED ø 20mm ID ø 13mm thickness 2mm Qty 1 pcs		
accessories for	415566		
	Part No.	520229	Ref. No. —
	nut thread M12x1 H 4mm WS 16 zinc-coated steel Qty 1 pcs		
	Part No.	521103	Ref. No. —
	nut thread M4 H 3mm WS 7 brass Qty 20 pcs		
	Part No.	521104	Ref. No. —
	washer ID ø 4.3mm ED ø 8mm thickness 0.5mm brass Qty 20 pcs for thread M4		
	Part No.	521131	Ref. No. —
	nut thread M12x1 H 3.5mm WS 17 SS Qty 1 pcs		
	Part No.	528110	Ref. No. —
	O-ring EPDM thickness 2.62mm ID ø 12.37mm Qty 1 pcs		
	Part No.	560111	Ref. No. —
	plain washer ID ø 4.3mm ED ø 9mm thickness 0.8mm SS Qty 20 pcs DIN 125A for thread M4		
	Part No.	560131	Ref. No. —
	hexagonal nut thread M4 H 3.2mm WS 7 SS DIN/ISO DIN 934 / ISO 4032/8673 Qty 20 pcs		

heating elements for griddles

			
Part No.	415561	Ref. No.	343103
description	heating element 2000W 230V L 426mm W 150mm Hmm tube ø 8.5mm L1 22mm L2 388.5mm W1 112mm W2 38mm 2 hole fixing connection male faston 6.3mm thread M14x1.25 mounting distance 30mm immersion heater		
spare parts for	415561		
	Part No.	510417	Ref. No. —
	flat gasket fibre ED ø 20mm ID ø 14mm thickness 2mm Qty 1 pcs		
accessories for	415561		
	Part No.	361182	Ref. No. —
	nut thread 1/4" H 5mm nickel-plated brass WS 17 Qty 1 pcs		
	Part No.	510420	Ref. No. —
	gasket copper ED ø 19.9mm ID ø 14.3mm thickness 2mm Qty 1 pcs		
	Part No.	520228	Ref. No. —
	tooth lock washer ID ø 15.3mm ED ø 24mm steel Qty 1 pcs for thread M14		
	Part No.	521103	Ref. No. —
	nut thread M4 H 3mm WS 7 brass Qty 20 pcs		
	Part No.	521104	Ref. No. —
	washer ID ø 4.3mm ED ø 8mm thickness 0.5mm brass Qty 20 pcs for thread M4		
	Part No.	560111	Ref. No. —
	plain washer ID ø 4.3mm ED ø 9mm thickness 0.8mm SS Qty 20 pcs DIN 125A for thread M4		
	Part No.	560131	Ref. No. —
	hexagonal nut thread M4 H 3.2mm WS 7 SS DIN/ISO DIN 934 / ISO 4032/8673 Qty 20 pcs		
			
Part No.	416964	Ref. No.	343126 343126 rechte
description	heating element 2200W 240V heating circuits 1 L 365mm W 174mm H 30mm tube ø 8.5mm W1 86mm W2 88mm 2 hole fixing connection male faston 6.3mm thread M14x1.5 mounting distance 82mm for griddle dry heating element		
spare parts for	416964		
	Part No.	510417	Ref. No. —
	flat gasket fibre ED ø 20mm ID ø 14mm thickness 2mm Qty 1 pcs		
accessories for	416964		
	Part No.	520228	Ref. No. —
	tooth lock washer ID ø 15.3mm ED ø 24mm steel Qty 1 pcs for thread M14		
	Part No.	520230	Ref. No. —
	nut thread M14x1.5 H 5mm WS 19 zinc-coated steel Qty 1 pcs		

Table continues overleaf





accessories for	416964			
	Part No.	521101	Ref. No.	—
	nut thread M14x1.5 H 5mm WS 19 SS Qty 1 pcs			
	Part No.	550262	Ref. No.	—
	flat gasket copper ED ø 20mm ID ø 14mm thickness 2mm			

heating elements for chicken rotisseries

			
1			
Part No.	419173	Ref. No.	343113
description	heating element 4500W 235V rectangular flange L 205mm W 195mm H 48mm heating circuits 1 connection M4 L1 72mm L2 135mm dry heating element tube ø 8.5mm flange length 70mm flange width 22mm connection length 50mm chicken rotisserie		

heating elements for chargrills

			
1			
Part No.	415564	Ref. No.	343161
description	heating element 1100W 230V heating circuits 1 L 471mm W 82mm rectangular flange hole distance 42.2mm hole ø 5.5mm cable length 1200mm flange length 98mm flange width 24mm tube ø 13x5mm dry heating element connection length 25mm		

			
1			
Part No.	416913	Ref. No.	343131
description	heating element 5200W 230V heating circuits 4 L 437mm W 120mm rectangular flange hole distance 48mm hole ø M4mm connection M4 flange length 125mm flange width 26mm tube ø 8.5mm dry heating element H 8.5mm		

hot plates

round

with radiused edge

for domestic and commercial kitchens

			
1			
Part No.	490018	Ref. No.	343203
description	hot plate ø 220mm 2000W 230V connection 4 screw clamps with 8mm spill ring		

energy regulators

EGO

1-circuit

			
1			
Part No.	380015	Ref. No.	341141
description	energy regulator 230V 13A single-circuit turn direction right shaft ø 6x4.6mm shaft L 23mm mounting thread M4 power release 6-100% no. 50.57021.010		

thermostats

control and safety thermostats

EGO

control thermostats

55.13_ series

				
1				
Part No.	375012	Ref. No.	342229	
description	thermostat t.max. 358°C temperature range 50-358°C 1-pole 1NO 16A probe ø 3.1mm probe L 147mm capillary pipe 1730mm capillary pipe isolated 1100mm gland nut shaft L 23mm shaft position upper rotation 270°			
accessories for	375012			
	Part No.	110247	Ref. No.	—
	knob thermostat t.max. 350°C ø 50mm shaft ø 6x4.6mm shaft flat upper black temperature range 100-350°C			

55.34_ series

			
1			
Part No.	375022	Ref. No.	342206
description	thermostat t.max. 180°C temperature range 95-180°C 3-pole 3NO 16A probe ø 6mm probe L 133mm capillary pipe 1780mm capillary pipe isolated 1400mm gland nut M9x1 shaft ø 6x4.6mm shaft L 23mm rotation 270°		



Part No.	375019	Ref. No.	342217
description	thermostat t.max. 85°C temperature range 30-85°C 3-pole 3NO 16A probe ø 6mm probe L 131mm capillary pipe 1440mm capillary pipe isolatedmm gland nut M9x1 shaft ø 6x4.6mm shaft L 23mm shaft position upper rotation 270°		

55.60_ series



Part No.	390015	Ref. No.	342213
description	thermostat t.max. 180°C temperature range 135-180°C 3-pole 3NC/3NO 16A probe ø 6mm probe L 167/87mm capillary pipe 1770mm capillary pipe isolatedmm gland nut M9x1 shaft ø 6x4.6mm shaft L 23mm shaft position upper rotation 270° with 2 probes with safety thermostat safety temperature 230°C		

safety thermostats

55.32_ series



Part No.	375393	Ref. No.	342212
description	safety thermostat switch-off temp. 235°C 3-pole 1CO/2NC 20A probe ø 6mm probe L 87mm capillary pipe 1790mm capillary pipe isolated 1710mm gland nut M9x1 probe SS		

switches and momentary switches
rocker/momentary rocker switches

30x22mm



Part No.	347774	Ref. No.	341108 341111
description	rocker switch mounting measurements 30x22mm orange 2NO 250V 20A illuminated 0-I connection male faston 6.3mm ambient temperature max. 125/55°C protection IP65		

cam switches

4-position



Part No.	300104	Ref. No.	341134
description	cam switch 4 operating positions 3NO/1CO sequence 0-1-2-3 32A shaft ø 6x4.6mm shaft L 23mm connection screw ceramic		

7-position



Part No.	300025	Ref. No.	341133
description	cam switch 7 operating positions 1NO/2CO sequence 0-1-2-3-4-5-6 16A shaft ø 6x4.6mm shaft L 23mm connection screw 7-position ceramic		
accessories for	300025		
	Part No.	112172	Ref. No. —
	knob universal ø 70mm black without adaptor/dial plate		
	Part No.	112213	Ref. No. —
	knob dial plate silver switch 7-position t.max.°C ED ø 63mm ID ø 45.5mm		
	Part No.	112311	Ref. No. —
	knob adapter shaft ø 6x4.6mm L 0mm with spring		

1 electric components



lamps

indicator lights

indicator lamps for socket type SRZ / SDK / SDY / SFK



Part No.	359130	Ref. No.	340732
description	indicator lamp 230V clear connection male faston 6.3mm ø 8mm		



Part No.	359132	Ref. No.	340733
description	indicator lamp green 250V connection male faston 6.3mm protection IP54 ambient temperature max. 85°C		

linear lamps

halogen lamps



Part No.	360556	Ref. No.	340623n 340623o
description	halogen lamp socket R7s L 74.9mm 230V 80W OSRAM		

infrared lamps

with base type X lug



Part No.	359617	Ref. No.	Q1000
description	infrared lamp 1000W 220V L 365mm lens L 340mm total length 480mm with mounting strap		
For models:	RT 205 MP		

sockets for linear lamps

R7s



Part No.	360555	Ref. No.	340412n 340412o
description	lamp socket socket R7s 250V ø 20mm L 43mm W 36mm H 27mm connection cable 400mm mounting distance 28mm with external angle holder length 36mm Qty 1 pcs		

fans

axial fans

ebm-papst



Part No.	601724	Ref. No.	344117n
description	axial fan L 80mm W 80mm H 38mm 230VAC 50/60Hz 9W manuf. no. 8886 VW cable length 315mm metal connection cable ebm-papst fan wheel ø 75mm		

condensators & interference suppression filters

operating capacitors

metal



Part No.	365002	Ref. No.	380129
description	operating capacitor capacity 4µF 400V tolerance 5% 50/60Hz ambient temperature max. -25 to +85°C ø 30mm L 75mm with cable M8 aluminium connection cable 300mm MKP protection IP65		

gas taps

MADEC (MP)

with nozzle outlet









Part No.	106255	Ref. No.	351207	
description	gas tap MADEC with nozzle outlet (with nozzle) gas inlet M12x1 (tube ø 8mm) external nozzle ø 2.2mm internal nozzle ø 0.55mm bypass nozzle ø 0.27mm mixing pipe connection M17x1 thermocouple connection M8x1 front fixing M12x1 shaft ø 6x4.6mm shaft L 30/17mm shaft flat upper			
spare parts for	106255			
	Part No.	101051	Ref. No.	—
	magnet unit L 27mm D1 ø 12.5mm D2 ø 8.5mm suitable for JUNKERS/EGA/MADEC/SABAF standard			

Table continues overleaf



spare parts for		106255	
	Part No.	101234	Ref. No. —
	union nut T1: M8x1 T2: M15		
accessories for		106255	
	Part No.	101277	Ref. No. —
	olive ID ø 8mm Qty 1 pcs		
	Part No.	101296	Ref. No. —
	union nut thread M12x1 for pipe ø 8mm		
	Part No.	101394	Ref. No. —
	nut thread M17x1 H 3mm WS 19 brass Qty 1 pcs		
	Part No.	101400	Ref. No. —
	air mixing tube thread M17x1 suitable for L350, L700		

GASTROPARTS.COM

