



GASTROPARTS

Thirotde

- [EN]** Equipment
- [DE]** Geräte
- [ES]** Aparatos
- [FR]** Équipement
- [IT]** Attrezzature
- [PL]** Urządzenia
- [RU]** Оборудование

✉ gastroparts@gastroparts.com

☎ +48 56 657 00 66

📘 fb.com/gastroparts.global

GASTROPARTS.COM





heating elements

heating elements for ovens

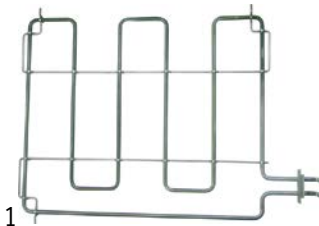

1

Part No.	418525	Ref. No.	302191
description	heating element 3300W 400V L 610mm W 450mm L1 75mm L2 535mm W1 40mm W2 55mm flange length 72mm flange width 53mm hole distance 62mm hole ø 5mm tube ø 8.5mm connection M5 heating circuits 1 rectangular flange dry heating element oven		

heating elements for frying pans



1

Part No.	420432	Ref. No.	302197 302256
description	heating element 1800W 230V heating circuits 1 L 90mm W 556mm hole distance 55mm tube ø 8mm H 134mm		

immersion heating elements

with expansion flange 70 x 18mm



1

Part No.	420171	Ref. No.	903121
description	heating element 1500W 220V heating circuits 1 flange 70x18mm L 255mm W 65mm H 32mm connection male faston 6.3mm immersion heater tube ø 8.5mm		



1

Part No.	415016	Ref. No.	903101
description	heating element 3000W 230V heating circuits 3 flange 70x18mm L 398mm W 60mm H 24mm connection male faston 6.3mm immersion heater expansion flange tube ø 6.3mm		



1

Part No.	416243	Ref. No.	2001624H
description	heating element 7600W 230V heating circuits 3 flange 70x18mm L 390mm W 60mm H 13mm connection male faston 6.3mm tube ø 6.3mm immersion heater expansion flange INCOLOY-800		

accessories

sealing washers

O-rings

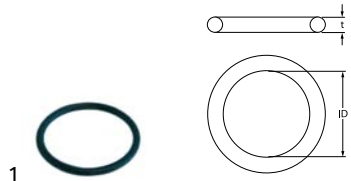

1

Part No.	510409	Ref. No.	905588
description	O-ring EPDM thickness 5.34mm ID ø 56.52mm Qty 1 pcs		

hot plates

square & rectangular

with radiused edge



1

Part No.	490066 ¹	Ref. No.	303001
description	hot plate dimensions 220x220mm 2600W 230V with spill ring connection 4 screw clamps protector yes square		

¹incl. protector



1

Part No.	490068 ¹	Ref. No.	303002
description	hot plate dimensions 220x220mm 2600W 400V with spill ring connection 4 screw clamps protector yes square		

¹incl. protector



round

with radiused edge

for domestic and commercial kitchens



1

Part No.	490020	Ref. No.	303003
description	hot plate ø 220mm 2600W 230V connection 4 screw clamps with 8mm spill ring		
accessories for	490020		
	Part No.	550796	Ref. No.
			—
	fixing plate for hot plate ø220mm		



1

Part No.	490021	Ref. No.	303004
description	hot plate ø 220mm 2600W 400V connection 4 screw clamps with 8mm spill ring		



1

Part No.	490061	Ref. No.	303009
description	hot plate ø 300mm 2500W 230V connection 4 screw clamps with 8mm spill ring		



1

Part No.	490063	Ref. No.	303008
description	hot plate ø 300mm 2500W 400V connection 4 screw clamps with 8mm spill ring		

energy regulators

EGO

1-circuit



1

Part No.	380015	Ref. No.	301200
description	energy regulator 230V 13A single-circuit turn direction right shaft ø 6x4.6mm shaft L 23mm mounting thread M4 power release 6-100% no. 50.57021.010		

accessories

knobs



1

Part No.	110075	Ref. No.	308091
description	knob energy regulator 1-3 t.max.°C°C ø 50mm shaft ø 6x4.6mm shaft flat upper black		
accessories for	110075		
	Part No.	110135	Ref. No.
			—
	rosette knob up to ø 52mm		

thermostats

control and safety thermostats

EGO

control thermostats

55.10/19_ series

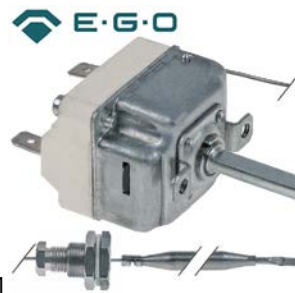

1

Part No.	376054	Ref. No.	2020062
description	thermostat t.max. 200°C temperature range 65-200°C 1CO 6.3A probe ø 6mm probe L 78mm capillary pipe 900mm capillary pipe isolatedmm gland nut M12 shaft ø 6x4.6mm shaft L 23mm rotation 270° probe material SS screw connection M9x1 disc ø 7.7mm		
accessories for	376054		
	Part No.	110121	Ref. No.
			—
	knob thermostat t.max. 200°C ø 50mm shaft ø 6x4.6mm shaft flat upper black temperature range 60-200°C rotation 270°		

Table continues overleaf



accessories for	376054			
	Part No.	110135	Ref. No.	—
	rosette knob up to ø 52mm			

			
			
1 			

Part No.	375664	Ref. No.	301031
description	thermostat t.max. 287°C temperature range 60-287°C 1-pole 1N0 16A probe ø 3.1mm probe L 226mm capillary pipe 1470mm capillary pipe isolated 350mm gland nut shaft ø 6x4.6mm shaft L 23mm shaft position upper rotation 270°		

			
			
1 			

Part No.	390416	Ref. No.	901001
description	thermostat t.max. 85°C temperature range fixed 85°C 1-pole 1C0 16A probe ø 6mm probe L 129mm capillary pipe 1470mm capillary pipe isolated 1430mm gland nut shaft Lmm shaft position		

55.34_ series

			
			
1 			

Part No.	375143	Ref. No.	901007
description	thermostat t.max. 110°C temperature range 32-110°C 3-pole 3N0 16A probe ø 6mm probe L 138mm capillary pipe 1480mm capillary pipe isolated 1100mm gland nut M9x1 shaft ø 6x4.6mm shaft L 23mm shaft position upper rotation 270°		

			
			
1 			

Part No.	375022	Ref. No.	301062
description	thermostat t.max. 180°C temperature range 95-180°C 3-pole 3N0 16A probe ø 6mm probe L 133mm capillary pipe 1780mm capillary pipe isolated 1400mm gland nut M9x1 shaft ø 6x4.6mm shaft L 23mm rotation 270°		

			
			
1 			

Part No.	375026	Ref. No.	301006
description	thermostat t.max. 350°C temperature range 100-350°C 3-pole 3N0 16A probe ø 6mm probe L 77mm capillary pipe 2430mm capillary pipe isolated 1100mm gland nut shaft ø 6x4.6mm shaft L 23mm shaft position upper rotation 270°		

safety thermostats

55.13_ series

			
			
1 			

Part No.	375830	Ref. No.	905886
description	safety thermostat switch-off temp. 365°C 1-pole 1NC 16A probe ø 3mm probe L 160mm capillary pipe 1730mm capillary pipe isolated 1710mm gland nut probe		



55.32_ series

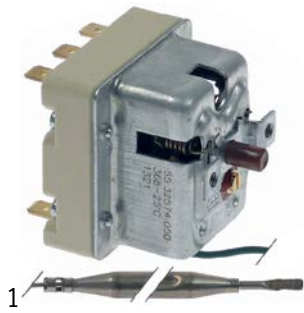

Part No.	376062	Ref. No.	1040069
description	safety rod thermostat switch-off temp. 370°C 3-pole probe ø 6mm probe L 77mm capillary pipe 1500mm		



Part No.	375984	Ref. No.	301061
description	safety thermostat switch-off temp. 225°C 3-pole 3NC 20A probe ø 6mm probe L 94mm capillary pipe 900mm capillary pipe isolated 670mm gland nut M10x1 probe SS		

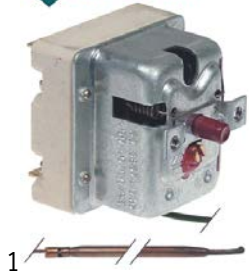

Part No.	375706	Ref. No.	301049
description	safety thermostat switch-off temp. 400°C 3-pole 3NC 20A probe ø 3.9mm probe L 228mm capillary pipe 1190mm capillary pipe isolatedmm gland nut probe SS		

56._ series



Part No.	375442	Ref. No.	301039 301066
description	safety thermostat capillary pipe 1760mm probe ø 4mm 1-pole probe L 100mm 16A capillary pipe isolated 1600mm gland nut switch-off temp. 320°C probe		

IMIT / TEMPOMATIC / ARATHERMO

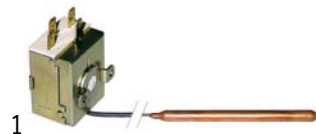

control thermostats

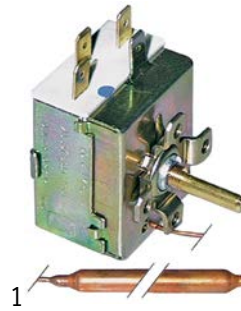

Part No.	390314	Ref. No.	2001895H
description	thermostat t.max. 60°C temperature range fixed 60°C-pole 1CO 15A probe ø 6.5mm probe L 95mm capillary pipe 2000mm capillary pipe isolated 1950mm gland nut shaft ømm shaft Lmm shaft position rotation° probe material copper		



Part No.	390006	Ref. No.	901017
description	thermostat t.max. 86°C temperature range 0-86°C 1-pole 1CO 16A probe ø 6.5mm probe L 95mm capillary pipe 1500mm capillary pipe isolatedmm gland nut shaft ø6x4.6mm shaft L 19mm rotation 270°		

accessories for	390006			
	Part No.	110100	Ref. No.	—
	knob thermostat t.max. 90°C 0-90°C ø 42mm shaft ø 6x4.6mm shaft flat -135° black			
	Part No.	110105	Ref. No.	—
	rosette knob ø 42mm ø 56mm zero mark			



safety thermostats



1

Part No.	390770	Ref. No.	2002136H
description	safety thermostat switch-off temp. 90-110°C 1-pole 1CO 16/0.5A probe ø 6.5mm probe L 90mm capillary pipe 2000mm capillary pipe isolated 1950mm gland nut probe		

PRODIGY / FIRT

safety thermostats



1

Part No.	375478	Ref. No.	2001687H
description	safety thermostat switch-off temp. 200°C temperature range°C 1-pole 1CO 20A probe ø 3.3mm probe L 190mm capillary pipe 2150mm capillary pipe isolatedmm gland nut probe SS		

switches and momentary switches

rocker/momentary rocker switches

30x22mm



1

Part No.	346068	Ref. No.	905022	
description	momentary rocker switch mounting measurements 30x22mm black 2NO 250V 16A 0-I connection male faston 6.3mm ambient temperature max. 85/125°C protection IP40			
accessories for	346068			
	Part No.	301036	Ref. No.	—
	protective cover internal size 30x22mm for rocker switch mounting measurementsmm			

microswitches

lever actuated



1

Part No.	345257	Ref. No.	300688
description	microswitch with lever 250V 16A 1CO connection male faston 6.3mm L 29mm L1 33mm ambient temperature max. 120°C mounting distance 22mm actuating force: 130g lever length 31.5mm		

system switches (ROLD)



1



Part No.	345650	Ref. No.	900054
description	momentary switch unit 2CO 250V 16A connection male faston 6.3mm		

cam switches

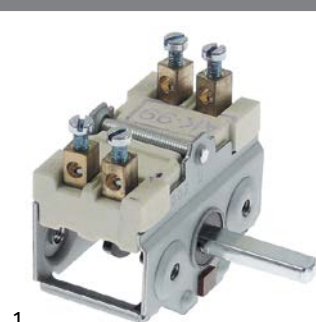
on/off





1

Part No.	300020	Ref. No.	300002	
description	cam switch 4 operating positions 2NO sequence 0-1-0-1 16A shaft ø 6x4.6mm shaft L 23mm connection screw ceramic			
accessories for	300020			
	Part No.	110135	Ref. No.	—
	rosette knob up to ø 52mm			
	Part No.	110231	Ref. No.	—
	knob switch 0-1-0-1 t.max.°C°C ø 50mm shaft ø 6x4.6mm shaft flat upper black			

7-position



1	Part No.	300025	Ref. No.	300011
description	cam switch 7 operating positions 1NO/2CO sequence 0-1-2-3-4-5-6 16A shaft \varnothing 6x4.6mm shaft L 23mm connection screw 7-position ceramic			
accessories for	300025			
	Part No.	112172	Ref. No.	—
	knob universal \varnothing 70mm black without adaptor/dial plate			
	Part No.	112213	Ref. No.	—
	knob dial plate silver switch 7-position t.max.°C°C ED \varnothing 63mm ID \varnothing 45.5mm			
	Part No.	112311	Ref. No.	—
	knob adapter shaft \varnothing 6x4.6mm L 0mm with spring			



1	Part No.	300106	Ref. No.	300010
description	cam switch 7 operating positions 1NO/2CO sequence 0-1-2-3-4-5-6 32A shaft \varnothing 6x4.6mm shaft L 23mm connection screw 7-position shaft flat upper			

4 operating positions



1	Part No.	300360	Ref. No.	300051
description	cam switch 4 operating positions 3NO/1CO sequence 0-1-2-3 32A shaft \varnothing 6x4.6mm shaft L 23mm connection screw ceramic			

operation switches



1	Part No.	300091	Ref. No.	300175 300176
description	operation switch EGO 2 operating positions 2NO 16A sequence 0-1 shaft \varnothing 6x4.6mm shaft L 23mm connection screw ceramic			

magnetic switches

accessories

magnets

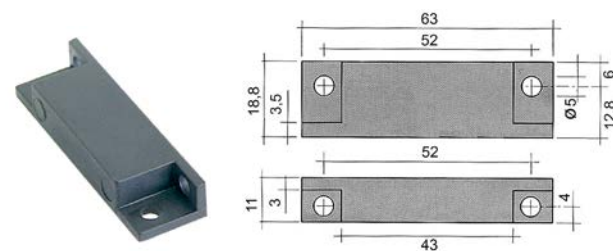

1	Part No.	345336	Ref. No.	2001868H
description	magnet \varnothing 4.8mm L 63mm H 11mm W 18.8mm hole distance 51mm M4			

encoders and potentiometers



1	Part No.	300265	Ref. No.	309411
description	potentiometer			

lamps

LED

indicator lamps

mounting diameter 6mm



1	Part No.	358098	Ref. No.	2001677H
description	indicator light LED mounting \varnothing 6mm 5VDC yellow connection cable 200mm 2mA			







timers

programme timers



1

Part No.	360025	Ref. No.	905026
description	timer CDC 7003F engines 1 chambers 3 operation time 360s 230V 50Hz shaft ø 6x7mm shaft L 26mm manuf. no. 7003F3 / 360025 motor type M37LN		
spare parts for	360025		
	Part No.	360131	Ref. No. —
	motor CDC pinion ø 5.4mm teeth 12 230V turn direction left motor ø 37mm motor type M37LN for timer		
accessories for	360025		
	Part No.	110085	Ref. No. —
	push button t.max.°C ø 36mm shaft ømm shaft flat grey for knob		
	Part No.	110086	Ref. No. —
	knob switch zero mark t.max.°C ø 45mm shaft ømm shaft flat special black		
	Part No.	110087	Ref. No. —
	retaining ring shaft ø 8mm DIN 471		

relays

power relays

with bracket mounting



1

Part No.	380185	Ref. No.	2001929h
description	power relays Italiana Relè 230VAC 30A 1NO connection F6.3 bracket mounting dimensions 36.5x32.2x51.8mm manuf. no. A10-230AC-FA		

electronic controllers





EVCO - EVERY CONTROL

refrigeration controllers

built-in version



1

Part No.	378153	Ref. No.	651094
description	electronic controller EVERY CONTROL type EVK213N3VXBS mounting measurements 71x29mm 12/24V voltage AC/DC NTC/PTC relay outputs 3 NO-16A(5) CO-8A(4) NO-8A(4) NTC/PTC NTC/PTC DI front measurementsmm built-in depth 59mm protection IP65 yes -50 up to +150°C display 3½ digits		
accessories for	378153		
	Part No.	379053	Ref. No. —
	temperature probe PTC 1kOhm cable PVC probe -50 up to +150°C cable -10 up to 100°C probe ø6x30mm cable length 3m without screw connection 2-wire		
	Part No.	379064	Ref. No. —
	temperature probe PTC 1kOhm cable silicone probe -50 up to +150°C cable -50 up to +180°C probe ø6x40mm cable length 3m without screw connection 2-wire		
	Part No.	379161	Ref. No. —
	temperature probe NTC 10kOhm cable thermoplastic probe -40 up to +110°C cable -40 up to +110°C probe ø6x14mm cable length 3m without screw connection 2-wire		
	Part No.	379782	Ref. No. —
	temperature probe PTC 1kOhm cable thermoplastic probe -50 up to +150°C cable -40 up to +110°C probe ø6x14mm cable length 3m 2-wire resistor 1kOhm		

electronics

PCBs



1

Part No.	403093	Ref. No.	2002140H
description	PCB dishwasher L 135mm W 82mm		



solenoid valves

solenoid valves (water)

ELBI



Part No.	370357	Ref. No.	634086
description	solenoid valve double straight 230VAC inlet 3/4" outlet 11.5mm plastic flow regulating valve outlet A 0.25		

TP



Part No.	370021	Ref. No.	634086
-----------------	--------	-----------------	--------

description solenoid valve double straight 230VAC inlet 3/4" outlet 11.5mm DN10 TP flow regulating valve inlet white

spare parts for 370021

	Part No.	371013	Ref. No.	—
	solenoid coil TP 230VAC 50/60Hz			

accessories for 370021

	Part No.	371220	Ref. No.	—
	reducer TP flow rate 3l/min red tolerance ±15%			
	Part No.	371221	Ref. No.	—
	reducer TP flow rate 5.5l/min yellow tolerance ±15%			
	Part No.	371222	Ref. No.	—
	reducer TP flow rate 6l/min grey tolerance ±15%			
	Part No.	371223	Ref. No.	—
	reducer TP flow rate 10l/min white tolerance ±15%			
	Part No.	371224	Ref. No.	—
	reducer TP flow rate 12l/min bronze tolerance ±15%			
	Part No.	371225	Ref. No.	—
	reducer TP flow rate 16l/min light brown tolerance ±15%			
	Part No.	371226	Ref. No.	—
	reducer TP flow rate 20l/min red tolerance ±15%			
	Part No.	371230	Ref. No.	—
	reducer TP flow rate 0.25l/min red tolerance ±25%			
	Part No.	371231	Ref. No.	—
	reducer TP flow rate 0.35l/min violet tolerance ±25%			
	Part No.	371232	Ref. No.	—
	reducer TP flow rate 0.5l/min orange tolerance ±25%			

accessories for	370021			
	Part No.	371233	Ref. No.	—
	reducer TP flow rate 0.8l/min white tolerance ±25%			
	Part No.	371234	Ref. No.	—
	reducer TP flow rate 1l/min light blue tolerance ±25%			
	Part No.	371235	Ref. No.	—
	reducer TP flow rate 1.2l/min brown tolerance ±25%			
	Part No.	371236	Ref. No.	—
	reducer TP flow rate 1.5l/min light brown tolerance ±25%			
	Part No.	371237	Ref. No.	—
	reducer TP flow rate 2.5l/min yellow tolerance ±25%			
	Part No.	371238	Ref. No.	—
	reducer TP flow rate 3.4l/min dark green tolerance ±25%			
	Part No.	371239	Ref. No.	—
	reducer TP flow rate 5l/min black tolerance ±25%			
	Part No.	371240	Ref. No.	—
	reducer TP flow rate 8l/min blue tolerance ±20%			

	Part No.	370024	Ref. No.	634089
	description solenoid valve triple angled 230VAC inlet 3/4" outlet 14mm DN10 TP			
spare parts for	370024			
	Part No.	371013	Ref. No.	—
	solenoid coil TP 230VAC 50/60Hz			
accessories for	370024			
	Part No.	371220	Ref. No.	—
	reducer TP flow rate 3l/min red tolerance ±15%			
	Part No.	371221	Ref. No.	—
	reducer TP flow rate 5.5l/min yellow tolerance ±15%			
	Part No.	371222	Ref. No.	—
	reducer TP flow rate 6l/min grey tolerance ±15%			
	Part No.	371223	Ref. No.	—
	reducer TP flow rate 10l/min white tolerance ±15%			
	Part No.	371224	Ref. No.	—
	reducer TP flow rate 12l/min bronze tolerance ±15%			
	Part No.	371225	Ref. No.	—
	reducer TP flow rate 16l/min light brown tolerance ±15%			

Table continues overleaf



accessories for		370024		
	Part No.	371226	Ref. No.	—
	reducer TP flow rate 20l/min red tolerance ±15%			
	Part No.	371230	Ref. No.	—
	reducer TP flow rate 0.25l/min red tolerance ±25%			
	Part No.	371231	Ref. No.	—
	reducer TP flow rate 0.35l/min violet tolerance ±25%			
	Part No.	371232	Ref. No.	—
	reducer TP flow rate 0.5l/min orange tolerance ±25%			
	Part No.	371233	Ref. No.	—
	reducer TP flow rate 0.8l/min white tolerance ±25%			
	Part No.	371234	Ref. No.	—
	reducer TP flow rate 1l/min light blue tolerance ±25%			
	Part No.	371235	Ref. No.	—
	reducer TP flow rate 1.2l/min brown tolerance ±25%			
	Part No.	371236	Ref. No.	—
	reducer TP flow rate 1.5l/min light brown tolerance ±25%			
	Part No.	371237	Ref. No.	—
	reducer TP flow rate 2.5l/min yellow tolerance ±25%			
	Part No.	371238	Ref. No.	—
	reducer TP flow rate 3.4l/min dark green tolerance ±25%			
	Part No.	371239	Ref. No.	—
	reducer TP flow rate 5l/min black tolerance ±25%			
	Part No.	371240	Ref. No.	—
	reducer TP flow rate 8l/min blue tolerance ±20%			

various

	1		
Part No.	370726	Ref. No.	2002183H
description	solenoid valve double straight 220-240VAC inlet 11mm outlet 11mm MILANO plastic output B red		

pressure switches

for warewashing

ø 58mm with male faston 6.3mm

with connection horizontal



1

Part No.	541002	Ref. No.	2001959H
description	pressure control pressure range 110/60mbar connection 6mm ø 58mm pressure connection horizontal warewashing pressure connection ø 6mm		

compressors

L'UNITE HERMETIQUE / TECUMSEH

R404A

LBP monophase

Lower evaporation temperature below -20°C



1

Part No.	605134	Ref. No.	653243
description	compressor coolant R404A type CAJ2446Z 220-240V 50Hz LBP 23kg 1.2HP cylinder capacity 26.1cm ³ CSR H 280mm 797W 1110W 1423W 1821W 2290WWWWW 549W		





fans

axial fans

import



1

Part No.	601080 ¹	Ref. No.	304194
description	axial fan L 119mm W 119mm H 38mm 230VAC 50/60Hz 23/20W bearing ball bearing connection male faston 2.8mm metal ADDA fan wheel ø 110mm temp.-resist. 70°C		
accessories for	601080		
	Part No.	550898	Ref. No. —
	connecting cable cable length 2000mm connection F 2.8 connection distance 7.9mm for axial flow fan		
	Part No.	692519	Ref. No. —
	guard L 120mm W 120mm plastic		

¹with ball bearings

cross flow fans

COPREL

double fans



1

Part No.	601026	Ref. No.	504365
description	cross flow fan COPREL TFD(FD) roller ø 60mm roller length 2x180mm laminated core thickness 35mm motor position centre 230V/50-60Hz 42W refrigeration bearing rubber connection male faston 6.3mm coil type airflow 255m ³ /h -10 up to +60°C		

hot air fans

ebm-papst

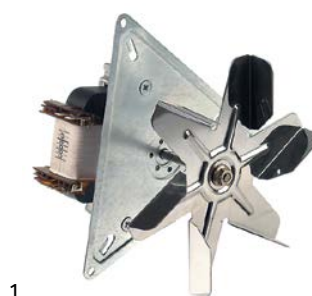

1

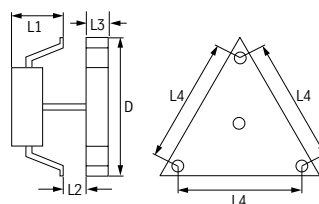

Part No.	601267	Ref. No.	645457
description	hot air fan 230V 32W 0.27A L1 60mm L2 50mm L3 20mm L4 157mm fan wheel ø 150mm ebm-papst type R2K150-0020A9		

motors

gear motors

for dishwashers



1

Part No.	601861	Ref. No.	2001419H
description	gear motor FIR type 71-B5 180W 400V voltage AC 50/60Hz 3 phase 900/1100rpm shaft ø 14mm L 227mm for transport system without gearbox		



pumps





wash and rinse pumps

FIR

pumps



1

Part No.	499079	Ref. No.	5519E
description	pump inlet \varnothing 28mm outlet \varnothing 26mm type 2211.1610 220-240V 50Hz 1 phase 0.07kW 0.1HP rotation direction left capacitor 5 μ F FIR		
spare parts for	499079		
	Part No.	365017	Ref. No. —
	operating capacitor capacity 5 μ F 450V tolerance 5% 50/60Hz ambient temperature max. -25 to +85°C \varnothing 28mm L 54mm M8 plastic connection male faston 6.3mm 16.10.08 protection		
	Part No.	510384	Ref. No. —
	pump cover inlet \varnothing 28mm outlet \varnothing 26mm \varnothing 100mm ID \varnothing 76mm		
	Part No.	510695	Ref. No. —
	mechanical shaft seal height counter ring 5.5mm ID \varnothing 11mm		
	Part No.	521203	Ref. No. —
	impellor \varnothing 72mm H 18mm thread M7 shaft \varnothing 11mm shaft length 32mm blades 3		
	Part No.	521703	Ref. No. —
	pump cover gasket EPDM thickness 2.5mm ID \varnothing 75mm Qty 1 pcs		



1

Part No.	500038	Ref. No.	904001 904013
description	pump inlet \varnothing 45mm outlet \varnothing 40mm type 3911.1425 230V 50Hz 1 phase 0.55kW 0.75HP L 205mm rotation direction right capacitor 10 μ F FIR		
spare parts for	500038		
	Part No.	365015	Ref. No. —
	operating capacitor capacity 10 μ F 400V tolerance 5%Hz ambient temperature max. -25 to +85°C \varnothing 35.5mm L 59mm M8 plastic connection male faston 6.3mm protection		
	Part No.	510508	Ref. No. —
	pump cover FIR inlet \varnothing 45mm outlet \varnothing 40mm pump type PU 0.5/3911 turn direction right \varnothing 160mm ID \varnothing 125mm inner height 25mm		
	Part No.	510610	Ref. No. —
	impellor \varnothing 95.5mm H 23mm shaft intake \varnothing 9/8mm rotation direction right seat \varnothing 16mm blades 6		
	Part No.	510692	Ref. No. —
	mechanical shaft seal for shaft \varnothing 11mm slide ring ext. \varnothing 24mm slide ring H 13mm counter ring mounting \varnothing 26mm height counter ring 8mm counter ring int. \varnothing 14mm		
	Part No.	521702	Ref. No. —
	pump cover gasket thickness 3.5x4.5mm Qty 1 pcs		
accessories for	500038		
	Part No.	551286	Ref. No. —
	adapter L 120mm 4-pole for Meiko pump suitable for 500038 plug type dependent on equipment		







1

Part No.	499334	Ref. No.	2001896H
description	pump inlet ø 62mm outlet ø 62mm type 2250.2731 230/400V 50Hz 1 phase 3kW FIR		
spare parts for	499334		
	Part No.	510687	Ref. No. 904115
	mechanical shaft seal for shaft ø 18mm height counter ring 8mm ID ø 17mm ED ø 39mm H 15mm mounting ø 42mm int. ø 1 21mm		
	Part No.	512455	Ref. No. —
	fan wheel ø 155mm H 18mm shaft intake ø 18mm plastic blades 12		
	Part No.	521026	Ref. No. —
	pump cover gasket ID ø 182.5mm thickness 5x4.5mm		
	Part No.	521028	Ref. No. 904112
	pump cover FIR inlet ø 62mm outlet ø 62mm turn direction right ø 215mm ID ø 175mm inner height 40mm		
	Part No.	521277	Ref. No. —
	impellor ø 135mm H 39mm pump type Fir 2275 - 3.6HP thread M14L		



1

Part No.	500056	Ref. No.	904003
description	pump inlet ø 63mm outlet ø 47mm type 1211.2706 230/400V 50Hz 3 phase 0.55kW 0.75HP L 305mm rotation direction right FIR		
spare parts for	500056		
	Part No.	510601	Ref. No. —
	impellor ø 103mm H 25mm rotation direction right thread M8L seat ø 12.2mm blades 6		
	Part No.	510693	Ref. No. —
	mechanical shaft seal for shaft ø 12mm slide ring ext. ø 24mm slide ring H 15.5mm slide ring int. ø 11mm counter ring mounting ø 24mm height counter ring 8mm counter ring int. ø 13.5mm		

spare parts for	500056		
	Part No.	521513	Ref. No. —
	pump cover FIR inlet ø 63mm outlet ø 47mm turn direction right ID ø 150mm inner height 32mm		
	Part No.	524416	Ref. No. 1476E 2001956H 904121
	pump cover gasket thickness 4x4mm Qty 1 pcs		

LGB



1

Part No.	499099	Ref. No.	2002220H
description	pump inlet ø 28mm outlet ø 26mm type CRC-R DX 230V 50Hz 1 phase 0.2kW L 175mm rotation direction left capacitor 4µF LGB		
spare parts for	499099		
	Part No.	365031	Ref. No. —
	operating capacitor capacity 4µF 450V tolerance 5% 50/60Hz ambient temperature max. -25 to +85°C ø 31mm L 58mm M8 plastic connection male faston 6.3mm protection		
	Part No.	509002	Ref. No. —
	O-ring EPDM thickness 2.62mm ID ø 82.22mm Qty 1 pcs		
	Part No.	510703	Ref. No. —
	mechanical shaft seal for shaft ø 13mm slide ring H 13mm height counter ring 5.5mm ED ø 26mm		
	Part No.	521091	Ref. No. —
	pump cover LGB inlet ø 28mm outlet ø 26mm pump type CRC-R DX		
	Part No.	521092	Ref. No. —
	impellor ø 80mm H 25mm pump type CRC-R DX thread M6R shaft ø 13mm shaft length 20mm		

drain pumps

ASKOLL



1

Part No.	500210	Ref. No.	2001519H
description	drain pump 230V 40W		



HANNING

1

Part No.	500573	Ref. No.	2001523H
description	drain pump 30W 4-piece 230V inlet \varnothing 24/30mm outlet \varnothing 24mm 50Hz HANNING type DPS25-032 1x pump, 3x pump cover		

service kits

1

Part No.	500573	Ref. No.	2001523H
description	drain pump 30W 4-piece 230V inlet \varnothing 24/30mm outlet \varnothing 24mm 50Hz HANNING type DPS25-032 1x pump, 3x pump cover		

electric accessories

cables

ribbon cables

group 1

1

Part No.	400902	Ref. No.	2001087H
description	ribbon cable 10-pole L 750mm plug type FC-10P raster size 2.54mm		

terminals

connection terminals with screw/faston connections

1

Part No.	550411	Ref. No.	2001039H
description	power terminal block 6-pole max. 40A max 450V connection \varnothing 6mm ² / F6.3 temp.-resist. 150°C cross section 6mm ²		

gas taps







PEL







21S series

1

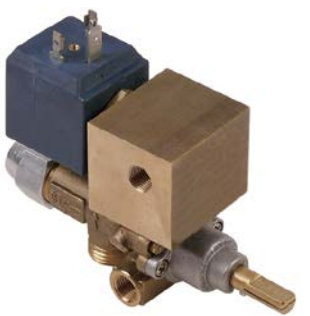
Part No.	101397	Ref. No.	310139	
description	gas tap PEL type 21S gas inlet M16x1.5 (tube \varnothing 10mm) bypass nozzle \varnothing 0.35mm gas outlet M16x1.5 (tube \varnothing 10/8mm) thermocouple connection M9x1 pilot connection M10x1 shaft \varnothing 8x6.5mm shaft L 22/15mm shaft flat lower			
spare parts for	101397			
	Part No.	100408	Ref. No.	—
	bypass nozzle type PEL20/21 bore \varnothing 0.35mm thread M5x0.5			
	Part No.	101060	Ref. No.	—
	magnet unit standard L 39mm D1 \varnothing 15.4mm D2 \varnothing 11mm suitable for PEL20-21/JUNKERS/EGA			
	Part No.	101206	Ref. No.	—
	gas tap front part shaft \varnothing 8x6.5mm shaft L 22/15mm shaft flat upper/lower suitable for PEL21			
	Part No.	101231	Ref. No.	—
	thermocouple nut T1: M9x1 T2: M18x1			
accessories for	101397			
	Part No.	100908	Ref. No.	—
	union screw thread M10x1 for pipe \varnothing 4mm Qty 1 pcs			
	Part No.	100909	Ref. No.	—
	union screw thread M10x1 for pipe \varnothing 6mm Qty 1 pcs			
	Part No.	101246	Ref. No.	—
	olive for pipe \varnothing 4mm Qty 1 pcs			
	Part No.	101278	Ref. No.	—
	olive for pipe \varnothing 10mm Qty 1 pcs			
	Part No.	101286	Ref. No.	—
	olive ID \varnothing 6mm Qty 1 pcs			
	Part No.	101300	Ref. No.	—
	union nut thread M16x1.5 tube \varnothing 10mm			
	Part No.	101450	Ref. No.	—
	olive for pipe \varnothing 8mm L 12.7mm Qty 1 pcs ED \varnothing 10mm			
	Part No.	101451	Ref. No.	—
	union nut thread M16x1.5 tube \varnothing 8mm			
	Part No.	110081	Ref. No.	—
	knob \varnothing 70mm shaft \varnothing 8x6.5mm shaft flat universal			
	Part No.	112206	Ref. No.	—
	knob dial plate silver gas tap PEL21/22/23 t.max.°C ED \varnothing 63mm ID \varnothing 45.5mm			



			
1			
Part No.	106815	Ref. No.	N/A
description	gas tap PEL type 21S gas inlet M16x1.5 (tube ø 10mm) bypass nozzle ø 0mm gas outlet 2x M10x1 thermocouple connection M9x1 pilot connection M10x1 shaft ø 8x6.5mm shaft L 22/15mm shaft flat upper		
spare parts for	106815		
	Part No.	101060	Ref. No. —
	magnet unit standard L 39mm D1 ø 15.4mm D2 ø 11mm suitable for PEL20-21/JUNKERS/EGA		
	Part No.	101206	Ref. No. —
	gas tap front part shaft ø 8x6.5mm shaft L 22/15mm shaft flat upper/lower suitable for PEL21		
	Part No.	101231	Ref. No. —
	thermocouple nut T1: M9x1 T2: M18x1		
	Part No.	106202	Ref. No. —
	bypass nozzle type PEL20/21 bore ø 0mm thread M5x0.5		
	Part No.	106823	Ref. No. —
	gas connection gas inlet M16x1.5 gas outlet 2x M10x1		

			
1			
Part No.	106817	Ref. No.	165961
description	gas tap PEL type 21S gas inlet M16x1.5 (tube ø 10mm) bypass nozzle ø 0mm gas outlet 2x M10x1 thermocouple connection M9x1 pilot connection M10x1 shaft ø 8x6.5mm shaft L 22/15mm shaft flat upper		
spare parts for	106817		
	Part No.	101060	Ref. No. —
	magnet unit standard L 39mm D1 ø 15.4mm D2 ø 11mm suitable for PEL20-21/JUNKERS/EGA		
	Part No.	101206	Ref. No. —
	gas tap front part shaft ø 8x6.5mm shaft L 22/15mm shaft flat upper/lower suitable for PEL21		
	Part No.	101231	Ref. No. —
	thermocouple nut T1: M9x1 T2: M18x1		
	Part No.	106202	Ref. No. —
	bypass nozzle type PEL20/21 bore ø 0mm thread M5x0.5		
	Part No.	106819	Ref. No. —
	solenoid valve body		
	Part No.	106820	Ref. No. —
	solenoid valve connection gas inlet M16x1.5 gas outlet 2x M10x1 thread size valve body M20x1		

spare parts for	106817		
	Part No.	371157	Ref. No. —
	solenoid coil t.max. 125°C 230V seat ø 13mm 17VA		
accessories for	106817		
	Part No.	100908	Ref. No. —
	union screw thread M10x1 for pipe ø 4mm Qty 1 pcs		
	Part No.	100909	Ref. No. —
	union screw thread M10x1 for pipe ø 6mm Qty 1 pcs		
	Part No.	101246	Ref. No. —
	olive for pipe ø 4mm Qty 1 pcs		
	Part No.	101278	Ref. No. —
	olive for pipe ø 10mm Qty 1 pcs		
	Part No.	101286	Ref. No. —
	olive ID ø 6mm Qty 1 pcs		
	Part No.	101300	Ref. No. —
	union nut thread M16x1.5 tube ø 10mm		
	Part No.	101450	Ref. No. —
	olive for pipe ø 8mm L 12.7mm Qty 1 pcs ED ø 10mm		
	Part No.	101451	Ref. No. —
	union nut thread M16x1.5 tube ø 8mm		
	Part No.	110081	Ref. No. —
	knob ø 70mm shaft ø 8x6.5mm shaft flat universal		
	Part No.	112206	Ref. No. —
	knob dial plate silver gas tap PEL21/22/23 t.max.°C ED ø 63mm ID ø 45.5mm		

			
1			
Part No.	106816	Ref. No.	165962
description	gas tap PEL type 21S gas inlet M16x1.5 (tube ø 10mm) bypass nozzle ø 0mm gas outlet M10x1 thermocouple connection M9x1 pilot connection M10x1 shaft ø 8x6.5mm shaft L 22/15mm shaft flat upper with solenoid valve with ignition safety device		
spare parts for	106816		
	Part No.	101060	Ref. No. —
	magnet unit standard L 39mm D1 ø 15.4mm D2 ø 11mm suitable for PEL20-21/JUNKERS/EGA		
	Part No.	101206	Ref. No. —
	gas tap front part shaft ø 8x6.5mm shaft L 22/15mm shaft flat upper/lower suitable for PEL21		
	Part No.	101231	Ref. No. —
	thermocouple nut T1: M9x1 T2: M18x1		

Table continues overleaf







spare parts for		106816	
Part No.	106202	Ref. No.	—
	bypass nozzle type PEL20/21 bore \varnothing 0mm thread M5x0.5		
Part No.	106819	Ref. No.	—
	solenoid valve body		
Part No.	106821	Ref. No.	—
	solenoid valve connection gas inlet M16x1.5 gas outlet 3/8" thread size valve body M20x1		
Part No.	371157	Ref. No.	—
	solenoid coil t.max. 125°C 230V seat \varnothing 13mm 17VA		
accessories for		106816	
Part No.	100908	Ref. No.	—
	union screw thread M10x1 for pipe \varnothing 4mm Qty 1 pcs		
Part No.	100909	Ref. No.	—
	union screw thread M10x1 for pipe \varnothing 6mm Qty 1 pcs		
Part No.	101246	Ref. No.	—
	olive for pipe \varnothing 4mm Qty 1 pcs		
Part No.	101278	Ref. No.	—
	olive for pipe \varnothing 10mm Qty 1 pcs		
Part No.	101286	Ref. No.	—
	olive ID \varnothing 6mm Qty 1 pcs		
Part No.	101300	Ref. No.	—
	union nut thread M16x1.5 tube \varnothing 10mm		
Part No.	101450	Ref. No.	—
	olive for pipe \varnothing 8mm L 12.7mm Qty 1 pcs ED \varnothing 10mm		
Part No.	101451	Ref. No.	—
	union nut thread M16x1.5 tube \varnothing 8mm		
Part No.	110081	Ref. No.	—
	knob \varnothing 70mm shaft \varnothing 8x6.5mm shaft flat universal		
Part No.	112206	Ref. No.	—
	knob dial plate silver gas tap PEL21/22/23 t.max.°C ED \varnothing 63mm ID \varnothing 45.5mm		

22S/O series



1

Part No.	101086	Ref. No.	310140
description	gas tap PEL type 22S/O gas inlet M20x1.5 (tube \varnothing 12mm) bypass nozzle \varnothing 0.35mm gas outlet M20x1.5 (tube \varnothing 12/10mm) thermocouple connection M9x1 pilot connection M10x1 shaft \varnothing 10x8mm shaft L 25/17mm shaft flat lower		
spare parts for		101086	
Part No.	100259	Ref. No.	—
	bypass nozzle type PEL22 bore \varnothing 0.35mm thread M6x0.5		

spare parts for		101086	
Part No.	101058	Ref. No.	—
	magnet unit L 39mm D1 \varnothing 15.4mm D2 \varnothing 13.5mm suitable for PEL22/ EGA24197 standard		
Part No.	101201	Ref. No.	—
	gas tap front part shaft \varnothing 10x8mm shaft L 25/17mm shaft flat upper/ lower suitable for PEL22		
Part No.	101231	Ref. No.	—
	thermocouple nut T1: M9x1 T2: M18x1		
Part No.	101240	Ref. No.	—
	gas connection thread M20x1.5 tube \varnothing 12/10mm for PEL gas taps with gasket and screws horizontal		
Part No.	101460	Ref. No.	—
	O-ring \varnothing 12.37mm D1 \varnothing 2.62mm suitable for PEL22		
Part No.	101461	Ref. No.	—
	screw kit suitable for PEL22 Qty 4 pcs		
accessories for		101086	
Part No.	100908	Ref. No.	—
	union screw thread M10x1 for pipe \varnothing 4mm Qty 1 pcs		
Part No.	100909	Ref. No.	—
	union screw thread M10x1 for pipe \varnothing 6mm Qty 1 pcs		
Part No.	101241	Ref. No.	—
	gas connection thread M20x1.5 tube \varnothing 12/10mm for PEL gas taps vertical		
Part No.	101246	Ref. No.	—
	olive for pipe \varnothing 4mm Qty 1 pcs		
Part No.	101248	Ref. No.	—
	olive for pipe \varnothing 12mm Qty 1 pcs suitable for PEL		
Part No.	101249	Ref. No.	—
	olive for pipe \varnothing 10mm Qty 1 pcs		
Part No.	101250	Ref. No.	—
	union nut thread M20x1.5 for pipe \varnothing 10mm		
Part No.	101251	Ref. No.	—
	union nut thread M20x1.5 for pipe \varnothing 12mm		
Part No.	101286	Ref. No.	—
	olive ID \varnothing 6mm Qty 1 pcs		
Part No.	110080	Ref. No.	—
	knob \varnothing 70mm shaft \varnothing 10x8mm shaft flat universal		
Part No.	112206	Ref. No.	—
	knob dial plate silver gas tap PEL21/22/23 t.max.°C ED \varnothing 63mm ID \varnothing 45.5mm		

















			
1			
Part No.	106818	Ref. No.	156033
description	gas tap PEL type 22S/O gas inlet M20x1.5 (tube ø 12mm) bypass nozzle ø 0mm gas outlet 3/8" thermocouple connection M9x1 pilot connection M10x1 shaft ø 10x8mm shaft L 25/17mm shaft flat lower with solenoid valve		
spare parts for	106818		
	Part No.	101058	Ref. No. —
	magnet unit L 39mm D1 ø 15.4mm D2 ø 13.5mm suitable for PEL22/ EGA24197 standard		
	Part No.	101231	Ref. No. —
	thermocouple nut T1: M9x1 T2: M18x1		
	Part No.	101365	Ref. No. —
	gas connection thread M20x1.5 tube ø 12mm for PEL gas taps horizontal		
	Part No.	106191	Ref. No. —
	bypass nozzle type PEL22 bore ø 0mm thread M6x0.5		
	Part No.	106819	Ref. No. —
	solenoid valve body		
	Part No.	106822	Ref. No. —
	solenoid valve connection gas inlet M20x1.5 gas outlet 3/8" thread size valve body M20x1		
	Part No.	371157	Ref. No. —
	solenoid coil t.max. 125°C 230V seat ø 13mm 17VA		
accessories for	106818		
	Part No.	101248	Ref. No. —
	olive for pipe ø 12mm Qty 1 pcs suitable for PEL		
	Part No.	101249	Ref. No. —
	olive for pipe ø 10mm Qty 1 pcs		
	Part No.	101250	Ref. No. —
	union nut thread M20x1.5 for pipe ø 10mm		
	Part No.	101251	Ref. No. —
	union nut thread M20x1.5 for pipe ø 12mm		



			
1			
Part No.	109510	Ref. No.	310140
description	gas tap PEL type 22S/O gas inlet M20x1.5 (tube ø 12mm) bypass nozzle ø 1.3mm gas outlet M20x1.5 (tube ø 12/10mm) thermocouple connection M8x1 pilot connection M10x1 shaft ø 10x8mm shaft L 25/17mm shaft flat right		
spare parts for	109510		
	Part No.	100438	Ref. No. —
	bypass nozzle type PEL22 bore ø 1.2mm thread M6x0.5		
	Part No.	101058	Ref. No. —
	magnet unit L 39mm D1 ø 15.4mm D2 ø 13.5mm suitable for PEL22/ EGA24197 standard		
	Part No.	101202	Ref. No. —
	gas tap front part shaft ø 8x10mm shaft L 25/17mm shaft flat right/ left suitable for PEL22		
	Part No.	101230	Ref. No. —
	thermocouple nut T1: M8x1 T2: M18x1 aluminium		
	Part No.	101240	Ref. No. —
	gas connection thread M20x1.5 tube ø 12/10mm for PEL gas taps with gasket and screws horizontal		
	Part No.	101460	Ref. No. —
	O-ring ø 12.37mm D1 ø 2.62mm suitable for PEL22		
	Part No.	101461	Ref. No. —
	screw kit suitable for PEL22 Qty 4 pcs		
accessories for	109510		
	Part No.	100908	Ref. No. —
	union screw thread M10x1 for pipe ø 4mm Qty 1 pcs		
	Part No.	100909	Ref. No. —
	union screw thread M10x1 for pipe ø 6mm Qty 1 pcs		
	Part No.	101241	Ref. No. —
	gas connection thread M20x1.5 tube ø 12/10mm for PEL gas taps vertical		
	Part No.	101246	Ref. No. —
	olive for pipe ø 4mm Qty 1 pcs		
	Part No.	101248	Ref. No. —
	olive for pipe ø 12mm Qty 1 pcs suitable for PEL		
	Part No.	101249	Ref. No. —
	olive for pipe ø 10mm Qty 1 pcs		
	Part No.	101250	Ref. No. —
	union nut thread M20x1.5 for pipe ø 10mm		
	Part No.	101251	Ref. No. —
	union nut thread M20x1.5 for pipe ø 12mm		
	Part No.	101286	Ref. No. —
	olive ID ø 6mm Qty 1 pcs		



22S/V series



Part No.	101087	Ref. No.	160094
description	gas tap PEL type 22S/V gas inlet M20x1.5 (tube ø 12mm) bypass nozzle ø 0.35mm gas outlet M20x1.5 (tube ø 12/10mm) thermocouple connection M9x1 pilot connection M10x1 shaft ø 10x8mm shaft L 25/17mm shaft flat upper		
spare parts for	101087		
	Part No.	100259	Ref. No. —
	bypass nozzle type PEL22 bore ø 0.35mm thread M6x0.5		
	Part No.	101058	Ref. No. —
	magnet unit L 39mm D1 ø 15.4mm D2 ø 13.5mm suitable for PEL22/ EGA24197 standard		
	Part No.	101201	Ref. No. —
	gas tap front part shaft ø 10x8mm shaft L 25/17mm shaft flat upper/ lower suitable for PEL22		
	Part No.	101231	Ref. No. —
	thermocouple nut T1: M9x1 T2: M18x1		
	Part No.	101241	Ref. No. —
	gas connection thread M20x1.5 tube ø 12/10mm for PEL gas taps vertical		
	Part No.	101460	Ref. No. —
	O-ring ø 12.37mm D1 ø 2.62mm suitable for PEL22		
	Part No.	101461	Ref. No. —
	screw kit suitable for PEL22 Qty 4 pcs		
accessories for	101087		
	Part No.	100908	Ref. No. —
	union screw thread M10x1 for pipe ø 4mm Qty 1 pcs		
	Part No.	100909	Ref. No. —
	union screw thread M10x1 for pipe ø 6mm Qty 1 pcs		
	Part No.	101240	Ref. No. —
	gas connection thread M20x1.5 tube ø 12/10mm for PEL gas taps with gasket and screws horizontal		
	Part No.	101246	Ref. No. —
	olive for pipe ø 4mm Qty 1 pcs		
	Part No.	101248	Ref. No. —
	olive for pipe ø 12mm Qty 1 pcs suitable for PEL		
	Part No.	101249	Ref. No. —
	olive for pipe ø 10mm Qty 1 pcs		
	Part No.	101250	Ref. No. —
	union nut thread M20x1.5 for pipe ø 10mm		
	Part No.	101251	Ref. No. —
	union nut thread M20x1.5 for pipe ø 12mm		

accessories for	101087		
	Part No.	101286	Ref. No. —
	olive ID ø 6mm Qty 1 pcs		
	Part No.	110080	Ref. No. —
	knob ø 70mm shaft ø 10x8mm shaft flat universal		
	Part No.	112206	Ref. No. —
	knob dial plate silver gas tap PEL21/22/23 t.max. °C ED ø 63mm ID ø 45.5mm		

23S/O series



Part No.	101091	Ref. No.	310141
description	gas tap PEL type 23S/O gas inlet M28x1.5 (tube ø 20mm) bypass nozzle ø 0.35mm gas outlet M24x1.5 (tube ø 16mm) thermocouple connection M9x1 pilot connection M10x1 shaft ø 10x8mm shaft L 35/19mm shaft flat upper		
spare parts for	101091		
	Part No.	100455	Ref. No. —
	bypass nozzle type PEL23/24 bore ø 0.35mm thread M8x0.5		
	Part No.	101045	Ref. No. —
	magnet unit T1: M9x1 T2: M22x1 L 46mm ø 18mm suitable for PEL23S M9x1		
	Part No.	101244	Ref. No. —
	gas connection thread M24x1.5 tube ø 12/16mm horizontal for PEL gas taps		
	Part No.	101336	Ref. No. —
	gas tap front part shaft ø 10x8mm shaft L 35/17mm shaft flat upper/ lower suitable for PEL23S		
	Part No.	101463	Ref. No. —
	screw suitable for PEL23S Qty 4 pcs		
	Part No.	528455	Ref. No. —
	O-ring Viton thickness 2.62mm ID ø 18.72mm Qty 1 pcs		
accessories for	101091		
	Part No.	100908	Ref. No. —
	union screw thread M10x1 for pipe ø 4mm Qty 1 pcs		
	Part No.	100909	Ref. No. —
	union screw thread M10x1 for pipe ø 6mm Qty 1 pcs		
	Part No.	101246	Ref. No. —
	olive for pipe ø 4mm Qty 1 pcs		
	Part No.	101252	Ref. No. —
	union nut thread M24x1.5 for pipe ø 12mm		
	Part No.	101253	Ref. No. —
	union nut thread M24x1.5 PEL for pipe ø 16mm		

Table continues overleaf







accessories for		101091	
	Part No.	101254	Ref. No. —
union nut thread M28x1.5 tube ø 20mm			
	Part No.	101255	Ref. No. —
olive for pipe ø 12mm Qty 1 pcs			
	Part No.	101256	Ref. No. —
olive for pipe ø 16mm Qty 1 pcs			
	Part No.	101257	Ref. No. —
olive for pipe ø 20mm Qty 1 pcs			
	Part No.	101286	Ref. No. —
olive ID ø 6mm Qty 1 pcs			
	Part No.	110080	Ref. No. —
knob ø 70mm shaft ø 10x8mm shaft flat universal			
	Part No.	112206	Ref. No. —
knob dial plate silver gas tap PEL21/22/23 t.max. °C ED ø 63mm ID ø 45.5mm			

gas thermostats

SIT

710 Minisit series



Part No.	107237	Ref. No.	7472030
description	gas thermostat without cap, button and angle SIT type MINISIT 710 t.max. 210°C 70-210°C gas inlet 1/2" gas outlet 3/8" thermocouple connection M9x1 pilot connection M10x1 probe ø 4mm probe L 122mm capillary pipe 1300mm probe type pressure controller no pressure regulator mbar gland nut		
accessories for	107237		
	Part No.	101137	Ref. No. —
cover cap without piezoelectric igniter			
	Part No.	101267	Ref. No. —
reducer IT 3/8" ET 1/2" L 21mm			
	Part No.	101268	Ref. No. —
gas connection thread 3/8" angled with O-ring MINISIT 710			
	Part No.	110068	Ref. No. —
knob suitable for Minisit ø 37mm			

PEL

25ST series



Part No.	101172	Ref. No.	310137
description	gas thermostat PEL type 25ST 100-300°C gas inlet M16x1.5 (tube ø 10mm) bypass nozzle ø 0.35mm gas outlet M16x1.5 (tube ø 10/8mm) thermocouple connection M9x1 pilot connection M10x1 capillary pipe 1200mm probe ø 6mm probe L 100mm shaft ø 8x6.5mm shaft L 21/15mm shaft flat upper		
spare parts for	101172		
	Part No.	100259	Ref. No. —
bypass nozzle type PEL22 bore ø 0.35mm thread M6x0.5			
	Part No.	101060	Ref. No. —
magnet unit standard L 39mm D1 ø 15.4mm D2 ø 11mm suitable for PEL20-21/JUNKERS/EGA			
	Part No.	106200	Ref. No. —
nut thread M9x1 suitable for PEL 24/25S			
accessories for	101172		
	Part No.	100908	Ref. No. —
union screw thread M10x1 for pipe ø 4mm Qty 1 pcs			
	Part No.	100909	Ref. No. —
union screw thread M10x1 for pipe ø 6mm Qty 1 pcs			
	Part No.	101246	Ref. No. —
olive for pipe ø 4mm Qty 1 pcs			
	Part No.	101278	Ref. No. —
olive for pipe ø 10mm Qty 1 pcs			
	Part No.	101286	Ref. No. —
olive ID ø 6mm Qty 1 pcs			
	Part No.	101300	Ref. No. —
union nut thread M16x1.5 tube ø 10mm			
	Part No.	101450	Ref. No. —
olive for pipe ø 8mm L 12.7mm Qty 1 pcs ED ø 10mm			
	Part No.	101451	Ref. No. —
union nut thread M16x1.5 tube ø 8mm			
	Part No.	110079	Ref. No. —
knob dial plate gas thermostat 1-8 silver			
	Part No.	110081	Ref. No. —
knob ø 70mm shaft ø 8x6.5mm shaft flat universal			



ignition parts













pilot burners



SIT

100 series



1

Part No.	106906	Ref. No.	311022
description	pilot burner SIT type 100 series 3 flames nozzle \varnothing 0.2mm gas connection 6mm		
spare parts for	106906		
	Part No.	100245	Ref. No. —
	pilot burner nozzle LPG code 20 bore \varnothing 0.2mm Qty 1 pcs thread M8x0.75		
	Part No.	100855	Ref. No. —
	pilot burner bracket triple		
	Part No.	100885	Ref. No. —
	air mixing sleeve for pilot burner Qty 1 pcs		
	Part No.	100916	Ref. No. —
	compression spring for pilot burner Qty 1 pcs		
	Part No.	100917	Ref. No. —
	gasket for pilot burner Qty 1 pcs aluminium		
	Part No.	100918	Ref. No. —
	screw for pilot burner		
	Part No.	107162	Ref. No. —
	pilot burner cap SIT 3 flames Hmm Lmm Qty 1 pcs		
	Part No.	107701	Ref. No. —
	pilot burner bottom part SIT 100 series nozzle \varnothing 0.2mm		
accessories for	106906		
	Part No.	100245	Ref. No. —
	pilot burner nozzle LPG code 20 bore \varnothing 0.2mm Qty 1 pcs thread M8x0.75		
	Part No.	100246	Ref. No. —
	pilot burner nozzle natural gas bore \varnothing 0.35mm Qty 1 pcs thread M8x0.75		
	Part No.	100904	Ref. No. —
	locking screw M10x1 for pipe \varnothing 4mm Qty 1 pcs		
	Part No.	100905	Ref. No. —
	locking screw M10x1 for pipe \varnothing 6mm Qty 1 pcs		
	Part No.	102110	Ref. No. —
	pilot tube copper pipe \varnothing 4mm thickness 1mm L 3000mm		
	Part No.	102111	Ref. No. —
	pilot tube copper pipe \varnothing 6mm thickness 1mm L 3000mm		



accessories for	106906		
	Part No.	107171	Ref. No. —
	pilot burner nozzle SIT natural/liquid gas bore \varnothing 0.25mm Qty 1 pcs		
	Part No.	107700	Ref. No. —
	pilot burner bottom part SIT 100 series nozzle \varnothing 0.25mm		
	Part No.	107702	Ref. No. —
	pilot burner bottom part SIT 100 series nozzle \varnothing 0.35mm		

HONEYWELL

pilot burners



1

Part No.	102887	Ref. No.	310092
description	pilot burner HONEYWELL type Q327 3 flames		
accessories for	102887		
	Part No.	102891	Ref. No. —
	pilot burner nozzle HONEYWELL LPG code KR14 model Q3480, Q3481, Q348, Q179, Q327		
	Part No.	107496	Ref. No. —
	pilot burner nozzle HONEYWELL natural gas code NE22 model Q3480, Q3481, Q348, Q179, Q327		

electrodes



1

Part No.	102981	Ref. No.	308469
description	ignition electrode D1 \varnothing 7mm L1 30mm BL1 24mm BL2 21.5mm connection F2.8x0.8 cable length 1300mm 1/8"		



1

Part No.	100906	Ref. No.	317980
description	screw connection thread M10x1 for ignition electrode brass Qty 1 pcs WS 10		



piezoelectric igniters

miscellaneous



1	Part No.	nla ¹	Ref. No.	310034
	description	piezoelectric igniter suitable for Minisit connection F6.3x0.8 ømm		

¹no longer available

ignition units



1	Part No.	102485	Ref. No.	308465
	description	ignition unit outputs 2 220-240VAC 0.6VA 50-60Hz		

thermocouples

thermocouple sets universal



1	Part No.	102284	Ref. No.	310144
	description	thermocouple set 8-piece L 900mm		

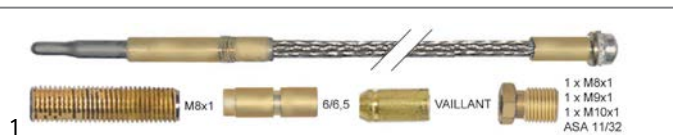

1	Part No.	102286	Ref. No.	634321
	description	thermocouple set 8-piece L 900mm flexible		

threaded thermocouples

threaded thermocouples standard

with socket with thread M8x1

type Junkers with aluminised tip

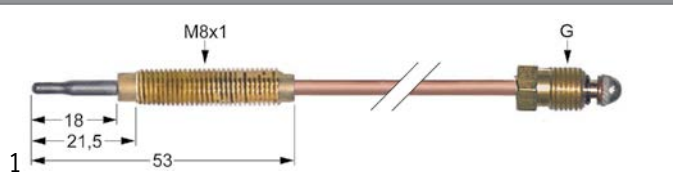

1	Part No.	102060	Ref. No.	310193
	description	thermocouple M8x1 L 1500mm M8x1		
	accessories for	102060		

	Part No.	102067	Ref. No.	—
	nut thread M8x1 H 3mm brass Qty 1 pcs type SEF 1			

gas burners

hob burners

producer-specific hob burners

THIRODE

833 series



1	Part No.	107039	Ref. No.	301004
	description	burner type 833 ø 80mm L 250mm		
	spare parts for	107039		
	Part No.	108011	Ref. No.	303001
	burner cap type 833 ø 78mm			



1	Part No.	108011	Ref. No.	303001
	description	burner cap type 833 ø 78mm		





1	Part No.	108040	Ref. No.	311138
	description	burner head type 833 ø 80mm		
	accessories for	108040		
	Part No.	108011	Ref. No.	303001
	burner cap type 833 ø 78mm			

861 series



1	Part No.	107009	Ref. No.	313001 99013752
	description	burner type 861 ø 80mm L 185mm complete		



 <p>1</p>			
Part No.	108003	Ref. No.	311138 75496
description	burner head for burner cap ø 78mm seat ø 35mm ID ø 30mm ED ø 83mm		
accessories for	108003		
 <p>Part No. 108004 Ref. No. 303001</p> <p>burner cap ø 78mm 5kW mounting ø 72mm</p>			

bar burners

bar burners

 <p>1</p>			
Part No.	104732	Ref. No.	141610
description	bar burner ø 50mm Wmm Hmm L 350mm		

gas nozzles

pilot burner nozzles

pilot burner nozzles HONEYWELL

for series Q349

 <p>1</p>			
Part No.	102889	Ref. No.	310150
description	pilot burner nozzle HONEYWELL LPG bore ø 0.25mm model Q349		

 <p>1</p>			
Part No.	106938	Ref. No.	310152
description	pilot burner nozzle HONEYWELL natural gas code 0.51 model Q349		

bypass nozzles

bypass nozzles PEL22

 <p>1</p>			
Part No.	100428	Ref. No.	310165
description	bypass nozzle type PEL22 bore ø 0.65mm thread M6x0.5		

 <p>1</p>			
Part No.	100407	Ref. No.	310166
description	bypass nozzle type PEL22 bore ø 1mm thread M6x0.5		

burner nozzles

 <p>1</p>			
Part No.	102897	Ref. No.	312126
description	burner nozzle LPG		

 <p>1</p>			
Part No.	102896	Ref. No.	312127
description	burner nozzle natural gas		

auxiliary gas parts

screw connections

union screws

 <p>1</p>			
Part No.	100906	Ref. No.	317980
description	screw connection thread M10x1 for ignition electrode brass Qty 1 pcs WS 10		

 <p>1</p>			
Part No.	100907	Ref. No.	317979
description	screw connection thread M10x1 Qty 1 pcs type SEF 1 ømm for thermocouple		

equipment-specific units

for espresso machines

brewing units

filter holder gaskets

O-rings

 <p>1</p>			
Part No.	510409	Ref. No.	905588
description	O-ring EPDM thickness 5.34mm ID ø 56.52mm Qty 1 pcs		



for dishwashers

boilers

boilers for dishwashers



1

Part No. 518235 **Ref. No.** 2002149H

description boiler ø 145mm L 405mm flange 3 hole flange

air traps

air traps



1

Part No. 518200 **Ref. No.** 2001861H

description air trap ø 34mm H 78mm hose ø 6mm plastic

spare parts for 518200



Part No. 504618 **Ref. No.** —

O-ring EPDM thickness 2.62mm ID ø 15.54mm Qty 1 pcs



Part No. 510075 **Ref. No.** —

flat gasket rubber ED ø 22mm ID ø 13mm thickness 1.5mm Qty 1 pcs



Part No. 510106 **Ref. No.** —

hose connector for air trap

washing and rinsing systems



1

Part No. 517568 **Ref. No.** 2001143H

description counterflange for wash arm support ø 69mm ID ø 63mm H 35mm mounting distance 64mm hole ø 7mm

accessories for 517568



Part No. 531605 **Ref. No.** 2001907H

extension for rinsing shaft ø 16mm H 122mm thread L 12mm WS 19



Part No. 532603 **Ref. No.** —

O-ring EPDM thickness 3.53mm ID ø 69.85mm Qty 1 pcs



Part No. 698750 **Ref. No.** —

throttle disc ø 71.5mm hole ø 17/22mm

EQUIPMENT-SPECIFIC UNITS/KNOBS THIRODE



1

Part No. 513270 **Ref. No.** 2001604H

description throttle disc

knobs

universal knobs



1

Part No. 110247 **Ref. No.** 308078

description knob thermostat t.max. 350°C ø 50mm shaft ø 6x4.6mm shaft flat upper black temperature range 100-350°C



1

Part No. 110240 **Ref. No.** 308064

description knob thermostat t.max. 85°C ø 50mm shaft ø 6x4.6mm shaft flat upper black temperature range 30-85°C



1

Part No. 110075 **Ref. No.** 308091

description knob energy regulator 1-3 t.max. °C ø 50mm shaft ø 6x4.6mm shaft flat upper black

accessories for 110075



Part No. 110135 **Ref. No.** —

rosette knob up to ø 52mm



hinges

edgemount hinges

CAFF/FERMOD

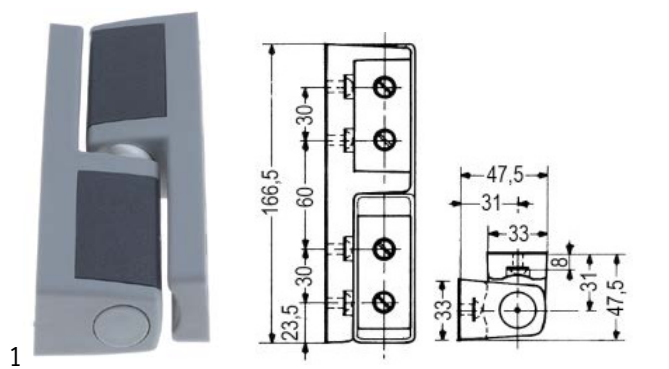

Part No.	700566	Ref. No.	621090
description	edgemount hinge L 166.5mm W 33mm mounting distance 30/60mm hinging left/right with gradient series G 481		



fittings for catering equipment

drain taps

brass

drain taps



Part No.	548001	Ref. No.	313001
description	drain tap 1 1/2" IT O-ring seal kettle connection with union nut A 80mm B1 68mm B2 132mm		
spare parts for	548001		
	Part No.	505092	Ref. No. —
	O-ring EPDM thickness 5.34mm ID ø 43.82mm Qty 1 pcs		
	Part No.	540213	Ref. No. —
	handle ID ø 5mm L 117mm		



Part No.	541673	Ref. No.	3130
description	drain tap 1 1/2" IT with union nut conical seal		
spare parts for	541673		
	Part No.	540213	Ref. No. —
	handle ID ø 5mm L 117mm		
	Part No.	540956	Ref. No. —
	gasket for drain tap hose ext. ø 46mm ID ø 38mm H 2mm		
accessories for	541673		
	Part No.	510404	Ref. No. —
	flat gasket fibre ED ø 44mm ID ø 34mm thickness 2mm Qty 1 pcs		
	Part No.	890116	Ref. No. —
	fitting grease FERMIT GLISSA tube 60g -20 up to +140°C approval complies with KTW recommendation		
	Part No.	890118	Ref. No. —
	fitting grease FERMIT GLISSA can 1000g -20 up to +140°C approval complies with KTW recommendation		
	Part No.	890119	Ref. No. —
	fitting grease FERMIT GLISSA tube 30g -20 up to +140°C approval complies with KTW recommendation		

equipment feet and end caps

equipment feet

with screw mounting

	Part No.	513287	Ref. No.	2001489H
description	equipment foot tube ø 60mm thread M12 thread L 33mm H 155-235mm SS size 2" Qty 1 pcs			



gaskets

refrigeration gaskets

plug-in gaskets

profile 9704

We offer custom-made gaskets for this profile

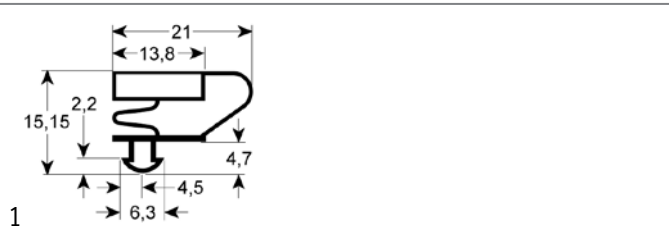

Part No.	902299	Ref. No.	N/A
description	refrigeration gasket profile 9704 Wmm L 2500mm		

profile 9195

We offer custom-made gaskets for this profile

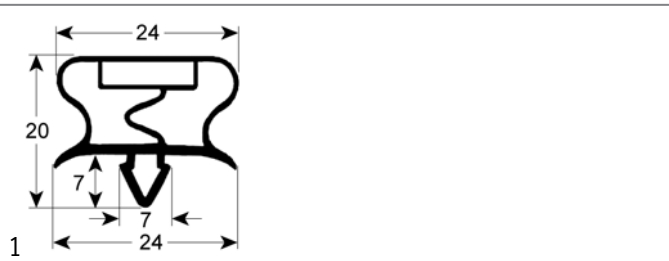

Part No.	901915	Ref. No.	638255
description	refrigeration gasket profile 9195 W 387mm L 572mm plug size		

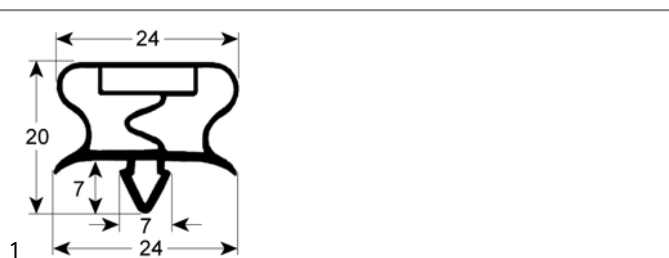

Part No.	901905	Ref. No.	638138
description	refrigeration gasket profile 9195 W 627mm L 1500mm plug size		

gaskets for heated units

door seals

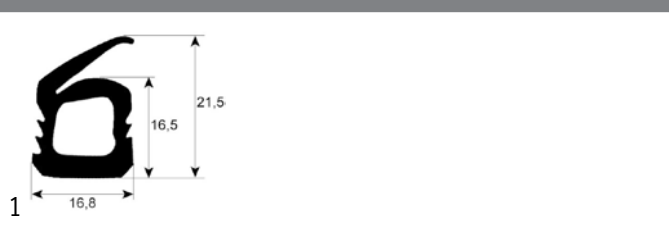

Part No.	900610	Ref. No.	366371
description	door seal profile 2275 W 290mm L 690mm external size Qty 1 3-sided		

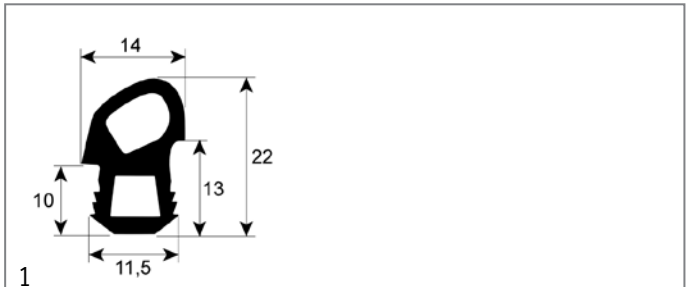

Part No.	901362	Ref. No.	366386
description	door seal profile 2707 Qty supplied by meter		

O-rings

EPDM

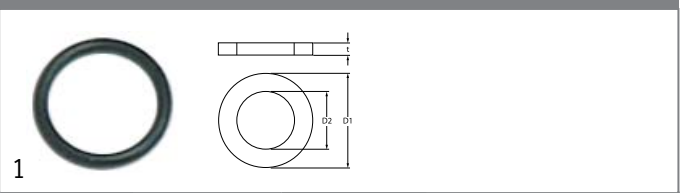

Part No.	510302	Ref. No.	966011
description	O-ring EPDM ID ø 12.42mm thickness 1.78mm Qty 1 pcs		

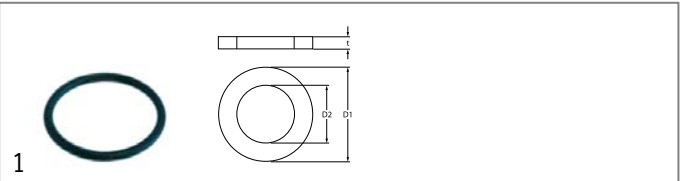

Part No.	510409	Ref. No.	905588
description	O-ring EPDM thickness 5.34mm ID ø 56.52mm Qty 1 pcs		

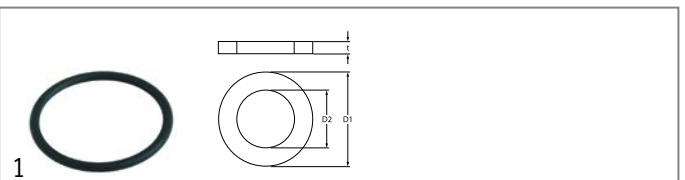

Part No.	691033	Ref. No.	966005
description	O-ring EPDM thickness 5.34mm ID ø 62.87mm Qty 1 pcs		

Viton

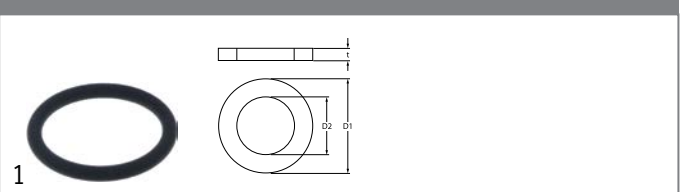

Part No.	524478	Ref. No.	15118K 966003 966017
description	O-ring Viton thickness 5.7mm ID ø 44.2mm Qty 1 pcs		

mechanical components,
equipment accessories
1



sealing washers

rubber gaskets



1

Part No.	518205	Ref. No.	2001368H
description	flat gasket rubber ED ø 61mm ID ø 47mm thickness 2mm Qty 1 pcs		

springs

tension springs



1

Part No.	693881	Ref. No.	385053
description	tension spring ø 23mm total length 90mm wire gauge ø 3mm thread M8		

hoses

drain hoses



1

Part No.	518068	Ref. No.	2001854H
description	drain hose DN34 L 2000mm elbow ø inside 50mm elbow ext. ø 59mm inner hose ø 35mm outer hose ø 42mm PVC		

formed hoses

form U



1

Part No.	518517	Ref. No.	2001408H
description	formed hose for drain pump D1 ø 28mm D2 ø 21mm warewashing U-shape		

fittings, hose and pipe connectors

hose connectors

without screw connection



1

Part No.	504302	Ref. No.	904364
description	T-piece plastic hose ø 10-6-10mm ID ø 5/7.5mm L 62mm W 34mm		

measuring equipment

thermometers

built-in thermometers



1

Part No.	541086	Ref. No.	901018
description	thermometer mounting measurements 58x25.5mm 0 up to +120°C capillary pipe 2000mm probe ø 6mm probe L 23mm		

fastening material

screws

hexagonal screws



1

Part No.	560083	Ref. No.	388105
description	hexagonal screw thread M5 thread L 10mm SS WS 8 Qty 20 pcs DIN 933 / ISO 4017		

cylinder head bolts

DIN 912/ISO 4762



1

Part No.	560335	Ref. No.	388107
description	cylinder head bolt thread M5 thread L 20mm WS 4 SS Qty 1 pcs DIN 912/ISO 4762		

mechanical components,
equipment accessories
1



nuts

hexagonal nuts

DIN 934 / ISO 4032/8673



1

Part No.	560197	Ref. No.	388146
description	nut thread M10 H 8mm WS 17 SS DIN/ISO DIN 934 / ISO 4032/8673 Qty 1 pcs		

DIN 985



1

Part No.	560141	Ref. No.	389540
description	hexagonal nut thread M5 H 5.4mm SS WS 8 Qty 20 pcs DIN/ISO DIN 985 self-locking		

GASTROPARTS.COM

