



**GASTROPARTS**

# Therma

- [EN]** Equipment
- [DE]** Geräte
- [ES]** Aparatos
- [FR]** Équipement
- [IT]** Attrezzature
- [PL]** Urządzenia
- [RU]** Оборудование

✉ [gastroparts@gastroparts.com](mailto:gastroparts@gastroparts.com)

☎ +48 56 657 00 66

📘 [fb.com/gastroparts.global](https://fb.com/gastroparts.global)

**GASTROPARTS.COM**





## heating elements

### heating elements for ovens

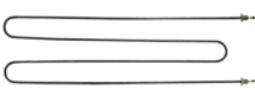

1

<b>Part No.</b>	415350	<b>Ref. No.</b>	OK4982
<b>description</b>	heating element 1600W 400V heating circuits 1 L 610mm W 180mm tube ø 6.5mm 2 hole fixing thread 1/4" dry heating element bain marie mounting distance 173mm		

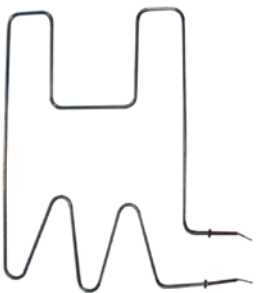

1

<b>Part No.</b>	415356	<b>Ref. No.</b>	OK4863
<b>description</b>	heating element 2750W 400V heating circuits 1 L 538mm W 618mm L1 58mm L2 480mm W1 523mm W2 95mm mounting distance 86.5mm tube ø 8.5mm connection M4 dry heating element		

### heating elements for bain maries



1

<b>Part No.</b>	415350	<b>Ref. No.</b>	OK4982
<b>description</b>	heating element 1600W 400V heating circuits 1 L 610mm W 180mm tube ø 6.5mm 2 hole fixing thread 1/4" dry heating element bain marie mounting distance 173mm		



1

<b>Part No.</b>	415624	<b>Ref. No.</b>	OK4984
<b>description</b>	heating element 2400W 400V heating circuits 1 L 605mm W 380mm connection male faston 6.3mm tube ø 6.5mm 2 hole fixing thread M14x1.5 dry heating element bain marie Hmm mounting distance 374mm		

### heating elements for griddles



1

<b>Part No.</b>	415624	<b>Ref. No.</b>	OK4984
<b>description</b>	heating element 2400W 400V heating circuits 1 L 605mm W 380mm connection male faston 6.3mm tube ø 6.5mm 2 hole fixing thread M14x1.5 dry heating element bain marie Hmm mounting distance 374mm		

### heating elements for large hobs

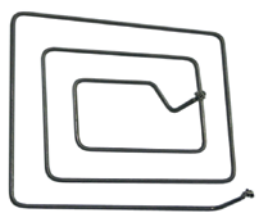

1

<b>Part No.</b>	415576	<b>Ref. No.</b>	OK4814
<b>description</b>	heating element 1335W 400V L 320mm W 275mm H 76mm heating circuits 1 tube ø 6.3mm mounting pos. centre connection length 18mm connection male faston dry heating element 400V		

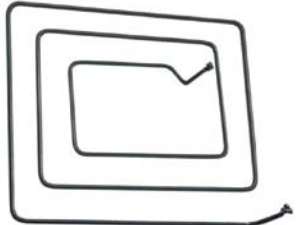

1

<b>Part No.</b>	420291	<b>Ref. No.</b>	OK4855
<b>description</b>	heating element 1505W 440V L 350mm W 300mm H 95mm heating circuits 1 tube ø 6.5mm mounting pos. outer connection length 22mm connection M5		

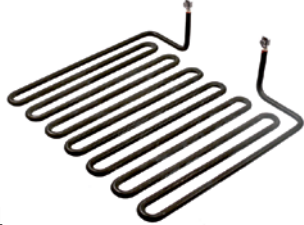



1

<b>Part No.</b>	418701	<b>Ref. No.</b>	OG2883
<b>description</b>	heating element 4000W 400V heating circuits 1 L 300mm W 330mm H 80mm tube ø 8.5mm W1 92.5mm W2 145mm connection screw clamp windings 7		









## heating elements for tilting bratt pan

			
1			
<b>Part No.</b>	415747	<b>Ref. No.</b>	N/A
<b>description</b>	heating element tilting bratt pan 2500W 230V L 518mm W 95mm dry heating element heating circuits 1 tube ø 8.5mm cable length 215mm connection distance 87mm		

			
1			
<b>Part No.</b>	415355	<b>Ref. No.</b>	OK4810
<b>description</b>	heating element tilting bratt pan 2500W 230V L 612mm W 130mm H 8.5mm dry heating element heating circuits 1 tube ø 8.5mm cable length 750mm connection length 17mm connection distance 122mm		



## heating elements for salamanders/toast-

			
1			
<b>Part No.</b>	415559	<b>Ref. No.</b>	OK4777
<b>description</b>	heating element 2100W 400V heating circuits 1 L 260mm W 217mm H 20mm thread M14x1.25 mounting distance 210mm connection length 14mm tube ø 6.5mm 2 hole fixing dry heating element		

			
1			
<b>Part No.</b>	415558	<b>Ref. No.</b>	OK4784
<b>description</b>	heating element 2600W 400V L 361mm W 310mm H 30mm thread M14x1.5 mounting distance 280mm connection length 34mm tube ø 8.5mm connection M4 2 hole fixing dry heating element		
<b>accessories for</b>	415558		
	<b>Part No.</b>	510417	<b>Ref. No.</b> —
	flat gasket fibre ED ø 20mm ID ø 14mm thickness 2mm Qty 1 pcs		
	<b>Part No.</b>	520228	<b>Ref. No.</b> —
	tooth lock washer ID ø 15.3mm ED ø 24mm steel Qty 1 pcs for thread M14		
	<b>Part No.</b>	520230	<b>Ref. No.</b> —
	nut thread M14x1.5 H 5mm WS 19 zinc-coated steel Qty 1 pcs		
	<b>Part No.</b>	521101	<b>Ref. No.</b> —
	nut thread M14x1.5 H 5mm WS 19 SS Qty 1 pcs		
	<b>Part No.</b>	550262	<b>Ref. No.</b> —
	flat gasket copper ED ø 20mm ID ø 14mm thickness 2mm		



## ceramic heaters

## 245x60mm

			
1			
<b>Part No.</b>	415104	<b>Ref. No.</b>	0A2843
<b>description</b>	ceramic emitter 1000W 230V cable beaded cord L 245mm W 60mm H 35mm		
<b>spare parts for</b>	415104		
	<b>Part No.</b>	415109	<b>Ref. No.</b> —
	spring clip		
<b>accessories for</b>	415104		
	<b>Part No.</b>	415110	<b>Ref. No.</b> —
	reflector L 245mm W 95mm H 31mm thickness 0.75mm hole ø 15x40mm		

## immersion heating elements

## 3 hole flange ø47.5mm

			
1			
<b>Part No.</b>	415063	<b>Ref. No.</b>	OC5336
<b>description</b>	heating element 17000W 230V mounting ø 47.5mm heating circuits 3 L 590mm W 29mm H 38mm number of thermostat sleeves 1 thermostat sleeves ø 4mm length thermostat sleeves 225mm thermostat sleeve centre tube ø 8.5mm hole distance 63mm hole ø 10mm connection M5 3 hole flange immersion heater		
<b>accessories for</b>	415063		
	<b>Part No.</b>	510408	<b>Ref. No.</b> 067620
	O-ring EPDM thickness 5.34mm ID ø 47mm Qty 1 pcs		
	<b>Part No.</b>	510562	<b>Ref. No.</b> —
	O-ring silicone thickness 5.34mm ID ø 47mm Qty 1 pcs		



1

<b>Part No.</b>	415066	<b>Ref. No.</b>	OL1849
<b>description</b>	heating element 4500W 230V mounting $\varnothing$ 47.5mm heating circuits 3 L 310mm W 30mm H 36mm number of thermostat sleeves 1 thermostat sleeves $\varnothing$ 7mm length thermostat sleeves 185mm thermostat sleeve eccentric, clinging tube $\varnothing$ 6.3mm hole distance 64mm hole $\varnothing$ 10mm connection male faston 6.3mm 3 hole flange immersion heater		
<b>spare parts for</b>	415066		
	<b>Part No.</b>	510408	<b>Ref. No.</b> 067620
	O-ring EPDM thickness 5.34mm ID $\varnothing$ 47mm Qty 1 pcs		
<b>accessories for</b>	415066		
	<b>Part No.</b>	510408	<b>Ref. No.</b> 067620
	O-ring EPDM thickness 5.34mm ID $\varnothing$ 47mm Qty 1 pcs		
	<b>Part No.</b>	510562	<b>Ref. No.</b> —
	O-ring silicone thickness 5.34mm ID $\varnothing$ 47mm Qty 1 pcs		

1

<b>Part No.</b>	415668	<b>Ref. No.</b>	OK3789
<b>description</b>	heating element 2625W 230V mounting $\varnothing$ 47.5mm heating circuits 1 L 190mm W 41mm H 54mm number of thermostat sleeves 1 thermostat sleeves $\varnothing$ 7mm length thermostat sleeves 170mm thermostat sleeve eccentric, non clinging tube $\varnothing$ 6.3mm hole distance 62mm hole $\varnothing$ 8mm connection M4 3 hole flange immersion heater		
<b>spare parts for</b>	415668		
	<b>Part No.</b>	510408	<b>Ref. No.</b> 067620
	O-ring EPDM thickness 5.34mm ID $\varnothing$ 47mm Qty 1 pcs		
<b>accessories for</b>	415668		
	<b>Part No.</b>	510562	<b>Ref. No.</b> —
	O-ring silicone thickness 5.34mm ID $\varnothing$ 47mm Qty 1 pcs		

3 hole flange  $\varnothing$ 57.5mm

1

<b>Part No.</b>	418779	<b>Ref. No.</b>	OL1630
<b>description</b>	heating element 9000W 230V mounting $\varnothing$ 57.5mm heating circuits 3 L 340mm W 52mm H 54mm tube $\varnothing$ 8.5mm hole distance 72mm hole $\varnothing$ 8mm with integrated fuse INCOLOY		
<b>spare parts for</b>	418779		
	<b>Part No.</b>	510409	<b>Ref. No.</b> —
	O-ring EPDM thickness 5.34mm ID $\varnothing$ 56.52mm Qty 1 pcs		

with round flange  $\varnothing$ 47.5mm

1

<b>Part No.</b>	418782	<b>Ref. No.</b>	OK4734
<b>description</b>	heating element 4500W 230V heating circuits 3 L 330mm W 43mm H 33mm tube $\varnothing$ 6.3mm thermostat sleeves $\varnothing$ 6.25mm length thermostat sleeves 203mm number of thermostat sleeves 1 connection male faston 6.3mm immersion heater round flange mounting $\varnothing$ 47.5mm with temperature protection		
<b>accessories for</b>	418782		
	<b>Part No.</b>	510408	<b>Ref. No.</b> 067620
	O-ring EPDM thickness 5.34mm ID $\varnothing$ 47mm Qty 1 pcs		

with round flange  $\varnothing$ 57.5mm

1

<b>Part No.</b>	418983	<b>Ref. No.</b>	OK7530
<b>description</b>	heating element 12000W 220V heating circuits 3 mounting $\varnothing$ 57.5mm L 455mm W 40mm H 30mm connection M5 immersion heater tube $\varnothing$ 6.3mm connection length 20mm thermostat sleeves $\varnothing$ 6mm number of thermostat sleeves 1 length thermostat sleeves 290mm thermostat sleeve upper dishwasher		

1

<b>Part No.</b>	418982	<b>Ref. No.</b>	OL1833
<b>description</b>	heating element 4000W 230V heating circuits 3 mounting $\varnothing$ 57.5mm L 455mm W 40mm H 32mm connection male faston 6.3mm immersion heater tube $\varnothing$ 6.3mm thermostat sleeves $\varnothing$ 6mm number of thermostat sleeves 1 length thermostat sleeves 290mm thermostat sleeve upper dishwasher		

1



<b>Part No.</b>	418615	<b>Ref. No.</b>	OL1859
<b>description</b>	heating element 7500W 230V heating circuits 3 mounting $\varnothing$ round flange $\varnothing$ 57.5mm L 440mm W 35mm H 55mm round flange immersion heater tube $\varnothing$ 6.2mm H1 20mm H2 35mm L1 40mm L2 400mm		
<b>spare parts for</b>	418615		
	<b>Part No.</b>	510409	<b>Ref. No.</b> —
	O-ring EPDM thickness 5.34mm ID $\varnothing$ 56.52mm Qty 1 pcs		
<b>accessories for</b>	418615		
	<b>Part No.</b>	550002	<b>Ref. No.</b> —
	tension strap H 10mm L 21mm W 10mm hole $\varnothing$ 6.5mm for heating element		

1 electric components



3/4"



<b>Part No.</b>	415580	<b>Ref. No.</b>	OG0334
<b>description</b>	heating element 5000W 400V heating circuits 1 L 404mm W 23mm H 80mm cable length 400mm connection length 85mm immersion heater flange with thread H1 52mm H2 28mm thread 3/4"		
<b>accessories for</b>	415580		
	<b>Part No.</b>	510403	<b>Ref. No.</b> —
	flat gasket fibre ED ø 36.5mm ID ø 27mm thickness 2mm Qty 1 pcs		
	<b>Part No.</b>	510421	<b>Ref. No.</b> —
	gasket copper ED ø 31.8mm ID ø 26.4mm thickness 2.2mm for thread 3/4"		
	<b>Part No.</b>	520234	<b>Ref. No.</b> —
	nut thread 3/4" H 5mm brass WS 30 Qty 1 pcs		



<b>Part No.</b>	415072	<b>Ref. No.</b>	048086
<b>description</b>	heating element 2200W 230V heating circuits 1 L 325mm W 83mm H 25mm thread M14x1 mounting distance 75mm tube ø 8.5mm connection male faston 6.3mm 2 hole fixing immersion heater		
<b>accessories for</b>	415072		
	<b>Part No.</b>	510417	<b>Ref. No.</b> —
	flat gasket fibre ED ø 20mm ID ø 14mm thickness 2mm Qty 1 pcs		
	<b>Part No.</b>	520228	<b>Ref. No.</b> —
	tooth lock washer ID ø 15.3mm ED ø 24mm steel Qty 1 pcs for thread M14		
	<b>Part No.</b>	521133	<b>Ref. No.</b> —
	nut thread M14x1.5 H 6mm WS 19 zinc-coated steel Qty 1 pcs		
	<b>Part No.</b>	550261	<b>Ref. No.</b> —
	nut thread M14x1 H 4mm WS 19 SS Qty 1 pcs		
	<b>Part No.</b>	550262	<b>Ref. No.</b> —
	flat gasket copper ED ø 20mm ID ø 14mm thickness 2mm		

## radiation heaters

## square



<b>Part No.</b>	490008	<b>Ref. No.</b>	OK0589
<b>description</b>	radiation heater L 300mm W 300mm 4000W 400V heating circuits 2 connections 3 square connection type male faston 6.3mm without pan detection EGO		
<b>spare parts for</b>	490008		
	<b>Part No.</b>	499157	<b>Ref. No.</b> —
	protection pipe for temperature probe ceramic L 297mm ED ø 7mm ID ø 5mm		



<b>Part No.</b>	416999	<b>Ref. No.</b>	005942
<b>description</b>	radiation heater rectangular 5000W 230V L 410mm W 280mm heating circuits 3 connections 3x 2 IRCA for fryer		

## hot plates

## square &amp; rectangular

## with radiused edge



<b>Part No.</b>	490056 <sup>1</sup>	<b>Ref. No.</b>	052198
<b>description</b>	hot plate dimensions 300x300mm 3000W 230V with spill ring connection 4 screw clamps protector yes square		

<sup>1</sup>incl. protector



1

<b>Part No.</b>	490057 <sup>1</sup>	<b>Ref. No.</b>	OK4756
<b>description</b>	hot plate dimensions 300x300mm 3000W 400V with spill ring connection 4 screw clamps protector yes square		

<sup>1</sup>incl. protector



1

<b>Part No.</b>	490187	<b>Ref. No.</b>	OG0233
<b>description</b>	hot plate dimensions 350x400mm 4500W 380V with spill ring		

tiltable

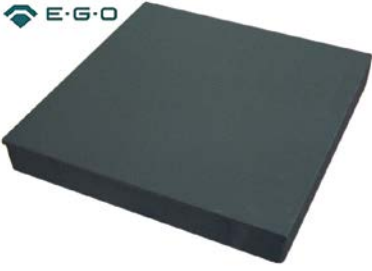

1

<b>Part No.</b>	490090	<b>Ref. No.</b>	OK0381
<b>description</b>	hot plate dimensions 300x300mm 4000W 400V with cast edge tilt boiling plate connection 4 screw clamps H 43mm square		

miscellaneous



1

<b>Part No.</b>	490165	<b>Ref. No.</b>	OK4760
<b>description</b>	hot plate dimensions 350x400mm 4000W 400V connection 2x3		

round

with radiused edge

for domestic and commercial kitchens



1

<b>Part No.</b>	490021	<b>Ref. No.</b>	003931
<b>description</b>	hot plate ø 220mm 2600W 400V connection 4 screw clamps with 8mm spill ring		

accessories

fasteners



1

<b>Part No.</b>	550129	<b>Ref. No.</b>	OG4300
<b>description</b>	bearing screw for tilt boiling plate straight thread M12x80		

## energy regulators

EGO

1-circuit



1

<b>Part No.</b>	380015	<b>Ref. No.</b>	OC1605
<b>description</b>	energy regulator 230V 13A single-circuit turn direction right shaft ø 6x4.6mm shaft L 23mm mounting thread M4 power release 6-100% no. 50.57021.010		

## thermostats

bi-metal thermostats

safety bi-metal thermostats



1



<b>Part No.</b>	390138	<b>Ref. No.</b>	048887	
<b>description</b>	bi-metal safety thermostat hole distancemm switch-off temp. 112°C 1NC 1-pole 16A connection F6.3			
<b>accessories for</b>	390138			
	<b>Part No.</b>	504736	<b>Ref. No.</b>	—
	bracket for contact thermostat			

Table continues overleaf





accessories for	390138		
	Part No.	550388	Ref. No.
			—
	bracket for contact thermostat mounting distance 24.5mm mounting $\varnothing$ 3.8		

## bi-metal thermostats



1

Part No.	390101	Ref. No.	048487
description	bi-metal thermostat hole distance 38mm switch-off temp. 53°C 1CO 1-pole 16A connection F6.3 2 hole fixing		

## control and safety thermostats

EGO

control thermostats

55.13\_ series



1

Part No.	375871	Ref. No.	0E5032
description	thermostat t.max. 110°C temperature range 30-110°C 1-pole 1CO 16A probe $\varnothing$ 6mm probe L 113mm capillary pipe 2930mm capillary pipe isolated gland nut M9x1 shaft $\varnothing$ 6x4.6mm shaft L 23mm shaft position upper rotation 270° H 40mm W 35mm D 30mm		



1

Part No.	375505	Ref. No.	0H2049
description	thermostat t.max. 320°C temperature range 50-320°C 1-pole 1NO 16A probe $\varnothing$ 3mm probe L 160mm capillary pipe 870mm capillary pipe isolated gland nut shaft $\varnothing$ 6x4.6mm shaft L 23mm shaft position upper rotation 270°		



1

Part No.	375810	Ref. No.	0H9843
description	thermostat t.max. 80°C temperature range fixed 80°C 1-pole 1NC 16A probe $\varnothing$ 7.5mm probe L 30.5mm capillary pipe 810mm capillary pipe isolated gland nut shaft L 23mm		

55.34\_ series



1

Part No.	375022	Ref. No.	0H6127
description	thermostat t.max. 180°C temperature range 95-180°C 3-pole 3NO 16A probe $\varnothing$ 6mm probe L 133mm capillary pipe 1780mm capillary pipe isolated 1400mm gland nut M9x1 shaft $\varnothing$ 6x4.6mm shaft L 23mm rotation 270°		



1

Part No.	375766	Ref. No.	002587
description	thermostat t.max. 190°C temperature range 120-190°C 3-pole 1CO/2NO 16A probe $\varnothing$ 6mm probe L 133mm capillary pipe 880mm capillary pipe isolated 350mm gland nut shaft $\varnothing$ 6x4.6mm shaft L 23mm shaft position upper rotation 270°		



<b>Part No.</b>	375763	<b>Ref. No.</b>	OKW841
<b>description</b>	thermostat t.max. 206°C temperature range 120-206°C 3-pole 1C0/2NO 16A probe ø 4mm probe L 157mm capillary pipe 1780mm capillary pipe isolated 1500mm gland nut shaft ø 6x4.6mm shaft L 23mm shaft position upper rotation 270°		



<b>Part No.</b>	390038	<b>Ref. No.</b>	OKI260
<b>description</b>	thermostat t.max. 90°C temperature range 30-90°C 3-pole 3C0 16A probe ø 6mm probe L 215mm capillary pipe 900mm capillary pipe isolatedmm gland nut shaft Lmm		



<b>Part No.</b>	375038	<b>Ref. No.</b>	OH6217
<b>description</b>	thermostat t.max. 300°C temperature range 50-300°C 3-pole 3NO 16A probe ø 6mm probe L 79mm capillary pipe 1740mm capillary pipe isolated 800mm gland nut shaft ø 6x4.6mm shaft L 23mm shaft position upper rotation 270°		
<b>accessories for</b>	375038		
	<b>Part No.</b>	110123	<b>Ref. No.</b> —
	knob thermostat t.max. 300°C ø 50mm shaft ø 6x4.6mm shaft flat upper black temperature range 50-300°C rotation 270°		

safety thermostats

55.13\_ series



<b>Part No.</b>	375854	<b>Ref. No.</b>	OE5086
<b>description</b>	safety thermostat switch-off temp. 126°C 1-pole 16A probe ø 6mm probe L 129mm capillary pipe 1730mm capillary pipe isolated 800mm gland nut M9x1 shaft ø 6x4.6mm starting temperature 120°C probe		



<b>Part No.</b>	375621	<b>Ref. No.</b>	OK8421
<b>description</b>	thermostat t.max. 320°C temperature range 50-320°C 3-pole 3NO 16A probe ø 3mm probe L 219mm capillary pipe 1200mm capillary pipe isolated 1200mm gland nut shaft ø 6x4.6mm shaft L 23mm shaft position upper rotation 318°		



<b>Part No.</b>	375106	<b>Ref. No.</b>	OH6142
<b>description</b>	safety thermostat switch-off temp. 190°C 1-pole 16A probe ø 3.1mm probe L 178mm capillary pipe 350mm capillary pipe isolatedmm gland nut M9x1 probe SS		





55.31\_ series



<b>Part No.</b>	375108	<b>Ref. No.</b>	052331
<b>description</b>	safety thermostat switch-off temp. 250°C 3-pole 1x20/2x0.5A probe ø 6mm probe L 157mm capillary pipe 1230mm capillary pipe isolated 800mm gland nut probe SS		

55.32\_ series

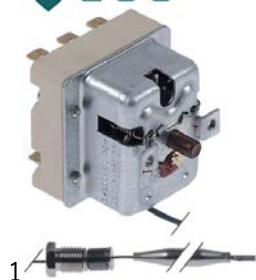

<b>Part No.</b>	375394	<b>Ref. No.</b>	0K3967
<b>description</b>	safety thermostat switch-off temp. 135°C 3-pole 1CO/2NC 20A probe ø 6mm probe L 73mm capillary pipe 1490mm capillary pipe isolated 1350mm gland nut M9x1 probe SS		

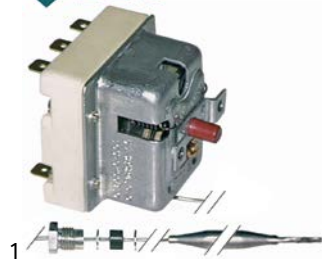

<b>Part No.</b>	375150	<b>Ref. No.</b>	0H6219
<b>description</b>	safety thermostat switch-off temp. 145°C 3-pole 20A probe ø 3mm probe L 178mm capillary pipe 1790mm capillary pipe isolated 800mm gland nut M9x1 probe		



<b>Part No.</b>	375455	<b>Ref. No.</b>	002730
<b>description</b>	safety thermostat switch-off temp. 350°C 1-pole 16A probe ø 11mm probe L 16mm capillary pipe 900mm capillary pipe isolated 900mm gland nut probe screw-in probe probe thread M14x1		

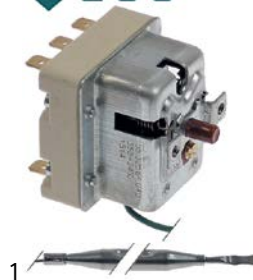

<b>Part No.</b>	390141	<b>Ref. No.</b>	006826
<b>description</b>	safety thermostat switch-off temp. 350°C 3-pole 3NC 20A probe ø 6mm probe L 77mm capillary pipe 1490mm capillary pipe isolated 800mm gland nut probe SS		

control thermostats with operation switch

55.10/19\_ series

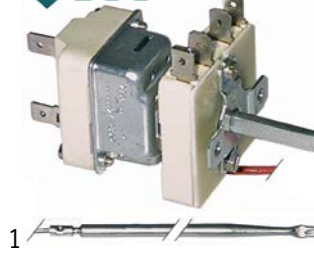

<b>Part No.</b>	390052	<b>Ref. No.</b>	052330
<b>description</b>	thermostat t.max. 185°C temperature range 90-185°C 1-pole 1NO 15A probe ø 4mm probe L 229mm capillary pipe 2500mm capillary pipe isolated 1200/200mm gland nut shaft ø 6x4.6mm shaft L 23mm shaft position upper° rotation 270° outer switch 2NO		



55.13\_ series

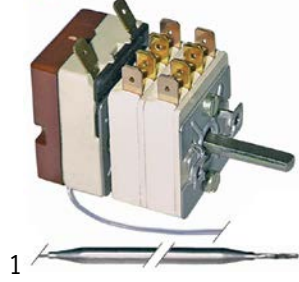



<b>Part No.</b>	375053	<b>Ref. No.</b>	OK5023
<b>description</b>	thermostat t.max. 110°C temperature range 30-110°C 1-pole 1NO 16A probe ø 6mm probe L 113mm capillary pipe 830mm capillary pipe isolated 800mm gland nut shaft ø 6x4.6mm shaft L 23mm shaft position upper rotation 270° outer switch 2NO/2NO		

55.34\_ series

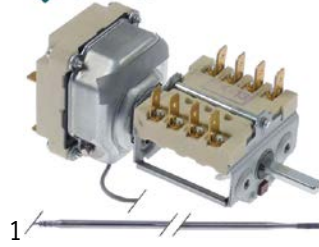

<b>Part No.</b>	375877	<b>Ref. No.</b>	OG2529
<b>description</b>	thermostat t.max. 530°C temperature range 100-530°C 3-pole 3NO 16A probe ø 3.9mm probe L 228mm capillary pipe 1110mm capillary pipe isolated 1000mm gland nut shaft ø 6x4.6mm shaft L 23mm shaft position shaft position 90° rotation 270° outer switch 0-1 with operation switch		



<b>Part No.</b>	390919	<b>Ref. No.</b>	077018015428
<b>description</b>	thermostat temperature range 50-300°C 3-pole 3NO 16A probe ø 4mm probe L 292mm capillary pipe 2300mm capillary pipe isolated 2260mm gland nut shaft ø 6x4.6mm shaft L 25.5mm shaft position upper rotation 270° outer switch 49.41015.500		
<b>spare parts for</b>	390919		
	<b>Part No.</b>	300002	<b>Ref. No.</b> 0A2134
	cam switch 2 operating positions 4NO 16A sequence 0-1 shaft ø 6x4.6mm shaft L 23mm connection male faston 6.3mm ceramic		
	<b>Part No.</b>	550059	<b>Ref. No.</b> 0A2205
	connecting bow short for switch Qty 1 pcs		

accessories

gland nut accessories

locking screws



<b>Part No.</b>	504738	<b>Ref. No.</b>	067899
<b>description</b>	screw connection for probe thread M12x1 ID ø 6.3mm L 18mm		
<b>accessories for</b>	504738		
	<b>Part No.</b>	528485	<b>Ref. No.</b> —
	O-ring EPDM thickness 1.78mm ID ø 6.07mm Qty 1 pcs		

connecting bows



<b>Part No.</b>	550059	<b>Ref. No.</b>	0A2205
<b>description</b>	connecting bow short for switch Qty 1 pcs		

switches and momentary switches

rocker/momentary rocker switches

30x11mm



<b>Part No.</b>	301014	<b>Ref. No.</b>	OK6805
<b>description</b>	momentary rocker switch mounting measurements 30x11mm black 1NO 250V 16A connection male faston 6.3mm ambient temperature max. 85/125°C protection IP40 mounting ømm male faston 6.3mm		

30x22mm



<b>Part No.</b>	301091	<b>Ref. No.</b>	OK7092
<b>description</b>	rocker switch mounting measurements 30x22mm red 2NO 400V 10A illuminated 0-I connection male faston 6.3mm ambient temperature max. 125/55°C protection IP40		



## microswitches

## lever actuated



1

<b>Part No.</b>	347006	<b>Ref. No.</b>	OK5144
<b>description</b>	microswitch with lever 250V 1NO connection with cable ambient temperature max. 85°C		



1

<b>Part No.</b>	345254	<b>Ref. No.</b>	046286
<b>description</b>	microswitch with lever 250V 16A 1CO connection male faston 6.3mm ambient temperature max. 120°C mounting distance 22mm actuating force: 60g lever length 58mm		



1

<b>Part No.</b>	346072	<b>Ref. No.</b>	0E0209
<b>description</b>	microswitch with lever 250V 6A 1CO connection male faston 6.3mm ambient temperature max. 85°C lever length 71mm		



1

<b>Part No.</b>	345049	<b>Ref. No.</b>	OK3764
<b>description</b>	microswitch with lever CO connection male faston		

## roller-lever actuated

## non-standard



1

<b>Part No.</b>	347008	<b>Ref. No.</b>	0E5629
<b>description</b>	microswitch with handle with a switch 250V 5A 1CO connection cable ambient temperature max. 85°C lever length 20mm		

## pin-plunger actuated

## M10



1

<b>Part No.</b>	345032	<b>Ref. No.</b>	OKI395
<b>description</b>	microswitch with plunger thread M10x1 thread L 12mm 250V 16A 1CO connection male faston 6.3mm stroke 7mm mounting distance 22mm L 28mm ambient temperature max. 125°C type SP9603 actuating force: 180g		

## M12



1

<b>Part No.</b>	347009	<b>Ref. No.</b>	OK7633
<b>description</b>	microswitch with plunger thread M12x1 380V 20A 1CO connection screw ambient temperature max. 85°C		

## non-standard



1

<b>Part No.</b>	345777	<b>Ref. No.</b>	004288
<b>description</b>	microswitch		

## position switches

## TELEMECANIQUE (EFA)



1

<b>Part No.</b>	346807	<b>Ref. No.</b>	OK4382
<b>description</b>	position switch plastic 1NO/1NC 400V 3A L 116.7mm W 40mm H 36mm protection IP67 actuating force: 1800g screw connection M19 mounting distance 30x60mm		



float switches

<b>Part No.</b>	345484	<b>Ref. No.</b>	OE5808
<b>description</b>	float switch thread M16x1.5 1NO or 1NC ø 17.5mm L 92mm mounting ø 16mm 250V 1A cable cable length 2000mm		

cam switches

on/off

<b>Part No.</b>	300218	<b>Ref. No.</b>	OE5222
<b>description</b>	cam switch 2 operating positions 6NO sequence 0-1 16A shaft ø 6x4.6mm shaft L 23mm connection male faston 6.3mm plastic		

4-position

<b>Part No.</b>	300007	<b>Ref. No.</b>	OH6602
<b>description</b>	cam switch 4 operating positions 1NO/2CO sequence 0-1-2-3 16A shaft ø 6x4.6mm shaft L 23mm connection male faston 6.3mm 4-position ceramic		

7-position

<b>Part No.</b>	300004	<b>Ref. No.</b>	OK6627
<b>description</b>	cam switch 7 operating positions 1NO/2CO sequence 0-1-2-3-4-5-6 16A shaft ø 6x4.6mm shaft L 23mm connection male faston 6.3mm 7-position ceramic		

<b>Part No.</b>	300106	<b>Ref. No.</b>	0A2022
<b>description</b>	cam switch 7 operating positions 1NO/2CO sequence 0-1-2-3-4-5-6 32A shaft ø 6x4.6mm shaft L 23mm connection screw 7-position shaft flat upper		

<b>Part No.</b>	300237	<b>Ref. No.</b>	18005022
<b>description</b>	cam switch 7-position shaft ø 6x4.6mm shaft L 23mm ambient temperature max. 150°C		

with potentiometer

<b>Part No.</b>	346984	<b>Ref. No.</b>	OK5063
<b>description</b>	cam switch 2 operating positions 4NO sequence 0-1 32A shaft ø 6x4.6mm shaft L 23mm connection cable 2400mm cable length 2400mm 50kOhm ceramic		



## operation switches

E-G-O



1

<b>Part No.</b>	300002	<b>Ref. No.</b>	0A2134
<b>description</b>	cam switch 2 operating positions 4NO 16A sequence 0-1 shaft $\varnothing$ 6x4.6mm shaft L 23mm connection male faston 6.3mm ceramic		

E-G-O



1

<b>Part No.</b>	300080	<b>Ref. No.</b>	026945
<b>description</b>	cam switch 2 operating positions 4NO 16A sequence 0-1 shaft $\varnothing$ 6x4.6mm shaft L 23mm connection screw operation switch ceramic ambient temperature max. 150°C		
<b>accessories for</b>	300080		
	<b>Part No.</b>	551456	<b>Ref. No.</b> —
	gasket for switch ED $\varnothing$ 14mm ID $\varnothing$ 2.5mm thickness 3.5mm white		

E-G-O



1

<b>Part No.</b>	300200	<b>Ref. No.</b>	054375
<b>description</b>	operation switch 2 operating positions 2NO 16A sequence 0-1 shaft $\varnothing$ 6x4.6mm shaft L 23mm connection male faston 6.3mm operation switch ceramic		

## miscellaneous

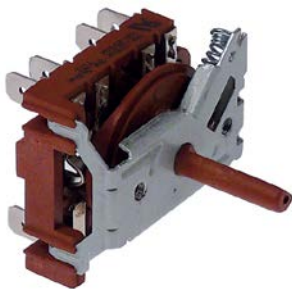

1

<b>Part No.</b>	300221	<b>Ref. No.</b>	0E5131
<b>description</b>	cam switch 2 operating positions 4NO sequence 1-2 16A shaft $\varnothing$ 6x4.6mm shaft L 23mm connection male faston 6.3mm plastic		

## rotary switches

## GOTTAK



1

<b>Part No.</b>	300219	<b>Ref. No.</b>	0E5132
<b>description</b>	switch 3 operating positions 3NO sequence 0-1 momentary switch 16A shaft $\varnothing$ 6x4.6mm shaft L 23mm connection male faston 6.3mm plastic		

## KRAUS &amp; NAIMER

## rotary switches



1

<b>Part No.</b>	301206	<b>Ref. No.</b>	0K4923
<b>description</b>	rotary switch 4 0-1-2-3 sets of contacts 8 type CA11-AT08A188 690V 7.5A shaft $\varnothing$ 4.8x6mm shaft L 18mm shaft round connection screw code 37/000100 marking 7BC540		

## miscellaneous



1

<b>Part No.</b>	346390	<b>Ref. No.</b>	0K4925
<b>description</b>	rotary switch sets of contacts 1 2 0-1 250V 16A illuminated connection male faston 6.3mm mounting measurements 25x25mm		

## magnetic switches

## 35x22mm

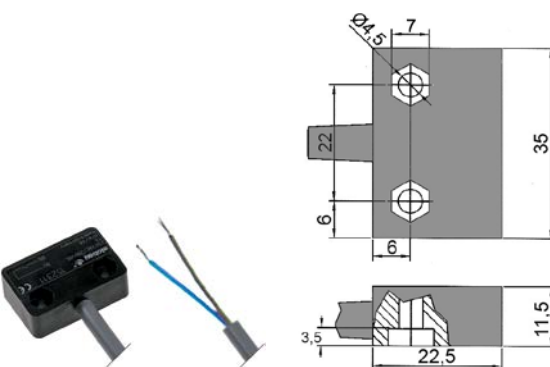

1

<b>Part No.</b>	347003	<b>Ref. No.</b>	0K7171
<b>description</b>	magnetic switch L 35mm W 22mm 1NO 230V 1A 60W		





36x26mm

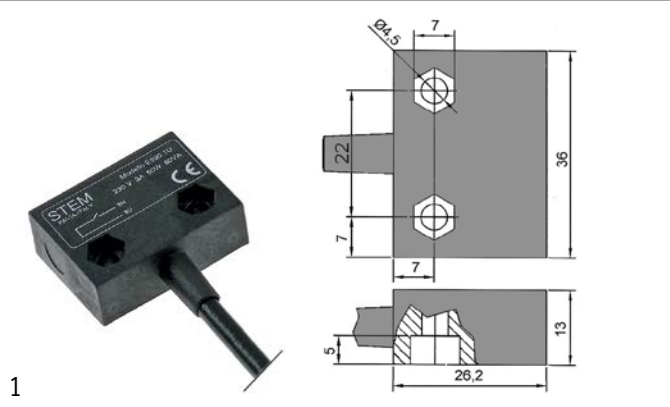

1

<b>Part No.</b>	346998	<b>Ref. No.</b>	049966
<b>description</b>	magnetic switch L 36mm W 26mm 1NO 230V 3A P max. 60W connection cable cable length 2000mm		
<b>accessories for</b>	346998		
	<b>Part No.</b>	347001	<b>Ref. No.</b> 088361
	magnet ømm L 23mm H 18mm W 16mm ID ømm ED ømm M5		

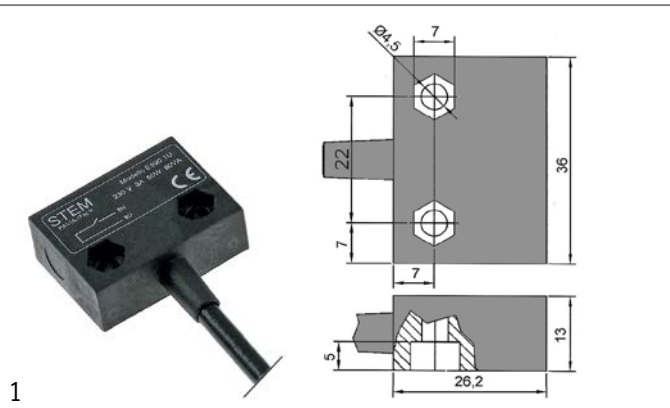

1

<b>Part No.</b>	347000	<b>Ref. No.</b>	049967
<b>description</b>	magnetic switch L 36mm W 26mm 1NO 230V 3A P max. 60W connection cable cable length 5500mm		

accessories

magnets

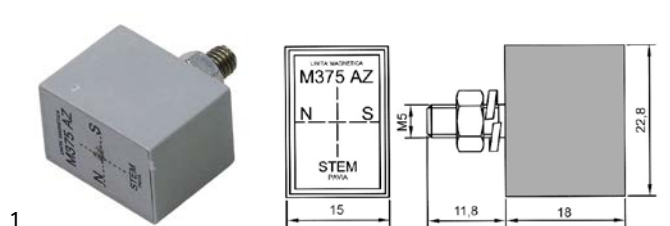

1

<b>Part No.</b>	347001	<b>Ref. No.</b>	088361
<b>description</b>	magnet ømm L 23mm H 18mm W 16mm ID ømm ED ømm M5		

miscellaneous

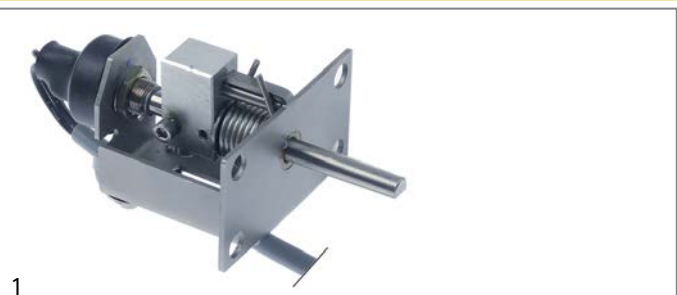

1

<b>Part No.</b>	347830	<b>Ref. No.</b>	769045-01
<b>description</b>	switch for tilting kettle with potentiometer		
<b>accessories for</b>	347830		
	<b>Part No.</b>	347831	<b>Ref. No.</b> —
	stop for switch shaft ø 6x4.6mm		

control equipment



lamps



1

<b>Part No.</b>	359606	<b>Ref. No.</b>	OK2043
<b>description</b>	neon light bulb socket Ba9s 220V 2W clear ø 10mm L 28mm		

**accessories for** 359606

	<b>Part No.</b>	359832	<b>Ref. No.</b> —
	lamp socket mounting measurements ø16.2mm socket Ba9s connection male faston 6.3mm		
	<b>Part No.</b>	359853	<b>Ref. No.</b> —
	lamp socket mounting measurements ø18.2mm socket Ba9s connection male faston 6.3mm		



1

<b>Part No.</b>	359807	<b>Ref. No.</b>	OK9110
<b>description</b>	light bulb socket Ba9s 24V 2W ø 10mm L 28mm clear		

encoders and potentiometers





1

<b>Part No.</b>	346984	<b>Ref. No.</b>	OK5063
<b>description</b>	cam switch 2 operating positions 4NO sequence 0-1 32A shaft ø 6x4.6mm shaft L 23mm connection cable 2400mm cable length 2400mm 50kOhm ceramic		





			
1			
<b>Part No.</b>	402070	<b>Ref. No.</b>	OG0317
<b>description</b>	potentiometer 10KOhm rotation 360° shaft ø 6x4.6mm shaft L 18mm connection male faston 2.8mm thread M10x0.75 thread L 9mm		



			
1			
<b>Part No.</b>	402071	<b>Ref. No.</b>	OG2907
<b>description</b>	potentiometer cable length 1200mm		

## lamps

### indicator lights

#### indicator light lenses

ø10mm (type SRZ-3)

			
1			
<b>Part No.</b>	359123	<b>Ref. No.</b>	004896
<b>description</b>	indicator light housings mounting measurements ø10mm green round Qty 1 pcs		
<b>accessories for</b>	359123		
	<b>Part No.</b>	359132	<b>Ref. No.</b> —
	indicator lamp green 250V connection male faston 6.3mm protection IP54 ambient temperature max. 85°C		

#### indicator lamps for socket type SRZ / SDK / SDY / SFK



			
1			
<b>Part No.</b>	359133	<b>Ref. No.</b>	OKI362
<b>description</b>	indicator lamp 400V green connection male faston 6.3mm		

#### lamps

#### light bulbs

			
1			
<b>Part No.</b>	359807	<b>Ref. No.</b>	OK9110
<b>description</b>	light bulb socket Ba9s 24V 2W ø 10mm L 28mm clear		

#### neon light bulbs

			
1			
<b>Part No.</b>	359606	<b>Ref. No.</b>	OK2043
<b>description</b>	neon light bulb socket Ba9s 220V 2W clear ø 10mm L 28mm		
<b>accessories for</b>	359606		
	<b>Part No.</b>	359832	<b>Ref. No.</b> —
	lamp socket mounting measurements ø16.2mm socket Ba9s connection male faston 6.3mm		
	<b>Part No.</b>	359853	<b>Ref. No.</b> —
	lamp socket mounting measurements ø18.2mm socket Ba9s connection male faston 6.3mm		

			
1			
<b>Part No.</b>	359602	<b>Ref. No.</b>	OH7036
<b>description</b>	neon light bulb socket E14 230V clear ø 14mm L 30mm		

			
1			
<b>Part No.</b>	359603	<b>Ref. No.</b>	OH7037
<b>description</b>	neon light bulb socket E14 380V clear ø 14mm L 30mm		

#### indicator lights (complete)

ø10mm

with screw socket

			
1			
<b>Part No.</b>	359378	<b>Ref. No.</b>	0A2224
<b>description</b>	indicator light ø 10mm 230V green connection male faston 6.3mm socket screw base		

ø12.5mm

			
1			
<b>Part No.</b>	359999	<b>Ref. No.</b>	OK9096
<b>description</b>	indicator light ø 12.5mm 230V clear connection male faston 6.3mm		





ø14mm			
with plug-in socket			
			
1			
<b>Part No.</b>	359150	<b>Ref. No.</b>	053153
<b>description</b>	indicator light ø 14mm red 400V connection male faston 6.3mm temp.-resist. 105°C square		

ø19mm			
			
1			
<b>Part No.</b>	359519	<b>Ref. No.</b>	OK4898
<b>description</b>	indicator light housings mounting measurements ø19mm socket E14 clear		

ø20mm			
			
1			
<b>Part No.</b>	359516	<b>Ref. No.</b>	OK4903
<b>description</b>	indicator light ø 20mm 230V clear		

			
1			
<b>Part No.</b>	359514	<b>Ref. No.</b>	18003964
<b>description</b>	indicator light ø 20mm 230V green connection male faston 6.3mm ambient temperature max. 125°C		

ø22mm			
			
1			
<b>Part No.</b>	359506	<b>Ref. No.</b>	OK5094
<b>description</b>	indicator light ø 22mm 230V green connection screw temp.-resist. 60°C		

			
1			
<b>Part No.</b>	359512	<b>Ref. No.</b>	OK6368
<b>description</b>	indicator light ø 22mm 400V clear connection screw temp.-resist. 60°C		

			
1			
<b>Part No.</b>	359510	<b>Ref. No.</b>	OK6366
<b>description</b>	indicator light ø 22mm 400V green connection screw temp.-resist. 60°C		

miscellaneous			
			
1			
<b>Part No.</b>	359006	<b>Ref. No.</b>	OK3776
<b>description</b>	indicator light white 230V		

screw-on/push-on fit

neon light bulbs			
			
1			
<b>Part No.</b>	359606	<b>Ref. No.</b>	OK2043
<b>description</b>	neon light bulb socket Ba9s 220V 2W clear ø 10mm L 28mm		
<b>accessories for</b>	359606		
	<b>Part No.</b>	359832	<b>Ref. No.</b>
			—
	<b>description</b>	lamp socket mounting measurements ø16.2mm socket Ba9s connection male faston 6.3mm	
	<b>Part No.</b>	359853	<b>Ref. No.</b>
			—
	<b>description</b>	lamp socket mounting measurements ø18.2mm socket Ba9s connection male faston 6.3mm	

			
1			
<b>Part No.</b>	359602	<b>Ref. No.</b>	OH7036
<b>description</b>	neon light bulb socket E14 230V clear ø 14mm L 30mm		

			
1			
<b>Part No.</b>	359603	<b>Ref. No.</b>	OH7037
<b>description</b>	neon light bulb socket E14 380V clear ø 14mm L 30mm		

light bulbs			
for ovens			
			
1			
<b>Part No.</b>	359612	<b>Ref. No.</b>	054840
<b>description</b>	light bulb t.max. 300°C socket E14 25W 230V ø 25mm L 56mm lens L 30mm for oven lamp type Philips		



## for indicator lights



1

<b>Part No.</b>	359807	<b>Ref. No.</b>	OK9110
<b>description</b>	light bulb socket Ba9s 24V 2W ø 10mm L 28mm clear		

## oven lamps

## universal oven lamps

55x100mm



1







<b>Part No.</b>	359714	<b>Ref. No.</b>	055022
<b>description</b>	gasket for bulb socket		



1

<b>Part No.</b>	101372	<b>Ref. No.</b>	OK7521
<b>description</b>	oven lamp complete L 100mm W 55mm 230V 25W socket E14 rectangular temp.-resist. 300°C connection male faston 6.3mm		

## spare parts for 101372

	<b>Part No.</b>	359612	<b>Ref. No.</b>	054840
	<b>description</b>	light bulb t.max. 300°C socket E14 25W 230V ø 25mm L 56mm lens L 30mm for oven lamp type Philips		
	<b>Part No.</b>	359698	<b>Ref. No.</b>	—
	<b>description</b>	lamp socket L 100mm W 55mm socket E14 connection male faston 6.3mm		
	<b>Part No.</b>	359714	<b>Ref. No.</b>	055022
	<b>description</b>	gasket for bulb socket		
	<b>Part No.</b>	359715	<b>Ref. No.</b>	—
	<b>description</b>	lamp glass L 110mm W 65mm thickness 5mm		
	<b>Part No.</b>	359716	<b>Ref. No.</b>	—
	<b>description</b>	frame for bulb socket		

## lamps

## light bulbs



1

<b>Part No.</b>	359612	<b>Ref. No.</b>	054840
<b>description</b>	light bulb t.max. 300°C socket E14 25W 230V ø 25mm L 56mm lens L 30mm for oven lamp type Philips		

## timers

## programme timers



1

<b>Part No.</b>	360349	<b>Ref. No.</b>	069926
<b>description</b>	timer CDC 11803 engines 1 chambers 3 operation time 150s 230V shaft ømm shaft Lmm manuf. no. 11803F1BEE000.0010 motor type M48R ATS type 11803F1 / 238046		

## spare parts for 360349

	<b>Part No.</b>	360673	<b>Ref. No.</b>	—
	<b>description</b>	motor kit pinion ø 6.8mm teeth 15 230V voltage AC 50/60Hz turn direction clockwise motor ø 48mm H 18.5mm motor type UDS-40NE1RNZ165 cable length 150mm with holder		



1

<b>Part No.</b>	360024	<b>Ref. No.</b>	069926 (old version)
<b>description</b>	timer FIBER P25 engines 1 chambers 3 operation time 2min 230V shaft ømm shaft Lmm manuf. no. P255J03H3N6 motor type M51BJ0L6400		

## spare parts for 360024

	<b>Part No.</b>	360674	<b>Ref. No.</b>	—
	<b>description</b>	motor kit pinion ø 6.8mm teeth 15 230V voltage AC 50/60Hz turn direction counterclockwise motor ø 48mm H 18.5mm motor type UDS40NE1RNZ165 cable length 150mm with holder		



mechanical timers



1

<b>Part No.</b>	350170	<b>Ref. No.</b>	0H6114
<b>description</b>	timer 600 2-pole operation time 60min impulse mechanical 2NO at 250V 16A permanent position no shaft 6x4.6mm shaft L 21mm mounting distance 28mm		

contactors

BENEDIKT & JÄGER

power contactors



1

<b>Part No.</b>	380777	<b>Ref. No.</b>	0K9134
<b>description</b>	auxiliary contactor resistive load 20A 230VAC main contacts 4NO type K2-07A40230		



1

<b>Part No.</b>	380773	<b>Ref. No.</b>	0L0285
<b>description</b>	power contactor resistive load 25A 230VAC (AC3/400V) 10A/4kW main contacts 3NO auxiliary contacts 1NC connection screw connection type K3-10A01230		



1

<b>Part No.</b>	380679	<b>Ref. No.</b>	003598
<b>description</b>	power contactor resistive load 25A 230VAC (AC3/400V) 12A/5.5kW main contacts 3NO auxiliary contacts 1NO connection screw connection type K2-12A01230		



1

<b>Part No.</b>	380674	<b>Ref. No.</b>	0H7051
<b>description</b>	power contactor resistive load 25A 230VAC (AC3/400V) 12A/5.5kW main contacts 4NO connection screw connection type K2-12A0040230		



1

<b>Part No.</b>	381079	<b>Ref. No.</b>	004012
<b>description</b>	power contactor resistive load 25A 230VAC (AC3/400V) 16A/7.5kW main contacts 3NO auxiliary contacts 1NO connection screw connection type K2-16A10230		



1

<b>Part No.</b>	380779	<b>Ref. No.</b>	0K3968
<b>description</b>	power contactor resistive load 25A 24VAC (AC3/400V) 14A/5.5kW main contacts 3NO auxiliary contacts 1NO connection screw connection type K3-14ND10		



1

<b>Part No.</b>	380789	<b>Ref. No.</b>	0K9132
<b>description</b>	power contactor resistive load 32A 230VAC main contacts 3 auxiliary contacts 1 with 2 auxiliary contacts NC		



1

<b>Part No.</b>	381171	<b>Ref. No.</b>	OK9124
<b>description</b>	power contactor resistive load 32A 24VAC (AC3/400V) 22A/11kW main contacts 3NO auxiliary contacts 1NO connection screw connection type K3-22ND10		



1

<b>Part No.</b>	380637	<b>Ref. No.</b>	054928
<b>description</b>	power contactor resistive load 45A 230VAC main contacts 3NO auxiliary contacts 1NO connection screw type K2-23A10 230		



1

<b>Part No.</b>	380776	<b>Ref. No.</b>	007104
<b>description</b>	power contactor resistive load 80A 230VAC (AC3/400V) 40A/18.5kW main contacts 3NO auxiliary contacts connection screw connection type K3-40A00230 contacts		



1

<b>Part No.</b>	380676	<b>Ref. No.</b>	OTRA70
<b>description</b>	power contactor resistive load 80A 230VAC (AC3/400V) 45A/20kW main contacts 3NO connection screw connection type K2-45A00230		

## auxiliary contacts



1

<b>Part No.</b>	380677	<b>Ref. No.</b>	047046
<b>description</b>	auxiliary contact contacts 1NC AC15 10A for contactors K2/K3 connection screw type HN01 AC1 25A		



1

<b>Part No.</b>	380678	<b>Ref. No.</b>	046995
<b>description</b>	auxiliary contact contacts 1NO AC15 10A for contactors K2/K3 connection screw type HN10 AC1 25A		



1

<b>Part No.</b>	380781	<b>Ref. No.</b>	048497
<b>description</b>	auxiliary contact contacts 1NO AC15 6A for contactors K2/K5 connection screw type HA10 AC1 25A		

## solid state relays

## CRYDOM



1

<b>Part No.</b>	403038	<b>Ref. No.</b>	OK5070
<b>description</b>	solid state relay CRYDOM 1 phase 50A 480V 4-32VDC L 57mm W 45mm screw type CWD4850P		





relays

power relays

with bracket mounting



1

<b>Part No.</b>	380702	<b>Ref. No.</b>	005033
<b>description</b>	power relays FINDER 230VAC 16A 3NO connection male faston 6.3mm flange dimensions 36x38x68mm manuf. no. 62.83.8.230.0300 230V		

with male contacts

bullet connectors, 11 contacts



1

<b>Part No.</b>	380132	<b>Ref. No.</b>	0K3700	
<b>description</b>	power relays Italiana Relè 230VAC 10A 3CO connection plug-in connection round 11-pole manuf. no. C43-230AC ZVE11 250V 11-pole			
<b>accessories for</b>	380132			
	<b>Part No.</b>	380136	<b>Ref. No.</b>	—
	 relay socket 11-pole connection plug-in connection round 11-pole dimensions 65x28x40mm 250V voltage AC 10A Italiana Relè manuf. no. ZVE11			

female contact 4.8mm





1

<b>Part No.</b>	380475	<b>Ref. No.</b>	0K4944	
<b>description</b>	power relays FINDER 220-240VAC 12A 2CO connection F4.8 raster size 10mm plug-in connection manuf. no. 56.32.8.230.0040 250V 2-pole connection 4.8mm			
<b>accessories for</b>	380475			
	<b>Part No.</b>	380476	<b>Ref. No.</b>	—
	 relay socket dimensions 78x27x33.5mm 250V voltage AC 10A FINDER manuf. no. 96.72			

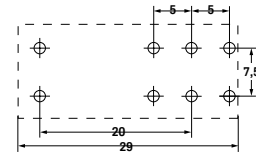
plug-in/print relays



1

<b>Part No.</b>	380333	<b>Ref. No.</b>	0E5849	
<b>description</b>	print relay 230VAC 2CO at 250V 8A connection pins raster size 5mm FINDER manuf. no. 40.52.8.230.0000 95.65/95.75			
<b>accessories for</b>	380333			
	<b>Part No.</b>	380340	<b>Ref. No.</b>	—
	 relay socket dimensions 62x36x15mm 250V voltage AC 10A Italiana Relè manuf. no. ZMEM/5			
	<b>Part No.</b>	380505	<b>Ref. No.</b>	—
	 relay socket 2CO 40.52 dimensions 81.9x15.5x75mm 250V voltage AC 10A FINDER manuf. no. 95.95.3			
	<b>Part No.</b>	381181	<b>Ref. No.</b>	—
	 relay socket 2-pole 40.51/40.52/40.61 connection screw clamp dimensions 15.8x78.6mm 250V voltage AC 10A FINDER manuf. no. 95.75			

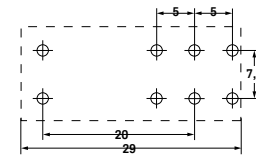

1

<b>Part No.</b>	380853	<b>Ref. No.</b>	0E5172
<b>description</b>	print relay 24VAC 1CO at 250V 16A connection pins raster size 5mm FINDER manuf. no. 40.61.8.024.0000 95.65/95.75		

time relays

time relays



1

<b>Part No.</b>	360407	<b>Ref. No.</b>	075659
<b>description</b>	timer FINDER T23522203F0 time range 0.5s-120h 24VAC 2x6A mounting measurements 45x70mm 2CO		





## transformers

### toroidal core transformers

			
1			
<b>Part No.</b>	401663	<b>Ref. No.</b>	OL0174
<b>description</b>	transformer primary 230V secondary 12V 25VA		

### encapsulated transformers

#### with screw connection

			
1			
<b>Part No.</b>	401665	<b>Ref. No.</b>	OL1158
<b>description</b>	transformer primary 230/400V secondary 24-48V 400VA connection screw 50-60Hz		

### for lighting

			
1			
<b>Part No.</b>	401547	<b>Ref. No.</b>	002856
<b>description</b>	transformer primary 230V secondary 11.5V 50W		

## electronic controllers

### ELIWELL

#### universal controllers

##### built-in version

			
1			
<b>Part No.</b>	379559	<b>Ref. No.</b>	OS0989
<b>description</b>	electronic controller ELIWELL type IC901 mounting measurements 71x29mm 12V voltage AC/DC NTC/PTC relay outputs 1 relay refrigeration front measurements 74x32mm built-in depth 60mm protection IP65 accuracy superior to 0.5% from final value% defr. funct. no -55 up to +150°C display 2½ digit Templn1 yes 15A		
<b>accessories for</b>	379559		
	<b>Part No.</b>	379053	<b>Ref. No.</b> —
	temperature probe PTC 1kOhm cable PVC probe -50 up to +150°C cable -10 up to 100°C probe ø6x30mm cable length 3m without screw connection 2-wire		
	<b>Part No.</b>	379064	<b>Ref. No.</b> —
	temperature probe PTC 1kOhm cable silicone probe -50 up to +150°C cable -50 up to +180°C probe ø6x40mm cable length 3m without screw connection 2-wire		
	<b>Part No.</b>	379161	<b>Ref. No.</b> —
	temperature probe NTC 10kOhm cable thermoplastic probe -40 up to +110°C cable -40 up to +110°C probe ø6x14mm cable length 3m without screw connection 2-wire		
	<b>Part No.</b>	379782	<b>Ref. No.</b> —
	temperature probe PTC 1kOhm cable thermoplastic probe -50 up to +150°C cable -40 up to +110°C probe ø6x14mm cable length 3m 2-wire resistor 1kOhm		

			
1			
<b>Part No.</b>	379690	<b>Ref. No.</b>	OS0789
<b>description</b>	electronic controller ELIWELL type ICPlus902 model ICP16D0750000 mounting measurements 71x29mm 230V voltage AC NTC/PTC relay outputs 1 CO-15A(8) NTC/PTC built-in depth 60mm defr. funct. -50 up to +150°C display 3½ digits		
<b>accessories for</b>	379690		
	<b>Part No.</b>	378194	<b>Ref. No.</b> —
	temperature probe NTC 10kOhm cable PVC probe -20 up to +80°C cable -10 up to 100°C probe ø7x24.5mm cable length 1.5m without screw connection 2-wire		
	<b>Part No.</b>	379052	<b>Ref. No.</b> —
	temperature probe PTC 1kOhm cable silicone probe -50 up to +150°C cable -50 up to +180°C probe ø6x40mm cable length 1.5m without screw connection 2-wire		
	<b>Part No.</b>	379053	<b>Ref. No.</b> —
	temperature probe PTC 1kOhm cable PVC probe -50 up to +150°C cable -10 up to 100°C probe ø6x30mm cable length 3m without screw connection 2-wire		

Table continues overleaf



accessories for		379690	
Part No.	379057	Ref. No.	—
temperature probe NTC 10kOhm cable PVC probe -20 up to +80°C cable -10 up to 100°C probe ø6x25mm cable length 3m 2-wire			
Part No.	379064	Ref. No.	—
temperature probe PTC 1kOhm cable silicone probe -50 up to +150°C cable -50 up to +180°C probe ø6x40mm cable length 3m without screw connection 2-wire			
Part No.	379142	Ref. No.	—
temperature probe PTC 1kOhm cable PVC probe -50 up to +150°C cable -10 up to 100°C probe ø6x30mm cable length 1.5m without screw connection 2-wire			
Part No.	379160	Ref. No.	—
temperature probe NTC 10kOhm cable thermoplastic probe -40 up to +110°C cable -40 up to +110°C probe ø6x14mm cable length 1.5m without screw connection 2-wire			
Part No.	379161	Ref. No.	—
temperature probe NTC 10kOhm cable thermoplastic probe -40 up to +110°C cable -40 up to +110°C probe ø6x14mm cable length 3m without screw connection 2-wire			
Part No.	379343	Ref. No.	—
temperature probe NTC 10kOhm cable silicone probe -40 up to +110°C cable -50 up to +180°C probe ø6x40mm cable length 3m 2-wire			
Part No.	379458	Ref. No.	—
temperature probe NTC 10kOhm cable silicone probe -40 up to +110°C cable -50 up to +180°C probe ø6x40mm cable length 1.5m without screw connection 2-wire			
Part No.	379781	Ref. No.	—
temperature probe PTC 1kOhm cable thermoplastic probe -50 up to +150°C cable -40 up to +110°C probe ø6x14mm cable length 1.5m without screw connection 2-wire			
Part No.	379782	Ref. No.	—
temperature probe PTC 1kOhm cable thermoplastic probe -50 up to +150°C cable -40 up to +110°C probe ø6x14mm cable length 3m 2-wire resistor 1kOhm			

miscellaneous

miscellaneous



Part No.	381419	Ref. No.	712.340.179
description electronic controller kit type ERT4V 230V Pt1000 +50 up to +130°C relay outputs 1CO			

probes

producer-specific probes

probes



Part No.	379476	Ref. No.	OK5154
description probe Pt1000 cable PTFE probe -100 up to 450°C cable -40 up to +250°C connection male faston 4.8mm thread probe ø6/10x22mm cable length 2m			



Part No.	400910	Ref. No.	OC0202
description temperature probe NTC 10kOhm cable silicone probe -40 up to +110°C cable -50 up to +180°C connection coded plug thread probe ø4.5x30mm cable length 0.35m			



Part No.	379404	Ref. No.	OK8490
description temperature probe Pt1000 cable glass fibre probe -70 up to +500°C cable -50 up to +350°C connection male faston thread probe ø4x-60mm cable length 1.6m			



Part No.	379100	Ref. No.	OC5342
description temperature probe Pt1000 cable silicone probe -70 up to +500°C cable -50 up to +180°C connection male faston 4.8mm thread probe ø4x235mm cable length 1.8m			

accessories for		379100	
Part No.	693745	Ref. No.	—
description gasket PTFE ED ø 20mm ID ø 15mm thickness 1mm Qty 1 pcs			
Part No.	697993	Ref. No.	—
description sleeve for temperature probe ø 11mm ID ø 4.3mm H 22.4mm			



Part No.	378012	Ref. No.	OK5047
description temperature probe PTC 2kOhm cable probe -50 up to +150°C cable°C connection F6.3 thread M10x1 cable lengthm			



Part No.	402005	Ref. No.	086344
description temperature probe PTC 2kOhm cable TPE probe -50 up to +150°C cable -40 up to +110°C connection plug thread probe ø6x50mm cable length 1.6m			



Part No.	379427	Ref. No.	OK5058
description temperature probe thermocouple K (NiCr-Ni) cable glass fibre probe -50 up to 1150°C cable -50 up to +350°C connection 2-wire thread probe ø4x20mm cable length 2.6m			



Part No.	379098	Ref. No.	OK5623
description temperature probe thermocouple K (NiCr-Ni) cable Vetrotex probe -50 up to 1150°C cable -50 up to +350°C connection 2-wire thread M6/M10 probe ø6x20mm cable length 2.1m			



core probes



1

<b>Part No.</b>	379407	<b>Ref. No.</b>	OK8488
<b>description</b>	core temperature probe Pt1000 cable SS corrugated hose probe -40 up to +250°C cable -40 up to +250°C connection 2-wire probe ø4x100mm thread M8 cable length 2.7m handle ø 10mm handle length 45mm		



1

<b>Part No.</b>	379060	<b>Ref. No.</b>	002673
<b>description</b>	core temperature probe Pt1000 cable SS corrugated hose probe -40 up to +250°C cable -40 up to +250°C connection 2-wire probe ø4x100mm thread M8 cable length 2m handle ø 10mm handle length 45mm		

accessories

adapters

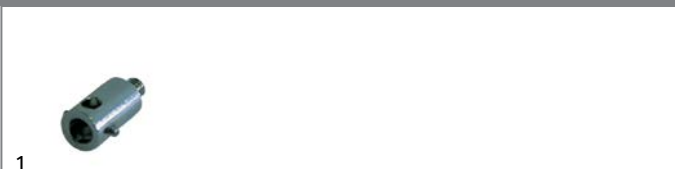

1

<b>Part No.</b>	379093	<b>Ref. No.</b>	OK5057
<b>description</b>	bayonet adapter L 18mm thread M6x1 ID ø 7/4mm ED ø 12mm		





1

<b>Part No.</b>	378127	<b>Ref. No.</b>	OKI657
<b>description</b>	bayonet adapter L 32mm thread M6x1 ID ø 7/4mm ED ø 12mm		



1

<b>Part No.</b>	379094	<b>Ref. No.</b>	OG2155
<b>description</b>	bayonet adapter L 39mm thread M6x1 ID ø 7/4mm ED ø 12mm		
<b>accessories for</b>	379094		
	<b>Part No.</b>	<b>Ref. No.</b>	—
	379092		
<b>description</b>	temperature probe thermocouple K (NiCr-Ni) cable silicone probe -50 up to 1150°C cable -50 up to +180°C connection 2-wire thread probe ø4x20mm cable length 2.6m		



1

<b>Part No.</b>	378128	<b>Ref. No.</b>	0KE127
<b>description</b>	bayonet adapter L 59mm thread M6x1 ID ø 7/4mm ED ø 12mm		

miscellaneous

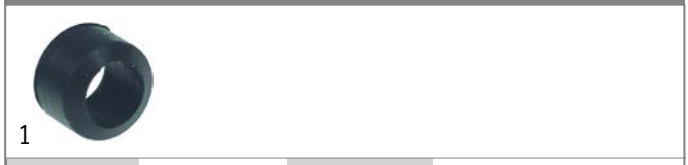

1

<b>Part No.</b>	550924	<b>Ref. No.</b>	002075
<b>description</b>	gasket for probe ID ø 6mm EPDM		

electronics

PCBs

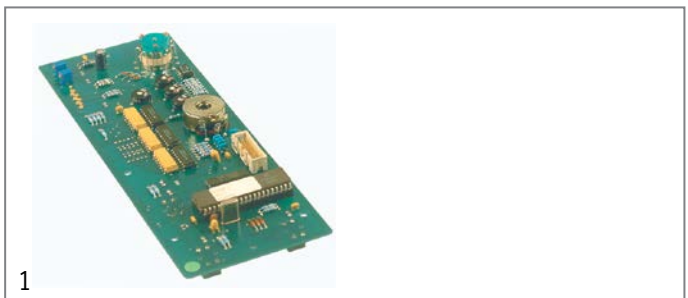

1

<b>Part No.</b>	401575	<b>Ref. No.</b>	OK4880
<b>description</b>	control PCB		

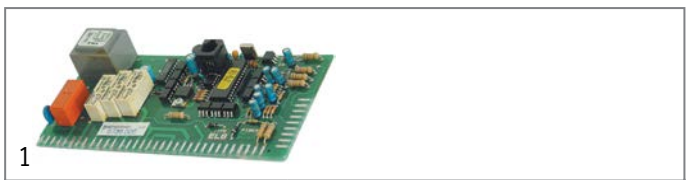

1

<b>Part No.</b>	400929	<b>Ref. No.</b>	048926
<b>description</b>	PCB		

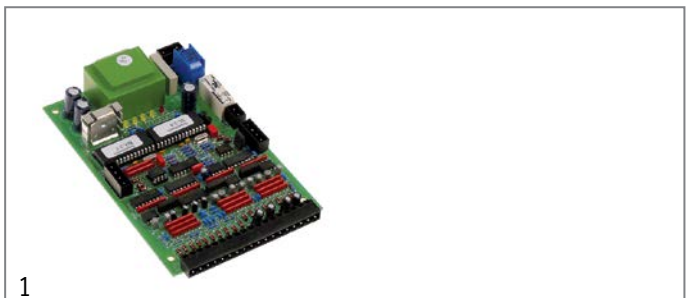

1

<b>Part No.</b>	401964	<b>Ref. No.</b>	OK5071
<b>description</b>	PCB		

1

<b>Part No.</b>	401573	<b>Ref. No.</b>	OK4882
<b>description</b>	power PCB		

Triacs



1

<b>Part No.</b>	402072	<b>Ref. No.</b>	OK5065
<b>description</b>	Triac		

keypads

front foils



1

<b>Part No.</b>	401574	<b>Ref. No.</b>	OK4333
<b>description</b>	keypad foil		

membrane keypads



1

<b>Part No.</b>	400915	<b>Ref. No.</b>	049956
<b>description</b>	membrane keypad		

accessories



1

<b>Part No.</b>	400997	<b>Ref. No.</b>	002670
<b>description</b>	push button		

solenoid valves

solenoid valves (water)

ROBERTSHAW/INVENSYS

medium temperature: 90°C 90°C 60°C  
 ambient temperature: 60°C 25°C 60°C  
 duty cycle: 40% 100% 100%



1

<b>Part No.</b>	372021	<b>Ref. No.</b>	OK5389
<b>description</b>	solenoid valve double straight 230VAC inlet 3/4" outlet 11.5mm DN10 EATON (INVENSYS)		

spare parts and accessories

reducers

outlet side



1

<b>Part No.</b>	371252	<b>Ref. No.</b>	OK5369
<b>description</b>	reducer type EATON (INVENSYS) flow rate 1.2l/min pressure range 0 up to 10bar tolerance ±15/25% blue		



1

<b>Part No.</b>	371253	<b>Ref. No.</b>	OK5368
<b>description</b>	reducer type EATON (INVENSYS) flow rate 2.5l/min pressure range 0 up to 10bar tolerance ±15/25% brown		

TP

solenoid valves with reducers



1

<b>Part No.</b>	370375	<b>Ref. No.</b>	0F0001
<b>description</b>	solenoid valve triple straight 230VAC inlet 3/4" outlet 11.5mm t.max. 90°C TP plastic output A 2.5l/min output C 0.25l/min flow regulating valve outlet A yellow flow regulating valve outlet C red		

**solenoid valves (gas)**

**BRAHMA**

spare parts and accessories

solenoid coils



1

<b>Part No.</b>	101968	<b>Ref. No.</b>	005548
<b>description</b>	solenoid valve 230VAC 20VA seat ø 17mm coil type 13902001 BRAHMA		

**ball valves electric**



1

<b>Part No.</b>	401139	<b>Ref. No.</b>	0C0882
<b>description</b>	ball valve inlet 3/4" IT outlet 3/4" IT with plug 230V L 65mm 50/60Hz closed off-current mode of operation electric connection cable 200mm		

**pressure switches**

for boiling pans



1

<b>Part No.</b>	541459	<b>Ref. No.</b>	0G2935
<b>description</b>	pressure control with cable		

**electrodes**



1

<b>Part No.</b>	400121	<b>Ref. No.</b>	055346
<b>description</b>	level electrode 1/4" total length 121mm probe L 94mm insulated probe length 90mm PTFE insulated connection angled, male faston 6.3mm stainless steel		



1

<b>Part No.</b>	400124	<b>Ref. No.</b>	002694
<b>description</b>	level electrode push-in total length 128mm probe L 103mm insulated probe length 93mm PTFE insulated connection F6.3 ø 2.5mm		



1

<b>Part No.</b>	378013	<b>Ref. No.</b>	0K4871
<b>description</b>	level electrode to clip		



**fans**

axial fans

import



1

<b>Part No.</b>	601080 <sup>1</sup>	<b>Ref. No.</b>	0C4423	
<b>description</b>	axial fan L 119mm W 119mm H 38mm 230VAC 50/60Hz 23/20W bearing ball bearing connection male faston 2.8mm metal ADDA fan wheel ø 110mm temp.-resist. 70°C			
<b>accessories for</b>	601080			
	<b>Part No.</b>	550898	<b>Ref. No.</b>	—
	connecting cable cable length 2000mm connection F 2.8 connection distance 7.9mm for axial flow fan			
	<b>Part No.</b>	692519	<b>Ref. No.</b>	—
	guard L 120mm W 120mm plastic			

<sup>1</sup>with ball bearings



refrigeration fans

cold air circulating fans (complete)

ebm-papst

R2E series

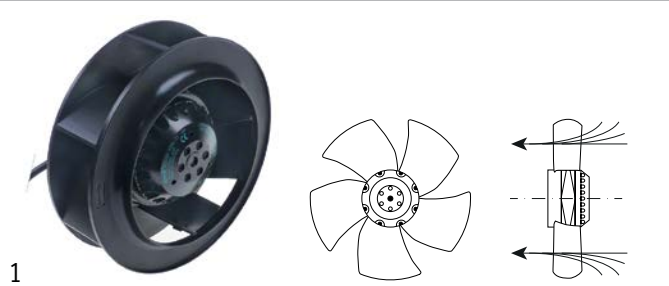

<b>Part No.</b>	601536	<b>Ref. No.</b>	0E5666
<b>description</b>	fan R2E190-A026-73 fan wheel ø 190mm blades 6 230V 50/60Hz 58/75W ø 190mm H 70mm 2700rpm cable length 450mm rotation direction right ebm-papst sucking suitable capacitor 2µF		
<b>spare parts for</b>	601536		
	<b>Part No.</b>	365170	<b>Ref. No.</b>
	capacitor capacity 2µF 425V tolerance 5% 50/60Hz ambient temperature max. -25 to +85°C ø 25mm L 49mm M8 plastic connection cable 250mm 416.17.74 protection		

cross flow fans

ebm-papst



<b>Part No.</b>	601505	<b>Ref. No.</b>	OK5059
<b>description</b>	cross flow fan QLN65/2400A17-3030L roller ø 65mm roller length 240mm laminated core thickness 29mm motor position right 230V/50Hz 22W refrigeration bearing silicone connection F 6.3 0 up to +60°C 230V throughput 200m³/h 50Hz		

COPREL

double fans



<b>Part No.</b>	601026	<b>Ref. No.</b>	OK3707
<b>description</b>	cross flow fan COPREL TFD(FD) roller ø 60mm roller length 2x180mm laminated core thickness 35mm motor position centre 230V/50-60Hz 42W refrigeration bearing rubber connection male faston 6.3mm coil type airflow 255m³/h -10 up to +60°C		

hot air motors

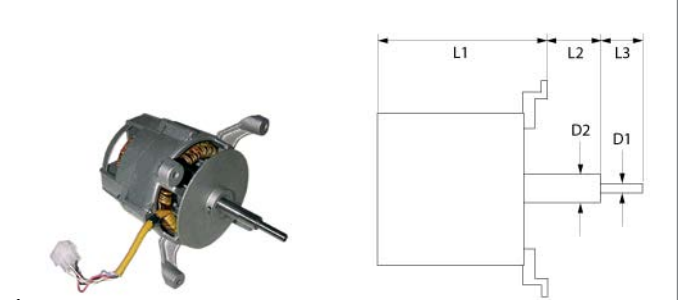

<b>Part No.</b>	500141	<b>Ref. No.</b>	0F0007
<b>description</b>	fan motor 230V 1 phase 50/60Hz 0.19kW 1450/1750rpm speeds 1 L1 150mm L2 52mm L3 35mm D1 ø 9/10mm D2 ø 14mm M6R IT 1.3A Cos(fi) 0.91 at 50Hz 1450rpm at 60Hz 1750rpm type LM80/4 no. 596477 shaft flat length 12mm		



<b>Part No.</b>	601220	<b>Ref. No.</b>	0C6462
<b>description</b>	fan wheel D1 ø 280mm H1 100mm blades 6 D2 ø 10mm D3 ø 10mm H2 37mm H3 22mm		



<b>Part No.</b>	511300	<b>Ref. No.</b>	002873
<b>description</b>	O-ring Viton thickness 3.53mm ID ø 28.17mm for 57 series for motor shaft		



<b>Part No.</b>	511301	<b>Ref. No.</b>	002699
<b>description</b>	shaft seal ID ø 16mm ED ø 38mm thickness 18mm		







## hot air fans

## miscellaneous

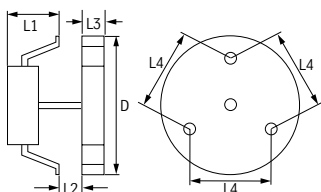

1



<b>Part No.</b>	601011	<b>Ref. No.</b>	031484
<b>description</b>	hot air fan 220-240V 40W 50/60Hz L1 65mm L2 15mm L3 25mm L4 87mm fan wheel ø 150mm FIME type C25R8023CLH		
<b>accessories for</b>	601011		
	<b>Part No.</b>	550879	<b>Ref. No.</b> —
	insulation ø 130mm thickness 3mm hole ø 20mm for hot air fan		
	<b>Part No.</b>	601260	<b>Ref. No.</b> —
	nut thread M6L IT for hot air fan		

## motors

## gear motors

## for tilting bratt pans



1

<b>Part No.</b>	501580	<b>Ref. No.</b>	763001 763090
<b>description</b>	gear motor SKF/ATB type MAX30-C220450A101N0-005 24V L 490mm W 185mm H 120mm		

## miscellaneous

1

<b>Part No.</b>	500620	<b>Ref. No.</b>	0K4843
<b>description</b>	gear motor for kettle		

## spindle motors

## SKF/ATB



1

<b>Part No.</b>	501580	<b>Ref. No.</b>	763001 763090
<b>description</b>	gear motor SKF/ATB type MAX30-C220450A101N0-005 24V L 490mm W 185mm H 120mm		

## pumps





## wash and rinse pumps

## ALBA (C&amp;A)

## pumps



1

<b>Part No.</b>	500090	<b>Ref. No.</b>	046370
<b>description</b>	pump inlet ø 45mm outlet ø 40mm type C5803 230V 50Hz 1 phase 0.55kW 0.75HP L 210mm rotation direction right capacitor 12.5µF ALBA PUMPS (C&A)		
<b>spare parts for</b>	500090		
	<b>Part No.</b>	365014	<b>Ref. No.</b> —
	operating capacitor capacity 12.5µF 450V tolerance 5%Hz ambient temperature max. -25 to +85°C ø 35mm L 70mm M8 plastic connection male faston 6.3mm 45S.C3DS.12.5 protection		
	<b>Part No.</b>	504320	<b>Ref. No.</b> —
	pump cover gasket ID ø 160.75mm thickness 3.53mm EPDM Qty 1 pcs		
	<b>Part No.</b>	509021	<b>Ref. No.</b> —
	impeller ø 102mm H 32mm shaft intake ø 9/8mm rotation direction right		
	<b>Part No.</b>	510692	<b>Ref. No.</b> —
	mechanical shaft seal for shaft ø 11mm slide ring ext. ø 24mm slide ring H 13mm counter ring mounting ø 26mm height counter ring 8mm counter ring int. ø 14mm		
	<b>Part No.</b>	521531	<b>Ref. No.</b> —
	pump cover ALBA PUMPS (C&A) inlet ø 45mm outlet ø 40mm turn direction right ø 153mm ID ø 127mm inner height 24mm		
	<b>Part No.</b>	521709	<b>Ref. No.</b> —
	O-ring EPDM thickness 3mm ID ø 126mm Qty 1 pcs		



**FIR**  
pumps



1

<b>Part No.</b>	500985	<b>Ref. No.</b>	OL0437
<b>description</b>	pump inlet ø 62mm outlet ø 64mm type 4290.2700 220-240/380-415V 50Hz 3 phase 1.5kW 2HP L 350mm rotation direction right FIR installation kit inclusive		

spare parts for 500003

Part No.	510693	Ref. No.	—
----------	--------	----------	---



mechanical shaft seal for shaft ø 12mm slide ring ext. ø 24mm slide ring H 15.5mm slide ring int. ø 11mm counter ring mounting ø 24mm height counter ring 8mm counter ring int. ø 13.5mm

**drain pumps**

**PLASET**







1

<b>Part No.</b>	500206	<b>Ref. No.</b>	047562
<b>description</b>	drain pump with auxiliary pressure connection inlet ø 25mm outlet ø 22mm 230V 90W 50Hz PLASET type 8411		

**OLYMPIA**  
pumps



1

<b>Part No.</b>	500003	<b>Ref. No.</b>	069540
<b>description</b>	pump inlet ø 45mm outlet ø 32mm type T30 230V 50Hz 1 phase 0.29kW 0.39HP L 190mm rotation direction right capacitor 8µF OLYMPIA		
<b>spare parts for</b>	500003		
	Part No.	365013	Ref. No. —
	operating capacitor capacity 8µF 400V tolerance 5%Hz ambient temperature max. -25 to +85°C ø 31.5mm L 55mm M8 plastic connection male faston 6.3mm protection		
	Part No.	510512	Ref. No. —
	pump cover OLYMPIA inlet ø 45mm outlet ø 31mm outlet 2 ø 24 turn direction right ø 130mm ID ø 124mm inner height 20mm		
	Part No.	510554	Ref. No. —
	O-ring EPDM thickness 2mm ID ø 120mm Qty 1 pcs		
	Part No.	510615	Ref. No. —
	impellor ø 90mm H 22mm rotation direction right thread M10L blades 4		

**condensators & interference suppression filters**

**operating capacitors**

**metal**



1

<b>Part No.</b>	365139	<b>Ref. No.</b>	056148
<b>description</b>	operating capacitor capacity 10µF 450V tolerance 5% 60Hz ambient temperature max. -25 up to +70°C ø 40mm L 83mm M8 aluminium connection male faston 6.3mm C.87.8BF2 MKP protection		

**filters**

**interference suppression filters**



1

<b>Part No.</b>	365045	<b>Ref. No.</b>	OK4865
<b>description</b>	interference suppression filter type FC701Y2F 250V 50-60Hz conductor 2 with E connection cable 200mm L 40mm ø 30mm Hmm Wmm plastic Qty 1 pcs		



## fuses

## fine fuses

			
1			
<b>Part No.</b>	358677	<b>Ref. No.</b>	057783
<b>description</b>	fine fuse size ø5x20mm 4A fast-acting rated 250V Qty 10 pcs		

			
1			
<b>Part No.</b>	358695	<b>Ref. No.</b>	005032
<b>description</b>	fine fuse size ø5x20mm 3.15A medium lag rated 250V Qty 10 pcs		

			
1			
<b>Part No.</b>	358703	<b>Ref. No.</b>	002750
<b>description</b>	fine fuse size ø5x20mm 0.4A slow-acting rated 250V Qty 10 pcs		

## various

			
1			
<b>Part No.</b>	358397	<b>Ref. No.</b>	0K5074
<b>description</b>	fuse size 76mm 25A rated 690V Qty 1 pcs		

## overload switches

			
1			
<b>Part No.</b>	358523	<b>Ref. No.</b>	0H6104
<b>description</b>	overload switch drop-away current 0.6A		

## line circuit breakers

## miscellaneous

			
1			
<b>Part No.</b>	380689	<b>Ref. No.</b>	0K3682
<b>description</b>	line circuit breaker		

## electric accessories

## cables

## copper wire

up to 200°C

			
1			
<b>Part No.</b>	550081	<b>Ref. No.</b>	0K3285
<b>description</b>	copper wire 1.5mm <sup>2</sup> permanent temperature -60 up to +200°C conductor nickel-plated copper wire insulation glass fibre braiding/silicone rubber Qty 10m green/yellow t.max. 250°C rated 300/500V test voltage 2000V		

## terminals

## connection terminals with screw/faston connections

			
1			
<b>Part No.</b>	550411	<b>Ref. No.</b>	046347
<b>description</b>	power terminal block 6-pole max. 40A max 450V connection ø6mm <sup>2</sup> / F6.3 temp.-resist. 150°C cross section 6mm <sup>2</sup>		

## gas taps

## PEL

## 21S series





				
1				
<b>Part No.</b>	101897	<b>Ref. No.</b>	0C0205	
<b>description</b>	gas tap PEL type 21S gas inlet pipe flange ø21mm bypass nozzle ø 0.35mm gas outlet M16x1.5 (tube ø 10/8mm) thermocouple connection M8x1 pilot connection M10x1 shaft ø 8x6.5mm shaft L 32/25mm shaft flat upper			
<b>spare parts for</b>	101897			
	<b>Part No.</b>	101060	<b>Ref. No.</b>	—
	magnet unit standard L 39mm D1 ø 15.4mm D2 ø 11mm suitable for PEL20-21/JUNKERS/EGA			
	<b>Part No.</b>	101230	<b>Ref. No.</b>	—
	thermocouple nut T1: M8x1 T2: M18x1 aluminium			
	<b>Part No.</b>	101875	<b>Ref. No.</b>	—
	gas tap front part shaft ø 8x6.5mm shaft L 32/25mm shaft flat upper/lower type PEL21			
	<b>Part No.</b>	528347	<b>Ref. No.</b>	—
	O-ring Viton thickness 1.78mm ID ø 2.9mm Qty 1 pcs			







Table continues overleaf



accessories for		101897	
	Part No.	100908	Ref. No. 052125
	union screw thread M10x1 for pipe ø 4mm Qty 1 pcs		
	Part No.	100909	Ref. No. —
	union screw thread M10x1 for pipe ø 6mm Qty 1 pcs		
	Part No.	101246	Ref. No. —
	olive for pipe ø 4mm Qty 1 pcs		
	Part No.	101278	Ref. No. 060325
	olive for pipe ø 10mm Qty 1 pcs		
	Part No.	101286	Ref. No. —
	olive ID ø 6mm Qty 1 pcs		
	Part No.	101300	Ref. No. —
	union nut thread M16x1.5 tube ø 10mm		
	Part No.	110081	Ref. No. —
	knob ø 70mm shaft ø 8x6.5mm shaft flat universal		
	Part No.	112206	Ref. No. —
	knob dial plate silver gas tap PEL21/22/23 t.max.°C ED ø 63mm ID ø 45.5mm		



Part No.		106060		Ref. No.		OKI367	
<b>description</b>		gas tap PEL type 21S/O gas inlet pipe flange ø21mm bypass nozzle ø 0mm gas outlet M16x1.5 (tube ø 10/8mm) thermocouple connection M8x1 pilot connection M10x1 shaft ø 6x4.6mm shaft L 45/19mm shaft flat upper					
<b>spare parts for</b>		106060					
	Part No.	101060	Ref. No.	—			
	magnet unit standard L 39mm D1 ø 15.4mm D2 ø 11mm suitable for PEL20-21/JUNKERS/EGA						
	Part No.	101230	Ref. No.	—			
	thermocouple nut T1: M8x1 T2: M18x1 aluminium						
	Part No.	101880	Ref. No.	—			
	gasket Viton ED ø 14mm ID ø 9mm thickness 7.7mm Qty 1 pcs						
<b>accessories for</b>		106060					
	Part No.	101278	Ref. No.	060325			
	olive for pipe ø 10mm Qty 1 pcs						
	Part No.	101300	Ref. No.	—			
	union nut thread M16x1.5 tube ø 10mm						

22N/V series			
			
<b>Part No.</b>		106169	
<b>Ref. No.</b>		OG0113	
<b>description</b>			
gas tap PEL type 22N/V gas inlet M20x1.5 (tube ø 12mm) bypass nozzle ø 0.35mm gas outlet M20x1.5 (tube ø 12/10mm) thermocouple connection pilot connection M10x1 shaft ø 6x4.6mm shaft L 45/20mm shaft flat left			
<b>spare parts for</b>			
106169			
	Part No.	100259	Ref. No. —
	bypass nozzle type PEL22 bore ø 0.35mm thread M6x0.5		
	Part No.	101213	Ref. No. —
	gas tap front part shaft ø 6x4.6mm shaft L 45/20mm shaft flat right/left suitable for PEL22		
	Part No.	101241	Ref. No. —
	gas connection thread M20x1.5 tube ø 12/10mm for PEL gas taps vertical		
	Part No.	101460	Ref. No. —
	O-ring ø 12.37mm D1 ø 2.62mm suitable for PEL22		
	Part No.	101461	Ref. No. —
	screw kit suitable for PEL22 Qty 4 pcs		
<b>accessories for</b>			
106169			
	Part No.	100908	Ref. No. 052125
	union screw thread M10x1 for pipe ø 4mm Qty 1 pcs		
	Part No.	100909	Ref. No. —
	union screw thread M10x1 for pipe ø 6mm Qty 1 pcs		
	Part No.	101246	Ref. No. —
	olive for pipe ø 4mm Qty 1 pcs		
	Part No.	101248	Ref. No. 050682
	olive for pipe ø 12mm Qty 1 pcs suitable for PEL		
	Part No.	101249	Ref. No. —
	olive for pipe ø 10mm Qty 1 pcs		
	Part No.	101250	Ref. No. —
	union nut thread M20x1.5 for pipe ø 10mm		
	Part No.	101251	Ref. No. —
	union nut thread M20x1.5 for pipe ø 12mm		
	Part No.	101286	Ref. No. —
	olive ID ø 6mm Qty 1 pcs		



















## 22S/O series

1



Part No.	106022	Ref. No.	OK5756
<b>description</b>	gas tap PEL type 22S/O gas inlet M20x1.5 (tube ø 12mm) bypass nozzle ø 0.35mm gas outlet M20x1.5 (tube ø 12/10mm) thermocouple connection M8x1 pilot connection M10x1 shaft ø 6x4.6mm shaft L 45/20mm shaft flat left		
<b>spare parts for</b>	106022		
	Part No.	101058	Ref. No. 056594
	magnet unit L 39mm D1 ø 15.4mm D2 ø 13.5mm suitable for PEL22/EGA24197 standard		
	Part No.	101213	Ref. No. —
	gas tap front part shaft ø 6x4.6mm shaft L 45/20mm shaft flat right/left suitable for PEL22		
	Part No.	101230	Ref. No. —
	thermocouple nut T1: M8x1 T2: M18x1 aluminium		
	Part No.	101240	Ref. No. —
	gas connection thread M20x1.5 tube ø 12/10mm for PEL gas taps with gasket and screws horizontal		
	Part No.	101460	Ref. No. —
	O-ring ø 12.37mm D1 ø 2.62mm suitable for PEL22		
	Part No.	101461	Ref. No. —
	screw kit suitable for PEL22 Qty 4 pcs		
<b>accessories for</b>	106022		
	Part No.	100908	Ref. No. 052125
	union screw thread M10x1 for pipe ø 4mm Qty 1 pcs		
	Part No.	100909	Ref. No. —
	union screw thread M10x1 for pipe ø 6mm Qty 1 pcs		
	Part No.	101241	Ref. No. —
	gas connection thread M20x1.5 tube ø 12/10mm for PEL gas taps vertical		
	Part No.	101246	Ref. No. —
	olive for pipe ø 4mm Qty 1 pcs		
	Part No.	101248	Ref. No. 050682
	olive for pipe ø 12mm Qty 1 pcs suitable for PEL		
	Part No.	101249	Ref. No. —
	olive for pipe ø 10mm Qty 1 pcs		
	Part No.	101250	Ref. No. —
	union nut thread M20x1.5 for pipe ø 10mm		
	Part No.	101251	Ref. No. —
	union nut thread M20x1.5 for pipe ø 12mm		
	Part No.	101286	Ref. No. —
	olive ID ø 6mm Qty 1 pcs		

1



Part No.	106023	Ref. No.	OK5619
<b>description</b>	gas tap PEL type 22S/O gas inlet M20x1.5 (tube ø 12mm) bypass nozzle ø 0mm gas outlet M20x1.5 (tube ø 12/10mm) thermocouple connection M8x1 pilot connection M10x1 shaft ø 6x4.6mm shaft L 29/19.5mm shaft flat lower		
<b>spare parts for</b>	106023		
	Part No.	101058	Ref. No. 056594
	magnet unit L 39mm D1 ø 15.4mm D2 ø 13.5mm suitable for PEL22/EGA24197 standard		
	Part No.	101230	Ref. No. —
	thermocouple nut T1: M8x1 T2: M18x1 aluminium		
	Part No.	101240	Ref. No. —
	gas connection thread M20x1.5 tube ø 12/10mm for PEL gas taps with gasket and screws horizontal		
	Part No.	101460	Ref. No. —
	O-ring ø 12.37mm D1 ø 2.62mm suitable for PEL22		
	Part No.	101461	Ref. No. —
	screw kit suitable for PEL22 Qty 4 pcs		
	Part No.	106154	Ref. No. —
	gas tap front part shaft ø 6x4.6mm shaft L 29/19.5mm shaft flat upper/lower suitable for PEL22		
<b>accessories for</b>	106023		
	Part No.	100908	Ref. No. 052125
	union screw thread M10x1 for pipe ø 4mm Qty 1 pcs		
	Part No.	100909	Ref. No. —
	union screw thread M10x1 for pipe ø 6mm Qty 1 pcs		
	Part No.	101246	Ref. No. —
	olive for pipe ø 4mm Qty 1 pcs		
	Part No.	101248	Ref. No. 050682
	olive for pipe ø 12mm Qty 1 pcs suitable for PEL		
	Part No.	101249	Ref. No. —
	olive for pipe ø 10mm Qty 1 pcs		
	Part No.	101250	Ref. No. —
	union nut thread M20x1.5 for pipe ø 10mm		
	Part No.	101251	Ref. No. —
	union nut thread M20x1.5 for pipe ø 12mm		
	Part No.	101286	Ref. No. —
	olive ID ø 6mm Qty 1 pcs		
	Part No.	110080	Ref. No. —
	knob ø 70mm shaft ø 10x8mm shaft flat universal		

Table continues overleaf



accessories for 106023			
	Part No.	112206	Ref. No. —
knob dial plate silver gas tap PEL21/22/23 t.max.°C ED ø 63mm ID ø 45.5mm			



## gas thermostats

### SIT

#### 710 Minisit series



<b>Part No.</b>	106061	<b>Ref. No.</b>	OK5692
<b>description</b>	gas thermostat SIT type MINISIT 710 t.max. 340°C 100-340°C		
<b>spare parts for</b>	106061		
	Part No.	100809	Ref. No. —
O-ring EPDM thickness 2mm ID ø 21mm Qty 1 pcs			
	Part No.	101053	Ref. No. —
magnet unit T1: M9x1 T2: M24x1 L 45mm ø 17mm suitable for Minisit			
	Part No.	101136	Ref. No. 054269
piezoelectric igniter suitable for Minisit with cover cap ømm connection F6.3x0.8			
	Part No.	101269	Ref. No. —
gas connection thread 1/2" angled with O-ring MINISIT 710			
	Part No.	101516	Ref. No. —
flat-headed bolt thread M4 thread L 16mm SS DIN 7985/ISO 7045 Qty 1 pcs			
	Part No.	101517	Ref. No. —
flat-headed bolt thread M4 thread L 23mm			
	Part No.	102107	Ref. No. —
probe 100-340°C probe ø 4mm probe L 72mm capillary pipe 1050mm t.max. 340°C oven/grill probe type type C1 suitable for MINISIT 710			
	Part No.	107564	Ref. No. —
piezoelectric igniter body plastic blowing connection F6.3x0.8 ø 22mm			
	Part No.	110068	Ref. No. 054268
knob suitable for Minisit ø 37mm			
<b>accessories for</b> 106061			
	Part No.	101273	Ref. No. —
olive for pipe ø 12mm L 9.5mm brass Qty 1 pcs suitable for universal			
	Part No.	101274	Ref. No. —
olive for pipe ø 16mm Qty 1 pcs			
	Part No.	101275	Ref. No. —
union screw thread 1/2" for pipe ø 16mm Qty 1 pcs			

accessories for 106061			
	Part No.	101276	Ref. No. —
union screw thread 3/8" tube ø 12mm Qty 1 pcs			
	Part No.	101278	Ref. No. 060325
olive for pipe ø 10mm Qty 1 pcs			
	Part No.	101279	Ref. No. —
union screw thread 3/8" for pipe ø 10mm Qty 1 pcs			

## gas valves and ignition boxes

### gas control valves

#### SIT

#### ELETTROSIT



1







<b>Part No.</b>	101127	<b>Ref. No.</b>	057543
<b>description</b>	gas valve SIT type ELETTROSIT 230V gas inlet 3/4" gas outlet 3/4" thermocouple connection M9x1 pilot connection M10x1 lateral equiv. no. 0.810.175		
<b>spare parts for</b>	101127		
	Part No.	101312	Ref. No. —
microswitch			
	Part No.	101352	Ref. No. —
solenoid coil 230V 50Hz suitable for ELETTROSIT			
<b>accessories for</b> 101127			
	Part No.	100006	Ref. No. —
piezoelectric igniter suitable for ELETTROSIT body plastic blowing connection ø2.4mm ø 14mm			
	Part No.	100904	Ref. No. —
locking screw M10x1 for pipe ø 4mm Qty 1 pcs			
	Part No.	100905	Ref. No. —
locking screw M10x1 for pipe ø 6mm Qty 1 pcs			
	Part No.	101301	Ref. No. —
gas connection thread 1/2" straight ELETTROSIT screw with O-ring			
	Part No.	101303	Ref. No. —
gas connection straight thread 3/4" ELETTROSIT			
	Part No.	101309	Ref. No. —
extension			





NOVASIT



1			
<b>Part No.</b>	101187	<b>Ref. No.</b>	002606
<b>description</b>	gas valve SIT series Novasit 820 0.17VHz gas inlet 1/2" gas outlet 1/2" thermocouple connection M9x1 pilot connection M10x1 ignition pressurebar pressure range 5-50mbar pressure regulator connection blind equiv. no. 0.820.301 supply Operator millivolt		
<b>spare parts for</b>	101187		
	<b>Part No.</b>	101065	<b>Ref. No.</b> —
	magnet unit with cable L 44mm D1 ø 30mm D2 ø 20mm suitable for NOVASIT		
<b>accessories for</b>	101187		
	<b>Part No.</b>	100110	<b>Ref. No.</b> —
	pilot burner SIT type 190 series 3 flames nozzle 6mm gas connectionmm		
	<b>Part No.</b>	101305	<b>Ref. No.</b> —
	gas connection straight 1/2" flange 45x45mm ELETTROSIT/V4400/4600/4605 suitable for SIT/HONEYWELL hole distance 36x36mm		
	<b>Part No.</b>	101306	<b>Ref. No.</b> —
	gas connection angled flange 45x45mm hole distance 36x36mm 1/2" ELETTROSIT/V4400/4600/4605 screw with O-ring suitable for SIT/HONEYWELL		
	<b>Part No.</b>	101307	<b>Ref. No.</b> —
	gas connection straight flange 45x45mm hole distance 36x36mm 3/4" ELETTROSIT/V4400/4600/4605 screw with O-ring suitable for SIT/HONEYWELL		
	<b>Part No.</b>	101308	<b>Ref. No.</b> —
	gas connection angled flange 45x45mm hole distance 36x36mm 3/4" ELETTROSIT/V4400/4600/4605 screw with O-ring suitable for SIT/HONEYWELL		
	<b>Part No.</b>	102116	<b>Ref. No.</b> 002607
	thermopile ROBERTSHAW L 900mm probe ø 9mm probe L 57mm 250-750mV screw connection 7/16"		







accessories



1			
<b>Part No.</b>	101928	<b>Ref. No.</b>	059305
<b>description</b>	knob adapter shaft ø 10x8mm shaft L 18mm catch upper suitable for ZANUSSI shaft flat upper		

TANDEM



1			
<b>Part No.</b>	106219	<b>Ref. No.</b>	OK5838
<b>description</b>	gas valve 230V 50Hz gas inlet 1/2" gas outlet 1/2" pilot connection M10x1 level slow ignition standard ignition time 3-7s Tandem equiv. no. 0.830.020		
<b>spare parts for</b>	106219		
	<b>Part No.</b>	101379	<b>Ref. No.</b> —
	solenoid coil 230V 50Hz suitable for Tandem		
<b>accessories for</b>	106219		
	<b>Part No.</b>	101274	<b>Ref. No.</b> —
	olive for pipe ø 16mm Qty 1 pcs		
	<b>Part No.</b>	101275	<b>Ref. No.</b> —
	union screw thread 1/2" for pipe ø 16mm Qty 1 pcs		
	<b>Part No.</b>	101925	<b>Ref. No.</b> —
	plug with O-ring thread M10x1 for pilot burner suitable for NOVASIT		
	<b>Part No.</b>	101936	<b>Ref. No.</b> —
	gasket with screw Tandem		
	<b>Part No.</b>	102845	<b>Ref. No.</b> —
	gas connection angled 1/2" flange 32x32mm hole distance 24x24mm Tandem		
	<b>Part No.</b>	102846	<b>Ref. No.</b> —
	gas connection straight 1/2" flange 32x32mm hole distance 24x24mm suitable for Tandem		

ignition parts

pilot burners

SIT

100 series





















1			
<b>Part No.</b>	106902	<b>Ref. No.</b>	029776
<b>description</b>	pilot burner SIT type 100 series 2 flames nozzle ø 0.2mm gas connection 6mm		
<b>spare parts for</b>	106902		
	<b>Part No.</b>	100245	<b>Ref. No.</b> 056799
	pilot burner nozzle LPG code 20 bore ø 0.2mm Qty 1 pcs thread M8x0.75		

Table continues overleaf



spare parts for		106902	
	Part No.	100842	Ref. No. —
pilot burner cap 2 flames Qty 1 pcs			
	Part No.	100885	Ref. No. —
air mixing sleeve for pilot burner Qty 1 pcs			
	Part No.	100916	Ref. No. —
compression spring for pilot burner Qty 1 pcs			
	Part No.	100917	Ref. No. —
gasket for pilot burner Qty 1 pcs aluminium			
	Part No.	100918	Ref. No. —
screw for pilot burner			
	Part No.	107161	Ref. No. —
pilot burner cap SIT 2 flames Hmm Lmm Qty 1 pcs			
	Part No.	107701	Ref. No. —
pilot burner bottom part SIT 100 series nozzle $\varnothing$ 0.2mm			
accessories for		106902	
	Part No.	100246	Ref. No. 056656
pilot burner nozzle natural gas bore $\varnothing$ 0.35mm Qty 1 pcs thread M8x0.75			
	Part No.	100904	Ref. No. —
locking screw M10x1 for pipe $\varnothing$ 4mm Qty 1 pcs			
	Part No.	100905	Ref. No. —
locking screw M10x1 for pipe $\varnothing$ 6mm Qty 1 pcs			
	Part No.	102110	Ref. No. —
pilot tube copper pipe $\varnothing$ 4mm thickness 1mm L 3000mm			
	Part No.	102111	Ref. No. —
pilot tube copper pipe $\varnothing$ 6mm thickness 1mm L 3000mm			
	Part No.	107171	Ref. No. —
pilot burner nozzle SIT natural/liquid gas bore $\varnothing$ 0.25mm Qty 1 pcs			
	Part No.	107700	Ref. No. —
pilot burner bottom part SIT 100 series nozzle $\varnothing$ 0.25mm			
	Part No.	107702	Ref. No. —
pilot burner bottom part SIT 100 series nozzle $\varnothing$ 0.35mm			

spare parts for		106907	
	Part No.	100855	Ref. No. —
pilot burner bracket triple			
	Part No.	100885	Ref. No. —
air mixing sleeve for pilot burner Qty 1 pcs			
	Part No.	100916	Ref. No. —
compression spring for pilot burner Qty 1 pcs			
	Part No.	100917	Ref. No. —
gasket for pilot burner Qty 1 pcs aluminium			
	Part No.	100918	Ref. No. —
screw for pilot burner			
	Part No.	107162	Ref. No. —
pilot burner cap SIT 3 flames Hmm Lmm Qty 1 pcs			
	Part No.	107702	Ref. No. —
pilot burner bottom part SIT 100 series nozzle $\varnothing$ 0.35mm			
accessories for		106907	
	Part No.	100245	Ref. No. 056799
pilot burner nozzle LPG code 20 bore $\varnothing$ 0.2mm Qty 1 pcs thread M8x0.75			
	Part No.	100904	Ref. No. —
locking screw M10x1 for pipe $\varnothing$ 4mm Qty 1 pcs			
	Part No.	100905	Ref. No. —
locking screw M10x1 for pipe $\varnothing$ 6mm Qty 1 pcs			
	Part No.	102110	Ref. No. —
pilot tube copper pipe $\varnothing$ 4mm thickness 1mm L 3000mm			
	Part No.	102111	Ref. No. —
pilot tube copper pipe $\varnothing$ 6mm thickness 1mm L 3000mm			
	Part No.	107171	Ref. No. —
pilot burner nozzle SIT natural/liquid gas bore $\varnothing$ 0.25mm Qty 1 pcs			
	Part No.	107700	Ref. No. —
pilot burner bottom part SIT 100 series nozzle $\varnothing$ 0.25mm			
	Part No.	107701	Ref. No. —
pilot burner bottom part SIT 100 series nozzle $\varnothing$ 0.2mm			

			
1			
<b>Part No.</b>	106907	<b>Ref. No.</b>	058329
<b>description</b>	pilot burner SIT type 100 series 3 flames nozzle $\varnothing$ 0.35mm gas connection 6mm		
spare parts for		106907	
	Part No.	100246	Ref. No. 056656
pilot burner nozzle natural gas bore $\varnothing$ 0.35mm Qty 1 pcs thread M8x0.75			



accessories

pilot burner brackets

universal



<b>Part No.</b>	100854	<b>Ref. No.</b>	052256
<b>description</b>	pilot burner bracket double		

pilot burner nozzles



<b>Part No.</b>	100245	<b>Ref. No.</b>	056799
<b>description</b>	pilot burner nozzle LPG code 20 bore $\varnothing$ 0.2mm Qty 1 pcs thread M8x0.75		



<b>Part No.</b>	100246	<b>Ref. No.</b>	056656
<b>description</b>	pilot burner nozzle natural gas bore $\varnothing$ 0.35mm Qty 1 pcs thread M8x0.75		

ignition electrodes



<b>Part No.</b>	100706	<b>Ref. No.</b>	056754
<b>description</b>	ignition electrode connection M4 Qty 1 pcs		

140 - 145 -150 series



<b>Part No.</b>	100094	<b>Ref. No.</b>	059214
<b>description</b>	pilot burner SIT type 140 series 1 flame nozzle $\varnothing$ mm gas connectionmm for thermocouple $\varnothing$ 5mm		

accessories for 100094

	<b>Part No.</b>	100182	<b>Ref. No.</b>	003547
	cover for pilot burner Qty 1 pcs			
	<b>Part No.</b>	100204	<b>Ref. No.</b>	—
	pilot burner nozzle SIT LPG code 14 bore $\varnothing$ 0.18/0.20mm Qty 1 pcs suitable for 140 series			
	<b>Part No.</b>	100205	<b>Ref. No.</b>	—
	pilot burner nozzle SIT LPG code 19 bore $\varnothing$ 0.23/0.26mm Qty 1 pcs suitable for SIT 150 series			

accessories for 100094

	<b>Part No.</b>	100206	<b>Ref. No.</b>	—
	pilot burner nozzle SIT natural gas code 36 bore $\varnothing$ 0.60/0.55mm Qty 1 pcs suitable for SIT 150 series			
	<b>Part No.</b>	100207	<b>Ref. No.</b>	—
	pilot burner nozzle SIT natural gas code 27 bore $\varnothing$ 0.40/0.38mm suitable for SIT 140 series			
	<b>Part No.</b>	100216	<b>Ref. No.</b>	—
	pilot burner nozzle SIT natural gas code 38 bore $\varnothing$ 0.45mm Qty 1 pcs suitable for SIT 150 series			
	<b>Part No.</b>	100897	<b>Ref. No.</b>	059161
	olive for pipe $\varnothing$ 4mm Qty 1 pcs for pilot burner			
	<b>Part No.</b>	100898	<b>Ref. No.</b>	—
	olive for pipe $\varnothing$ 6mm Qty 1 pcs for pilot burner			
	<b>Part No.</b>	100908	<b>Ref. No.</b>	052125
	union screw thread M10x1 for pipe $\varnothing$ 4mm Qty 1 pcs			
	<b>Part No.</b>	100909	<b>Ref. No.</b>	—
	union screw thread M10x1 for pipe $\varnothing$ 6mm Qty 1 pcs			
	<b>Part No.</b>	102110	<b>Ref. No.</b>	—
	pilot tube copper pipe $\varnothing$ 4mm thickness 1mm L 3000mm			
	<b>Part No.</b>	102111	<b>Ref. No.</b>	—
	pilot tube copper pipe $\varnothing$ 6mm thickness 1mm L 3000mm			

JUNKERS

CB 503 series

pilot burners



<b>Part No.</b>	100058	<b>Ref. No.</b>	0K0205
-----------------	--------	-----------------	--------

<b>description</b>	pilot burner JUNKERS type CB503006 natural gas nozzle no.26 gas connection 4mm		
--------------------	--	--	--

spare parts for 100058

	<b>Part No.</b>	100224	<b>Ref. No.</b>	—
	pilot burner nozzle natural gas gas pressure 25mbar code 26 Qty 1 pcs suitable for JUNKERS CB503_			
	<b>Part No.</b>	101281	<b>Ref. No.</b>	—
	olive for pipe $\varnothing$ 4mm L 8.7mm Qty 1 pcs suitable for CB 502/503			
	<b>Part No.</b>	101283	<b>Ref. No.</b>	—
	union screw thread M10x1 for pipe $\varnothing$ 4mm Qty 1 pcs			



accessories for 100058

	<b>Part No.</b>	100220	<b>Ref. No.</b>	0K1176
	pilot burner nozzle LPG gas pressure 50mbar code 2 Qty 1 pcs suitable for JUNKERS CB503_			
	<b>Part No.</b>	100221	<b>Ref. No.</b>	—
	pilot burner nozzle LPG gas pressure 30mbar code 29 Qty 1 pcs suitable for JUNKERS CB50203_			

Table continues overleaf



accessories for		100058	
	Part No.	100222	Ref. No. 0K1126
	pilot burner nozzle LPG gas pressure 50mbar code 5 Qty 1 pcs suitable for JUNKERS CB50203_		
	Part No.	100223	Ref. No. —
	pilot burner nozzle natural gas gas pressure 20mbar code 3 Qty 1 pcs suitable for JUNKERS CB50203_		
	Part No.	100226	Ref. No. —
	pilot burner nozzle LPG gas pressure 50mbar code 15 suitable for JUNKERS		
	Part No.	100227	Ref. No. —
	pilot burner nozzle natural gas gas pressure 25mbar code 6 Qty 1 pcs suitable for JUNKERS CB50203_		
	Part No.	100228	Ref. No. —
	pilot burner nozzle town gas gas pressure 8mbar code 4 Qty 1 pcs suitable for JUNKERS CB50203_		
	Part No.	100909	Ref. No. —
	union screw thread M10x1 for pipe ø 6mm Qty 1 pcs		
	Part No.	101287	Ref. No. —
	olive for pipe ø 6mm Qty 1 pcs		
	Part No.	102110	Ref. No. —
	pilot tube copper pipe ø 4mm thickness 1mm L 3000mm		
	Part No.	102111	Ref. No. —
	pilot tube copper pipe ø 6mm thickness 1mm L 3000mm		

spare parts for		100093	
	Part No.	100908	Ref. No. 052125
	union screw thread M10x1 for pipe ø 4mm Qty 1 pcs		
accessories for		100093	
	Part No.	100204	Ref. No. —
	pilot burner nozzle SIT LPG code 14 bore ø 0.18/0.20mm Qty 1 pcs suitable for 140 series		
	Part No.	100205	Ref. No. —
	pilot burner nozzle SIT LPG code 19 bore ø 0.23/0.26mm Qty 1 pcs suitable for SIT 150 series		
	Part No.	100206	Ref. No. —
	pilot burner nozzle SIT natural gas code 36 bore ø 0.60/0.55mm Qty 1 pcs suitable for SIT 150 series		
	Part No.	100207	Ref. No. —
	pilot burner nozzle SIT natural gas code 27 bore ø 0.40/0.38mm suitable for SIT 140 series		
	Part No.	100803	Ref. No. —
	gasket for pilot burner Qty 1 pcs		
	Part No.	100898	Ref. No. —
	olive for pipe ø 6mm Qty 1 pcs for pilot burner		
	Part No.	100909	Ref. No. —
	union screw thread M10x1 for pipe ø 6mm Qty 1 pcs		
	Part No.	102110	Ref. No. —
	pilot tube copper pipe ø 4mm thickness 1mm L 3000mm		
	Part No.	102111	Ref. No. —
	pilot tube copper pipe ø 6mm thickness 1mm L 3000mm		





**PRO-GAS**

140 - 145 -150 series

pilot burners



1

Part No.	100093	Ref. No.	0H6311
description	pilot burner type 150 series 1 flame with accessories		
spare parts for		100093	
	Part No.	100216	Ref. No. —
	pilot burner nozzle SIT natural gas code 38 bore ø 0.45mm Qty 1 pcs suitable for SIT 150 series		
	Part No.	100701	Ref. No. 059380
	ignition electrode connection M4 Qty 1 pcs		
	Part No.	100897	Ref. No. 059161
	olive for pipe ø 4mm Qty 1 pcs for pilot burner		
	Part No.	100906	Ref. No. 057960
	screw connection thread M10x1 for ignition electrode brass Qty 1 pcs WS 10		
	Part No.	100907	Ref. No. —
	screw connection thread M10x1 Qty 1 pcs type SEF 1 ømm for thermocouple		

**producer-specific pilot burners**

THERMA

Thermaline S90 series (version 1)



1

Part No.	102956	Ref. No.	-
description	pilot burner type C without nozzle		



1

Part No.	102957	Ref. No.	-
description	pilot burner type D without nozzle		







1

<b>Part No.</b>	102958	<b>Ref. No.</b>	-
<b>description</b>	pilot burner type E without nozzle		

Thermaline S90 series (version 2)



1

<b>Part No.</b>	101856	<b>Ref. No.</b>	0G3101	
<b>description</b>	pilot burner with nozzles			
<b>spare parts for</b>	101856			
	<b>Part No.</b>	100900	<b>Ref. No.</b>	—
	air mixing sleeve for pilot burner Qty 1 pcs			
	<b>Part No.</b>	100979	<b>Ref. No.</b>	—
	pilot burner nozzle LPG bore $\varnothing$ 0.25mm code 25 gas pressure 30mbar thread M5x0.8			
	<b>Part No.</b>	101534	<b>Ref. No.</b>	0G2372
	pilot burner nozzle LPG bore $\varnothing$ 0.19mm code 19 gas pressure 50mbar thread M5x0.8 suitable for THERMA/ELECTROLUX			
	<b>Part No.</b>	101543	<b>Ref. No.</b>	0K1185
	pilot burner nozzle natural gas bore $\varnothing$ 0.3mm code 30 gas pressure 20mbar thread M5x0.8			
	<b>Part No.</b>	101583	<b>Ref. No.</b>	—
	pilot burner head slit width 0.8mm bore $\varnothing$ 3mm $\varnothing$ 6mm M7x0.75mm total length 22mm WS 8 nickel-plated brass			
	<b>Part No.</b>	101587	<b>Ref. No.</b>	—
	gasket for pilot burner without ignition electrode			

Thermaline 800 / 900 series



1

<b>Part No.</b>	102916	<b>Ref. No.</b>	0K5767
<b>description</b>	cap for pilot burner		



1

<b>Part No.</b>	102917	<b>Ref. No.</b>	0K5768
<b>description</b>	cap for pilot burner		



1

<b>Part No.</b>	106247	<b>Ref. No.</b>	0K5715
<b>description</b>	double nipple T1: M10x1 T2: M10x1		

miscellaneous



1

<b>Part No.</b>	101937	<b>Ref. No.</b>	0G2965
<b>description</b>	pilot burner		

electrodes



1

<b>Part No.</b>	102965	<b>Ref. No.</b>	0K1351
<b>description</b>	ignition electrode connection F 2.8x0.8mm		





<b>Part No.</b>	100701	<b>Ref. No.</b>	059380
<b>description</b>	ignition electrode connection M4 Qty 1 pcs		
<b>accessories for</b>	100701		
	<b>Part No.</b>	100906	<b>Ref. No.</b> 057960
	screw connection thread M10x1 for ignition electrode brass Qty 1 pcs WS 10		

<b>Part No.</b>	100706	<b>Ref. No.</b>	056754
<b>description</b>	ignition electrode connection M4 Qty 1 pcs		

<b>Part No.</b>	101779	<b>Ref. No.</b>	N/A
<b>description</b>	ignition electrode D1 ø 7mm D2 ø 9mm connection M4 L1 10mm L2 5mm BL1 18mm BL2 3mm BL3 23mm to clip		

<b>Part No.</b>	102170	<b>Ref. No.</b>	0A5169
<b>description</b>	ignition electrode flange length 24mm flange width 17mm D1 ø 10mm fixing dimensions ø4.5mm with flange		

<b>Part No.</b>	102169	<b>Ref. No.</b>	003556
<b>description</b>	ignition electrode flange length 24mm flange width 17mm D1 ø 9.5mm L1 45mm L2 30mm L4 18mm L3 17mm BL1 30mm BL2 28mm fixing dimensions ø4.5mm with flange connection ø 6mm		

<b>Part No.</b>	100906	<b>Ref. No.</b>	057960
<b>description</b>	screw connection thread M10x1 for ignition electrode brass Qty 1 pcs WS 10		

ignition cables

pre-assembled cables

<b>Part No.</b>	100026	<b>Ref. No.</b>	054273
<b>description</b>	ignition cable cable length 1000mm connection ø4mm / F6.3mm		

piezoelectric igniters

miscellaneous

<b>Part No.</b>	nla <sup>1</sup>	<b>Ref. No.</b>	0K5693
<b>description</b>	piezoelectric igniter body metal connection F6.3x0.8 3 hole fixing ø 22mm		

<sup>1</sup>no longer available

1

<b>Part No.</b>	nla <sup>1</sup>	<b>Ref. No.</b>	002057
<b>description</b>	piezoelectric igniter suitable for Minisit connection F6.3x0.8 ømm		

<sup>1</sup>no longer available



1

<b>Part No.</b>	nla <sup>1</sup>	<b>Ref. No.</b>	054269
<b>description</b>	piezoelectric igniter suitable for Minisit with cover cap ømm connection F6.3x0.8		
<b>spare parts for</b>	101136		
	<b>Part No.</b>	100001	<b>Ref. No.</b> 002057
	piezoelectric igniter suitable for Minisit connection F6.3x0.8 ømm		

<sup>1</sup>no longer available

## ignition switches



1

<b>Part No.</b>	301014	<b>Ref. No.</b>	0K6805
<b>description</b>	momentary rocker switch mounting measurements 30x11mm black 1NO 250V 16A connection male faston 6.3mm ambient temperature max. 85/125°C protection IP40 mounting ømm male faston 6.3mm		

## thermocouples

### plug-in thermocouples

#### plug-in thermocouples standard

##### with barrel socket ø5mm - type Junkers with aluminised tip





1

<b>Part No.</b>	102202	<b>Ref. No.</b>	0K1368
<b>description</b>	thermocouple M8x1 L 320mm plug connection ø5.0mm		
<b>accessories for</b>	102202		
	<b>Part No.</b>	101260	<b>Ref. No.</b> —
	thermocouple fitting thread M8x1 Qty 1 pcs		



1

<b>Part No.</b>	102205	<b>Ref. No.</b>	058332
<b>description</b>	thermocouple M8x1 L 750mm plug connection ø5.0mm		
<b>accessories for</b>	102205		
	<b>Part No.</b>	101260	<b>Ref. No.</b> —
	thermocouple fitting thread M8x1 Qty 1 pcs		



1

<b>Part No.</b>	102294	<b>Ref. No.</b>	0K1369
<b>description</b>	thermocouple M8x1 L 750mm plug connection ø5.0mm		

### with barrel socket ø6(6.5)mm

#### thermocouples SIT

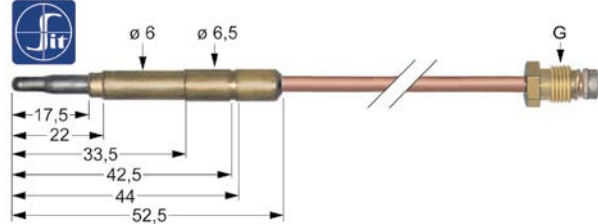

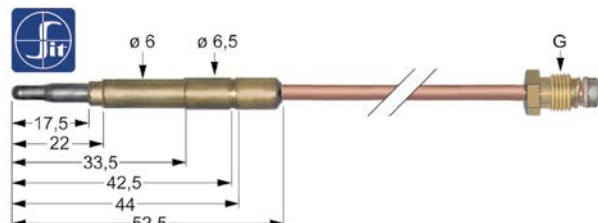

1

<b>Part No.</b>	107601	<b>Ref. No.</b>	0G1120
<b>description</b>	thermocouple SIT M8x1 L 600mm plug connection ø6.0(6.5)mm		



1

<b>Part No.</b>	107602	<b>Ref. No.</b>	0C0202
<b>description</b>	thermocouple SIT M8x1 L 850mm plug connection ø6.0(6.5)mm		
<b>accessories for</b>	107602		
	<b>Part No.</b>	100920	<b>Ref. No.</b> —
	thermocouple fitting thread M8x1 / M9x1 Qty 1 pcs		
	<b>Part No.</b>	100922	<b>Ref. No.</b> —
	thermocouple fitting thread M10x1 / ASA 11/32 Qty 1 pcs		



<b>Part No.</b>	107613	<b>Ref. No.</b>	OK3464
<b>description</b>	thermocouple SIT M9x1 L 1200mm plug connection ø6.0(6.5)mm		

plug-in thermocouples with interruption

<b>Part No.</b>	107863	<b>Ref. No.</b>	OC3162
<b>description</b>	thermocouple SIT with interrupter M9x1 L 1000mm plug connection ø6.0(6.5)mm cable 820mm		

threaded thermocouples  
threaded thermocouples standard  
with socket with thread M8x1  
SIT

<b>Part No.</b>	107630	<b>Ref. No.</b>	19012635	
<b>description</b>	thermocouple SIT M8x1 L 600mm M8x1			
<b>accessories for</b>	107630			
	<b>Part No.</b>	102067	<b>Ref. No.</b>	—
	nut thread M8x1 H 3mm brass Qty 1 pcs type SEF 1			

thermopiles

<b>Part No.</b>	102116	<b>Ref. No.</b>	002607
<b>description</b>	thermopile ROBERTSHAW L 900mm probe ø 9mm probe L 57mm 250-750mV screw connection 7/16"		

accessories

screws

<b>Part No.</b>	106246	<b>Ref. No.</b>	OK5713
<b>description</b>	screw thread M8x1 IT / M12x1 ET for thermocouple		

miscellaneous

<b>Part No.</b>	106245	<b>Ref. No.</b>	OK5775
<b>description</b>	sleeve for thermocouple thread M12x1		

gas burners

hob burners

producer-specific hob burners

THERMA  
Thermaline S90 series

<b>Part No.</b>	104540	<b>Ref. No.</b>	17012726
<b>description</b>	burner cap C ø 83mm 3.5kW		

<b>Part No.</b>	104460	<b>Ref. No.</b>	17012727
<b>description</b>	burner cap D ø 94mm 5kW with central hole		

<b>Part No.</b>	104542	<b>Ref. No.</b>	17012728	
<b>description</b>	burner cap E ø 114mm mounting ø 105mm ID ø 45mm 7kW with central hole bore ø 3mm			
<b>accessories for</b>	104542			
	<b>Part No.</b>	104507	<b>Ref. No.</b>	17012725
	burner head E for burner cap ø 115mm			





			
1			
<b>Part No.</b>	104500	<b>Ref. No.</b>	17012723
<b>description</b>	burner head C for burner cap ø 85mm		

			
1			
<b>Part No.</b>	104505	<b>Ref. No.</b>	17012724
<b>description</b>	burner head D for burner cap ø 95mm		

			
1			
<b>Part No.</b>	104507	<b>Ref. No.</b>	17012725
<b>description</b>	burner head E for burner cap ø 115mm		

			
1			
<b>Part No.</b>	104707	<b>Ref. No.</b>	17012729
<b>description</b>	burner lower part C complete		

			
1			
<b>Part No.</b>	104708	<b>Ref. No.</b>	17012730
<b>description</b>	burner lower part D complete		

			
1			
<b>Part No.</b>	104709	<b>Ref. No.</b>	17012731
<b>description</b>	burner lower part E complete		

			
1			
<b>Part No.</b>	104511	<b>Ref. No.</b>	17012722
<b>description</b>	gasket ø 72mm ID ø 45mm for burner head H 1.2mm perforation ø 5mm		

			
1			
<b>Part No.</b>	104522	<b>Ref. No.</b>	17012721
<b>description</b>	nozzle holder ID ø 10mm ET M17x1		

## Thermaline 800/900, Starline series

			
1			
<b>Part No.</b>	106248	<b>Ref. No.</b>	19012588
<b>description</b>	air mixing tube ID ø 15mm		

			
1			
<b>Part No.</b>	106249	<b>Ref. No.</b>	19012587
<b>description</b>	air mixing tube ID ø 17mm		

			
1			
<b>Part No.</b>	104744	<b>Ref. No.</b>	19012600
<b>description</b>	burner cap 3.5kW ø 53mm		

			
1			
<b>Part No.</b>	104746	<b>Ref. No.</b>	19012601
<b>description</b>	burner cap 5.6kW ø 78mm		

			
1			
<b>Part No.</b>	104748	<b>Ref. No.</b>	19012602
<b>description</b>	burner cap 8.4kW ø 103mm		

			
1			
<b>Part No.</b>	105990	<b>Ref. No.</b>	19012941
<b>description</b>	burner cap ø 103mm 7kW with central hole mounting pos. outer		





			
1			
<b>Part No.</b>	105988	<b>Ref. No.</b>	19012942
<b>description</b>	burner cap ø 40mm 7kW mounting pos. inner		

			
1			
<b>Part No.</b>	104750	<b>Ref. No.</b>	19012925
<b>description</b>	burner head 3.5kW for burner cap ø 53mm KBF suitable for simmering plate		

			
1			
<b>Part No.</b>	104759	<b>Ref. No.</b>	0G1905
<b>description</b>	burner head 3.5kW for burner cap ø 53mm simmering plate		

			
1			
<b>Part No.</b>	104747	<b>Ref. No.</b>	0K5682
<b>description</b>	burner head 5.6kW for burner cap ø 78mm		

			
1			
<b>Part No.</b>	104751	<b>Ref. No.</b>	19012619
<b>description</b>	burner head 5.6kW for burner cap ø 78mm		

			
1			
<b>Part No.</b>	104769	<b>Ref. No.</b>	19013008
<b>description</b>	burner head 5.6kW for burner cap ø 78mm grill/giddle plate		

			
1			
<b>Part No.</b>	104749	<b>Ref. No.</b>	19012612
<b>description</b>	burner head 8.4kW for burner cap ø 103mm		

			
1			
<b>Part No.</b>	105989	<b>Ref. No.</b>	19012946
<b>description</b>	burner head for burner cap ø 40/103mm 7kW		

			
1			
<b>Part No.</b>	104745	<b>Ref. No.</b>	0K5681
<b>description</b>	burner head suitable for burner 3.7kW		

			
1			
<b>Part No.</b>	104753	<b>Ref. No.</b>	19012711
<b>description</b>	nozzle holder		

bar burners

bar burners

			
1			
<b>Part No.</b>	104581	<b>Ref. No.</b>	006650
<b>description</b>	bar burner 2 row L 550mm W 190mm ømm H 50mm griddle		

			
1			
<b>Part No.</b>	104580	<b>Ref. No.</b>	0A5124
<b>description</b>	bar burner 3 row L 645mm W 190mm ømm H 45mm griddle		





			
1			
<b>Part No.</b>	104186	<b>Ref. No.</b>	0H6337
<b>description</b>	bar burner ømm W 28mm H 49mm L 510mm with ignition bridge 170mm flange width 35mm flange length 70mm tilting bratt pan		

			
1			
<b>Part No.</b>	105999	<b>Ref. No.</b>	0G3823
<b>description</b>	bar burner slotted ømm W 30mm H 55mm L 500mm gas range		

			
1			
<b>Part No.</b>	104590	<b>Ref. No.</b>	0TR593
<b>description</b>	bar burner T-shape L 224mm ø 32mm bain marie		

## tube burners

			
1			
<b>Part No.</b>	105071	<b>Ref. No.</b>	059297
<b>description</b>	tubular burner L 265mm W 50mm H 71mm for fryer oval suitable for 700/900 series		

## accessories

### nozzle holders

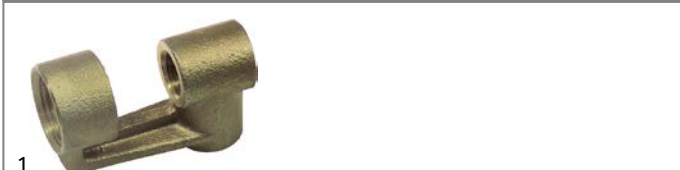
			
1			
<b>Part No.</b>	104753	<b>Ref. No.</b>	19012711
<b>description</b>	nozzle holder		

			
1			
<b>Part No.</b>	104522	<b>Ref. No.</b>	17012721
<b>description</b>	nozzle holder ID ø 10mm ET M17x1		

## gas nozzles

### main nozzles

#### gas nozzles M10x1

			
1			
<b>Part No.</b>	100155	<b>Ref. No.</b>	056470
<b>description</b>	gas injector thread M10x1 bore ø 1.45mm L 30mm WS 12		

			
1			
<b>Part No.</b>	106403	<b>Ref. No.</b>	054033
<b>description</b>	gas injector thread M10x1 bore ø 1.9mm L 30mm WS 12		

			
1			
<b>Part No.</b>	102499	<b>Ref. No.</b>	056471
<b>description</b>	gas injector thread M10x1 bore ø 2.25mm L 30mm WS 12		

#### gas nozzles M12x1

			
1			
<b>Part No.</b>	100279	<b>Ref. No.</b>	0KW937
<b>description</b>	gas injector thread M12x1 WS 14 bore ø 0.82mm		

			
1			
<b>Part No.</b>	100280	<b>Ref. No.</b>	0G2773
<b>description</b>	gas injector thread M12x1 WS 14 bore ø 0.93mm		

			
1			
<b>Part No.</b>	100282	<b>Ref. No.</b>	0KW934
<b>description</b>	gas injector thread M12x1 WS 14 bore ø 0.95mm		





			
1			
<b>Part No.</b>	100285	<b>Ref. No.</b>	0G2774
<b>description</b>	gas injector thread M12x1 WS 14 bore ø 1.10mm		

			
1			
<b>Part No.</b>	100239	<b>Ref. No.</b>	0G2396
<b>description</b>	gas injector thread M12x1 WS 14 bore ø 1.65mm		

			
1			
<b>Part No.</b>	100243	<b>Ref. No.</b>	0KW933
<b>description</b>	gas injector thread M12x1 WS 14 bore ø 1.12mm		

			
1			
<b>Part No.</b>	100288	<b>Ref. No.</b>	0K1229
<b>description</b>	gas injector thread M12x1 WS 14 bore ø 1.70mm		

			
1			
<b>Part No.</b>	100286	<b>Ref. No.</b>	0K1246
<b>description</b>	gas injector thread M12x1 WS 14 bore ø 1.30mm		

			
1			
<b>Part No.</b>	100289	<b>Ref. No.</b>	0G3001
<b>description</b>	gas injector thread M12x1 WS 14 bore ø 1.80mm		

			
1			
<b>Part No.</b>	100669	<b>Ref. No.</b>	0G2395
<b>description</b>	gas injector thread M12x1 WS 14 bore ø 1.37mm		

			
1			
<b>Part No.</b>	100740	<b>Ref. No.</b>	0G2397
<b>description</b>	gas injector thread M12x1 WS 14 bore ø 1.95mm		

			
1			
<b>Part No.</b>	100307	<b>Ref. No.</b>	0K1224
<b>description</b>	gas injector thread M12x1 WS 14 bore ø 1.40mm		

			
1			
<b>Part No.</b>	100291	<b>Ref. No.</b>	0G2914
<b>description</b>	gas injector thread M12x1 WS 14 bore ø 2.00mm		

			
1			
<b>Part No.</b>	100700	<b>Ref. No.</b>	0G3463
<b>description</b>	gas injector thread M12x1 WS 14 bore ø 1.50mm		

			
1			
<b>Part No.</b>	100744	<b>Ref. No.</b>	0G2915
<b>description</b>	gas injector thread M12x1 WS 14 bore ø 2.12mm		

			
1			
<b>Part No.</b>	100301	<b>Ref. No.</b>	0G3804
<b>description</b>	gas injector thread M12x1 WS 14 bore ø 1.55mm		

			
1			
<b>Part No.</b>	100309	<b>Ref. No.</b>	0K1230
<b>description</b>	gas injector thread M12x1 WS 14 bore ø 2.30mm		



1

<b>Part No.</b>	100294	<b>Ref. No.</b>	OG3803
<b>description</b>	gas injector thread M12x1 WS 14 bore ø 2.40mm		



1

<b>Part No.</b>	100416	<b>Ref. No.</b>	OG3511
<b>description</b>	gas injector thread M12x1 WS 14 bore ø 2.55mm		



1

<b>Part No.</b>	100304	<b>Ref. No.</b>	OG3891
<b>description</b>	gas injector thread M12x1 WS 14 bore ø 2.60mm		



1

<b>Part No.</b>	100752	<b>Ref. No.</b>	OG2964
<b>description</b>	gas injector thread M12x1 WS 14 bore ø 3.20mm		



1

<b>Part No.</b>	100762	<b>Ref. No.</b>	OG3892
<b>description</b>	gas injector thread M12x1 WS 14 bore ø 4.10mm		

## pilot burner nozzles

## pilot burner nozzles EGA



1

<b>Part No.</b>	101534	<b>Ref. No.</b>	OG2372
<b>description</b>	pilot burner nozzle LPG bore ø 0.19mm code 19 gas pressure 50mbar thread M5x0.8 suitable for THERMA/ELECTROLUX		



1

<b>Part No.</b>	101543	<b>Ref. No.</b>	OKI185
<b>description</b>	pilot burner nozzle natural gas bore ø 0.3mm code 30 gas pressure 20mbar thread M5x0.8		

## pilot burner nozzles JUNKERS

## CB 50203\_/503\_ series



1

<b>Part No.</b>	100220	<b>Ref. No.</b>	OK1176
<b>description</b>	pilot burner nozzle LPG gas pressure 50mbar code 2 Qty 1 pcs suitable for JUNKERS CB503_		



1

<b>Part No.</b>	100222	<b>Ref. No.</b>	OK1126
<b>description</b>	pilot burner nozzle LPG gas pressure 50mbar code 5 Qty 1 pcs suitable for JUNKERS CB50203_		

## pilot burner nozzles SIT

## 100 series



1

<b>Part No.</b>	100245	<b>Ref. No.</b>	056799
<b>description</b>	pilot burner nozzle LPG code 20 bore ø 0.2mm Qty 1 pcs thread M8x0.75		



1

<b>Part No.</b>	100246	<b>Ref. No.</b>	056656
<b>description</b>	pilot burner nozzle natural gas bore ø 0.35mm Qty 1 pcs thread M8x0.75		



1

<b>Part No.</b>	107170	<b>Ref. No.</b>	058525
<b>description</b>	pilot burner nozzle SIT natural gas bore ø 0.35mm Qty 1 pcs		

## 160 series



1

<b>Part No.</b>	107172	<b>Ref. No.</b>	054593
<b>description</b>	pilot burner nozzle SIT LPG code 25 Qty 1 pcs		



bypass nozzles

bypass nozzles PEL20/21



1			
<b>Part No.</b>	100554	<b>Ref. No.</b>	002900
<b>description</b>	bypass nozzle type PEL20/21 bore ø 0.45mm thread M5x0.5		



1			
<b>Part No.</b>	100548	<b>Ref. No.</b>	002991
<b>description</b>	bypass nozzle type PEL20/21 bore ø 0.65mm thread M5x0.5		



1			
<b>Part No.</b>	100528	<b>Ref. No.</b>	002926
<b>description</b>	bypass nozzle type PEL20/21 bore ø 0.9mm thread M5x0.5		

bypass nozzles PEL22



1			
<b>Part No.</b>	100414	<b>Ref. No.</b>	004261
<b>description</b>	bypass nozzle type PEL22 bore ø 0.45mm thread M6x0.5		

auxiliary gas parts

screw connections

olives

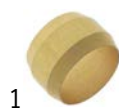

1			
<b>Part No.</b>	101278	<b>Ref. No.</b>	060325
<b>description</b>	olive for pipe ø 10mm Qty 1 pcs		

accessories for 101278

	<b>Part No.</b>	100943	<b>Ref. No.</b>	OKL494
	<b>description</b>	union nut thread M17x1 tube ø 10mm		

	<b>Part No.</b>	101300	<b>Ref. No.</b>	—
	<b>description</b>	union nut thread M16x1.5 tube ø 10mm		

	<b>Part No.</b>	101478	<b>Ref. No.</b>	—
	<b>description</b>	union nut thread 3/8" for pipe ø 10mm		



1			
<b>Part No.</b>	101248	<b>Ref. No.</b>	050682
<b>description</b>	olive for pipe ø 12mm Qty 1 pcs suitable for PEL		

accessories for 101248

	<b>Part No.</b>	101251	<b>Ref. No.</b>	—
	<b>description</b>	union nut thread M20x1.5 for pipe ø 12mm		



1			
<b>Part No.</b>	100897	<b>Ref. No.</b>	059161
<b>description</b>	olive for pipe ø 4mm Qty 1 pcs for pilot burner		

union nuts

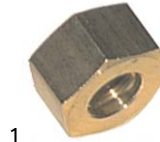

1			
<b>Part No.</b>	100943	<b>Ref. No.</b>	OKL494
<b>description</b>	union nut thread M17x1 tube ø 10mm		

accessories for 100943

	<b>Part No.</b>	101278	<b>Ref. No.</b>	060325
	<b>description</b>	olive for pipe ø 10mm Qty 1 pcs		

union screws





1			
<b>Part No.</b>	100906	<b>Ref. No.</b>	057960
<b>description</b>	screw connection thread M10x1 for ignition electrode brass Qty 1 pcs WS 10		



1			
<b>Part No.</b>	100908	<b>Ref. No.</b>	052125
<b>description</b>	union screw thread M10x1 for pipe ø 4mm Qty 1 pcs		

accessories for 100908

	<b>Part No.</b>	100897	<b>Ref. No.</b>	059161
	<b>description</b>	olive for pipe ø 4mm Qty 1 pcs for pilot burner		

	<b>Part No.</b>	101246	<b>Ref. No.</b>	—
	<b>description</b>	olive for pipe ø 4mm Qty 1 pcs		

	<b>Part No.</b>	101280	<b>Ref. No.</b>	—
	<b>description</b>	olive for pipe ø 4mm Qty 1 pcs		

	<b>Part No.</b>	101282	<b>Ref. No.</b>	—
	<b>description</b>	olive for pipe ø 4mm L 7.4mm Qty 1 pcs		



## equipment-specific units

## for convection ovens/combi-steamers

## filters



1

<b>Part No.</b>	514425	<b>Ref. No.</b>	0C1740
<b>description</b>	drain filter ø 102mm		

## for boiling pans

## miscellaneous



1

<b>Part No.</b>	691254	<b>Ref. No.</b>	0KJ532
<b>description</b>	lever for tilting kettle		



1

<b>Part No.</b>	540993	<b>Ref. No.</b>	0TR591
<b>description</b>	support for manometer size 1/2"		

## for dishwashers

## containers

## accessories



1

<b>Part No.</b>	504703	<b>Ref. No.</b>	048434
<b>description</b>	lid suitable for ZANUSSI equiv. no. 048434 external height 20mm		

## boilers

## accessories



1

<b>Part No.</b>	517339	<b>Ref. No.</b>	005381
<b>description</b>	flange ø 74mm ID ø 33mm thickness 1mm hole ø 9mm		

## air traps

## air traps



1

<b>Part No.</b>	504620	<b>Ref. No.</b>	048308
-----------------	--------	-----------------	--------

**description** air trap**accessories for** 504620

<b>Part No.</b>	504618	<b>Ref. No.</b>	—
<b>description</b>	O-ring EPDM thickness 2.62mm ID ø 15.54mm Qty 1 pcs		



<b>Part No.</b>	504621	<b>Ref. No.</b>	—
<b>description</b>	nut		



1

<b>Part No.</b>	504622	<b>Ref. No.</b>	046631
-----------------	--------	-----------------	--------

**description** air trap**accessories for** 504622

<b>Part No.</b>	511452	<b>Ref. No.</b>	—
<b>description</b>	gasket for air trap		



<b>Part No.</b>	528487	<b>Ref. No.</b>	—
<b>description</b>	O-ring EPDM thickness 2.62mm ID ø 9.19mm Qty 1 pcs		



1

<b>Part No.</b>	510103	<b>Ref. No.</b>	069515
-----------------	--------	-----------------	--------

**description** air trap L 85mm W 20mm H 80mm hose ø 6mm plastic**spare parts for** 510103

<b>Part No.</b>	505045	<b>Ref. No.</b>	—
<b>description</b>	O-ring EPDM thickness 1.78mm ID ø 5.28mm Qty 1 pcs		



<b>Part No.</b>	505094	<b>Ref. No.</b>	—
<b>description</b>	air trap		



<b>Part No.</b>	510016	<b>Ref. No.</b>	—
<b>description</b>	eye bolt for rinse aid container connection		

Table continues overleaf







spare parts for 510103			
	Part No.	510105	Ref. No. —
hose connector for air trap			

mechanics for flight type dishwashers

1 			
Part No.	510598	Ref. No.	0E5006
description guide for spindle L 60mm W 40mm hole ø 21mm thickness 15mm			

1 			
Part No.	511483	Ref. No.	0K8142
description hook			

1 			
Part No.	504603	Ref. No.	0K8166
description hook for dishwasher			

door mechanics

springs

roller springs

1 			
Part No.	519449	Ref. No.	0E5158
description roller spring W 25mm ID ø 32mm lug lengthmm			

locks

1 			
Part No.	504659	Ref. No.	047491
description door catch L 84mm W 19mm H 31mm mounting distance 64mm catch housing			

curtains

curtains

1 			
Part No.	533004	Ref. No.	0E5038
description curtain W 550mm H 355mm			

washing and rinsing systems

1 			
Part No.	504547	Ref. No.	047283
description knurled nut thread M8x1 ø 25mm H 6mm SS			

1 			
Part No.	504258	Ref. No.	0E2969
description wash pipe ø 63mm L 185mm L-shape			

knobs

universal knobs

1 			
Part No.	110242	Ref. No.	0K9909
description knob thermostat t.max. 180°C ø 50mm shaft ø 6x4.6mm shaft flat upper black temperature range 100-180°C			

producer-specific knobs

ELECTROLUX/THERMA

1 			
Part No.	112054	Ref. No.	0KI391
description knob gas tap with ignition flame t.max.°C temperature range°C ø 60mm shaft ø 6x4.6mm shaft flat lower blue			

mechanical components,  
equipment accessories  
1



1

<b>Part No.</b>	111824	<b>Ref. No.</b>	OG3711
<b>description</b>	knob gas tap with ignition flame t.max.°C temperature range°C ø 60mm shaft ø 6x4.6mm shaft flat upper blue		



1

<b>Part No.</b>	111827	<b>Ref. No.</b>	OG3648
<b>description</b>	knob switch zero mark t.max.°C temperature range°C ø 60mm shaft ø 6x4.6mm shaft flat lower dark blue		

## accessories

### covers



1

<b>Part No.</b>	112107	<b>Ref. No.</b>	OG3399
<b>description</b>	lid knob		

### fascias



1

<b>Part No.</b>	112106	<b>Ref. No.</b>	OK5794
<b>description</b>	bezel zero mark		

## handles and hand wheels

### hand wheels

### hand wheels



1

<b>Part No.</b>	690085	<b>Ref. No.</b>	OK5532
<b>description</b>	hand wheel ø 200mm D1 ø 48mm bore ø 20mm thread groove widthmm L1 30mm L2 60mm handle length 82mm with folding handle		
<b>spare parts for</b>	690085		
	<b>Part No.</b>	514255	<b>Ref. No.</b> —
	folding handle ø 26mm total length 85mm seat ø 20mm shaft ømm thread M6 with pin L 85mm		



1

<b>Part No.</b>	690551	<b>Ref. No.</b>	OH6472
<b>description</b>	hand wheel ø 200mm D1 ø 48mm bore ø 20mm thread M8 groove widthmm L1 30mm L2 60mm handle length 80mm no fold-away handle		

### lever handles



1

<b>Part No.</b>	540929	<b>Ref. No.</b>	056887
<b>description</b>	lever handle suitable for outlet tap shaft 8x8mm L 90mm		

### recessed handles



1

<b>Part No.</b>	504780	<b>Ref. No.</b>	047481
<b>description</b>	handle		



## locks



### edgemount latches

#### handle latches

#### producer-specific

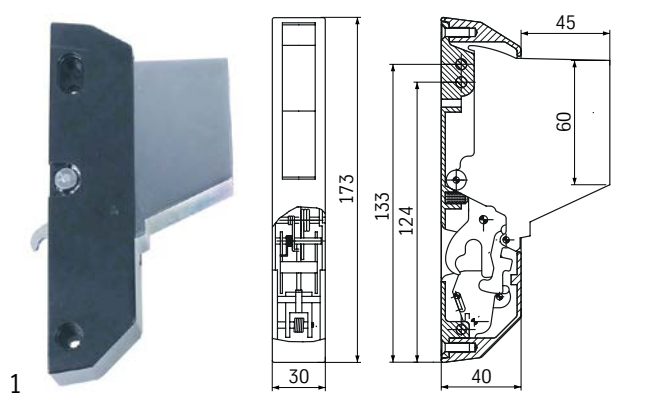
#### ZANUSSI



<b>Part No.</b>	700467	<b>Ref. No.</b>	002647
<b>description</b>	catch L 173mm H 40mm mounting distance 133/124mm W 30mm non lockable 6200 total length 170mm overall height 85mm		
<b>accessories for</b>	700467		
	<b>Part No.</b>	693937	<b>Ref. No.</b> 0F0029
	door handle H 44mm L 220mm W 50mm plastic black		
	<b>Part No.</b>	700468	<b>Ref. No.</b> 002650
	door catch with roller		
	<b>Part No.</b>	701412	<b>Ref. No.</b> —
	cover cap plastic round ø 11mm black for catch thickness 8mm		

### door catches



<b>Part No.</b>	700468	<b>Ref. No.</b>	002650
<b>description</b>	door catch with roller		

## hinges

### door bearing



<b>Part No.</b>	700480	<b>Ref. No.</b>	002875
<b>description</b>	hinge bearing mounting pos. lower with bolt		

### accessories

#### base plate



<b>Part No.</b>	700479	<b>Ref. No.</b>	002877
<b>description</b>	base plate for door hinge mounting pos. upper left		

### miscellaneous



<b>Part No.</b>	700474	<b>Ref. No.</b>	002653
<b>description</b>	disc for hinge corrugated		



<b>Part No.</b>	700478	<b>Ref. No.</b>	002645
<b>description</b>	protector for glass door for hinge		

## fittings for catering equipment

### aerators and air bleeders



<b>Part No.</b>	540014	<b>Ref. No.</b>	OK5787
<b>description</b>	aerator and air bleeder thread 1/2" ET chrome-plated L 78mm		
<b>spare parts for</b>	540014		
	<b>Part No.</b>	112777	<b>Ref. No.</b> —
	star handle shaft 6x6mm ø 50mm L 18mm black plastic		
	<b>Part No.</b>	540365	<b>Ref. No.</b> —
	star handle shaft 6x6mm ø 50mm L 18mm black thermoplastic		

1 mechanical components, equipment accessories





**1**

<b>Part No.</b>	540013	<b>Ref. No.</b>	OG3246
<b>description</b>	aerator and air bleeder thread 3/8" ET WS 27 chrome-plated L 86mm		
<b>spare parts for</b>	540013		
	<b>Part No.</b>	112777	<b>Ref. No.</b> —
	star handle shaft 6x6mm ø 50mm L 18mm black plastic		
	<b>Part No.</b>	540365	<b>Ref. No.</b> —
	star handle shaft 6x6mm ø 50mm L 18mm black thermoplastic		



**1**

<b>Part No.</b>	540949	<b>Ref. No.</b>	OH9729
<b>description</b>	aerator and air bleeder thread 1/2" ET chrome-plated with O-ring L 15mm ø 25mm		

## lid hinges

### type ECHTERMANN

#### 10 series

#### 10.81

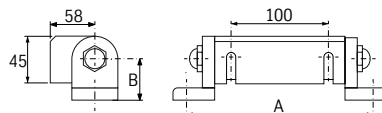

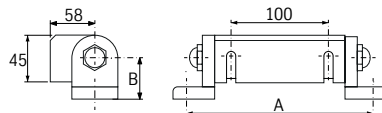

**1**

<b>Part No.</b>	692648	<b>Ref. No.</b>	OK5245
<b>description</b>	lid hinge type 1081 level of centre of rotation 35mm load capacity 10-20NM opening angle 75° closing angle 10° mounting distance 198mm bore ø 11mm MD lid 100mm chrome-plated brass		





**1**

<b>Part No.</b>	691203	<b>Ref. No.</b>	OK5247
<b>description</b>	lid hinge type 1081 level of centre of rotation 45mm load capacity 50-60NM opening angle 75° closing angle 10° mounting distance 198mm bore ø 11mm MD lid 100mm chrome-plated brass		
<b>spare parts for</b>	691203		
	<b>Part No.</b>	691614	<b>Ref. No.</b> —
	repair kit for lid hinge load capacity 50-60NM		

## FITTINGS FOR CATERING EQUIPMENT THERMA

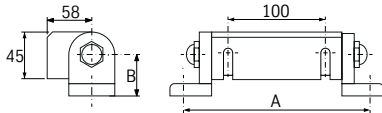
### 10.82



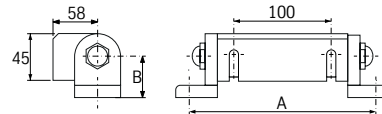

**1**

<b>Part No.</b>	692652	<b>Ref. No.</b>	OG3736
<b>description</b>	lid hinge type 1082 level of centre of rotation 35mm load capacity 70-100NM opening angle 72° closing angle 10° mounting distance 220mm bore ø 11mm MD lid 100mm chrome-plated brass		

**1**

<b>Part No.</b>	691204	<b>Ref. No.</b>	OH9913
<b>description</b>	lid hinge type 1082 level of centre of rotation 35mm load capacity 70-100NM opening angle 75° closing angle 10° mounting distance 220mm bore ø 11mm MD lid 100mm chrome-plated brass		
<b>spare parts for</b>	691204		
	<b>Part No.</b>	691615	<b>Ref. No.</b> —
	repair kit for lid hinge load capacity 70-100NM		

## drain taps

### brass

#### drain taps



**1**

<b>Part No.</b>	548001	<b>Ref. No.</b>	OS1037
<b>description</b>	drain tap 1 1/2" IT O-ring seal kettle connection with union nut A 80mm B1 68mm B2 132mm		
<b>spare parts for</b>	548001		
	<b>Part No.</b>	505092	<b>Ref. No.</b> —
	O-ring EPDM thickness 5.34mm ID ø 43.82mm Qty 1 pcs		
	<b>Part No.</b>	540213	<b>Ref. No.</b> —
	handle ID ø 5mm L 117mm		



1

<b>Part No.</b>	540275	<b>Ref. No.</b>	0C4850
<b>description</b>	drain tap 2" IT with union nut A 90mm B 151mm B1 80mm chrome-plated brass		
<b>spare parts for</b>	540275		
	<b>Part No.</b>	540214	<b>Ref. No.</b> —
	handle ID ø 6mm L 145mm		
<b>accessories for</b>	540275		
	<b>Part No.</b>	529484	<b>Ref. No.</b> —
	flat gasket fibre ED ø 58mm ID ø 50mm thickness 2mm Qty 1 pcs		
	<b>Part No.</b>	542448	<b>Ref. No.</b> —
	gasket silicone 60x49x2 for drain tap 2"		

**accessories**



1

<b>Part No.</b>	540222	<b>Ref. No.</b>	053809
<b>description</b>	O-ring EPDM thickness 2.62mm ID ø 47.3mm Qty 1 pcs		



1

<b>Part No.</b>	540083	<b>Ref. No.</b>	0K1469
<b>description</b>	pressure bolt for drain tap		

steam traps

steam traps

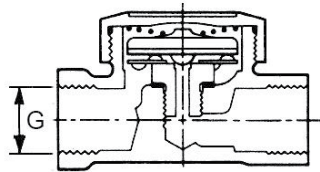
1

<b>Part No.</b>	541461	<b>Ref. No.</b>	0K5388
<b>description</b>	thermostatic steam trap thread 1/2" type BPT13S brass		

safety valves



1

<b>Part No.</b>	541458	<b>Ref. No.</b>	0K5784
<b>description</b>	safety valve T1: 1/2" T2: 1/2" triggering pressure 1.3bar		

**gaskets**  
gaskets for heated units

door seals

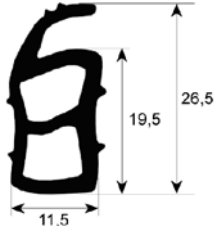

1

<b>Part No.</b>	900763	<b>Ref. No.</b>	0K9170
<b>description</b>	door seal profile 2276 Qty supplied by meter		

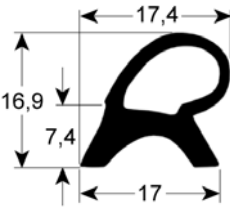

1

<b>Part No.</b>	900758	<b>Ref. No.</b>	0K8016
<b>description</b>	door seal profile 2450 W 445mm H 1360mm external size Qty 1 suitable for ELECTROLUX 450x1360		





<b>Part No.</b>	900759	<b>Ref. No.</b>	OK8015
<b>description</b>	door seal profile 2450 W 450mm H 720mm external size Qty 1 suitable for ELECTROLUX 447x719		

<b>Part No.</b>	900579	<b>Ref. No.</b>	005708
<b>description</b>	door seal profile 2520 W 450mm L 1490mm external size Qty 1 suitable for ELECTROLUX 450x1490		

<b>Part No.</b>	900577	<b>Ref. No.</b>	005710
<b>description</b>	door seal profile 2520 W 450mm L 550mm external size Qty 1 suitable for ELECTROLUX 450x550		

<b>Part No.</b>	900578	<b>Ref. No.</b>	005709
<b>description</b>	door seal profile 2520 W 450mm L 770mm external size Qty 1 suitable for ELECTROLUX 450x770		

<b>Part No.</b>	900753	<b>Ref. No.</b>	OK9171
<b>description</b>	door seal profile 2905 Qty supplied by meter		

<b>Part No.</b>	900764	<b>Ref. No.</b>	OK8159
<b>description</b>	door seal profile 2921 L 1600mm Qty 1		

## boiling pan gaskets

<b>Part No.</b>	900755	<b>Ref. No.</b>	OK5571
<b>description</b>	boiling pan gasket profile 3030 L 1130mm W 655mm		

<b>Part No.</b>	900609	<b>Ref. No.</b>	OK5574
<b>description</b>	door seal profile 3030 ø 430mm		

## O-rings

## EPDM

<b>Part No.</b>	532003	<b>Ref. No.</b>	059293
<b>description</b>	O-ring EPDM thickness 1.78mm ID ø 3.69mm Qty 10 pcs		

<b>Part No.</b>	532581	<b>Ref. No.</b>	0E5118
<b>description</b>	O-ring EPDM thickness 2.3mm ID ø 17.2mm Qty 1 pcs		

<b>Part No.</b>	540222	<b>Ref. No.</b>	053809
<b>description</b>	O-ring EPDM thickness 2.62mm ID ø 47.3mm Qty 1 pcs		



1

<b>Part No.</b>	510009	<b>Ref. No.</b>	069531
<b>description</b>	O-ring EPDM thickness 3.53mm ID ø 101.2mm Qty 1 pcs		

1

<b>Part No.</b>	510408	<b>Ref. No.</b>	067620
<b>description</b>	O-ring EPDM thickness 5.34mm ID ø 47mm Qty 1 pcs		

Viton

1

<b>Part No.</b>	511300	<b>Ref. No.</b>	002873
<b>description</b>	O-ring Viton thickness 3.53mm ID ø 28.17mm for 57 series for motor shaft		

1

<b>Part No.</b>	528412	<b>Ref. No.</b>	002874
<b>description</b>	O-ring Viton thickness 3.53mm ID ø 31.34mm Qty 1 pcs		

sealing washers

rubber gaskets

1

<b>Part No.</b>	504776	<b>Ref. No.</b>	049828
<b>description</b>	gasket rubber ED ø 60mm ID ø 50mm thickness 1.5mm for intake body		

shaft gaskets

miscellaneous

1

<b>Part No.</b>	511301	<b>Ref. No.</b>	002699
<b>description</b>	shaft seal ID ø 16mm ED ø 38mm thickness 18mm		

special gaskets

miscellaneous

1

<b>Part No.</b>	550924	<b>Ref. No.</b>	002075
<b>description</b>	gasket for probe ID ø 6mm EPDM		

1

<b>Part No.</b>	900775	<b>Ref. No.</b>	OK5103
<b>description</b>	gasket L 1000mm size 10x2mm self-adhesive silicone		

1

<b>Part No.</b>	691252	<b>Ref. No.</b>	OK5262
<b>description</b>	gasket profile V ED ø 46mm ID ø 36mm		



## transmission technology and ball bearings

### drive belts

#### toothed belts



1

<b>Part No.</b>	504778	<b>Ref. No.</b>	0E5050
<b>description</b>	toothed belt profile T10 L 610mm H 4mm teeth 61 rubber with textile insertion CODE 354TI W 16mm		

## springs

### compression springs



1

<b>Part No.</b>	504660	<b>Ref. No.</b>	047492
<b>description</b>	compression spring $\phi$ 8.9mm L 37.5mm wire gauge $\phi$ 1.15mm		

### roller springs

#### roller springs



1

<b>Part No.</b>	519449	<b>Ref. No.</b>	0E5158
<b>description</b>	roller spring W 25mm ID $\phi$ 32mm lug lengthmm		



1

<b>Part No.</b>	504518	<b>Ref. No.</b>	0E5167
<b>description</b>	roller spring W 39mm ID $\phi$ 32mm lug lengthmm		

## manometers



1

<b>Part No.</b>	541460	<b>Ref. No.</b>	0K5402
<b>description</b>	manometer pressure range 0 up to 2.5bar marking 1.3		

## hoses

### supply hoses

#### PVC supply hoses



1

<b>Part No.</b>	520011	<b>Ref. No.</b>	0L1887
<b>description</b>	supply hose PVC straight-curved DN13 connections 3/4" L 2000mm operating p. 10bar burst p. 32bar t.max. 90°C approval VDE flat seal		

### industrial hoses

#### Niplaflex hoses



1

<b>Part No.</b>	530561	<b>Ref. No.</b>	0C4158
<b>description</b>	pressure hose ID $\phi$ 10mm ED $\phi$ 17mm L 5m thickness 3.5mm operating p. 10bar burst p. 30bar t.max. 110°C		

## valves and tank inlets

### ball valves

#### universal

#### ball valves with butterfly handle



1

<b>Part No.</b>	540982	<b>Ref. No.</b>	005927
<b>description</b>	ball valve connection 3/4" IT - 3/4" ET DN20 total length 69mm shaft $\phi$ 8x5mm		



ball valves electric

 <p>1</p>			
<b>Part No.</b>	401139	<b>Ref. No.</b>	OC0882
<b>description</b>	ball valve inlet 3/4" IT outlet 3/4" IT with plug 230V L 65mm 50/60Hz closed off-current mode of operation electric connection cable 200mm		

ancillary products

clamps

hose clamps

DIN 3017 - W2

 <p>1</p>			
<b>Part No.</b>	520112	<b>Ref. No.</b>	048126
<b>description</b>	hose clamp ø 12-20mm width 9mm Qty 10 pcs DIN 3017		

 <p>1</p>			
<b>Part No.</b>	520116	<b>Ref. No.</b>	046878
<b>description</b>	hose clamp ø 32-50mm width 9mm Qty 5 pcs DIN 3017		

 <p>1</p>			
<b>Part No.</b>	520118	<b>Ref. No.</b>	046855
<b>description</b>	hose clamp ø 50-70mm width 9mm Qty 5 pcs DIN 3017		

measuring equipment

thermometers

built-in thermometers

 <p>1</p>			
<b>Part No.</b>	541522	<b>Ref. No.</b>	048525
<b>description</b>	thermometer mounting measurements 45x45mm +40 up to +120°C capillary pipe 5000mm probe ø 6mm probe L 36mm front measurements 48x48mm		

fastening material

nuts

knurled nuts

 <p>1</p>			
<b>Part No.</b>	504547	<b>Ref. No.</b>	047283
<b>description</b>	knurled nut thread M8x1 ø 25mm H 6mm SS		

hexagonal nuts

DIN 6923 / ISO 4161

 <p>1</p>			
<b>Part No.</b>	504315	<b>Ref. No.</b>	0E5372
<b>description</b>	nut thread M5 H 5mm WS 8 Qty 10 pcs		

washers

washers

DIN 125A

 <p>1</p>			
<b>Part No.</b>	560114	<b>Ref. No.</b>	OK5101
<b>description</b>	plain washer ID ø 8.4mm ED ø 16mm thickness 1.6mm SS Qty 20 pcs DIN 125A for thread M8		



## fasteners

## slot nuts



1

<b>Part No.</b>	560268	<b>Ref. No.</b>	0E5048
<b>description</b>	slot nut W 8mm H 7mm L 35mm		

## clamps

## hose clamps

## DIN 3017 - W2



1

<b>Part No.</b>	520112	<b>Ref. No.</b>	048126
<b>description</b>	hose clamp ø 12-20mm width 9mm Qty 10 pcs DIN 3017		



1

<b>Part No.</b>	520116	<b>Ref. No.</b>	046878
<b>description</b>	hose clamp ø 32-50mm width 9mm Qty 5 pcs DIN 3017		



1

<b>Part No.</b>	520118	<b>Ref. No.</b>	046855
<b>description</b>	hose clamp ø 50-70mm width 9mm Qty 5 pcs DIN 3017		

## roll pins



1

<b>Part No.</b>	692013	<b>Ref. No.</b>	0H6043
<b>description</b>	roll pin ø 3mm L 16mm		

## consumables

## sealants and adhesives

## high temperature silicone



1

<b>Part No.</b>	890050	<b>Ref. No.</b>	OK3948
<b>description</b>	high temperature silicone NOVASIL S76 acetoxy-curing -40 up to +265°C t.max. 280°C anthracite cartridge 310ml		
<b>description</b>	<p>Novasil S56 - cartridge 310ml - anthracite</p> <ul style="list-style-type: none"> <li>- Developed for applications in the home appliance industry: <ul style="list-style-type: none"> <li>- Gluing of oven door seals</li> </ul> </li> <li>- Gluing of mounting brackets for cooker fascias, oven door seals and handles</li> <li>- Attachment of elastic seals, e.g. to oven doors Temperature resistance: -40°C to +265°C</li> </ul>		

## lubricants

## silicone fats



1

<b>Part No.</b>	890101	<b>Ref. No.</b>	0H7004
<b>description</b>	silicone grease FERMIT GLISSA tube 60g -40 to +200°C approval		
<b>description</b>	<p>Fermit GLISSA - tube 60g</p> <p>Non-drip lubricating grease for drinking water valves and fittings Glissa silicone grease is suitable as a lubricant and sealant for drinking water valves and fittings (e.g. cartridges of single-lever mixers, switching valves and swivel spouts). Water-repellent, physiologically safe, sealing and has a high temperature resistance up to 200°C. Complies with the guidelines of the UBA for sanitary lubricants, tested by TZW for suitability for drinking water and approved in accordance with DIN ISO 21469.</p> <p>Temperature range: -40°C to +200°C</p>		

## fuses

## fine fuses





1

<b>Part No.</b>	358677	<b>Ref. No.</b>	057783
<b>description</b>	fine fuse size ø5x20mm 4A fast-acting rated 250V Qty 10 pcs		





			
1			
<b>Part No.</b>	358695	<b>Ref. No.</b>	005032
<b>description</b>	fine fuse size ø5x20mm 3.15A medium lag rated 250V Qty 10 pcs		

			
1			
<b>Part No.</b>	358703	<b>Ref. No.</b>	002750
<b>description</b>	fine fuse size ø5x20mm 0.4A slow-acting rated 250V Qty 10 pcs		

			
1			
<b>Part No.</b>	358397	<b>Ref. No.</b>	OK5074
<b>description</b>	fuse size 76mm 25A rated 690V Qty 1 pcs		

**GASTRO**PARTS.COM

