



**GASTROPARTS**

# Telme

- [EN]** Equipment
- [DE]** Geräte
- [ES]** Aparatos
- [FR]** Équipement
- [IT]** Attrezzature
- [PL]** Urządzenia
- [RU]** Оборудование

✉ [gastroparts@gastroparts.com](mailto:gastroparts@gastroparts.com)

☎ +48 56 657 00 66

📘 [fb.com/gastroparts.global](https://fb.com/gastroparts.global)

**GASTROPARTS.COM**





## thermostats

### refrigeration thermostats

RANCO

K50 series

RANCO



1

<b>Part No.</b>	390292	<b>Ref. No.</b>	F05.002.R
<b>description</b>	thermostat RANCO type K50P1118 probe ømm probe Lmm capillary pipe 1250mm temperature range -3 up to +2.5°C		

## switches and momentary switches

### rocker/momentary rocker switches

30x22mm



1

<b>Part No.</b>	347791	<b>Ref. No.</b>	E02.001.R
<b>description</b>	rocker switch mounting measurements 30x22mm green 2NO 230V 20A illuminated 0-I connection male faston 6.3mm ambient temperature max. 125/55°C protection IP65 with rubber collar		



1

<b>Part No.</b>	301004	<b>Ref. No.</b>	E02007
<b>description</b>	rocker switch mounting measurements 30x22mm black 2CO 250V 16A connection male faston 6.3mm ambient temperature max. 125/55°C protection IP40		
<b>accessories for</b>	301004		



<b>Part No.</b>	301036	<b>Ref. No.</b>	—
<b>description</b>	protective cover internal size 30x22mm for rocker switch mounting measurementsmm		



1

<b>Part No.</b>	301078	<b>Ref. No.</b>	E02.016.R
<b>description</b>	momentary rocker switch mounting measurements 30x22mm black 2NO 250V 16A momentary 0-I connection male faston 6.3mm ambient temperature max. 85/125°C protection IP40		
<b>accessories for</b>	301078		



<b>Part No.</b>	301036	<b>Ref. No.</b>	—
<b>description</b>	protective cover internal size 30x22mm for rocker switch mounting measurementsmm		

## magnetic switches

M25x1.5



1

<b>Part No.</b>	347671	<b>Ref. No.</b>	E04.097
<b>description</b>	magnetic switch thread M25x1.5 24V cable length 1900mm		

## control equipment

### SIEMENS

3SB series ø22mm new

push buttons



1

<b>Part No.</b>	347520	<b>Ref. No.</b>	E02.015.R E02006
<b>description</b>	push button mounting measurements ø22mm non-illuminated black		
<b>accessories for</b>	347520		



<b>Part No.</b>	346630	<b>Ref. No.</b>	E03003 E03.084.R
<b>description</b>	contact block SIEMENS 3SB3400-0B 1NO max 400V 10A black		



1

<b>Part No.</b>	346630	<b>Ref. No.</b>	E03.084.R E03003
<b>description</b>	contact block SIEMENS 3SB3400-0B 1NO max 400V 10A black		
<b>accessories for</b>	346630		



<b>Part No.</b>	347520	<b>Ref. No.</b>	E02006 E02.015.R
<b>description</b>	push button mounting measurements ø22mm non-illuminated black		



## timers

## mechanical timers



1

<b>Part No.</b>	350140 <sup>1</sup>	<b>Ref. No.</b>	E08.002.R
<b>description</b>	timer G 2-pole operation time 30min impulse mechanical 1NC/1NO at 250V 16A permanent position no shaft ø 3.5x3.5mm shaft L 18mm connection male faston 6.3mm 250/380V		

<sup>1</sup>incl. knob

## contactors

## GENERAL ELECTRIC (AEG)

## power contactors



1

<b>Part No.</b>	380235	<b>Ref. No.</b>	E04.018.R
<b>description</b>	power contactor resistive load 16A (AC3/400V) 6A/3kW main contacts 3NO auxiliary contacts 1NC connection screw type AEG LS0701A 24V		

## probes

## universal probes

## temperature probes



1

<b>Part No.</b>	379052	<b>Ref. No.</b>	E03.023.R
<b>description</b>	temperature probe PTC 1kOhm cable silicone probe -50 up to +150°C cable -50 up to +180°C probe ø6x40mm cable length 1.5m without screw connection 2-wire		

## electronics

## PCBs



1

<b>Part No.</b>	401716	<b>Ref. No.</b>	E10.092.R
<b>description</b>	keypad PCB		

## solenoid valves

## solenoid valves (water)

## metal

## PARKER

## spare parts and accessories

## solenoid coils



1

<b>Part No.</b>	371098	<b>Ref. No.</b>	E07.003.R
<b>description</b>	solenoid coil 220-230VAC 50/60Hz seat ø 14mm cable length 1000mm 14W		

## valve bodies



1

<b>Part No.</b>	371197	<b>Ref. No.</b>	E07.002.R
<b>description</b>	solenoid valve body ø 14mm		



## compressors

### ACC/ZEL

R134A

HMBP monophase

High/Medium evaporation temperature above -20/-15 °C



1

<b>Part No.</b>	605006	<b>Ref. No.</b>	F01.025.R
<b>description</b>	compressor coolant R134a type GD40MB 220-240V 50Hz HMBP fully hermetic 6.7kg 1/8HP power input 200W cylinder capacity 4.1cm <sup>3</sup> CSIR H 162.5mm 64W 87W 117W 153W 196W 245W 301W 363W test method ASHRAE		

## fans

### refrigeration fans

cold air circulating fans (complete)

miscellaneous



1

<b>Part No.</b>	601501	<b>Ref. No.</b>	M02.001.R
<b>description</b>	fan 230V 50/60Hz 25W ø 96mm type AAS13B-004 fan wheel ø 135mm connection right shaft L 24mm feet depth 25mm		

## motors

### motors

for cream whipping machines



1

<b>Part No.</b>	500701	<b>Ref. No.</b>	M01.042.R
<b>description</b>	motor 410W 230V 50Hz 1 phase shaft ø 15mm flange ø 79mm 1400rpm capacitor 16µF type RM80B4 REBO 0.41kW		

## equipment-specific units

for cream whipping machines

transmission technology and ball bearings

miscellaneous

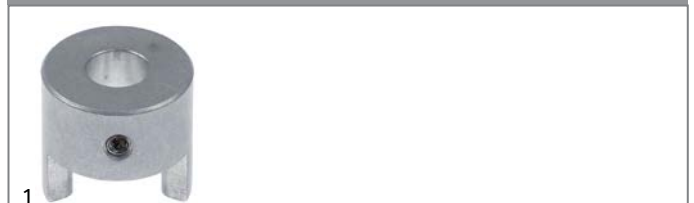

1

<b>Part No.</b>	696449	<b>Ref. No.</b>	A14.005 A14.005.R
<b>description</b>	coupling ø 27mm aluminium for cream maker suitable for TELME H 26mm shaft intake ø 11mm		



1

<b>Part No.</b>	696450	<b>Ref. No.</b>	A14.006 A14.006.R
<b>description</b>	rubber pad ø 27mm for coupling suitable for TELME H 11mm		

spare parts



1

<b>Part No.</b>	695455	<b>Ref. No.</b>	P10.002
<b>description</b>	cleaning brush for cream maker		





1

<b>Part No.</b>	695454	<b>Ref. No.</b>	B06.096
<b>description</b>	container for cream maker L 205mm W 80mm		



1

<b>Part No.</b>	695453	<b>Ref. No.</b>	P08.020
<b>description</b>	extraction hose for cream maker L 340mm ID ø 6mm ED ø 10mm		



1

<b>Part No.</b>	696447	<b>Ref. No.</b>	A02.004.R
<b>description</b>	valve for cream maker H 9mm ID ø 9mm ED ø 15mm		

### decorator tips



1

<b>Part No.</b>	696434	<b>Ref. No.</b>	P04.117
<b>description</b>	decorator tip cram whipping machine W 28mm H 36mm ID ø 22mm ED ø 28mm		



1

<b>Part No.</b>	696435	<b>Ref. No.</b>	P04.115.R
<b>description</b>	decorator tip cram whipping machine W 28mm H 36mm ID ø 22mm ED ø 28mm		



1

<b>Part No.</b>	695450	<b>Ref. No.</b>	P04.118
<b>description</b>	decorator tip for cream maker L 35mm		



1

<b>Part No.</b>	695452	<b>Ref. No.</b>	P04.116
<b>description</b>	decorator tip for cream maker L 36.5mm		

### pumps

#### accessories



1

<b>Part No.</b>	695451	<b>Ref. No.</b>	A11.033 A11.033.R
<b>description</b>	pin for cream maker angled 90° L 60mm		

### gaskets

#### O-rings

#### EPDM



1

<b>Part No.</b>	510302	<b>Ref. No.</b>	P02.013
<b>description</b>	O-ring EPDM ID ø 12.42mm thickness 1.78mm Qty 1 pcs		

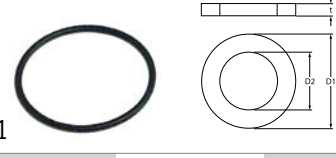

1

<b>Part No.</b>	532616	<b>Ref. No.</b>	P02.021
<b>description</b>	O-ring EPDM thickness 1.78mm ID ø 34.65mm Qty 1 pcs		

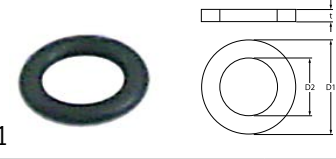

1

<b>Part No.</b>	532004	<b>Ref. No.</b>	P02.023
<b>description</b>	O-ring EPDM thickness 1.78mm ID ø 5.28mm Qty 10 pcs		



1

<b>Part No.</b>	510177	<b>Ref. No.</b>	P02.010.R
<b>description</b>	O-ring EPDM thickness 1.78mm ID ø 7.66mm Qty 1 pcs		

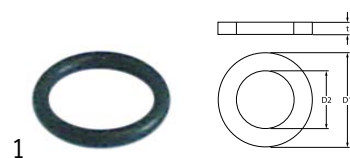
1

<b>Part No.</b>	504574	<b>Ref. No.</b>	P02.001
<b>description</b>	O-ring EPDM thickness 1.78mm ID ø 9.25mm Qty 1 pcs		



1

<b>Part No.</b>	529412	<b>Ref. No.</b>	P02.019.R
<b>description</b>	O-ring EPDM thickness 2.62mm ID ø 10.78mm Qty 1 pcs		

shaft gaskets

shaft gaskets



1

<b>Part No.</b>	696451	<b>Ref. No.</b>	P03.008.R
<b>description</b>	shaft sealing ID ø 13mm ED ø 22mm for cream maker H 6mm		

miscellaneous

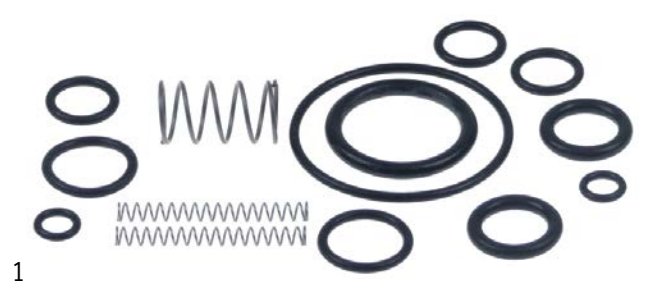

1

<b>Part No.</b>	551099	<b>Ref. No.</b>	P11.011.R
<b>description</b>	gasket set cram whipping machine Qty set 14-piece		

springs

compression springs



1

<b>Part No.</b>	528972	<b>Ref. No.</b>	A05.003
<b>description</b>	compression spring ø 10.7mm L 20mm wire gauge ø 0.8mm		



1

<b>Part No.</b>	528971	<b>Ref. No.</b>	A05.002
<b>description</b>	compression spring ø 3.4mm L 31.5mm wire gauge ø 0.4mm		

tools

cleaning tools

brushes

pipe brushes

nylon



1

<b>Part No.</b>	695455	<b>Ref. No.</b>	P10.002
<b>description</b>	cleaning brush for cream maker		

**GASTRO**PARTS.COM

