



**GASTROPARTS**

# Tecnoinox

- [EN]** Equipment
- [DE]** Geräte
- [ES]** Aparatos
- [FR]** Équipement
- [IT]** Attrezzature
- [PL]** Urządzenia
- [RU]** Оборудование

✉ [gastroparts@gastroparts.com](mailto:gastroparts@gastroparts.com)

☎ +48 56 657 00 66

📘 [fb.com/gastroparts.global](https://fb.com/gastroparts.global)

**GASTROPARTS.COM**





## heating elements



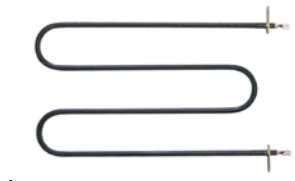

### heating elements for ovens

 <p>1</p>			
<b>Part No.</b>	416601	<b>Ref. No.</b>	00775 RC00775000
<b>description</b>	heating element 1000W 230V L 396mm W 65mm H 35mm 2 hole fixing mounting distance 87mm connection M4 tube ø 6.5mm immersion heater thread 1/4" heating circuits 1 connection length 26mm		

### heating elements for bain maries





 <p>1</p>			
<b>Part No.</b>	415293	<b>Ref. No.</b>	00269 RC00269000
<b>description</b>	heating element 1300W 230V heating circuits 1 L 330mm W 184mm tube ø 8.5mm lug length 40mm lug width 18mm connection male faston 6.3mm hole ø 5mm dry heating element bracket mounting		

### heating elements for frying pans

 <p>1</p>			
<b>Part No.</b>	415292	<b>Ref. No.</b>	00528 RC00528000
<b>description</b>	heating element 1100W 230V L 205mm W 110mm connection M4 tube ø 6.3mm 2 hole fixing thread 1/4" dry heating element H 54mm mounting distance 220mm		
<b>accessories for</b>	415292		
	<b>Part No.</b>	361182	<b>Ref. No.</b> —
	nut thread 1/4" H 5mm nickel-plated brass WS 17 Qty 1 pcs		
	<b>Part No.</b>	510417	<b>Ref. No.</b> —
	flat gasket fibre ED ø 20mm ID ø 14mm thickness 2mm Qty 1 pcs		
	<b>Part No.</b>	520228	<b>Ref. No.</b> —
	tooth lock washer ID ø 15.3mm ED ø 24mm steel Qty 1 pcs for thread M14		
	<b>Part No.</b>	550262	<b>Ref. No.</b> —
	flat gasket copper ED ø 20mm ID ø 14mm thickness 2mm		

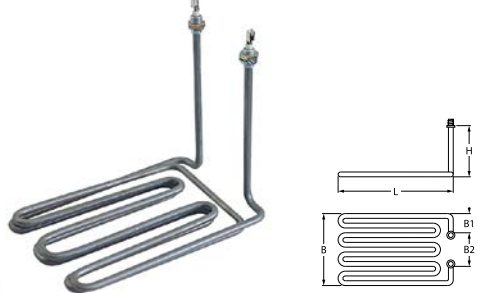
## heating elements for fryers

### 2 hole fixing

 <p>1</p>			
<b>Part No.</b>	416659	<b>Ref. No.</b>	00772 RC00772000
<b>description</b>	heating element 3000W 230V heating circuits 1 L 250mm W 175mm H 197mm 2 hole fixing connection male faston 6.3mm W1 35mm W2 95mm H1 175mm H2 20mm immersion heater thread 1/4" tube ø 8.9mm mounting distance 86mm connection length 21mm windings 3		
<b>accessories for</b>	416659		
	<b>Part No.</b>	361182	<b>Ref. No.</b> —
	nut thread 1/4" H 5mm nickel-plated brass WS 17 Qty 1 pcs		
	<b>Part No.</b>	510417	<b>Ref. No.</b> —
	flat gasket fibre ED ø 20mm ID ø 14mm thickness 2mm Qty 1 pcs		
	<b>Part No.</b>	520228	<b>Ref. No.</b> —
	tooth lock washer ID ø 15.3mm ED ø 24mm steel Qty 1 pcs for thread M14		
	<b>Part No.</b>	550262	<b>Ref. No.</b> —
	flat gasket copper ED ø 20mm ID ø 14mm thickness 2mm		





 <p>1</p>			
<b>Part No.</b>	415291	<b>Ref. No.</b>	00282 RC00282000
<b>description</b>	heating element 2000W 230V heating circuits 1 L 250mm W 45mm H 190mm H1 154mm H2 36mm thread 1/4" tube ø 8.5mm mounting distance 30mm windings 3 2 hole fixing connection male faston 6.3mm immersion heater		
<b>spare parts for</b>	415291		
	<b>Part No.</b>	510417	<b>Ref. No.</b> —
	flat gasket fibre ED ø 20mm ID ø 14mm thickness 2mm Qty 1 pcs		
<b>accessories for</b>	415291		
	<b>Part No.</b>	361182	<b>Ref. No.</b> —
	nut thread 1/4" H 5mm nickel-plated brass WS 17 Qty 1 pcs		
	<b>Part No.</b>	520228	<b>Ref. No.</b> —
	tooth lock washer ID ø 15.3mm ED ø 24mm steel Qty 1 pcs for thread M14		

Table continues overleaf



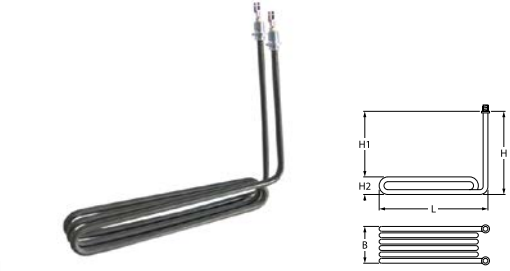

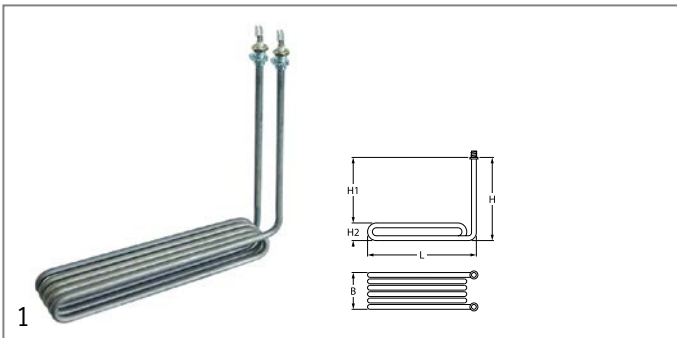

accessories for	415291		
	Part No.	550262	Ref. No.
			—
	flat gasket copper ED $\varnothing$ 20mm ID $\varnothing$ 14mm thickness 2mm		

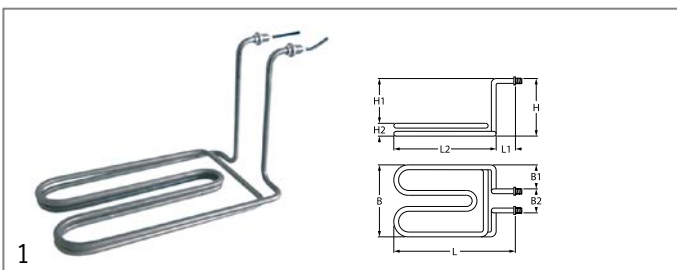





Part No.	416660	Ref. No.	01276 RC01276000
description	heating element 3600W 230V heating circuits 1 L 280mm W 68mm H 246mm H1 210mm H2 36mm thread 1/4" tube $\varnothing$ 8.5mm windings 5 2 hole fixing connection male faston 6.3mm		
accessories for	416660		
	Part No.	361182	Ref. No.
			—
	nut thread 1/4" H 5mm nickel-plated brass WS 17 Qty 1 pcs		
	Part No.	510417	Ref. No.
			—
	flat gasket fibre ED $\varnothing$ 20mm ID $\varnothing$ 14mm thickness 2mm Qty 1 pcs		
	Part No.	520228	Ref. No.
			—
	tooth lock washer ID $\varnothing$ 15.3mm ED $\varnothing$ 24mm steel Qty 1 pcs for thread M14		
	Part No.	550262	Ref. No.
			—
	flat gasket copper ED $\varnothing$ 20mm ID $\varnothing$ 14mm thickness 2mm		

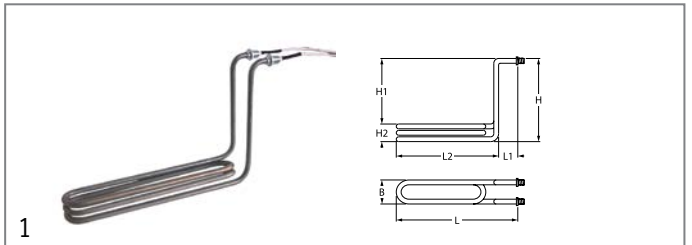



Part No.	415284	Ref. No.	00067 RC00067000
description	heating element 3400W 230V heating circuits 1 L 301mm W 185mm H 185mm 2 hole fixing immersion heater L1 22mm L2 282mm W1 50mm W2 85mm H1 165mm H2 20mm cable length 225mm tube $\varnothing$ 8.5mm thread 1/4" mounting distance 76mm connection length 55mm		
accessories for	415284		
	Part No.	361182	Ref. No.
			—
	nut thread 1/4" H 5mm nickel-plated brass WS 17 Qty 1 pcs		
	Part No.	510417	Ref. No.
			—
	flat gasket fibre ED $\varnothing$ 20mm ID $\varnothing$ 14mm thickness 2mm Qty 1 pcs		
	Part No.	520228	Ref. No.
			—
	tooth lock washer ID $\varnothing$ 15.3mm ED $\varnothing$ 24mm steel Qty 1 pcs for thread M14		
	Part No.	550262	Ref. No.
			—
	flat gasket copper ED $\varnothing$ 20mm ID $\varnothing$ 14mm thickness 2mm		

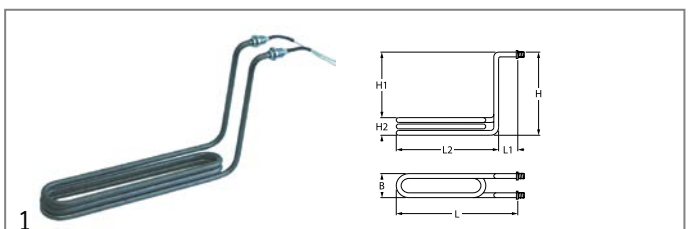

Part No.	415285	Ref. No.	00073 RC00073000
description	heating element 1200W 230V heating circuits 1 L 295mm W 55mm H 185mm L1 20mm L2 275mm H1 154mm H2 31mm thread 1/4" tube $\varnothing$ 8.5mm cable length 290mm 2 hole fixing windings 3		
accessories for	415285		
	Part No.	361182	Ref. No.
			—
	nut thread 1/4" H 5mm nickel-plated brass WS 17 Qty 1 pcs		
	Part No.	510417	Ref. No.
			—
	flat gasket fibre ED $\varnothing$ 20mm ID $\varnothing$ 14mm thickness 2mm Qty 1 pcs		
	Part No.	520228	Ref. No.
			—
	tooth lock washer ID $\varnothing$ 15.3mm ED $\varnothing$ 24mm steel Qty 1 pcs for thread M14		
	Part No.	550262	Ref. No.
			—
	flat gasket copper ED $\varnothing$ 20mm ID $\varnothing$ 14mm thickness 2mm		



Part No.	415286	Ref. No.	00075 RC00075000
description	heating element 1500W 230V heating circuits 1 L 299mm W 50mm H 180mm L1 22mm L2 275mm H1 148mm H2 32mm thread 1/4" tube $\varnothing$ 8.5mm cable length 295mm 2 hole fixing windings 3		
accessories for	415286		
	Part No.	361182	Ref. No.
			—
	nut thread 1/4" H 5mm nickel-plated brass WS 17 Qty 1 pcs		
	Part No.	510417	Ref. No.
			—
	flat gasket fibre ED $\varnothing$ 20mm ID $\varnothing$ 14mm thickness 2mm Qty 1 pcs		
	Part No.	520228	Ref. No.
			—
	tooth lock washer ID $\varnothing$ 15.3mm ED $\varnothing$ 24mm steel Qty 1 pcs for thread M14		
	Part No.	550262	Ref. No.
			—
	flat gasket copper ED $\varnothing$ 20mm ID $\varnothing$ 14mm thickness 2mm		



<b>Part No.</b>	415287	<b>Ref. No.</b>	00142 RC00142000
<b>description</b>	heating element 2000W 230V heating circuits 1 L 298mm W 50mm H 183mm L1 22mm L2 275mm H1 144mm H2 37mm thread 1/4" tube ø 8.5mm cable length 275mm 2 hole fixing windings 3		
<b>accessories for</b>	415287		
	<b>Part No.</b>	361182	<b>Ref. No.</b> —
	nut thread 1/4" H 5mm nickel-plated brass WS 17 Qty 1 pcs		
	<b>Part No.</b>	510417	<b>Ref. No.</b> —
	flat gasket fibre ED ø 20mm ID ø 14mm thickness 2mm Qty 1 pcs		
	<b>Part No.</b>	520228	<b>Ref. No.</b> —
	tooth lock washer ID ø 15.3mm ED ø 24mm steel Qty 1 pcs for thread M14		
	<b>Part No.</b>	550262	<b>Ref. No.</b> —
	flat gasket copper ED ø 20mm ID ø 14mm thickness 2mm		

<b>Part No.</b>	415282	<b>Ref. No.</b>	00049 RC00049000
<b>description</b>	heating element 2200W 230V heating circuits 1 L 295mm W 70mm H 183mm L1 20mm L2 275mm H1 148mm H2 35mm thread 1/4" tube ø 8.5mm cable length 250mm 2 hole fixing fryer heaters windings 3		
<b>accessories for</b>	415282		
	<b>Part No.</b>	361182	<b>Ref. No.</b> —
	nut thread 1/4" H 5mm nickel-plated brass WS 17 Qty 1 pcs		
	<b>Part No.</b>	510417	<b>Ref. No.</b> —
	flat gasket fibre ED ø 20mm ID ø 14mm thickness 2mm Qty 1 pcs		
	<b>Part No.</b>	520228	<b>Ref. No.</b> —
	tooth lock washer ID ø 15.3mm ED ø 24mm steel Qty 1 pcs for thread M14		
	<b>Part No.</b>	550262	<b>Ref. No.</b> —
	flat gasket copper ED ø 20mm ID ø 14mm thickness 2mm		

<b>Part No.</b>	415283	<b>Ref. No.</b>	00054 RC00054000
<b>description</b>	heating element 3000W 230V heating circuits 1 L 290mm W 78mm H 185mm L1 18mm L2 267mm H1 155mm H2 27mm thread 1/4" mounting distance 67mm tube ø 8.5mm cable length 250mm 2 hole fixing connection male faston 6.3mm immersion heater windings 3		
<b>accessories for</b>	415283		
	<b>Part No.</b>	361182	<b>Ref. No.</b> —
	nut thread 1/4" H 5mm nickel-plated brass WS 17 Qty 1 pcs		
	<b>Part No.</b>	510417	<b>Ref. No.</b> —
	flat gasket fibre ED ø 20mm ID ø 14mm thickness 2mm Qty 1 pcs		
	<b>Part No.</b>	520228	<b>Ref. No.</b> —
	tooth lock washer ID ø 15.3mm ED ø 24mm steel Qty 1 pcs for thread M14		
	<b>Part No.</b>	550262	<b>Ref. No.</b> —
	flat gasket copper ED ø 20mm ID ø 14mm thickness 2mm		

heating elements for griddles

<b>Part No.</b>	415290	<b>Ref. No.</b>	00286 RC00286000
<b>description</b>	heating element 1300W 230V heating circuits 1 L 473mm W 80mm H 55mm tube ø 6.5mm connection M4 griddle connection distance 75mm dry heating element		

<b>Part No.</b>	416613	<b>Ref. No.</b>	00767 RC00767000
<b>description</b>	heating element 3000W 230V heating circuits 1 L 474mm W 285mm H 54mm tube ø 8.5mm connection M4 griddle connection distance 277mm dry heating element		

heating elements for chicken rotisseries

<b>Part No.</b>	416657	<b>Ref. No.</b>	00243 RC00243000
<b>description</b>	heating element 1500W 230V 2 hole fixing thread M14x1.25 L 535mm W 49mm heating circuits 1 connection M5 dry heating element tube ø 10mm mounting distance 39mm connection length 55mm chicken rotisserie		







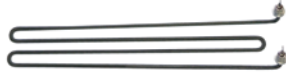

## heating elements for pasta cookers

			
1			
<b>Part No.</b>	416629	<b>Ref. No.</b>	00595 01250 RC00595000 RC01250000
<b>description</b>	heating element 1600W 230V heating circuits 1 L 368mm W 70mm H 178mm connection M4 tube ø 9mm connection length 24mm dry heating element		

## heating elements for chargrills

			
1			
<b>Part No.</b>	416601	<b>Ref. No.</b>	00775 RC00775000
<b>description</b>	heating element 1000W 230V L 396mm W 65mm H 35mm 2 hole fixing mounting distance 87mm connection M4 tube ø 6.5mm immersion heater thread 1/4" heating circuits 1 connection length 26mm		

			
1			
<b>Part No.</b>	415288	<b>Ref. No.</b>	00513 RC00513000
<b>description</b>	heating element 1350W 230V L 396mm W 80mm H 37mm thread 1/4" mounting distance 72mm tube ø 6.3mm connection M4 heating circuits 1 2 hole fixing dry heating element		
<b>accessories for</b>	415288		
	<b>Part No.</b>	361182	<b>Ref. No.</b> —
	nut thread 1/4" H 5mm nickel-plated brass WS 17 Qty 1 pcs		
	<b>Part No.</b>	510417	<b>Ref. No.</b> —
	flat gasket fibre ED ø 20mm ID ø 14mm thickness 2mm Qty 1 pcs		
	<b>Part No.</b>	520228	<b>Ref. No.</b> —
	tooth lock washer ID ø 15.3mm ED ø 24mm steel Qty 1 pcs for thread M14		
	<b>Part No.</b>	550262	<b>Ref. No.</b> —
	flat gasket copper ED ø 20mm ID ø 14mm thickness 2mm		

			
1			
<b>Part No.</b>	416618	<b>Ref. No.</b>	01111 RC01111000
<b>description</b>	heating element 1350W 230V L 450mm W 76mm H 36mm thread 1/4" mounting distance 71mm tube ø 6.3mm connection M4 heating circuits 1 connection length 36mm 2 hole fixing dry heating element		

## heating elements for salamanders/toast-

			
1			
<b>Part No.</b>	420271	<b>Ref. No.</b>	03708 RC00003708
<b>description</b>	heating element 1000W 230V L 215mm W 95mm L1 25mm L2 25mm L3 165mm W1 16mm W2 63mm hole distance 96mm connection M4 tube ø 8.5mm flange length 106mm flange width 32mm heating circuits 1 hole ø 5mm tilt flange dry heating element H 8.5mm		

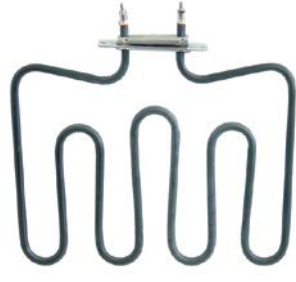
			
1			
<b>Part No.</b>	416653	<b>Ref. No.</b>	03804 RC00003804
<b>description</b>	heating element 2000W 230V L 225mm W 283mm L1 15mm L2 210mm W1 110mm W2 63mm hole distance 96mm connection M4 tube ø 8.5mm flange length 106mm flange width 32mm heating circuits 1 hole ø 5mm tilt flange dry heating element H 8.5mm		

			
1			
<b>Part No.</b>	416654	<b>Ref. No.</b>	03706 RC00003706
<b>description</b>	heating element 2000W 230V L 230mm W 230mm L1 22mm L2 208mm W1 83mm W2 63mm hole distance 96mm tube ø 8.5mm flange length 106mm flange width 32mm heating circuits 1 hole ø 5mm tilt flange dry heating element H 8.5mm		

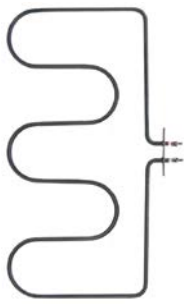
			
1			
<b>Part No.</b>	415280	<b>Ref. No.</b>	00171 RC00171000
<b>description</b>	heating element 1000W 230V heating circuits 1 L 217mm W 424mm L1 19mm L2 203mm W1 195mm W2 30mm flange length 70mm flange width 22mm hole distance 56mm tube ø 6.3mm windings 3 dry heating element connection M4 rectangular flange hole ø 6mm H 6.3mm		

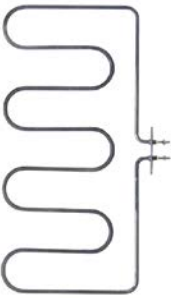
1

<b>Part No.</b>	415279	<b>Ref. No.</b>	RC00000613
<b>description</b>	heating element 1500W 230V heating circuits 1 L 223mm W 430mm L1 12mm L2 211mm W1 200mm W2 30mm flange length 70mm flange width 23mm hole distance 56mm tube ø 6.3mm windings 4 dry heating element connection M4 rectangular flange hole ø 6mm H 6.3mm		

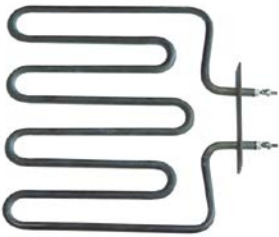

1

<b>Part No.</b>	415621	<b>Ref. No.</b>	03706 RC00003706
<b>description</b>	heating element 2000W 230V heating circuits 1 L 228mm W 230mm L1 29mm L2 228mm W1 84mm W2 62mm flange length 116mm flange width 32mm hole distance 96mm tube ø 8.5mm connection length 17mm dry heating element connection M4 rectangular flange hole ø 5mm H 8.5mm		

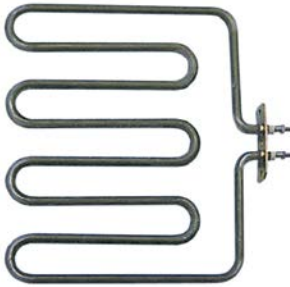

1

<b>Part No.</b>	415622	<b>Ref. No.</b>	00109 RC00000109
<b>description</b>	heating element 2000W 230V heating circuits 1 L 229mm W 255mm L1 17mm L2 212mm W1 112mm W2 32mm flange length 70mm flange width 23mm hole distance 25mm tube ø 8.5mm connection length 20mm dry heating element connection M4 rectangular flange hole ø 5mm H 8.5mm		



1

<b>Part No.</b>	415281	<b>Ref. No.</b>	6000 RC00006000
<b>description</b>	heating element 1000W 230V L 290mm W 130mm 2 hole fixing thread M12x1.25 mounting distance 123mm connection male faston 6.3mm dry heating element tube ø 6.3mm heating circuits 1 H 6.3mm		



1

<b>Part No.</b>	416655	<b>Ref. No.</b>	01029 RC01029000
<b>description</b>	radiation heater rectangular 2000W 230V L 290mm W 240mm heating circuits 1 connections 2 IRCA for salamander grill		

ceramic heaters

245x60mm





1

<b>Part No.</b>	415104	<b>Ref. No.</b>	01098 RC01098000	
<b>description</b>	ceramic emitter 1000W 230V cable beaded cord L 245mm W 60mm H 35mm			
<b>spare parts for</b>	415104			
	<b>Part No.</b>	415109	<b>Ref. No.</b>	—
	spring clip			
<b>accessories for</b>	415104			
	<b>Part No.</b>	415110	<b>Ref. No.</b>	—
	reflector L 245mm W 95mm H 31mm thickness 0.75mm hole ø 15x40mm			



1

<b>Part No.</b>	415103	<b>Ref. No.</b>	00288 RC00288000	
<b>description</b>	ceramic emitter 650W 230V cable beaded cord L 245mm W 60mm H 35mm			
<b>spare parts for</b>	415103			
	<b>Part No.</b>	415109	<b>Ref. No.</b>	—
	spring clip			
<b>accessories for</b>	415103			
	<b>Part No.</b>	415110	<b>Ref. No.</b>	—
	reflector L 245mm W 95mm H 31mm thickness 0.75mm hole ø 15x40mm			



## immersion heating elements

3 hole flange  $\varnothing 47.5\text{mm}$ 

<b>Part No.</b>	419113	<b>Ref. No.</b>	40400038 RC40400038
<b>description</b>	heating element 9000W 230V mounting $\varnothing 47.5\text{mm}$ heating circuits 3 L 550mm W 38mm H 45mm number of thermostat sleeves 1 thermostat sleeves $\varnothing 7.3\text{mm}$ length thermostat sleeves 260mm tube $\varnothing 8.5\text{mm}$ connection M4 3 hole flange immersion heater L1 55mm H1 33mm H2 34mm		

<b>accessories for</b>	419113			
	Part No.	510408	Ref. No.	—

O-ring EPDM thickness 5.34mm ID  $\varnothing 47\text{mm}$  Qty 1 pcs

## heating elements for convection



<b>Part No.</b>	418087	<b>Ref. No.</b>	RCK6002125
<b>description</b>	heating element 15000W 230/400V heating circuits 3 ID $\varnothing 398\text{mm}$ ED $\varnothing 415\text{mm}$ L 452mm H 121mm L1 32mm W1 105mm H1 80mm H2 25mm flange length 142mm flange width 25mm hole distance 126mm connection M4 tube $\varnothing 8.5\text{mm}$ convection heating element hole $\varnothing 6\text{mm}$ rectangular flange		

<b>accessories for</b>	418087			
	Part No.	550548	Ref. No.	RCK2005173

gasket L 144mm W 25.5mm thickness 2.2mm for heating element suitable for GIORIK equiv. no. 2005173



<b>Part No.</b>	415251	<b>Ref. No.</b>	00568 RC00568000
<b>description</b>	heating element 2500W 230V heating circuits 1 ID $\varnothing 178\text{mm}$ ED $\varnothing 190\text{mm}$ L 242mm H 35mm L1 46mm W1 31mm H1 10mm H2 25mm flange length 70mm flange width 22mm hole distance 56mm connection male faston 6.3mm horizontal tube $\varnothing 6.3\text{mm}$ convection heating element hole $\varnothing 5\text{mm}$ rectangular flange		

<b>spare parts for</b>	415251			
	Part No.	510368	Ref. No.	—

gasket L 70mm W 23.5mm hole  $\varnothing 5\text{mm}$  hole distance 56mm FIBER thickness 2mm for heating element



<b>Part No.</b>	418086	<b>Ref. No.</b>	RCK6002001
<b>description</b>	heating element 8400W 230V heating circuits 3 ID $\varnothing 218\text{mm}$ ED $\varnothing 235\text{mm}$ L 275mm H 112mm L1 40mm W1 105mm H1 32mm H2 80mm flange length 142mm flange width 25mm hole distance 64mm connection M4 tube $\varnothing 8.5\text{mm}$ convection heating element hole $\varnothing 6\text{mm}$ rectangular flange		

<b>accessories for</b>	418086			
	Part No.	550548	Ref. No.	RCK2005173

gasket L 144mm W 25.5mm thickness 2.2mm for heating element suitable for GIORIK equiv. no. 2005173

## radiation heaters

square



<b>Part No.</b>	490159	<b>Ref. No.</b>	RC01434000
<b>description</b>	radiation heater L 300mm W 300mm 3500W 230V connections 3 square without pan detection EGO		



<b>spare parts for</b>	490159			
	Part No.	499157	Ref. No.	—

protection pipe for temperature probe ceramic L 297mm ED  $\varnothing 7\text{mm}$  ID  $\varnothing 5\text{mm}$



<b>Part No.</b>	416655	<b>Ref. No.</b>	01029 RC01029000
<b>description</b>	radiation heater rectangular 2000W 230V L 290mm W 240mm heating circuits 1 connections 2 IRCA for salamander grill		



 <p>1</p>			
<b>Part No.</b>	416656	<b>Ref. No.</b>	01030 RC01030000 RC01229000
<b>description</b>	radiation heater rectangular 4000W 230V L 490mm W 245mm heating circuits 2 connections 2+2 IRCA		
<b>spare parts for</b>	416656		
	<b>Part No.</b>	417727	<b>Ref. No.</b> —
	 <p>terminal L 20m W 8.2mm</p>		

1-circuit

 <p>1</p>			
<b>Part No.</b>	490113	<b>Ref. No.</b>	00931 RC00931000
<b>description</b>	radiation heater ø 200mm 1800W 230V heating circuits 1 energy regulation with temperature signalization with ribbon heater connections 2+2 connection type male faston 6.3mm CERAMASPEED		

2-circuit

 <p>1</p>			
<b>Part No.</b>	490118	<b>Ref. No.</b>	00932 RC00932000
<b>description</b>	radiation heater ø 250mm 2500W heating circuits 2 partial power 1000W		

accessories

flange gaskets

 <p>1</p>			
<b>Part No.</b>	550548	<b>Ref. No.</b>	RCK2005173
<b>description</b>	gasket L 144mm W 25.5mm thickness 2.2mm for heating element suitable for GIORIK equiv. no. 2005173		

spring clips

 <p>1</p>			
<b>Part No.</b>	550539	<b>Ref. No.</b>	RC00091000
<b>description</b>	probe clip for pipe ø 8.5mm for probe ø 4mm Qty 1 pcs		

 <p>1</p>			
<b>Part No.</b>	550398	<b>Ref. No.</b>	00333 RC00333000
<b>description</b>	probe spring for pipe ø 2x8.5mm for probe ø 4mm L 42mm W 11mm Qty 1 pcs		

hot plates

square & rectangular

with radiused edge

 <p>1</p>			
<b>Part No.</b>	490066 <sup>1</sup>	<b>Ref. No.</b>	01110 RC01110000
<b>description</b>	hot plate dimensions 220x220mm 2600W 230V with spill ring connection 4 screw clamps protector yes square		

<sup>1</sup>incl. protector





round

with radiused edge

for domestic and commercial kitchens

E-G-O



1

<b>Part No.</b>	490012	<b>Ref. No.</b>	00764 RC00764000
<b>description</b>	hot plate ø 145mm 1500W 230V connection 4 screw clamps with 8mm spill ring		

E-G-O



1

<b>Part No.</b>	490016	<b>Ref. No.</b>	00290 RC00290000
<b>description</b>	hot plate ø 180mm 2000W 230V connection 4 screw clamps with 8mm spill ring		



1

<b>Part No.</b>	490020	<b>Ref. No.</b>	01107 RC01107000
<b>description</b>	hot plate ø 220mm 2600W 230V connection 4 screw clamps with 8mm spill ring		
<b>accessories for</b>	490020		
	<b>Part No.</b>	550796	<b>Ref. No.</b> —
	fixing plate for hot plate ø220mm		

## energy regulators

EGO

1-circuit

E-G-O



1

<b>Part No.</b>	380015	<b>Ref. No.</b>	00012 00937 06501 RC00006501 RC00012000 RC00937000
<b>description</b>	energy regulator 230V 13A single-circuit turn direction right shaft ø 6x4.6mm shaft L 23mm mounting thread M4 power release 6-100% no. 50.57021.010		

2-circuit

E-G-O



1

<b>Part No.</b>	380027	<b>Ref. No.</b>	00938 RC00938000
<b>description</b>	energy regulator EGO 230V 13A dual circuit turn direction right shaft ø 6x4.6mm shaft L 23mm mounting thread M4 power release 6-70% no. 50.55021.100		

## thermostats

control and safety thermostats

EGO

control thermostats

55.10/19\_ series

E-G-O



1

<b>Part No.</b>	375309	<b>Ref. No.</b>	00038 00779 RC00038000 RC00779000
<b>description</b>	thermostat t.max. 180°C temperature range 95-180°C 1-pole 1NO 16A probe ø 6mm probe L 130mm capillary pipe 1500mm capillary pipe isolated 1100mm gland nut shaft L 23mm shaft position upper rotation 270°		

E-G-O



1

<b>Part No.</b>	375327	<b>Ref. No.</b>	00769 RC00769000
<b>description</b>	thermostat t.max. 297°C temperature range 58-297°C 1-pole 1NO 16A probe ø 3.03mm probe L 219mm capillary pipe 870mm capillary pipe isolatedmm gland nut shaft L 23mm shaft position upper rotation 270°		



<b>Part No.</b>	375002	<b>Ref. No.</b>	00569 RC00569000
<b>description</b>	thermostat t.max. 320°C temperature range 55-320°C 1-pole 1NO 16A probe ø 3.1mm probe L 226mm capillary pipe 870mm capillary pipe isolated 850mm gland nut shaft L 23mm shaft position upper rotation 270°		



<b>Part No.</b>	375143	<b>Ref. No.</b>	00274 RC00274000
<b>description</b>	thermostat t.max. 110°C temperature range 32-110°C 3-pole 3NO 16A probe ø 6mm probe L 138mm capillary pipe 1480mm capillary pipe isolated 1100mm gland nut M9x1 shaft ø 6x4.6mm shaft L 23mm shaft position upper rotation 270°		



<b>Part No.</b>	375437	<b>Ref. No.</b>	RC40100042
<b>description</b>	thermostat t.max. 324°C temperature range 66-324°C 1-pole 1NO 16A probe ø 4mm probe L 124mm capillary pipe 1470mm capillary pipe isolated 850mm gland nut shaft ø 6x4.6mm shaft L 23mm shaft position upper rotation 270°		



<b>Part No.</b>	375256	<b>Ref. No.</b>	00064 RC00064000
<b>description</b>	thermostat t.max. 175°C temperature range 100-175°C 3-pole 3NO 16A probe ø 4mm probe L 157mm capillary pipe 850mm capillary pipe isolated 350mm gland nut shaft ø 6x4.6mm shaft L 23mm shaft position upper rotation 270°		

55.34\_series



<b>Part No.</b>	375630	<b>Ref. No.</b>	1207 RC00001207
<b>description</b>	thermostat t.max. 110°C temperature range 30-110°C 3-pole 3NO 16A probe ø 6mm probe L 131mm capillary pipe 900mm capillary pipe isolated 1000mm gland nut M9x1 shaft ø 6x4.6mm shaft L 23mm shaft position upper rotation 318°		



<b>Part No.</b>	390056	<b>Ref. No.</b>	00281 RC00281000
<b>description</b>	thermostat t.max. 185°C temperature range 100-185°C 3-pole 3NO 16A probe ø 4mm probe L 231mm capillary pipe 2600mm capillary pipe isolated 1000mm gland nut shaft ø 6x4.6mm shaft L 23mm shaft position upper rotation 270°		

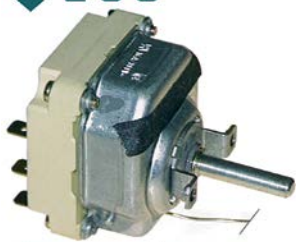

<b>Part No.</b>	375183	<b>Ref. No.</b>	00285 RC00285000
<b>description</b>	thermostat t.max. 298°C temperature range 50-298°C 3-pole 3NO 16A probe ø 3mm probe L 219mm capillary pipe 900mm capillary pipe isolatedmm gland nut shaft ø 6x4.6mm shaft L 23mm shaft position upper rotation 318°		

safety thermostats

55.10/19\_ series

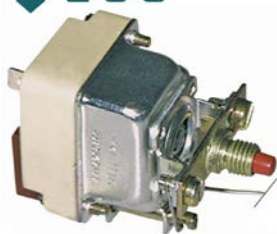

<b>Part No.</b>	375254	<b>Ref. No.</b>	00031 RC00031000
<b>description</b>	safety thermostat 1-pole capillary pipe isolatedmm gland nut switchoff temp. 295°C probe		

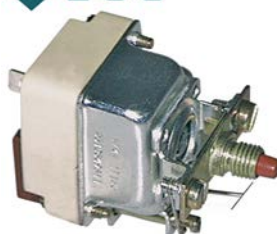

<b>Part No.</b>	375250	<b>Ref. No.</b>	00427 RC00427000
<b>description</b>	safety thermostat capillary pipe 870mm probe ø 6mm 1-pole probe L 129mm 16A capillary pipe isolatedmm gland nut switch-off temp. 130°C probe SS		

spare parts for 375250

	<b>Part No.</b>	551083	<b>Ref. No.</b>	—
cap for safety thermostat thread M8x1				

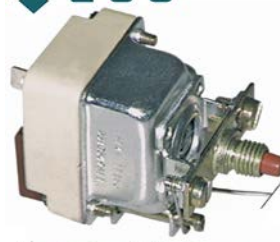

<b>Part No.</b>	390060	<b>Ref. No.</b>	00450 RC00450000
-----------------	--------	-----------------	---------------------

**description** safety thermostat switch-off temp. 230°C 1-pole 0.5A probe SS probe ø 6mm probe L 77mm capillary pipe 870mm capillary pipe isolatedmm gland nut

accessories for 390060

	<b>Part No.</b>	551083	<b>Ref. No.</b>	—
cap for safety thermostat thread M8x1				

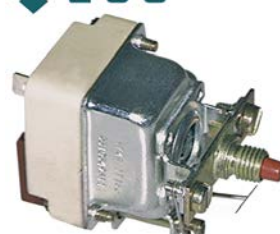

<b>Part No.</b>	390786	<b>Ref. No.</b>	RC00770000
<b>description</b>	safety thermostat switch-off temp. 360°C 1-pole 16A probe ø 4mm probe L 128mm capillary pipe 1170mm capillary pipe isolated 990mm gland nut probe		

55.32\_ series



<b>Part No.</b>	375328	<b>Ref. No.</b>	1007 RC00001007
-----------------	--------	-----------------	--------------------

**description** safety thermostat switch-off temp. 162°C 3-pole 20A probe ø 6mm probe L 77mm capillary pipe 900mm capillary pipe isolatedmm gland nut probe



<b>Part No.</b>	375340	<b>Ref. No.</b>	00031 00063 RC00031000 RC00063000
<b>description</b>	safety thermostat switch-off temp. 295°C 3-pole 20A probe ø 4mm probe L 120mm capillary pipe 1800mm capillary pipe isolated 800mm gland nut probe material SS		



<b>Part No.</b>	390142	<b>Ref. No.</b>	00305 RC00305000
<b>description</b>	safety thermostat switch-off temp. 360°C 3-pole 20A probe ø 3.1mm probe L 188mm capillary pipe 1490mm capillary pipe isolated 800mm gland nut probe SS		

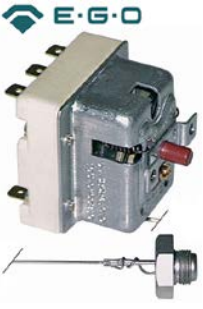

<b>Part No.</b>	375220	<b>Ref. No.</b>	00238 RC00238000
<b>description</b>	safety thermostat switch-off temp. 330°C 3-pole 20A probe ø 11mm probe L 18.5mm capillary pipe 900mm capillary pipe isolated 900mm gland nut probe screw-in probe probe thread M14x1		

### accessories

#### probe clips

#### spring clips

#### for thermostat



<b>Part No.</b>	550398	<b>Ref. No.</b>	00333 RC00333000
<b>description</b>	probe spring for pipe ø 2x8.5mm for probe ø 4mm L 42mm W 11mm Qty 1 pcs		



<b>Part No.</b>	375628	<b>Ref. No.</b>	RCK6010008
<b>description</b>	safety thermostat switch-off temp. 350°C 3-pole 20A probe ø 4mm probe L 120mm capillary pipe 900mm capillary pipe isolated 670mm gland nut M10x1 probe SS		

#### for safety thermostat





<b>Part No.</b>	550539	<b>Ref. No.</b>	RC00091000
<b>description</b>	probe clip for pipe ø 8.5mm for probe ø 4mm Qty 1 pcs		

## switches and momentary switches

### rocker/momentary rocker switches

#### 30x22mm



<b>Part No.</b>	301003	<b>Ref. No.</b>	00021 04702 RC00004702 RC00021000
<b>description</b>	rocker switch mounting measurements 30x22mm green 2NO 250V 16A illuminated 0-I connection male faston 6.3mm ambient temperature max. 125/55°C protection IP65		
<b>accessories for</b>	301003		
	<b>Part No.</b>	301036	<b>Ref. No.</b> —
	protective cover internal size 30x22mm for rocker switch mounting measurementsmm		



## push/momentary push switches

ø16mm



1

<b>Part No.</b>	346346	<b>Ref. No.</b>	RCK6032038
<b>description</b>	momentary push switch mounting ø 16mm red 1NO/indicator light 250V 3A connection male faston 2.8mm ambient temperature max. 125/55°C protection IP40		

## microswitches

lever actuated



1

<b>Part No.</b>	345107	<b>Ref. No.</b>	00204 RC00204000
<b>description</b>	microswitch with lever 250V 16A 1CO connection male faston 6.3mm L 98mm ambient temperature max. 125°C mounting distance 22mm actuating force: 30g lever length 90mm		

pin-plunger actuated



1

<b>Part No.</b>	300092	<b>Ref. No.</b>	00092 RC00092000
<b>description</b>	microswitch with plunger 400V 16A 2NO connection male faston 6.3mm ambient temperature max. 85°C mounting distance 22mm type XTD22A21 actuating force: 150g fryer black		



1

<b>Part No.</b>	345285	<b>Ref. No.</b>	00283 RC7804 n.änd. RC00283000
<b>description</b>	microswitch with plunger 400V 16A 2NO connection male faston 6.3mm ambient temperature max. 85°C mounting distance 22mm type XTD22J actuating force: 400g black		

M10



1

<b>Part No.</b>	347216	<b>Ref. No.</b>	RC01853000
<b>description</b>	microswitch with plunger thread M10x0.75 thread L 14mm 250V 10A 1CO connection male faston 6.3mm stroke 7.5mm mounting distance 22mm L 28mm ambient temperature max. 125°C type NR6K5 actuating force: 260g		



1

<b>Part No.</b>	346347	<b>Ref. No.</b>	RCK6043088
<b>description</b>	microswitch with plunger thread M10x0.75 thread L 14mm 250V 6A 2NO connection male faston 6.3mm stroke 4mm mounting distance 22mm ambient temperature max. 85°C actuating force: 100g		

## cam switches

on/off



1

<b>Part No.</b>	300129	<b>Ref. No.</b>	RCK6030007
<b>description</b>	cam switch 2 operating positions 2NO sequence 0-1 16A shaft ø 6x4.6mm shaft L 23mm connection male faston 6.3mm ceramic		

7-position



1

<b>Part No.</b>	300004	<b>Ref. No.</b>	00291 RC00291000
<b>description</b>	cam switch 7 operating positions 1NO/2CO sequence 0-1-2-3-4-5-6 16A shaft ø 6x4.6mm shaft L 23mm connection male faston 6.3mm 7-position ceramic		



1

<b>Part No.</b>	300106	<b>Ref. No.</b>	RC01482000
<b>description</b>	cam switch 7 operating positions 1NO/2CO sequence 0-1-2-3-4-5-6 32A shaft ø 6x4.6mm shaft L 23mm connection screw 7-position shaft flat upper		



4 operating positions



1

<b>Part No.</b>	345765	<b>Ref. No.</b>	01071 RC01071000
<b>description</b>	cam switch 4 operating positions 8NO sequence 0-1-2-3 16A shaft ø 6x4.6mm shaft L 23mm connection male faston 6.3mm plastic		

with potentiometer



1

<b>Part No.</b>	345636	<b>Ref. No.</b>	01028 RC01028000
<b>description</b>	cam switch 2 operating positions 4NO sequence 0-1 16A shaft ø 6x4.6mm shaft L 23mm connection cable 560mm 0.1-10KOhm with potentiometer		

operation switches



1

<b>Part No.</b>	300002	<b>Ref. No.</b>	00070 RC00070000
<b>description</b>	cam switch 2 operating positions 4NO 16A sequence 0-1 shaft ø 6x4.6mm shaft L 23mm connection male faston 6.3mm ceramic		



1

<b>Part No.</b>	300080	<b>Ref. No.</b>	RC40100006
<b>description</b>	cam switch 2 operating positions 4NO 16A sequence 0-1 shaft ø 6x4.6mm shaft L 23mm connection screw operation switch ceramic ambient temperature max. 150°C		
<b>accessories for</b>	300080		
	<b>Part No.</b>	<b>Ref. No.</b>	—
	551456		
	gasket for switch ED ø 14mm ID ø 2.5mm thickness 3.5mm white		



1

<b>Part No.</b>	300200	<b>Ref. No.</b>	00037 RC00037000
<b>description</b>	operation switch 2 operating positions 2NO 16A sequence 0-1 shaft ø 6x4.6mm shaft L 23mm connection male faston 6.3mm operation switch ceramic		

rotary switches

BREMAS

A1600 series



1

<b>Part No.</b>	346341	<b>Ref. No.</b>	RCK6030030
<b>description</b>	rotary switch 8 1-2-3-4-5-6-7-8 sets of contacts 10 type CS0169134 400V 16A shaft ø 4x5mm shaft L 20mm shaft square connection screw		

control equipment

GENERAL ELECTRIC (AEG)

push buttons



1

<b>Part No.</b>	346854	<b>Ref. No.</b>	RC00004811
<b>description</b>	push button mounting measurements ø22mm green		

encoders and potentiometers

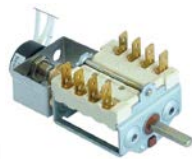

1

<b>Part No.</b>	345636	<b>Ref. No.</b>	01028 RC01028000
<b>description</b>	cam switch 2 operating positions 4NO sequence 0-1 16A shaft ø 6x4.6mm shaft L 23mm connection cable 560mm 0.1-10KOhm with potentiometer		

1 electric components







			
1			
<b>Part No.</b>	300187	<b>Ref. No.</b>	RCK6010097
<b>description</b>	potentiometer 4.7KOhm rotation 310° shaft ø 0.6x4.5mm shaft L 20mm cable length 650mm		

## lamps

## indicator lights

indicator light lenses			
ø10mm (type SRZ-3)			
			
1			
<b>Part No.</b>	359228	<b>Ref. No.</b>	RC01783000
<b>description</b>	indicator light housings mounting measurements ø10mm clear round Qty 1 pcs		

			
1			
<b>Part No.</b>	359123	<b>Ref. No.</b>	00053 RC00053000
<b>description</b>	indicator light housings mounting measurements ø10mm green round Qty 1 pcs		
<b>accessories for</b>	359123		
	<b>Part No.</b>	359132	<b>Ref. No.</b> 00052 RC01782000
	indicator lamp green 250V connection male faston 6.3mm protection IP54 ambient temperature max. 85°C		

			
1			
<b>Part No.</b>	359124	<b>Ref. No.</b>	00319 RC00319000
<b>description</b>	indicator light housings mounting measurements ø10mm yellow round Qty 1 pcs		
<b>accessories for</b>	359124		
	<b>Part No.</b>	359132	<b>Ref. No.</b> 00052 RC01782000
	indicator lamp green 250V connection male faston 6.3mm protection IP54 ambient temperature max. 85°C		

indicator lamps for socket type SRZ / SDK / SDY / SFK			
			
1			
<b>Part No.</b>	359130	<b>Ref. No.</b>	RC00052000
<b>description</b>	indicator lamp 230V clear connection male faston 6.3mm ø 8mm		

			
1			
<b>Part No.</b>	359132	<b>Ref. No.</b>	00052 RC01782000
<b>description</b>	indicator lamp green 250V connection male faston 6.3mm protection IP54 ambient temperature max. 85°C		

indicator lights (complete)			
ø 6mm			
			
1			
<b>Part No.</b>	357084	<b>Ref. No.</b>	RC00006601
<b>description</b>	indicator lamp ø 6mm 240V green		

			
1			
<b>Part No.</b>	359031	<b>Ref. No.</b>	00011 RC00011000
<b>description</b>	indicator light ø 6mm 230V green		

ø12mm			
with screw socket			
			
1			
<b>Part No.</b>	359048	<b>Ref. No.</b>	RC40200150
<b>description</b>	indicator light ø 12mm 230V yellow connection male faston 6.3mm		

## screw-on/push-on fit

light bulbs			
for ovens			
			
1			
<b>Part No.</b>	359610	<b>Ref. No.</b>	00566 RC00566000
<b>description</b>	light bulb t.max. 300°C socket E14 15W 230V ø 22mm L 47mm lens L 20mm for oven lamp type Philips		



halogen lamp

for socket G4 / G6.35 / G9

1 

<b>Part No.</b>	357191	<b>Ref. No.</b>	RCE00C4396
<b>description</b>	halogen lamp socket G4 12V 10W temp.-resist. 300°C OSRAM HALOSTAR OVEN		

1 

<b>Part No.</b>	359599	<b>Ref. No.</b>	RCK6061054
<b>description</b>	halogen lamp socket G4 12V 20W temp.-resist. 500°C		

1 

<b>Part No.</b>	359946	<b>Ref. No.</b>	RC01856000
<b>description</b>	halogen lamp socket G9 230V 40W temp.-resist. 300°C		

linear lamps

infrared lamps

with base type X lug

1 

<b>Part No.</b>	359617	<b>Ref. No.</b>	00217 RC00217000
<b>description</b>	infrared lamp 1000W 220V L 365mm lens L 340mm total length 480mm with mounting strap		

sockets for linear lamps

X lug

1 



<b>Part No.</b>	359710	<b>Ref. No.</b>	00218 RC00218000
<b>description</b>	lamp socket L 70mm W 70mm H 49mm mounting distance 50mm bracket mounting		

oven lamps

universal oven lamps

mounting diameter 35.5mm

1 

<b>Part No.</b>	359718	<b>Ref. No.</b>	00805 RC00805000	
<b>description</b>	oven lamp mounting ø 35.5mm 230V 15W socket E14 temp.-resist. 300°C connection male faston 6.3mm hard glas			
<b>spare parts for</b>	359718			
	<b>Part No.</b>	359701	<b>Ref. No.</b>	—
	lamp socket socket E14 220-230V mounting ø 35.5mm connection male faston 6.3mm 15W			
	<b>Part No.</b>	359740	<b>Ref. No.</b>	—
	light bulb t.max. 300°C socket E14 15W 230V ø 22mm L 48mm lens L 20mm for oven lamp IMPORT			

30x70mm

1 

<b>Part No.</b>	359338	<b>Ref. No.</b>	RCK6063077
<b>description</b>	lamp glass		

1 

<b>Part No.</b>	359337	<b>Ref. No.</b>	RCK6063075	
<b>description</b>	oven lamp socket G4 cable length 800mm connection Faston 6.3mm L 70mm W 29mm			
<b>accessories for</b>	359337			
	<b>Part No.</b>	359599	<b>Ref. No.</b>	RCK6061054
	halogen lamp socket G4 12V 20W temp.-resist. 500°C			

55x70mm

1 

<b>Part No.</b>	359659	<b>Ref. No.</b>	00275 RC00275000
<b>description</b>	oven lamp complete 230V 25W socket E14 L 70mm W 55mm mounting measurements 55x70mm temp.-resist. 300°C connection male faston 6.3mm		





			
1			
<b>Part No.</b>	359299	<b>Ref. No.</b>	RC02027000
<b>description</b>	gasket L 91mm W 77mm hole ø 3mm for oven lamp		

## lamps

## light bulbs

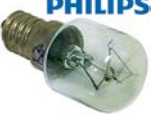
			
1			
<b>Part No.</b>	359610	<b>Ref. No.</b>	00566 RC00566000
<b>description</b>	light bulb t.max. 300°C socket E14 15W 230V ø 22mm L 47mm lens L 20mm for oven lamp type Philips		

## halogen lamps

## for socket G4 / G6.35 / G9

			
1			
<b>Part No.</b>	357191	<b>Ref. No.</b>	RCE00C4396
<b>description</b>	halogen lamp socket G4 12V 10W temp.-resist. 300°C OSRAM HALOSTAR OVEN		

			
1			
<b>Part No.</b>	359599	<b>Ref. No.</b>	RCK6061054
<b>description</b>	halogen lamp socket G4 12V 20W temp.-resist. 500°C		

			
1			
<b>Part No.</b>	359946	<b>Ref. No.</b>	RC01856000
<b>description</b>	halogen lamp socket G9 230V 40W temp.-resist. 300°C		



## timers

## electric timers

## with time spread

			
1			
<b>Part No.</b>	350074	<b>Ref. No.</b>	RCK6032047
<b>description</b>	timer MS65 operation time 120min time spread 30min 1CO/2NO/1NC at 250V 16A permanent position yes impulse electric shaft ø 6x4.6mm shaft L 22mm mounting distance 28mm connection lateral Invensys 4-pole shaft position lower°		

## mechanical timers

			
1			
<b>Part No.</b>	350032	<b>Ref. No.</b>	00022 00713 RC00000713 RC00022000
<b>description</b>	timer M2 2-pole operation time 15min impulse mechanical 2NO at 250V 16A permanent position no shaft ø 6x4.6mm shaft 6x4.6mm shaft L 18mm mounting distance 28mm connection rear		
<b>accessories for</b>	350032		
	<b>Part No.</b>	110366	<b>Ref. No.</b> —
	knob switch zero mark t.max.°C ø 44mm shaft ø 6x4.6mm shaft flat upper black		
	<b>Part No.</b>	110371	<b>Ref. No.</b> —
	dial plate graduation 15min permanent position no rotation 30-330° ø 60mm timers knob ø 45mm		

			
1			
<b>Part No.</b>	350049	<b>Ref. No.</b>	RC01261000
<b>description</b>	timer M2 with bell 2-pole operation time 30min impulse mechanical 2NO at 250V 16A permanent position yes shaft ø 6x4.6mm shaft 6x4.6mm shaft L 23mm mounting distance 28mm connection lateral		
<b>accessories for</b>	350049		
	<b>Part No.</b>	110366	<b>Ref. No.</b> —
	knob switch zero mark t.max.°C ø 44mm shaft ø 6x4.6mm shaft flat upper black		
	<b>Part No.</b>	111205	<b>Ref. No.</b> —
	dial plate graduation 30min permanent position yes rotation 30-300° ø 60mm		



			
1			
<b>Part No.</b>	350040	<b>Ref. No.</b>	RC00576000
<b>description</b>	timer M2 with bell 2-pole operation time 60min impulse mechanical 2NO at 250V 16A permanent position yes shaft ø 6x4.6mm shaft 6x4.6mm shaft L 23mm mounting distance 28mm connection lateral		
<b>accessories for</b>	350040		
	<b>Part No.</b>	110366	<b>Ref. No.</b> —
	knob switch zero mark t.max. °C ø 44mm shaft ø 6x4.6mm shaft flat upper black		
	<b>Part No.</b>	111202	<b>Ref. No.</b> —
	dial plate graduation 60min permanent position yes rotation 0-300° ø 60mm timers knob ø 45mm with permanent position		

audible timers

			
1			
<b>Part No.</b>	350036	<b>Ref. No.</b>	00570 RC00570000
<b>description</b>	audible timer operation time 60min ø 55mm shaft ø 6x4.6mm shaft L 22mm mounting distance 28mm		

alarm devices

buzzers



			
1			
<b>Part No.</b>	350080	<b>Ref. No.</b>	RCK6010103
<b>description</b>	buzzer buzzer		

contactors

ISKRA (FANAL)

power contactors

			
1			
<b>Part No.</b>	380204	<b>Ref. No.</b>	00938 06208 RC00006208 RC00938000
<b>description</b>	power contactor resistive load 25A 230VAC (AC3/400V) 9A/4kW main contacts 3NO auxiliary contacts 1NO connection screw connection type Fanal DSL9 10 type ISKRA KNL9 10		

			
1			
<b>Part No.</b>	380424	<b>Ref. No.</b>	RCK6046041
<b>description</b>	power contactor resistive load 35A 230VAC (AC3/400V) 32A/15kW main contacts 3NO connection screw connection type Fanal DSL30 type ISKRA KNL30		
<b>accessories for</b>	380424		
	<b>Part No.</b>	381378	<b>Ref. No.</b> —
	overload switch connection screw setting range 24,5-30A for contactors KNL30 type BR30 24.5-30A		

miscellaneous

overload switches

			
1			
<b>Part No.</b>	380373	<b>Ref. No.</b>	00239 RC00239000
<b>description</b>	overload switch		



## relays

## power relays

## with bracket mounting



1

<b>Part No.</b>	380403	<b>Ref. No.</b>	00774 01213 RC00001213 RC00774000
<b>description</b>	power relays FINDER 230VAC 16A 3CO connection F6.3 bracket mounting manuf. no. 62.83.8.230.0500		

## time relays

## time relays



1

<b>Part No.</b>	381119	<b>Ref. No.</b>	RCK6042049
<b>description</b>	time relay LOVATO TM D time range 0.06-180s		



1

<b>Part No.</b>	380607	<b>Ref. No.</b>	RCK6042054
<b>description</b>	time relay LOVATO TM M1 time range 0s-10 days 12-24V AC/DC 8A 1CO connection grip connection		



1

<b>Part No.</b>	380606	<b>Ref. No.</b>	RCK6042056
<b>description</b>	time relay LOVATO TM PL time range 2x 0.1s-100 days 12-240V AC/DC 8A 1CO connection grip connection		

## transformers

## for lighting



1

<b>Part No.</b>	401175	<b>Ref. No.</b>	RCK6041065
<b>description</b>	transformer primary 230V secondary 11.5V 90VA		

## probes

## universal probes

## temperature probes



1

<b>Part No.</b>	379860	<b>Ref. No.</b>	RCK6000100
<b>description</b>	temperature probe NTC 10kOhm cable PVC probe -20 up to +80°C cable -10 up to 100°C probe ø6x40mm cable length 1.5m without screw connection 2-wire		



1

<b>Part No.</b>	379222 <sup>1</sup>	<b>Ref. No.</b>	RCK6000083
<b>description</b>	temperature probe Pt100 cable Vetrotex probe -200 up to +600°C cable -50 up to +350°C probe ø4x110mm cable length 1.4m 3-wire		

<sup>1</sup>3-wire

## electronics

## PCBs

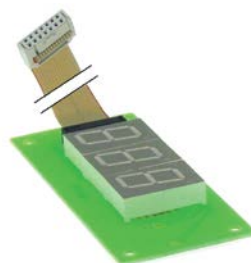

1

<b>Part No.</b>	401166	<b>Ref. No.</b>	RCK6010095
<b>description</b>	display		



1

<b>Part No.</b>	400952	<b>Ref. No.</b>	01014 RC01014000
<b>description</b>	PCB		

1

<b>Part No.</b>	400953	<b>Ref. No.</b>	01015 RC01015000
<b>description</b>	PCB		



1

<b>Part No.</b>	401171	<b>Ref. No.</b>	RCK6010084
<b>description</b>	PCB combi-steamer		



1

<b>Part No.</b>	401172	<b>Ref. No.</b>	RCK6010093
<b>description</b>	PCB combi-steamer VE 06/10		



1

<b>Part No.</b>	401167	<b>Ref. No.</b>	RCK6010096
<b>description</b>	PCB combi-steamer VE 06/10 230V 50/60Hz		
<b>accessories for</b>	401167		
	<b>Part No.</b>	<b>Ref. No.</b>	—
	401062		
	buzzer board 230VAC L 48mm W 45mm connection Faston 6.3mm		

## keypads

### front foils



1

<b>Part No.</b>	693150	<b>Ref. No.</b>	01016 RC01016000
<b>description</b>	keypad foil salamander grill QSE40		



1

<b>Part No.</b>	693151	<b>Ref. No.</b>	01017 RC01017000
<b>description</b>	keypad foil salamander grill QSE60		

## solenoid valves

### solenoid valves (water)

#### RPE



1

<b>Part No.</b>	374017	<b>Ref. No.</b>	RCK6042070
<b>description</b>	solenoid valve single straight 230VAC inlet 3/4" outlet 10mm input 6l/min DN10 RPE polyamide flow regulating valve inlet white membranes NBR pressure range 0.2-10bar		

#### JOHN GUEST



1

<b>Part No.</b>	370768 <sup>1</sup>	<b>Ref. No.</b>	RC01964000
<b>description</b>	solenoid valve single straight 230VAC inlet 3/4" outlet 10mm input/min output/min DN10 t.max. 90°C duty cycle 100% RPE		

<sup>1</sup>cylindrical outlet



## pressure switches

for steam control



1

<b>Part No.</b>	541074	<b>Ref. No.</b>	RC01842000
<b>description</b>	pressure control $\varnothing$ 45mm triggering pressure 0.5bar reset pressure 0.35bar pressure connection vertical steam control pressure range 0.35/0.51bar connection 1/8" pressure connection 1/8"		

## fans

axial fans

import



1

<b>Part No.</b>	601604 <sup>1</sup>	<b>Ref. No.</b>	RC01863000
<b>description</b>	axial fan L 119mm W 119mm H 38mm 230VAC 50/60Hz 17/15W bearing slide bearing manuf. no. AA1282HS-AT connection cable 300mm fan wheel $\varnothing$ 110mm temp.-resist. 70°C input current 0.1A airflow 130m <sup>3</sup> /h 2600rpm		

<sup>1</sup>with slide bearings

hot air motors



1

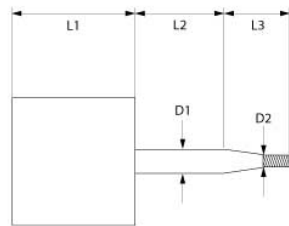

<b>Part No.</b>	500640	<b>Ref. No.</b>	RCK6032122
<b>description</b>	fan motor 220-240V 1 phase 50Hz 0.05/0.25HP 1400/2700rpm speeds 2 L1 145mm L2 65mm L3 35mm D1 $\varnothing$ 15mm D2 $\varnothing$ 12mm M10L ET 1.1/0.55A suitable capacitor 12.5 $\mu$ F/450V at 50Hz 1400/2700rpm type 2758D2253 no. 6032122		
<b>spare parts for</b>	500640		
	<b>Part No.</b>	560280	<b>Ref. No.</b> —
	nut thread M10L H 8mm WS 17 SS DIN/ISO DIN 934 / ISO 4032/8673 Qty 1 pcs		



1

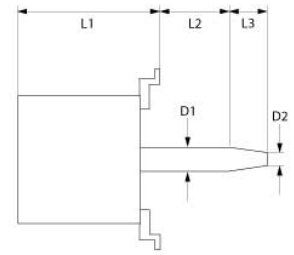

<b>Part No.</b>	500642	<b>Ref. No.</b>	RCK6033145
<b>description</b>	fan motor 380-415V 3 phase 50Hz 0.22/0.75kW 700/1400rpm speeds 2 L1 166mm L2 45mm L3 67mm D1 $\varnothing$ 24mm D2 $\varnothing$ 20mm M6R ITA at 50Hz 380-415V at 50Hz 700/1400rpm type FB80 4/8 no. 629764		



1

<b>Part No.</b>	601202	<b>Ref. No.</b>	RCK5901006
<b>description</b>	fan wheel D1 $\varnothing$ 180mm H1 100mm blades 16 D2 $\varnothing$ 11.5mm D3 $\varnothing$ 16mm H2 30mm		



1

<b>Part No.</b>	601203	<b>Ref. No.</b>	RCK5901010
<b>description</b>	fan wheel D1 $\varnothing$ 310mm H1 100mm blades 30 D2 $\varnothing$ 19.5mm D3 $\varnothing$ 23mm H2 46mm		

hot air fans

ebm-papst



1

<b>Part No.</b>	601103	<b>Ref. No.</b>	00229 RC00229000
<b>description</b>	radial fan 230V 47W L1 60mm L2 26mm L3 20mm L4 157mm fan wheel $\varnothing$ 150mm type G2S150-AB08-44		





miscellaneous

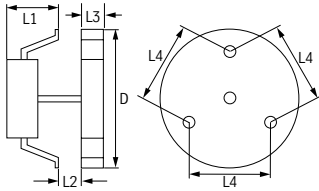

1





<b>Part No.</b>	601011	<b>Ref. No.</b>	00565 RC00565000
<b>description</b>	hot air fan 220-240V 40W 50/60Hz L1 65mm L2 15mm L3 25mm L4 87mm fan wheel ø 150mm FIME type C25R8023CLH		
<b>accessories for</b>	601011		
	<b>Part No.</b>	550879	<b>Ref. No.</b> —
	insulation ø 130mm thickness 3mm hole ø 20mm for hot air fan		
	<b>Part No.</b>	601260	<b>Ref. No.</b> —
	nut thread M6L IT for hot air fan		

pumps

vibration pumps



1

<b>Part No.</b>	500568	<b>Ref. No.</b>	RC01969000
<b>description</b>	vibration pump 230V 32W 50Hz inlet ø 7 outlet ø 1/8" IT CEME type E512/A32		
<b>spare parts for</b>	500568		
	<b>Part No.</b>	390698	<b>Ref. No.</b> —
	thermal fuse switch-off temp. 110°C suitable for ULKA pump		
	<b>Part No.</b>	520153	<b>Ref. No.</b> —
	bracket rubber dimensions 53x34x28mm		

condensators & interference suppression filters

operating capacitors

plastic



1

<b>Part No.</b>	365014	<b>Ref. No.</b>	LF3068081 RCK2013001
<b>description</b>	operating capacitor capacity 12.5µF 450V tolerance 5%Hz ambient temperature max. -25 to +85°C ø 35mm L 70mm M8 plastic connection male faston 6.3mm 45S.C3DS.12.5 protection		

filters

interference suppression filters



1

<b>Part No.</b>	365044	<b>Ref. No.</b>	RCK6090050
<b>description</b>	interference suppression filter type FC701Y2F 250V 50-60Hz conductor 2 with E connection cable 200mm L 42mm ø 23mm Hmm Wmm plastic Qty 1 pcs		

fuses

fine fuses



1

<b>Part No.</b>	358677	<b>Ref. No.</b>	RC01861000
<b>description</b>	fine fuse size ø5x20mm 4A fast-acting rated 250V Qty 10 pcs		

electric accessories

cables

accessories

cable glands

threaded cable glands

screw connections



1

<b>Part No.</b>	550571	<b>Ref. No.</b>	RC00241000
<b>description</b>	cable gland thread PG16 cable ø 12.0-14.0mm mounting ø 21.5mm nickel-plated brass Qty 1 pcs		



## terminals

## connection terminals with screw/faston connections



1

<b>Part No.</b>	550977 <sup>1</sup>	<b>Ref. No.</b>	RC00194000
<b>description</b>	power terminal block 6-pole max. 40A max 450V connection $\varnothing 6\text{mm}^2$ / F6.3 temp.-resist. 150°C cross section 6mm <sup>2</sup> with ground lug		

<sup>1</sup>with ground lug









## gas taps





## PEL

## 21S series



1

<b>Part No.</b>	101095	<b>Ref. No.</b>	50014 RC05001400
<b>description</b>	gas tap PEL type 21S gas inlet M16x1.5 (tube $\varnothing$ 10mm) bypass nozzle $\varnothing$ 0.35mm gas outlet M16x1.5 (tube $\varnothing$ 10/8mm) thermocouple connection M8x1 pilot connection M10x1 shaft $\varnothing$ 8x6.5mm shaft L 22/15mm shaft flat lower		
<b>spare parts for</b>	101095		
	<b>Part No.</b>	100408	<b>Ref. No.</b> —
	bypass nozzle type PEL20/21 bore $\varnothing$ 0.35mm thread M5x0.5		
	<b>Part No.</b>	101060	<b>Ref. No.</b> —
	magnet unit standard L 39mm D1 $\varnothing$ 15.4mm D2 $\varnothing$ 11mm suitable for PEL20-21/JUNKERS/EGA		
	<b>Part No.</b>	101206	<b>Ref. No.</b> —
	gas tap front part shaft $\varnothing$ 8x6.5mm shaft L 22/15mm shaft flat upper/lower suitable for PEL21		
	<b>Part No.</b>	101230	<b>Ref. No.</b> —
	thermocouple nut T1: M8x1 T2: M18x1 aluminium		
<b>accessories for</b>	101095		
	<b>Part No.</b>	100908	<b>Ref. No.</b> —
	union screw thread M10x1 for pipe $\varnothing$ 4mm Qty 1 pcs		
	<b>Part No.</b>	100909	<b>Ref. No.</b> —
	union screw thread M10x1 for pipe $\varnothing$ 6mm Qty 1 pcs		
	<b>Part No.</b>	101246	<b>Ref. No.</b> —
	olive for pipe $\varnothing$ 4mm Qty 1 pcs		
	<b>Part No.</b>	101278	<b>Ref. No.</b> —
	olive for pipe $\varnothing$ 10mm Qty 1 pcs		
	<b>Part No.</b>	101286	<b>Ref. No.</b> —
	olive ID $\varnothing$ 6mm Qty 1 pcs		

<b>accessories for</b>	101095		
	<b>Part No.</b>	101300	<b>Ref. No.</b> —
	union nut thread M16x1.5 tube $\varnothing$ 10mm		
	<b>Part No.</b>	101450	<b>Ref. No.</b> —
	olive for pipe $\varnothing$ 8mm L 12.7mm Qty 1 pcs ED $\varnothing$ 10mm		
	<b>Part No.</b>	101451	<b>Ref. No.</b> —
	union nut thread M16x1.5 tube $\varnothing$ 8mm		
	<b>Part No.</b>	110081	<b>Ref. No.</b> RC05001300
	knob $\varnothing$ 70mm shaft $\varnothing$ 8x6.5mm shaft flat universal		
	<b>Part No.</b>	112206	<b>Ref. No.</b> —
	knob dial plate silver gas tap PEL21/22/23 t.max.°C ED $\varnothing$ 63mm ID $\varnothing$ 45.5mm		

## 22S/V series





1

<b>Part No.</b>	101087	<b>Ref. No.</b>	00126 RC00126000
<b>description</b>	gas tap PEL type 22S/V gas inlet M20x1.5 (tube $\varnothing$ 12mm) bypass nozzle $\varnothing$ 0.35mm gas outlet M20x1.5 (tube $\varnothing$ 12/10mm) thermocouple connection M9x1 pilot connection M10x1 shaft $\varnothing$ 10x8mm shaft L 25/17mm shaft flat upper		
<b>spare parts for</b>	101087		
	<b>Part No.</b>	100259	<b>Ref. No.</b> —
	bypass nozzle type PEL22 bore $\varnothing$ 0.35mm thread M6x0.5		
	<b>Part No.</b>	101058	<b>Ref. No.</b> —
	magnet unit L 39mm D1 $\varnothing$ 15.4mm D2 $\varnothing$ 13.5mm suitable for PEL22/EGA24197 standard		
	<b>Part No.</b>	101201	<b>Ref. No.</b> —
	gas tap front part shaft $\varnothing$ 10x8mm shaft L 25/17mm shaft flat upper/lower suitable for PEL22		
	<b>Part No.</b>	101231	<b>Ref. No.</b> —
	thermocouple nut T1: M9x1 T2: M18x1		
	<b>Part No.</b>	101241	<b>Ref. No.</b> —
	gas connection thread M20x1.5 tube $\varnothing$ 12/10mm for PEL gas taps vertical		
	<b>Part No.</b>	101460	<b>Ref. No.</b> —
	O-ring $\varnothing$ 12.37mm D1 $\varnothing$ 2.62mm suitable for PEL22		
	<b>Part No.</b>	101461	<b>Ref. No.</b> —
	screw kit suitable for PEL22 Qty 4 pcs		
<b>accessories for</b>	101087		
	<b>Part No.</b>	100908	<b>Ref. No.</b> —
	union screw thread M10x1 for pipe $\varnothing$ 4mm Qty 1 pcs		
	<b>Part No.</b>	100909	<b>Ref. No.</b> —
	union screw thread M10x1 for pipe $\varnothing$ 6mm Qty 1 pcs		

Table continues overleaf



accessories for		101087	
	Part No.	101240	Ref. No. —
gas connection thread M20x1.5 tube ø 12/10mm for PEL gas taps with gasket and screws horizontal			
	Part No.	101246	Ref. No. —
olive for pipe ø 4mm Qty 1 pcs			
	Part No.	101248	Ref. No. —
olive for pipe ø 12mm Qty 1 pcs suitable for PEL			
	Part No.	101249	Ref. No. —
olive for pipe ø 10mm Qty 1 pcs			
	Part No.	101250	Ref. No. —
union nut thread M20x1.5 for pipe ø 10mm			
	Part No.	101251	Ref. No. —
union nut thread M20x1.5 for pipe ø 12mm			
	Part No.	101286	Ref. No. —
olive ID ø 6mm Qty 1 pcs			
	Part No.	110080	Ref. No. 00127 RC00127000
knob ø 70mm shaft ø 10x8mm shaft flat universal			
	Part No.	112206	Ref. No. —
knob dial plate silver gas tap PEL21/22/23 t.max.°C ED ø 63mm ID ø 45.5mm			

accessories for		101396	
	Part No.	520656	Ref. No. —
union nut thread 1/4" tube ø 6/8mm			
	Part No.	560082	Ref. No. —
hexagonal screw thread M4 thread L 16mm SS WS 7 Qty 20 pcs DIN 933 / ISO 4017			



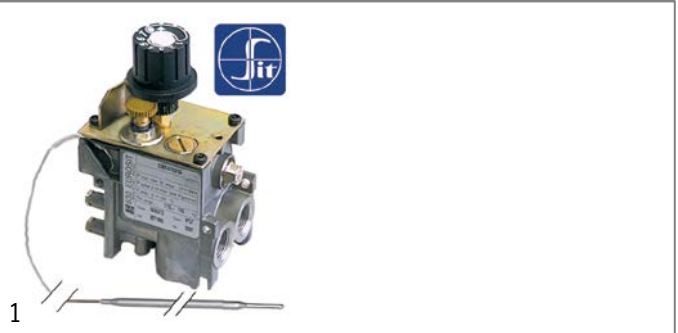

## gas thermostats

### SIT

#### 630 Eurosit series





Part No.	101188	Ref. No.	00446 RC00446000
<b>description</b>	gas thermostat type 630 Eurosit series t.max. 190°C 110-190°C gas inlet 3/8" gas outlet 3/8" thermocouple connection M9x1 pilot connection M10x1 probe ø 4mm probe L 202mm capillary pipe 1050mm SIT		



accessories for		101188	
	Part No.	100904	Ref. No. —
locking screw M10x1 for pipe ø 4mm Qty 1 pcs			
	Part No.	100905	Ref. No. —
locking screw M10x1 for pipe ø 6mm Qty 1 pcs			
	Part No.	101273	Ref. No. —
olive for pipe ø 12mm L 9.5mm brass Qty 1 pcs suitable for universal			
	Part No.	101276	Ref. No. —
union screw thread 3/8" tube ø 12mm Qty 1 pcs			
	Part No.	101333	Ref. No. —
plug thread 3/8" with O-ring			

## SABAF



Part No.	101396	Ref. No.	00369 RC00369000
<b>description</b>	gas tap SABAF type 10 gas inlet pipe flange ø16mm bypass nozzle ø 0mm gas outlet 1/4" (tube ø 8mm) front fixing thermocouple connection M8x1 shaft ø 8x6.5mm shaft L 26/12mm shaft flat lower		

spare parts for		101396	
	Part No.	101376	Ref. No. —
gasket ID ø 8mm ED ø 12mm H 3/5mm			
	Part No.	101751	Ref. No. —
bracket			
	Part No.	106724	Ref. No. —
magnet unit L 30mm D1 ø 12.5mm D2 ø 8.5mm suitable for SABAF			

accessories for		101396	
	Part No.	101277	Ref. No. —
olive ID ø 8mm Qty 1 pcs			
	Part No.	101751	Ref. No. —
bracket			



Part No.	101696	Ref. No.	01171 RC01171000
<b>description</b>	gas thermostat type 630 Eurosit series t.max. 300°C 60-300°C gas inlet 3/8" gas outlet 3/8" thermocouple connection M9x1 pilot connection M10x1 probe ø 4mm probe L 72mm capillary pipe 1050mm SIT		

spare parts for		101696	
	Part No.	101333	Ref. No. —
plug thread 3/8" with O-ring			

Table continues overleaf





<b>accessories for</b> 101696	
	Part No. 100904 Ref. No. — locking screw M10x1 for pipe ø 4mm Qty 1 pcs
	Part No. 100905 Ref. No. — locking screw M10x1 for pipe ø 6mm Qty 1 pcs
	Part No. 101273 Ref. No. — olive for pipe ø 12mm L 9.5mm brass Qty 1 pcs suitable for universal
	Part No. 101276 Ref. No. — union screw thread 3/8" tube ø 12mm Qty 1 pcs

**PEL**

**25ST series**



<b>Part No.</b>	101172	<b>Ref. No.</b>	01133 RC01133000
<b>description</b>	gas thermostat PEL type 25ST 100-300°C gas inlet M16x1.5 (tube ø 10mm) bypass nozzle ø 0.35mm gas outlet M16x1.5 (tube ø 10/8mm) thermocouple connection M9x1 pilot connection M10x1 capillary pipe 1200mm probe ø 6mm probe L 100mm shaft ø 8x6.5mm shaft L 21/15mm shaft flat upper		
<b>spare parts for</b>	101172		
	Part No. 100259	Ref. No.	—
	Part No. 101060	Ref. No.	—
	Part No. 106200	Ref. No.	—
<b>accessories for</b>	101172		
	Part No. 100908	Ref. No.	—
	Part No. 100909	Ref. No.	—
	Part No. 101246	Ref. No.	—
	Part No. 101278	Ref. No.	—
	Part No. 101286	Ref. No.	—
	Part No. 101300	Ref. No.	—
	Part No. 101450	Ref. No.	—
	Part No. 101451	Ref. No.	—

<b>accessories for</b> 101172	
	Part No. 110079 Ref. No. —
	Part No. 110081 Ref. No. RC05001300

**SABAF**





<b>Part No.</b>	101694	<b>Ref. No.</b>	00889 RC00889000 RC02228000
<b>description</b>	gas thermostat SABAF t.max. 300°C gas inlet pipe flange bypass nozzle ø 0.38mm gas outlet M13x1 IT (tube ø 8mm) gas outlet 2 thermocouple connection M8x1 capillary pipe 850mm probe ø 4mm probe L 150mm shaft ø 8x6.5mm shaft flat lower L1 29mm L2 29mm		
<b>spare parts for</b>	101694		
	Part No. 101060	Ref. No.	—
<b>accessories for</b>	101694		
	Part No. 101277	Ref. No.	—
	Part No. 101376	Ref. No.	—
	Part No. 101477	Ref. No.	—
	Part No. 101751	Ref. No.	—



<b>Part No.</b>	101695	<b>Ref. No.</b>	00890 RC00890000
<b>description</b>	gas thermostat SABAF t.max. 300°C gas inlet pipe flange bypass nozzle ø 0.52mm gas outlet M13x1 IT (tube ø 8mm) gas outlet 2 thermocouple connection M8x1 capillary pipe 850mm probe ø 4mm probe L 150mm shaft ø 8x6.5mm shaft L 29/29mm shaft flat lower		
<b>spare parts for</b>	101695		
	Part No. 101060	Ref. No.	—
<b>accessories for</b>	101695		
	Part No. 101277	Ref. No.	—
	Part No. 101376	Ref. No.	—

Table continues overleaf



accessories for	101695			
	Part No.	101477	Ref. No.	—
	union screw thread M13x1 tube ø 8mm Qty 1 pcs			
	Part No.	101479	Ref. No.	—
	bracket			

## gas valves and ignition boxes







### gas control valves

#### SIT

#### NOVASIT



1

<b>Part No.</b>	101187	<b>Ref. No.</b>	RC30300014	
<b>description</b>	gas valve SIT series Novasit 820 0.17VHz gas inlet 1/2" gas outlet 1/2" thermocouple connection M9x1 pilot connection M10x1 ignition pressurembar pressure range 5-50mbar pressure regulator connection blind equiv. no. 0.820.301 supply Operator millivolt			
<b>spare parts for</b>	101187			
	Part No.	101065	Ref. No.	—
	magnet unit with cable L 44mm D1 ø 30mm D2 ø 20mm suitable for NOVASIT			
<b>accessories for</b>	101187			
	Part No.	100110	Ref. No.	—
	pilot burner SIT type 190 series 3 flames nozzle ømm gas connectionmm			
	Part No.	101305	Ref. No.	—
	gas connection straight 1/2" flange 45x45mm ELETTROSIT/V4400/4600/4605 suitable for SIT/HONEYWELL hole distance 36x36mm			
	Part No.	101306	Ref. No.	—
	gas connection angled flange 45x45mm hole distance 36x36mm 1/2" ELETTROSIT/V4400/4600/4605 screw with O-ring suitable for SIT/HONEYWELL			
	Part No.	101307	Ref. No.	—
	gas connection straight flange 45x45mm hole distance 36x36mm 3/4" ELETTROSIT/V4400/4600/4605 screw with O-ring suitable for SIT/HONEYWELL			
	Part No.	101308	Ref. No.	—
	gas connection angled flange 45x45mm hole distance 36x36mm 3/4" ELETTROSIT/V4400/4600/4605 screw with O-ring suitable for SIT/HONEYWELL			
	Part No.	102116	Ref. No.	—
	thermopile ROBERTSHAW L 900mm probe ø 9mm probe L 57mm 250-750mV screw connection 7/16"			

#### TANDEM



1

<b>Part No.</b>	101881	<b>Ref. No.</b>	RCK7020080	
<b>description</b>	gas valve 230V 50Hz gas inlet 1/2" gas outlet 1/2" pilot connection level slow ignition ignition times pressure range 3-50mbar power supply for modulator equiv. no. 0.830.041 suitable for Tandem			
<b>spare parts for</b>	101881			
	Part No.	101379	Ref. No.	—
	solenoid coil 230V 50Hz suitable for Tandem			
<b>accessories for</b>	101881			
	Part No.	101274	Ref. No.	RCK7070036
	olive for pipe ø 16mm Qty 1 pcs			
	Part No.	101275	Ref. No.	—
	union screw thread 1/2" for pipe ø 16mm Qty 1 pcs			
	Part No.	101925	Ref. No.	—
	plug with O-ring thread M10x1 for pilot burner suitable for NOVASIT			
	Part No.	102845	Ref. No.	—
	gas connection angled 1/2" flange 32x32mm hole distance 24x24mm Tandem			
	Part No.	102846	Ref. No.	—
	gas connection straight 1/2" flange 32x32mm hole distance 24x24mm suitable for Tandem			
	Part No.	102847	Ref. No.	—
	O-ring			

### ignition boxes

#### SIT



1

<b>Part No.</b>	101685	<b>Ref. No.</b>	RCK7020085
<b>description</b>	ignition box SIT type 503EFD electrodes 2 waiting time 1.5s safety time 10s 220/240V 10VA 50-60Hz protection IP40		



# ignition parts









## pilot burners

SIT

100 series



















1

<b>Part No.</b>	106901	<b>Ref. No.</b>	01140 RC01140000
<b>description</b>	pilot burner SIT type 100 series 1 flame nozzle ø 0.2mm gas connection 6mm		
<b>spare parts for</b>	106901		
	Part No.	100854	Ref. No. —
	pilot burner bracket double		
	Part No.	100916	Ref. No. —
	compression spring for pilot burner Qty 1 pcs		
	Part No.	100917	Ref. No. —
	gasket for pilot burner Qty 1 pcs aluminium		
	Part No.	100918	Ref. No. —
	screw for pilot burner		
<b>accessories for</b>	106901		
	Part No.	100904	Ref. No. —
	locking screw M10x1 for pipe ø 4mm Qty 1 pcs		
	Part No.	100905	Ref. No. —
	locking screw M10x1 for pipe ø 6mm Qty 1 pcs		
	Part No.	102110	Ref. No. —
	pilot tube copper pipe ø 4mm thickness 1mm L 3000mm		
	Part No.	102111	Ref. No. —
	pilot tube copper pipe ø 6mm thickness 1mm L 3000mm		
	Part No.	102742	Ref. No. —
	pilot burner nozzle LPG code 25 bore ø 0.25mm Qty 1 pcs		



















1

<b>Part No.</b>	106903	<b>Ref. No.</b>	00119 RC00119000
<b>description</b>	pilot burner SIT type 100 series 3 flames nozzle ø 0.2mm gas connection 6mm		
<b>spare parts for</b>	106903		
	Part No.	100245	Ref. No. 00435 RC00435000
	pilot burner nozzle LPG code 20 bore ø 0.2mm Qty 1 pcs thread M8x0.75		

<b>spare parts for</b>	106903		
	Part No.	100854	Ref. No. —
	pilot burner bracket double		
	Part No.	100885	Ref. No. —
	air mixing sleeve for pilot burner Qty 1 pcs		
	Part No.	100916	Ref. No. —
	compression spring for pilot burner Qty 1 pcs		
	Part No.	100917	Ref. No. —
	gasket for pilot burner Qty 1 pcs aluminium		
	Part No.	100918	Ref. No. —
	screw for pilot burner		
	Part No.	107162	Ref. No. —
	pilot burner cap SIT 3 flames Hmm Lmm Qty 1 pcs		
	Part No.	107701	Ref. No. —
	pilot burner bottom part SIT 100 series nozzle ø 0.2mm		
<b>accessories for</b>	106903		
	Part No.	100245	Ref. No. 00435 RC00435000
	pilot burner nozzle LPG code 20 bore ø 0.2mm Qty 1 pcs thread M8x0.75		
	Part No.	100246	Ref. No. 00436 RC00436000
	pilot burner nozzle natural gas bore ø 0.35mm Qty 1 pcs thread M8x0.75		
	Part No.	100904	Ref. No. —
	locking screw M10x1 for pipe ø 4mm Qty 1 pcs		
	Part No.	100905	Ref. No. —
	locking screw M10x1 for pipe ø 6mm Qty 1 pcs		
	Part No.	102110	Ref. No. —
	pilot tube copper pipe ø 4mm thickness 1mm L 3000mm		
	Part No.	102111	Ref. No. —
	pilot tube copper pipe ø 6mm thickness 1mm L 3000mm		
	Part No.	107171	Ref. No. —
	pilot burner nozzle SIT natural/liquid gas bore ø 0.25mm Qty 1 pcs		
	Part No.	107700	Ref. No. —
	pilot burner bottom part SIT 100 series nozzle ø 0.25mm		
	Part No.	107702	Ref. No. —
	pilot burner bottom part SIT 100 series nozzle ø 0.35mm		





			
1			
<b>Part No.</b>	106906	<b>Ref. No.</b>	00445 RC00445000
<b>description</b>	pilot burner SIT type 100 series 3 flames nozzle ø 0.2mm gas connection 6mm		
<b>spare parts for</b>	106906		
	<b>Part No.</b>	100245	<b>Ref. No.</b> 00435 RC00435000
	pilot burner nozzle LPG code 20 bore ø 0.2mm Qty 1 pcs thread M8x0.75		
	<b>Part No.</b>	100855	<b>Ref. No.</b> 00411 RC00411000
	pilot burner bracket triple		
	<b>Part No.</b>	100885	<b>Ref. No.</b> —
	air mixing sleeve for pilot burner Qty 1 pcs		
	<b>Part No.</b>	100916	<b>Ref. No.</b> —
	compression spring for pilot burner Qty 1 pcs		
	<b>Part No.</b>	100917	<b>Ref. No.</b> —
	gasket for pilot burner Qty 1 pcs aluminium		
	<b>Part No.</b>	100918	<b>Ref. No.</b> —
	screw for pilot burner		
	<b>Part No.</b>	107162	<b>Ref. No.</b> —
	pilot burner cap SIT 3 flames Hmm Lmm Qty 1 pcs		
	<b>Part No.</b>	107701	<b>Ref. No.</b> —
	pilot burner bottom part SIT 100 series nozzle ø 0.2mm		
<b>accessories for</b>	106906		
	<b>Part No.</b>	100245	<b>Ref. No.</b> 00435 RC00435000
	pilot burner nozzle LPG code 20 bore ø 0.2mm Qty 1 pcs thread M8x0.75		
	<b>Part No.</b>	100246	<b>Ref. No.</b> 00436 RC00436000
	pilot burner nozzle natural gas bore ø 0.35mm Qty 1 pcs thread M8x0.75		
	<b>Part No.</b>	100904	<b>Ref. No.</b> —
	locking screw M10x1 for pipe ø 4mm Qty 1 pcs		
	<b>Part No.</b>	100905	<b>Ref. No.</b> —
	locking screw M10x1 for pipe ø 6mm Qty 1 pcs		
	<b>Part No.</b>	102110	<b>Ref. No.</b> —
	pilot tube copper pipe ø 4mm thickness 1mm L 3000mm		
	<b>Part No.</b>	102111	<b>Ref. No.</b> —
	pilot tube copper pipe ø 6mm thickness 1mm L 3000mm		
	<b>Part No.</b>	107171	<b>Ref. No.</b> —
	pilot burner nozzle SIT natural/liquid gas bore ø 0.25mm Qty 1 pcs		
	<b>Part No.</b>	107700	<b>Ref. No.</b> —
	pilot burner bottom part SIT 100 series nozzle ø 0.25mm		

<b>accessories for</b>	106906		
	<b>Part No.</b>	107702	<b>Ref. No.</b> —
	pilot burner bottom part SIT 100 series nozzle ø 0.35mm		

			
1			
<b>Part No.</b>	106907	<b>Ref. No.</b>	RC30100005
<b>description</b>	pilot burner SIT type 100 series 3 flames nozzle ø 0.35mm gas connection 6mm		
<b>spare parts for</b>	106907		
	<b>Part No.</b>	100246	<b>Ref. No.</b> 00436 RC00436000
	pilot burner nozzle natural gas bore ø 0.35mm Qty 1 pcs thread M8x0.75		
	<b>Part No.</b>	100855	<b>Ref. No.</b> 00411 RC00411000
	pilot burner bracket triple		
	<b>Part No.</b>	100885	<b>Ref. No.</b> —
	air mixing sleeve for pilot burner Qty 1 pcs		
	<b>Part No.</b>	100916	<b>Ref. No.</b> —
	compression spring for pilot burner Qty 1 pcs		
	<b>Part No.</b>	100917	<b>Ref. No.</b> —
	gasket for pilot burner Qty 1 pcs aluminium		
	<b>Part No.</b>	100918	<b>Ref. No.</b> —
	screw for pilot burner		
	<b>Part No.</b>	107162	<b>Ref. No.</b> —
	pilot burner cap SIT 3 flames Hmm Lmm Qty 1 pcs		
	<b>Part No.</b>	107702	<b>Ref. No.</b> —
	pilot burner bottom part SIT 100 series nozzle ø 0.35mm		
<b>accessories for</b>	106907		
	<b>Part No.</b>	100245	<b>Ref. No.</b> 00435 RC00435000
	pilot burner nozzle LPG code 20 bore ø 0.2mm Qty 1 pcs thread M8x0.75		
	<b>Part No.</b>	100904	<b>Ref. No.</b> —
	locking screw M10x1 for pipe ø 4mm Qty 1 pcs		
	<b>Part No.</b>	100905	<b>Ref. No.</b> —
	locking screw M10x1 for pipe ø 6mm Qty 1 pcs		
	<b>Part No.</b>	102110	<b>Ref. No.</b> —
	pilot tube copper pipe ø 4mm thickness 1mm L 3000mm		
	<b>Part No.</b>	102111	<b>Ref. No.</b> —
	pilot tube copper pipe ø 6mm thickness 1mm L 3000mm		
	<b>Part No.</b>	107171	<b>Ref. No.</b> —
	pilot burner nozzle SIT natural/liquid gas bore ø 0.25mm Qty 1 pcs		

Table continues overleaf





<b>accessories for</b>	106907		
	<b>Part No.</b>	107700	<b>Ref. No.</b> —
	pilot burner bottom part SIT 100 series nozzle $\varnothing$ 0.25mm		
	<b>Part No.</b>	107701	<b>Ref. No.</b> —
	pilot burner bottom part SIT 100 series nozzle $\varnothing$ 0.2mm		

**accessories**  
**pilot burner brackets**

**universal**



<b>Part No.</b>	100855	<b>Ref. No.</b>	00411 RC00411000
<b>description</b>	pilot burner bracket triple		
<b>accessories for</b>	100855		
	<b>Part No.</b>	100855	<b>Ref. No.</b> 00411 RC00411000
	pilot burner bracket triple		
	<b>Part No.</b>	100886	<b>Ref. No.</b> —
	pilot burner bracket suitable for 100 series 3-piece		
	<b>Part No.</b>	100888	<b>Ref. No.</b> —
	screw bolt for pilot burner		

**pilot burner nozzles**



<b>Part No.</b>	100245	<b>Ref. No.</b>	00435 RC00435000
<b>description</b>	pilot burner nozzle LPG code 20 bore $\varnothing$ 0.2mm Qty 1 pcs thread M8x0.75		



<b>Part No.</b>	100246	<b>Ref. No.</b>	00436 RC00436000
<b>description</b>	pilot burner nozzle natural gas bore $\varnothing$ 0.35mm Qty 1 pcs thread M8x0.75		

**ignition electrodes**

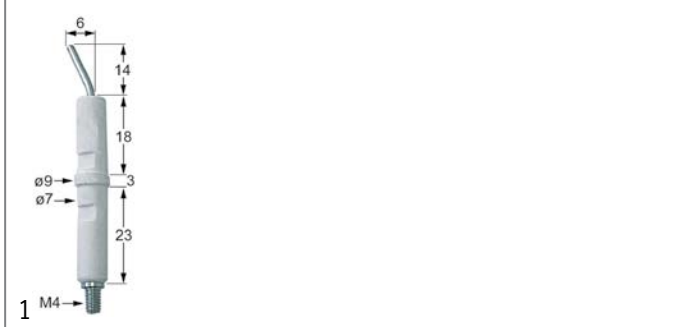





<b>Part No.</b>	100706	<b>Ref. No.</b>	00120 RC00120000
<b>description</b>	ignition electrode connection M4 Qty 1 pcs		

**140 - 145 -150 series**





<b>Part No.</b>	107134	<b>Ref. No.</b>	01169 RC01169000
<b>description</b>	pilot burner SIT type 140 series 1 flame nozzle $\varnothing$ mm gas connectionmm		

**accessories for** 107134

	<b>Part No.</b>	100204	<b>Ref. No.</b>	RC01219000
	pilot burner nozzle SIT LPG code 14 bore $\varnothing$ 0.18/0.20mm Qty 1 pcs suitable for 140 series			
	<b>Part No.</b>	100205	<b>Ref. No.</b>	—
	pilot burner nozzle SIT LPG code 19 bore $\varnothing$ 0.23/0.26mm Qty 1 pcs suitable for SIT 150 series			
	<b>Part No.</b>	100206	<b>Ref. No.</b>	—
	pilot burner nozzle SIT natural gas code 36 bore $\varnothing$ 0.60/0.55mm Qty 1 pcs suitable for SIT 150 series			
	<b>Part No.</b>	100207	<b>Ref. No.</b>	RCK7042013
	pilot burner nozzle SIT natural gas code 27 bore $\varnothing$ 0.40/0.38mm suitable for SIT 140 series			
	<b>Part No.</b>	100216	<b>Ref. No.</b>	—
	pilot burner nozzle SIT natural gas code 38 bore $\varnothing$ 0.45mm Qty 1 pcs suitable for SIT 150 series			

	<b>Part No.</b>	100701	<b>Ref. No.</b>	01168 RC01168000
	ignition electrode connection M4 Qty 1 pcs			

	<b>Part No.</b>	100897	<b>Ref. No.</b>	—
	olive for pipe $\varnothing$ 4mm Qty 1 pcs for pilot burner			

	<b>Part No.</b>	100898	<b>Ref. No.</b>	—
	olive for pipe $\varnothing$ 6mm Qty 1 pcs for pilot burner			

	<b>Part No.</b>	100906	<b>Ref. No.</b>	RCK7050028
	screw connection thread M10x1 for ignition electrode brass Qty 1 pcs WS 10			

	<b>Part No.</b>	100907	<b>Ref. No.</b>	—
	screw connection thread M10x1 Qty 1 pcs type SEF 1 $\varnothing$ mm for thermocouple			

















	<b>Part No.</b>	100908	<b>Ref. No.</b>	—
	union screw thread M10x1 for pipe $\varnothing$ 4mm Qty 1 pcs			

Table continues overleaf



accessories for	107134		
	Part No.	100909	Ref. No. —
	union screw thread M10x1 for pipe ø 6mm Qty 1 pcs		

1			
<b>Part No.</b>	107114 <sup>1</sup>	<b>Ref. No.</b>	RCK7090028
<b>description</b>	pilot burner SIT type 140 series 2 flames nozzle ømm gas connectionmm		
<b>spare parts for</b>	107114		
	Part No.	100907	Ref. No. —
	screw connection thread M10x1 Qty 1 pcs type SEF 1 ømm for thermocouple		
<b>accessories for</b>	107114		
	Part No.	100204	Ref. No. RC01219000
	pilot burner nozzle SIT LPG code 14 bore ø 0.18/0.20mm Qty 1 pcs suitable for 140 series		
	Part No.	100205	Ref. No. —
	pilot burner nozzle SIT LPG code 19 bore ø 0.23/0.26mm Qty 1 pcs suitable for SIT 150 series		
	Part No.	100206	Ref. No. —
	pilot burner nozzle SIT natural gas code 36 bore ø 0.60/0.55mm Qty 1 pcs suitable for SIT 150 series		
	Part No.	100207	Ref. No. RCK7042013
	pilot burner nozzle SIT natural gas code 27 bore ø 0.40/0.38mm suitable for SIT 140 series		
	Part No.	100216	Ref. No. —
	pilot burner nozzle SIT natural gas code 38 bore ø 0.45mm Qty 1 pcs suitable for SIT 150 series		
	Part No.	100701	Ref. No. 01168 RC01168000
	ignition electrode connection M4 Qty 1 pcs		
	Part No.	100801	Ref. No. —
	gasket for pilot burner Qty 1 pcs		
	Part No.	100897	Ref. No. —
	olive for pipe ø 4mm Qty 1 pcs for pilot burner		
	Part No.	100898	Ref. No. —
	olive for pipe ø 6mm Qty 1 pcs for pilot burner		
	Part No.	100906	Ref. No. RCK7050028
	screw connection thread M10x1 for ignition electrode brass Qty 1 pcs WS 10		
	Part No.	100908	Ref. No. —
	union screw thread M10x1 for pipe ø 4mm Qty 1 pcs		
	Part No.	100909	Ref. No. —
	union screw thread M10x1 for pipe ø 6mm Qty 1 pcs		
	Part No.	102110	Ref. No. —
	pilot tube copper pipe ø 4mm thickness 1mm L 3000mm		
	Part No.	102111	Ref. No. —
	pilot tube copper pipe ø 6mm thickness 1mm L 3000mm		

<sup>1</sup>incl. thermocouple fitting





POLIDORO

pilot burners

1			
<b>Part No.</b>	100051	<b>Ref. No.</b>	RCK7090026
<b>description</b>	pilot burner POLIDORO 3 flames code gas connectionmm		
<b>spare parts for</b>	100051		
	Part No.	100907	Ref. No. —
	screw connection thread M10x1 Qty 1 pcs type SEF 1 ømm for thermocouple		
<b>accessories for</b>	100051		
	Part No.	100000	Ref. No. —
	pilot burner nozzle POLIDORO LPG code 22 bore ø 0.22mm Qty 1 pcs		
	Part No.	100208	Ref. No. —
	pilot burner nozzle POLIDORO LPG code 20 bore ø 0.2mm Qty 1 pcs		
	Part No.	100209	Ref. No. —
	pilot burner nozzle POLIDORO natural gas code 40 bore ø 0.4mm Qty 1 pcs		
	Part No.	100701	Ref. No. 01168 RC01168000
	ignition electrode connection M4 Qty 1 pcs		
	Part No.	100906	Ref. No. RCK7050028
	screw connection thread M10x1 for ignition electrode brass Qty 1 pcs WS 10		
	Part No.	100907	Ref. No. —
	screw connection thread M10x1 Qty 1 pcs type SEF 1 ømm for thermocouple		
	Part No.	100908	Ref. No. —
	union screw thread M10x1 for pipe ø 4mm Qty 1 pcs		
	Part No.	100909	Ref. No. —
	union screw thread M10x1 for pipe ø 6mm Qty 1 pcs		
	Part No.	102110	Ref. No. —
	pilot tube copper pipe ø 4mm thickness 1mm L 3000mm		
	Part No.	102111	Ref. No. —
	pilot tube copper pipe ø 6mm thickness 1mm L 3000mm		
	Part No.	102508	Ref. No. —
	union screw thread M10x1 for pipe ø 4mm Qty 5 pcs		
	Part No.	102509	Ref. No. —
	union screw thread M10x1 for pipe ø 6mm Qty 5 pcs		
	Part No.	102699	Ref. No. —
	pilot burner nozzle POLIDORO natural gas code 25.2 bore ø 2x0.25mm Qty 1 pcs 2 bores		
	Part No.	102795	Ref. No. —
	olive for pipe ø 4mm Qty 1 pcs		
	Part No.	102797	Ref. No. —
	olive for pipe ø 6mm Qty 1 pcs		

Table continues overleaf



accessories for		100051	
Part No.		Ref. No.	
	106703	RCK7042008	pilot burner nozzle POLIDORO natural gas code 27.2 bore $\varnothing$ 2x0.27mm Qty 1 pcs
	106704	—	pilot burner nozzle POLIDORO LPG code 16.2 bore $\varnothing$ 2x0.16mm Qty 1 pcs
	106763	—	pilot burner nozzle POLIDORO natural gas code 27.2A bore $\varnothing$ 2x0.27mm Qty 1 pcs
	106859	—	pilot burner nozzle POLIDORO LPG code 24 bore $\varnothing$ 0.24mm Qty 1 pcs

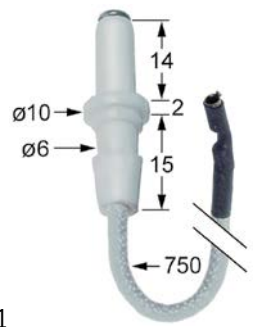

Part No.	100738	Ref. No.	00368 RC00368000
description	ignition electrode D1 $\varnothing$ 6mm cable length 750mm D2 $\varnothing$ 10mm BL1 14mm BL2 2mm BL3 15mm to clip with spring and insulation connection $\varnothing$ 2.4mm		

electrodes

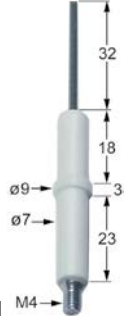

Part No.	100701	Ref. No.	01168 RC01168000
description	ignition electrode connection M4 Qty 1 pcs		



Part No.	102333	Ref. No.	RCK2012111
description	ignition electrode D1 $\varnothing$ 7mm D2 $\varnothing$ 9mm connection M4 L1 23mm L2 19mm BL1 18mm BL2 3mm BL3 23mm to clip		

accessories for		100701	
Part No.		Ref. No.	
	100906	RCK7050028	screw connection thread M10x1 for ignition electrode brass Qty 1 pcs WS 10

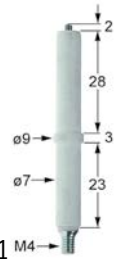

Part No.	102314	Ref. No.	RCK6010061
description	ignition electrode D1 $\varnothing$ 7mm D2 $\varnothing$ 9mm connection M4 L1 2mm BL1 28mm BL2 3mm BL3 23mm to clip		



Part No.	100706	Ref. No.	00120 RC00120000
description	ignition electrode connection M4 Qty 1 pcs		



Part No.	102871	Ref. No.	RC01168000
description	ignition electrode D1 $\varnothing$ 7mm D2 $\varnothing$ 9mm connection M4 L1 8mm BL1 18mm BL2 3mm BL3 23mm to clip		

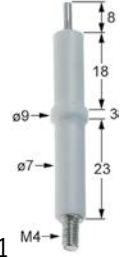

Part No.	102871	Ref. No.	RC01168000
description	ignition electrode D1 $\varnothing$ 7mm D2 $\varnothing$ 9mm connection M4 L1 8mm BL1 18mm BL2 3mm BL3 23mm to clip		

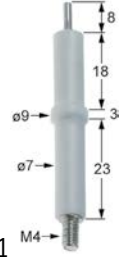

Part No.	102871	Ref. No.	RC01168000
description	ignition electrode D1 $\varnothing$ 7mm D2 $\varnothing$ 9mm connection M4 L1 8mm BL1 18mm BL2 3mm BL3 23mm to clip		

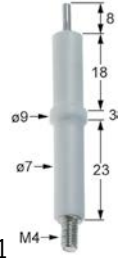

Part No.	102871	Ref. No.	RC01168000
description	ignition electrode D1 $\varnothing$ 7mm D2 $\varnothing$ 9mm connection M4 L1 8mm BL1 18mm BL2 3mm BL3 23mm to clip		

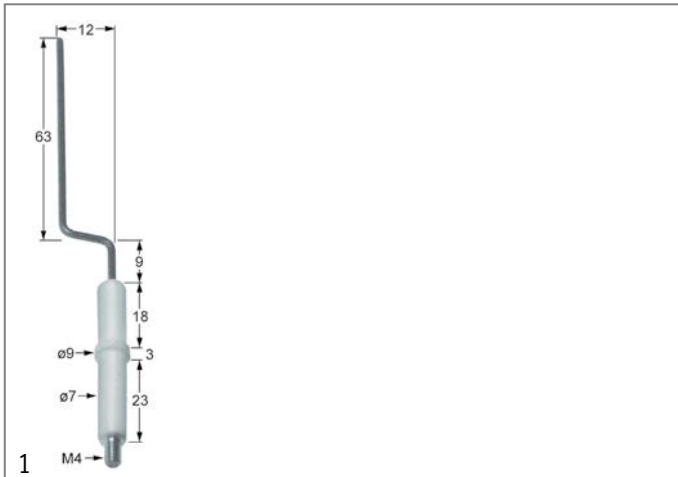

<b>Part No.</b>	102334	<b>Ref. No.</b>	RCK2012110
<b>description</b>	ignition electrode D1 ø 7mm D2 ø 9mm connection M4 L1 9mm L2 12mm L3 62mm BL1 18mm BL2 3mm BL3 23mm to clip		

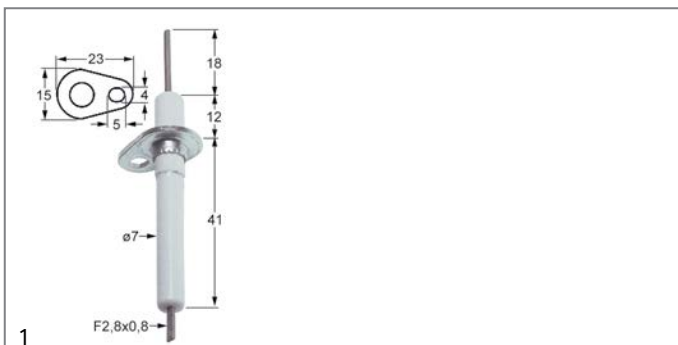

<b>Part No.</b>	100818	<b>Ref. No.</b>	00861 RC00861000
<b>description</b>	ignition electrode flange length 23mm flange width 15mm D1 ø 7mm L1 18mm BL1 12mm BL2 41mm connection F 2.8x0.8mm fixing dimensions ø5x4mm with flange		



<b>Part No.</b>	100906	<b>Ref. No.</b>	RCK7050028
<b>description</b>	screw connection thread M10x1 for ignition electrode brass Qty 1 pcs WS 10		

ignition cables

pre-assembled cables

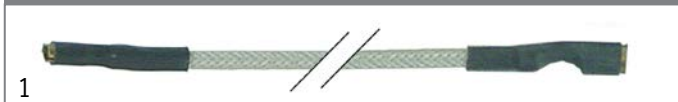

<b>Part No.</b>	100176	<b>Ref. No.</b>	RCK6050610
<b>description</b>	ignition cable cable length 1000mm connection ø2.4mm / ø4mm permanent temperature 200°C		



<b>Part No.</b>	100174	<b>Ref. No.</b>	00867 RC00867000
<b>description</b>	ignition cable cable length 1500mm connection F2.8mm / F2.8mm		



<b>Part No.</b>	100140	<b>Ref. No.</b>	RCK6050051
<b>description</b>	ignition cable cable length 400mm connection ø2.4mm / ø4mm		



<b>Part No.</b>	100018	<b>Ref. No.</b>	00123 RC00123000
<b>description</b>	ignition cable cable length 600mm connection ø2.4mm / ø4mm permanent temperature 200°C		

piezoelectric igniters

mounting diameter 18mm

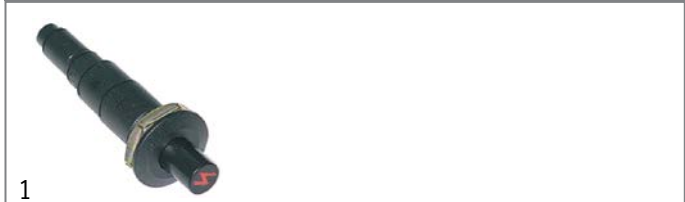

<b>Part No.</b>	100009	<b>Ref. No.</b>	00128 RC00128000
<b>description</b>	piezoelectric igniter body plastic blowing mounting ø 18mm connection ø2.4mm front measurements 26mm M18x1.5		

<b>accessories for</b>	100009			
	<b>Part No.</b>	101339	<b>Ref. No.</b>	—
	cover cap for piezoelectric igniter			
	<b>Part No.</b>	106869	<b>Ref. No.</b>	—
	cover cap for piezoelectric igniter ID ø 22mm ED ø 35mm H 25mm			
	<b>Part No.</b>	107931	<b>Ref. No.</b>	—
	cover cap for piezoelectric igniter ID ø 21mm ED ø 36mm			

ignition units



<b>Part No.</b>	102485	<b>Ref. No.</b>	RC00862000 RCK6041059
<b>description</b>	ignition unit outputs 2 220-240VAC 0.6VA 50-60Hz		



**1**

<b>Part No.</b>	101002	<b>Ref. No.</b>	00862
<b>description</b>	ignition unit outputs 2 230VAC dimensions 88x23x34mm mounting distance 73mm inlet F6.3x0.8 outlet F2.8x0.8 0.6VA 50/60Hz		

## thermocouples

### plug-in thermocouples

### plug-in thermocouples standard

### with barrel socket ø6(6.5)mm

### thermocouples SIT

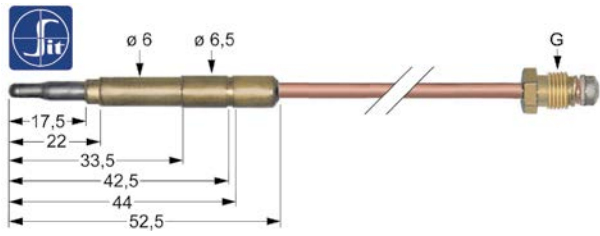

**1**

<b>Part No.</b>	107605	<b>Ref. No.</b>	RC01483000
<b>description</b>	thermocouple SIT M8x1 L 1500mm plug connection ø6.0(6.5)mm		

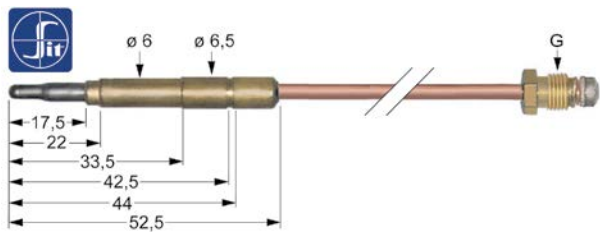

**1**

<b>Part No.</b>	107613	<b>Ref. No.</b>	RC40400100
<b>description</b>	thermocouple SIT M9x1 L 1200mm plug connection ø6.0(6.5)mm		

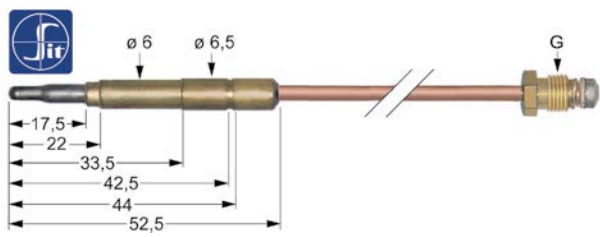

**1**

<b>Part No.</b>	107609	<b>Ref. No.</b>	00118 RC00118000
<b>description</b>	thermocouple SIT M9x1 L 600mm plug connection ø6.0(6.5)mm		

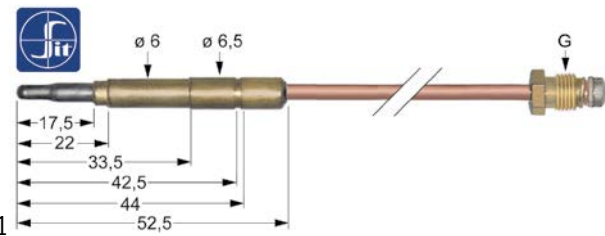

**1**

<b>Part No.</b>	107611	<b>Ref. No.</b>	RC40400110 RCK6010057
<b>description</b>	thermocouple SIT M9x1 L 850mm plug connection ø6.0(6.5)mm		

### threaded thermocouples

### threaded thermocouples standard

### with socket with thread M8x1

### SIT

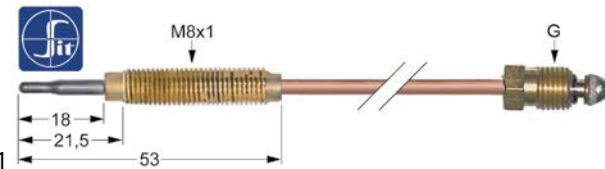

**1**

<b>Part No.</b>	107634	<b>Ref. No.</b>	00864 RC00864000	
<b>description</b>	thermocouple SIT M8x1 L 1500mm M8x1			
<b>accessories for</b>	107634			
	<b>Part No.</b>	102067	<b>Ref. No.</b>	00865 RC00865000
	nut thread M8x1 H 3mm brass Qty 1 pcs type SEF 1			

### threaded thermocouples (miscellaneous)

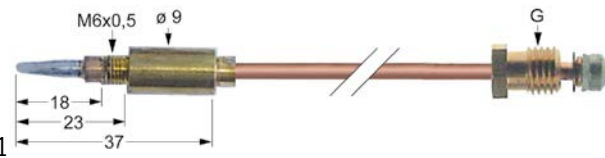

**1**

<b>Part No.</b>	102121	<b>Ref. No.</b>	00367 RC00367000	
<b>description</b>	thermocouple M8x1 L 600mm M6x0.5			
<b>accessories for</b>	102121			
	<b>Part No.</b>	100892	<b>Ref. No.</b>	—
	thermocouple nut thread M6x0.5 H 6.5mm WS 8 brass Qty 1 pcs			

### accessories

#### nuts



**1**

<b>Part No.</b>	102067	<b>Ref. No.</b>	00865 RC00865000
<b>description</b>	nut thread M8x1 H 3mm brass Qty 1 pcs type SEF 1		



interrupters

 <p>1</p>			
<b>Part No.</b>	101265	<b>Ref. No.</b>	RC00460000
<b>description</b>	interrupter thread M9x1		



gas burners





hob burners









universal hob burners

SABAF

1 series

 <p>1</p>			
<b>Part No.</b>	104288	<b>Ref. No.</b>	00375 RC00375000
<b>description</b>	burner cap 3.6kW ø 120mm		
<b>accessories for</b>	104288		
	<b>Part No.</b>	104289	<b>Ref. No.</b> 00377 RC00377000
	burner lower part 3/3.6kW for burner cap ø 90/120mm		
	<b>Part No.</b>	105086	<b>Ref. No.</b> —
	burner ring 3.6kW for burner cap ø 120mm		
	<b>Part No.</b>	105087	<b>Ref. No.</b> —
	burner head 3.6kW for burner cap ø 120mm		

 <p>1</p>			
<b>Part No.</b>	104286	<b>Ref. No.</b>	00373 RC00373000
<b>description</b>	burner cap 3kW ø 90mm		
<b>accessories for</b>	104286		
	<b>Part No.</b>	104289	<b>Ref. No.</b> 00377 RC00377000
	burner lower part 3/3.6kW for burner cap ø 90/120mm		
	<b>Part No.</b>	105089	<b>Ref. No.</b> —
	burner ring 3kW for burner cap ø 90mm		
	<b>Part No.</b>	105090	<b>Ref. No.</b> —
	burner head 3kW for burner cap ø 90mm		

 <p>1</p>			
<b>Part No.</b>	104289	<b>Ref. No.</b>	00377 RC00377000
<b>description</b>	burner lower part 3/3.6kW for burner cap ø 90/120mm		
<b>accessories for</b>	104289		
	<b>Part No.</b>	104286	<b>Ref. No.</b> 00373 RC00373000
	burner cap 3kW ø 90mm		
	<b>Part No.</b>	104288	<b>Ref. No.</b> 00375 RC00375000
	burner cap 3.6kW ø 120mm		
	<b>Part No.</b>	105086	<b>Ref. No.</b> —
	burner ring 3.6kW for burner cap ø 120mm		
	<b>Part No.</b>	105087	<b>Ref. No.</b> —
	burner head 3.6kW for burner cap ø 120mm		
	<b>Part No.</b>	105089	<b>Ref. No.</b> —
	burner ring 3kW for burner cap ø 90mm		
	<b>Part No.</b>	105090	<b>Ref. No.</b> —
	burner head 3kW for burner cap ø 90mm		
	<b>Part No.</b>	106482	<b>Ref. No.</b> —
	gas injector thread M6x0.75 WS 7 bore ø 1.1mm		
	<b>Part No.</b>	106485	<b>Ref. No.</b> —
	gas injector thread M6x0.75 WS 7 bore ø 1.6mm		

producer-specific hob burners

TECNOINOX



650 (1) series

 <p>1</p>			
<b>Part No.</b>	104288	<b>Ref. No.</b>	00375 RC00375000
<b>description</b>	burner cap 3.6kW ø 120mm		
<b>accessories for</b>	104288		
	<b>Part No.</b>	104289	<b>Ref. No.</b> 00377 RC00377000
	burner lower part 3/3.6kW for burner cap ø 90/120mm		
	<b>Part No.</b>	105086	<b>Ref. No.</b> —
	burner ring 3.6kW for burner cap ø 120mm		
	<b>Part No.</b>	105087	<b>Ref. No.</b> —
	burner head 3.6kW for burner cap ø 120mm		









			
1			
<b>Part No.</b>	104286	<b>Ref. No.</b>	00373 RC00373000
<b>description</b>	burner cap 3kW ø 90mm		
<b>accessories for</b>	104286		
	<b>Part No.</b>	104289	<b>Ref. No.</b> 00377 RC00377000
burner lower part 3/3.6kW for burner cap ø 90/120mm			
	<b>Part No.</b>	105089	<b>Ref. No.</b> —
burner ring 3kW for burner cap ø 90mm			
	<b>Part No.</b>	105090	<b>Ref. No.</b> —
burner head 3kW for burner cap ø 90mm			





			
1			
<b>Part No.</b>	104289	<b>Ref. No.</b>	00377 RC00377000
<b>description</b>	burner lower part 3/3.6kW for burner cap ø 90/120mm		
<b>accessories for</b>	104289		
	<b>Part No.</b>	104286	<b>Ref. No.</b> 00373 RC00373000
burner cap 3kW ø 90mm			
	<b>Part No.</b>	104288	<b>Ref. No.</b> 00375 RC00375000
burner cap 3.6kW ø 120mm			
	<b>Part No.</b>	105086	<b>Ref. No.</b> —
burner ring 3.6kW for burner cap ø 120mm			
	<b>Part No.</b>	105087	<b>Ref. No.</b> —
burner head 3.6kW for burner cap ø 120mm			
	<b>Part No.</b>	105089	<b>Ref. No.</b> —
burner ring 3kW for burner cap ø 90mm			
	<b>Part No.</b>	105090	<b>Ref. No.</b> —
burner head 3kW for burner cap ø 90mm			
	<b>Part No.</b>	106482	<b>Ref. No.</b> —
gas injector thread M6x0.75 WS 7 bore ø 1.1mm			
	<b>Part No.</b>	106485	<b>Ref. No.</b> —
gas injector thread M6x0.75 WS 7 bore ø 1.6mm			

			
1			
<b>Part No.</b>	104287	<b>Ref. No.</b>	00374 RC00374000
<b>description</b>	burner ring for burner cap ø 120mm		
<b>accessories for</b>	104287		
	<b>Part No.</b>	105086	<b>Ref. No.</b> —
burner ring 3.6kW for burner cap ø 120mm			





<b>accessories for</b>	104287		
	<b>Part No.</b>	105087	<b>Ref. No.</b> —
burner head 3.6kW for burner cap ø 120mm			





			
1			
<b>Part No.</b>	104285	<b>Ref. No.</b>	00372 RC00372000
<b>description</b>	burner ring ø 90mm for burner cap ø 90mm		
<b>accessories for</b>	104285		
	<b>Part No.</b>	105089	<b>Ref. No.</b> —
burner ring 3kW for burner cap ø 90mm			
	<b>Part No.</b>	105090	<b>Ref. No.</b> —
burner head 3kW for burner cap ø 90mm			

<b>650 (2) series</b>			
			
1			
<b>Part No.</b>	105379	<b>Ref. No.</b>	00969 RC00969000
<b>description</b>	air mixing tube		
<b>accessories for</b>	105379		
	<b>Part No.</b>	105376	<b>Ref. No.</b> 00967 RC00967000
burner cap ø 110mm			
	<b>Part No.</b>	105377	<b>Ref. No.</b> 00968 RC00968000
burner head for burner cap ø 110mm			
	<b>Part No.</b>	105378	<b>Ref. No.</b> 00976 RC00976000
burner holder			





			
1			
<b>Part No.</b>	105376	<b>Ref. No.</b>	00967 RC00967000
<b>description</b>	burner cap ø 110mm		
<b>accessories for</b>	105376		
	<b>Part No.</b>	105377	<b>Ref. No.</b> 00968 RC00968000
burner head for burner cap ø 110mm			
	<b>Part No.</b>	105378	<b>Ref. No.</b> 00976 RC00976000
burner holder			
	<b>Part No.</b>	105379	<b>Ref. No.</b> 00969 RC00969000
air mixing tube			











 <p>1</p>			
<b>Part No.</b>	105377	<b>Ref. No.</b>	00968 RC00968000
<b>description</b>	burner head for burner cap ø 110mm		
<b>accessories for</b>	105377		
	<b>Part No.</b>	105376	<b>Ref. No.</b> 00967 RC00967000
burner cap ø 110mm			
	<b>Part No.</b>	105378	<b>Ref. No.</b> 00976 RC00976000
burner holder			
	<b>Part No.</b>	105379	<b>Ref. No.</b> 00969 RC00969000
air mixing tube			





 <p>1</p>			
<b>Part No.</b>	105378	<b>Ref. No.</b>	00976 RC00976000
<b>description</b>	burner holder		
<b>accessories for</b>	105378		
	<b>Part No.</b>	105376	<b>Ref. No.</b> 00967 RC00967000
burner cap ø 110mm			
	<b>Part No.</b>	105377	<b>Ref. No.</b> 00968 RC00968000
burner head for burner cap ø 110mm			
	<b>Part No.</b>	105379	<b>Ref. No.</b> 00969 RC00969000
air mixing tube			

700 series

 <p>1</p>			
<b>Part No.</b>	105393	<b>Ref. No.</b>	01142 RC01142000
<b>description</b>	air mixing tube H 44mm ø 20mm suitable for burner 4.5kW		
<b>accessories for</b>	105393		
	<b>Part No.</b>	105390	<b>Ref. No.</b> 01150 RC01150000
burner cap ø 110mm 4.5kW			
	<b>Part No.</b>	105391	<b>Ref. No.</b> 01147 RC01147000
burner head for burner cap ø 110mm 4.5kW			
	<b>Part No.</b>	105392	<b>Ref. No.</b> 01139 RC01139000
venturi suitable for burner 4.5kW			

 <p>1</p>			
<b>Part No.</b>	105397	<b>Ref. No.</b>	01143 RC01143000
<b>description</b>	air mixing tube H 48mm ø 22mm suitable for burner 7.2kW		
<b>accessories for</b>	105397		
	<b>Part No.</b>	105394	<b>Ref. No.</b> 01149 RC01149000
burner cap ø 130mm 7.2kW with central hole			
	<b>Part No.</b>	105395	<b>Ref. No.</b> 01146 RC01146000
burner head for burner cap ø 130mm 7.2kW			
	<b>Part No.</b>	105396	<b>Ref. No.</b> 01137 RC01137000
venturi suitable for burner 7.2kW			

 <p>1</p>			
<b>Part No.</b>	105389	<b>Ref. No.</b>	01141 RC01141000
<b>description</b>	air mixing tube L 44mm ø 16mm suitable for burner 3.3kW		
<b>accessories for</b>	105389		
	<b>Part No.</b>	105386	<b>Ref. No.</b> 01151 RC01151000
burner cap ø 75mm 3.3kW			
	<b>Part No.</b>	105387	<b>Ref. No.</b> 01148 RC01148000
burner head for burner cap ø 75mm 3.3kW			
	<b>Part No.</b>	105388	<b>Ref. No.</b> 01138 RC01138000
venturi suitable for burner 3.3kW			

 <p>1</p>			
<b>Part No.</b>	105390	<b>Ref. No.</b>	01150 RC01150000
<b>description</b>	burner cap ø 110mm 4.5kW		
<b>accessories for</b>	105390		
	<b>Part No.</b>	105391	<b>Ref. No.</b> 01147 RC01147000
burner head for burner cap ø 110mm 4.5kW			
	<b>Part No.</b>	105392	<b>Ref. No.</b> 01139 RC01139000
venturi suitable for burner 4.5kW			
	<b>Part No.</b>	105393	<b>Ref. No.</b> 01142 RC01142000
air mixing tube H 44mm ø 20mm suitable for burner 4.5kW			









 <p>1</p>			
<b>Part No.</b>	105394	<b>Ref. No.</b>	01149 RC01149000
<b>description</b>	burner cap ø 130mm 7.2kW with central hole		
<b>accessories for</b>	105394		
	<b>Part No.</b>	105395	<b>Ref. No.</b> 01146 RC01146000
burner head for burner cap ø 130mm 7.2kW			





Table continues overleaf









<b>accessories for</b> 105394	
	Part No. 105396 Ref. No. 01137 RC01137000
venturi suitable for burner 7.2kW	
	Part No. 105397 Ref. No. 01143 RC01143000
air mixing tube H 48mm ø 22mm suitable for burner 7.2kW	





	
<b>Part No.</b> 105386	<b>Ref. No.</b> 01151 RC01151000
<b>description</b> burner cap ø 75mm 3.3kW	
<b>accessories for</b> 105386	
	Part No. 105387 Ref. No. 01148 RC01148000
burner head for burner cap ø 75mm 3.3kW	
	Part No. 105388 Ref. No. 01138 RC01138000
venturi suitable for burner 3.3kW	
	Part No. 105389 Ref. No. 01141 RC01141000
air mixing tube L 44mm ø 16mm suitable for burner 3.3kW	

	
<b>Part No.</b> 105391	<b>Ref. No.</b> 01147 RC01147000
<b>description</b> burner head for burner cap ø 110mm 4.5kW	
<b>accessories for</b> 105391	
	Part No. 105390 Ref. No. 01150 RC01150000
burner cap ø 110mm 4.5kW	
	Part No. 105392 Ref. No. 01139 RC01139000
venturi suitable for burner 4.5kW	
	Part No. 105393 Ref. No. 01142 RC01142000
air mixing tube H 44mm ø 20mm suitable for burner 4.5kW	





	
<b>Part No.</b> 105395	<b>Ref. No.</b> 01146 RC01146000
<b>description</b> burner head for burner cap ø 130mm 7.2kW	
<b>accessories for</b> 105395	
	Part No. 105394 Ref. No. 01149 RC01149000
burner cap ø 130mm 7.2kW with central hole	
	Part No. 105396 Ref. No. 01137 RC01137000
venturi suitable for burner 7.2kW	
	Part No. 105397 Ref. No. 01143 RC01143000
air mixing tube H 48mm ø 22mm suitable for burner 7.2kW	

	
<b>Part No.</b> 105387	<b>Ref. No.</b> 01148 RC01148000
<b>description</b> burner head for burner cap ø 75mm 3.3kW	
<b>accessories for</b> 105387	
	Part No. 105386 Ref. No. 01151 RC01151000
burner cap ø 75mm 3.3kW	
	Part No. 105388 Ref. No. 01138 RC01138000
venturi suitable for burner 3.3kW	
	Part No. 105389 Ref. No. 01141 RC01141000
air mixing tube L 44mm ø 16mm suitable for burner 3.3kW	

	
<b>Part No.</b> 105388	<b>Ref. No.</b> 01138 RC01138000
<b>description</b> venturi suitable for burner 3.3kW	
<b>accessories for</b> 105388	
	Part No. 105386 Ref. No. 01151 RC01151000
burner cap ø 75mm 3.3kW	
	Part No. 105387 Ref. No. 01148 RC01148000
burner head for burner cap ø 75mm 3.3kW	
	Part No. 105389 Ref. No. 01141 RC01141000
air mixing tube L 44mm ø 16mm suitable for burner 3.3kW	

	
<b>Part No.</b> 105392	<b>Ref. No.</b> 01139 RC01139000
<b>description</b> venturi suitable for burner 4.5kW	
<b>accessories for</b> 105392	
	Part No. 105390 Ref. No. 01150 RC01150000
burner cap ø 110mm 4.5kW	
	Part No. 105391 Ref. No. 01147 RC01147000
burner head for burner cap ø 110mm 4.5kW	
	Part No. 105393 Ref. No. 01142 RC01142000
air mixing tube H 44mm ø 20mm suitable for burner 4.5kW	





 <p>1</p>			
<b>Part No.</b>	105396	<b>Ref. No.</b>	01137 RC01137000
<b>description</b>	venturi suitable for burner 7.2kW		
<b>accessories for</b>	105396		
 <p>Part No. 105394 Ref. No. 01149 RC01149000</p> <p>burner cap ø 130mm 7.2kW with central hole</p>			
 <p>Part No. 105395 Ref. No. 01146 RC01146000</p> <p>burner head for burner cap ø 130mm 7.2kW</p>			
 <p>Part No. 105397 Ref. No. 01143 RC01143000</p> <p>air mixing tube H 48mm ø 22mm suitable for burner 7.2kW</p>			

<b>pan supports</b>			
 <p>1</p>			
<b>Part No.</b>	210182	<b>Ref. No.</b>	01144 RC01144000
<b>description</b>	pan support W 285mm L 135mm		

 <p>1</p>			
<b>Part No.</b>	210155	<b>Ref. No.</b>	00376 RC00376000
<b>description</b>	pan support W 320mm L 530mm		

 <p>1</p>			
<b>Part No.</b>	210181	<b>Ref. No.</b>	00970 RC00970000
<b>description</b>	pan support W 330mm L 540mm		

<b>reducers for pan supports</b>			
 <p>1</p>			
<b>Part No.</b>	210050	<b>Ref. No.</b>	N/A
<b>description</b>	reducer for pan support L 260mm W 260mm chrome-plated steel suitable for universal		

 <p>1</p>			
<b>Part No.</b>	210001	<b>Ref. No.</b>	N/A
<b>description</b>	reducer for pan support L 265mm W 265mm SS suitable for universal		

<b>accessories</b>			
<b>reducers for pan supports</b>			
 <p>1</p>			
<b>Part No.</b>	210050	<b>Ref. No.</b>	N/A
<b>description</b>	reducer for pan support L 260mm W 260mm chrome-plated steel suitable for universal		

 <p>1</p>			
<b>Part No.</b>	210001	<b>Ref. No.</b>	N/A
<b>description</b>	reducer for pan support L 265mm W 265mm SS suitable for universal		



<b>pan supports</b>			
 <p>1</p>			
<b>Part No.</b>	210182	<b>Ref. No.</b>	01144 RC01144000
<b>description</b>	pan support W 285mm L 135mm		









			
1			
<b>Part No.</b>	210155	<b>Ref. No.</b>	00376 RC00376000
<b>description</b>	pan support W 320mm L 530mm		



			
1			
<b>Part No.</b>	210181	<b>Ref. No.</b>	00970 RC00970000
<b>description</b>	pan support W 330mm L 540mm		





air mixers

			
1			
<b>Part No.</b>	105379	<b>Ref. No.</b>	00969 RC00969000
<b>description</b>	air mixing tube		
<b>accessories for</b>	105379		
	<b>Part No.</b>	105378	<b>Ref. No.</b> 00976 RC00976000
burner holder			

			
1			
<b>Part No.</b>	105393	<b>Ref. No.</b>	01142 RC01142000
<b>description</b>	air mixing tube H 44mm ø 20mm suitable for burner 4.5kW		
<b>accessories for</b>	105393		
	<b>Part No.</b>	105390	<b>Ref. No.</b> 01150 RC01150000
burner cap ø 110mm 4.5kW			
	<b>Part No.</b>	105391	<b>Ref. No.</b> 01147 RC01147000
burner head for burner cap ø 110mm 4.5kW			
	<b>Part No.</b>	105392	<b>Ref. No.</b> 01139 RC01139000
venturi suitable for burner 4.5kW			

			
1			
<b>Part No.</b>	105397	<b>Ref. No.</b>	01143 RC01143000
<b>description</b>	air mixing tube H 48mm ø 22mm suitable for burner 7.2kW		
<b>accessories for</b>	105397		
	<b>Part No.</b>	105394	<b>Ref. No.</b> 01149 RC01149000
burner cap ø 130mm 7.2kW with central hole			

<b>accessories for</b>	105397		
	<b>Part No.</b>	105395	<b>Ref. No.</b> 01146 RC01146000
burner head for burner cap ø 130mm 7.2kW			
	<b>Part No.</b>	105396	<b>Ref. No.</b> 01137 RC01137000
venturi suitable for burner 7.2kW			

			
1			
<b>Part No.</b>	105389	<b>Ref. No.</b>	01141 RC01141000
<b>description</b>	air mixing tube L 44mm ø 16mm suitable for burner 3.3kW		
<b>accessories for</b>	105389		
	<b>Part No.</b>	105386	<b>Ref. No.</b> 01151 RC01151000
burner cap ø 75mm 3.3kW			
	<b>Part No.</b>	105387	<b>Ref. No.</b> 01148 RC01148000
burner head for burner cap ø 75mm 3.3kW			
	<b>Part No.</b>	105388	<b>Ref. No.</b> 01138 RC01138000
venturi suitable for burner 3.3kW			

bar burners

bar burners

			
1			
<b>Part No.</b>	105483	<b>Ref. No.</b>	00539 RC00539000
<b>description</b>	bar burner 2 row L 468mm W 200mm ømm H 45mm chargrill		

			
1			
<b>Part No.</b>	104292	<b>Ref. No.</b>	50000 RC05000000
<b>description</b>	bar burner 2 row L 493mm W 200mm ømm H 45mm chargrill		

			
1			
<b>Part No.</b>	105408	<b>Ref. No.</b>	01164 RC01164000
<b>description</b>	bar burner 2 row L 510mm W 190mm ømm H 40mm griddle		



1			
<b>Part No.</b>	105475	<b>Ref. No.</b>	RCK2010924
<b>description</b>	bar burner 2 row L 575mm W 225mm ømm H 45mm 11kW chargrill		

1			
<b>Part No.</b>	105427	<b>Ref. No.</b>	00117 RC00117000
<b>description</b>	bar burner 2 row L 680mm W 240mm ømm H 260mm salamander grill		

1			
<b>Part No.</b>	104291	<b>Ref. No.</b>	00420 RC00420000
<b>description</b>	bar burner ø 26mm Wmm Hmm L 260mm bain marie		

1			
<b>Part No.</b>	105405	<b>Ref. No.</b>	00882 RC00882000
<b>description</b>	bar burner ø 27mm Wmm Hmm L 640mm oven		

1			
<b>Part No.</b>	105406	<b>Ref. No.</b>	01134 RC01134000
<b>description</b>	bar burner ø 40mm Wmm Hmm L 520mm flange width 46mm oven flange ø 61mm		

1			
<b>Part No.</b>	105776	<b>Ref. No.</b>	RCK7090100
<b>description</b>	bar burner ø 50mm Wmm Hmm L 305mm with bolt M5x12 flange width 52mm convection oven flange ø 75mm		

1			
<b>Part No.</b>	105407	<b>Ref. No.</b>	00587 RC00587000
<b>description</b>	bar burner ø 50mm Wmm Hmm L 320mm flange width 72mm pasta cooker flange ø 75mm		

1			
<b>Part No.</b>	104290	<b>Ref. No.</b>	00366 RC00366000
<b>description</b>	bar burner ø 50mm Wmm Hmm L 390mm tilting bratt pan		

1			
<b>Part No.</b>	105775	<b>Ref. No.</b>	RCK7090101
<b>description</b>	bar burner ø 50mm Wmm Hmm L 425mm with bolt M5x12 flange width 52mm convection oven flange ø 75mm		



1			
<b>Part No.</b>	211025	<b>Ref. No.</b>	00541 RC00541000
<b>description</b>	charginn grid L 480mm W 305mm H 14mm		
<b>accessories for</b>	211025		
	<b>Part No.</b>	<b>Ref. No.</b>	
	211098	RC05001900	
	 handle ø 28mm L 89mm thread M10x1 black		





			
1			
<b>Part No.</b>	211024	<b>Ref. No.</b>	00543 RC00543000
<b>description</b>	lava rock grid L 420mm W 268mm		

## chargrill grids

			
1			
<b>Part No.</b>	211025	<b>Ref. No.</b>	00541 RC00541000
<b>description</b>	chargrill grid L 480mm W 305mm H 14mm		
<b>accessories for</b>	211025		
	<b>Part No.</b>	211098	<b>Ref. No.</b> RC05001900
	handle ø 28mm L 89mm thread M10x1 black		

## lava rock grids

			
1			
<b>Part No.</b>	211024	<b>Ref. No.</b>	00543 RC00543000
<b>description</b>	lava rock grid L 420mm W 268mm		

## tube burners

			
1			
<b>Part No.</b>	105409	<b>Ref. No.</b>	01184 RC01184000
<b>description</b>	tubular burner L 300mm W 75mm H 42mm for fryer oval		

			
1			
<b>Part No.</b>	104293	<b>Ref. No.</b>	00440 RC00440000
<b>description</b>	tubular burner ø 74mm L 200mm H 60mm round for fryer		

## solid top burners

			
1			
<b>Part No.</b>	105398	<b>Ref. No.</b>	01161 RC01161000
<b>description</b>	solid top burner ø 65mm H 102mm L 284mm		

## accessories

## nozzle holders

			
1			
<b>Part No.</b>	105399	<b>Ref. No.</b>	00414 RC00414000
<b>description</b>	nozzle holder		

## gas nozzles

## main nozzles

## gas nozzles M10x1

			
1			
<b>Part No.</b>	100477	<b>Ref. No.</b>	01195
<b>description</b>	gas injector thread M10x1 WS 12 bore ø 1.65mm		

## pilot burner nozzles

## pilot burner nozzles POLIDORO

			
1			
<b>Part No.</b>	106703	<b>Ref. No.</b>	RCK7042008
<b>description</b>	pilot burner nozzle POLIDORO natural gas code 27.2 bore ø 2x0.27mm Qty 1 pcs		



pilot burner nozzles SIT			
100 series			
			
1			
<b>Part No.</b>	100245	<b>Ref. No.</b>	00435 RC00435000
<b>description</b>	pilot burner nozzle LPG code 20 bore $\varnothing$ 0.2mm Qty 1 pcs thread M8x0.75		

			
1			
<b>Part No.</b>	100246	<b>Ref. No.</b>	00436 RC00436000
<b>description</b>	pilot burner nozzle natural gas bore $\varnothing$ 0.35mm Qty 1 pcs thread M8x0.75		

140/150 series			
			
1			
<b>Part No.</b>	100204	<b>Ref. No.</b>	RC01219000
<b>description</b>	pilot burner nozzle SIT LPG code 14 bore $\varnothing$ 0.18/0.20mm Qty 1 pcs suitable for 140 series		



			
1			
<b>Part No.</b>	100207	<b>Ref. No.</b>	RCK7042013
<b>description</b>	pilot burner nozzle SIT natural gas code 27 bore $\varnothing$ 0.40/0.38mm suitable for SIT 140 series		

## auxiliary gas parts

### screw connections

#### olives

			
1			
<b>Part No.</b>	106426	<b>Ref. No.</b>	RCK7070025
<b>description</b>	olive		

			
1			
<b>Part No.</b>	101274	<b>Ref. No.</b>	RCK7070036
<b>description</b>	olive for pipe $\varnothing$ 16mm Qty 1 pcs		
<b>accessories for</b>	101274		
	<b>Part No.</b>	101275	<b>Ref. No.</b>
			—
			
	union screw thread 1/2" for pipe $\varnothing$ 16mm Qty 1 pcs		

### union screws

			
1			
<b>Part No.</b>	100906	<b>Ref. No.</b>	RCK7050028
<b>description</b>	screw connection thread M10x1 for ignition electrode brass Qty 1 pcs WS 10		

### gas lines

#### pilot tubes

##### producer-specific

			
1			
<b>Part No.</b>	106883	<b>Ref. No.</b>	RC00125000 RC0082551
<b>description</b>	pilot tube tube $\varnothing$ 6mm L 245mm copper T1: M10x1 T2: M10x1 with screw connection		

### consumables

#### lava rocks / ceramic briquettes

			
1			
<b>Part No.</b>	211002	<b>Ref. No.</b>	50017 RC05001700
<b>description</b>	lava rocks size ca.40mm Qty 3.3Kg		



## equipment-specific units

## for vegetable slicers

## miscellaneous



1

<b>Part No.</b>	110703	<b>Ref. No.</b>	4205 RC00004205
-----------------	--------	-----------------	--------------------

**description** cylindrical handle thread M10 ø 28mm L 87mm

## for cheese graters

## miscellaneous



1

<b>Part No.</b>	110703	<b>Ref. No.</b>	4205 RC00004205
-----------------	--------	-----------------	--------------------

**description** cylindrical handle thread M10 ø 28mm L 87mm

## for cream whipping machines

## spare parts



1

<b>Part No.</b>	655001	<b>Ref. No.</b>	RC00492000
-----------------	--------	-----------------	------------

**description** angle piece for cream maker



1

<b>Part No.</b>	750219	<b>Ref. No.</b>	RC00003211
-----------------	--------	-----------------	------------

**description** container lid for cream maker



1

<b>Part No.</b>	750220	<b>Ref. No.</b>	RC00003511
-----------------	--------	-----------------	------------

**description** lid handle for cream maker mounting pos. front



1

<b>Part No.</b>	750221	<b>Ref. No.</b>	RC00003011
-----------------	--------	-----------------	------------

**description** lid handle for cream maker rear

## decorator tips



1

<b>Part No.</b>	696411	<b>Ref. No.</b>	RC00087000
-----------------	--------	-----------------	------------

**description** decorator tip for cream maker L 36mm ID ø 25mm ED ø 29.5mm

**For models:** POLOBAR

## for grills

## glass panels



1

<b>Part No.</b>	693152	<b>Ref. No.</b>	00213 RC00213000
-----------------	--------	-----------------	---------------------

**description** glass panel L 280mm W 65mm thickness 4mm rectangular

## for convection ovens/combi-steamers

## doors



1

<b>Part No.</b>	690585	<b>Ref. No.</b>	RCK2011212
-----------------	--------	-----------------	------------

**description** bush for door mechanism L 35mm ED ø 36mm int. ø 1 31mm int. ø 2 13mm mounting distance 28mm brass

## door mechanics

## miscellaneous





1

<b>Part No.</b>	690585	<b>Ref. No.</b>	RCK2011212
-----------------	--------	-----------------	------------

**description** bush for door mechanism L 35mm ED ø 36mm int. ø 1 31mm int. ø 2 13mm mounting distance 28mm brass



vibration pumps

 <p>1</p>			
<b>Part No.</b>	500568	<b>Ref. No.</b>	RC01969000
<b>description</b>	vibration pump 230V 32W 50Hz inlet ø 7 outlet ø 1/8" IT CEME type E512/A32		
<b>spare parts for</b>	500568		
	<b>Part No.</b>	390698	<b>Ref. No.</b> —
	thermal fuse switch-off temp. 110°C suitable for ULKA pump		
	<b>Part No.</b>	520153	<b>Ref. No.</b> —
	bracket rubber dimensions 53x34x28mm		

for toasters

pliers

pliers

 <p>1</p>			
<b>Part No.</b>	690010	<b>Ref. No.</b>	9014
<b>description</b>	plier for toaster H 180mm total length 100mm		

knobs

universal knobs

 <p>1</p>			
<b>Part No.</b>	110241	<b>Ref. No.</b>	00598 RC00598000
<b>description</b>	knob thermostat t.max. 110°C ø 50mm shaft ø 6x4.6mm shaft flat upper black temperature range 30-110°C		

producer-specific knobs

TECNOINOX

 <p>1</p>			
<b>Part No.</b>	110701	<b>Ref. No.</b>	06301 RC00006301
<b>description</b>	knob energyregulator 1-10 + MAX t.max.°C temperature range°C ø 38mm shaft ø 6x4.6mm shaft flat upper black		

 <p>1</p>			
<b>Part No.</b>	110081	<b>Ref. No.</b>	RC05001300
<b>description</b>	knob ø 70mm shaft ø 8x6.5mm shaft flat universal		

 <p>1</p>			
<b>Part No.</b>	110702	<b>Ref. No.</b>	00035 RC00035000
<b>description</b>	knob switch zero mark ø 40mm shaft ø 6x4.6mm shaft flat upper black		

 <p>1</p>			
<b>Part No.</b>	110709	<b>Ref. No.</b>	00086 01113 RC00001113 RC00086000
<b>description</b>	knob switch zero mark t.max.°C temperature range°C ø 38mm shaft ø 6x4.6mm shaft flat upper black		

 <p>1</p>			
<b>Part No.</b>	110241	<b>Ref. No.</b>	00598 RC00598000
<b>description</b>	knob thermostat t.max. 110°C ø 50mm shaft ø 6x4.6mm shaft flat upper black temperature range 30-110°C		

1 mechanical components, equipment accessories

1

<b>Part No.</b>	110708	<b>Ref. No.</b>	00287 RC00287000
<b>description</b>	knob energy regulator 1-6 + MAX t.max.°C temperature range°C ø 60mm shaft ø 6x4.6mm shaft flat left black		



1

<b>Part No.</b>	110711	<b>Ref. No.</b>	00289 RC00289000
<b>description</b>	knob switch 7-position t.max.°C temperature range°C ø 60mm shaft ø 6x4.6mm shaft flat right black		



1

<b>Part No.</b>	110716	<b>Ref. No.</b>	00538 RC00538000
<b>description</b>	knob gas tap with ignition flame t.max.°C temperature range°C ø 60mm shaft ø 8x6.5mm shaft flat lower black		



1

<b>Part No.</b>	110715	<b>Ref. No.</b>	00280 RC00280000
<b>description</b>	knob thermostat t.max. 190°C temperature range 10x9°C ø 60mm shaft ø 6x4.6mm shaft flat right black		



1

<b>Part No.</b>	110710	<b>Ref. No.</b>	00401 RC00401000
<b>description</b>	knob gas tap without ignition flame t.max.°C temperature range°C ø 60mm shaft ø 8x6.5mm shaft flat lower black		



1

<b>Part No.</b>	110707	<b>Ref. No.</b>	00495 RC00495000
<b>description</b>	knob thermostat t.max. 275°C temperature range 50-275°C ø 59mm shaft ø 6x4.6mm shaft flat right rotation 270° black		



1

<b>Part No.</b>	110714	<b>Ref. No.</b>	00448 RC00448000
<b>description</b>	knob gas thermostat 1-7 t.max.°C temperature range°C ø 60mm shaft ø 8x6.5mm shaft flat lower black		



1

<b>Part No.</b>	110713	<b>Ref. No.</b>	00284 RC00284000
<b>description</b>	knob thermostat t.max. 310°C temperature range 100-310°C ø 60mm shaft ø 6x4.6mm shaft flat right black		



1

<b>Part No.</b>	110938	<b>Ref. No.</b>	00917 RC00917000
<b>description</b>	knob gas thermostat t.max. 260°C ø 60mm shaft ø 8x6.5mm shaft flat lower black		



1

<b>Part No.</b>	110712	<b>Ref. No.</b>	00268 RC00268000
<b>description</b>	knob thermostat t.max. 90°C temperature range 30-90°C ø 60mm shaft ø 6x4.6mm shaft flat right rotation 270° black		



1			
<b>Part No.</b>	110706	<b>Ref. No.</b>	00494 RC00494000
<b>description</b>	knob time 50min ø 60mm shaft ø 6x4.6mm shaft flat right black		

1			
<b>Part No.</b>	110940	<b>Ref. No.</b>	01059 RC01059000
<b>description</b>	knob oven BH/TH/BH+TH ø 70mm shaft ø 6x4.6mm shaft flat right blue		

1			
<b>Part No.</b>	110937	<b>Ref. No.</b>	01070 RC01070000
<b>description</b>	knob energy regulator 1-6 + MAX ø 70mm shaft ø 6x4.6mm shaft flat left blue		

1			
<b>Part No.</b>	110944	<b>Ref. No.</b>	01249 RC01249000
<b>description</b>	knob switch 4-position ø 70mm shaft ø 6x4.6mm shaft flat left blue		

1			
<b>Part No.</b>	110943	<b>Ref. No.</b>	01172 RC01172000
<b>description</b>	knob gas thermostat 1-7 ø 70mm shaft ø 8x6.5mm shaft flat lower blue		

1			
<b>Part No.</b>	110936	<b>Ref. No.</b>	01109 RC01109000
<b>description</b>	knob switch 7-position ø 70mm shaft ø 6x4.6mm shaft flat right blue		

1			
<b>Part No.</b>	110939	<b>Ref. No.</b>	01152 RC01152000
<b>description</b>	knob gas thermostat t.max. 290°C temperature range 150-290°C ø 70mm shaft ø 8x6.5mm shaft flat upper blue		

1			
<b>Part No.</b>	110946	<b>Ref. No.</b>	01121 RC01121000
<b>description</b>	knob thermostat t.max. 190°C temperature range 100-190°C ø 70mm shaft ø 6x4.6mm shaft flat right blue		

1			
<b>Part No.</b>	110732	<b>Ref. No.</b>	01011 RC01011000
<b>description</b>	knob graduated ø 70mm shaft ø 6x4.6mm shaft flat left blue		

1			
<b>Part No.</b>	110942	<b>Ref. No.</b>	01079 RC01079000
<b>description</b>	knob thermostat t.max. 300°C temperature range 100-300°C ø 70mm shaft ø 6x4.6mm shaft flat right rotation 270° blue		

1

<b>Part No.</b>	110941	<b>Ref. No.</b>	01060 RC01060000
<b>description</b>	knob thermostat t.max. 300°C temperature range 60-300°C ø 70mm shaft ø 6x4.6mm shaft flat right rotation 270° blue		



1

<b>Part No.</b>	110945	<b>Ref. No.</b>	01085 RC01085000
<b>description</b>	knob thermostat t.max. 90°C temperature range 30-90°C ø 70mm shaft ø 6x4.6mm shaft flat right blue		

## handles and hand wheels

### cylindrical handles

#### fixed



1

<b>Part No.</b>	110703	<b>Ref. No.</b>	4205 RC00004205
<b>description</b>	cylindrical handle thread M10 ø 28mm L 87mm		

### cone handles



1

<b>Part No.</b>	110704	<b>Ref. No.</b>	00329 RC00329000
<b>description</b>	cone handle thread M6 ø 16mm L 25mm plastic black		

### mushroom cap handles



1

<b>Part No.</b>	110705	<b>Ref. No.</b>	00323 RC00323000
<b>description</b>	mushroom cap handle thread M5 handle ø 25mm L 19mm plastic black		

### bracket handles



1

<b>Part No.</b>	700551	<b>Ref. No.</b>	3101 70501611 RC00003101
<b>description</b>	pull handle L 200mm H 62mm mounting distance 179mm handle M8		

### lever handles



1

<b>Part No.</b>	211098	<b>Ref. No.</b>	RC05001900
<b>description</b>	handle ø 28mm L 89mm thread M10x1 black		

## locks

### handle latches

#### producer-specific

#### TECNOINOX



1

<b>Part No.</b>	694067	<b>Ref. No.</b>	RC01940000
<b>description</b>	door catch with spigot 1-stage L 26mm total length 51mm thread M8		



espagnolette locks

universal

			
1			
<b>Part No.</b>	690041	<b>Ref. No.</b>	RCK5900121
<b>description</b>	cam L 148mm mounting distance 32mm		

			
1			
<b>Part No.</b>	690040	<b>Ref. No.</b>	RCK5900122
<b>description</b>	door catch with roller H 42mm L 40mm W 40mm zinc die cast mounting distance 26mm type 0751 series		



			
1			
<b>Part No.</b>	700771	<b>Ref. No.</b>	RCK5900123
<b>description</b>	latch gear opening to the left shaft intake $\varnothing$ 8x8mm L 170mm W 40mm H 40mm		

hinges

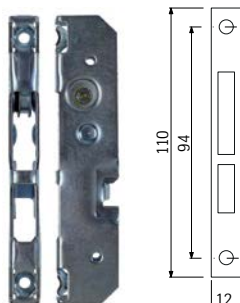
oven hinges

			
1			
<b>Part No.</b>	700003	<b>Ref. No.</b>	00804 RC00804000
<b>description</b>	opposite support L 110mm W 12mm mounting distance 94mm		

			
1			
<b>Part No.</b>	690496	<b>Ref. No.</b>	00940 RC00940000
<b>description</b>	oven hinge mounting distance 118mm lug mounting 13mm lever length 119mm groove distance 12mm spring thickness 3.5mm mounting ear position left spring length 59mm mounting pos. W 21mm		



			
1			
<b>Part No.</b>	690498	<b>Ref. No.</b>	00802 RC00802000
<b>description</b>	oven hinge mounting distance 118mm lug mounting 13mm lever length 119mm groove distance 12mm spring thickness 4mm mounting ear position right spring length 59mm L 155mm W 21mm		
<b>accessories for</b>	690498		
	<b>Part No.</b>	700003	<b>Ref. No.</b>
			00804 RC00804000
	opposite support L 110mm W 12mm mounting distance 94mm		



			
1			
<b>Part No.</b>	694505	<b>Ref. No.</b>	00803 RC00803000
<b>description</b>	oven hinge mounting distance 118mm mounting distance 2mm lug mounting 13mm lever length 125mm groove distance 12mm spring thickness 4mm mounting ear position left spring length 59mm L 155mm W 21mm with hook		

			
1			
<b>Part No.</b>	690495	<b>Ref. No.</b>	00939 RC00939000
<b>description</b>	oven hinge mounting distance 118mm spring thickness 3.5mm spring length 59mm L 155mm mounting pos. right W 22mm C 13mm D 119mm		



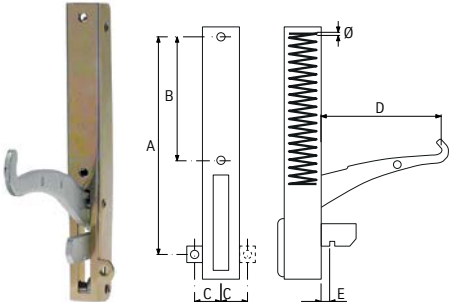

			
<b>Part No.</b>	700006	<b>Ref. No.</b>	01067 RC01067000
<b>description</b>	oven hinge mounting distance 173mm mounting distance 2 105mm lug mounting 14mm lever length 120mm groove distance 11mm spring thickness 3.5mm mounting ear position left spring length 112mm W 25mm		
<b>accessories for</b>	700006		
	<b>Part No.</b>	700001	<b>Ref. No.</b> —
	opposite support L 118mm W 17mm mounting distance 94mm		
	<b>Part No.</b>	700007	<b>Ref. No.</b> 01068 RC01068000
	oven hinge mounting distance 173mm mounting distance 2 105mm lug mounting 14mm lever length 120mm groove distance 11mm spring thickness 3.5mm mounting ear position right spring length 112mm W 25mm		

			
<b>Part No.</b>	700007	<b>Ref. No.</b>	01068 RC01068000
<b>description</b>	oven hinge mounting distance 173mm mounting distance 2 105mm lug mounting 14mm lever length 120mm groove distance 11mm spring thickness 3.5mm mounting ear position right spring length 112mm W 25mm		
<b>accessories for</b>	700007		
	<b>Part No.</b>	700001	<b>Ref. No.</b> —
	opposite support L 118mm W 17mm mounting distance 94mm		

## fittings for catering equipment



### inlet taps

			
<b>Part No.</b>	514048	<b>Ref. No.</b>	00583 RC00583000
<b>description</b>	ball valve connection 1/2" complete total length 55mm mounting pos. any brass H 30mm L 55mm rosette ø 70mm rosette thread G2 M22x1		
<b>spare parts for</b>	514048		
	<b>Part No.</b>	540871	<b>Ref. No.</b> —
	lever handle cold water suitable for intake tap		

## baskets

### fryer baskets

#### TECNOINOX

			
<b>Part No.</b>	970188	<b>Ref. No.</b>	00024 RC00024000
<b>description</b>	fryer basket L1 245mm W1 130mm H1 100mm		
			
<b>Part No.</b>	970194	<b>Ref. No.</b>	00055 RC00055000
<b>description</b>	fryer basket L1 245mm W1 220mm H1 100mm		





1

<b>Part No.</b>	970139	<b>Ref. No.</b>	00678 RC00678000
<b>description</b>	fryer basket L1 265mm W1 210mm H1 105mm L2 480mm H2 147mm H3 205mm chrome-plated steel		



1

<b>Part No.</b>	970420	<b>Ref. No.</b>	RC01295000
<b>description</b>	fryer basket L1 290mm W1 105mm H1 120mm L2 490mm H2 170mm H3 200mm chrome-plated steel		



1

<b>Part No.</b>	970147	<b>Ref. No.</b>	00076 RC00076000
<b>description</b>	fryer basket L1 290mm W1 220mm H1 100mm L2 540mm H2 230mm H3 175mm chrome-plated steel		

pasta baskets

TECNOINOX



1

<b>Part No.</b>	970387	<b>Ref. No.</b>	00606 RC00606000
<b>description</b>	pasta basket H1 200mm W1 290mm L1 145mm H3 343mm stainless steel		
<b>accessories for</b>	970387		
	<b>Part No.</b>	691314	<b>Ref. No.</b> —
	cylindrical handle thread M8 ø 28mm L 86mm		



1

<b>Part No.</b>	970388	<b>Ref. No.</b>	00603 RC00603000
<b>description</b>	pasta basket H1 200mm W1 290mm L1 290mm H3 340mm stainless steel		



1

<b>Part No.</b>	970385	<b>Ref. No.</b>	00605 RC00605000
<b>description</b>	pasta basket left H1 200mm W1 145mm L1 145mm H3 340mm stainless steel		



1

<b>Part No.</b>	970386	<b>Ref. No.</b>	00604 RC00604000
<b>description</b>	pasta basket right H1 200mm W1 145mm L1 145mm H3 340mm stainless steel		

gaskets

gaskets for heated units

door seals

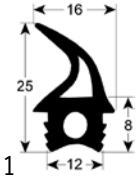

1

<b>Part No.</b>	902409	<b>Ref. No.</b>	RCK7070100
<b>description</b>	door seal profile 2714 Qty supplied by meter suitable for GIORIK		

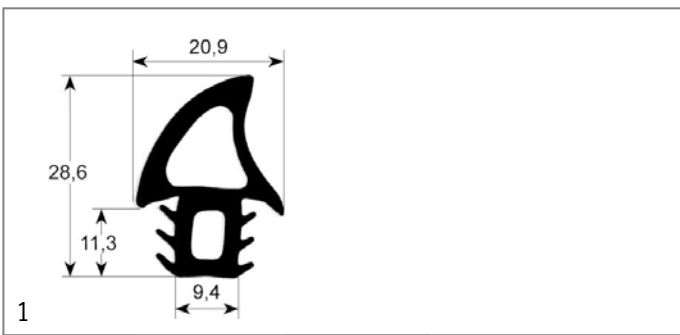

<b>Part No.</b>	900439	<b>Ref. No.</b>	RCK7070166
<b>description</b>	door seal profile 2750 Qty supplied by meter		

door seals with fixing hook



<b>Part No.</b>	901434	<b>Ref. No.</b>	RC70044040
<b>description</b>	door seal W 600mm with 6 mounting clips H 400mm		

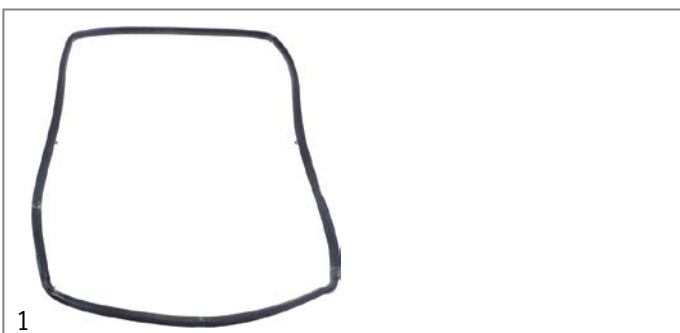

<b>Part No.</b>	901371	<b>Ref. No.</b>	RC70044030
<b>description</b>	oven gasket L 540mm W 390mm with 6 mounting clips		

O-rings

EPDM

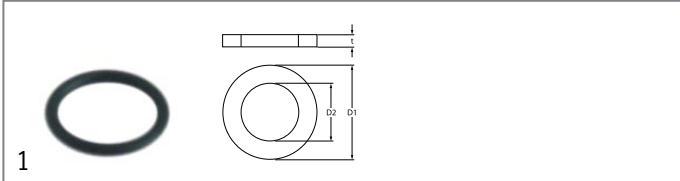

<b>Part No.</b>	529545	<b>Ref. No.</b>	RC00002611
<b>description</b>	O-ring EPDM thickness 1.78mm ID $\varnothing$ 10.82mm Qty 1 pcs		
<b>For models:</b>	POLOBAR		

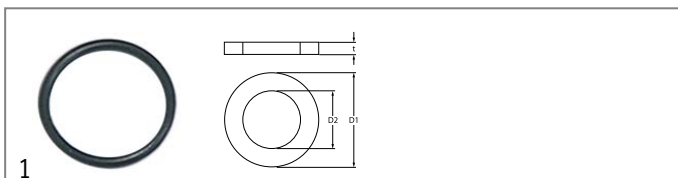

<b>Part No.</b>	532011	<b>Ref. No.</b>	RC00009011
<b>description</b>	O-ring EPDM thickness 1.78mm ID $\varnothing$ 17.17mm Qty 10 pcs		
<b>For models:</b>	POLOBAR		

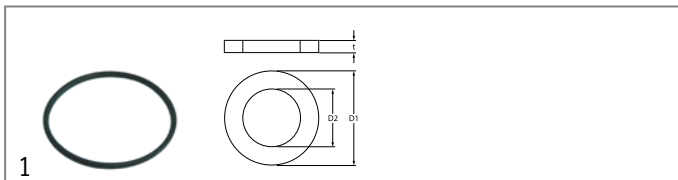

<b>Part No.</b>	510824	<b>Ref. No.</b>	RC00007811
<b>description</b>	O-ring EPDM thickness 1.78mm ID $\varnothing$ 20.35mm Qty 1 pcs		

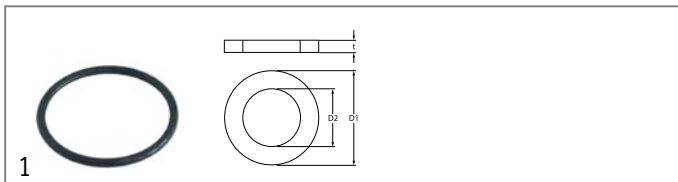

<b>Part No.</b>	532014	<b>Ref. No.</b>	RC00003315
<b>description</b>	O-ring EPDM thickness 1.78mm ID $\varnothing$ 21.95mm Qty 10 pcs		
<b>For models:</b>	POLOBAR		

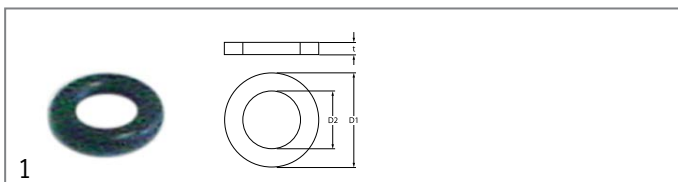

<b>Part No.</b>	532003	<b>Ref. No.</b>	RC00009511
<b>description</b>	O-ring EPDM thickness 1.78mm ID $\varnothing$ 3.69mm Qty 10 pcs		

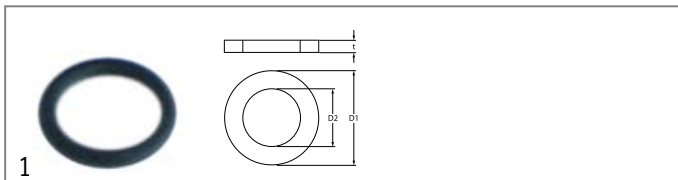

<b>Part No.</b>	510177	<b>Ref. No.</b>	RC00008711
<b>description</b>	O-ring EPDM thickness 1.78mm ID $\varnothing$ 7.66mm Qty 1 pcs		
<b>For models:</b>	POLOBAR		

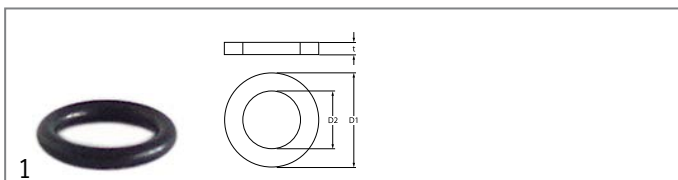

<b>Part No.</b>	532050	<b>Ref. No.</b>	RC00008911
<b>description</b>	O-ring EPDM thickness 2.62mm ID $\varnothing$ 11.91mm Qty 10 pcs		
<b>For models:</b>	POLOBAR		



1

<b>Part No.</b>	532053	<b>Ref. No.</b>	RC00008012
<b>description</b>	O-ring EPDM thickness 2.62mm ID ø 15.88mm Qty 10 pcs		

1

<b>Part No.</b>	511513	<b>Ref. No.</b>	RC00009711
<b>description</b>	O-ring EPDM thickness 2.62mm ID ø 20.24mm Qty 10 pcs		

1

<b>Part No.</b>	532081	<b>Ref. No.</b>	RC00007211
<b>description</b>	O-ring EPDM thickness 2.62mm ID ø 60mm Qty 10 pcs		

1

<b>Part No.</b>	532118	<b>Ref. No.</b>	RCK6090145
<b>description</b>	O-ring EPDM thickness 3.53mm ID ø 55.56mm Qty 10 pcs		

shaft gaskets

shaft gaskets

1

<b>Part No.</b>	550549	<b>Ref. No.</b>	RCK7070150
<b>description</b>	shaft sealing for fan motor		

1

<b>Part No.</b>	550550	<b>Ref. No.</b>	RCK7070151
<b>description</b>	shaft sealing for fan motor		

fittings, hose and pipe connectors

fittings

angle pieces

1

<b>Part No.</b>	520824	<b>Ref. No.</b>	RCK7050374
<b>description</b>	angle piece thread 1/8" ET - 1/8" IT nickel-plated brass		

push-in fittings

JOHN GUEST

1

<b>Part No.</b>	520494	<b>Ref. No.</b>	RC01922000	
<b>description</b>	push-in fitting John Guest angled pipe connection ø10mm - ø10mm			
<b>accessories for</b>	520494			
	<b>Part No.</b>	520973	<b>Ref. No.</b>	—
	hose John Guest thickness 1.5mm LLDPE blue ID ø 7mm ED ø 10mm			

1

<b>Part No.</b>	520495	<b>Ref. No.</b>	RC01927000	
<b>description</b>	push-in fitting John Guest straight thread 1/8" BSP stub ø 8mm			
<b>accessories for</b>	520495			
	<b>Part No.</b>	520971	<b>Ref. No.</b>	—
	hose thickness 1mm LLDPE blue ID ø 4mm ED ø 6mm operating pressure at 20°C 16bar			



## valves and tank inlets

## ball valves

universal

ball valves with lever handle



1

<b>Part No.</b>	540758	<b>Ref. No.</b>	00579 RC00579000
<b>description</b>	ball valve connection 1" IT - 1" ET DN25 total length 90mm with lever handle handle length 95mm		

## fastening material

## nuts

hexagonal nuts

hexagonal nuts metric (without norm)



1

<b>Part No.</b>	102067	<b>Ref. No.</b>	00865 RC00865000
<b>description</b>	nut thread M8x1 H 3mm brass Qty 1 pcs type SEF 1		

## consumables

## lava rocks / ceramic briquettes



1

<b>Part No.</b>	211002	<b>Ref. No.</b>	50017 RC05001700
<b>description</b>	lava rocks size ca.40mm Qty 3.3Kg		

## fuses

## fine fuses



1

<b>Part No.</b>	358677	<b>Ref. No.</b>	RC01861000
<b>description</b>	fine fuse size ø5x20mm 4A fast-acting rated 250V Qty 10 pcs		

**GASTRO**PARTS.COM

