



GASTROPARTS

Tecnoeka

- [EN]** Equipment
- [DE]** Geräte
- [ES]** Aparatos
- [FR]** Équipement
- [IT]** Attrezzature
- [PL]** Urządzenia
- [RU]** Оборудование

✉ gastroparts@gastroparts.com

☎ +48 56 657 00 66

📘 fb.com/gastroparts.global

GASTROPARTS.COM





heating elements

heating elements for ovens

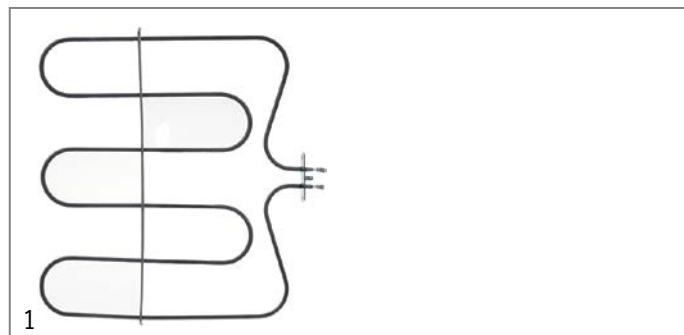

Part No.	416969	Ref. No.	01200870 01203250 09950327000 SP007950067
description	heating element 1400W 230V heating circuits 1 L 370mm W 400mm L1 45mm L2 325mm W1 184mm W2 30mm flange length 70mm flange width 22mm hole distance 46mm bridge length 420mm hole ø 5mm tube ø 6.3mm connection male faston 6.3mm windings 3 rectangular flange dry heating element		
For models:	648 CI, EKF423ALM, EKF423M, KF723M		
accessories for	416969		
	Part No.	510368	Ref. No. —
	gasket L 70mm W 23.5mm hole ø 5mm hole distance 56mm FIBER thickness 2mm for heating element		

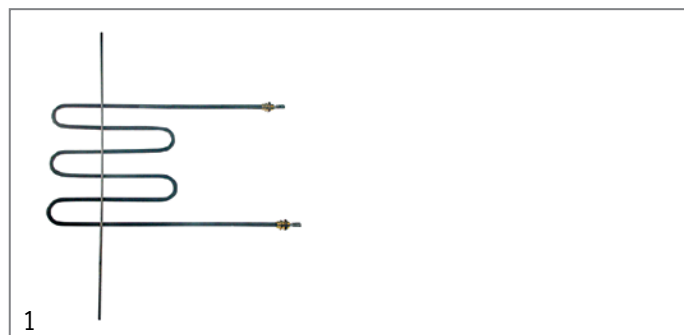

Part No.	416968	Ref. No.	09950027000
description	heating element 2000W 230V heating circuits 1 L 347mm thread 1/4" W 215mm tube ø 6.3mm mounting distance 209mm bridge length 490mm connection male faston 6.3mm 2 hole fixing dry heating element		
For models:	640 CI+GRILL		

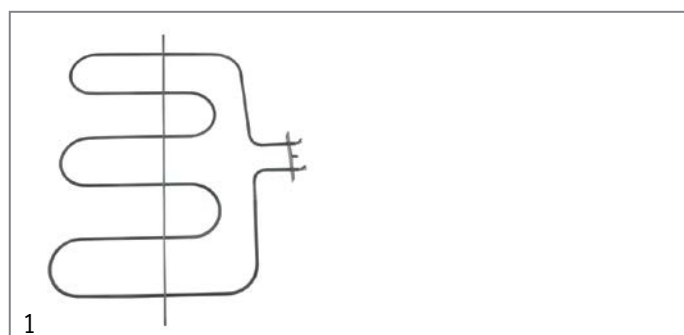

Part No.	416971	Ref. No.	09950447000
description	heating element 2000W 230V heating circuits 1 L 428mm W 505mm L1 67mm L2 357mm W1 222mm W2 60mm flange length 100mm flange width 22mm hole distance 86mm bridge length 600mm hole ø 5mm tube ø 6.3mm connection male faston 6.3mm windings 3 rectangular flange dry heating element		
For models:	938.3, KF965M		

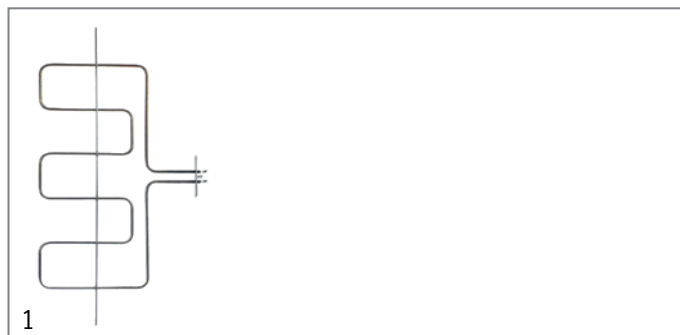

Part No.	419251	Ref. No.	01200261 01200262 01951017000
description	heating element 2500W 230V heating circuits 1 L 360mm W 530mm L1 110mm L2 250mm W1 250mm W2 30mm flange length 100mm flange width 22mm hole distance 86mm bridge length 700mm hole ø 5mm tube ø 6.5mm connection male faston 6.3mm windings 3		
For models:	EKF411.3GRILL, EKF464.3GRILL, KC96V, KCV96, KCV96P		

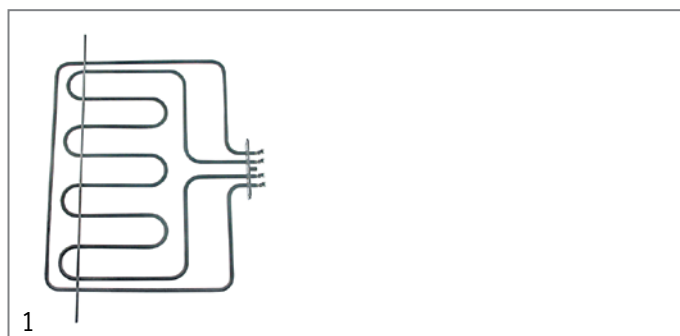

Part No.	416970	Ref. No.	01200860 01203240 09950317000 SP007950066
description	heating element 2800W 230V heating circuits 2 L 323mm W 393mm L1 30mm L2 293mm W1 166mm W2 61mm flange length 100mm flange width 22mm hole distance 76mm bridge length 485mm hole ø 5mm tube ø 6.3mm connection male faston 6.3mm rectangular flange dry heating element		
For models:	648 CI, EKF423ALM, EKF423M, KF723M		
accessories for	416970		
	Part No.	528090	Ref. No. 01000160 01980518000
	gasket L 100mm W 22mm thickness 1mm		

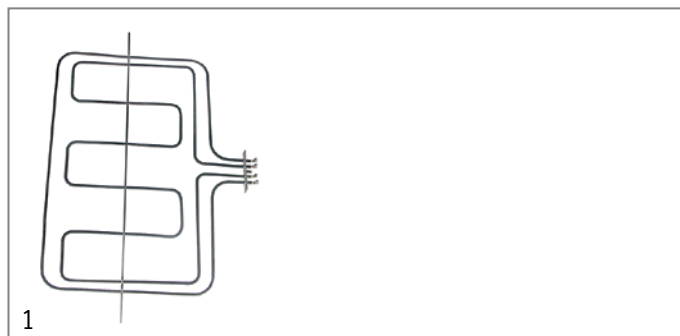

Part No.	416972	Ref. No.	01200910 09950457000
description	heating element 3700W 230V heating circuits 2 L 442mm W 575mm L1 73mm L2 369mm W1 258mm W2 60mm flange length 100mm flange width 22mm hole distance 86mm bridge length 700mm hole ø 5mm tube ø 6.3mm connection length 28mm rectangular flange dry heating element		
For models:	938.3, KF965M		



heating elements for heated cabinets



Part No.	419155	Ref. No.	01201441 01201441+30303201
description	heating element 1200W 230V heating circuits 1 L 350mm W 150mm connection male faston 6.3mm tube ø 6.3mm thread M12x1.25 mounting distance 145mm		



Part No.	418860	Ref. No.	10950017000 10950017000-1
description	heating element 800W 230V heating circuits 1 L 345mm W 90mm thread M12x1.5 mounting distance 83mm tube ø 6.5mm connection male faston 6.3mm dry heating element 2 hole fixing		
For models:	KL823, KL864, KL898		

heating elements for convection



Part No.	418042	Ref. No.	01200390 01951147000
description	heating element 1200W 230V heating circuits 1 ID ø 180mm ED ø 194mm L 245mm H 34mm L1 44mm W1 31mm H1 15mm H2 18mm flange length 70mm flange width 22mm hole distance 56mm connection male faston 6.3mm tube ø 6.3mm convection heating element hole ø 5mm rectangular flange		
For models:	KCV96, KCV96P		
spare parts for	418042		
	Part No.	510368	Ref. No. —
	gasket L 70mm W 23.5mm hole ø 5mm hole distance 56mm FIBER thickness 2mm for heating element		



Part No.	415119	Ref. No.	01201010
description	heating element 1600W 230V heating circuits 1 ID ø 179mm ED ø 197mm L 254mm H 30mm L1 51mm W1 31mm H1 9mm H2 21mm flange length 70mm flange width 22mm hole distance 56mm connection male faston 6.3mm connection length 41mm tube ø 6.3mm convection heating element hole ø 4mm rectangular flange		
accessories for	415119		
	Part No.	510368	Ref. No. —
	gasket L 70mm W 23.5mm hole ø 5mm hole distance 56mm FIBER thickness 2mm for heating element		



Part No.	418043	Ref. No.	09950987000
description	heating element 1600W 230V heating circuits 1 ID ø 180mm ED ø 192mm L 245mm H 25mm L1 45mm W1 30mm H1 12mm H2 18mm flange length 70mm flange width 22mm hole distance 56mm connection male faston 6.3mm tube ø 6.3mm convection heating element hole ø 5mm rectangular flange		
For models:	900, KF912, KF912IX		
spare parts for	418043		
	Part No.	510368	Ref. No. —
	gasket L 70mm W 23.5mm hole ø 5mm hole distance 56mm FIBER thickness 2mm for heating element		





Part No.	418045	Ref. No.	01950137000
description	heating element 2200W 230V heating circuits 1 ID ø 175mm ED ø 187mm L 246mm H 25mm L1 58mm W1 31mm H1 7mm H2 18mm flange length 70mm flange width 22mm hole distance 56mm connection male faston 6.3mm tube ø 6.3mm convection heating element hole ø 5mm flange 70 x 22mm		
For models:	938.3		
accessories for	418045		
	Part No.	510368	Ref. No. —
	gasket L 70mm W 23.5mm hole ø 5mm hole distance 56mm FIBER thickness 2mm for heating element		





Part No.	418044	Ref. No.	01200080 01201000 01203260 09950977000
description	heating element 2500W 230V heating circuits 1 ID ø 180mm ED ø 192mm L 245mm H 28mm L1 45mm W1 30mm H1 3mm H2 25mm flange length 70mm flange width 22mm hole distance 56mm connection male faston 6.3mm tube ø 6.3mm convection heating element hole ø 5mm rectangular flange		
For models:	440, 640 CI, 640 CI+GRILL, 640 CI+U, 648 CI, 930, 938.3, CV5-90/X, EKF411.3D, EKF411.3GRILL, EKF412US, EKF423ALM, EKF423M, EKF464.3D, EKF464.3GRILL, KC96V, KCV96, KCV96P, KF412, KF412U, KF723, KF723M		
accessories for	418044		
	Part No.	550937	Ref. No. 01000140 01960368000
	gasket L 71mm W 21mm hole ø 5mm hole distance 57mm fibre thickness 1mm for heating element		





			
1			
Part No.	420507	Ref. No.	01201210 01203220 09952477000
description	heating element 2700W 230V heating circuits 1 ID ø 180mm ED ø 192mm L 240mm H 250mm L1 54mm W1 30mm H1 30mm H2 24mm flange length 70mm flange width 22mm hole distance 56mm connection F6.3 tube ø 6.5mm hole ø 4.5mm mounting pos. rear		
For models:	EKF423, EKF423AL, EKF423ALP, EKF423ALU, EKF423ALUD, EKF423ALUP, EKF423DALUD, EKF423DUD, EKF423P, EKF423U, EKF423UD, EKF423UP, EKF620S, EKF620US		

			
1			
Part No.	419016	Ref. No.	01200800 11950537000
description	heating element 3000W 230V heating circuits 1 ID ø 227mm ED ø 240mm L 265mm H 50mm L1 21mm W1 30mm H1 18mm H2 32mm flange length 70mm flange width 22mm hole distance 56mm connection male faston 6.3mm connection length 34mm tube ø 6.5mm convection heating element hole ø 5mm		
For models:	KF733, KF933, KF933AL, KF933AL-U, KF933U, KF965, KF965AL-UD, KF965M, KF981-DOUBLE-EV, KF981-DOUBLE-EV-UD, KF981-DOUBLEEV-UI, KF981EV		

			
1			
Part No.	418894	Ref. No.	11950537000
description	heating element 3000W 230V heating circuits 1 ID ø 210mm ED ø 225mm L 260mm H 45mm L1 30mm W1 31mm H1 12.5mm H2 32.5mm flange length 70mm flange width 22mm hole distance 56mm connection male faston 6.3mm connection length 47mm tube ø 6.3mm hole ø 5mm		

			
1			
Part No.	420506	Ref. No.	01201300
description	heating element 3500W 230V heating circuits 1 ID ø 218mm ED ø 232mm H 46mm L1 264mm W1 32mm H1 8mm H2 38mm hole distance 57mm connection F6.3 tube ø 8.5mm hole ø 5mm mounting pos. rear		
For models:	EKF311DUD, EKF311UD, EKF364DUD, EKF364UD		

			
1			
Part No.	420508	Ref. No.	01201610 01202671
description	heating element 3000W 230V heating circuits 1 ID ø 215mm ED ø 226mm L 261mm H 40mm L1 15mm H1 10mm H2 27mm flange length 70mm flange width 22mm hole distance 57mm connection F6.3 tube ø 6.5mm		
For models:	EKF411ALUD, EKF411DALUD, EKF411DUD, EKF411UD, EKF416ALUD, EKF416DALUD, EKF416DUD, EKF416UD, EKF443DUD, EKF464ALP, EKF464ALUD, EKF464DALUD, EKF464DUD, EKF464UD, EKF523EUD, EKF523UD		

			
1			
Part No.	419024	Ref. No.	01200810 09950247000
description	heating element 4000W 230V heating circuits 1 ID ø 217mm ED ø 233mm L 265mm H 50mm L1 25mm W1 33mm H1 5mm H2 45mm flange length 70mm flange width 22mm hole distance 56mm connection male faston 6.3mm connection length 29mm tube ø 8.5mm convection heating element hole ø 5mm rectangular flange oven		
For models:	KF981, KF981-DOUBLE, KF981-DOUBLE-EV-UD, KF981-DOUBLE-EV-UI, KF981-DOUBLE-UD, KF981-DOUBLE-V, KF981-DOUBLE-V-UD, KF981-DOUBLE-V-UI, KF981UD, KF981V		
accessories for	419024		
	Part No.	510368	Ref. No. —
	 gasket L 70mm W 23.5mm hole ø 5mm hole distance 56mm FIBER thickness 2mm for heating element		





			
1			
Part No.	419215	Ref. No.	01203130
description	heating element 4000W 230V heating circuits 2 ID ø 220mm ED ø 230mm L 262mm H 60mm L1 20mm W1 92mm H1 10mm H2 50mm flange length 100mm flange width 22mm hole distance 86mm connection F6.3 tube ø 6.5mm hole ø 5mm threaded		
For models:	EKF616EUD, EKF616UD, EKF664.3EUD, EKF664EUD, EKF664P, EKF664UD, EKF711.3EUD, EKF711EUD, EKF711EV, EKF711UD		

			
1			
Part No.	420509	Ref. No.	01202660
description	heating element 5000W 230V heating circuits 2 ID ø 225mm ED ø 235mm L 248mm H 60mm L1 18mm W1 90mm H1 18mm H2 50mm flange length 100mm flange width 22mm hole distance 85mm connection F6.3 tube ø 6.5mm hole ø 4mm		
For models:	EKF1016EUD, EKF1016UD, EKF1064EUD, EKF1064TC, EKF1064UD, EKF1111EUD, EKF1111EVUD, EKF1111TC, EKF1111UD, EKF664.3EUD, EKF664TC, EKF711.3EUD, EKF711TC		

accessories

flange gaskets

			
1			
Part No.	528090	Ref. No.	01000160 01980518000
description	gasket L 100mm W 22mm thickness 1mm		
For models:	EKF411.3GRILL, EKF423ALM, EKF423M, EKF464.3GRILL, KCV96, KCV96P, KF723M, KF965M, TCFG		

			
1			
Part No.	528963	Ref. No.	0196036800
description	gasket L 70mm W 22.5mm fibre thickness 1mm		

			
1			
Part No.	550937	Ref. No.	01000140 01960368000
description	gasket L 71mm W 21mm hole ø 5mm hole distance 57mm fibre thickness 1mm for heating element		
For models:	EKF411, EKF411.3D, EKF411.3GRILL, EKF411D, EKF412US, EKF423, EKF423AL, EKF423ALM, EKF423ALP, EKF423ALU, EKF423ALUP, EKF423M, EKF423P, EKF423U, EKF423UP, EKF464, EKF464.3D, EKF464.3GRILL, EKF464D, EKF620S, EKF620US, KCV96, KCV96P, KF412, KF412U, KF620, KF622, KF630, KF723, KF723M, KF733, KF912, KF912IX, KF933, KF933AL, KF933AL-U, KF933U, KF937, KF965, KF965AL-UD, KF965M, KF981, KF981-DOUBLE, KF981-DOUBLE-EV, KF981-DOUBLE-EV-UD, KF981-DOUBLE-EV-UI, KF981-DOUBLE-UD, KF981-DOUBLE-V, KF981-DOUBLE-V-UD, KF981-DOUBLE-V-UI...(Other models you can see in the webshop)		

energy regulators

EGO

1-circuit

			
1			
Part No.	380015	Ref. No.	01201450 11950017000
description	energy regulator 230V 13A single-circuit turn direction right shaft ø 6x4.6mm shaft L 23mm mounting thread M4 power release 6-100% no. 50.57021.010		
For models:	EKF1016UD, EKF1064UD, EKF1111UD, EKF311UD, EKF364UD, EKF411ALUD, EKF411UD, EKF416ALUD, EKF416UD, EKF464ALUD, EKF464UD, EKF523UD, EKF616UD, EKF664UD, EKF711UD, KF981, KF981-DOUBLE, KF981-DOUBLE-EV-UD, KF981-DOUBLE-EV-UI, KF981-DOUBLE-UD, KF981-DOUBLE-V-UD, KF981-DOUBLE-V-UI, KF981UD		



thermostats

control and safety thermostats

EGO

control thermostats

55.10/19_ series

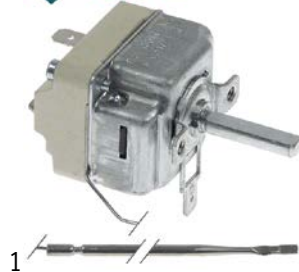

Part No.	375463	Ref. No.	01201310 09953137000
description	thermostat t.max. 277°C 1-pole 1NO 16A probe ø 3.03mm probe L 139mm capillary pipe 870mm capillary pipe isolatedmm gland nut shaft ø 6x4.6mm shaft L 23mm		
For models:	EKF1016UD, EKF1064UD, EKF1111UD, EKF523UD, EKF616UD, EKF664P, EKF664UD, EKF711UD, KF733		



Part No.	375595	Ref. No.	01201550 11950417000
description	thermostat t.max. 303°C temperature range 71-303°C 1-pole 1NO 16A probe ø 3mm probe L 114mm capillary pipe 1230mm capillary pipe isolatedmm gland nut shaft ø 6x4.6mm shaft L 23mm shaft position upper rotation 270° with 2 probes		
For models:	EKF411ALUD, EKF411UD, EKF416ALUD, EKF416UD, EKF464ALP, EKF464ALUD, EKF464P, EKF464UD, KCP97-VG-A, KCV96, KCV96P, KF1001G, KF1001G-IX-AL, KF1001G-LPG, KF1001G-LPG-IX-AL		



Part No.	375800	Ref. No.	09952637000
description	thermostat t.max. 308°C temperature range 65-308°C 1-pole 1NO 16A probe ø 3.03mm probe L 120mm capillary pipe 600mm capillary pipe isolatedmm gland nut shaft ø 6x4.6mm shaft L 23mm shaft position upper rotation 270° with 2 probes		
For models:	KF723M, KF933, KF933AL, KF933AL-U, KF933U, KF965, KF965AL-UD, KF965M, KF981, KF981-DOUBLE, KF981-DOUBLE-EV-UD, KF981-DOUBLE-EV-UI, KF981-DOUBLE-UD, KF981-DOUBLE-V, KF981-DOUBLE-VUD, KF981-DOUBLE-V-UI, KF981UD, KF981V		

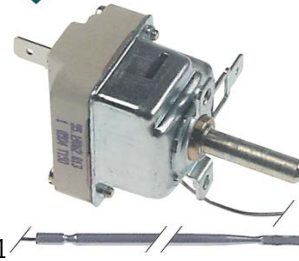

Part No.	375594	Ref. No.	01200370 01950267000 01951317000
description	thermostat t.max. 318°C temperature range 60-318°C 1-pole 1NO 16A probe ø 3.03mm probe L 139mm capillary pipe 870mm capillary pipe isolatedmm gland nut shaft ø 6x4.6mm shaft L 23mm shaft position upper rotation 270°		
For models:	440, 640 CI, 640 CI+U, EKF311UD, EKF364UD, EKF412US, EKF423, EKF423AL, EKF423ALP, EKF423ALU, EKF423ALUD, EKF423ALUP, EKF423P, EKF423U, EKF423UD, EKF423UP, EKF620S, EKF620US, KF412, KF412U, KF620, KF622, KF630, KF723, KF937		



Part No.	375799	Ref. No.	01201230 09952647000
description	thermostat t.max. 325°C temperature range 55-325°C 1-pole 1NO 16A probe ø 3.03mm probe L 120mm capillary pipe 600mm capillary pipe isolatedmm gland nut shaft ø 6x4.6mm shaft L 23mm shaft position upper rotation 270° with 2 probes		
For models:	EKF411, EKF411.3GRILL, EKF464, EKF464.3GRILL, KF912, KF912IX		

safety thermostats

55.32_ series



Part No.	390999	Ref. No.	01202690
description	safety thermostat switch-off temp. 350°C temperature range°C 2-pole NC 20A probe ø 3mm probe L 187mm capillary pipe 690mm capillary pipe isolated 680mm gland nut shaft ømm probe SS		
For models:	EKF412US, EKF423, EKF423AL, EKF423ALM, EKF423ALU, EKF423ALUD, EKF423DALUD, EKF423DUD, EKF423M, EKF423U, EKF423UD, EKF-443DUD, EKF523EUD, EKF523UD		



IMIT / TEMPOMATIC / ARTHERMO

control thermostats



Part No.	375847	Ref. No.	01201430
description	thermostat t.max. 90°C temperature range 0-90°C 1-pole 1CO 15A probe ø 6.5mm probe L 100mm capillary pipe 1500mm capillary pipe isolatedmm gland nut shaft ø 6x4.6mm shaft L 18mm shaft position +135° rotation 270° 250V		

CAEM

safety thermostats



Part No.	375597	Ref. No.	01201190 09952387000
description	safety thermostat switch-off temp. 335°C 1-pole 16A probe ø 5mm probe L 80mm capillary pipe 900mm capillary pipe isolatedmm gland nut probe SS		
For models:	900, 938.3, KF912, KF912IX, KF933, KF933AL, KF933AL-U, KF933U, KF937, KF965, KF965AL-UD, KF965M, KF981, KF981-DOUBLE, KF981-DOUBLE-EV, KF981-DOUBLE-EV-UD, KF981-DOUBLE-EV-UI, KF981-DOUBLE-UD, KF981-DOUBLE-V, KF981-DOUBLE-V-UD, KF981-DOUBLE-V-UI, KF981EV, KF981UD, KF981V		



Part No.	375456	Ref. No.	01200400 01951367000
description	safety thermostat switch-off temp. 335°C 2-pole 20A probe ø 3mm probe L 200mm capillary pipe 1050mm capillary pipe isolated 650mm gland nut probe SS at 250V 20A at 400V 10A		
For models:	EKF423ALP, EKF423P, EKF620S, EKF620US, KF1010GE-JD, KF412U, KF622, KF630, KF733		

TECASA

control thermostats

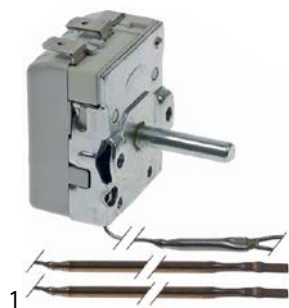

Part No.	376091	Ref. No.	01201220 01204190
description	thermostat t.max. 328°C temperature range 57-328°C 1-pole 1NO 16A probe ø 3mm probe L 98mm capillary pipe 1540mm capillary pipe isolatedmm gland nut shaft ø 6x4.6mm shaft L 21mm rotation 270° outer switch probe thread disc ømm		

CAMPINI

safety thermostats



Part No.	375892	Ref. No.	01202780 SP00916
description	safety thermostat switch-off temp. 318°C 1-pole 16A probe ø 3mm probe L 137mm capillary pipe 1260mm capillary pipe isolated 710mm gland nut probe SS type Ty 95-H		
For models:	EKF1016EUD, EKF1016UD, EKF1064EUD, EKF1064TC, EKF1064UD, EKF1111EUD, EKF1111EVUD, EKF1111TC, EKF1111UD, EKF1664TC, EKF2011TC, EKF311DUD, EKF311UD, EKF364DUD, EKF364UD, EKF411, EKF411.3D, EKF411.3GRILL, EKF411ALUD, EKF411D, EKF411DALUD, EKF411DUD, EKF411UD, EKF416ALUD, EKF416DALUD, EKF416DUD, EKF416UD, EKF464, EKF464.3D, EKF464.3GRILL, EKF464ALP, EKF464ALUD, EKF464D, EKF464DALUD, EKF464DUD, EKF464P, EKF464TC, EKF464UD, EKF511TC, EKF616EUD, EKF616UD, EKF664.3EUD, EKF664EUD, EKF664P, EKF664TC, EKF664UD, EKF711.3EUD, EKF711EUD, EKF711EV, EKF711TC...(Other models you can see in the webshop)		

accessories

fitting parts



Part No.	699163	Ref. No.	30307040
description	mounting flange L 50mm W 30mm bore ø 5/12mm		
For models:	EKF1016UD, EKF1064UD, EKF1111UD, EKF311UD, EKF364UD, EKF411.3GRILL, EKF411UD, EKF412US, EKF416UD, EKF423, EKF423AL, EKF423ALM, EKF423ALU, EKF423ALUD, EKF423M, EKF423U, EKF423UD, EKF464.3GRILL, EKF464ALP, EKF464P, EKF464UD, EKF523UD, EKF616UD, EKF664P, EKF664UD, EKF711UD		



switches and momentary switches

push/momentary push switches

19x13mm



Part No.	347627	Ref. No.	00010300
description	momentary push switch mounting measurements 19x13mm black 2NO 250V 16A connection male faston 6.3mm ambient temperature max. 85°C protection IP65 with cover cap		
For models:	EKF411, EKF411.3GRILL, EKF412US, EKF423ALU, EKF423ALUD, EKF423ALUP, EKF423U, EKF423UD, EKF423UP, EKF464, EKF464.3GRILL		

28.5x28.5mm





Part No.	346313	Ref. No.	00002610 09951687000
description	push switch mounting measurements 28.5x28.5mm red/green 1CO/1NO 250V 16A connection male faston 6.3mm ambient temperature max. 150°C protection IP40 with indicator		
For models:	1308, 1311-A, 1408, 1411-A, 640 CI+GRILL, 900, 930, 938.3, KL823, KL864, KL898		



Part No.	346317	Ref. No.	09950067023
description	momentary push switch mounting measurements 28.5x28.5mm black 1NO 250V 16A connection male faston 6.3mm ambient temperature max. 150°C protection IP40		
For models:	900, 930, 938.3, CV5-90/X, KC96V		

ø16mm



Part No.	346315	Ref. No.	00005750 11950427000
description	momentary push switch mounting ø 16mm red 1NO/indicator light 250V 3A connection male faston 2.8mm ambient temperature max. 85°C protection IP40		
For models:	KCP97-VG-A, KCV96, KCV96P, KF1001G, KF1001G-IX-AL, KF1001G-LPG, KF1001G-LPG-IX-AL		
accessories for	346315		
	Part No.	346343	Ref. No. —
			protective cover
	Part No.	346344	Ref. No. —
			ring for protecting cover

ø25mm



Part No.	346312	Ref. No.	00002600 09951677000
description	momentary push switch mounting ø 25mm black 1NO 250V 16A water connection male faston 6.3mm ambient temperature max. 85°C protection IP40		
For models:	640 CI+U, EKF620US, KF1001G, KF1001G-IX-AL, KF1001G-LPG, KF1001G-LPG-IX-AL, KF412U, KF630, KF912, KF912IX, KF933AL-U, KF933U, KF965, KF965AL-UD, KF965M, KF981-DOUBLE-V, KF981-DOUBLE-V-UD, KF981-DOUBLE-V-UI, KF981V		



Part No.	346316	Ref. No.	00002630 09951707000
description	push switch mounting ø 25mm black 2NO 250V 16A connection male faston 6.3mm ambient temperature max. 85°C protection IP40		
For models:	KF1001G, KF1001G-IX-AL, KF1001G-LPG, KF1001G-LPG-IX-AL, KF912, KF912IX, KF965, KF965AL-UD, KF981, KF981-DOUBLE, KF981-DOUBLEEV-UD, KF981-DOUBLE-EV-UI, KF981-DOUBLE-UD, KF981-DOUBLE-V, KF981-DOUBLE-V-UD, KF981-DOUBLE-V-UI, KF981UD, KF981V		

microswitches

lever actuated



Part No.	346314	Ref. No.	01201160 09951147000 09951727000
description	microswitch with lever 250V 16A 1CO connection male faston 6.3mm L 56mm ambient temperature max. 125°C mounting distance 22mm type VRSR01DA1 actuating force: 50g		
For models:	900, 900 G, 938.3, KC96V, KCP97-VG-A, KCV96, KCV96P, TCFG		

pin-plunger actuated

M10



Part No.	347603	Ref. No.	01200890
description	microswitch with plunger thread M10x0.75 thread L 10mm 250V 16A 1CO connection male faston 6.3mm stroke 5mm mounting distance 22mm L 29mm ambient temperature max. 125°C type VRSR01DZ2 actuating force: 170g		
For models:	EKF311DUD, EKF311UD, EKF364DUD, EKF364UD, EKF411, EKF411.3D, EKF411D, EKF411DUD, EKF411UD, EKF416DUD, EKF416UD, EKF423ALUD, EKF423DALUD, EKF423DUD, EKF423UD, EKF443DUD, EKF464, EKF464.3D, EKF464ALP, EKF464D, EKF464DUD, EKF464P, EKF464UD		



1

Part No.	347216	Ref. No.	09950437000
description	microswitch with plunger thread M10x0.75 thread L 14mm 250V 10A 1CO connection male faston 6.3mm stroke 7.5mm mounting distance 22mm L 28mm ambient temperature max. 125°C type NR6K5 actuating force: 260g		
For models:	KF1001G, KF1001G-IX-AL, KF1001G-LPG, KF1001G-LPG-IX-AL, KF630, KF733, KF912, KF912IX, KF933, KF933AL, KF933AL-U, KF933U, KF937, KF965, KF965AL-UD, KF965M, KF981, KF981-DOUBLE, KF981-DOUBLEEV-UD, KF981-DOUBLE-EV-UI, KF981-DOUBLE-UD, KF981-DOUBLE-VUD, KF981-DOUBLE-V-UI, KF981UD		



1

Part No.	347762	Ref. No.	01201700
description	microswitch with plunger thread M10x0.75 thread L 14mm 250V 16A 2NO connection male faston 6.3mm stroke 4mm mounting distance 22mm ambient temperature max. 85°C actuating force: 650g		
For models:	EKF411.3GRILL, EKF464.3GRILL		
accessories for	347762		
	Part No.	100779	Ref. No. —
	nut thread M10x0.75 H 3mm WS 14 SS Qty 2 pcs		

cam switches

10 operating positions



1

Part No.	301205	Ref. No.	01200040 01950037000
description	cam switch 10 operating positions 5NO/1CO sequence 0-1-2-3-4-5-6-7-8-9 16A shaft ø 6x4.6mm shaft L 23mm connection male faston 6.3mm ceramic		
For models:	648 CI, EKF423ALM, EKF423M, KF723M, KF965M		

operation switches



1

Part No.	300183	Ref. No.	01200180 01950337400
description	operation switch 5 operating positions 5NO 16A sequence 0-1-2-3-4 shaft ø 6x4.6mm shaft L 23mm connection male faston 6.3mm plastic ambient temperature max. 270°C		
For models:	CV5-90/X, KC96V		

magnetic switches

M10x0.75



1

Part No.	348182	Ref. No.	00005771 00010510
description	magnetic switch thread M10x0.75 1NO 250V 0.04A cable length 570mm L 40mm		
For models:	EKF1016EUD, EKF1016UD, EKF1064EUD, EKF1064TC, EKF1064UD, EKF1111EUD, EKF1111EVUD, EKF1111TC, EKF1111UD, EKF1664TC, EKF2011TC, EKF411ALUD, EKF411DALUD, EKF416ALUD, EKF416DALUD, EKF464ALUD, EKF464DALUD, EKF464TC, EKF511TC, EKF523EUD, EKF523UD, EKF616EUD, EKF616UD, EKF664.3EUD, EKF664EUD, EKF664P, EKF664TC, EKF664UD, EKF711.3EUD, EKF711EUD, EKF711EV, EKF711TC, EKF711UD		

lamps

indicator lights

indicator light lenses

ø 8mm (type RL-2)



1

Part No.	359819	Ref. No.	00002360 09950388535
description	indicator light lens green Qty 1 pcs ø 8mm		
For models:	440, 640 CI, 640 CI+GRILL, 640 CI+U, 648 CI, 900, 930, 938.3, CV5-90/X, EKF1016UD, EKF1064UD, EKF1111UD, EKF311UD, EKF364UD, EKF411, EKF411.3GRILL, EKF411ALUD, EKF411UD, EKF412US, EKF416ALUD, EKF416UD, EKF423, EKF423AL, EKF423ALM, EKF423ALP, EKF423ALU, EKF423ALUD, EKF423ALUP, EKF423M, EKF423P, EKF423U, EKF423UD, EKF423UP, EKF464, EKF464.3GRILL, EKF464ALP, EKF464ALUD, EKF464P, EKF464UD, EKF523UD, EKF616UD, EKF620US, EKF664P, EKF664UD, EKF711UD, KC96V, KF412, KF412U, KF620, KF622...(Other models you can see in the webshop)		



1

Part No.	359820	Ref. No.	00002350 09950368534
description	indicator light lens yellow Qty 1 pcs ø 8mm		
For models:	440, 640 CI, 640 CI+GRILL, 640 CI+U, 648 CI, 900, 930, 938.3, CV5-90/X, EKF1016UD, EKF1064UD, EKF1111UD, EKF311UD, EKF364UD, EKF411, EKF411.3GRILL, EKF411ALUD, EKF411UD, EKF412US, EKF416ALUD, EKF416UD, EKF423, EKF423AL, EKF423ALM, EKF423ALP, EKF423ALU, EKF423ALUD, EKF423ALUP, EKF423M, EKF423P, EKF423U, EKF423UD, EKF423UP, EKF464, EKF464.3GRILL, EKF464ALP, EKF464ALUD, EKF464P, EKF464UD, EKF523UD, EKF616UD, EKF620S, EKF620US, EKF664P, EKF664UD, EKF711UD, KC96V, KCP97-VG-A, KCV96, KCV96P...(Other models you can see in the webshop)		



indicator lamps for socket type RL				
<p>1</p>				
Part No.	359818	Ref. No.	01200330 01950377000 01951177000	
description	indicator light 230V clear connection male faston 6.3mm			
For models:	440, 640 CI, 640 CI+GRILL, 640 CI+U, 648 CI, 900, 938.3, CV5-90/X, EKF1016UD, EKF1064UD, EKF1111UD, EKF311UD, EKF364UD, EKF411, EKF411.3GRILL, EKF411ALUD, EKF411UD, EKF412US, EKF416ALUD, EKF416UD, EKF423, EKF423AL, EKF423ALM, EKF423ALP, EKF423ALU, EKF423ALUD, EKF423ALUP, EKF423M, EKF423P, EKF423U, EKF423UD, EKF423UP, EKF464, EKF464.3GRILL, EKF464ALP, EKF464ALUD, EKF464P, EKF464UD, EKF523UD, EKF616UD, EKF620S, EKF620US, EKF664P, EKF664UD, EKF711UD, KC96V, KCP97-VG-A, KCV96, KCV96P, KF1001G... (Other models you can see in the webshop)			
accessories for	359818			
	Part No.	359820	Ref. No.	00002350 09950368534
indicator light lens yellow Qty 1 pcs ø 8mm				
	Part No.	359833	Ref. No.	—
indicator light lens red Qty 1 pcs ø 8mm				
	Part No.	359948	Ref. No.	—
indicator light lens clear Qty 1 pcs ø 8mm				

<p>1</p>				
Part No.	359817	Ref. No.	01200340 01951187000 09950377000	
description	indicator light 230V green connection male faston 6.3mm			
For models:	440, 640 CI, 640 CI+GRILL, 640 CI+U, 648 CI, 900, 930, 938.3, CV5-90/X, EKF1016UD, EKF1064UD, EKF1111UD, EKF311UD, EKF364UD, EKF411, EKF411.3GRILL, EKF411ALUD, EKF411UD, EKF412US, EKF416ALUD, EKF416UD, EKF423, EKF423AL, EKF423ALM, EKF423ALP, EKF423ALU, EKF423ALUD, EKF423ALUP, EKF423M, EKF423P, EKF423U, EKF423UD, EKF423UP, EKF464, EKF464.3GRILL, EKF464ALP, EKF464ALUD, EKF464P, EKF464UD, EKF523UD, EKF616UD, EKF620S, EKF620US, EKF664P, EKF664UD, EKF711UD, KC96V, KF412, KF412U, KF620... (Other models you can see in the webshop)			
accessories for	359817			
	Part No.	359819	Ref. No.	00002360 09950388535
indicator light lens green Qty 1 pcs ø 8mm				

screw-on/push-on fit

light bulbs

for ovens

<p>1</p>			
Part No.	359610	Ref. No.	01950108400
description	light bulb t.max. 300°C socket E14 15W 230V ø 22mm L 47mm lens L 20mm for oven lamp type Philips		
For models:	440, 640 CI, 640 CI+GRILL, 640 CI+U, 648 CI, 900, 900 G, 930, 938.3, CV5-90/X, KC96V, KCP97-VG-A, KCV96, KCV96P, KF1001G, KF1001GIX-AL, KF1001G-LPG, KF1001G-LPG-IX-AL, KF412, KF412U, KF630, KF723, KF723M, KF733, KF912, KF912IX, KF933, KF933AL, KF933AL-U, KF933U, KF937, KF965, KF965M, TCFG		

halogen lamp

for socket G4 / G6.35 / G9

<p>1 500°C</p>			
Part No.	359074	Ref. No.	01201470 11950097000
description	halogen lamp socket G6.35 12V 35W temp.-resist. 500°C		
For models:	EKF1016EUD, EKF1016UD, EKF1064EUD, EKF1064UD, EKF1111EUD, EKF1111EVUD, EKF1111UD, EKF616EUD, EKF616UD, EKF664.3EUD, EKF664EUD, EKF664P, EKF664UD, EKF711.3EUD, EKF711EUD, EKF711EV, EKF711UD, KF1010GE-UD, KF981, KF981-DOUBLE, KF981-DOUBLE-EV, KF981-DOUBLE-EV-UD, KF981-DOUBLE-EV-UI, KF981-DOUBLE-UD, KF981-DOUBLE-V, KF981-DOUBLE-V-UD, KF981-DOUBLE-V-UI, KF981EV, KF981UD, KF981V		

oven lamps

universal oven lamps



mounting diameter 35.5mm

<p>1</p>				
Part No.	359718	Ref. No.	00002330 09950187400	
description	oven lamp mounting ø 35.5mm 230V 15W socket E14 temp.-resist. 300°C connection male faston 6.3mm hard glas			
For models:	EKF411, EKF411.3D, EKF411.3GRILL, EKF411D, EKF423, EKF423AL, EKF423ALM, EKF423ALP, EKF423ALU, EKF423ALUP, EKF423M, EKF423P, EKF423U, EKF423UP, EKF464, EKF464.3D, EKF464.3GRILL, EKF464ALP, EKF464D, EKF464P			
spare parts for	359718			
	Part No.	359701	Ref. No.	09950197400
lamp socket socket E14 220-230V mounting ø 35.5mm connection male faston 6.3mm 15W				
	Part No.	359740	Ref. No.	—
light bulb t.max. 300°C socket E14 15W 230V ø 22mm L 48mm lens L 20mm for oven lamp IMPORT				

<p>1</p>				
Part No.	359259	Ref. No.	00002720 00002730	
description	oven lamp mounting ø 35.5mm 230V 40W socket G9 temp.-resist. 300°C connection cable 380mm hard glas			
For models:	EKF311DUD, EKF311UD, EKF364DUD, EKF364UD, EKF411ALUD, EKF411DALUD, EKF411DUD, EKF411UD, EKF416ALUD, EKF416DALUD, EKF416DUD, EKF416UD, EKF423ALUD, EKF423DALUD, EKF423DUD, EKF423UD, EKF443DUD, EKF464ALUD, EKF464DALUD, EKF464DUD, EKF464UD, EKF523EUD, EKF523UD			
spare parts for	359259			
	Part No.	357161	Ref. No.	—
lamp socket socket G9 220-230V mounting ø 35.5mm connection cable 380mm				
	Part No.	358128	Ref. No.	—
gasket for oven lamp silicone ID ø 30mm ED ø 38mm thickness 2mm				

Table continues overleaf



spare parts for 359259			
	Part No.	359942	Ref. No. —
oven lamp glass thr.ø 33.5mm ø 41mm hard glas temp.-resist. 350°C			
	Part No.	359946	Ref. No. —
halogen lamp socket G9 230V 40W temp.-resist. 300°C			

			
1			
Part No.	359701	Ref. No.	09950197400
description lamp socket socket E14 220-230V mounting ø 35.5mm connection male faston 6.3mm 15W			
For models: 900, 900 G, 930, 938.3, CV5-90/X, KC96V, KCP97-VG-A, KCV96, KCV96P, KF1001G, KF1001G-IX-AL, KF1001G-LPG, KF1001G-LPG-IX-AL, KF630, KF733, KF912, KF912IX, KF933, KF933AL, KF933AL-U, KF933U, KF937, KF965, KF965M			
accessories for 359701			
	Part No.	359705	Ref. No. —
oven lamp glass thr.ø 33.5mm ø 52mm hard glas temp.-resist. 350°C			
	Part No.	359709	Ref. No. 09950208400
oven lamp glass thr.ø 33.5mm ø 42mm hard glas temp.-resist. 350°C			
	Part No.	359721	Ref. No. —
gasket silicone ED ø 48mm ID ø 39.5mm thickness 5mm Qty 1 pcs			
	Part No.	359942	Ref. No. —
oven lamp glass thr.ø 33.5mm ø 41mm hard glas temp.-resist. 350°C			

			
1			
Part No.	359709	Ref. No.	09950208400
description oven lamp glass thr.ø 33.5mm ø 42mm hard glas temp.-resist. 350°C			
For models: 900, 900 G, 930, 938.3, CV5-90/X, KC96V, KCP97-VG-A, KCV96, KCV96P, KF1001G, KF1001G-IX-AL, KF1001G-LPG, KF1001G-LPG-IX-AL, KF733, KF912, KF912IX, KF933, KF933AL, KF933AL-U, KF933U, KF937, KF965, KF965M, TCFG			

mounting diameter 47.8mm

			
1			
Part No.	359703	Ref. No.	01200050 01950077400
description oven lamp mounting ø 47.8mm 230V 15W socket E14 temp.-resist. 300°C connection male faston 6.3mm hard glas			
For models: EKF412US			
spare parts for 359703			
	Part No.	359610	Ref. No. 01950108400
light bulb t.max. 300°C socket E14 15W 230V ø 22mm L 47mm lens L 20mm for oven lamp type Philips			
	Part No.	359725	Ref. No. —
oven lamp glass thread ø 44mm H 43mm ø 54mm hard glas temp.-resist. 350°C			

lamps

light bulbs

			
1			
Part No.	359610	Ref. No.	01950108400
description light bulb t.max. 300°C socket E14 15W 230V ø 22mm L 47mm lens L 20mm for oven lamp type Philips			
For models: 440, 640 CI, 640 CI+GRILL, 640 CI+U, 648 CI, 900, 900 G, 930, 938.3, CV5-90/X, KC96V, KCP97-VG-A, KCV96, KCV96P, KF1001G, KF1001GIX-AL, KF1001G-LPG, KF1001G-LPG-IX-AL, KF412, KF412U, KF630, KF723, KF723M, KF733, KF912, KF912IX, KF933, KF933AL, KF933AL-U, KF933U, KF937, KF965, KF965M, TCFG			

halogen lamps

for socket G4 / G6.35 / G9

			
1 500°C			
Part No.	359074	Ref. No.	01201470 11950097000
description halogen lamp socket G6.35 12V 35W temp.-resist. 500°C			
For models: EKF1016EUD, EKF1016UD, EKF1064EUD, EKF1064UD, EKF1111EUD, EKF1111EVUD, EKF1111UD, EKF616EUD, EKF616UD, EKF664.3EUD, EKF664EUD, EKF664P, EKF664UD, EKF711.3EUD, EKF711EUD, EKF711EV, EKF711UD, KF1010GE-UD, KF981, KF981-DOUBLE, KF981-DOUBLE-EV, KF981-DOUBLE-EV-UD, KF981-DOUBLE-EV-UI, KF981-DOUBLE-UD, KF981-DOUBLE-V, KF981-DOUBLE-V-UD, KF981-DOUBLE-V-UI, KF981EV, KF981UD, KF981V			



sockets

G4 / G5,3 / G6,35

			
1			
Part No.	359646	Ref. No.	00005690
description	lamp socket socket G4/G5.3/G6.35 24V ø 17mm H 15mm connection cable 130mm mounting distance 26mm for halogen lamp holder length 31mm cable length 130mm		

timers

programme timers

			
1			
Part No.	360329	Ref. No.	01201040 01201350 09951027000 09954657000
description	timer CDC 11902F3 engines 1 chambers 2 operation time 240s 230V manuf. no. PWE5J02H620 motor type M51B10R0000		
For models:	900 G, 930, 938.3, EKF1016UD, EKF1064UD, EKF1111UD, EKF311UD, EKF364UD, EKF411ALUD, EKF411UD, EKF416ALUD, EKF416UD, EKF423ALUD, EKF423UD, EKF464ALP, EKF464ALUD, EKF464P, EKF464UD, EKF523UD, EKF616UD, EKF664P, EKF664UD, EKF711UD, KCP97-VG-A, KF1001G, KF1001G-IX-AL, KF1001G-LPG, KF1001G-LPG-IX-AL, KF630, KF733, KF933, KF933AL, KF933AL-U, KF933U, KF937, KF965, KF965AL-UD, KF965M, KF981, KF981-DOUBLE, KF981-DOUBLE-EV-UD, KF981-DOUBLE-EV-UI, KF981-DOUBLE-UD, KF981-DOUBLE-V, KF981-DOUBLE-V-UD, KF981-DOUBLE-V-UI, KF981EV, KF981UD, KF981V		
spare parts for	360329		
	Part No.	360118	Ref. No. —
	 motor CDC pinion ø 4.9mm teeth 10 230V voltage AC 50/60Hz turn direction right motor ø 47mm H 19.3mm motor type M48R ATS for timer cable length 260mm 1.9/2.5W		

electric timers

			
1			
Part No.	350072	Ref. No.	01200950 09950677000
description	timer MS65 with bell operation time 120min 2CO/1NO at 250V 16A impulse electric shaft ø 6x4.6mm shaft L 23mm with permanent position mounting distance 28mm connection lateral Invensys 3-pole 230V		
For models:	440, 640 CI, 640 CI+GRILL, 640 CI+U, 648 CI, 930, KCP97-VG-A, KCV96, KCV96P, KF412U		

with time spread

			
1			
Part No.	350142	Ref. No.	01201200 01201200+2x00002520 09952437000
description	timer MS65 with bell operation time 120min time spread 30min 1CO/1NC/2NO at 250V 16A permanent position yes time range 0-120min impulse electric 16A shaft ø 6x4.6mm shaft L 22mm connection male faston 6.3mm Invensys screw/F6.3 230V voltage AC 50Hz		
For models:	KF1001G, KF1001G-IX-AL, KF1001G-LPG, KF1001G-LPG-IX-AL, KF412, KF723M, KF733, KF912, KF912IX, KF933, KF933AL, KF933AL-U, KF933U, KF937, KF965, KF965AL-UD, KF965M, KF981, KF981-DOUBLE, KF981-DOUBLE-EV-UD, KF981-DOUBLE-EV-UI, KF981-DOUBLE-UD, KF981-DOUBLE-V, KF981-DOUBLE-V-UD, KF981-DOUBLE-V-UI, KF981UD, KF981V		

			
1			
Part No.	350073	Ref. No.	01200930 01201200+2x00002520 09950507000
description	timer MS65 with buzzer board operation time 120min time spread 30min 1CO/1NC/2NO at 250V 16A permanent position yes impulse electric shaft ø 6x4.6mm shaft L 20mm with bell mounting distance 28mm connection lateral 3-pole		
For models:	900, 938.3, CV5-90/X, KC96V, KF723		

mechanical timers



			
1			
Part No.	350159	Ref. No.	01200950 01201270 21003700+2x00002520 21004130 21004131
description	timer M2 2-pole operation time 120min impulse mechanical 2CO at 250V 16A permanent position yes shaft ø 6x4.6mm shaft 6x4.6mm shaft L 22mm mounting distance 28mm mounting thread M4 connection male faston 6.3mm ambient temperature max. 125°C with buzzer		
For models:	EKF620S, EKF620US		
spare parts for	350159		
	Part No.	350186	Ref. No. 01202980
	 timer M2 2-pole operation time 120min impulse mechanical 2CO at 250V 16A permanent position yes shaft ø 6x4.6mm shaft 6x4.6mm shaft L 23mm mounting distance 28mm		

Table continues overleaf



spare parts for	350159		
	Part No.	401062	Ref. No. 01201250 09952707000
buzzer board 230VAC L 48mm W 45mm connection Faston 6.3mm			





1	Part No.	350186	Ref. No.	01202980
description timer M2 2-pole operation time 120min impulse mechanical 2CO at 250V 16A permanent position yes shaft \varnothing 6x4.6mm shaft 6x4.6mm shaft L 23mm mounting distance 28mm				

accessories for	350186			
	Part No.	112627	Ref. No.	—
knob time 120min \varnothing 58mm shaft \varnothing 6x4.6mm shaft flat lower				



1	Part No.	350003	Ref. No.	09950617000
description timer M2 with bell 2-pole operation time 120min impulse mechanical 2NO at 250V 16A permanent position no shaft \varnothing 6x4.6mm shaft 6x4.6mm shaft L 23mm mounting distance 28mm connection lateral				

accessories for	350003			
	Part No.	110366	Ref. No.	—
knob switch zero mark t.max.°C°C \varnothing 44mm shaft \varnothing 6x4.6mm shaft flat upper black				

	Part No.	111199	Ref. No.	—
dial plate graduation 120min permanent position no rotation 0-330° \varnothing 60mm timers knob \varnothing 45mm				

alarm devices

buzzer boards



1	Part No.	401062	Ref. No.	01201250 09952707000
description buzzer board 230VAC L 48mm W 45mm connection Faston 6.3mm				

contactors

SIEMENS

power contactors



1	Part No.	380526	Ref. No.	01201680
description power contactor resistive load 20A 230VAC (AC3/400V) 8.4A/4kW main contacts 4NO auxiliary contacts connection screw connection type 3TG10-10-0A2L2				
For models: EKF1016EUD, EKF1016UD, EKF1064EUD, EKF1064TC, EKF1064UD, EKF1111EUD, EKF1111EVUD, EKF1111TC, EKF1111UD, EKF1664TC, EKF2011TC, EKF311DUD, EKF311UD, EKF364DUD, EKF364UD, EKF411, EKF411.3D, EKF411.3GRILL, EKF411ALUD, EKF411D, EKF411DALUD, EKF411DUD, EKF411UD, EKF416ALUD, EKF416DALUD, EKF416DUD, EKF416UD, EKF423ALUD, EKF423DALUD, EKF423DUD, EKF423UD, EKF443DUD, EKF464, EKF464.3D, EKF464.3GRILL, EKF464ALP, EKF464ALUD, EKF464D, EKF464DALUD, EKF464DUD, EKF464P, EKF464TC, EKF464UD, EKF511TC, EKF523EUD, EKF523UD, EKF616EUD, EKF616UD, EKF664.3EUD, EKF664EUD...(Other models you can see in the webshop)				

TELEMECANIQUE (Schneider Electric)

power contactors



1	Part No.	380090	Ref. No.	11950197000
description power contactor resistive load 25A 230VAC (AC3/400V) 12A/5.5kW main contacts 4NO auxiliary contacts 1NO/1NC connection screw connection type LC1DT25P7				
For models: 900, 930, 938.3, CV5-90/X, KC96V				



relays

power relays

with bracket mounting



1

Part No.	380197	Ref. No.	09950287000
description	power relays 230VAC 16A 2CO connection male faston bracket mounting		
For models:	900, 930, 938.3, CV5-90/X, KC96V, KF965M		

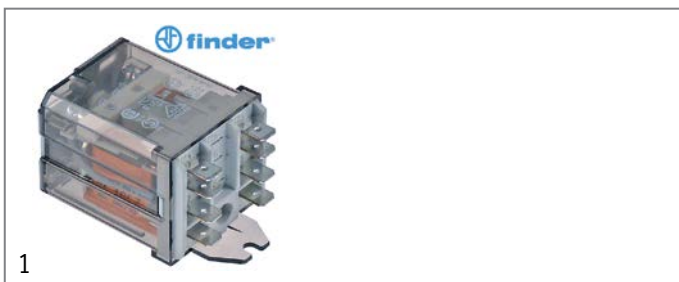

1

Part No.	380139	Ref. No.	01200820
description	power relays FINDER 230VAC 16A 2CO connection F6.3 bracket mounting dimensions 68x38.2x35.8mm manuf. no. 62.82.8.230.0000		

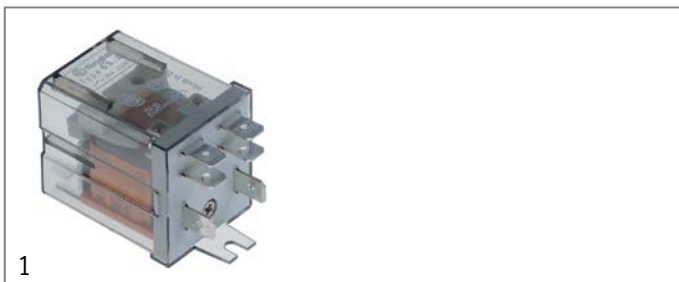

1

Part No.	380900	Ref. No.	01200020
description	power relays FINDER 230VAC 20A 1NO/1NC connection F6.3 bracket mounting dimensions 36.5x32.2x51.8mm manuf. no. 65.31.8.230.0000 2-pole		
For models:	EKF1016UD, EKF1064UD, EKF1111UD, EKF411.3GRILL, EKF411ALUD, EKF416ALUD, EKF464.3GRILL, EKF464ALUD, EKF523UD, EKF616UD, EKF664P, EKF664UD, EKF711UD		

transformers

for lighting



1

Part No.	401177	Ref. No.	00005680
description	transformer primary 230V secondary 11.5V 50W		



1

Part No.	403698	Ref. No.	00012590
description	transformer primary 230VAC secondary 12VAC 105VA secondaryA L 128mm W 38mm H 28mm 50/60Hz		
For models:	EKF1016EUD, EKF1016UD, EKF1064EUD, EKF1064UD, EKF1111EUD, EKF1111EVUD, EKF1111UD, EKF616EUD, EKF616UD, EKF664.3EUD, EKF664EUD, EKF664P, EKF664UD, EKF711.3EUD, EKF711EUD, EKF711EV, EKF711UD		

probes

producer-specific probes

probes



1

Part No.	379638	Ref. No.	00005790 11950677000
description	temperature probe Pt100 cable silicone probe -50 up to +250°C cable -50 up to +180°C connection plug thread probe ø3x100mm cable length 1m		

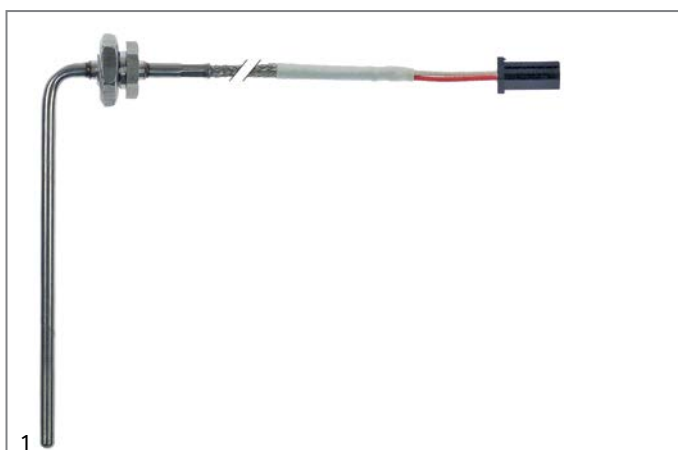

1

Part No.	378552	Ref. No.	00002660
description	temperature probe Pt100 cable Vetrotex probe -100 up to 450°C cable°C connection coded plug thread M10 probe ø4x100mm cable length 1m		
For models:	EKF1016EUD, EKF1064EUD, EKF1064TC, EKF1111EUD, EKF1111EVUD, EKF1111TC, EKF311DUD, EKF364DUD, EKF411.3D, EKF411D, EKF-411DALUD, EKF411DUD, EKF416DALUD, EKF416DUD, EKF423DALUD, EKF423DUD, EKF443DUD, EKF464.3D, EKF464D, EKF464DALUD, EKF464DUD, EKF464TC, EKF511TC, EKF523EUD, EKF616EUD, EKF664.3EUD, EKF664EUD, EKF664TC, EKF711.3EUD, EKF711EUD, EKF711EV, EKF711TC		



electronics

PCBs

1 electric components



1

Part No.	403701	Ref. No.	01900081
description	control PCB combi-steamer EKF series L 432mm W 80mm		
For models:	EKF1016EUD, EKF1064EUD, EKF1111EUD, EKF1111EVUD, EKF523EUD, EKF616EUD, EKF664.3EUD, EKF664EUD, EKF711.3EUD, EKF711EUD, EKF711EV		



1

Part No.	403726	Ref. No.	01202500 01202501 01202502 01900170 11951767000
description	display PCB pizza oven EKF L 364mm W 54mm		
For models:	EKF311DUD, EKF364DUD, EKF411.3D, EKF411D, EKF411DALUD, EKF411DUD, EKF416DALUD, EKF416DUD, EKF423DALUD, EKF423DUD, EKF443DUD, EKF464.3D, EKF464D, EKF464DALUD, EKF464DUD		

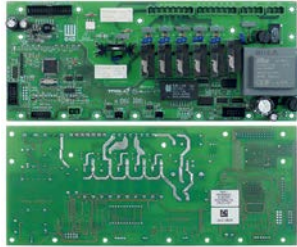

1

Part No.	403725	Ref. No.	01900090 01900130 11950577000
description	main PCB combi-steamer L 262mm W 108mm		
For models:	EKF1016EUD, EKF1064EUD, EKF1111EUD, EKF523EUD, EKF616EUD, EKF664.3EUD, EKF664EUD, EKF711.3EUD, EKF711EUD, EKF711EV, KF981-DOUBLE-EV, KF981-DOUBLE-EV-UD, KF981-DOUBLE-EV-UI, KF981EV		

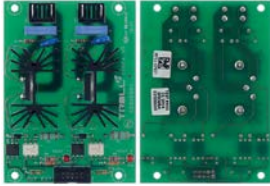

1

Part No.	403699	Ref. No.	01900100
description	PCB combi-steamer EKF 523 L 102mm W 54mm		
For models:	EKF523EUD		



1

Part No.	403700	Ref. No.	01900480
description	PCB combi-steamer EKF series L 105mm W 98mm suitable for TECNOEKA		
For models:	EKF1016EUD, EKF1064EUD, EKF1111EUD, EKF1111EVUD, EKF616EUD, EKF664.3EUD, EKF664EUD, EKF711.3EUD, EKF711EUD, EKF711EV		

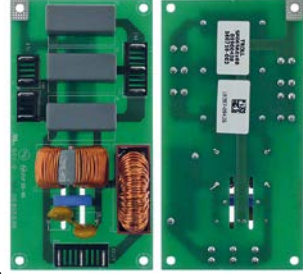

1

Part No.	403697	Ref. No.	01900430
description	PCB combi-steamer EKF664/EKF1064 L 128mm W 67mm		
For models:	EKF1016EUD, EKF1064EUD, EKF1111EUD, EKF1111EVUD, EKF616EUD, EKF664.3EUD, EKF664EUD, EKF711.3EUD, EKF711EUD, EKF711EV		

solenoid valves



solenoid valves (water)

RPE

JOHN GUEST



1

Part No.	370772	Ref. No.	01201790
description	solenoid valve double straight 230VAC inlet 3/4" outlet JG 8 DN10 t.max. 60°C duty cycle 100% RPE		
accessories for	370772		
	Part No.	371265	Ref. No. —
	reducer flow rate 3l/min black		
	Part No.	371269	Ref. No. —
	reducer flow rate 0.07-0.14l/min brown		





1



Part No.	374090	Ref. No.	01201800
description	solenoid valve triple straight 220-240VAC inlet 3/4" outlet JG 8 DN8 t.max. 25/60/90°C duty cycle 100% RPE output A 0.2l/min output B 0.2l/min output C 0.2l/min flow regulating valve outlet A red flow regulating valve outlet B red flow regulating valve outlet C red		
For models:	EKF1016EUD, EKF1016UD, EKF1064EUD, EKF1064TC, EKF1064UD, EKF1111EUD, EKF1111TC, EKF1111UD		



solenoid valves with reducers			
single			
			
1			
Part No.	374012	Ref. No.	01201860
description	solenoid valve single straight 220-240VAC inlet 3/4" outlet JG 8 input 10-12l/min t.max. 60°C duty cycle 100% RPE plastic flow regulating valve outlet brown flow regulating valve inlet white output A 0.07-0.14l/min 2-ways medium temp max. 25°C male faston 6.3mm		
For models:	EKF311DUD, EKF311UD, EKF364DUD, EKF364UD, EKF411, EKF411.3D, EKF411.3GRILL, EKF411ALUD, EKF411D, EKF411DALUD, EKF411DUD, EKF411UD, EKF412US, EKF416ALUD, EKF416DALUD, EKF416DUD, EKF416UD, EKF423ALU, EKF423ALUD, EKF423ALUP, EKF423DALUD, EKF423DUD, EKF423U, EKF423UD, EKF423UP, EKF443DUD, EKF464, EKF464.3D, EKF464.3GRILL, EKF464ALUD, EKF464D, EKF464DALUD, EKF464DUD, EKF464TC, EKF464UD, EKF511TC, EKF523EUD, EKF523UD, EKF620US		

2-fold			
			
1			
Part No.	374037	Ref. No.	01203180
description	solenoid valve double straight 220-240VAC inlet 3/4" outlet JG 8 input 10-12l/min t.max. 60°C duty cycle 100% RPE plastic flow regulating valve inlet white output A 0.2-0.33l/min output B 0.2-0.33l/min flow regulating valve outlet A red flow regulating valve outlet B red output A John Guest 8mm output B John Guest 8mm		
For models:	EKF616EUD, EKF616UD, EKF664.3EUD, EKF664EUD, EKF664TC, EKF664UD, EKF711.3EUD, EKF711EUD, EKF711TC, EKF711UD		

			
1			
Part No.	374109	Ref. No.	01201640 259179
description	solenoid valve double straight 230VAC inlet 3/4" outlet JG 8 t.max. 60°C duty cycle 100% RPE plastic flow regulating valve inlet output A 0.7-1l/min output B l/min flow regulating valve outlet A light blue		
For models:	EKF711EV		

TP			
			
1			
Part No.	370017	Ref. No.	11950277000
description	solenoid valve single straight 230VAC inlet 3/4" outlet 11.5mm DN10 TP p max 10bar		
For models:	640 CI+U, 900, 900 G, 930, 938.3, KF412U		
spare parts for	370017		
			
	Part No.	Ref. No.	—
	solenoid coil TP 230VAC 50/60Hz		

accessories for 370017			
			
	Part No.	Ref. No.	—
	reducer TP flow rate 3l/min red tolerance ±15%		
			
	Part No.	Ref. No.	—
	reducer TP flow rate 5.5l/min yellow tolerance ±15%		
			
	Part No.	Ref. No.	—
	reducer TP flow rate 6l/min grey tolerance ±15%		
			
	Part No.	Ref. No.	—
	reducer TP flow rate 10l/min white tolerance ±15%		
			
	Part No.	Ref. No.	—
	reducer TP flow rate 12l/min bronze tolerance ±15%		
			
	Part No.	Ref. No.	—
	reducer TP flow rate 16l/min light brown tolerance ±15%		
			
	Part No.	Ref. No.	—
	reducer TP flow rate 20l/min red tolerance ±15%		
			
	Part No.	Ref. No.	—
	reducer TP flow rate 0.25l/min red tolerance ±25%		
			
	Part No.	Ref. No.	—
	reducer TP flow rate 0.35l/min violet tolerance ±25%		
			
	Part No.	Ref. No.	—
	reducer TP flow rate 0.5l/min orange tolerance ±25%		
			
	Part No.	Ref. No.	—
	reducer TP flow rate 0.8l/min white tolerance ±25%		
			
	Part No.	Ref. No.	—
	reducer TP flow rate 1l/min light blue tolerance ±25%		
			
	Part No.	Ref. No.	—
	reducer TP flow rate 1.2l/min brown tolerance ±25%		
			
	Part No.	Ref. No.	—
	reducer TP flow rate 1.5l/min light brown tolerance ±25%		
			
	Part No.	Ref. No.	—
	reducer TP flow rate 2.5l/min yellow tolerance ±25%		
			
	Part No.	Ref. No.	—
	reducer TP flow rate 3.4l/min dark green tolerance ±25%		
			
	Part No.	Ref. No.	—
	reducer TP flow rate 5l/min black tolerance ±25%		
			
	Part No.	Ref. No.	—
	reducer TP flow rate 8l/min blue tolerance ±20%		



fans

cross flow fans

EMMEVI - FER GAS

with standard coil



1

Part No.	601018	Ref. No.	01202330 09950337000 15950077000 15950427000
description	cross flow fan TG 180 roller ø 60mm roller length 180mm motor position right 230V/50Hz 25W universal bearing silicone connection male faston 6.3mm -10 up to +60°C 230V connections 1-2 1950U/min connections 1-4 1500U/min		
For models:	EKF1016EUD, EKF1016UD, EKF1064EUD, EKF1064TC, EKF1064UD, EKF1111EUD, EKF1111EVUD, EKF1111TC, EKF1111UD, EKF1664TC, EKF2011TC, EKF311DUD, EKF311UD, EKF364DUD, EKF364UD, EKF411, EKF411.3D, EKF411.3GRILL, EKF411ALUD, EKF411D, EKF-411DALUD, EKF411DUD, EKF411UD, EKF416ALUD, EKF416DALUD, EKF416DUD, EKF416UD, EKF423, EKF423AL, EKF423ALM, EKF423ALU, EKF423ALUD, EKF423DALUD, EKF423DUD, EKF423M, EKF423U, EKF423UD, EKF443DUD, EKF464, EKF464.3D, EKF464.3GRILL, EKF464ALP, EKF464ALUD, EKF464D, EKF464DALUD, EKF464DUD, EKF464P, EKF464TC, EKF464UD, EKF511TC...(Other models you can see in the webshop)		

COPREL

with moulded coils



1

Part No.	601194	Ref. No.	09951057000
description	cross flow fan roller ø 60mm roller length 300mm laminated core thickness 20mm motor position right 230V/50Hz 43W universal bearing silicone connection male faston 6.3mm -30 up to +100°C 230V 50Hz		
For models:	930		

accessories for cross flow fans

air ducts



1

Part No.	701630	Ref. No.	00012330
description	air duct for cross flow fan for combi-steamer plastic grey		
For models:	EKF1016EUD, EKF1016UD, EKF1064EUD, EKF1064UD, EKF1111EUD, EKF1111EVUD, EKF1111UD, EKF311DUD, EKF311UD, EKF364DUD, EKF364UD, EKF411, EKF411.3D, EKF411.3GRILL, EKF411ALUD, EKF411D, EKF411DALUD, EKF411DUD, EKF411UD, EKF416ALUD, EKF416DALUD, EKF416DUD, EKF416UD, EKF423, EKF423AL, EKF423ALM, EKF423ALU, EKF423ALUD, EKF423DALUD, EKF423DUD, EKF423M, EKF423U, EKF423UD, EKF443DUD, EKF464, EKF464.3D, EKF464.3GRILL, EKF464ALP, EKF464ALUD, EKF464D, EKF464DALUD, EKF464DUD, EKF464P, EKF464UD, EKF523EUD, EKF523UD, EKF616EUD, EKF616UD, EKF664.3EUD, EKF664EUD...(Other models you can see in the webshop)		

hot air motors



1

Part No.	602099	Ref. No.	01202600 01202600+01203600
description	fan motor 220/240V 1 phase 50/60Hz 0.12kW 2800/3400rpm suitable capacitor 6.3 type 1004.2459		

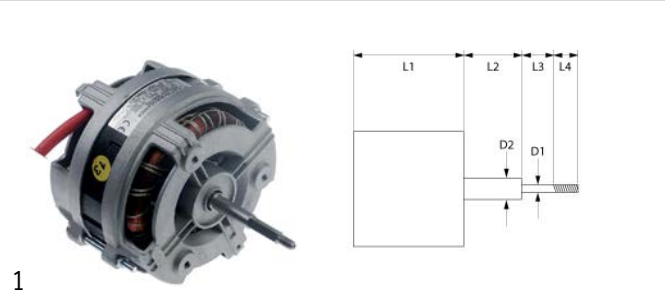
1

Part No.	601648	Ref. No.	01201330 01201330+01201030 01201330+01203600 01202600+00010380+01201330 09954527000
description	fan motor 220-240V 1 phase 50/60Hz 0.12kW 2800/3400rpm speeds 1 L1 95mm L2 32mm L3 23mm L4 12mm D1 ø 6x8mm D2 ø 10mm M6R ET 0.9A power input 0.12W at 50Hz 2800rpm at 60Hz 3400rpm suitable capacitor 6.3µF/450V		
For models:	KF733, KF933AL, KF933AL-U, KF933U, KF981, KF981-DOUBLE, KF981-DOUBLE-EV, KF981-DOUBLE-EV-UD, KF981-DOUBLE-EV-UI, KF981-DOUBLE-UD, KF981-DOUBLE-V, KF981-DOUBLE-V-UD, KF981-DOUBLE-V-UI, KF981EV, KF981UD, KF981V		
accessories for	601648		
	Part No.	365012	Ref. No. 01201030
	operating capacitor capacity 6.3µF 450V tolerance 5% 50Hz ambient temperature max. -25 to +85°C ø 30mm L 61mm M8 plastic connection male faston 6.3mm protection		

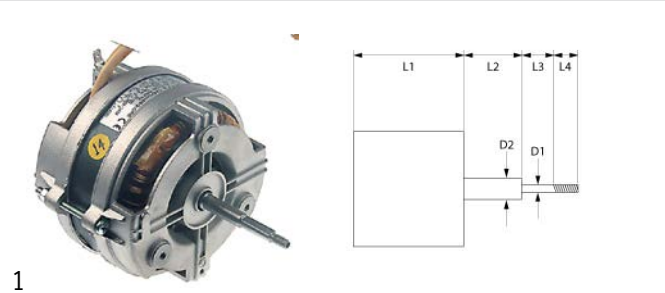

1

Part No.	601195	Ref. No.	01201130 01201130+01203600 09951627000
description	fan motor 220-240V 1 phase 50/60Hz 0.12kW 2800/3400rpm speeds 1 L1 95mm L2 32mm L3 23mm L4 12mm D1 ø 7x8mm D2 ø 10mm M6R ET 0.9A at 50Hz 2800rpm at 60Hz 3400rpm suitable capacitor 6.3µF/450V type FIR1004		
For models:	900 G, 930, 938.3, KCP97-VG-A, KF1001G, KF1001G-IX-AL, KF1001GLPG, KF1001G-LPG-IX-AL, KF630, KF933, KF937, KF965, KF965AL-UD, KF965M		



1

Part No.	602096	Ref. No.	00002570
description	fan wheel blades 30 D1 ø 160mm D2 ø 6.8mm D3 ø 6.9mm H1 38mm H2 24mm H3 4mm		
For models:	EKF423ALUD, EKF423DALUD, EKF423DUD, EKF423UD		



1

Part No.	602097	Ref. No.	00005870 11951439400
description	fan wheel blades 38 D1 ø 200mm D2 ø 6.5x8mm D3 ø 7mm H1 38mm H2 22mm H3 3mm		
For models:	EKF311DUD, EKF311UD, EKF364DUD, EKF364UD, EKF411ALUD, EKF411DALUD, EKF411DUD, EKF411UD, EKF416ALUD, EKF416DALUD, EKF416DUD, EKF416UD, EKF443DUD, EKF443UD, EKF464ALP, EKF464ALUD, EKF464DALUD, EKF464DUD, EKF464UD, EKF523EUD, EKF523UD, KF933, KF933AL, KF933U, KF981, KF981-DOUBLE, KF981-DOUBLE-EV, KF981-DOUBLE-EV-UD, KF981-DOUBLE-EV-UI, KF981-DOUBLE-UD, KF981-DOUBLE-V, KF981-DOUBLE-V-UD, KF981-DOUBLE-V-UI, KF981EV, KF981UD, KF981V		



1

Part No.	602098	Ref. No.	00007180 00007181
description	fan wheel blades 45 D1 ø 196mm D2 ø 6.5x8mm D3 ø 8mm H1 60mm H2 23mm H3 3mm		
For models:	EKF1016EUD, EKF1016UD, EKF1064EUD, EKF1064TC, EKF1064UD, EKF1111EUD, EKF1111EVUD, EKF1111TC, EKF1111UD, EKF464ALP, EKF464P, EKF464TC, EKF511TC, EKF616EUD, EKF616UD, EKF664.3EUD, EKF664EUD, EKF664P, EKF664TC, EKF664UD, EKF711.3EUD, EKF711EUD, EKF711EV, EKF711TC, EKF711UD		



1

Part No.	601187	Ref. No.	00005740 11950389400
description	fan wheel D1 ø 200mm H1 40mm blades 38 D2 ø 8mm D3 ø 8mm H2 28mm		
For models:	930, 938.3, KF937, KF965, KF965AL-UD, KF965M		



1

Part No.	601186	Ref. No.	11950509400
description	fan wheel D1 ø 215mm H1 40mm blades 38 D2 ø 8mm D3 ø 8mm H2 26.5mm		
For models:	900 G, KCP97-VG-A, KF1001G, KF1001G-IX-AL, KF1001G-LPG, KF1001G-LPG-IX-AL		

hot air fans

miscellaneous



1

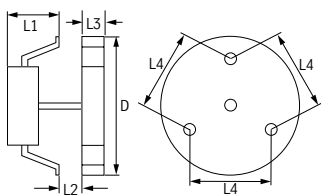

Part No.	601125	Ref. No.	01201460 11950057000 11950257000
description	hot air fan 220-240V 45W 50/60Hz L1 70mm L2 11mm L3 25mm L4 87mm fan wheel ø 150mm FIME type C30R0479CLF		
For models:	440, 640 CI, 640 CI+GRILL, 640 CI+U, 648 CI, 900, CV5-90/X, EKF411, EKF411.3D, EKF411.3GRILL, EKF411D, EKF412US, EKF464, EKF464.3D, EKF464.3GRILL, EKF464D, EKF620S, EKF620US, KCV96, KCV96P, KF412, KF412U, KF620, KF622, KF723, KF723M, KF912, KF912IX		
accessories for	601125		
	Part No.	550879	Ref. No. —
	insulation ø 130mm thickness 3mm hole ø 20mm for hot air fan		



1

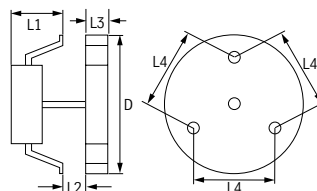

Part No.	602100	Ref. No.	01203230 01203231
description	hot air fan 240V 59W 50/60Hz L1 80mm L2 16mm fan wheel ø 150mm IMS type 138251		
For models:	EKF423, EKF423AL, EKF423ALM, EKF423ALP, EKF423ALU, EKF423ALUP, EKF423M, EKF423P, EKF423U, EKF423UP		

accessories

miscellaneous



1

Part No.	211088	Ref. No.	00002830 09960218715
description	guard L 155mm W 155mm for fan		
For models:	EKF412US, EKF620S, EKF620US, KC96V, KCV96, KCV96P, KF412, KF412U, KF620, KF622, KF723, KF723M, KF912, KF912IX		



pumps

booster pumps II

accessories



1

Part No.	365012	Ref. No.	01201030
description	operating capacitor capacity 6.3µF 450V tolerance 5% 50Hz ambient temperature max. -25 to +85°C ø 30mm L 61mm M8 plastic connection male faston 6.3mm protection		
For models:	EKF1016EUD, EKF1016UD, EKF1064EUD, EKF1064TC, EKF1064UD, EKF1111EUD, EKF1111EVUD, EKF1111TC, EKF1111UD, EKF1664TC, EKF2011TC, EKF311DUD, EKF311UD, EKF364DUD, EKF364UD, EKF411ALUD, EKF411DALUD, EKF411DUD, EKF411UD, EKF416ALUD, EKF416DALUD, EKF416DUD, EKF416UD, EKF423ALUD, EKF423DALUD, EKF423DUD, EKF423UD, EKF443DUD, EKF464ALUD, EKF464DALUD, EKF464DUD, EKF464UD, EKF523EUD, EKF523UD, EKF616EUD, EKF616UD, EKF664.3EUD, EKF664EUD, EKF664P, EKF664TC, EKF664UD, EKF711.3EUD, EKF711EUD, EKF711EV, EKF711TC, EKF711UD		

condensators & interference suppression filters

operating capacitors

plastic



1

Part No.	365012	Ref. No.	01201030
description	operating capacitor capacity 6.3µF 450V tolerance 5% 50Hz ambient temperature max. -25 to +85°C ø 30mm L 61mm M8 plastic connection male faston 6.3mm protection		
For models:	EKF1016EUD, EKF1016UD, EKF1064EUD, EKF1064TC, EKF1064UD, EKF1111EUD, EKF1111EVUD, EKF1111TC, EKF1111UD, EKF1664TC, EKF2011TC, EKF311DUD, EKF311UD, EKF364DUD, EKF364UD, EKF411ALUD, EKF411DALUD, EKF411DUD, EKF411UD, EKF416ALUD, EKF416DALUD, EKF416DUD, EKF416UD, EKF423ALUD, EKF423DALUD, EKF423DUD, EKF423UD, EKF443DUD, EKF464ALUD, EKF464DALUD, EKF464DUD, EKF464UD, EKF523EUD, EKF523UD, EKF616EUD, EKF616UD, EKF664.3EUD, EKF664EUD, EKF664P, EKF664TC, EKF664UD, EKF711.3EUD, EKF711EUD, EKF711EV, EKF711TC, EKF711UD		

fuses

fine fuses



1

Part No.	358675	Ref. No.	11950227000
description	fine fuse size ø5x20mm 2.5A fast-acting rated 250V Qty 10 pcs		

fine fuse holders



1

Part No.	550105	Ref. No.	11950147000
description	rail-mounted terminal WIELAND type WK10/SIU 5X20 /V0 suitable fuse ø5x20mm 1.0-16mm² 10A rated 250V		

electric accessories

terminals

connection terminals with screw/faston connections



1

Part No.	551444	Ref. No.	01200720 481560 FV71
description	power terminal block 3-pole max. 25A max 450V connection male faston 6.3mm temp.-resist. 150°C		
For models:	EKF412US, EKF423, EKF423AL, EKF423ALM, EKF423ALU, EKF423M, EKF423U		

connection terminals with screw connection



1

Part No.	550507	Ref. No.	01200980 09950957300
description	power terminal block 4-pole max. 40A max 400V connection M6/M6 temp.-resist. 150°C		
For models:	900, CV5-90/X, EKF311DUD, EKF311UD, EKF364DUD, EKF364UD, EKF411, EKF411.3D, EKF411.3GRILL, EKF411ALUD, EKF411D, EKF-411DALUD, EKF411DUD, EKF411UD, EKF416ALUD, EKF416DALUD, EKF416DUD, EKF416UD, EKF423ALUD, EKF423DALUD, EKF423DUD, EKF423UD, EKF443DUD, EKF464, EKF464.3D, EKF464.3GRILL, EKF464ALP, EKF464ALUD, EKF464D, EKF464DALUD, EKF464DUD, EKF464P, EKF464UD, EKF523EUD, EKF523UD, KC96V, KF912, KF912IX, KF933, KF933AL, KF933AL-U, KF933U, KF937, KF965, KF965AL-UD, KF965M, KF981, KF981-DOUBLE, KF981-DOUBLE-EV-UD, KF981-DOUBLE-EV-UI... (Other models you can see in the webshop)		



			
1			
Part No.	550355	Ref. No.	01201760
description	power terminal block 6-pole max. 40A max 400V connection M6/M6 temp.-resist. 150°C cross section 6mm ² hole distance 122mm		
For models:	EKF1016EUD, EKF1016UD, EKF1064EUD, EKF1064TC, EKF1064UD, EKF1111EUD, EKF1111EVUD, EKF1111TC, EKF1111UD, EKF464TC, EKF511TC, EKF616EUD, EKF616UD, EKF664.3EUD, EKF664EUD, EKF664P, EKF664TC, EKF664UD, EKF711.3EUD, EKF711EUD, EKF711EV, EKF711TC, EKF711UD		

connection boxes

			
1			
Part No.	550755 ¹	Ref. No.	00002260 09950047000
description	connecting cable 3-pole contacts P+N+E with strain relief black L 1600mm 2.5mm ²		
For models:	EKF423ALP, EKF423ALUP, EKF423P, EKF423UP, EKF620S, EKF620US, KCP97-VG-A, KCV96, KCV96P, KF1001G, KF1001G-IX-AL, KF1001G-LPG, KF1001G-LPG-IX-AL, KF412, KF412U, KF620, KF622, KF630, KF723, KF723M, KF733, KL823, KL864, KL898, TCFG		

¹with cable 1600mm

rail-mounted terminals

WIELAND

fuse terminal blocks

			
1			
Part No.	550105	Ref. No.	11950147000
description	rail-mounted terminal WIELAND type WK10/SIU 5X20 /V0 suitable fuse ø5x20mm 1.0-16mm ² 10A rated 250V		

accessories

			
1			
Part No.	550370	Ref. No.	11950137000
description	terminal block end bracket clampsmm ²		

gas taps



SABAF

			
1			
Part No.	101747	Ref. No.	00000820 01991628700 21003740
description	gas tap SABAF type 10 gas inlet pipe flange ø14mm bypass nozzle ø 0.4mm gas outlet 1/4" (tube ø 8mm) front fixing M13x1 thermocouple connection M8x1 shaft ø 6x4.6mm shaft L 23.5/18.5mm shaft flat upper		
For models:	CV5-90/X, KC96V, KCP97-VG-A, KCV96, KCV96P, KPP96, KTPP96		
spare parts for	101747		
	Part No.	101376	Ref. No. 01990308000
	gasket ID ø 8mm ED ø 12mm H 3/5mm		
	Part No.	106724	Ref. No. —
	magnet unit L 30mm D1 ø 12.5mm D2 ø 8.5mm suitable for SABAF		
accessories for	101747		
	Part No.	101277	Ref. No. 01991738700
	olive ID ø 8mm Qty 1 pcs		
	Part No.	101751	Ref. No. 01990279512
	bracket		
	Part No.	520656	Ref. No. —
	union nut thread 1/4" tube ø 6/8mm		
	Part No.	560082	Ref. No. —
	hexagonal screw thread M4 thread L 16mm SS WS 7 Qty 20 pcs DIN 933 / ISO 4017		

			
1			
Part No.	101748	Ref. No.	01991578700 21003870
description	gas tap SABAF type 10 gas inlet pipe flange ø14mm bypass nozzle ø 0.5mm gas outlet 1/4" (tube ø 8mm) front fixing M13x1 thermocouple connection M8x1 shaft ø 6x4.6mm shaft L 24/18mm shaft flat upper		
For models:	CV5-90/X, KC96V, KCP97-VG-A, KCV96, KCV96P, KPP96, KTPP96, TCFG		
spare parts for	101748		
	Part No.	101376	Ref. No. 01990308000
	gasket ID ø 8mm ED ø 12mm H 3/5mm		
	Part No.	106724	Ref. No. —
	magnet unit L 30mm D1 ø 12.5mm D2 ø 8.5mm suitable for SABAF		

Table continues overleaf



accessories for	101748		
	Part No.	101277	Ref. No. 01991738700
	olive ID ø 8mm Qty 1 pcs		
	Part No.	101751	Ref. No. 01990279512
	bracket		
	Part No.	520656	Ref. No. —
	union nut thread 1/4" tube ø 6/8mm		



			
1			
Part No.	101749	Ref. No.	00000810 01991608700
description	gas tap SABAF type 10 gas inlet pipe flange ø14mm bypass nozzle ø 0.74mm gas outlet 1/4" (tube ø 8mm) front fixing thermocouple connection M8x1 shaft ø 6x4.6mm shaft L 23/17mm shaft flat upper		
For models:	CV5-90/X, KC96V, KCP97-VG-A, KCV96, KCV96P, KPP96, KTPP96		
spare parts for	101749		
	Part No.	101376	Ref. No. 01990308000
	gasket ID ø 8mm ED ø 12mm H 3/5mm		
	Part No.	106724	Ref. No. —
	magnet unit L 30mm D1 ø 12.5mm D2 ø 8.5mm suitable for SABAF		
accessories for	101749		
	Part No.	101277	Ref. No. 01991738700
	olive ID ø 8mm Qty 1 pcs		
	Part No.	101751	Ref. No. 01990279512
	bracket		
	Part No.	520656	Ref. No. —
	union nut thread 1/4" tube ø 6/8mm		

gas valves and ignition boxes

gas control valves

HONEYWELL

			
1			
Part No.	107579	Ref. No.	01201810
description	gas valve type VK4105A 1100 4 220/240V 50/60Hz gas inlet 3/4" gas outlet 3/4" pressure range 15-60mbar max 60mbar HONEYWELL		

			
1			
Part No.	101989	Ref. No.	11950407000
description	gas valve 230V 50Hz gas inlet 3/4" gas outlet 3/4" SIT pressure range 2-50mbar equiv. no. 0.840.016		
For models:	900 G, KCP97-VG-A, KF1001G, KF1001G-IX-AL, KF1001G-LPG, KF1001G-LPG-IX-AL, KF1010GE-UD		
spare parts for	101989		
	Part No.	106214	Ref. No. —
	solenoid coil 230V 50Hz Sigma		
accessories for	101989		
	Part No.	107222	Ref. No. —
	plug for solenoid valve 3-pole cable length 1070mm		

ignition boxes

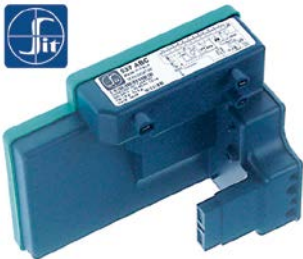
			
1			
Part No.	101990	Ref. No.	11950397000
description	ignition box SIT type 537ABC electrodes 3 waiting time 1.5s safety time 5s 230V 10VA 50-60Hz protection IP40		
For models:	900 G, KCP97-VG-A, KF1001G, KF1001G-IX-AL, KF1001G-LPG, KF1001G-LPG-IX-AL		

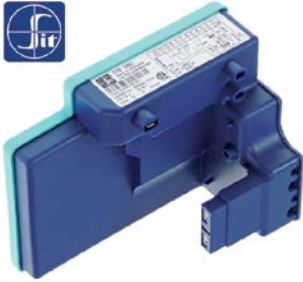
			
1			
Part No.	107850	Ref. No.	01900020
description	ignition box SIT type 579DBC electrodes 2 waiting time 1.5s safety time 6s 220/240V 12VA 50/60Hz		



ignition parts

electrodes



1

Part No.	102496	Ref. No.	07991148000
description	gasket for ignition electrode		
For models:	KCP97-VG-A, KCV96, KCV96P, KPP96, KTPP96		



1

Part No.	102495	Ref. No.	01993247000
description	ignition electrode D1 ø 6mm cable length 580mm connection male faston 2.8mm D2 ø 8mm L1 1mm BL1 22mm BL2 3.5mm BL3 13mm		
For models:	KCP97-VG-A		

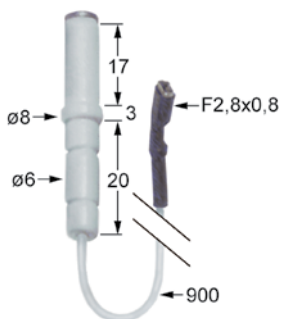

1

Part No.	102312	Ref. No.	01951047000
description	ignition electrode D1 ø 6mm cable length 900mm connection F 2.8x0.8mm D2 ø 8mm BL1 17mm BL2 3mm BL3 20mm to clip		
For models:	CV5-90/X, KC96V		



1

Part No.	102494	Ref. No.	01200600 01200610 01992307000
description	ignition electrode D1 ø 6mm total length 710mm cable length 660mm connection male faston 2.8mm D2 ø 8mm L1 1mm BL1 17mm BL2 3.5mm BL3 13mm		
For models:	KCP97-VG-A, KCV96, KCV96P, KPP96, KTPP96		



1

Part No.	102313	Ref. No.	01951077000
description	ignition electrode D1 ø 7mm D2 ø 12mm connection F 2.8x0.8mm		
For models:	CV5-90/X, KC96V		
accessories for	102313		



Part No.	105704	Ref. No.	01951057720
description	compression spring L 14.5mm ø 9mm wire gauge ø 0.9mm		



Part No.	550542	Ref. No.	01951067720
description	retaining ring E D1 ø 5mm D2 ø 11mm DIN 6799 thickness 0.7mm		



1

Part No.	101795	Ref. No.	01201570 11950447000
description	ignition electrode flange length 23mm flange width 15mm D1 ø 6.5mm L1 12mm L2 27mm BL1 17mm BL2 17mm connection F 4.8x0.8mm cable length 970mm fixing dimensions ø5x4mm with flange		
For models:	900 G, KF1001G, KF1001G-IX-AL, KF1001G-LPG, KF1001G-LPG-IX-AL		

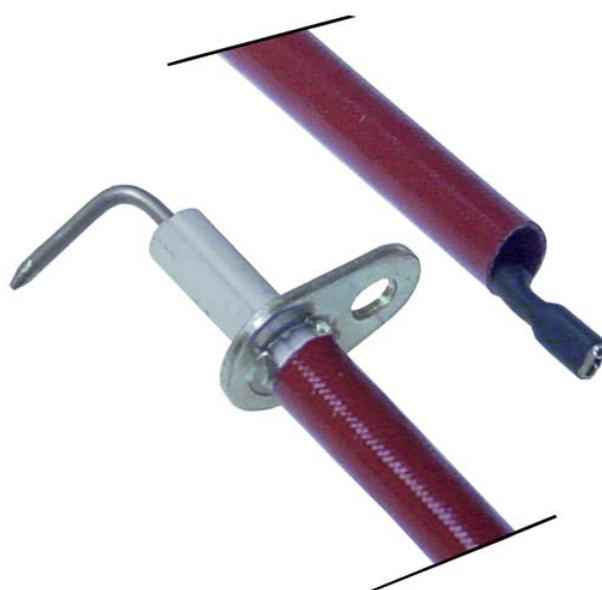

1

Part No.	101794	Ref. No.	01201560 11950437000
description	ignition electrode flange length 23mm flange width 15mm D1 ø 6.5mm L1 9mm L2 16mm BL1 17mm BL2 17mm connection F 2.8x0.8mm cable length 960mm fixing dimensions ø5x4mm with flange		
For models:	900 G, KF1001G, KF1001G-IX-AL, KF1001G-LPG, KF1001G-LPG-IX-AL		





			
1			
Part No.	102498	Ref. No.	07991159001
description	spring clip for ignition electrode		
For models:	KCP97-VG-A, KCV96, KCV96P, KPP96, KTPP96		

			
1			
Part No.	102257	Ref. No.	01990368700
description	thermocouple M8x1 L 600mm M8x1		
For models:	CV5-90/X, KC96V, TCFG		

ignition units

			
1			
Part No.	101037	Ref. No.	01951327000 07950017000
description	ignition unit outputs 6		
For models:	CV5-90/X, KC96V, KCP97-VG-A, KCV96, KCV96P		

			
1			
Part No.	102493	Ref. No.	01200590 01992288700
description	thermocouple M8x1 L 650mm M6x0.75		
For models:	KCP97-VG-A, KCV96, KCV96P, KPP96, KTPP96		

			
1			
Part No.	102389	Ref. No.	01202611
description	ignition unit outputs 6 230VAC dimensions 135x23x34mm mounting distance 123mm inlet F6.3x0.8 outlet F2.8x0.8 0.6VA 50/60Hz		

accessories			
nuts			
			
1			
Part No.	102497	Ref. No.	01500810 07991978700
description	nut thread M6x0.75 H 3mm WS 8 steel Qty 1 pcs		
For models:	KCP97-VG-A, KCV96, KCV96P, KPP96, KTPP96, TCFG		

thermocouples

plug-in thermocouples

plug-in thermocouples standard

threaded thermocouples (miscellaneous)

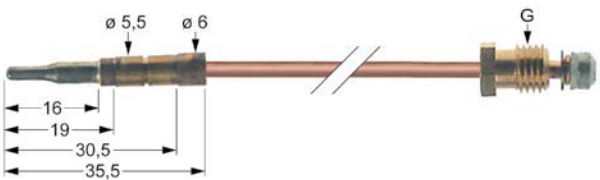
			
1			
Part No.	102258	Ref. No.	01991828700
description	thermocouple M8x1 L 600mm plug connection ø5.5mm		
For models:	CV5-90/X, KC96V		

threaded thermocouples

threaded thermocouples standard

threaded thermocouples (miscellaneous)

			
1			
Part No.	102492	Ref. No.	01992278700
description	thermocouple M8x1 L 600mm M6x0.75		
For models:	KCP97-VG-A, KCV96, KCV96P, KPP96, KTPP96		

gas burners



hob burners

universal hob burners



SABAF





2 series - standard

			
1			
Part No.	105993	Ref. No.	00001230 01992246610
description	burner cap 1.8kW ø 75mm bright finish		
For models:	KCP97-VG-A, KCV96, KCV96P, KPP96, KTPP96		



							
1							
Part No.	105054	Ref. No.	07991196610				
description	burner cap 3kW ø 100mm H 3.5mm bright finish						
For models:	KCP97-VG-A, KCV96, KCV96P, KPP96, KTPP96						
accessories for	105054						
		<table border="1"> <tr> <td>Part No.</td> <td>105058</td> <td>Ref. No.</td> <td>00001940 07991188901</td> </tr> </table>	Part No.	105058	Ref. No.	00001940 07991188901	
Part No.	105058	Ref. No.	00001940 07991188901				
		<table border="1"> <tr> <td>Part No.</td> <td>105059</td> <td>Ref. No.</td> <td>—</td> </tr> </table>	Part No.	105059	Ref. No.	—	
Part No.	105059	Ref. No.	—				





			
1			
Part No.	104271	Ref. No.	00001220 01992238901
description	burner head 1.8kW for burner cap ø 75mm		
For models:	KCP97-VG-A, KCV96, KCV96P, KPP96, KTPP96		
accessories for	104271		
	Part No.	107372	Ref. No. —
burner lower part 1.8kW for igniter ø 6mm for thermocouple ø 6mm without nozzle for burner cap ø 75mm			
	Part No.	107373	Ref. No. —
burner cap 1.8kW ø 75mm matt finish			



			
1			
Part No.	105058	Ref. No.	00001940 07991188901
description	burner head 3kW for igniter ø 6mm for burner cap ø 100mm		
For models:	KCP97-VG-A, KCV96, KCV96P, KPP96, KTPP96		
accessories for	105058		
	Part No.	105054	Ref. No. 07991196610
burner cap 3kW ø 100mm H 3.5mm bright finish			
	Part No.	105059	Ref. No. —
burner lower part 3kW for igniter ø 6mm for thermocouple ø 6mm without nozzle for burner cap ø 100mm			
	Part No.	107374	Ref. No. —
burner cap 3kW ø 100mm H 3.5mm matt finish			

			
1			
Part No.	104272	Ref. No.	01992228900
description	burner lower part 1.8kW for igniter ø 6mm for thermocouple ø 6mm with nozzle ø0.97mm for burner cap ø 75mm		
For models:	KCP97-VG-A, KCV96, KCV96P, KPP96, KTPP96		

			
1			
Part No.	105120	Ref. No.	00002080 07991698900
description	burner lower part 3kW for igniter ø 7mm for thermocouple ø 6mm with nozzle ø1.15mm for burner cap ø 100mm		
For models:	KCP97-VG-A, KCV96, KCV96P, KPP96, KTPP96		
accessories for	105120		
	Part No.	105121	Ref. No. —
burner head 3kW for igniter ø 7.5mm for burner cap ø 100mm			

accessories for	105120		
	Part No.	105122	Ref. No. —
burner cap 3kW ø 100mm H 6mm matt finish			

2 series - flat skirt version			
			
1			
Part No.	105993	Ref. No.	00001230 01992246610
description	burner cap 1.8kW ø 75mm bright finish		
For models:	KCP97-VG-A, KCV96, KCV96P, KPP96, KTPP96		

			
1			
Part No.	105054	Ref. No.	07991196610
description	burner cap 3kW ø 100mm H 3.5mm bright finish		
For models:	KCP97-VG-A, KCV96, KCV96P, KPP96, KTPP96		
accessories for	105054		
	Part No.	105058	Ref. No. 00001940 07991188901
burner head 3kW for igniter ø 6mm for burner cap ø 100mm			
	Part No.	105059	Ref. No. —
burner lower part 3kW for igniter ø 6mm for thermocouple ø 6mm without nozzle for burner cap ø 100mm			



			
1			
Part No.	104272	Ref. No.	01992228900
description	burner lower part 1.8kW for igniter ø 6mm for thermocouple ø 6mm with nozzle ø0.97mm for burner cap ø 75mm		
For models:	KCP97-VG-A, KCV96, KCV96P, KPP96, KTPP96		



			
1			
Part No.	105120	Ref. No.	00002080 07991698900
description	burner lower part 3kW for igniter ø 7mm for thermocouple ø 6mm with nozzle ø1.15mm for burner cap ø 100mm		
For models:	KCP97-VG-A, KCV96, KCV96P, KPP96, KTPP96		
accessories for	105120		
	Part No.	105121	Ref. No. —
burner head 3kW for igniter ø 7.5mm for burner cap ø 100mm			
	Part No.	105122	Ref. No. —
burner cap 3kW ø 100mm H 6mm matt finish			



triple ring burner series - standard version			
			
1			
Part No.	105063	Ref. No.	07991116610
description	burner cap 3.6kW ø 131mm H 4mm mounting pos. outer		
For models:	KCP97-VG-A, KCV96, KCV96P, KPP96, KTPP96		
accessories for	105063		
	Part No.	Ref. No.	
	105064	07991126610	
description	burner cap 3.6kW ø 61mm H 6.5mm mounting pos. inner bright finish		
	Part No.	Ref. No.	01993448901
description	burner head 3.6kW for burner cap ø 61/131mm		
	Part No.	Ref. No.	01992398900
description	burner lower part 3.6kW for igniter ø 6mm for thermocouple ø 6mm with nozzle ø1.35mm ID ø 64mm for burner cap ø 61/131mm		
	Part No.	Ref. No.	—
description	burner lower part 3.6kW for igniter ø 6mm for thermocouple ø 6mm with nozzle ø1.35mm ID ø 75mm for burner cap ø 61/131mm		

			
1			
Part No.	105064	Ref. No.	07991126610
description	burner cap 3.6kW ø 61mm H 6.5mm mounting pos. inner bright finish		
For models:	KCP97-VG-A, KCV96, KCV96P, KPP96, KTPP96		
accessories for	105064		
	Part No.	Ref. No.	
	105063	07991116610	
description	burner cap 3.6kW ø 131mm H 4mm mounting pos. outer		
	Part No.	Ref. No.	01993448901
description	burner head 3.6kW for burner cap ø 61/131mm		
	Part No.	Ref. No.	01992398900
description	burner lower part 3.6kW for igniter ø 6mm for thermocouple ø 6mm with nozzle ø1.35mm ID ø 64mm for burner cap ø 61/131mm		
	Part No.	Ref. No.	—
description	burner lower part 3.6kW for igniter ø 6mm for thermocouple ø 6mm with nozzle ø1.35mm ID ø 75mm for burner cap ø 61/131mm		

			
1			
Part No.	105065	Ref. No.	01993448901
description	burner head 3.6kW for burner cap ø 61/131mm		
accessories for	105065		
	Part No.	Ref. No.	
	105063	07991116610	
description	burner cap 3.6kW ø 131mm H 4mm mounting pos. outer		
	Part No.	Ref. No.	07991126610
description	burner cap 3.6kW ø 61mm H 6.5mm mounting pos. inner bright finish		
	Part No.	Ref. No.	01992398900
description	burner lower part 3.6kW for igniter ø 6mm for thermocouple ø 6mm with nozzle ø1.35mm ID ø 64mm for burner cap ø 61/131mm		

			
1			
Part No.	105717	Ref. No.	01992398900
description	burner lower part 3.6kW for igniter ø 6mm for thermocouple ø 6mm with nozzle ø1.35mm ID ø 64mm for burner cap ø 61/131mm		
For models:	KCP97-VG-A, KCV96, KCV96P, KPP96, KTPP96		
accessories for	105717		
	Part No.	Ref. No.	
	101277	01991738700	
description	olive ID ø 8mm Qty 1 pcs		
	Part No.	Ref. No.	—
description	union screw thread M13x1 tube ø 8mm Qty 1 pcs		

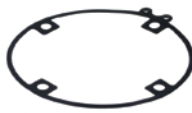
			
1			
Part No.	104273	Ref. No.	01000170 01981558000
description	gasket for burner cap ø 61/131mm		
For models:	KCP97-VG-A, KCV96, KCV96P, KPP96, KTPP96		

triple ring burner series - flat skirt version			
			
1			
Part No.	105063	Ref. No.	07991116610
description	burner cap 3.6kW ø 131mm H 4mm mounting pos. outer		
For models:	KCP97-VG-A, KCV96, KCV96P, KPP96, KTPP96		
accessories for	105063		
	Part No.	Ref. No.	
	105064	07991126610	
description	burner cap 3.6kW ø 61mm H 6.5mm mounting pos. inner bright finish		
	Part No.	Ref. No.	01993448901
description	burner head 3.6kW for burner cap ø 61/131mm		
	Part No.	Ref. No.	01992398900
description	burner lower part 3.6kW for igniter ø 6mm for thermocouple ø 6mm with nozzle ø1.35mm ID ø 64mm for burner cap ø 61/131mm		
	Part No.	Ref. No.	—
description	burner lower part 3.6kW for igniter ø 6mm for thermocouple ø 6mm with nozzle ø1.35mm ID ø 75mm for burner cap ø 61/131mm		





			
1			
Part No.	105064	Ref. No.	07991126610
description	burner cap 3.6kW ø 61mm H 6.5mm mounting pos. inner bright finish		
For models:	KCP97-VG-A, KCV96, KCV96P, KPP96, KTPP96		
accessories for	105064		
	Part No.	Ref. No.	
	105063	07991116610	
description	burner cap 3.6kW ø 131mm H 4mm mounting pos. outer		

Table continues overleaf



accessories for	105064		
	Part No.	105065	Ref. No. 01993448901
	burner head 3.6kW for burner cap ø 61/131mm		
	Part No.	105717	Ref. No. 01992398900
	burner lower part 3.6kW for igniter ø 6mm for thermocouple ø 6mm with nozzle ø1.35mm ID ø 64mm for burner cap ø 61/131mm		
	Part No.	105922	Ref. No. —
	burner lower part 3.6kW for igniter ø 6mm for thermocouple ø 6mm with nozzle ø1.35mm ID ø 75mm for burner cap ø 61/131mm		

	1		
Part No.	105717	Ref. No.	01992398900
description	burner lower part 3.6kW for igniter ø 6mm for thermocouple ø 6mm with nozzle ø1.35mm ID ø 64mm for burner cap ø 61/131mm		
For models:	KCP97-VG-A, KCV96, KCV96P, KPP96, KTPP96		
accessories for	105717		
	Part No.	101277	Ref. No. 01991738700
	olive ID ø 8mm Qty 1 pcs		
	Part No.	101477	Ref. No. —
	union screw thread M13x1 tube ø 8mm Qty 1 pcs		

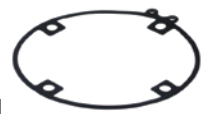
	1		
Part No.	104273	Ref. No.	01000170 01981558000
description	gasket for burner cap ø 61/131mm		
For models:	KCP97-VG-A, KCV96, KCV96P, KPP96, KTPP96		

producer-specific hob burners

TECNOEKA

900 series

	1		
Part No.	105703	Ref. No.	01991778700
description	air mixing tube for burner UR		
For models:	CV5-90/X, KC96V		

	1		
Part No.	105887	Ref. No.	01980838700
description	burner 3.1kW complete		

	1		
Part No.	105886	Ref. No.	01980818700
description	burner 3.6kW complete		

	1		
Part No.	105888	Ref. No.	01980828700 01982228700
description	burner R 2.7kW complete ball port ø 1.19mm		

	1		
Part No.	105489	Ref. No.	01982218700
description	burner SR 3.1kW complete		

	1		
Part No.	105702	Ref. No.	01991818700
description	burner cap mounting pos. inner type UR		
For models:	CV5-90/X, KC96V		

	1		
Part No.	105631	Ref. No.	01991808700
description	burner cap mounting pos. outer type UR		
For models:	CV5-90/X, KC96V		

	1		
Part No.	105623	Ref. No.	01991958700
description	burner cap R 2.7kW		
For models:	CV5-90/X, KC96V		

	1		
Part No.	105621	Ref. No.	01991968700
description	burner cap SR ø 67mm 3.1kW		
For models:	CV5-90/X, KC96V		





 <p>1</p>			
Part No.	105633	Ref. No.	01991788900
description	burner head 3.6kW type UR		
For models:	CV5-90/X, KC96V		

 <p>1</p>			
Part No.	105624	Ref. No.	01991938900
description	burner head R 2.7kW		
For models:	CV5-90/X, KC96V		

 <p>1</p>			
Part No.	105622	Ref. No.	01991978900
description	burner head SR 3.1kW		
For models:	CV5-90/X, KC96V		

 <p>1</p>			
Part No.	105626	Ref. No.	01991878700
description	burner lower part for burner R, SR		

 <p>1</p>			
Part No.	105632	Ref. No.	01991798700
description	burner ring 3.6kW type UR		
For models:	CV5-90/X, KC96V		

 <p>1</p>			
Part No.	105630	Ref. No.	01991928900
description	mounting flange mounting pos. outer for burner UR		
For models:	CV5-90/X, KC96V		

 <p>1</p>			
Part No.	105628	Ref. No.	01991858700
description	nozzle holder for burner R, SR		
For models:	CV5-90/X, KC96V		

 <p>1</p>			
Part No.	105634	Ref. No.	01991768900
description	nozzle holder for burner UR		
For models:	CV5-90/X, KC96V		

 <p>1</p>			
Part No.	105625	Ref. No.	01991918700
description	nut for burner R, SR		
For models:	CV5-90/X, KC96V		

 <p>1</p>			
Part No.	105629	Ref. No.	01992028700
description	nut for nozzle holder R, SR		
For models:	CV5-90/X, KC96V		

 <p>1</p>			
Part No.	532454	Ref. No.	01991948000
description	O-ring silicone thickness 3.53mm ID ø 101.2mm Qty 1 pcs		
For models:	CV5-90/X, KC96V		

 <p>1</p>			
Part No.	532455	Ref. No.	01991988000
description	O-ring silicone thickness 3.53mm ID ø 78.97mm Qty 1 pcs		
For models:	CV5-90/X, KC96V		

 <p>1</p>			
Part No.	532456	Ref. No.	01991898000
description	O-ring Viton thickness 2mm ID ø 16mm Qty 1 pcs		
For models:	CV5-90/X, KC96V		

 <p>1</p>			
Part No.	105627	Ref. No.	01991888900
description	venturi for burner R, SR		
For models:	CV5-90/X, KC96V		



miscellaneous



1

Part No.	104271	Ref. No.	00001220 01992238901
-----------------	--------	-----------------	-------------------------

description	burner head 1.8kW for burner cap ø 75mm
For models:	KCP97-VG-A, KCV96, KCV96P, KPP96, KTPP96

accessories for	104271
------------------------	--------



Part No.	107372	Ref. No.	—
description	burner lower part 1.8kW for igniter ø 6mm for thermocouple ø 6mm without nozzle for burner cap ø 75mm		



Part No.	107373	Ref. No.	—
description	burner cap 1.8kW ø 75mm matt finish		



1

Part No.	104272	Ref. No.	01992228900
-----------------	--------	-----------------	-------------

description	burner lower part 1.8kW for igniter ø 6mm for thermocouple ø 6mm with nozzle ø0.97mm for burner cap ø 75mm
For models:	KCP97-VG-A, KCV96, KCV96P, KPP96, KTPP96

pan supports



1

Part No.	210203	Ref. No.	01960796610 30500010
-----------------	--------	-----------------	-------------------------

description	pan support W 220mm L 530mm
For models:	CV5-90/X, KC96V, KCP97-VG-A, KCV96, KCV96P, KPP96, KTPP96



1

Part No.	210204	Ref. No.	01960806610 30500020
-----------------	--------	-----------------	-------------------------

description	pan support W 290mm L 520mm
For models:	CV5-90/X, KC96V, KCP97-VG-A, KCV96, KCV96P, KPP96, KTPP96

accessories

pan supports



1

Part No.	210203	Ref. No.	01960796610 30500010
-----------------	--------	-----------------	-------------------------

description	pan support W 220mm L 530mm
For models:	CV5-90/X, KC96V, KCP97-VG-A, KCV96, KCV96P, KPP96, KTPP96



1

Part No.	210204	Ref. No.	01960806610 30500020
-----------------	--------	-----------------	-------------------------

description	pan support W 290mm L 520mm
For models:	CV5-90/X, KC96V, KCP97-VG-A, KCV96, KCV96P, KPP96, KTPP96

bar burners

bar burners



1

Part No.	105635	Ref. No.	11980137915
-----------------	--------	-----------------	-------------

description	bar burner angled L 740mm W 355mm ømm Hmm convection oven
For models:	900 G, KCP97-VG-A, KF1001G, KF1001G-IX-AL, KF1001G-LPG, KF1001G-LPG-IX-AL

accessories

nozzle holders





1

Part No.	105628	Ref. No.	01991858700
-----------------	--------	-----------------	-------------

description	nozzle holder for burner R, SR
For models:	CV5-90/X, KC96V



miscellaneous			
			
1			
Part No.	105703	Ref. No.	01991778700
description	air mixing tube for burner UR		
For models:	CV5-90/X, KC96V		

			
1			
Part No.	105704	Ref. No.	01951057720
description	compression spring L 14.5mm ø 9mm wire gauge ø 0.9mm		
For models:	CV5-90/X, KC96V		

			
1			
Part No.	105625	Ref. No.	01991918700
description	nut for burner R, SR		
For models:	CV5-90/X, KC96V		

			
1			
Part No.	105629	Ref. No.	01992028700
description	nut for nozzle holder R, SR		
For models:	CV5-90/X, KC96V		

gas nozzles

main nozzles



gas nozzles M6x0.75			
			
1			
Part No.	106481	Ref. No.	00001960
description	gas injector thread M6x0.75 WS 7 bore ø 0.95mm		

gas nozzles M8x1			
			
1			
Part No.	102694	Ref. No.	00000920 01991848700
description	gas injector thread M8x1 WS 10 bore ø 0.9mm		
For models:	CV5-90/X, KC96V		

			
1			
Part No.	102693	Ref. No.	01991758700
description	gas injector thread M8x1 WS 10 bore ø 1.4mm gas pressure 20mbar		
For models:	CV5-90/X, KC96V		

auxiliary gas parts

screw connections

union nuts			
			
1			
Part No.	101296	Ref. No.	01991748612
description	union nut thread M12x1 for pipe ø 8mm		
For models:	CV5-90/X, KC96V		
accessories for	101296		
	Part No.	Ref. No.	
	101277	01991738700	
	 olive ID ø 8mm Qty 1 pcs		

equipment-specific units

for convection ovens/combi-steamers

			
1			
Part No.	692843	Ref. No.	00004380 09980728000
description	spacer bush ID ø 7mm H 7.5mm ED ø 17.5mm for glass plate white Spacer		
For models:	EKF311DUD, EKF311UD, EKF364DUD, EKF364UD, EKF411, EKF411.3D, EKF411.3GRILL, EKF411D, EKF411DUD, EKF411UD, EKF416DUD, EKF416UD, EKF423, EKF423AL, EKF423ALM, EKF423ALP, EKF423ALU, EKF423ALUD, EKF423ALUP, EKF423DALUD, EKF423DUD, EKF423M, EKF423P, EKF423U, EKF423UD, EKF423UP, EKF443DUD, EKF464, EKF464.3D, EKF464.3GRILL, EKF464ALP, EKF464D, EKF464DUD, EKF464P, EKF464UD, KC96V, KCV96, KCV96P, KF1001G, KF1001G-IXAL, KF1001G-LPG, KF1001G-LPG-IX-AL, KF1010GE-UD, KF630, KF733, KF912, KF912IX, KF933, KF933AL-U, KF933U...(Other models you can see in the webshop)		



flow controllers



1

Part No.	101752	Ref. No.	00004390 09980758900
description	flow controller for hot air oven		
For models:	900, 900 G, 930, 938.3		

glass panels



1

Part No.	693226	Ref. No.	01400400 09980438300
description	glass panel L 340mm W 280mm rectangular		
For models:	440, KF412, KF412U		

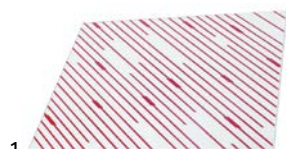

1

Part No.	693227	Ref. No.	09980448316
description	glass panel L 340mm W 280mm thickness 4mm rectangular		
For models:	440		





1

Part No.	693230	Ref. No.	01400020 01981248300
description	glass panel L 430mm W 345mm thickness 4mm rectangular		
For models:	440, 640 CI, 640 CI+GRILL, 640 CI+U, 648 CI, 723KFM, EKf620S, EKf620US, KF723, KF723M, TCFG		





1

Part No.	692841	Ref. No.	21100870 SP007952204	
description	glass panel L 447mm mounting pos. inner W 585mm			
accessories for	692841			
	Part No.	692842	Ref. No.	21100880 SP007952206
	glass panel L 450mm mounting pos. outer W 590mm			
	Part No.	692843	Ref. No.	00004380 09980728000
	spacer bush ID ø 7mm H 7.5mm ED ø 17.5mm for glass plate white Spacer			



1

Part No.	692842	Ref. No.	21100880 SP007952206	
description	glass panel L 450mm mounting pos. outer W 590mm			
accessories for	692842			
	Part No.	692841	Ref. No.	21100870 SP007952204
	glass panel L 447mm mounting pos. inner W 585mm			
	Part No.	692843	Ref. No.	00004380 09980728000
	spacer bush ID ø 7mm H 7.5mm ED ø 17.5mm for glass plate white Spacer			
	Part No.	694993	Ref. No.	00011680 11680
	door handle ø 18mm L 350mm stainless steel M5 black matt			



1

Part No.	693231	Ref. No.	09980578418
description	glass panel L 520mm W 280mm thickness 4mm rectangular		
For models:	440, 640 CI, 640 CI+GRILL, 640 CI+U, 648 CI		



1

Part No.	691811	Ref. No.	09982338418 21000250
description	glass panel L 583mm W 450mm mounting pos. outer		
For models:	KF723, KF723M		

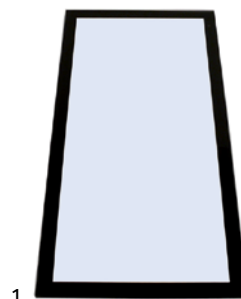

1

Part No.	693224	Ref. No.	01400430 09980648418
description	glass panel L 645mm W 315mm thickness 5mm rectangular		
For models:	900, 900 G, 930, 938, 938.3, CV5-90/X, KC96V, KCV96, KCV96P		



			
1			
Part No.	694454	Ref. No.	09981219002 09981498418 21000170
description	glass panel L 770mm W 455mm thickness 4mm with frame		
For models:	KCV96, KCV96P		

Fans - accessories			
			
1			
Part No.	701630	Ref. No.	00012330
description	air duct for cross flow fan for combi-steamer plastic grey		
For models:	EKF1016EUD, EKF1016UD, EKF1064EUD, EKF1064UD, EKF1111EUD, EKF1111EVUD, EKF1111UD, EKF311DUD, EKF311UD, EKF364DUD, EKF364UD, EKF411, EKF411.3D, EKF411.3GRILL, EKF411ALUD, EKF411D, EKF411DALUD, EKF411DUD, EKF411UD, EKF416ALUD, EKF416DALUD, EKF416DUD, EKF416UD, EKF423, EKF423AL, EKF423ALM, EKF423ALU, EKF423ALUD, EKF423DALUD, EKF423DUD, EKF423M, EKF423U, EKF423UD, EKF443DUD, EKF464, EKF464.3D, EKF464.3GRILL, EKF464ALP, EKF464ALUD, EKF464D, EKF464DALUD, EKF464DUD, EKF464P, EKF464UD, EKF523EUD, EKF523UD, EKF616EUD, EKF616UD, EKF664.3EUD, EKF664EUD...(Other models you can see in the webshop)		

doors			
			
1			
Part No.	699174	Ref. No.	21004930 21100350 S0902897
description	door glass L 720mm W 480mm H 70mm		
For models:	EKF411, EKF411.3D, EKF411.3GRILL, EKF411D, EKF411DUD, EKF411UD, EKF416DUD, EKF416UD, EKF464, EKF464.3D, EKF464.3GRILL, EKF464D, EKF464DUD, EKF464P, EKF464UD		

knobs

producer-specific knobs

TECNOEKA

			
1			
Part No.	111586	Ref. No.	00002780 09960028500
description	knob switch zero mark ø 43mm shaft ø 6x4.6mm shaft flat lower black		
For models:	440, 640 CI, 640 CI+GRILL, 640 CI+U, 648 CI, 900, 938.3, EKF1016UD, EKF1064UD, EKF1111UD, EKF523UD, EKF616UD, EKF664P, EKF664UD, EKF711UD, KF412, KF412U, KF630, KF723, KF723M, KF912, KF912IX, KF965, KF965AL-UD, KF965M, KF981, KF981-DOUBLE, KF981-DOUBLEEV-UD, KF981-DOUBLE-EV-UI, KF981-DOUBLE-UD, KF981-DOUBLE-VUD, KF981-DOUBLE-V-UI, KF981UD		

			
1			
Part No.	111587	Ref. No.	09960018500
description	knob switch zero mark ø 43mm shaft ø 6x4.6mm shaft flat right black		
For models:	440, 640 CI, 640 CI+GRILL, 640 CI+U, 648 CI, 930, KF412, KF412U, KF620, KF622, KF723, KF733, KF933, KF933AL, KF933AL-U, KF933U, KF937, KF981-DOUBLE-V, KF981-DOUBLE-V-UD, KF981-DOUBLE-V-UI, KF981V		

			
1			
Part No.	111585	Ref. No.	00000190 01960778504
description	knob switch zero mark ø 48mm shaft ø 6x4.6mm shaft flat upper blue/black		
For models:	CV5-90/X, KC96V, KF1001G, KF1001G-IX-AL, KF1001G-LPG, KF1001GLPG-IX-AL		

			
1			
Part No.	699164	Ref. No.	00006170
description	knob zero mark ø 40mm shaft ø 6x4.6mm shaft flat upper		
For models:	EKF1016EUD, EKF1064EUD, EKF1111EUD, EKF1111EVUD, EKF523EUD, EKF616EUD, EKF664.3EUD, EKF664EUD, EKF711.3EUD, EKF711EUD, EKF711EV		



1			
Part No.	699162	Ref. No.	00002770
description	knob zero mark ø 42.5mm shaft flat left black		
For models:	EKF311UD, EKF364UD, EKF411, EKF411.3GRILL, EKF411ALUD, EKF411UD, EKF412US, EKF416ALUD, EKF416UD, EKF423, EKF423AL, EKF423ALM, EKF423ALP, EKF423ALU, EKF423ALUD, EKF423ALUP, EKF423M, EKF423P, EKF423U, EKF423UD, EKF423UP, EKF464, EKF464.3GRILL, EKF464ALP, EKF464ALUD, EKF464P, EKF464UD, EKF620S, EKF620US		



1			
Part No.	111809	Ref. No.	00003030 09961258504
description	knob zero mark ø 48mm shaft ø 6x4.6mm silver/black		

handles and hand wheels

handle bars

producer-specific handle rails

TECNOEKA



1			
Part No.	694993	Ref. No.	00011680
description	door handle ø 18mm L 350mm stainless steel M5 black matt		
For models:	EKF311DUD, EKF311UD, EKF364DUD, EKF364UD, EKF411, EKF411.3D, EKF411.3GRILL, EKF411D, EKF423, EKF423AL, EKF423ALM, EKF423ALP, EKF423ALU, EKF423ALUD, EKF423ALUP, EKF423DALUD, EKF423DUD, EKF423M, EKF423P, EKF423U, EKF423UD, EKF423UP, EKF464, EKF464.3D, EKF464.3GRILL, EKF464ALP, EKF464D, EKF464P		

bracket handles



1			
Part No.	693229	Ref. No.	00002800 09960099002
description	pull handle L 296mm H 45mm mounting distance 280mm		
For models:	440, KF412, KF412U		



1			
Part No.	693225	Ref. No.	00002820 09960209002
description	pull handle L 515mm H 43mm mounting distance 497mm		
For models:	440, 640 CI, 640 CI+GRILL, 640 CI+U, 648 CI, 900, 900 G, 930, 938, 938.3, CV5-90/X, KC96V, KC96V, KC96V, KF630, KF723M, KF733, KF912, KF912IX, KF933, KF933U, KF937, KF965, KF965M, KL823, TCFG		

locks







handle latches

universal

inside fixing

locks



1			
Part No.	694054	Ref. No.	00006390 11961668500
description	door handle for headed units L 145mm W 40mm H 62mm spring length 33mm inner black		
For models:	EKF411ALUD, EKF411DALUD, EKF416ALUD, EKF416DALUD, EKF464ALUD, EKF464DALUD, EKF523EUD, EKF523UD, KF1001G-IX-AL, KF1001G-LPG-IX-AL, KF933AL, KF933AL-U, KF965AL-UD		
spare parts for	694054		
	Part No.	514390	Ref. No. —
	spring for door handle ø 6mm L 54mm W 27.5mm		
	Part No.	694675	Ref. No. —
	door catch L 88mm W 40mm H 37mm spring length 33mm mounting distance 60mm		
	Part No.	694734	Ref. No. —
	door handle L 165mm W 40mm H 25mm black		
	Part No.	694735	Ref. No. —
	cap ø 32mm black		
accessories for	694054		
	Part No.	691123	Ref. No. —
	duct for door opener		
	Part No.	694055	Ref. No. —
	door catch L 25mm W 14mm total length 54mm thread M8 thread L 29mm		
	Part No.	694066	Ref. No. —
	door catch with spigot 2-stage L 28mm W 14mm H 15mm H1 16mm total length 51mm thread M8 thread L 23mm stainless steel		
	Part No.	694067	Ref. No. —
	door catch with spigot 1-stage L 26mm total length 51mm thread M8		



 <p>1</p>			
Part No.	694234	Ref. No.	00006090 11960928500
description	door handle for headed units L 145mm W 40mm H 62mm spring length 40mm inner black		
For models:	EKF464TC, EKF511TC, EKF616EUD, EKF616UD, EKF664EUD, EKF664P, EKF664UD, EKF711EUD, EKF711EV, EKF711UD, KF981, KF981-DOUBLE, KF981-DOUBLE-EV, KF981-DOUBLE-EV-UD, KF981-DOUBLE-EV-UI, KF981-DOUBLE-UD, KF981-DOUBLE-V, KF981-DOUBLE-V-UD, KF981-DOUBLE-V-UI, KF981EV, KF981UD, KF981V		
spare parts for	694234		
	Part No.	Ref. No.	—
		514450	—
	spring for door handle ø 6mm L 61mm W 27.5mm		
	Part No.	Ref. No.	—
		694734	—
	door handle L 165mm W 40mm H 25mm black		
	Part No.	Ref. No.	—
		694735	—
	cap ø 32mm black		

 <p>1</p>			
Part No.	694882	Ref. No.	00005060 09988098500
description	door handle L 165mm W 40mm H 62mm inner black		
For models:	EKF1016EUD, EKF1016UD, EKF1064EUD, EKF1064TC, EKF1064UD, EKF1111EUD, EKF1111EVUD, EKF1111TC, EKF1111UD, EKF1664TC, EKF1111UD, EKF1664TC, EKF2011TC, EKF664.3EUD, EKF664TC, EKF711.3EUD, EKF711TC, KF1010GE-UD		
accessories for	694882		
	Part No.	Ref. No.	00005050 09988088500
		694881	—
	door catch total length 40mm M8 thread L 23mm W 26mm		

snap locks

universal

 <p>1</p>			
Part No.	700410	Ref. No.	00004310 09980358700
description	snap lock L 57mm W 12mm H 15mm mounting distance 47/12.5mm complete with door catch brass		
For models:	440, EKF412US, KF412, KF412U		

miscellaneous

 <p>1</p>			
Part No.	694883	Ref. No.	00010950
description	fixing plate L 100mm W 45mm H 2mm		
For models:	EKF1016EUD, EKF1016UD, EKF1064EUD, EKF1064TC, EKF1064UD, EKF1111EUD, EKF1111EVUD, EKF1111TC, EKF1111UD, EKF1664TC, EKF2011TC, EKF464TC, EKF511TC, EKF616EUD, EKF616UD, EKF664.3EUD, EKF664EUD, EKF664P, EKF664TC, EKF664UD, EKF711.3EUD, EKF711EUD, EKF711EV, EKF711TC, EKF711UD		

 <p>1</p>			
Part No.	694884	Ref. No.	00011060
description	fixing plate L 100mm W 45mm H 5mm		
For models:	EKF1016EUD, EKF1016UD, EKF1064EUD, EKF1064TC, EKF1064UD, EKF1111EUD, EKF1111EVUD, EKF1111TC, EKF1111UD, EKF1664TC, EKF2011TC, EKF464TC, EKF511TC, EKF616EUD, EKF616UD, EKF664.3EUD, EKF664EUD, EKF664TC, EKF664UD, EKF711.3EUD, EKF711EUD, EKF711EV, EKF711TC, EKF711UD		



 <p>1</p>			
Part No.	694885	Ref. No.	01502400
description	threaded bush L 17mm W 11mm M8		

hinges

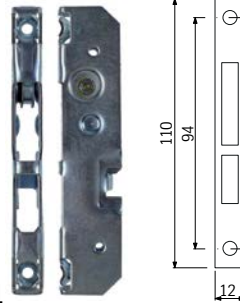
oven hinges

 <p>1</p>			
Part No.	700003	Ref. No.	00000310 01980059512
description	opposite support L 110mm W 12mm mounting distance 94mm		



			
Part No.	701631	Ref. No.	00014600 SP007950923
description	opposite support mounting distance 119mm L 135mm W 12mm		
accessories for	701631		
			
Part No.	701573	Ref. No.	00014610 SP007950922
description	oven hinge mounting distance 142mm mounting distance 2mm lug mountingmm lever lengthmm groove distance 12mm spring thickness 3.3mm mounting ear position spring length 116mm L 170mm mounting pos. left/right W 22mm		

			
Part No.	700841	Ref. No.	00003170 09964139512
description	opposite support mounting distance 85mm L 107mm W 12.5mm for hinge		
For models:	EKF311DUD, EKF311UD, EKF364DUD, EKF364UD, EKF411, EKF411.3GRILL, EKF411DUD, EKF411UD, EKF416DUD, EKF416UD, EKF423, EKF423DUD, EKF423M, EKF423P, EKF423U, EKF423UD, EKF423UP, EKF443DUD, EKF464, EKF464.3GRILL, EKF464DUD, EKF464P, EKF464UD, KF630		

			
Part No.	700707	Ref. No.	01981589512 30304870
description	opposite support mounting distance 94mm L 140mm mounting pos. left W 13mm with welded metal sheet H 110mm for hinge		
For models:	KCP97-VG-A, KCV96, KCV96P		
accessories for	700707		
			
Part No.	693045	Ref. No.	—
description	opposite support L 110mm W 12mm mounting distance 94mm		

			
Part No.	700434	Ref. No.	01980869512
description	opposite support oven hinge		
For models:	440, 640 CI, 640 CI+GRILL, 640 CI+U, 648 CI, 900, 900 G, 930, 938, 938.3, CV5-90/X, KC96V, KF723, TCFG		

			
Part No.	701511	Ref. No.	30304880 + 30304900
description	opposite support set mounting distance 94mm L 140mm mounting pos. left/right H 110mm W 13mm for oven width 60cm for hinge		
accessories for	701511		
			
Part No.	693045	Ref. No.	—
description	opposite support L 110mm W 12mm mounting distance 94mm		

			
Part No.	701512	Ref. No.	30304870 + 30304880
description	opposite support set mounting distance 94mm L 140mm mounting pos. left/right H 110mm W 13mm for oven width 90cm for hinge		





1

Part No.	690700	Ref. No.	00004360 09980699512
description	oven hinge mounting distance 118mm lug mounting 13mm lever length 119mm groove distance 12mm spring thickness 4mm mounting ear position left/right spring length 60mm L 155mm W 20mm FEP040		
accessories for	690700		
	Part No.	700003	Ref. No. 00000310 01980059512
opposite support L 110mm W 12mm mounting distance 94mm			



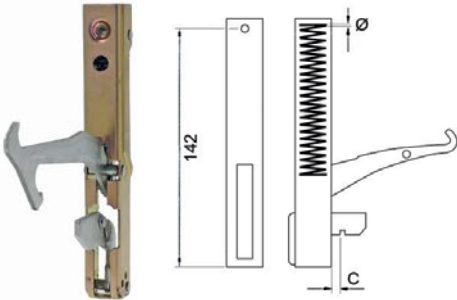

1

Part No.	700000	Ref. No.	00000350 01980859512
description	oven hinge mounting distance 142mm mounting distance 2mm lug mountingmm lever length 127mm groove distance 10mm spring thickness 3.7mm mounting ear position L 155mm mounting pos. left/right		
For models:	EKF620S, EKF620US, KF723, KF723M, KF733, KF937, TCFG		
accessories for	700000		
	Part No.	693045	Ref. No. —
opposite support L 110mm W 12mm mounting distance 94mm			
	Part No.	700707	Ref. No. 01981589512 30304870
opposite support mounting distance 94mm L 140mm mounting pos. left W 13mm with welded metal sheet H 110mm for hinge			



1

Part No.	700433	Ref. No.	00004440 09981619512
description	oven hinge mounting distance 142mm mounting distance 2mm lug mountingmm lever length 100mm groove distance 14mm spring thickness 4mm mounting ear position spring length 55mm L 155mm mounting pos. left/right		
For models:	900, 900 G, 930, 938, 938.3, CV5-90/X, KC96V, KCP97-VG-A, KCV96, KCV96P, KF1001G, KF1001G-LPG, KF912, KF912IX, KF965, KF965M		
accessories for	700433		
	Part No.	700434	Ref. No. 01980869512
opposite support oven hinge			



1

Part No.	701573	Ref. No.	00014610 SP007950922
description	oven hinge mounting distance 142mm mounting distance 2mm lug mountingmm lever lengthmm groove distance 12mm spring thickness 3.3mm mounting ear position spring length 116mm L 170mm mounting pos. left/right W 22mm		
accessories for	701573		
	Part No.	701631	Ref. No. 00014600 SP007950923
opposite support mounting distance 119mm L 135mm W 12mm			



			
1			
Part No.	701538	Ref. No.	00003180 09964199512
description	oven hinge set mounting distance 155mm mounting distance 2mm lug mountingmm lever length 77mm groove distance 14mm spring thickness 3.5mm mounting ear position spring length 53mm L 165mm mounting pos. left/right W 22mm pair		
For models:	EKF423, EKF423DUD, EKF423M, EKF423P, EKF423U, EKF423UD, EKF423UP, EKF443DUD, KF630		

door bearing

			
1			
Part No.	700412	Ref. No.	09980309202 30203740
description	hinge bottom left		
For models:	440, KF412, KF412U		

			
1			
Part No.	700411	Ref. No.	09980299202 30203730
description	hinge upper left		
For models:	440, KF412, KF412U		

accessories

bushes

			
1			
Part No.	694886	Ref. No.	00006080 11960918700
description	bush ID ø 7mm ED ø 12mm L 10mm		
For models:	EKF411ALUD, EKF411DALUD, EKF416ALUD, EKF416DALUD, EKF423AL, EKF423ALM, EKF423ALP, EKF423ALU, EKF423ALUD, EKF423ALUP, EKF423DALUD, EKF464ALP, EKF464ALUD, EKF464DALUD, EKF523EUD, EKF523UD, KF1001G-IX-AL, KF1001G-LPG-IX-AL, KF933AL, KF933AL-U, KF965AL-UD, KF981, KF981-DOUBLE, KF981-DOUBLE-EV, KF981-DOUBLE-EV-UD, KF981-DOUBLE-EV-UI, KF981-DOUBLE-UD, KF981-DOUBLE-V, KF981-DOUBLE-V-UD, KF981-DOUBLE-V-UI, KF981EV, KF981UD, KF981V		

			
2			
Part No.	701539	Ref. No.	00012580 00013340
description	oven hinge set mounting distance 155mm mounting distance 2mm lug mountingmm lever length 78mm groove distance 12mm spring thickness 3.2mm mounting ear position spring length 53mm L 165mm mounting pos. left/right W 22mm pair		
For models:	EKF311DUD, EKF311UD, EKF364DUD, EKF364UD		

			
1			
Part No.	701537	Ref. No.	00007150 00007510 11982239512
description	oven hinge set pair mounting distance 155mm mounting distance 2mm lug mountingmm lever length 77mm groove distance 14mm spring thickness 4mm mounting ear position spring length 53mm L 165mm mounting pos. left/right W 22mm		
For models:	EKF411, EKF411.3D, EKF411.3GRILL, EKF411D, EKF411DUD, EKF411UD, EKF416DUD, EKF416UD, EKF464, EKF464.3D, EKF464.3GRILL, EKF464D, EKF464DUD, EKF464UD		



equipment feet and end caps

screw-in feet

			
1			
Part No.	802156	Ref. No.	00002790 09960058500
description	equipment foot thread M10 thread L 20mm ø 60mm H 50mm Qty 1 pcs		
For models:	EKF1016EUD, EKF1016UD, EKF1064EUD, EKF1064TC, EKF1064UD, EKF1111EUD, EKF1111EVUD, EKF1111TC, EKF1111UD, EKF311DUD, EKF311UD, EKF364DUD, EKF364UD, EKF411, EKF411.3D, EKF411.3GRILL, EKF411ALUD, EKF411D, EKF411DALUD, EKF411DUD, EKF411UD, EKF412US, EKF416ALUD, EKF416DALUD, EKF416DUD, EKF416UD, EKF423, EKF423AL, EKF423ALM, EKF423ALP, EKF423ALU, EKF423ALUD, EKF423ALUP, EKF423DALUD, EKF423DUD, EKF423M, EKF423P, EKF423U, EKF423UD, EKF423UP, EKF443DUD, EKF464, EKF464.3D, EKF464.3GRILL, EKF464ALP, EKF464ALUD, EKF464D, EKF464DALUD, EKF464DUD, EKF464P...(Other models you can see in the webshop)		

shelves and shelf rails

grates

producer-specific

			
1			
Part No.	693930	Ref. No.	01960597915 KG7
description	grate W 435mm D 340mm chrome-plated steel suitable for refrigerator TECNOEKA		
For models:	KF620, KF622, KF723, KF723M, TCFG		

gaskets

gaskets for heated units

window seals

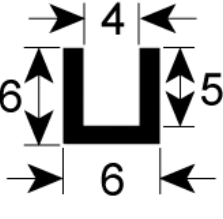
			
1			
Part No.	902418	Ref. No.	01000270 09963468000
description	window gasket profile 1595 suitable for TECNOEKA Qty supplied by meter		
For models:	KF1001G, KF1001G-LPG, KF630, KF733, KF912, KF912IX, KF933, KF933U, KF937, KF965, KF965M		

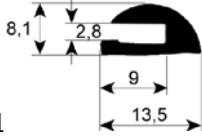
			
1			
Part No.	901272	Ref. No.	01000060
description	window gasket profile 1882 L 1000mm suitable for TECNOEKA Qty 2		

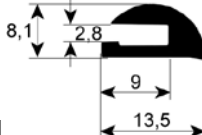
			
1			
Part No.	693228	Ref. No.	09980458000
description	window gasket profile 1882 L 2200mm Qty 1		
For models:	440, KF412, KF412U		

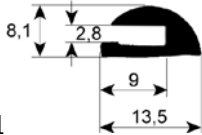
			
1			
Part No.	691202	Ref. No.	09980458000 09989738000
description	window gasket profile 1882 Qty supplied by meter		

door seals

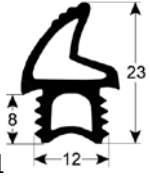
			
1			
Part No.	902497	Ref. No.	01000770 SP007260456
description	door seal profile 2764 L 1020mm suitable for TECNOEKA		

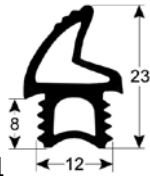
			
1			
Part No.	902496	Ref. No.	01000030 09989708000
description	door seal profile 2764 L 2105mm suitable for TECNOEKA		
For models:	EKF411, EKF411.3D, EKF411.3GRILL, EKF411D, EKF464, EKF464.3D, EKF464.3GRILL, EKF464D		

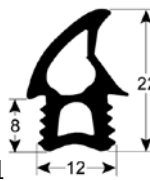
			
1			
Part No.	902495	Ref. No.	01000050 09989728000
description	door seal profile 2765 L 2510mm suitable for TECNOEKA		



Part No.	902419	Ref. No.	01000810 09981998000
description	door seal profile 2767 L 1780mm suitable for TECNOEKA		
For models:	EKF423AL, EKF423ALP, EKF423ALUP, EKF423P, EKF423UP		

Part No.	902420	Ref. No.	01000320 09982008000 09985548000
description	door seal profile 2767 L 2100mm suitable for TECNOEKA		
For models:	KF1010GE-UD, KF630, KF965AL-UD, KF981, KF981-DOUBLE, KF981-DOUBLE-EV, KF981-DOUBLE-EV-UD, KF981-DOUBLE-EV-UI, KF981-DOUBLE-UD, KF981-DOUBLE-V, KF981-DOUBLE-V-UD, KF981-DOUBLE-V-UI, KF981EV, KF981UD, KF981V		

Part No.	902196	Ref. No.	01000310
description	door seal profile 2769 L 1850mm		
For models:	EKF423, EKF423DUD, EKF423M, EKF423U, EKF423UD, EKF443DUD		

Part No.	902195	Ref. No.	01000710 01000780
description	door seal profile 2769 L 2140mm		
For models:	EKF411DUD, EKF411UD, EKF416DUD, EKF416UD, EKF464DUD, EKF464UD		

door seals with fixing hook

Part No.	900394	Ref. No.	01000370 01000371 09981148000 09988078000
description	oven gasket L 370mm W 640mm 6 hooks external size		
For models:	900, 900 G, 930, 938.3, CV5-90/X, KC96V, KCP97-VG-A, KCV96, KCV96P, KF1001G, KF1001G-IX-AL, KF1001G-LPG, KF1001G-LPG-IX-AL, KF912, KF912IX, KF933, KF933AL, KF933AL-U, KF933U, KF965, KF965M		

Part No.	900396	Ref. No.	01000390 09980748000 09988928000
description	oven gasket L 440mm W 370mm external size		
For models:	640 CI, 640 CI+GRILL, 640 CI+U, 648 CI, EKF620S, EKF620US, KF620, KF622, KF723, KF723M, TCFG		

Part No.	900395	Ref. No.	01000290 01000380 09980288000 09988848000
description	oven gasket W 320mm with 4 mounting clips H 260mm		
For models:	440, EKF412US, KF412, KF412U		

door gaskets (wire reinforced)

Part No.	693232	Ref. No.	01000300 09980928000
description	oven gasket wire reinforced L 425mm W 350mm		
For models:	440, 640 CI, 640 CI+GRILL, 640 CI+U, 648 CI, EKF620S, EKF620US, KF723, KF723M, TCFG		



O-rings

EPDM

1

Part No.	510955	Ref. No.	00002001
description	O-ring EPDM thickness 3mm ID \varnothing 6mm Qty 1 pcs		
For models:	EKF1016EUD, EKF1016UD, EKF1064EUD, EKF1064UD, EKF1111EUD, EKF1111EVUD, EKF1111UD, EKF311UD, EKF364UD, EKF411, EKF411.3GRILL, EKF411ALUD, EKF411UD, EKF412US, EKF416ALUD, EKF416UD, EKF423, EKF423AL, EKF423ALM, EKF423ALU, EKF423ALUD, EKF423M, EKF423U, EKF423UD, EKF464, EKF464.3GRILL, EKF464ALP, EKF464ALUD, EKF464P, EKF464UD, EKF523EUD, EKF523UD, EKF616EUD, EKF616UD, EKF664.3EUD, EKF664EUD, EKF664P, EKF664UD, EKF711.3EUD, EKF711EUD, EKF711EV, EKF711UD		

silicone

1

Part No.	532454	Ref. No.	01991948000
description	O-ring silicone thickness 3.53mm ID \varnothing 101.2mm Qty 1 pcs		
For models:	CV5-90/X, KC96V		

1

Part No.	532455	Ref. No.	01991988000
description	O-ring silicone thickness 3.53mm ID \varnothing 78.97mm Qty 1 pcs		
For models:	CV5-90/X, KC96V		

Viton

1

Part No.	532456	Ref. No.	01991898000
description	O-ring Viton thickness 2mm ID \varnothing 16mm Qty 1 pcs		
For models:	CV5-90/X, KC96V		

springs

compression springs

1

Part No.	105704	Ref. No.	01951057720
description	compression spring L 14.5mm \varnothing 9mm wire gauge \varnothing 0.9mm		
For models:	CV5-90/X, KC96V		

kitchen accessories

baking sheets

1

Part No.	694531	Ref. No.	09960148801 KV4
description	baking sheet W 258mm L 324mm H 10mm aluminium		
For models:	EKF412US, KF412, KF412U		

fittings, hose and pipe connectors

push-in fittings

JOHN GUEST

1

Part No.	440671	Ref. No.	00011090	
description	push-in fitting John Guest angled pipe connection \varnothing 8mm grommet \varnothing 8mm			
For models:	EKF1016EUD, EKF1064EUD, EKF1064TC, EKF1111EUD, EKF1111EVUD, EKF1111TC, EKF1664TC, EKF2011TC, EKF311DUD, EKF311UD, EKF364DUD, EKF364UD, EKF411UD, EKF416UD, EKF423ALUD, EKF-423DALUD, EKF423DUD, EKF423UD, EKF464TC, EKF464UD, EKF511TC, EKF523EUD, EKF523UD, EKF616EUD, EKF664.3EUD, EKF664EUD, EKF664TC, EKF711.3EUD, EKF711EUD, EKF711EV, EKF711TC			
accessories for	440671			
	Part No.	520972	Ref. No.	—
	hose John Guest thickness 1mm LLDPE blue ID \varnothing 6mm ED \varnothing 8mm			

mechanical components,
equipment accessories
1

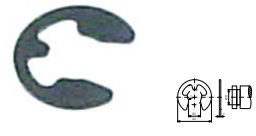

			
1			
Part No.	520493	Ref. No.	00006430
description	hose connector John Guest straight pipe connection ø8mm - ø10mm L 41mm PM201008E NSF, SK		
For models:	EKF1016EUD, EKF1016UD, EKF1064EUD, EKF1064TC, EKF1064UD, EKF1111EUD, EKF1111EVUD, EKF1111TC, EKF1111UD, EKF1664TC, EKF2011TC, EKF311DUD, EKF311UD, EKF364DUD, EKF364UD, EKF411ALUD, EKF411DALUD, EKF411DUD, EKF411UD, EKF416ALUD, EKF416DALUD, EKF416DUD, EKF416UD, EKF423ALUD, EKF423DALUD, EKF423DUD, EKF423UD, EKF443DUD, EKF464ALUD, EKF464DALUD, EKF464DUD, EKF464TC, EKF464UD, EKF511TC, EKF523EUD, EKF523UD, EKF616EUD, EKF616UD, EKF664.3EUD, EKF664EUD, EKF664TC, EKF664UD, EKF711.3EUD, EKF711EUD, EKF711TC, EKF711UD		

retaining rings			
DIN 6799			
			
1			
Part No.	550542	Ref. No.	01951067720
description	retaining ring E D1 ø 5mm D2 ø 11mm DIN 6799 thickness 0.7mm		
For models:	CV5-90/X, KC96V		

type C			
			
1			
Part No.	550544	Ref. No.	01992007700
description	retaining ring igniter		
For models:	CV5-90/X, KC96V		

consumables			
fuses			
fine fuses			
			
1			
Part No.	358675	Ref. No.	11950227000
description	fine fuse size ø5x20mm 2.5A fast-acting rated 250V Qty 10 pcs		

fastening material

nuts			
hexagonal nuts			
hexagonal nuts metric (without norm)			
			
1			
Part No.	102497	Ref. No.	01500810 07991978700
description	nut thread M6x0.75 H 3mm WS 8 steel Qty 1 pcs		
For models:	KCP97-VG-A, KCV96, KCV96P, KPP96, KPPP96, TCFG		

fasteners			
mounting clips			
			
1			
Part No.	692865	Ref. No.	00007750 15980609202
description	mounting clip for bulb socket L 16mm H 19mm		
For models:	EKF423AL, EKF423ALP, EKF423ALUP		

GASTROPARTS.COM

